

MultiTrak Recording Studio MRS-802

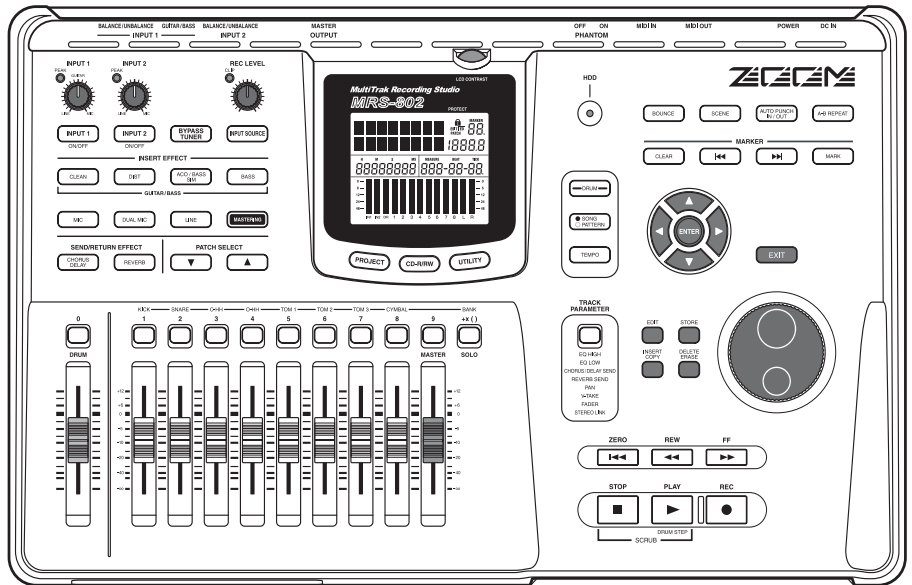

Operation Manual



© ZOOM Corporation

Reproduction of this manual, in whole or in part, by any means, is prohibited.

USAGE AND SAFETY PRECAUTIONS

SAFETY PRECAUTIONS

In this manual, symbols are used to highlight warnings and cautions for you to read so that accidents can be prevented. The meanings of these symbols are as follows:



This symbol indicates explanations about extremely dangerous matters. If users ignore this symbol and handle the device the wrong way, serious injury or death could result.



This symbol indicates explanations about dangerous matters. If users ignore this symbol and handle the device the wrong way, bodily injury and damage to the equipment could result.

Please observe the following safety tips and precautions to ensure hazard-free use of the MRS-802.

• Power requirements



The MRS-802 is powered by the supplied AC adapter. To prevent malfunction and safety hazards, do not use any other kind of AC adapter.

When using the MRS-802 in an area with a different line voltage, please consult your local ZOOM distributor about acquiring a proper AC adapter.

• About grounding



Depending on installation conditions, a slight electrical charge may be felt when touching a metal part of the MRS-802. If you wish to avoid this, ground the unit by connecting the ground screw on the bottom to a good external ground.

To prevent the risk of accidents, never use one of the following for grounding:

- Water pipe (risk of electric shock)
- Gas pipe (risk of explosion)
- Telephone wiring ground or lightning arrester (risk of lightning stroke)

• Environment



Avoid using your MRS-802 in environments where it will be exposed to:

- Extreme temperature
- High humidity or moisture
- Excessive dust or sand
- Excessive vibration or shock

• Handling



The MRS-802 is a precision instrument. Do not exert undue pressure on the keys and other controls. Also take care not to drop the unit, and do not subject it to shock or excessive pressure.

• Alterations



Never open the case of the MRS-802 or attempt to modify the product in any way since this can result in damage to the unit.

• Connecting cables and input and output jacks



You should always turn off the power to the MRS-802 and all other equipment before connecting or disconnecting any cables. Also make sure to disconnect all cables and the AC adapter before moving the MRS-802.

• Volume



Do not use the MRS-802 at a loud volume for a long time since this can cause hearing impairment.

• CD-R/RW Drive



Never look directly in the laser beam projected from the optical pickup of the CD-R/RW drive since your sight can be damaged.

Usage Precautions

• Electrical interference

For safety considerations, the MRS-802 has been designed to provide maximum protection against the emission of electromagnetic radiation from inside the device, and protection from external interference. However, equipment that is very susceptible to interference or that emits powerful electromagnetic waves should not be placed near the MRS-802, as the possibility of interference cannot be ruled out entirely.

With any type of digital control device, the MRS-802 included, electromagnetic interference can cause malfunctioning and can corrupt or destroy data. Care should be taken to minimize the risk of damage.

• Cleaning

Use a soft, dry cloth to clean the MRS-802. If necessary, slightly moisten the cloth. Do not use abrasive cleanser, wax, or solvents (such as paint thinner or cleaning alcohol), since these may dull the finish or damage the surface.

• Backup

The data of MRS-802 can be lost because of malfunction or incorrect operation. Backup your data.

• Copyrights

Except for personal use, unauthorized recording from copyrighted sources (CDs, records, tapes, video clips, broadcast material and so on) is prohibited.

ZOOM Corporation does not bear any liability for injunctions regarding the copyright law infringement.

Please keep this manual in a convenient place for future reference.

MIDI is a registered trademark of Association of Musical Electronics Industry (AMEI).

Contents

USAGE AND SAFETY PRECAUTIONS . . .	2
SAFETY PRECAUTIONS	2
Usage Precautions	3
Introduction	7
Overview	7
Introducing the MRS-802	9
Recorder section	9
Rhythm section	10
Mixer section	10
Effect section	10
Parts of the MRS-802	12
Top panel	12
Rear panel	14
Front panel	14
Connections	15
Installing the CD-R/RW Drive	17
Listening to the Demo Songs	19
Demo song protect status	19
Turning on the power	19
Selecting the demo song	19
Playing the demo song	20
Turning power off (shutdown)	20
Quick Tour	21
Step 1: Preparations	21
1.1 Creating a new project	21
1.2 Selecting a rhythm pattern	22
Step 2: Recording the first track	24
2.1 Adjusting input sensitivity	24
2.2 Applying the insert effect	24
2.3 Selecting a track and recording	25
Step 3: Overdubbing	27
3.1 Making settings for input sensitivity and insert effect	27
3.2 Selecting a track and recording	27
Step 4: Mixdown	28
4.1 Preparations for mixdown	28
4.2 Adjusting volume, panning, and EQ	28
4.3 Applying the send/return effect	29
4.4 Using the mastering insert effect	31
4.5 Mixdown on the master track	31
Reference [Recorder]	33
Using V-takes	33
Switching V-takes	33
Editing V-take names	33
Moving to a desired point in the song (Locate function)	35
Re-recording only a specified region (Punch-in/out function)	35
Using manual punch-in/out	35
Using auto punch-in/out	36
Recording several tracks on a master track (Mixdown function)	37
About the master track	37
Mixdown steps	37
Playing the master track	38
Combining multiple tracks on another track (Bounce function)	39
How bounce works	39
Making bounce settings	39
Executing bounce recording	40
Recording the drum sound (Rhythm recording)	41
Assigning marks within a song (Marker function)	42
Setting a mark	42
Locating a mark	43
Deleting a mark	43
Playing back the same passage repeatedly (A-B Repeat function)	44
Finding a desired location (Scrub/Preview function)	44
Using the scrub/preview functions	44
Changing the settings of the scrub function	45
Reference [Track Editing]	46
Editing a range of data	46
Basic editing steps for range editing	46
Copying a specified range of data	47
Moving a specified range of data	48
Erasing a specified range of data	49
Trimming a specified range of data	49
Fade-in/fade-out of specified data range	50
Reversing a specified range of audio data	51
Changing the duration of a specified data range	51
Editing using V-takes	53
Basic V-take editing steps	53
Erasing a V-take	54
Copying a V-take	54
Moving a V-take	54
Exchanging V-takes	55
Track capture and swap	55
Capturing a track	55
Swapping track data and captured data	56

Reference [Phrase Looping] 57

- Which kind of phrases can be used? 57
- Loading a phrase 58**
 - Basic phrase loading steps 58
 - Importing a V-take from the current project 58
 - Importing a WAV/AIFF file 59
 - Importing a phrase from a different project 60
- Adjusting phrase parameters 61**
 - Copying a phrase 62
- Creating a phrase loop 63**
 - About phrase loop FAST input 63
 - Writing a phrase loop to a track 65

Reference [Mixer] 67

- About the mixer 67
- Basic operation of the input mixer 68**
 - Assigning input signals to tracks 68
 - Adjusting the depth of the send/return effects 69
 - Adjusting the pan/balance 70
- Basic operation of the track mixer 71**
 - Adjusting the volume/pan/EQ 71
 - Adjusting depth of send/return effect 72
 - Linking odd-numbered/even-numbered channels (stereo link) 73
- Using the solo function 74**
- Saving/recalling mixer settings (Scene function) 74**
 - Saving a scene 74
 - Recalling a saved scene 75
 - Switching scenes automatically 75
 - Deleting certain parameters from a scene 76

Reference [Rhythm] 77

- About the rhythm section 77**
 - Drum kits 77
 - Rhythm patterns 77
 - Rhythm songs 77
 - Rhythm pattern mode and rhythm song mode 78
 - Synchronizing the recorder section and rhythm section 78
- Playing rhythm patterns 78**
 - Selecting and playing a rhythm pattern 78
 - Changing the tempo of the rhythm pattern 79
 - Changing the drum kit 79
- Creating a rhythm song 80**
 - Selecting a rhythm song 80
 - Inputting rhythm pattern data 81
 - Step input 81
 - FAST input 83
 - Inputting other event data 86
 - Playing a rhythm song 87
- Editing a rhythm song 88**
 - Copying a specific region of measures 88
 - Copying a rhythm song 88
 - Erasing a rhythm song 89

- Assigning a name to a rhythm song 89
- Creating an original rhythm pattern 90**
 - Preparations 90
 - Step input 91
 - Real-time input 93
- Editing a rhythm pattern 94**
 - Adjusting the drum volume balance 94
 - Copying a rhythm pattern 95
 - Editing the name of a rhythm pattern 95
 - Erasing a rhythm pattern 96
- Importing rhythm patterns and rhythm songs from another project 96**
- Editing various settings of the rhythm section 97**
 - Basic procedure 97
 - Changing the length of the pre-count 97
 - Changing the metronome volume 98
 - Specifying the sound dynamics 98
 - Checking the remaining amount of memory 98

Reference [Effects] 99

- About the effects 99**
 - Insert effect 99
 - Send/return effects 99
- Using the insert effect 100**
 - About insert effect patches 100
 - Changing the insert location of the insert effect . . . 101
 - Selecting the patch for the insert effect 101
 - Editing the insert effect patch 103
 - Storing an insert effect patch 105
 - Editing the name of an insert effect patch 105
- Applying the insert effect only to the monitor signal 106**
- Using the send/return effects 107**
 - About the send/return effect patches 107
 - Selecting a send/return effect patch 107
 - Editing a send/return effect patch 108
 - Storing a send/return effect patch 109
 - Editing the name of a send/return effect patch 109
- Importing patches from another project 110**

Reference [Creating a CD] 111

- Writing audio data 111**
- About CD-R/RW discs 111**
- Recording audio data by project 112**
- Recording audio data by album 113**
- Playing an audio CD 115**
- Erasing a CD-RW Disc 117**
- Finalizing a CD-R/RW Disc 118**
- Loading data from an audio CD 119**
- Backup and restore 119**
 - Saving a single project to CD-R/RW disc 119
 - Saving all projects to CD-R/RW disc 121
 - Loading a project from CD-R/RW disc 122

Reference [Projects] 124

- About projects 124
- Project operations 124
 - Basic procedure 124
 - Loading a project 125
 - Creating a new project 125
 - Checking the project size/available hard disk capacity 125
 - Duplicating a project 126
 - Erasing a project 126
 - Editing the project name 127
 - Protecting/unprotecting a project 127

Reference [MIDI] 128

- About MIDI 128
 - What you can do using MIDI 128
- Making MIDI-related settings 129
 - Basic procedure 129
- Setting the drum kit MIDI channel 130
- Specifying transmission of Timing Clock messages 130
- Specifying transmission of Song Position Pointer messages 131
- Specifying transmission of Start/Stop/Continue messages 131
- Using the SMF player 131
 - Reading an SMF into a project 131
 - Selecting the SMF output destination 132
 - SMF playback 134

Reference [Other Functions] 135

- Changing the function of the foot switch 135
- Using the tuner function 136
- Switching the level meter display type 137
- Hard disk maintenance 137
 - Basic maintenance procedure 137
 - Test/restore integrity of data on internal hard disk (ScanDisk) 138
 - Rewriting system file data (Factory Initialize) 138
 - Formatting the hard disk (All Initialize) 138
 - Hard disk maintenance using supplied CD-ROM 139
 - Connecting to a computer with an option card 139

Appendix 141

- MRS-802 Specifications 141
- Troubleshooting 142
 - Problems during playback 142
 - Problems during recording 142
 - Problems with effects 142
 - Problems with the rhythm section 143
 - Problems with MIDI 143
 - Problems with CD-R/RW drive 144
 - Other problems 144

- Effect Type/Parameter List 145
 - Insert effect 145
 - Send/return effect 153
- Effect Patch List 154
 - Insert effect 154
 - Send/return effect 158
- Rhythm Pattern List 159
- Drum Kit List 161
- Instrument/MIDI Note Number Table 161
- Phrase List 163
- MRS-802 hard disk contents 164
 - Compatibility With MRS-1044/MRS-1266 Series .. 164
- MIDI implementation 166
- MIDI implementation chart 167

INDEX 168

Introduction

Overview

Thank you for purchasing the **ZOOM MRS-802 multitrack recording studio** (subsequently referred to as "**the MRS-802**"). The MRS-802 is a digital audio workstation with the following features:

■ Brings together all the functionality you need for complete music production

The MRS-802 provides all the functionality you need for professional music production: hard disk recorder, drum machine, digital mixer, effects, CD-R/RW drive and more. From creating the rhythm tracks to multitrack recording, mixdown, and burning an audio CD, the MRS-802 lets you do it all.

■ 8-track x 10-take recorder

The recorder section provides eight mono tracks and a stereo master track for mixdown. Because each track has ten virtual tracks (V-takes), you can record multiple takes for important parts such as vocals or guitar solos and select the best take later.

A full range of editing functions is also provided, allowing you to copy or move audio data. Special functions include reversing of data and time stretch/compression. Data exchange and copy between regular tracks and the master track is also possible.

■ Bounce function allows ping-pong recording of eight tracks simultaneously

The bounce function makes it easy to consolidate multiple tracks into one or two tracks with just a few keystrokes. Even when there are no vacant tracks available, you can add the rhythm section parts and bounce the result onto two V-takes. If you select the master track as bounce target, internal mixdown is possible without using up any of the regular tracks or V-takes.

■ Phrase loop function for pasting audio material

Using recorded audio data or audio files picked up from a CD-ROM disc, you can create "phrase loops" for example drum licks and guitar riffs. The playback sequence and repetition count of phrases can be programmed easily and written to any track or V-take as audio data.

■ Rhythm section can be used to provide guide rhythm or accompaniment

The rhythm section provides more than 400 types of accompaniment patterns using the internal drum sound generator. This can be used as independent guide rhythm or in synchronization with the recorder. You can also program a pattern playback sequence to create the rhythm accompaniment for an entire song. In addition to conventional step input, the MRS-802 features an innovative concept called FAST input developed by ZOOM which lets you quickly build songs with simple steps.

■ Mixer section supporting automated operation

The internal digital mixer can handle 8 tracks plus the drum channel. The level, panning, and EQ settings of each channel can be saved as separate "scenes". A saved scene can be recalled manually at any time, or can be switched automatically at a desired point in a song.

■ Versatile effects

The MRS-802 provides "insert effects" that can be inserted into a specified signal path, and "send/return effects" that are used via the mixer send/return loop. The effects can be used in a variety of ways, from modifying the tone while recording a track, to spatial processing or mastering during mixdown.

■ CD-R/RW drive

When you have created a mixdown on the master track, you can easily burn it onto a CD-R or CD-RW disc using the built-in drive. This is convenient for creating audio CDs and to back up data that you have recorded.

The version of the MRS-802 without internal CD-R/RW drive lets you install the optional drive CD-01 later, giving you the same functionality as the integrated model.

In order to take full advantage of the MRS-802's versatile functions and to ensure trouble-free enjoyment, please read this manual carefully. Keep this manual in a safe place together with the warranty card.

Introducing the MRS-802

The MRS-802 is internally divided into the following five sections.

- **Recorder section**

Records and plays back audio.

- **Rhythm section**

Uses internal drum machine to play rhythms.

- **Mixer section**

Mixes the signals from the recorder section and rhythm section, for output via the stereo output jacks and for mixdown on dedicated master tracks.

- **Effect section**

Processes input signals or signals of the mixer section. The MRS-802 has two types of effects: an insert effect that is inserted in a specific signal path, and a send/return effect that uses the send/return loop of the mixer section.

- **CD-R/RW drive section**

Lets you burn an audio CD using the contents of the master tracks, or read audio material from CDs and CD-ROMs.

The diagram below shows the relationship and signal flow between each section.

Now let's take a closer look at each section.

Recorder section

The recorder section of the MRS-802 has eight mono tracks (tracks 1 - 8). (A "track" is a separate section for recording audio data.) Up to two tracks can be recorded simultaneously and up to eight tracks can be played back simultaneously.

Each of the tracks has ten switchable virtual tracks (called "V-takes"). In each track, one V-take can be selected for recording/playback. For example, you can record guitar solos onto multiple V-takes, and then compare them later to select the best take.

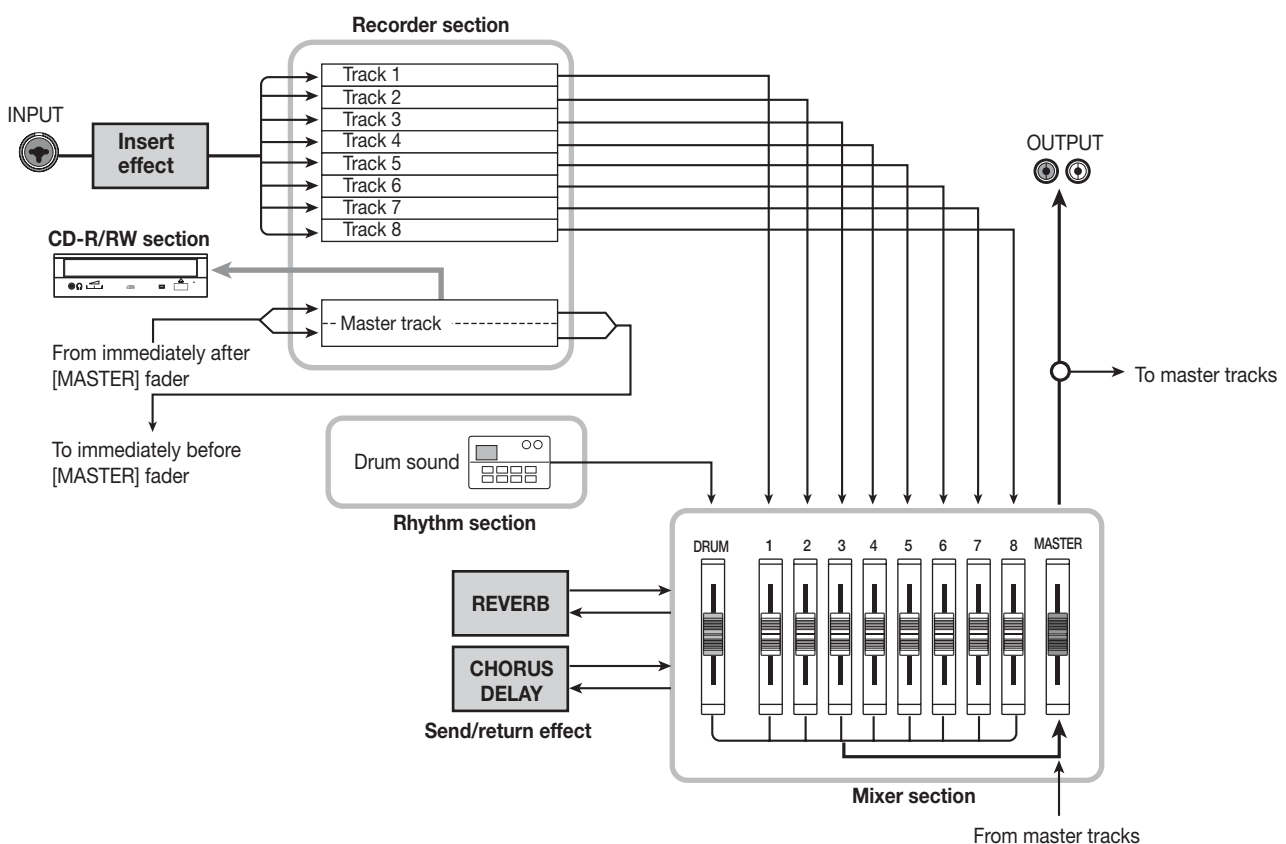

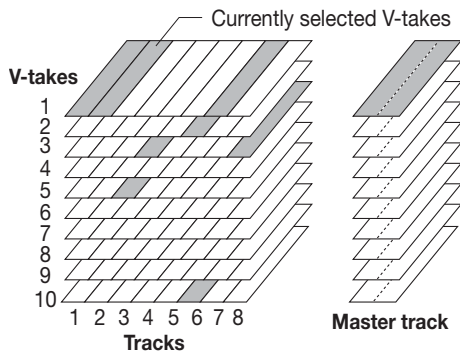

The recorder section also provides a set of stereo tracks which are separate from the normal record/play tracks 1 - 8. These are called the master track. The master track is dedicated to mixdown and also serves for holding the material used to create an audio CD.

Rhythm section

The rhythm section of the MRS-802 offers 511 accompaniment patterns (called "rhythm patterns") that use the internal drum sound generator. Over 400 patterns are preprogrammed at the factory. Rhythm patterns can be played independently or in synchronization with the recorder.

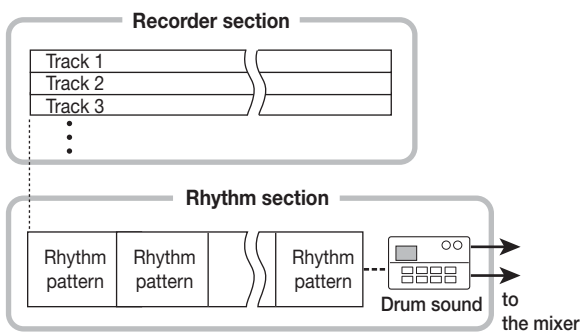

You can arrange rhythm patterns in the desired order of playback, and set the tempo to create the rhythm accompaniment for an entire song. (This is called a "rhythm song.") Up to 10 rhythm songs can be created, and one of these is selected for playback.

HINT

- You can also edit a rhythm pattern or create an original pattern.
- If desired, rhythm patterns and rhythm songs can be processed with the insert effect, and recorded on the audio tracks.

Mixer section

The signals from tracks 1 - 8, and the drum sounds are sent to separate mixer channels for individual adjustment of volume and tone and to create a stereo mix. For each track, the following parameters can be controlled independently.

- Volume
- Panning
- 2-band EQ
- Send level to the send/return effect
- Mute on/off
- V-take switching (except for drum track)

Effect section

The MRS-802 provides two types of effects: insert effects and send/return effects. These effects which can be used simultaneously have the characteristics described below.

Insert effect

This effect can be inserted at one of the following three points in the signal path.

- (1) Immediately after the input jack
- (2) A desired channel of the mixer
- (3) Immediately before the [MASTER] fader

In the default condition, position (1) (immediately after input jack) is selected.

When the setting is changed to (2), only a selected track or the drum sound is processed by the effect.

When the setting is changed to (3), the final stereo mix can be processed. This setting is suitable for processing the signal of the entire song during mixdown.

■ Send/return effect

This effect is internally connected to the send/return loop of the mixer section. There are two types of send/return effect, reverb and chorus/delay, which can be used simultaneously. The send level of each mixer channel adjusts the depth of the send/return effect. Raising the send level will produce a deeper reverb or chorus/delay effect for that channel.

Parts of the MRS-802

Top panel

In this manual, the names of faders, knobs, and other controls on the unit are enclosed in square brackets [].

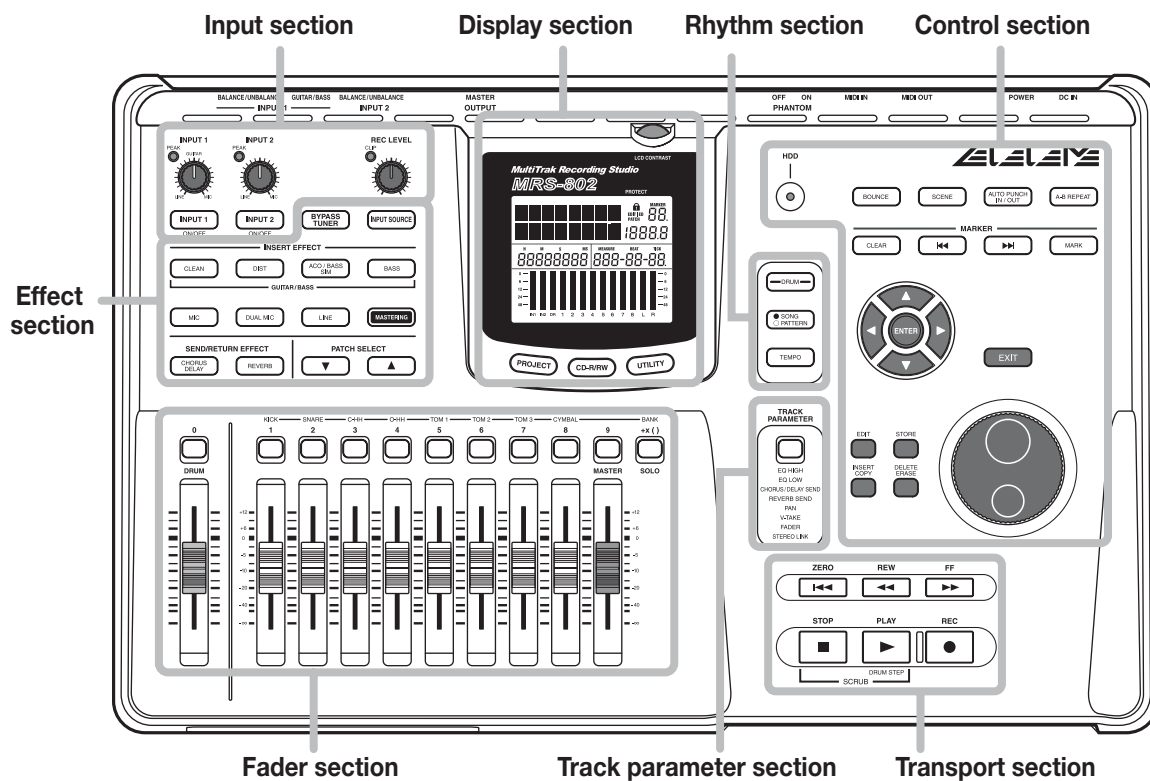

Input section

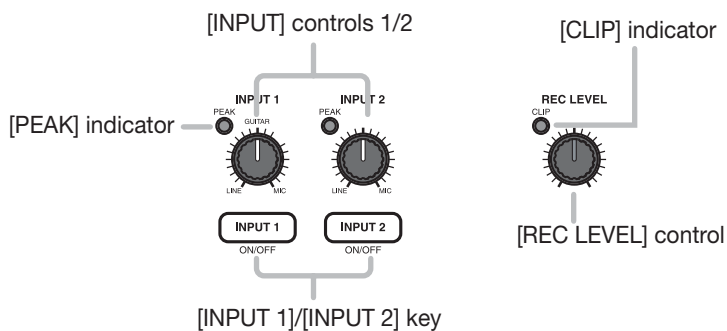

Display section

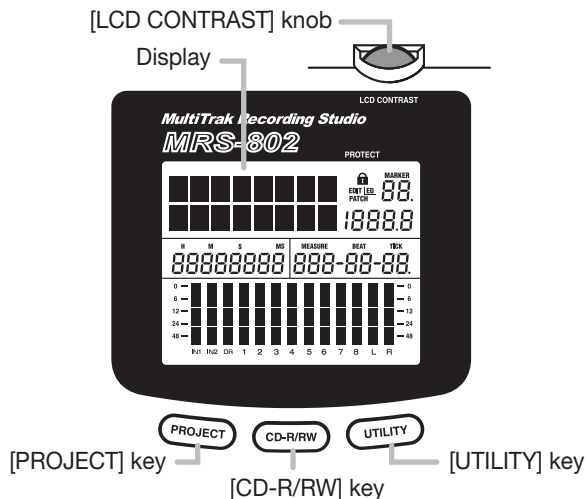

Effect section

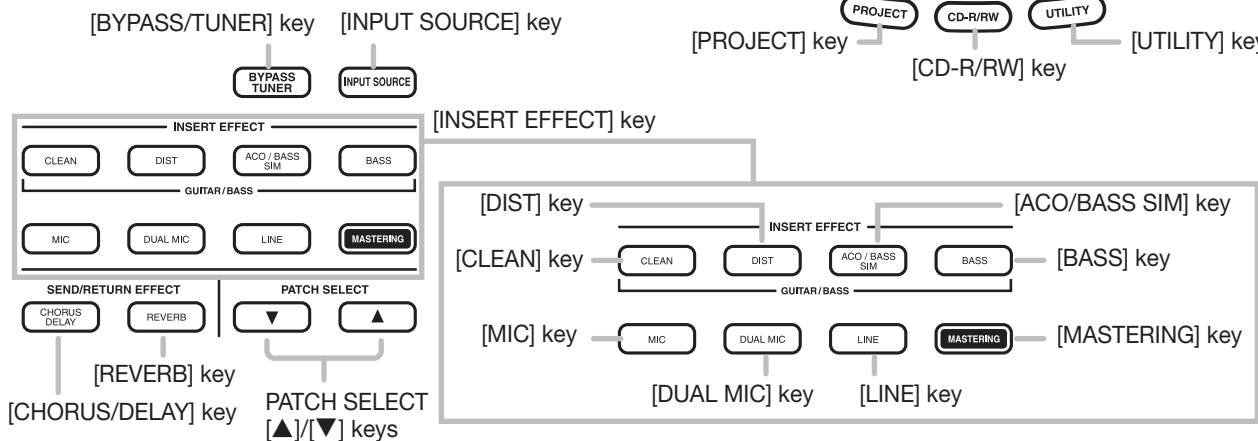

Fader section

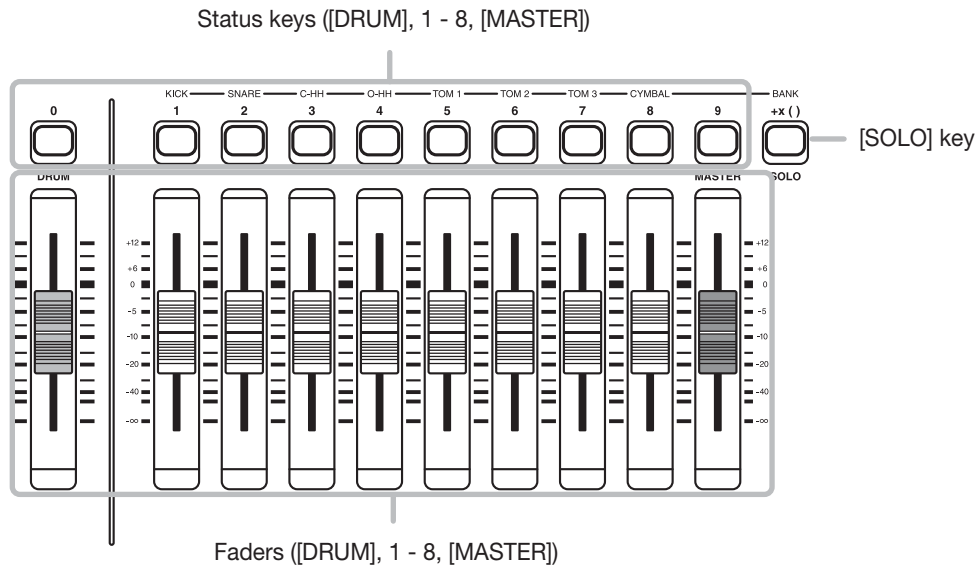

Rhythm section

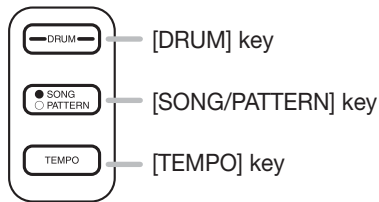

Control section

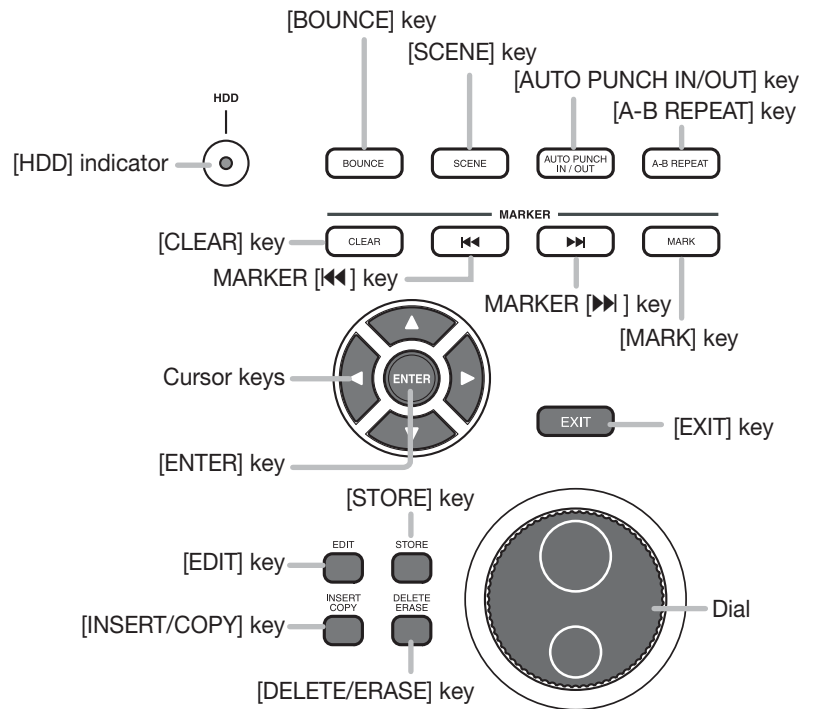

Track parameter section

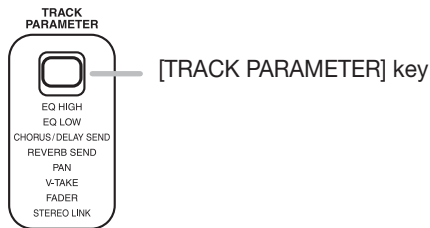

Transport section

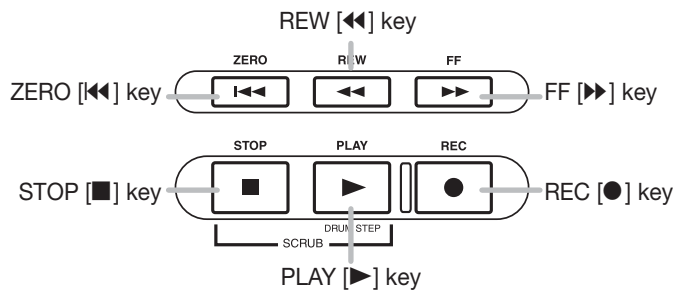

Rear panel

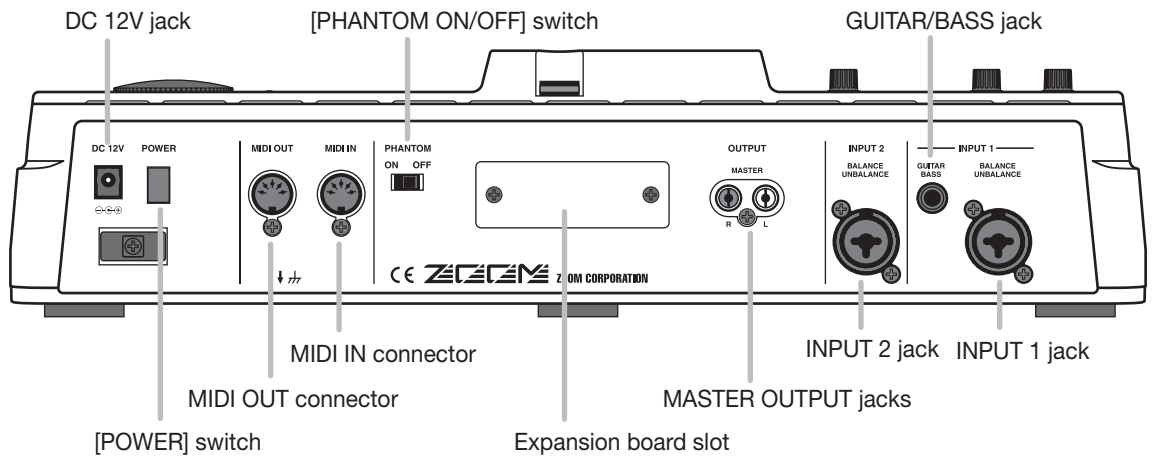

Front panel

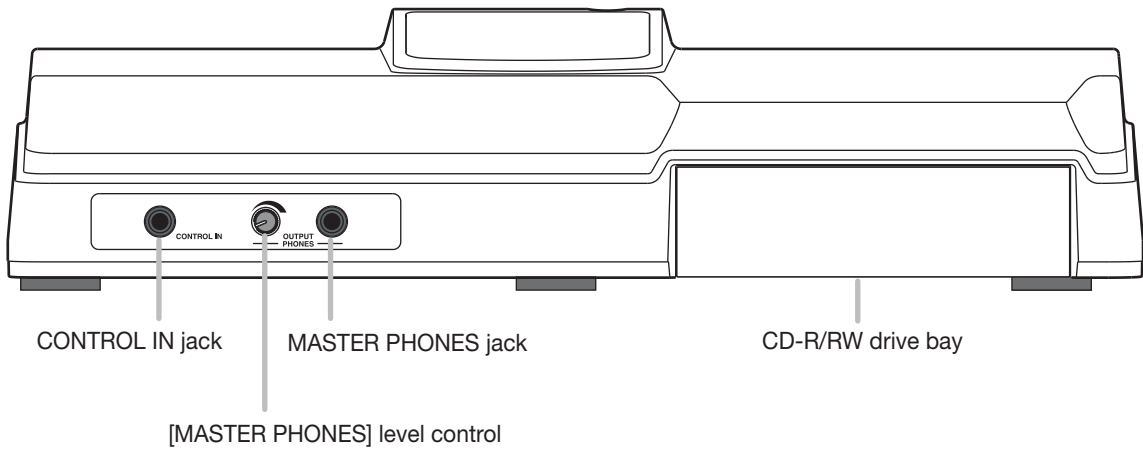

Connections

Connect your instruments, audio devices, and MIDI devices as shown in the following diagram.

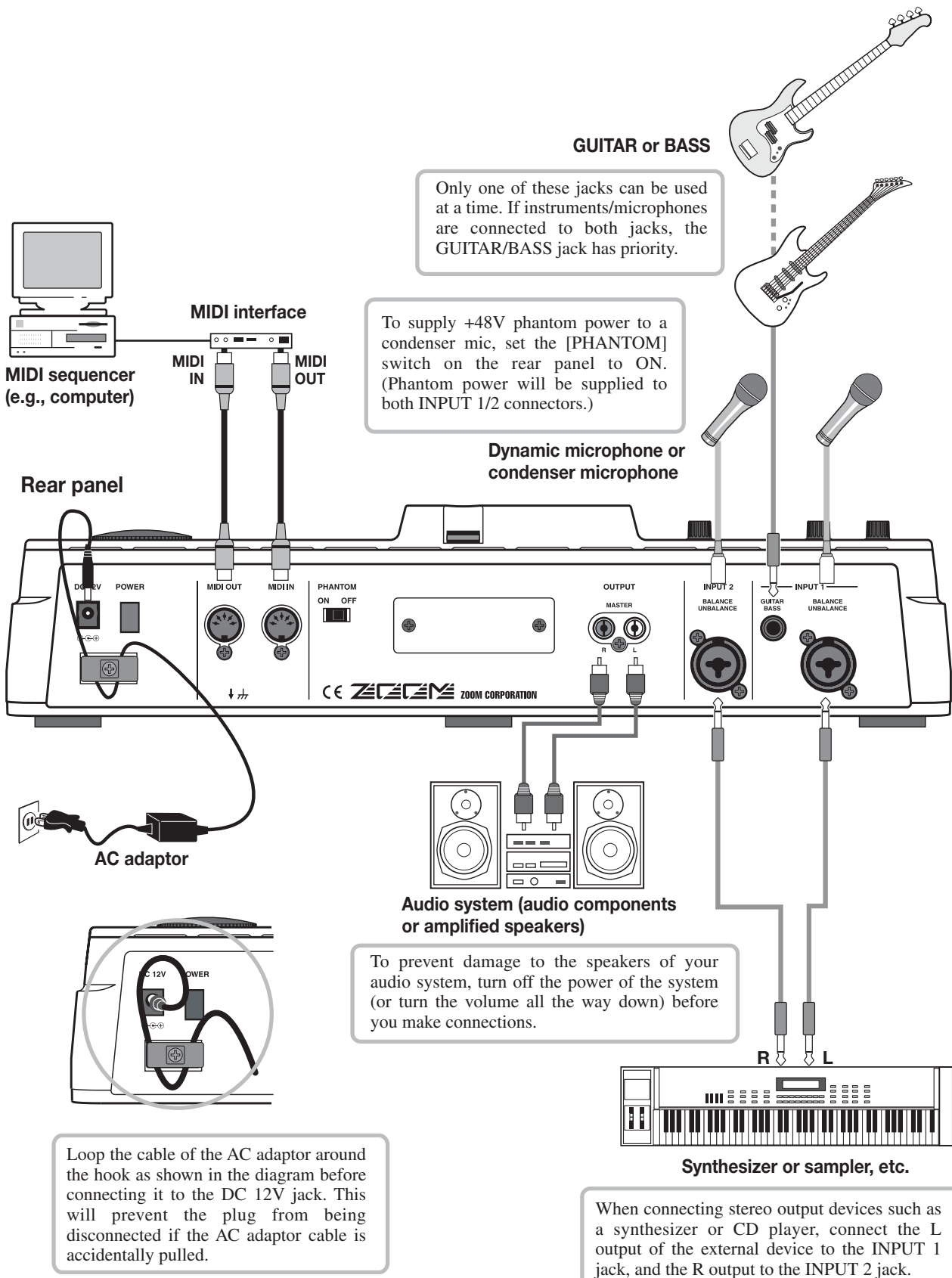

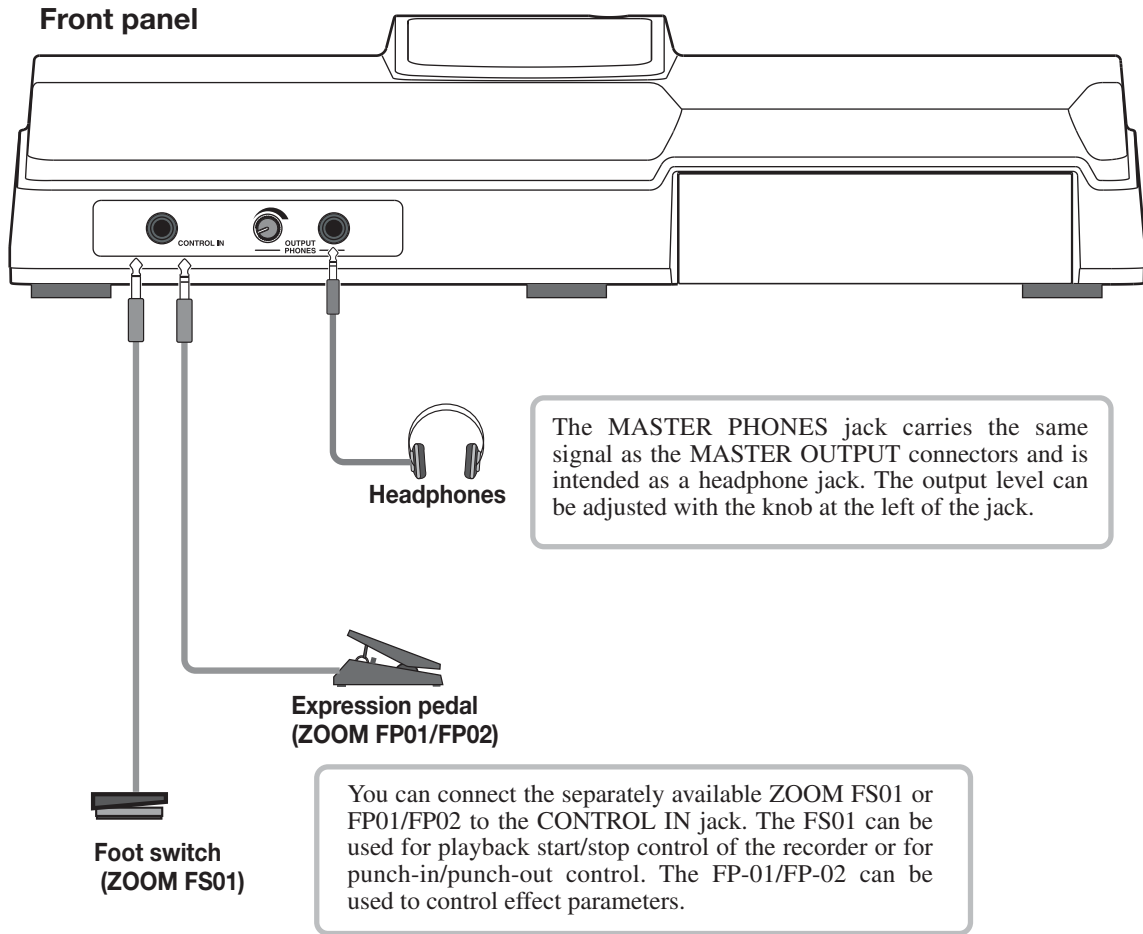

Rear panel

The diagram shows the rear panel of the ZOOM MRS-802 with a grounding jack circled in grey. The jack is labeled "Grounding jack" with an upward-pointing arrow. To the left of the jack is a ground symbol (a downward arrow with three horizontal lines) and a warning symbol (a triangle with an exclamation mark).

Grounding jack

Warning **■ About grounding**

Depending on installation conditions, a slight electrical charge may be felt when touching a metal part of the MRS-802. If you wish to avoid this, ground the unit by connecting the ground screw on the bottom to a good external ground.

To prevent the risk of accidents, never use one of the following for grounding:

- **Water pipe (risk of electric shock)**
- **Gas pipe (risk of explosion)**
- **Telephone wiring ground or lightning arrester (risk of lightning stroke)**

Installing the CD-R/RW Drive

To install the separately available CD-R/RW drive into the MRS-802 model without preinstalled CD-R/RW drive, proceed as follows.



Make sure to disconnect all cables and AC adaptor before installing the CD-R/RW drive.

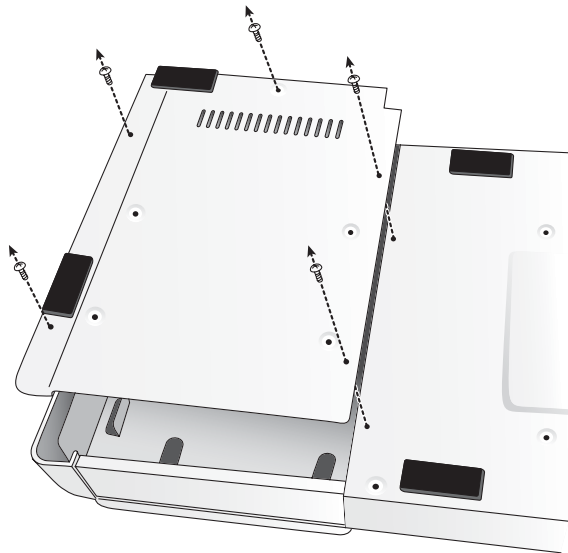

- 1.** Remove the drive mounting screws from the bottom of the MRS-802, and remove the bottom plate.

Take care not to lose the screws, since they will be required again for assembly.

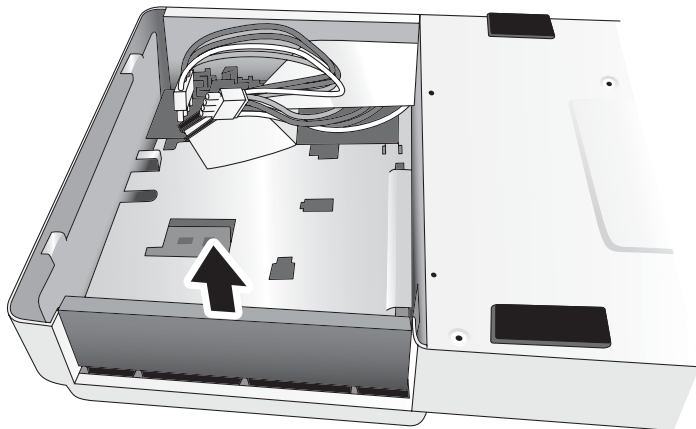

- 2.** Remove the drive bay blank panel from the front side of the chassis.

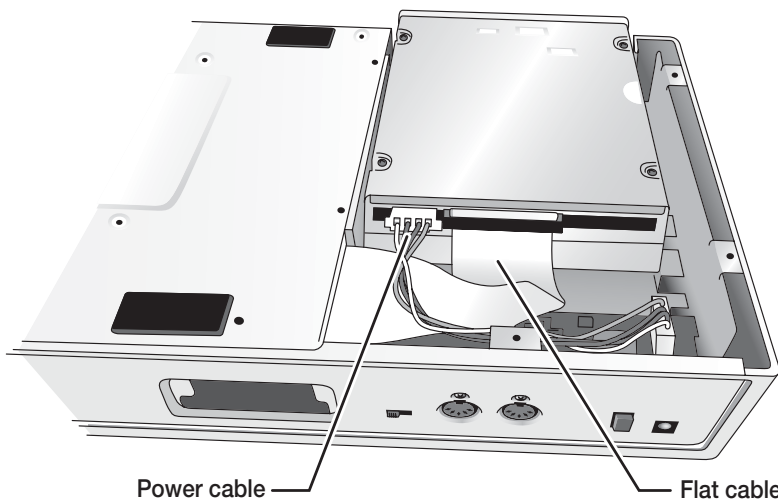

- 3.** Plug the power cable and flat cable from the chassis into the respective connectors on the CD-R/RW drive.

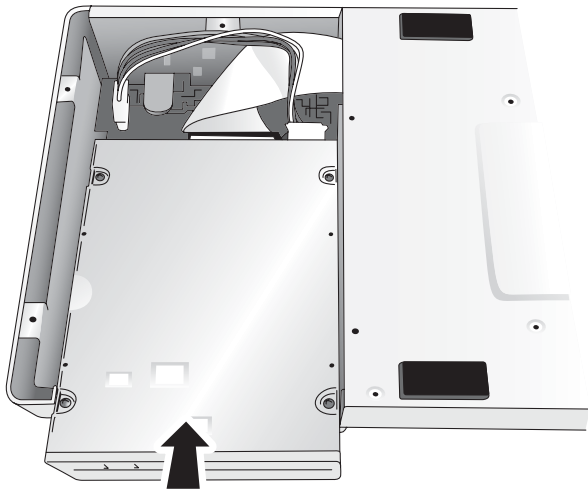

- 4.** Mount the drive on the drive bay adjusting location of the front panels of the drive and of the chassis.

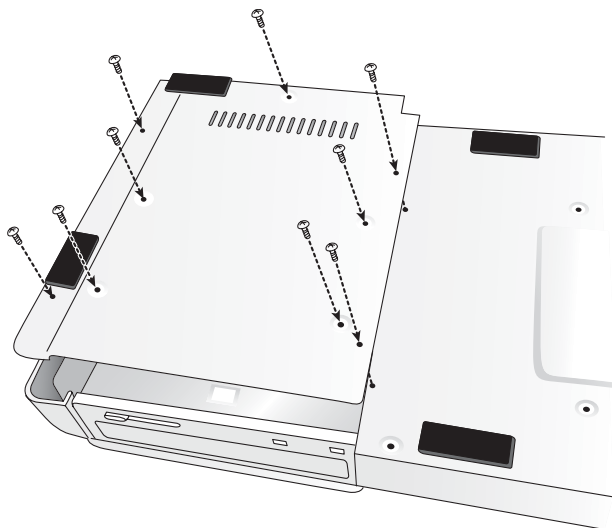

- 5.** Attach the bottom plate using the 4 supplied pan-head screws and those removed in step 1.

NOTE

- Make sure to use the optional CD-R/RW drive CD-01.
- Zoom Corporation does not accept any responsibility whatsoever for any kind of damage arising from the use of the other type of drive, whether they be direct or indirect from any third parties.

Listening to the Demo Songs

When shipped from the factory, the internal hard disk of the MRS-802 contains two demo songs. To listen to these, proceed as follows.

Demo song protect status

The demo songs on the hard disk are set to protected status, which means that level mixing and other settings can be changed while you play the song, but the changes cannot be stored on the disk. If you wish to retain changes you have made, disable the protect status (→ p. 127).

Turning on the power

1. Make sure that the AC adapter, instrument, and audio system (or headphones) are correctly connected to the MRS-802. (For information on connections, refer to page 15.)

2. Press the [POWER] switch on the rear panel.

Power to the MRS-802 comes on, the unit performs a self-test, and switch settings are read. Wait until the following indication appears on the display. This screen is called the main screen.

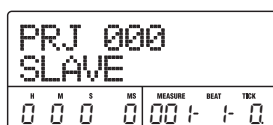

3. Turn on the audio system connected to the MASTER OUTPUT jacks.

HINT

When a synthesizer or other electronic instrument is connected to the MRS-802, turn power on in the order synthesizer → MRS-802 → audio system. Turn power off in the reverse order.

Selecting the demo song

On the MRS-802, song data are managed in units called "projects". A project encompasses recorded audio data, rhythm patterns and rhythm songs of the rhythm section, internal effect patches (effect programs), and other information. When you load a project, the complete state in which that song was saved will be reproduced.

To load the demo song project from the hard disk, proceed as follows.

1. Press the [PROJECT] key.

The indication "PROJECT SELECT" appears on the display. This is the screen for selecting a project.

2. Press the [ENTER] key.

Projects stored on the hard disk are shown in the lower part of the display.

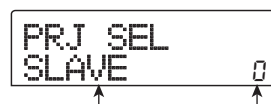

Project name Project number

3. Turn the dial to select the demo song.

Projects number 0 and 1 are demo songs.

4. Press the [ENTER] key.

The selected project is loaded. While the hard disk is being accessed, the [HDD] indicator lights up and the indication "LOADING" appears on the display. When the display changes, the demo song has been loaded.

Playing the demo song

After loading, play the demo song as follows.

1. Turn down the volume of the audio system.

When headphones are connected, turn down the [MASTER PHONES] level control.

2. Press the PLAY [▶] key in the transport section.

Playback of the demo song starts.

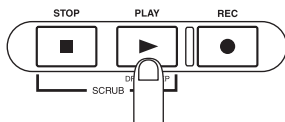

3. Adjust the audio system volume setting (or the [MASTER PHONES] level control) to a comfortable volume.

4. If you want to adjust the volume of the individual tracks, use the respective faders.

The volume of the drum track from the rhythm section can be adjusted with the [DRUM] fader. If you want to adjust the volume of the entire song, use the [MASTER] fader.

5. To switch individual tracks on or off, press the respective status key.

6. To stop the demo song, press the STOP [■] key.

Turning power off (shutdown)

Whenever you want to turn the MRS-802 off, be sure to follow the procedure described below.

1. Turn power to the audio system off.

2. Press the [POWER] switch on the rear panel of the MRS-802.

If a non-protected project was being used, the state of this project is automatically saved on the hard disk before the unit shuts down.

Caution

- You must use this method to turn off the power of the MRS-802. Never turn off the power by disconnecting the AC adaptor plug from the DC 12V jack or by unplugging the AC adaptor from the AC power outlet.
- In particular, you must never turn the power off by unplugging the AC adaptor while the [HDD] indicator is lit. Doing so may damage the internal hard disk, causing all data to be lost permanently.

Quick Tour

This section explains the process of creating a project, recording instruments and vocals, and performing mixdown onto the master tracks.

This Quick Tour comprises the four steps listed below.

- **Step 1: Preparations**

Shows how to create a new project, select a guide rhythm, and perform other steps necessary for recording.

- **Step 2: Recording the first track**

Shows how to record the first track while using the insert effect.

- **Step 3: Overdubbing**

Shows how to record further tracks while listening to a track already recorded (overdubbing).

- **Step 4: Mixdown**

Shows how to adjust the level, panning, and EQ of each track, apply the send/return effect, and mix the recorded tracks down to a pair of stereo tracks. Finally the mastering insert effect is applied to the finished mix and the result is recorded on the master track to create the finished song.

Step 1: Preparations

1.1 Creating a new project

On the MRS-802, song data are managed in units called “projects”.

A project encompasses the following information:

- All recorder section data
- All mixer section settings
- All rhythm section settings
- All internal effect settings
- Other information (scene, mark, MIDI, etc.)

1. Press the [PROJECT] key in the display section.

The menu for loading and copying projects appears.



2. Use the cursor left/right keys to bring up the indication “PROJECT NEW” on the display.



HINT

For information on other items that can be selected from the project menu, refer to page 124.

3. Press the [ENTER] key.

The number and name for the project to be created appear on the display.

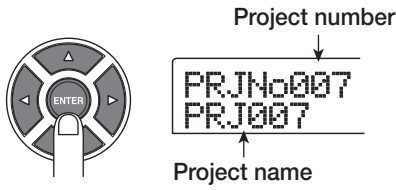

HINT

- When creating a new project, the lowest free project number is automatically selected.
- If desired, you can change the project name at this stage. Use the cursor left/right keys to move the flashing position, and turn the dial to select a letter.

4. Press the [ENTER] key once more.

A new project is created.

HINT

- When selecting a different project or creating a new project, the project you were working on up to that point is automatically saved.
- When performing the shutdown (→ p.20) procedure for the MRS-802, the last project is automatically saved.

1.2 Selecting a rhythm pattern

The rhythm section of the MRS-802 provides drum sounds (drum kits) which can repeatedly play accompaniment patterns of several measures in length (these are called “rhythm patterns”). By arranging rhythm patterns in the desired order, you can create the accompaniment for an entire song. (This is called a “rhythm song”).

This section describes how you can select one of the built-in 511 rhythm patterns and use it as a guide rhythm.

HINT

- If desired, you can create the rhythm accompaniment as a rhythm song. (For details on how to do this, see page 80.)
- When you have created a rhythm song, you can use it as part of a song.

1. Then set the [DRUM] and [MASTER] faders to the 0 (dB) position. Press the [DRUM] status key repeatedly until the key is lit.

The drum kit output signal (drum track) is sent to the mixer section. As for an ordinary audio track, the [DRUM] status

key and the [DRUM] fader can be used to turn the respective sound on or off and to adjust the level.

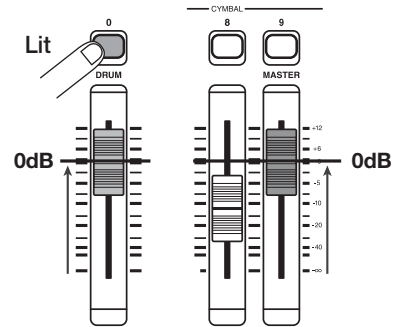

2. Press the [DRUM] key in the rhythm section.

The [DRUM] key lights up and the display shows the rhythm pattern number and name. The first line of the display shows the rhythm pattern number and the number of measures. The second line shows the rhythm pattern name. The right side of the counter shows the current measure/beat/tick position within the rhythm pattern.

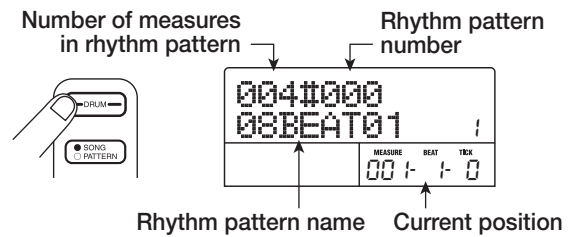

HINT

While the [DRUM] key is lit, the recorder section and rhythm section are disconnected and the rhythm section can be played.

3. Turn the dial to select the number of the rhythm pattern to be used as guide rhythm.

The MRS-802 has 511 rhythm patterns of which more than 400 are preprogrammed.

The illustration below shows the display when rhythm pattern no. 30 (ROCK01) has been selected.

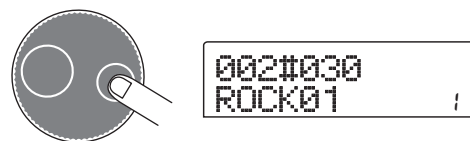

4. Press the PLAY [▶] key.

The selected rhythm pattern starts. When the last measure has been played, playback jumps to the beginning and continues.

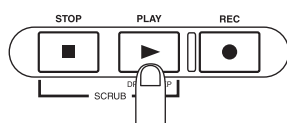

HINT

During play, the status key for the drum sound lights up. You can also press the status key to play the corresponding drum sound (→ p. 77).

5. To change the rhythm pattern, you can use the dial or the cursor up/down keys.

When you turn the dial to select another pattern, the new pattern will start playing when the end point of the current pattern is reached. (The display indication flashes until the pattern starts playing.)

If you use the cursor up/down keys to select the pattern, playback starts at that point.

6. To change the tempo, press the [TEMPO] key in the rhythm section and turn the dial to change the tempo value (BPM) shown on the display.

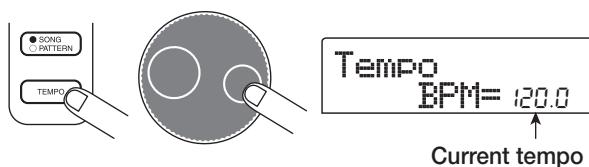

When the setting is complete, press the [EXIT] key to return to the previous screen.



NOTE

If you record a track while listening to the rhythm section and you change the rhythm tempo afterwards, the rhythm section and recorded contents may become mismatched. You should therefore always set the tempo first and then record the audio track.

HINT

You can also change the tempo setting by tapping the [TEMPO] key (→ p. 79).

7. To stop playback, press the [STOP] key.

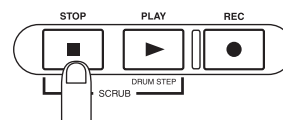

8. To return to the main screen, press the [EXIT] key several times.

The [DRUM] key goes out. When you use a key of the transport section in this condition, the rhythm section and recorder section will operate in sync.

HINT

You can also create an original rhythm pattern (→ p. 90).

Step 2: Recording the first track

In this step, you record the first track while listening to the rhythm section. As an example we describe how to record an electric guitar on track 1 with the insert effect.

2.1 Adjusting input sensitivity

1. Connect an instrument to the GUITAR/BASS jack (→ p. 15).

To connect a synthesizer or other component with line-level stereo output, use the INPUT 1/INPUT 2 jacks on the rear panel. To connect a guitar or bass, use the GUITAR/BASS jack.

HINT

When something is connected to both the GUITAR/BASS jack and the INPUT 1 jack on the rear panel, the GUITAR/BASS jack has priority. To adjust the GUITAR/BASS input sensitivity or switch the jack on/off, use the INPUT 1 control.

2. Press the [INPUT 1] key so that the key lights up.

The [INPUT 1]/[INPUT 2] keys serve to switch the respective input on and off. While the key is lit, the input is active.

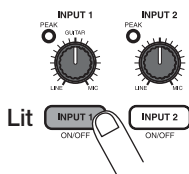

HINT

To record the output of a synthesizer or similar in stereo, connect the L and R output to the INPUT 1/INPUT 2 jacks and press both the [INPUT 1] and [INPUT 2] keys so that both keys are lit.

3. While playing the instrument, use the [INPUT] control 1 to adjust sensitivity.

Adjust the control so that the [PEAK] indicator lights up occasionally when you play the instrument at the loudest level.

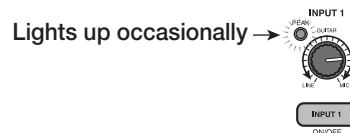

4. While playing the instrument, use the [REC LEVEL] control to adjust the recording level.

The [REC LEVEL] control modifies the signal level going to the recorder (after passing the insert effect). The IN1/IN2 level meter in the lower left of the display shows the level. Set the level as high as possible, but avoid settings that cause the 0 dB indicator to light during play peaks.

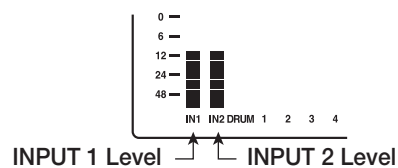

If the recording level setting is too high, the [CLIP] indicator of the [REC LEVEL] control lights up.

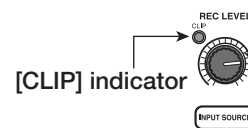

2.2 Applying the insert effect

The signal supplied to the MRS-802 can be modified with the insert effect. This effect can be applied to the input, to any track, or immediately before the [MASTER] fader. The insert effect actually is a multi-effect unit that contains a number of single effects (effect modules) such as compressor, distortion, and delay, connected in series. A combination of effect modules that can be used simultaneously is called an “algorithm”.

The following steps show how to select an algorithm and apply the insert effect to the guitar signal connected to the GUITAR/BASS jack.

1. Press the [INPUT SOURCE] key in the effect section.

The insert position of the insert effect is indicated on the 2nd line of the display. The default is “IN” (INPUT). To change the setting, turn the dial to select “IN”.



2. Use the [INSERT EFFECT] keys to select the desired algorithm.

There are eight keys which correspond to different algorithms. The following selections are available (For details on algorithms, see p. 100) .

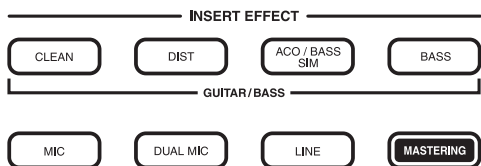

- CLEAN
- DIST
- ACO/BASS SIM
- BASS

These algorithms are for recording guitar/bass.

- MIC

An algorithm for vocals or microphone recording.

- Dual MIC

An algorithm for two entirely separate mono input and mono output channels.

- LINE

An algorithm mainly for recording line-level output instruments such as synthesizer or electric piano.

- MASTERING

An algorithm for processing a stereo mix signal, such as during mixdown.

The selected key lights up and a patch using the selected algorithm is shown on the display.

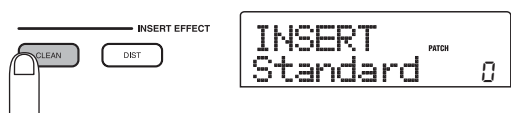

3. Turn the dial to select the patch.

A total of 280 patches are available for the insert effect. You can edit these patches if desired to alter the sound or the effect depth (→ p. 103).

The number of patches for each algorithm is listed below.

Algorithm	Patch number	Algorithm	Patch number
CLEAN	0 – 24	MIC	0 – 49
DIST	0 – 44	DUAL MIC	0 – 49
ACO/BASS SIM	0 – 14	LINE	0 – 49
BASS	0 – 14	MASTERING	0 – 29

HINT

The recording level may change if you change the selected patch. If necessary, readjust the recording level with the [REC LEVEL] control.

4. To return to the main screen, press the [EXIT] key several times.

HINT

To record without using the insert effect, press the [BYPASS/TUNER] key at the main screen. The key lights up and the insert effect is bypassed.

2.3 Selecting a track and recording

Now we will record the guitar sound (with the insert effect applied) on track 1.

1. Repeatedly press the status key 1 until the key is lit in red.

Status keys 1 - 8 are used to select the recording track and to switch muting for each track on and off. Each time you press a status key, the key will cycle through the following states:

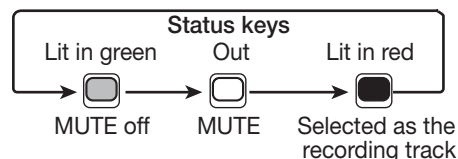

When status key 1 is red, track 1 is in the recording standby condition, and the input signal routing will change as follows.

When a recording track has not been selected

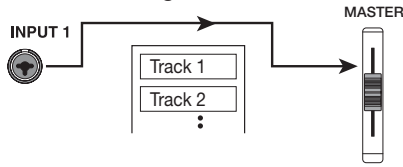

When a recording track (track 1) has been selected

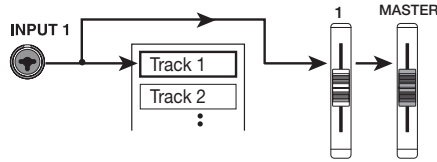

HINT

You can select up to two tracks simultaneously for recording. (Allowable track pairs are 1/2, 3/4, 5/6, and 7/8.)

2. Set fader 1 and the [MASTER] fader to 0 dB. Then adjust the volume of the monitor system while playing your instrument.

3. To begin recording, press the ZERO [◀◀] key to return to the beginning of the song. Then hold down the REC [●] key and press the PLAY [▶] key.

The REC [●] key and PLAY [▶] key will light, and recording will begin. Record your instrument playing while listening to the rhythm section.

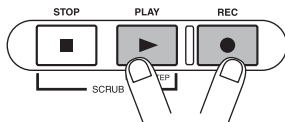

The recording level can be checked with the IN1/IN2 level meter in the lower left of the display and the [CLIP] indicator of the [REC LEVEL] control.

4. When you have finished recording, press the STOP [■] key.

The REC [●] key and PLAY [▶] key will go out, and recording will stop. The indication “wait...” is briefly shown on the display, and then the main screen returns.

NOTE

The duration of the “wait...” period may differ depending on the recording condition. Never turn power to the unit off while “wait...” is being shown on the display. Otherwise recorded data may be lost and damage to the unit may occur.

5. To listen to the recorded content, press the ZERO [◀◀] key to return to the beginning of the song, and press the PLAY [▶] key.

The track will be played back together with the rhythm section.

HINT

The REW [◀◀] key and FF [▶▶] key only operate when the recorder is in the stop mode.

6. To stop playback, press the STOP [■] key. If you want to re-do the recording, repeat steps 3 and 4.

7. Press status key 1 until the key is lit in green.

The recording standby condition of track 1 is canceled.

HINT

- Recorded content can be copied, deleted, or edited as an entire track or by specifying a range (→ p. 46).
- By using switching the V-take for the track, you can record a new take while preserving the current take (→ p. 33).

Basic operation of transport keys

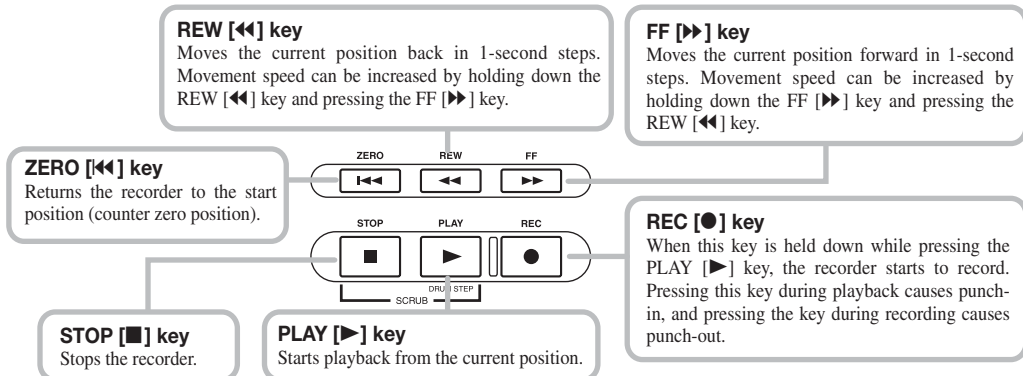

Step 3: Overdubbing

In this step, you will learn how to record another instrument on a new track, while listening to the guitar part you already recorded. Recording additional parts in this way is called “overdubbing”.

3.1 Making settings for input sensitivity and insert effect

- 1.** Connect an instrument or microphone to the INPUT 1 jack.
- 2.** Press the [INPUT 1] key so that the key lights up.
- 3.** While playing the instrument, use the [INPUT] control 1 to adjust sensitivity.
- 4.** While playing the instrument, use the [REC LEVEL] control to adjust the recording level.
- 5.** Select the algorithm and patch for the insert effect as described for Step 2.
- 6.** To return to the main screen, press the [EXIT] key several times.

3.2 Selecting a track and recording

Now you'll record the second instrument on track 2.

- 1.** Repeatedly press the status key 2 until the key is lit in red. Verify that the status key 1 and the [DRUM] status key are lit in green.

Track 2 is in the recording standby condition.

- 2.** Set the [MASTER] fader to 0 dB and use fader 2 to adjust the monitor level.

If necessary, set the recorder to playback and operate faders 1/2 and the [DRUM] fader to adjust the monitor level balance between tracks.

- 3.** To begin recording, press the ZERO [◀◀] key to

return to the beginning of the song. Then hold down the REC [●] key and press the PLAY [▶] key.

Recording on track 2 will begin. Play your instrument while listening to the rhythm section and track 1.

- 4.** When you have finished recording, press the STOP [■] key.

The indication “wait...” is briefly shown on the display, and then the main screen returns.

NOTE

The duration of the “wait...” period may differ depending on the recording condition. Never turn power to the unit off while “wait...” is being shown on the display. Otherwise recorded data may be lost and damage to the unit may occur.

- 5.** To listen to the recorded content, press the ZERO [◀◀] key to return to the beginning of the song, and press the PLAY [▶] key.

The rhythm section and tracks 1/2 will be played back. Adjust the fader 1/2 and the [DRUM] fader as necessary.

- 6.** To stop playback, press the STOP [■] key.

- 7.** Press status key 2 until the key is lit in green.

Use the same procedure to record other tracks.

Step 4: Mixdown

When you have finished recording all tracks, you can use the built-in mixer to adjust parameters such as volume level, EQ (equalizer), and panning (stereo left/right positioning) to create a pair of stereo tracks to create the finished song. This process is called “mixdown”.

The result of the mixdown process can be either recorded on an external master recorder or on the master track incorporated in the MRS-802. The following example describes recording on the master track.

HINT

Instead of the master track you can also select one or two ordinary tracks as recording target. This is called “bounce recording”. After using this function, you can switch the source V-take and record a new part. This is convenient when there are not enough free recording tracks. (For information on the bounce function, see page 39.)

4.1 Preparations for mixdown

1. Make sure that all status keys for the tracks you want to mix are lit in green, and that the other status keys are out.

If the rhythm section was used simply as guide rhythm, turn the [DRUM] status key off so that the drum track will not be added to the mix.

2. Turn the [INPUT 1] and [INPUT 2] keys off.

HINT

You can also add the signal from input 1 and/or input 2 to the mix. To do this, set the [INPUT 1] and/or [INPUT 2] key to on.

- Track parameter and setting range

Parameter	Display	Setting range	Description
EQ HIGH GAIN	EQ HI G	-12 – +12	Adjusts high-frequency boost/cut from -12 dB to +12 dB.
EQ HIGH FREQUENCY	EQ HI F	500 – 18000(Hz)	Adjusts turnover frequency for high-frequency boost/cut.
EQ LOW GAIN	EQ LO G	-12 – +12	Adjusts low-frequency boost/cut from -12 dB to +12 dB.

3. Set the [MASTER] fader to 0 dB.

4.2 Adjusting volume, panning, and EQ

1. On the main screen, press the [TRACK PARAMETER] key. The track parameter menu appears which lets you set parameters separately for each track.

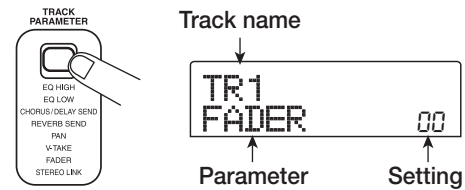

2. Use the status keys or the cursor left/right keys to select a track.

When the track parameter display is shown, you can use the status keys or the cursor left/right keys to select a track. The currently selected status key is lit in orange.

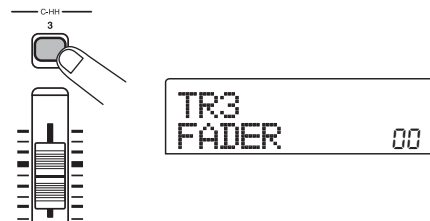

3. Use the cursor up/down keys to select a track parameter.

The currently selected parameter is shown on the second line of the display. Selectable track parameters and setting ranges are as follows.

EQ LOW FREQUENCY	EQ LO F	40 – 1600(Hz)	Adjusts turnover frequency for low-frequency boost/cut.
CHORUS/DELAY SEND LEVEL	CHO SEND	0 – 100	Adjusts signal level provided from selected track to chorus/delay of send/return effect.
REVERB SEND LEVEL	REV SEND	0 – 100	Adjusts signal level provided from selected track to reverb of send/return effect.
PAN	PAN	L100 – 0 – R100	Adjusts panning value (left/right position) for track. If ST LINK parameter is on, this adjusts left/right balance.
FADER	FADER	0 – 127	Shows current fader position as numeric value.
STEREO LINK (*)	ST LINK	ON/OFF	Switches stereo link feature (to combine odd/even numbered tracks 1/2, 3/4 etc.) on or off (→ p. 73).
V TAKE (*)	TR x-y	x=1 – 8 y=1 – 10	Selects V-take for track (→ p. 33). x is track number and y is V-take number.

(*) = Denotes parameter that can be selected only for tracks 1 - 8.

HINT

By pressing the [INPUT 1] or [INPUT 2] key instead of a status key, you can adjust the parameters for the signal from input 1 or 2 (→ p.68).

4. Turn the dial to select the setting value.

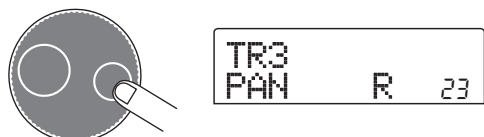

HINT

When one of the following track parameters is displayed, pressing the [ENTER] key toggles the parameter between on and off.

EQ HI G/EQ HI F	High-frequency EQ on/off
EQ LO G/EQ LO F	Low-frequency EQ on/off
CHO SEND	Chorus/delay signal on/off
REV SEND	Reverb signal on/off

4.3 Applying the send/return effect

The internal mixer of the MRS-802 incorporates two kinds of send/return effects (chorus/delay and reverb).

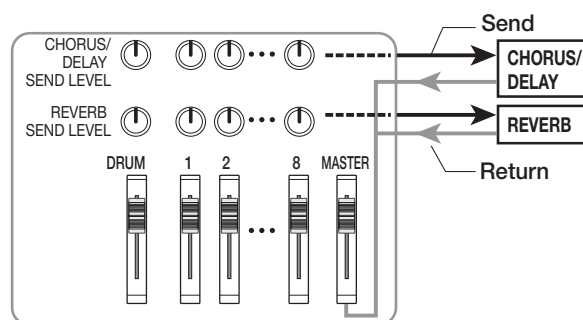

The intensity of the send/return effect can be adjusted for each track by using the send level parameter (which controls the signal level that is sent to the effect). Increasing this parameter will result in increased effect. This section describes how to select the send/return effect type and adjust the send level for each track.

■ **Selecting the send/return effect patch**

- 1.** From the main screen, press the [REVERB] key or [CHORUS/DELAY] key in the effect section.

Press the [REVERB] key to select a reverb patch, or the [CHORUS/DELAY] key to select a chorus/delay patch. The display will indicate the patch that is currently selected for the effect you selected. For example, a screen such as shown below appears when the [REVERB] key is pressed.



- 2.** Turn the dial to select a patch.

The send/return effect has 20 preprogrammed patches (numbered 0 - 19). If desired, you can edit these patches to modify the effect further (→ p.108).



- 3.** Select the patch for the other send/return effect in the same way.
- 4.** To return to the main screen, press the [EXIT] key several times.

● **NOTE** ●

In the default condition, the send level for the send/return effect is set to 0 for each track. Therefore you need to raise the setting to verify the sound produced by the effect.

■ **Adjusting the send/return effect intensity for each track**

- 5.** From the main screen, press the [TRACK PARAMETER] key and use the status keys to select the track for which you want to make the setting.
- 6.** Use the cursor up/down keys to bring up the indication CHO SEND or REV SEND onto the second line of the display.

Select CHO SEND if you want to adjust the chorus/delay send level. Select REV SEND if you want to adjust the reverb send level.



- 7.** While playing the song, turn the dial to adjust the send level value.



- 8.** Adjust the send level for other tracks in the same way.
- 9.** Adjust the intensity of the other send/return effect in the same way.
- 10.** To return to the main screen, press the [EXIT] key several times.

4.4 Using the mastering insert effect

You can place the insert effect immediately before the [MASTER] fader and use one of the MASTERING algorithm patches to modify the dynamics or tone of the stereo mix of the entire song.

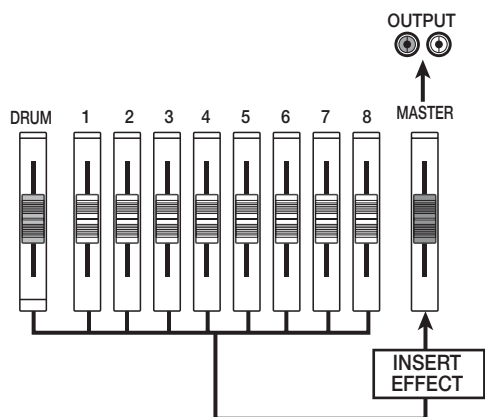

To apply the mastering effect to the entire song, proceed as follows.

■ Changing the insert location of the insert effect

1. From the main screen, press the [INPUT SOURCE] key in the effect section.

The current insert effect position is shown on the display.



2. Turn the dial to bring up the indication "MASTER" on the second line of the display.

Now the insert effect is inserted immediately before the [MASTER] fader.



3. Press the [EXIT] key.

The unit returns to the main screen.

■ Selecting a patch for the insert effect

4. Press the [MASTERING] key in the effect section.
The insert effect algorithm is switched to MASTERING.
The display shows the currently selected patch.



5. While playing the song, select the patch you want to use.

If desired, you can edit the patch to modify the effect further (→ p. 103).

6. When you have verified that the sound is as desired, press the [EXIT] key.

The unit returns to the main screen.

4.5 Mixdown on the master track

The master track is a stereo track designed only for use during mixdown. The signal immediately after the [MASTER] fader is recorded on the master track. Like other tracks, the master track also has 10 V-takes.

After mastering effect settings have been completed, record the final mix on the master track.

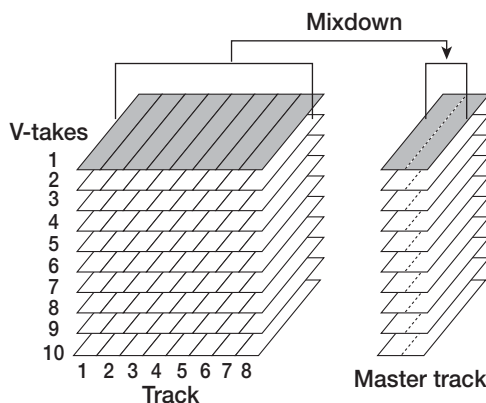

1. Press the ZERO [◀◀] key to return to the beginning of the song.

- 2.** Press the PLAY [▶] key to play the song, and check the level after the [MASTER] fader.

This can be done by observing the level meter in the lower right of the display. If the 0 dB indicator lights up during play, turn down the [MASTER] fader to perform fine adjustment. After checking the level, press the STOP [■] key.

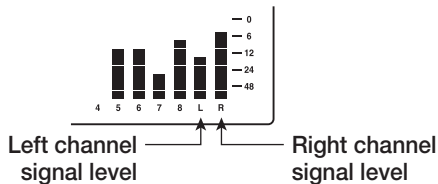

- 3.** Repeatedly press the [MASTER] status key so that the key lights up in red.

The master track can now be recorded.

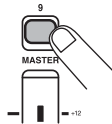

- 4.** Hold down the REC [●] key and press the PLAY [▶] key.

Recording on the master track starts.

- 5.** When recording is completed, press the STOP [■] key.

- 6.** To play the master track, repeatedly press the [MASTER] status key until it is lit in green.

In this condition, the master track can be played. All other status keys automatically go out and the signals from other tracks are automatically muted.

- 7.** Press the ZERO [◀◀] key to return to the beginning of the song, and press the PLAY [▶] key.

The master track is played back. To stop playback, press the STOP [■] key.

- 8.** To return the MRS-802 to normal operation, repeatedly press the [MASTER] status key until it is out.

Muting of other tracks is canceled, and the status keys revert to the original condition.

HINT

- With the CD-R/RW drive, you can record the contents of the master track onto CD-R/RW media to create an audio CD. For details, refer to page 111.
- The contents of the master track can also be edited later.

Reference [Recorder]

Using V-takes

Each track 1 - 8 of the recorder contains ten virtual tracks, called "V-takes". For each track, you can select one take, which will be used for recording and playback. For example, you can switch V-takes as you record multiple vocal or guitar solos on the same track, and later compare them and select the best V-take.

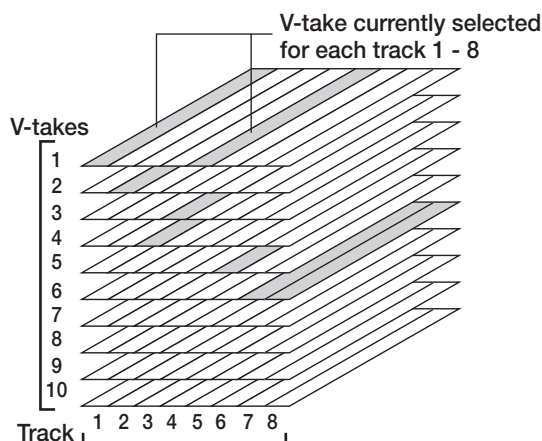

indication "NO DATA" is shown instead of the V-take name. In the level meter display area, a lit dot indicates a recorded V-take. If the dot is out, the V-take is unrecorded.

A flashing dot indicates the currently selected V-take for each track. (The dot for the selected V-take will flash at the same frequency regardless of whether it is recorded or not.)

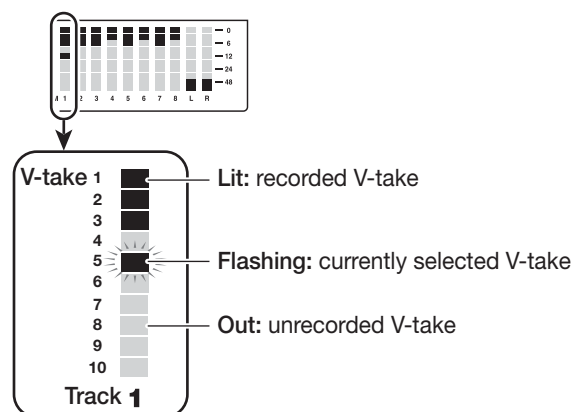

3. Use the cursor left/right keys to select the track.

```
TR 3- 1
GTR 3- 1
```

Switching V-takes

Here's how to switch the V-take used by each track 1 - 8.

1. From the main screen, press the [TRACK PARAMETER] key in the track parameter section.

The key lights up and you can select various track parameters.

2. Use the cursor up/down keys to bring the indication "TR xx-yy" onto the display (where xx is the track number and yy the V-take number).

The V-take name is shown under the track number/V-take number.

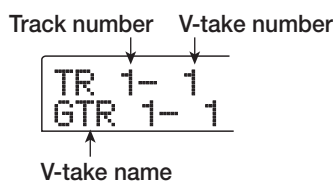

HINT

You can also select the track with the status keys (1 - 8, [MASTER]).

4. Turn the dial to select the V-take.

5. Repeat steps 3 - 4 as necessary, to select a V-take for each track.

6. When you have finished selecting V-takes, press the [EXIT] key.

The [TRACK PARAMETER] key goes out, and the unit returns to the main screen.

Editing V-take names

A V-take that has been recorded will be automatically assigned a default name, according to the following pattern.

- GTRxx-yy

V-take recorded through insert effect CLEAN, DIST, or

HINT

If you select a V-take on which nothing is recorded, the

ACO/BASS SIM

- **BASxx-yy**

V-take recorded through insert effect BASS

- **MICxx-yy**

V-take recorded through insert effect MIC

- **DULxx-yy**

V-take recorded through insert effect DUAL MIC

- **LINxx-yy**

V-take recorded through insert effect LINE

- **MASxx-yy**

V-take recorded through insert effect MASTERING

- **BYPxx-yy**

V-take recorded while bypassing the insert effect

- **BOUxx-yy**

V-take recorded using bounce function or rhythm recording function

- **LP_xx-yy**

Phrase written to V-take using phrase loop function

(→ p. 57)

HINT

When you write a phrase to the master track, the name "LP_MS_yy" is automatically assigned.

These names can be changed as desired. To do this, proceed as follows.

1. From the main screen, press the [TRACK PARAMETER] key.

NOTE

Only the name of the currently selected V-take of tracks 1 - 8 can be changed.

2. Use the cursor up/down keys to bring the indication "TR XX-YY" onto the display (where X, Y is the track number and V-take number).

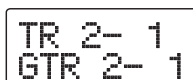

3. Use the cursor left/right keys to select the track whose V-take name you want to edit.

You can also select the track with the status keys (1 - 8, [MASTER]).

NOTE

If you select a V-take on which nothing is recorded, the indication "NO DATA" appears and the name cannot be edited.

4. Press the [EDIT] key.

The cursor (flashing box) is on the first character of the V-take name. This indicates that you can change this character.

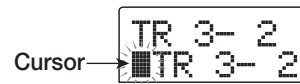

5. Use the cursor left/right keys to move the cursor to the character you want to change.

6. Turn the dial to select a character.

The following characters can be selected.

Numerals: 0 - 9

Letters: A - Z, a - z

Symbols: (space) ! " # \$ % & ' () ■ + , - . / : ; < > = ? @ [] ^ _ ` { } \ ~ | ■

7. Repeat steps 5 - 6 until the name is as desired.

8. When you have finished editing the name, press the [EXIT] key.

The new name is accepted and the unit returns to the condition of step 3. If necessary, you can edit the names of other V-takes.

9. To return to the main screen, press the [EXIT] key.

The [TRACK PARAMETER] key goes out.

HINT

If the data on a V-take are erased, the name of the V-take reverts to "NO DATA".

Moving to a desired point in the song (Locate function)

You can specify a location within the song in time units (minutes/seconds/milliseconds) or in measure units (measure/beat/tick) units, and move to that location.

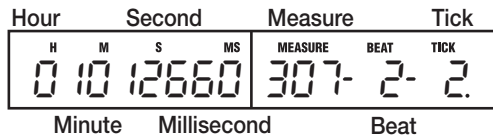

1. With the recorder stopped, use the cursor left/right keys from the main screen to move the flashing part to the unit you want to change.

For example, to change the minutes, cause the segment marked “M” to flash.



2. Turn the dial to specify the numeric value.

On the time indication, minutes, seconds, or milliseconds can be specified. On the measure indication, measures, beats, or ticks can be specified. When you change the displayed value, the unit immediately moves to the new location. Pressing the PLAY [▶] key starts playback from that point.

Re-recording only a specified region (Punch-in/out function)

Punch-in/out is a function that lets you re-record just a specified region of a previously recorded track. The action of switching a currently-playing track to record mode is called “punch-in”, and the action of switching back from recording to playback is called “punch-out”.

The MRS-802 provides two ways to do this. You can use the panel keys or a foot switch (sold separately) to punch-in/out manually (“manual punch-in/out”), or you can cause punch-in/out to occur automatically at previously specified points (“auto punch-in/out”).

Using manual punch-in/out

This section describes how to perform manual punch-in/out to re-record a region of a previously recorded track, using the panel keys or a foot switch (sold separately).

HINT

If you want to use a foot switch for punch-in/out, connect the ZOOM foot switch FS01 (option) to the [CONTROL IN] jack on the front panel.

NOTE

In the default condition of the MRS-802, a foot switch connected to the [CONTROL IN] jack is set to control recorder playback/stop. If you want to use the foot switch for punch-in/out, you must first change the foot switch setting (→ p. 135).

1. Repeatedly press the status key of the track on which you want to perform punch-in/out, until the key is lit in red.
2. Raise the fader of this track to a suitable position.
3. While playing the instrument connected to the input jack, use the [INPUT] control and [REC LEVEL] control to adjust the recording level.

As necessary, play back the recorder and use the faders of the mixer section to adjust the mix balance of your instrument and the playback of the tracks.

4. Locate a point several measures before the intended punch-in point, and press the PLAY [▶]

key to begin recorder playback.

5. When you come to the punch-in point, press the REC [●] key (or press the foot switch).

The REC [●] key lights up, and track recording begins from that location.

6. When you come to the intended punch-out point, press the REC [●] key (or the foot switch) once again.

The REC [●] key goes out, and the unit switches from recording to playback.

7. To stop playback, press the STOP [■] key.

8. To check the newly recorded content, locate to a point slightly before the punch-in point, and press the PLAY [▶] key.

Using auto punch-in/out

Auto punch-in/out is a function that lets you specify beforehand the region to be re-recorded. Punch-in will occur automatically when you reach the starting location (In point), and punch-out will occur automatically when you reach the ending location (Out point). This is convenient for example when you cannot operate the MRS-802 because you are playing the instrument yourself, or when very fast playback/record switching is required.



In order to perform auto punch-in/out, you must first specify the In point (switch point from playback to recording) and Out point (switch point from recording to playback), and then perform the recording operation. The procedure is as follows.

1. Raise the fader of the track where you want to perform auto punch-in/out to a suitable position.
2. While playing the instrument connected to the input jack, use the [INPUT] control and [REC LEVEL] control to adjust the recording level.

3. Locate the point at which you want to punch-in, and press the [AUTO PUNCH-IN/OUT] key.

The [AUTO PUNCH-IN/OUT] key flashes. This sets the “In point” at which recording will begin.

4. Locate the point at which you want to punch-out, and press the [AUTO PUNCH-IN/OUT] button once more.

This sets the “Out point” at which recording will end. The [AUTO PUNCH-IN/OUT] button will change from flashing to solidly lit. This indicates that the auto punch-in/out function is now enabled.

HINT

If you want to specify the in/out points precisely, it is convenient to use the scrub function (→ p. 44) to find the locations and assign a mark (→ p. 42) beforehand at the desired locations.

5. Use the Locate function to go to a spot slightly before the In point.

6. Repeatedly press the status key for the track on which you want to perform punch-in/out, until the key flashes red.

NOTE

A status key that is lit red means that the current location is between the In point and Out point. In this case, operate the transport once again to locate to a point that is earlier than the In point.

7. If you want to rehearse the auto punch-in/out, press the PLAY [▶] key.

The recorder will begin playing. When you reach the In point, the track on which you are punching-in/out will be muted. When you reach the Out point, muting will be defeated. (You will always be able to monitor the input signal during this time.) Performing this action will not delete or record anything on the track.

When you are finished rehearsing, move again to a location earlier than the In point. If necessary, adjust the In/Out points.

8. To actually perform auto punch-in/out, hold down the REC [●] key and press the PLAY [▶] key.

The recorder operates in playback mode. When you reach

the In point, recording will begin automatically (punch-in). When you reach the Out point, recording will end automatically, and playback will resume (punch-out).

9. When you are finished recording, press the STOP [■] key.

10. To listen to the recorded result, press the status key for the track on which you have performed punch-in/out so that the key is lit in green. Then move to a location earlier than the In point, and press the PLAY [▶] key.

If you want to re-do the recording, repeat steps 5 - 9.

11. When you are satisfied with the recording, press the [AUTO PUNCH-IN/OUT] key so that the key goes out.

The auto punch-in/out function is turned off, and the In point and Out point settings are discarded.

Recording several tracks on a master track (Mixdown function)

This section explains how to play recorded tracks and drum kit sounds and record them as a stereo mix on a master track (mixdown).

About the master track

The master track is a set of stereo tracks that is separate from the normal tracks 1 - 8. The most common use of the master track is as a track on which the end result of a mixdown process is recorded. The contents of the master track can be used to create the material for an audio CD.

The MRS-802 offers one master track for each project. Similar to the regular tracks 1 - 8, the master track also has ten virtual tracks (V-takes). This allows you to record different mixes on several V-takes and select the optimum take later.

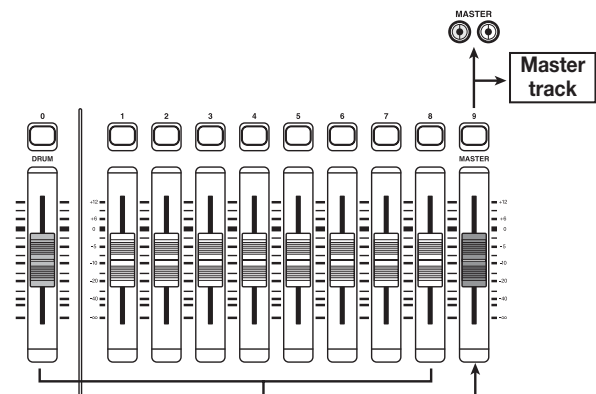

When you set the master track to recording, the signal coming from the [MASTER] fader (same signal as supplied at the OUTPUT jacks) will be recorded.

Mixdown steps

Here's how to mix tracks 1 - 8 and the drum track onto two stereo channels and record these on the master track.

1. From the main screen, press the [TRACK PARAMETER] key in the track parameter section.

- Use the cursor up/down keys to bring the indication "TR XX-XX" onto the display (where X is the track number and V-take number).

```
TR 2- 1
GTR 2- 1
```

- Press the [MASTER] status key to select the master track.

The number and name of the V-take currently selected for the master track appear on the display. (If nothing is recorded on the V-take, the indication shows "NO DATA".)

```
TR M- 1
NO DATA
```

HINT

Instead of pressing the [MASTER] status key, you can also use the cursor left/right keys to select the master track.

- If you want to change the V-take, turn the dial.

- When the V-take has been selected, press the [EXIT] key.

The [TRACK PARAMETER] key goes out, and the unit returns to the main screen.

- From the main screen, press the [MASTER] status key several times, until the key is lit in red.

The master track is now ready for recording.

While the key is lit in red, the other tracks as well as the drum track and effects operate normally.

HINT

The signal recorded on the master track is the signal coming from the [MASTER] fader. This is the same signal that is supplied at the OUTPUT jacks.

- Set the recorder to playback and adjust the mixing balance of the various tracks.

The individual track level settings as well as the insert effect and send/return effect settings all have an influence on the signal that is sent to the master track. Adjust levels while watching the L/R level meter, and make sure that no signal clipping occurs.

- To carry out the mixdown operation, press the ZERO [◀◀] key to return to the beginning of the song, and then press the PLAY [▶] key while holding down the REC [●] key.

Recording on the master track starts.

- When recording is complete, press the STOP [■] key.

Playing the master track

To play the recorded master track, proceed as follows.

- From the main screen, press the [MASTER] status key several times, until the key is lit in green.

The unit goes into master track playback mode. In this mode, all other status keys are out, all other tracks are muted, and all effects are switched off.

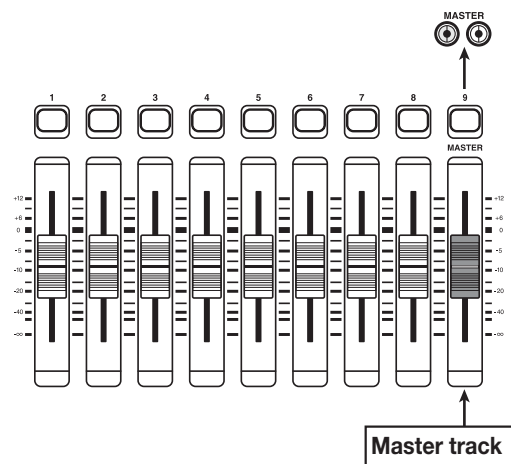

HINT

While the [MASTER] status key is lit in green, the transport keys except for the REC [●] key operate normally.

- Press the ZERO [◀◀] key to return to the beginning of the song, and then press the PLAY [▶] key.

Playback of the master track starts from the beginning. You can use the [MASTER] fader to adjust the playback volume.

3. To stop playback, press the STOP [■] key.
4. To cancel the master track playback mode, press the [MASTER] status key so that the key goes out.

Muting of tracks 1 - 8 and the rhythm section is canceled, and the unit returns to normal operation. Status keys that were automatically turned off are returned to the previous condition.

Combining multiple tracks on another track (Bounce function)

How bounce works

“Bounce” is a function that mixes the performances of the recorder section and the drum track, and records them on one or two tracks. (This is sometimes called “ping-pong recording”.)

For example, you might bounce the contents of tracks 1 - 6 onto tracks 7/8 and then switch the V-takes of tracks 1 - 6 to record new versions of your performance.

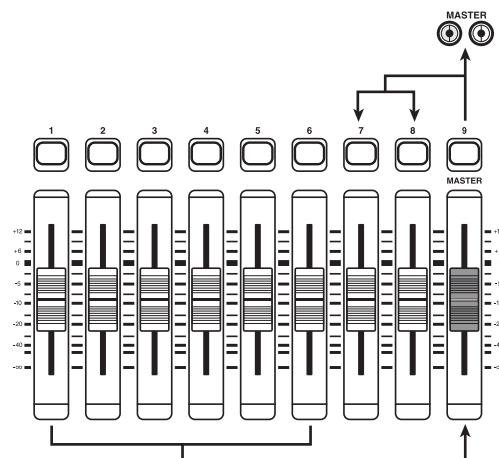

HINT

- You can also mix the signals from the INPUT jacks into the bounce recording.
- If you select only one mono track as the bounce destination, the signal mixed to mono will be recorded.
- If necessary, you can play back all eight tracks, and bounce onto empty V-takes.

Making bounce settings

Before using the bounce function, you may have to make certain settings.

■ Specifying playback/mute for the recording track(s)

In the default condition of the MRS-802, the bounce destination recording track(s) will be muted. If you want to play back a track while you bounce-record on another V-take of that track, use the following procedure to change the

internal setting so that the recording track(s) will also play back.

1. From the main screen, press the [UTILITY] key.

The indication “UTILITY TR EDIT” appears on the display.

2. Use the cursor left/right keys to bring up the indication “UTILITY BOUNCE” on the display, and press the [ENTER] key.

3. Use the cursor left/right keys to bring up the indication “BOUNCE RECTRACK” on the display, and press the [ENTER] key.



- **MUTE**

The recording track(s) will be muted (default setting).

- **PLAY**

The recording track(s) will play back.

4. Turn the dial to change the setting to “PLAY”.

5. To return to the main screen, press the [EXIT] key several times.

■ Selecting the recording destination V-take

In the default condition of the MRS-802, the result of the Bounce operation will be recorded on the V-take that is currently selected for the recording track(s).

If you want to play back a track while bouncing onto another V-take of that track, you can use the following procedure to change the recording destination V-take. (For information on V-takes, refer to page 33.)

1. From the main screen, press the [UTILITY] key.

The indication “UTILITY TR EDIT” appears on the display.

2. Use the cursor left/right keys to bring up the indication “UTILITY BOUNCE” on the display, and press the [ENTER] key.

3. Use the cursor left/right keys to bring up the

indication “BOUNCE REC TAKE” on the display, and press the [ENTER] key.

The V-take currently selected for recording is shown.



- **CURRENT**

The bounce result will be recorded on the V-take currently selected for the recording track.

- **1 - 10**

The bounce result will be recorded on the V-take of the number you specify here.

4. Turn the dial to specify the recording destination V-take.

5. To return to the main screen, press the [EXIT] key several times.

Executing bounce recording

In this example, we will bounce the contents of tracks 1 - 6 onto V-take 10 of tracks 7/8.

1. Go to the UTILITY screen and verify that the BOUNCE RECTRACK parameter is set to “PLAY” .

2. Also on the UTILITY screen, verify that the REC TAKE parameter is set to “10” (V-take 10).

3. Press the status key 7 so that the keys is lit in red, and keep pressing the key.

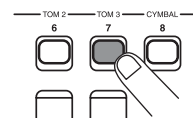

4. While still holding down status key 7, repeatedly press status key 8 until both keys are lit in red.

The V-takes 10 of tracks 7/8 are now ready for stereo recording.

To monitor the two bounce target tracks in stereo, set the pan parameter for track 7 to L100 and the pan parameter for track 8 to R100.

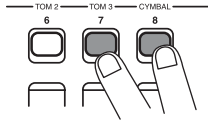

HINT

You can also preset the two tracks to function as a linked stereo track (→ p. 73).

5. Press the [BOUNCE] key.

The [BOUNCE] key lights up and the Bounce function is turned on. Other tracks and effects function normally.

6. Set the recorder to playback and adjust the mixing balance of the various tracks.

The individual track level settings as well as the insert effect and send/return effect settings all have an influence on the mixed signal. Adjust levels while watching the L/R level meter, and make sure that no signal clipping occurs.

7. Press the ZERO [◀◀] key to return to the beginning of the song, and then press the PLAY [▶] key while holding down the REC [●] key.

Recording on tracks 7/8 starts.

8. When recording is complete, press the STOP [■] key.

Recording the drum sound (Rhythm recording)

The MRS-802 allows you to record the drum kit sound onto any track. This function is called “rhythm recording”. To use the function, proceed as follows.

1. From the main screen, press the [UTILITY] key in the display section.

The utility menu appears on the display.

```
UTILITY
TR EDIT
```

2. Use the cursor left/right keys to bring up the indication “UTILITY BOUNCE” on the display, and press the [ENTER] key.

3. Use the cursor left/right keys to bring up the indication “BOUNCE REC SRC” on the display, and press the [ENTER] key.

The display changes as follows.

```
REC SRC
MASTER
```

From this screen, you can select the recording source signal.

- **MASTER**

Signal immediately after [MASTER] fader

- **DRUM TR**

Drum track signal

4. Turn the dial to select “DRUM TR”.

The drum track is selected as recording source.

5. Repeatedly press the [EXIT] key to return to the main screen.

6. Press the [BOUNCE] key.

7. From the main screen, repeatedly press the status key of the track to be used as recording destination, until the key is lit in red.

The selected track is ready for recording. Up to two status

keys can be selected. The other tracks function normally.

HINT

To record drum sounds in stereo, select two tracks as recording destination. If only one track is selected, the recording will be in mono.

- Verify that the [DRUM] key in the rhythm section is out, and that rhythm song or rhythm pattern that you want to record is selected.

HINT

By selecting an empty rhythm pattern, it is also possible to record drum sounds generated by playing an external MIDI keyboard or other device.

- Set the recorder to playback and adjust the recording level.

Adjust levels while watching the L/R level meter, and make sure that no signal clipping occurs.

- Press the ZERO [◀◀] key to return to the beginning of the song, and then press the PLAY [▶] key while holding down the REC [●] key.

Playback of the rhythm pattern/rhythm song starts and is recorded on the selected tracks.

- When recording is complete, press the STOP [■] key.

Rhythm recording ends. If you want to return to normal recording, select “MASTER” on the screen of step 3.

Assigning marks within a song (Marker function)

You can assign up to 100 marks in a song at any desired location, and jump to a mark by pressing a key or by specifying the desired mark number. This is convenient when you want to repeatedly locate a specific point for playback during recording or mixdown.

Setting a mark

Here's how to assign a mark at the desired location in a song.

- Locate the point at which you want to assign a mark.

HINT

- A mark can be assigned either during playback or when stopped.
- You can also use the scrub function to locate the position with high precision.

- Press the [MARK] key in the control section.

A mark will be assigned to the current location. When a mark has been assigned, the new mark number (01 - 99) will appear in the MARKER area in the upper right of the display.



The mark number is assigned automatically in ascending order from the beginning of the song. If you add a new mark between two existing marks, the subsequent marks will be renumbered.

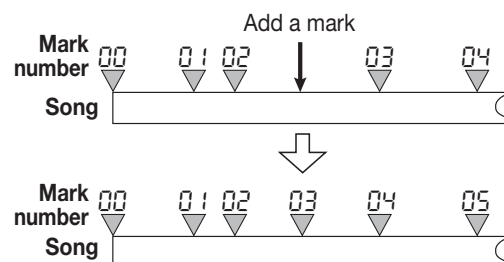

HINT

Mark number 00 is already set at the beginning of the song (the counter zero location).

In the main screen, the MARKER area in the upper right of the display will show the number of the mark immediately before the current location. If a dot is shown at the lower right of the mark number, this means that the mark location matches the current location.



Locating a mark

Here's how to move to the location of a mark. This can be done in two ways: you can use key operations, or specify the mark number directly.

■ Using keys to locate

1. From the main screen, press either the **MARKER** [◀◀] or [▶▶] key in the control section.

Each time you press the key, the unit jumps to the next mark before or after the current location.

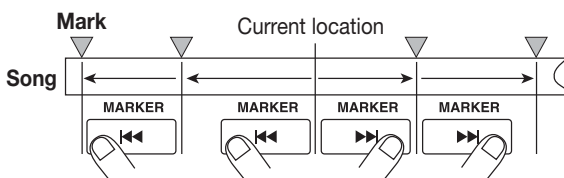

■ Specifying the mark number to locate

1. From the main screen, press the cursor left key once.

The indication "MARKER" flashes on the display.

2. Turn the dial to select the desired mark number.

As soon as the number is changed, the unit jumps to that number.

Deleting a mark

Here's how to delete a mark that you assigned.

1. **Locate the mark that you want to delete.**

The mark number displayed in the MARKER area is the mark that will be deleted.

It is not possible to delete a mark unless the mark location exactly matches the current location. If the dot at the lower right of the mark number is not lit, use the MARKER [◀◀] / [▶▶] keys to jump to the exact marker point.

2. Press the **[CLEAR]** key in the control section.

The selected mark will be deleted, and subsequent marks will be renumbered.

NOTE

- A deleted mark cannot be recovered.
- It is not possible to delete mark number "00" located at the beginning of the song.

Playing back the same passage repeatedly (A-B Repeat function)

A-B Repeat is a function that repeatedly plays back a desired region of the song. This is useful when you want to listen to the same passage repeatedly.

1. Move to the point at which you want to begin repeat playback, and press the [A-B REPEAT] key in the control section.

The [A-B REPEAT] key flashes, and the repeat start location (point A) is specified.

HINT

The A/B point can be specified either during playback or when stopped.

2. Move to the point at which you want to end repeat playback, and press the [A-B REPEAT] key once more.

The [A-B REPEAT] key will change from flashing to constantly lit, and the repeat end location (point B) will be specified.

NOTE

If you specify a point B that is located earlier than point A, the region from points B → A will be played repeatedly.

3. If you wish to redo the A/B point setting, press the [A-B REPEAT] key so that it goes out, and then repeat the procedure from step 1.

4. To begin repeat playback, press the PLAY [▶] key.

Repeat playback will begin when you press the PLAY [▶] key while the [A-B REPEAT] key is lit. When the end point (normally point B) is reached, the recorder jumps to the start point (normally point A), and playback continues.

5. To stop repeat playback, press the STOP [■] key.

Even after pressing the STOP [■] key to stop playback, you can perform repeat playback again as many times as desired, as long as the [A-B REPEAT] key is lit.

6. To turn off repeat playback, press the [A-B REPEAT] key.

The [A-B REPEAT] key goes out, and repeat playback will be turned off. The A/B point locations also will be erased.

Finding a desired location (Scrub/Preview function)

The MRS-802 provides a “Scrub” function that lets you search for a desired location while repeatedly playing a short region before or after the current point. This is convenient when you want to accurately find the point at which a specific sound starts or stops.

When the scrub function is on, you can use the “Preview function” that plays 0.7 seconds before and after the current point. By using the scrub and preview functions together, you can find the desired location quickly and accurately.

Using the scrub/preview functions

1. From the main screen, hold down the STOP [■] key and press the PLAY [▶] key.

This turns on the scrub function, and a short region (40 milliseconds by default) following the current location will play back repeatedly.

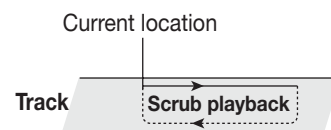

When the scrub function is on, the display changes as follows.

SCRUB				MARKER
FRM 40ms				04
H	M	S	MS	MEASURE
0	10	12660	207	1-8

2. Use the status keys 1 - 8 to select the track(s) for scrub playback.

Up to 2 tracks can be selected simultaneously.

3. Use the cursor left/right keys to cause the unit indication at the right edge of the counter (“MS” for time display, or “TICK” for measure display) to flash.

4. Turn the dial to the left or right to find the desired location.

During scrub playback, the current location can be moved

forward or backward in milliseconds or ticks.

- 5.** If you want to use the preview function to hear the region before the current location, press the REW [◀◀] key. To hear the region after the current location, press the FF [▶▶] key.

If you press the REW [◀◀] key, a region of 0.7 seconds prior to the current location will play (ending at the current location). If you press the FF [▶▶] key, a region of 0.7 seconds following the current location will play (beginning at the current location). This is called “preview playback”. When preview playback ends, scrub playback will resume.

- 6.** To cancel the scrub function, press the STOP [■] key.

The unit returns to the main screen.

Changing the settings of the scrub function

When the scrub function is on, you can change the direction of the scrub playback (whether it will play the region before or after the current location), and the length of the scrub playback region.

- 1.** From the main screen, hold down the STOP [■] key and press the PLAY [▶] key.

This turns the scrub function on, and the following screen will appear. The characters in the lower left (TO/FRM) indicate the direction of scrub playback, and the number in the lower right (40 - 200) is the length of scrub playback.

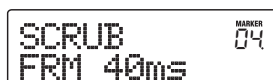

- 2.** If you want to change the length of scrub playback, use the cursor left/right keys to cause the scrub playback length setting to flash, and turn the dial.

You can select 40, 80, 120, 160, or 200 (ms) as the length of scrub playback.

HINT

You can also use the cursor up/down keys to change the scrub playback length.

- 3.** If you want to change the direction of scrub playback, use the cursor left/right keys to cause the scrub playback direction indication to flash, and turn the dial.

If you select “TO”, scrub playback will begin from an earlier point and end at the current location. If you select “FRM”, scrub playback will begin from the current location (this is the default setting).

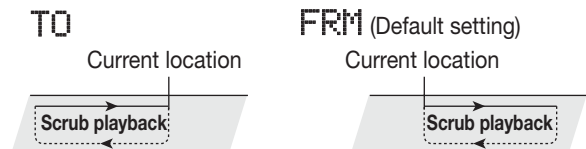

HINT

Any change you make to the scrub settings will take effect immediately.

- 4.** If you want to use the new scrub playback settings to find a location, use the cursor left/right keys to move the flashing area to the unit displayed at the right of the counter (“MS” for time display, or “TICK” for measure display).

- 5.** Turn the dial to the left or right to move the current location.

During scrub playback, the current location can be moved forward or backward in milliseconds or ticks.

- 6.** To exit the scrub function, press the STOP [■] key.

The unit returns to the main screen.

Reference [Track Editing]

This section explains how to edit audio data contained on the tracks of the recorder section. There are two major types of editing functions: specifying a range for editing, and editing an entire V-take.

Editing a range of data

The procedure for specifying a range of a V-take and then performing an action such as copying or moving is explained below.

Basic editing steps for range editing

When performing editing for a specified range of data, some steps are similar for each action. These are as follows.

- 1. From the main screen, press the [UTILITY] key in the display section.**

The utility menu appears on the display.



```
UTILITY
TR EDIT
```

- 2. Verify that the indication "UTILITY TR EDIT" is on the display, and press the [ENTER] key.**

The track edit menu containing various editing commands appears on the display.



```
TR EDIT
Copy
```

- 3. Use the cursor left/right keys to select the desired command.**

The following editing commands are available.

- **Copy**

Copy a specified range of audio data.

- **Move**

Move a specified range of audio data.

- **Erase**

Erase a specified range of audio data.

- **Trim**

Retain only a specified range of audio data and erase the rest.

- **Fade I/O (Fade-in/out)**

Perform fade-in/fade-out over a specified audio data interval.

- **Reverse**

Reverse a specified range of audio data.

- **TimStrch (Time Stretch/Compress)**

Change the duration of a specified range of audio data on a track without changing the pitch.

- 4. Press the [ENTER] key.**

The screen for selecting the track and V-take for editing appears.

The display shown below is an example for selecting the copy command in step 3.

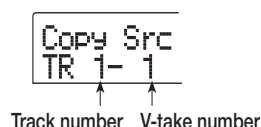

```
Copy Src
TR 1- 1
```

Track number V-take number

- 5. Turn the dial to select the track number (1 - 8), and use the cursor up/down keys to select the V-take number (1 - 10).**

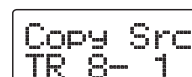

```
Copy Src
TR 8- 1
```

On this screen, also V-takes that are not currently selected for tracks 1 - 8 can be selected for editing.

When track 8 is selected, turning the dial further to the right brings up the following screen.

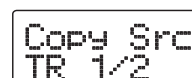

```
Copy Src
TR 1/2
```

When this screen is shown, turning the dial to the right selects tracks in odd-numbered/even-numbered pairs (1/2, 3/4, 5/6, 7/8) or the master track. In this case, the currently selected V-take for the two tracks or the master track becomes the editing target.

- 6. Press the [ENTER] key.**

The subsequent steps will differ, depending on which command was selected. See the sections for the respective commands.

7. When the editing command has been executed, repeatedly press the [EXIT] key to return to the main screen.

HINT

After performing an edit function and rewriting the audio data on a track, the original data cannot be restored. If you want to retain the condition before editing, use the capture function for that track (→ p. 55).

Copying a specified range of data

You can copy the audio data of a specified range to a specified position on a specified track. This action will overwrite the existing data at the destination location. The copy source data will be unchanged.

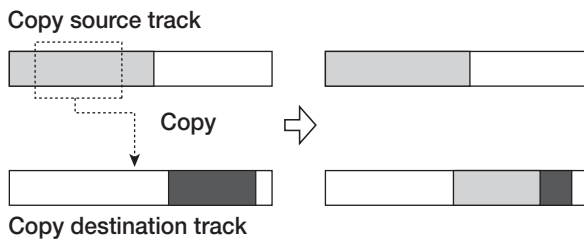

1. Refer to steps 1 - 6 of “Basic editing steps” to select the copy source track/V-take, and press the [ENTER] key.

The display changes as follows. This screen lets you specify the copy range start point.

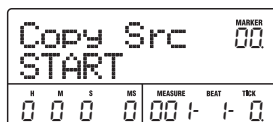

The edit range start point is shown on the left-hand counter in hours, minutes, seconds, milliseconds, and on the right-hand counter in measures, beats, and ticks.

2. Use the cursor left/right keys to move the flashing section of the counter, and turn the dial to specify the copy start point.

The point can be specified in hours/minutes/seconds/milliseconds. When a value is specified, the measure/beat/tick counter reflects the new location.

If you move the flashing section to the MARKER field on the display, you can specify a mark by turning the dial. In this case, the mark position becomes the editing start point. If you move to an area where no data are recorded, a “*” symbol is shown.

3. Press the [ENTER] key.

The display changes to “Copy Src END”. This screen lets you specify the copy range end point.

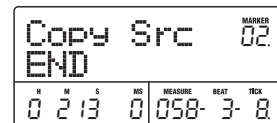

4. Use the same procedure as in step 2 to specify the copy range end point.

If you press the PLAY [▶] key at this point, the specified range will be played.

5. Press the [ENTER] key.

The display now shows “Copy Dst TR xx-yy” (where xx is the track number and yy the V-take number). This screen lets you specify the copy destination track/V-take.



NOTE

- If you have selected a single track as copy source, only a single track can be selected as copy destination.
- If you have selected two adjacent tracks or the master track as copy source, only two adjacent tracks or the master track can be selected as copy destination. In this case, the currently selected V-take for each track becomes the editing target.

6. Specify the copy destination track/V-take in the same way as when selecting the copy source track/V-take, and press the [ENTER] key.

The display changes as follows. This screen lets you specify the start point on the copy destination V-take.

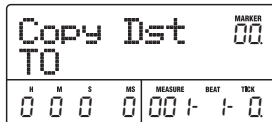

7. Specify the copy destination start point in the same way as for the copy source, and press the [ENTER] key.

The indication “Copy SURE?” appears on the display.

8. To execute the copy operation, press the [ENTER] key.

By pressing the [EXIT] key instead of the [ENTER] key, you can return to the previous screens. When the copy is executed, the indication “Copy COMPLETE” appears on the display, and the unit returns to the track edit menu.

HINT

To paste the same range repeatedly, use the phrase loop function (→ p. 57).

Moving a specified range of data

You can move the audio data of a specified range to a specified position on a specified track. This action will overwrite the existing data at the destination location. The move source data will be erased.

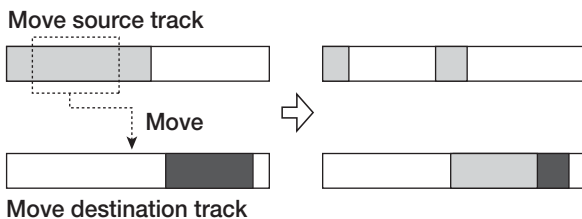

1. Refer to steps 1 - 6 of “Basic editing steps” to select the move source track/V-take, and press the [ENTER] key.

The display changes as follows. This screen lets you specify the move range start point.

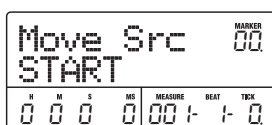

2. Use the cursor left/right keys to move the flashing section of the counter, and turn the dial to specify the move start point.

You can also specify the point as a mark.

3. Press the [ENTER] key.

The display changes to “Move Src END”.



4. Use the same procedure as in step 2 to specify the move range end point.

If you press the PLAY [▶] key at this point, the specified range will be played.

5. Press the [ENTER] key.

The display changes to let you specify the move destination track/V-take.

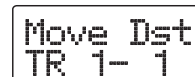

NOTE

- If you have selected a single track as move source, only a single track can be selected as move destination.
- If you have selected two adjacent tracks or the master track as move source, only two adjacent tracks or the master track can be selected as move destination. In this case, the currently selected V-take for each track becomes the editing target.

6. Specify the move destination track/V-take in the same way as when selecting the move source track/V-take, and press the [ENTER] key.

The display changes to the screen for specifying the move destination start point.



7. Specify the move destination start point in the same way as for the move source, and press the [ENTER] key.

The indication “Move SURE?” appears on the display.

8. To execute the move operation, press the [ENTER] key.

By using the [EXIT] key instead of the [ENTER] key, you can move back to previous screens.

When the move is executed, the indication “Move COMPLETE” appears on the display, and the unit returns to the track edit menu.

Erasing a specified range of data

You can erase the audio data of a specified range and return the range to the mute (non-recorded) condition.

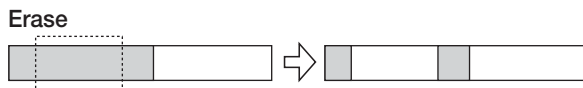

1. Refer to steps 1 - 6 of “Basic editing steps” to select the track/V-take for erasing, and press the [ENTER] key.

The display changes as follows. This screen lets you specify the erase range start point.

Ers Src			MARKER	00
START				
H	M	S	MS	MEASURE BEAT TRCK
0	0	0	0	001-1-0

2. Use the cursor left/right keys to move the flashing section of the counter, and turn the dial to specify the erase start point.

You can also specify the point as a mark.

3. Press the [ENTER] key.

The display changes to “Ers Src END”.

Ers Src			MARKER	00
END				
H	M	S	MS	MEASURE BEAT TRCK
0	132	0	0	042-1-24

4. Use the same procedure as in step 2 to specify the erase range end point.

If you press the PLAY [▶] key at this point, the specified range will be played.

5. Press the [ENTER] key.

The indication “Erase SURE?” appears on the display.

6. To execute the erase operation, press the [ENTER] key.

By using the [EXIT] key instead of the [ENTER] key, you can move back to previous screens.

When the erase is executed, the indication “Erase COMPLETE” appears on the display, and the unit returns to the track edit menu.

Trimming a specified range of data

You can erase the audio data of a specified range and adjust the data start/end point (trimming). For example, when preparing to burn the master track onto a CD-R/RW disc, you might want to remove unwanted portions at the start and the end of the V-take that will be used.

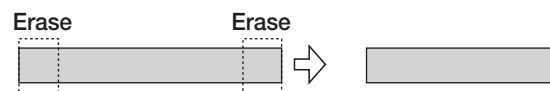

NOTE

When data before a specified section are erased (trimmed), the remaining audio data will move up by that amount. Therefore the timing may become mismatched with regard to other tracks/V-takes.

1. Refer to steps 1 - 6 of “Basic editing steps” to select the track/V-take for trimming, and press the [ENTER] key.

The display changes as follows. This screen lets you specify the start point for the range to be preserved after trimming (all data before this point will be erased).

Trim Src			MARKER	00
START				
H	M	S	MS	MEASURE BEAT TRCK
0	0	0	0	001-1-0

2. Use the cursor left/right keys to move the flashing section of the counter, and turn the dial to specify the range start point.

You can also specify the point as a mark.

3. Press the [ENTER] key.

The display changes to “Trm Src END”.



- Use the same procedure as in step 2 to specify the range end point.

All data after this point will be erased.

If you press the PLAY [▶] key, the specified range will be played.

- Press the [ENTER] key.

The indication “Trim SURE?” appears on the display.

- To execute the trimming operation, press the [ENTER] key.

By using the [EXIT] key instead of the [ENTER] key, you can move back to previous screens.

When the trimming operation is executed, the indication “Trim COMPLETE” appears on the display, and the unit returns to the track edit menu.

Fade-in/fade-out of specified data range

You can fade in or fade out the audio data over a specified range.

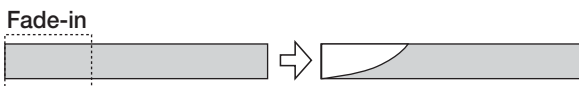

NOTE

The fade-in/out command does not simply alter the track volume. Rather, it rewrites the waveform data and is therefore not reversible once executed. If you want to retain the condition before editing, use the capture function for that track (→ p. 55).

- Refer to steps 1 - 6 of “Basic editing steps” to select the track/V-take for fade-in or fade-out, and press the [ENTER] key.

The display changes as follows. This screen lets you specify the start point for fade-in or fade-out.

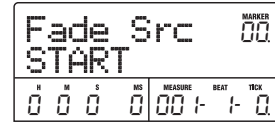

- Use the cursor left/right keys to move the flashing section of the counter, and turn the dial to specify the fade-in or fade-out start point.

You can also specify the point as a mark.

- Press the [ENTER] key.

The display changes to “Fade Src END”.



- Use the same procedure as in step 2 to specify the fade-in or fade-out end point.

If you press the PLAY [▶] key, the specified range of the specified V-take will be played.

- Press the [ENTER] key.

The display changes as follows.



- Turn the dial to select the fade-in or fade-out curve.

Curves I-1 to I-3 are for fade-in, and curves O-1 to O-3 are for fade-out. The three different kinds of curves look as follows.

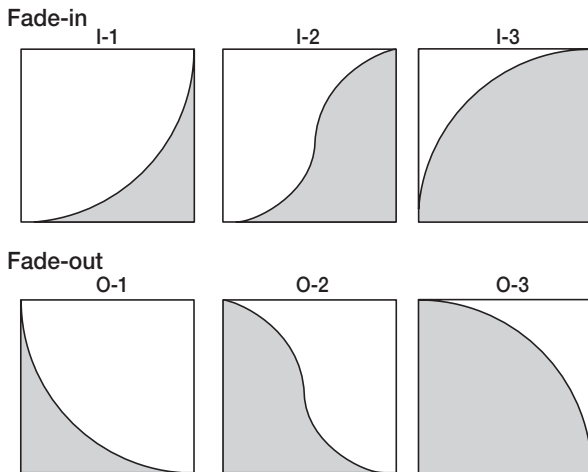

7. Press the [ENTER] key.

The indication “Fade I/O SURE?” appears on the display.

8. To execute the fade-in/fade-out operation, press the [ENTER] key.

By using the [EXIT] key instead of the [ENTER] key, you can move back to previous screens.

When the fade-in/fade-out operation is executed, the indication “Fade I/O COMPLETE” appears on the display, and the unit returns to the track edit menu.

Reversing a specified range of audio data

You can reverse the order of a specified range of audio data.

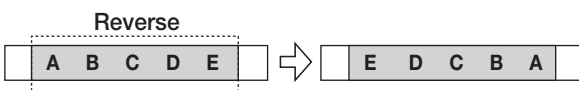

1. Refer to steps 1 - 6 of “Basic editing steps” to select the track/V-take for reversing, and press the [ENTER] key.

The display changes as follows. This screen lets you specify the start point for reversing.

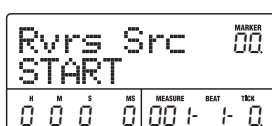

2. Use the cursor left/right keys to move the flashing section of the counter, and turn the dial to specify the reversing start point.

You can also specify the point as a mark.

3. Press the [ENTER] key.

The display changes to “Rvrs Src END”.



4. Use the same procedure as in step 2 to specify the reversing end point.

If you press the PLAY [▶] key, the specified range of the specified V-take will be played.

5. Press the [ENTER] key.

The indication “Reverse SURE?” appears on the display.

6. To execute the reversing operation, press the [ENTER] key.

By using the [EXIT] key instead of the [ENTER] key, you can move back to previous screens.

When the reversing operation is executed, the indication “Reverse COMPLETE” appears on the display, and the unit returns to the track edit menu.

Changing the duration of a specified data range

You can change the duration of a specified range of audio data on a track without changing the pitch (time stretch/compress). The stretched or compressed data can be written over the old data on the same track or pasted on another track while leaving the source data unchanged.

Time stretch/compress



1. Refer to steps 1 - 6 of “Basic editing steps” to select the track/V-take for time stretch/compress, and press the [ENTER] key.

The display changes to a screen for selecting a track/V-take on which to place the audio data after time stretch/compress. The indication is “TmStrDst TR-xx-yy” (where xx is the track number and yy the V-take number).

TmStrDst
TR 1- 1

- Use the cursor up/down keys and the dial to select the destination track/V-take, and press the [ENTER] key.

The display changes as follows.

TimStrch
100.00% 120.0

↑ ↑
Stretch ratio Tempo

This screen lets you specify the ratio for time stretch/compress in two ways, as listed below (the current selection flashes).

- Stretch ratio (%)**

Expresses the length of the track after time stretch/compress in percentage of the original. The setting range is 50% - 150%.

- Tempo (BPM)**

Sets the tempo (beats per minute) after time stretch/compress, using the tempo set in the rhythm song as reference. The default value is the tempo set at the beginning of the current rhythm song.

- Use the cursor left/right keys to select the unit for making the time stretch/compress setting.

The flashing section moves.

- Turn the dial to make the time stretch/compress setting.

When you change one item, the other item also changes accordingly.

Also when using the BPM item for making the setting, the setting range of 50% - 150% cannot be exceeded.

- Press the PLAY [▶] key.

The stretched/compressed track is played from the

beginning of the V-take.

- At the point where you want the time stretch/compress function to end, press the STOP [■] key.

The indication “TimStrch SURE?” appears on the display.

- To execute the time stretch/compress operation, press the [ENTER] key.

By using the [EXIT] key instead of the [ENTER] key, you can move back to previous screens.

When the time stretch/compress operation is executed, the indication “TimStrch COMPLETE” appears on the display, and the unit returns to the track edit menu.

NOTE

When performing time stretch/compress, the range is always from the start of the V-take to the point where the STOP [■] key was pressed.

HINT

When wishing to apply time stretch/compress only to a part of the song such as a drum pattern or riff, use the copy function and trimming function to create a V-take of the desired length first.

Editing using V-takes

Recorded audio data can also be edited in V-take units. You can for example exchange the data on two V-takes, or delete a V-take that is no longer needed.

Basic V-take editing steps

When editing audio data in V-take units, some steps are similar for each action. These are as follows.

1. From the main screen, press the [TRACK PARAMETER] key in the track parameter section.
2. Use the cursor up/down keys to bring up the following indication on the display.

In this condition, you can switch V-takes.

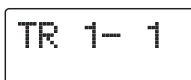

While this screen is shown, the level meter's dot flashing/lit/out status indicates the V-take selection and the presence or absence of audio data.

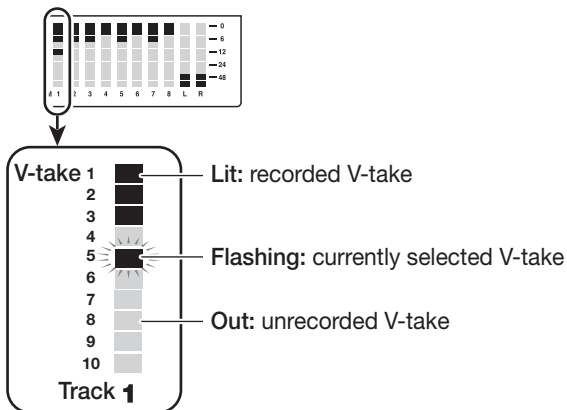

3. Use the cursor left/right keys and the dial to select a track and V-take.

The status key for the currently selected track is lit in orange. You can also press a status key to select a track.

It is also possible to select the master track. In this case, the indication shows "M- 1" and the [MASTER] status key is lit.

4. Press the [UTILITY] key in the display section.

A menu for editing audio data in track units appears on the display.



5. Repeatedly press the [UTILITY] key to call up the desired command.

The following editing commands are available.

- **ERASE**

Erase the audio data on a specified track/V-take.

- **COPY**

Copy the audio data of a specified track/V-take to another track/V-take.

- **MOVE**

Move the audio data of a specified track/V-take to another track/V-take.

- **EXCHG (Exchange)**

Exchange the audio data of a specified track/V-take with the data of another track/V-take.

HINT

If necessary, you can also change your selection of track and V-take from this screen.

6. Press the [ENTER] key.

The subsequent steps will differ, depending on which command was selected. See the sections for the respective commands.

7. When the editing command has been executed, repeatedly press the [EXIT] key to return to the main screen.

Erasing a V-take

You can erase the audio data on a specified V-take. The V-take is returned to the non-recorded condition.



1. Refer to steps 1 - 5 of “Basic V-take editing steps” to select the track/V-take to erase and to bring up the indication “ERASE” on the display. Then press the [ENTER] key.

The indication “ERASE SURE?” appears on the display.

2. To execute the erase operation, press the [ENTER] key once more. To cancel the operation, press the [EXIT] key.

After the erase operation is completed, the unit returns to the V-take editing menu.

Copying a V-take

You can copy the audio data of a specified V-take to any other V-take. This action will overwrite any existing data on the destination V-take. The data on the copy source V-take will be unchanged.

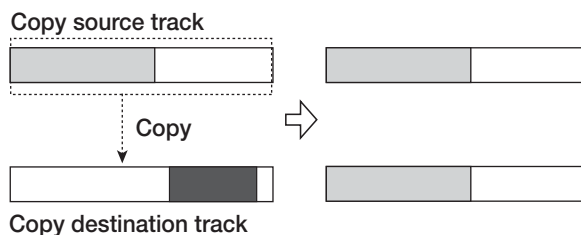

1. Refer to steps 1 - 5 of “Basic V-take editing steps” to select the track/V-take to copy and to bring up the indication “COPY” on the display. Then press the [ENTER] key.

A screen for selecting the copy destination appears on the display.

```
COPY TO
TR 4- 1
```

2. Use the cursor left/right keys and the dial to select the destination V-take, and press the [ENTER] key.

The indication “COPY SURE?” appears on the display.

3. To execute the copy operation, press the [ENTER] key once more. To cancel the operation, press the [EXIT] key.

After the copy operation is completed, the unit returns to the V-take editing menu.

Moving a V-take

You can move the audio data of a specified V-take to any other V-take. This action will overwrite any existing data on the destination V-take. The data on the move source V-take will be erased.

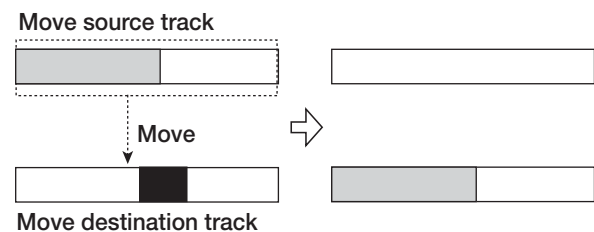

1. Refer to steps 1 - 5 of “Basic V-take editing steps” to select the track/V-take to move and to bring up the indication “MOVE” on the display. Then press the [ENTER] key.

A screen for selecting the move destination appears on the display.

```
MOVE TO
TR 1- 1
```

2. Use the cursor left/right keys and the dial to select the destination V-take, and press the [ENTER] key.

The indication “MOVE SURE?” appears on the display.

3. To execute the move operation, press the [ENTER] key once more. To cancel the operation, press the [EXIT] key.

After the move operation is completed, the unit returns to the V-take editing menu.

Exchanging V-takes

You can exchange the audio data of two specified V-takes.

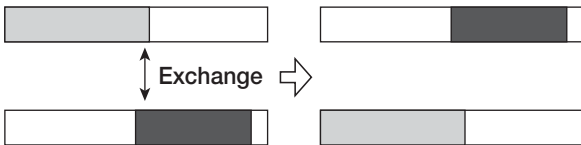

1. Refer to steps 1 - 5 of “Basic V-take editing steps” to select the exchange source track/V-take and to bring up the indication “EXCHG” on the display. Then press the [ENTER] key.

A screen for selecting the exchange destination appears on the display.

```
EXCHG TO
TR 1- 1
```

2. Use the cursor left/right keys and the dial to select the exchange destination V-take, and press the [ENTER] key.

The indication “EXCHG SURE?” appears on the display.

3. To execute the exchange operation, press the [ENTER] key once more. To cancel the operation, press the [EXIT] key.

After the exchange operation is completed, the unit returns to the V-take editing menu.

Track capture and swap

You can capture the audio data of any track and temporarily store them on the hard disk. Later you can swap the captured data with the current data of the track. This lets you for example save the state of a track before an editing operation. If the result of the operation is not as desired, you can then easily restore the track to its previous state.

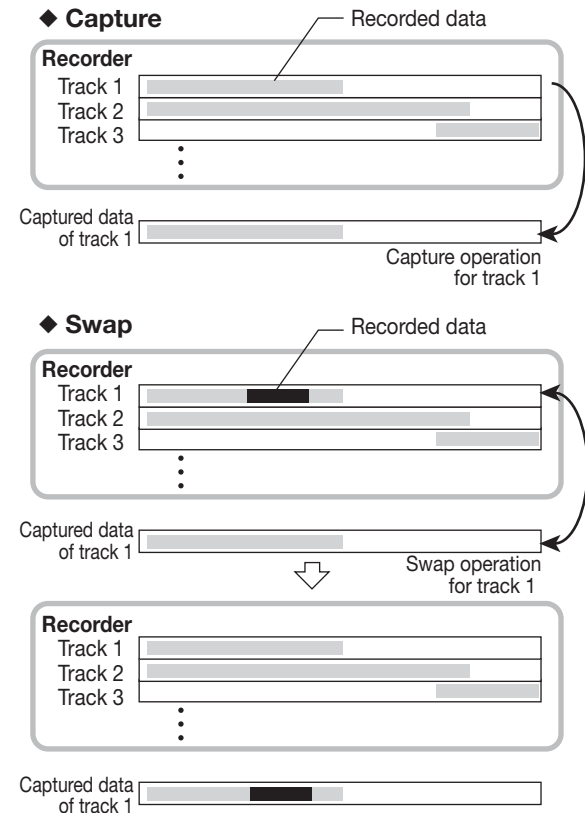

NOTE

Captured track data will be erased from the hard disk when the currently selected project is saved.

Capturing a track

You can capture the audio data of any specified track.

1. From the main screen, press the [UTILITY] key in the display section.

The indication “UTILITY TR EDIT” appears on the display.

2. Use the cursor left/right keys to bring up the indication “UTILITY CAP/SWAP” on the display, and press the [ENTER] key.

3. Use the status keys or the dial to select a track for capture.

The status key for the currently selected track is lit in orange.

It is also possible to select the master track. In this case, the indication shows “MASTER” and the [MASTER] status key is lit.

```
CAUTURE
TR1
```

NOTE

An unrecorded track cannot be captured.

4. Press the [ENTER] key.

The indication “CAPTURE SURE?” appears on the display.

5. To carry out the capture operation, press the [ENTER] key once more.

When capture is executed, the indication “SWAP TRxx” (where xx is the track number) appears on the display. In this condition, swapping with the displayed track is possible.

6. To return to the main screen, press the [EXIT] key.

HINT

By repeating steps 3 - 5, you can capture multiple tracks.

Swapping track data and captured data

You can swap the current data of a track with the captured data.

1. From the main screen, press the [UTILITY] key in the display section.

The indication “UTILITY TR EDIT” appears on the display.

2. Use the cursor left/right keys to bring up the indication “UTILITY CAP/SWAP” on the display, and press the [ENTER] key.

3. Use the status keys or the dial to select a track that was previously captured.

When you select a captured track, the indication “SWAP” appears on the display.

```
SWAP
TR1
```

HINT

If you select a track that was not captured, the indication “CAPTURE” appears.

4. Press the [ENTER] key.

The indication “SWAP SURE?” appears on the display.

5. To carry out the swap operation, press the [ENTER] key once more.

The audio data of the selected track are swapped with the previously captured audio data.

HINT

By performing the swap operation once more, you can return the track contents to the previous condition.

6. To return to the main screen, press the [EXIT] key.

Reference [Phrase Looping]

The MRS-802 lets you handle part of a recorded track or an audio file on CD-ROM as a phrase that can be loaded and played freely, in a preprogrammed sequence or for a specified number of times. The result can be written to any track/V-take. This function is called “phrase looping”. For example, you could use a commercially available sampling CD to pick up drum loops in any desired order, and use these to create a rhythm track.

This section describes the steps for phrase looping.

Which kind of phrases can be used?

The MRS-802 can manage up to 100 phrases in one project. The phrases are stored on the hard disk in an area called the “phrase pool”. The following kinds of data can be used as a phrase.

(1) Any track/V-take in the currently loaded project

You can select any track/V-take in the currently loaded project and specify a range to be used as a phrase.

(2) Audio file on CD-ROM/R/RW

You can load a stereo or mono audio file (8bit/16bit AIFF or WAV file with sampling frequency 8 - 48 kHz) from a CD-ROM/R/RW disc inserted in the CD-R/RW drive and use it as a phrase.

NOTE

- After loading, all audio files are played with a sampling frequency of 44.1 kHz. If necessary, files with other sampling frequencies can be converted (resampled) to 44.1 kHz.

- Files not corresponding to the ISO 9660 Level 2 standard will not be recognized.
- Files written to the disc in an open session will not be recognized.

(3) Phrase from another project

You can load any phrase from a project stored on the internal hard disk of the MRS-802. In this case, specifying a range is not possible.

HINT

It is not possible to directly load an audio track from an audio CD as a phrase into the phrase pool. You must first read it into a track (→ p. 119).

Once you have loaded phrases into the phrase pool, you can specify various parameters such as playback range and volume level, and then you can specify a playback sequence and number of times each phrase is played. The result can then be written to any track/V-take as a phrase loop.

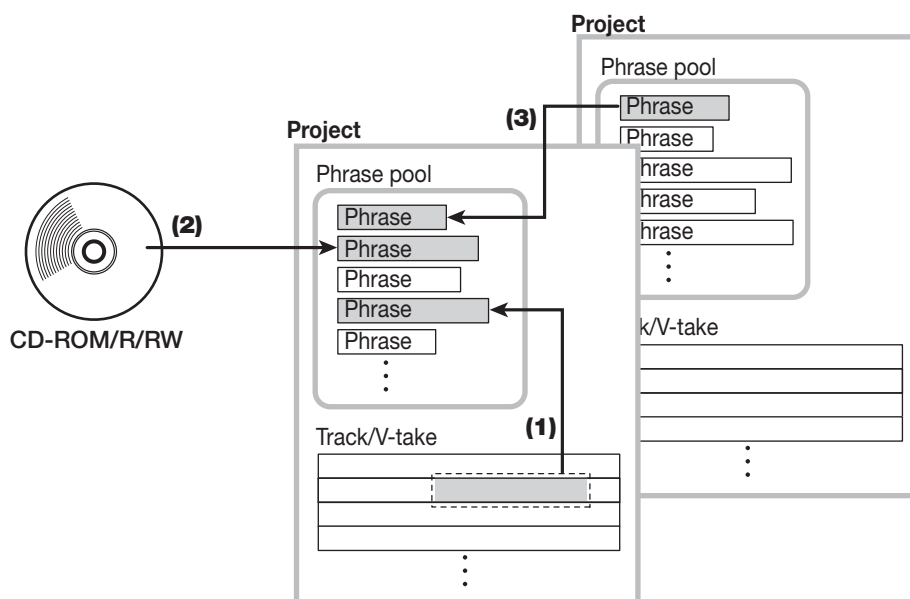

Loading a phrase

This section describes how to load a phrase into the phrase pool.

Basic phrase loading steps

When loading phrases, some steps are similar for each phrase type. These are as follows.

1. From the main screen, press the [UTILITY] key in the display section.

The utility menu appears on the display.



```
UTILITY
TR EDIT
```

2. Use the cursor left/right keys to bring up the indication "UTILITY PHRASE" on the display, and press the [ENTER] key.

The phrase menu appears on the display.

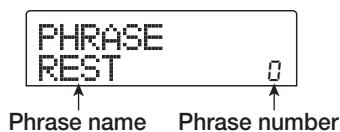

```
PHRASE
REST 0
```

↑ ↑
Phrase name Phrase number

HINT

Phrase number 0 already contains a 4/4 beat 1-measure rest.

3. Turn the dial to select a number into which the phrase should be loaded.

If you select an empty phrase number, the display shows "EMPTY".

NOTE

If you select a number into which a phrase is already loaded, the previous phrase will be erased and replaced by the new phrase.

4. Press the [UTILITY] key in the display section once more.

The phrase utility menu appears on the display.

5. Use the cursor left/right keys to bring up the indication "PHRASE IMPORT" on the display, and

press the [ENTER] key.

The menu for selecting the import source appears on the display.



```
IMPORT
TAKE
```

6. Use the cursor left/right keys to select one of the following, and press the [ENTER] key.

- TAKE

Import a specified range of audio data from any track/V-take in the currently loaded project.

- WAV/AIFF

Import an audio file (WAV/AIFF) from a CD-ROM or CD-R/RW disc inserted in the CD-R/RW drive or from the internal hard disk.

- PHRASE

Import a phrase from the phrase pool of another project saved on the hard disk.

The subsequent steps will differ, depending on which source was selected. See the sections for the respective commands. After the import operation was carried out, the phrase menu appears again on the display. If desired, you can import another phrase. Up to 100 phrases can be included in a project (1 phrase at sampling frequency 44.1 kHz/duration = 1 second to 30 minutes).

Importing a V-take from the current project

You can specify a range from any track/V-take of the current project and use it as material for a phrase loop.

1. Refer to steps 1 - 6 of "Basic phrase loading steps" to select "TAKE" as import source. Then press the [ENTER] key.

The indication "IMPORT TR xx-yy" (where xx is the track number and yy the V-take number) appears on the display. This indicates the import source.

2. Turn the dial to select the track number (1 - 8), and use the cursor up/down keys to select the V-take number (1 - 10).



On this screen, also V-takes that are not currently selected for tracks 1 - 8 can be selected for loading.

When track 8 is selected, turning the dial further to the right brings up the following screen.



When this screen is shown, turning the dial to the right selects tracks in odd-numbered/even-numbered pairs (1/2, 3/4, 5/6, 7/8) or the master track. In this case, the currently selected V-take for the two tracks or the master track becomes the loading target. Use the dial and the cursor up/down keys to select the track/V-take.

3. Press the [ENTER] key.

The display changes to “IMPORT START”. In this condition, you can specify the start point for the data range to be imported.

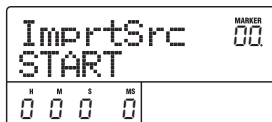

4. Use the cursor left/right keys to move the flashing section of the counter, and turn the dial to specify the start point.

If you move the flashing section to the MARKER field on the display, you can specify a mark by turning the dial. In this case, the mark position becomes the import start point.

NOTE

- By holding down the STOP [■] key and pressing the PLAY [▶] key you can perform scrub playback of the V-take of the specified track (→ p. 44).
- The playback range of the phrase loop can be fine-adjusted also after importing. Therefore it suffices if you make a rough selection here.
- You cannot specify a point where there are no audio data. If you try to do this, the indication “*” appears on the display.

5. When you have specified the start point, press the [ENTER] key.

The display changes as follows.



6. Specify the end point of the range in the same way.

If you press the PLAY [▶] key, the specified range will be played.

7. When you have specified the range, press the [ENTER] key.

The indication “IMPORT SURE?” appears on the display.



8. Press the [ENTER] key.

The phrase is imported. When the import process is completed, the phrase menu appears again.

Importing a WAV/AIFF file

You can import an audio file (WAV/AIFF) from a CD-ROM or CD-R/RW disc inserted in the CD-R/RW drive or from the internal hard disk.

Before doing this, the following preparations are necessary.

- **When importing from the CD-R/RW drive**

Insert a CD-ROM or CD-R/RW disc containing audio files into the CD-R/RW drive.

- **When importing from the internal hard disk**

Copy audio files from a computer into a folder named “WAV_AIFF” immediately under the root directory (top level folder) of the internal hard disk.

NOTE

- To copy audio files to the internal hard disk, the option card UIB01/UIB-02 and a computer are necessary. For details, refer to the documentation of the UIB-01/UIB-02.
- Any sub folders in the WAV_AIFF folder are not recognized.

- 1. Refer to steps 1 - 6 of “Basic phrase loading steps” to select “WAV/AIFF” as import source. Then press the [ENTER] key.**

The indication “IMPORT CD-ROM” appears on the display. You can now select the source device.

```
IMPORT
CD-ROM
```

- 2. Use the cursor left/right keys to select the source device: “CD-ROM” (CD-R/RW drive) or “IntHDD” (internal hard disk).**

- 3. Press the [ENTER] key.**

The unit searches for WAV/AIFF files on the specified device. When files are found, their names are listed on the display.

```
IMPORT
LOOP1
```

HINT

When you select the CD-ROM as import source but no disc is inserted in the drive, the indication “IMPORT Ins Disc” appears on the display and the tray of the CD-R/RW drive opens. To continue the process, insert a disc containing audio files and then press the [ENTER] key.

- 4. Turn the dial to select the audio file to import.**

When accessing a disc in the CD-R/RW drive which has audio files in a certain folder, select the folder name with the dial.

```
IMPORT
WAVFILES
```

When you press the [ENTER] key in this condition, the files inside the selected folder are displayed. Use the [EXIT] key to return to the next higher level.

- 5. To carry out the import process, press the [ENTER] key.**

Depending on the sampling frequency of the imported audio file, the following applies.

- **Sampling frequency 44.1 kHz**

When you press the [ENTER] key, the audio file is imported. When the process is complete, the phrase menu appears again.

- **Sampling frequency other than 44.1 kHz**

When you press the [ENTER] key, a selection screen for conversion to 44.1 kHz (resampling) appears.

```
WAV/AIFF
Resample on
```

Turn the dial to select resampling on/off, and then press the [ENTER] key once more. When the import process is complete, the phrase menu appears again.

NOTE

Imported audio files are always played with a sampling frequency of 44.1 kHz. If resampling was disabled during import, a file with a different sampling frequency will play back with a different pitch.

Importing a phrase from a different project

You can import any phrase contained in the phrase pool of another project stored on the hard disk.

HINT

When you import a phrase from the phrase pool of another project, you cannot specify a range. If necessary, edit the phrase playback point after importing the phrase (→ p. 61).

- 1. Refer to steps 1 - 6 of “Basic phrase loading steps” to select “PHRASE” as import source. Then press the [ENTER] key.**

The indication “PRJ SEL xxxxx” (where xxxxx is the project name) appears on the display. You can now select the source project.

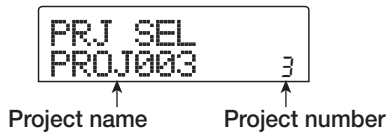

2. Turn the dial to select the source project, and press the [ENTER] key.

The display now shows the screen for selecting phrases in that project.

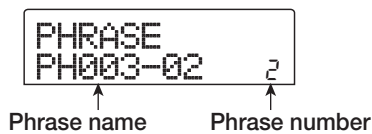

HINT

If the selected project does not contain any phrases, the indication "NO DATA" appears on the display for 2 seconds, and then the original screen returns.

3. Turn the dial to select the phrase, and press the [ENTER] key.

The indication "IMPORT SURE?" appears on the display.

4. To carry out the import process, press the [ENTER] key once more.

The phrase is imported. When the import process is completed, the phrase menu appears again.

Adjusting phrase parameters

Once you have imported phrases into the phrase pool, you should specify parameters such as playback range and number of measures. The following parameters can be adjusted for each phrase individually.

- **START/END (playback start/end point)**

This parameter determines the playback start point and end point of the phrase in millisecond units. In the default condition, the parameter is set to the start and end of the imported data. This parameter can be used for example to extract only a part of a drum loop imported from CD-ROM.

- **MEAS X (number of measures)**

This parameter specifies to how many measures the range between the START/END parameter values corresponds. The parameter lets you compress or expand the playing duration of the phrase to match the tempo setting of the rhythm section. The setting range is 1 - 99 measures.

- **TIMSIG (Beat)**

This parameter specifies the number of beats per measure in the imported phrase. In combination with the MEAS X parameter, this determines the phrase length. The setting range is 1 (1/4) to 8 (8/4).

HINT

If you do not wish to match the phrase to the rhythm section tempo, adjusting the MEAS X and TIMSIG parameters is not necessary.

- **NAME**

This is the name assigned to the phrase.

- **LVL (level)**

This is the playback level of the phrase.

To adjust the above parameters, proceed as follows.

1. From the main screen, press the [UTILITY] key in the display section.

The utility menu appears on the display.



- Use the cursor left/right keys to bring up the indication "UTILITY PHRASE" on the display, and press the [ENTER] key.

The names and numbers of phrases in the phrase pool appear on the display.



- Turn the dial to select the number of the phrase you want to edit.

When you press the PLAY [▶] key, the selected phrase is played. If you select a number where no phrase is imported, the indication "EMPTY" appears instead of the phrase name.

- Press the [EDIT] key.

The phrase edit menu appears.



- Use the cursor up/down keys to call up the parameter you want to edit.

- MEAS X xx (xx = 01 - 99)**

You can set the number of measures in the range from 1 - 99.

- TIMSIG (Beat)**

You can set the number of beats per measure in the phrase.

The setting range is 1 (1/4) to 8 (8/4).

- START**

You can adjust the phrase start point in minutes, seconds, and milliseconds.

- END**

You can adjust the phrase end point in minutes, seconds, and milliseconds.

- NAME**

You can specify a name for the phrase.

- LVL**

You can adjust the phrase playback level in the range of ±24 dB.

- Use the dial and the cursor left/right keys to adjust the setting value.

- Adjusting MEAS/TIMSIG/LVL**

Turn the dial to set the numerical value.

- Adjusting START/END**

Use the cursor left/right keys to select the unit, and turn the dial to set the numerical value.

- Adjusting NAME**

Use the cursor left/right keys to select the character to edit, and turn the dial to select the character.

HINT

You can use the PLAY [▶] key to check the phrase both during and after editing.

- Repeat steps 5 - 6 to complete the phrase.

If desired, press the [EXIT] key several times to return to the screen of step 2, and select another phrase parameter.

- To return to the main screen, press the [EXIT] key several times.

Copying a phrase

You can copy a phrase to any other phrase number. Any phrase at the copy destination will be overwritten (erased).

This is convenient for example to use one phrase as a starting point and save it with different parameter settings.

- From the main screen, press the [UTILITY] key in the display section.

The utility menu appears on the display.



- Use the cursor left/right keys to bring up the indication "UTILITY PHRASE" on the display, and press the [ENTER] key.

The display changes as follows.

3. Turn the dial to select the copy source.
4. Press the [INSERT/COPY] key in the control section.

The screen for specifying the copy destination phrase number appears.

5. Turn the dial to select the phrase number for the copy destination.

The indication "COPY SURE?" appears on the display.

HINT

If a phrase already exists at the copy destination number, it will be erased and replaced by the copy source phrase. Take care not to accidentally delete a phrase.

6. To carry out the copy process, press the [ENTER] key once more.

The phrase is copied. When the copy process is completed, the display reverts to the condition of step 2.

Creating a phrase loop

Phrases stored in the phrase pool can be selected and lined up in any desired sequence, and with any number of repetitions. The result can be written to a track/V-take as a phrase loop. When being written to the track/V-take, the phrase loop is stored in the same format as regular audio data, so that the resulting V-take can be used in the same way as other V-takes.

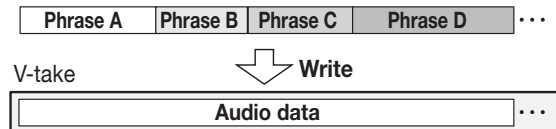

About phrase loop FAST input

The FAST (Formula Assisted Song Translator) method uses simple formulas to specify rhythm pattern playback from start to end.

The status keys and [SOLO] key in the fader section are used for FAST input, as described below.

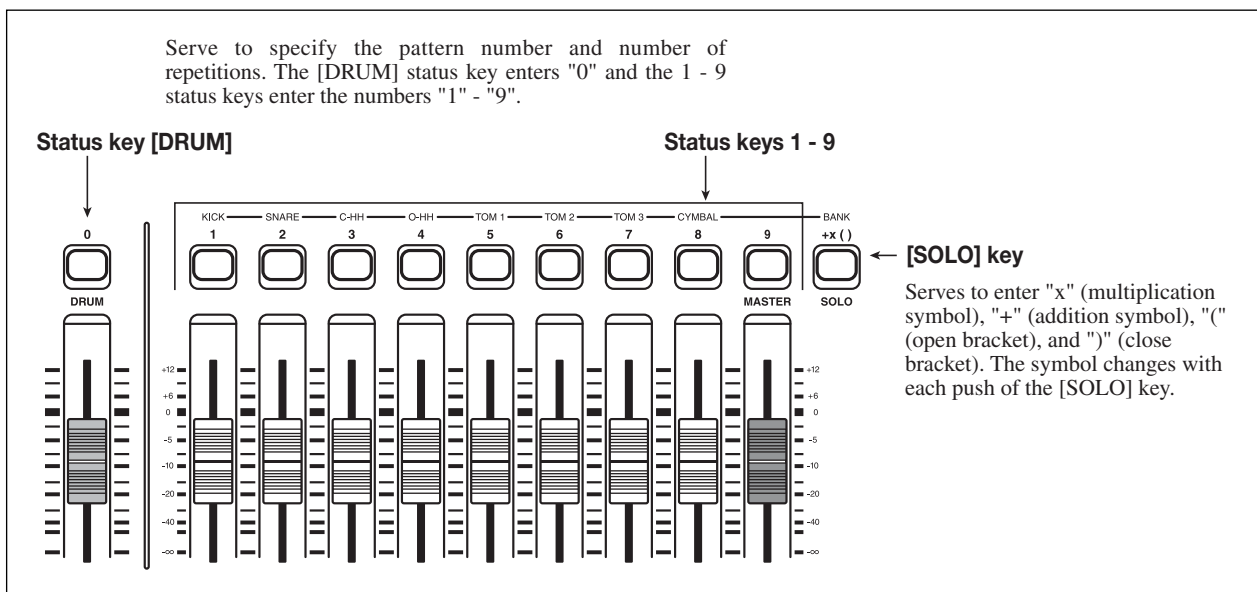

HINT

The FAST input method can also be used to program the rhythm pattern sequence in a rhythm song (→ p. 83).

The basic rules for programming a phrase loop are as follows.

• **Select the phrase**

Use status keys 1 - 9 and the [DRUM] status key to enter a phrase number from 0 - 99. The display shows the phrase number.

• **Line up phrases**

Use the “+” symbol to line up phrases. For example, entering **0+1+2** will result in the following play sequence.

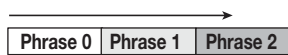

• **Repeat phrases**

Use the “x” symbol to specify phrase repetitions. “x” takes precedence over “+”. For example, entering **0+1x2+2** will result in the following play sequence.



• **Link phrases**

Use the “(“ and “)” symbols to link a group of phrases for repetition, and use the “x” symbol to specify the repetition count. For example, entering **(1+2)x2+3** will result in the following play sequence.



An example for creating the phrase loop “**0+(1+2)x8**” is shown below.

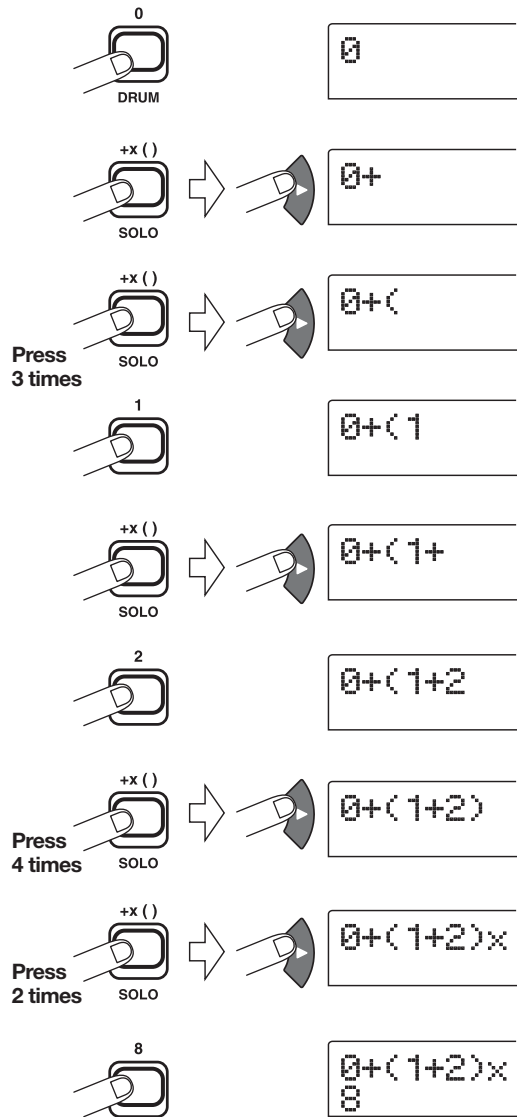

HINT

- When you enter a numeral, the cursor (flashing segment) automatically moves one step to the right.
- After entering “x” and “+” etc., you must use the cursor right key to move the cursor (flashing segment) one step to the right. Then enter the numeral.
- If the formula for the phrase loop does not fit on two lines, the indication scrolls in steps of one character. If you use the cursor left/right keys to move the input position, the line scrolls left and right accordingly.

After entering a formula, it can be edited as follows.

• **Inserting numbers or symbols**

Use the cursor left/right keys to move the cursor (flashing segment) to the desired position and enter the new numeral or symbol.

- **Deleting numbers or symbols**

Use the cursor left/right keys to move the cursor (flashing segment) to the desired position and press the [DELETE/ERASE] key.

When formula input is complete, specify a track/V-take on which to store the phrase loop as audio data.

NOTE

- The formula for a phrase loop is stored as part of a project also after writing the result to a track/V-take. Therefore you can edit and reuse the formula later.
- For a phrase loop that has already been written to a track/V-take, it is not possible to write it again in part or to add another phrase loop. In such a case, specify the entire phrase again as a formula and write the entire phrase again.

Writing a phrase loop to a track

This section explains how to create a phrase loop and write it as audio data to a specified track/V-take.

1. From the main screen, press the [UTILITY] key in the display section.

The utility menu appears on the display.

2. Use the cursor left/right keys to bring up the indication “UTILITY PHRASE” on the display, and press the [ENTER] key.

The display changes as follows.

```
PHRASE
REST  0
```

3. Press the [UTILITY] key in the display section once more.

The phrase utility menu appears on the display.

```
PHRASE
CREATE
```

4. Verify that the indication “PHRASE CREATE” is on the display, and press the [ENTER] key.

If “PHRASE IMPORT” is shown, use the cursor left/right keys to call up “PHRASE CREATE” and press the

[ENTER] key.

The display changes as follows. This screen lets you select a track/V-take for writing the phrase loop.

```
CREATE
TR 1- 1
```

5. Use the cursor up/down keys and the dial to select the track/V-take to which to write the phrase that will be created.

```
CREATE
TR 8- 1
```

When track 8 is selected, turning the dial further to the right brings up the following screen.

```
CREATE
TR1/2
```

When this screen is shown, turning the dial to the right selects tracks in odd-numbered/even-numbered pairs (1/2, 3/4, 5/6, 7/8) or the master track. In this case, the currently selected V-take for the two tracks or the master track becomes the writing target.

NOTE

- If the phrase is monaural and the write target track is stereo, the same data will be written to both tracks.
- If the phrase is stereo and the write target track is mono, the left and right channels of the phrase will be mixed when the data are written to the track.
- When a V-take which already contains audio data is selected, the existing data will be completely erased and overwritten by the new audio data.

6. When you have selected a track/V-take, press the [ENTER] key.

A screen for selecting the phrase loop number appears.

```
CREATE
LOOP01
```

7. Turn the dial to select the desired phrase loop number, and press the [ENTER] key.

Phrase loops can be created from 1 - 10. The name LOOP01 - LOOP10 is assigned to the respective loop.

When you press the [ENTER] key, the display changes to the loop input screen.

8. Use the status keys and [SOLO] key in the fader section to input the formula for creating the loop.

For information on the FAST entry procedure, refer to page 64.

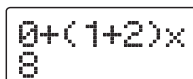

9. When formula input is completed, press the [ENTER] key.

The following screen appears on the display. This screen lets you select whether to match phrase playback to the rhythm section measure.



10. Turn the dial to select one of the following methods.

• ADJUST OFF

When you select this setting, the selected phrase is played continuously, independent of the rhythm song bar lines and tempo. (This is the default setting.)

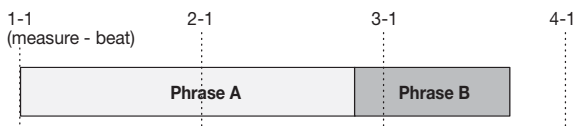

• ADJUST BAR

When you select this setting, phrase playback start is aligned to the measure start of the rhythm song. If one measure of the phrase (phrase playback range divided by number of measures specified by MEAS X parameter) is longer than one measure of the rhythm song, the phrase is switched when the number of measures specified by the MEAS X (→ P.61) parameter has played, without waiting for the end

of the phrase. If one measure of the phrase is shorter than one measure of the rhythm song, there will be a blank until the measure where playback switches to the next phrase.

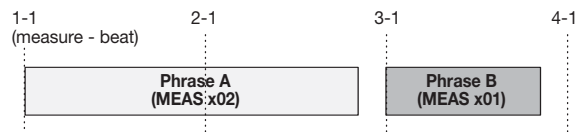

• ADJUST BAR & LEN

When you select this setting, the phrase length is adjusted so that the measures of the rhythm song and the phrase are matched. (Pitch will not change.)

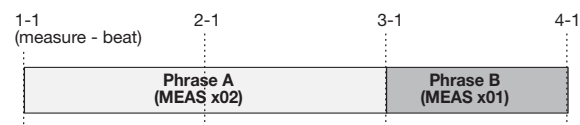

NOTE

- When selecting ADJUST BAR or ADJUST BAR & LEN, verify that the MEAS X parameter for each phrase is set to a suitable number of measures. If the setting is inappropriate, the rhythm song and phrase will not synchronize properly.
- If the compression/stretch ratio exceeds a certain range, the result will not be as intended. In this case, the indication “Out of range” appears during processing.

11. Press the [ENTER] key.

The indication “CREATE SURE?” appears on the display.

12. To carry out the phrase loop creation process, press the [ENTER] key once more.

The phrase loop is created. When the process is completed, the display reverts to the condition of step 2.

Reference [Mixer]

This section explains the functions and operation of the two types of mixers built into the MRS-802.

About the mixer

The mixer of the MRS-802 is divided into two sections: an “input mixer” that processes the input signals from the input jacks, and a “track mixer” that processes the signals from the tracks of the recorder section and from the rhythm section. Details of each mixer are described below.

■ Input mixer

The input mixer serves to adjust the sensitivity of the signals that are input from the INPUT 1/2 jacks, set various parameters such as pan and send levels to the send/return effects, and assign the signals to the recorder tracks.

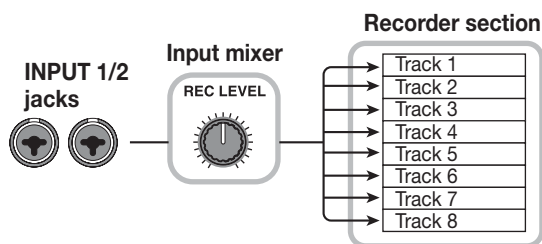

The parameters that can be adjusted in the input mixer are listed in the following table.

Parameter	Description
CHO SEND	Volume sent to chorus/delay (send/return effect)
REV SEND	Volume sent to reverb (send/return effect)
PAN	Left/right position (L/R channel balance)
REC LVL	Volume of input signal (position of [REC LEVEL] control)

■ Track mixer

The track mixer serves to process the playback signals of the recorder tracks (1 - 8) and the rhythm section (drum track), and mix these signals to stereo.

The faders and status keys are used to adjust the volume for each track and control the on/off setting.

The signal mixed by the track mixer is routed via the [MASTER] fader to the MASTER OUTPUT jacks and the master track (see diagram below).

The parameters that can be adjusted in the track mixer are listed in the following table.

■ HINT ■

The drum kit signal is in stereo. For the drum channel of the track mixer, the left/right parameter settings are therefore linked.

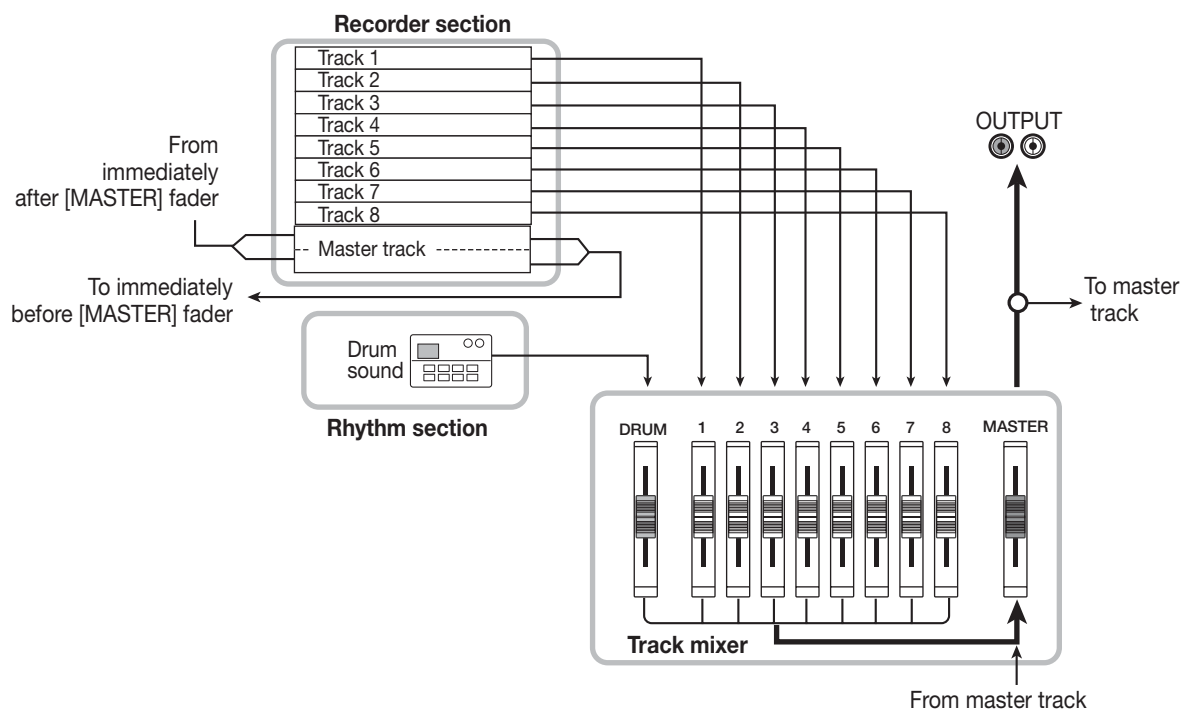

Parameter	Description	Drum track	Track 1 - 8	Master track
EQ HI G	High frequency range EQ boost/cut amount	○	○	
EQ HI F	High frequency range EQ boost/cut frequency	○	○	
EQ LO G	Low frequency range EQ boost/cut amount	○	○	
EQ LO F	Low frequency range EQ boost/cut frequency	○	○	
CHO SEND	Volume sent to chorus/delay (send/return effect)	○	○	
REV SEND	Volume sent to reverb (send/return effect)	○	○	
PAN	Left/right position (L/R channel balance)	○	○	
FADER	Volume of track or rhythm section	○	○	○
ST LINK	Link parameters of odd/even-numbered channels		○	
V TAKE	V-take selected for track		○	○

Basic operation of the input mixer

Assigning input signals to tracks

This section explains how to adjust the level of signals input from the INPUT 1/2 jacks and the GUITAR/BASS jack, and how to send them to a track in the recorder section.

1. Make sure that the instrument or mic that you want to record is connected to the INPUT 1/2 or the GUITAR/BASS jack.

NOTE

When something is connected to both the INPUT 1 jack and the GUITAR/BASS jack, the signal at the GUITAR/BASS jack has priority and the INPUT 1 signal is disabled.

2. Press the [INPUT 1] or [INPUT 2] key, so that the key to which the instrument or mic is connected lights up.

This shows that the input is selected. You can also select both inputs by pressing the two keys simultaneously.

HINT

If an input is already selected (key is lit) and you press the other key, the currently selected key goes out and the other key becomes active.

3. While playing your instrument, turn the [INPUT] control for the input selected in step 2, to adjust the input sensitivity.

Make adjustments so that the [PEAK] indicator flickers slightly when you play your instrument at its loudest volume.

4. If you will be recording the sound through the insert effect, press the [INPUT SOURCE] key in the effect section and turn the dial to set the insert position for the effect to IN.

With the default settings of a project, the insert effect is inserted into the input mixer (IN), and a patch suitable for guitar/bass recording is selected.

```
IN SRC
IN
```

HINT

If you want to record without sending the sound through the insert effect, press the [BYPASS/TUNER] key in the effect section to bypass the insert effect.

5. Press the [EXIT] key to return to the main screen.
6. Press one of [INSERT EFFECT] keys in the effect section to select the desired algorithm, and turn the dial to select the patch to be used.

The key lights up and the currently selected patch appears on the display. When patch selection is complete, press the [EXIT] key to return to the main screen.

You can also select a patch by using the PATCH SELECT [▲]/[▼] keys in the effect section.

```
INSERT
MRS-Drv
```

7. While playing your instrument, adjust the recording level by turning the [REC LEVEL] control.

The [REC LEVEL] control adjusts the signal level before it is sent to the recording track (i.e., after it has passed through

the insert effect). The [CLIP] indicator will light if the level is too high. Set the recording level as high as possible, but avoid settings that cause the [CLIP] indicator to light.

HINT

- The level of the signal sent to the recording track will change according to the settings of the insert effect parameters. If you switch insert effect patches or edit the parameters, you should once again check whether the recording level is appropriate.
- The precise setting of the [REC LEVEL] control parameter can be checked by pressing the track parameter section [TRACK PARAMETER] key → [INPUT 1] (or [INPUT 2]) and repeatedly the cursor down key. The value set with the [REC LEVEL] control is shown numerically. This is useful to obtain accurate information about the recording level setting.

8. Press the status key for the recording destination track (1 - 8) so that the key is lit in red. The track is now ready for recording.

The input signal from the input mixer will be sent to the recording track. You can select record mode for two tracks by causing two status keys to light up. Combinations are limited to 1/2, 3/4, 5/6, or 7/8.

The signal flow from the input mixer to the track will change as follows, depending on the number of inputs and recording tracks.

• Two mono tracks selected as recording tracks

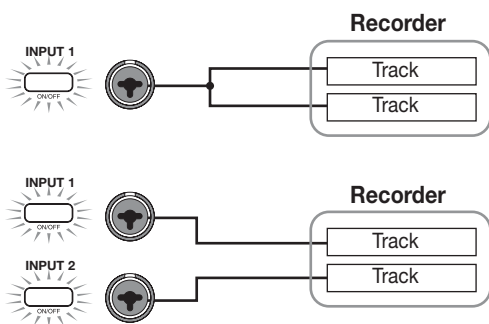

• One mono track selected as recording track

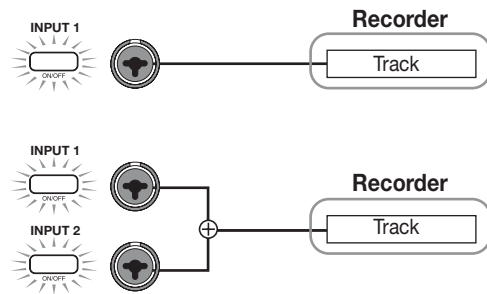

• No track selected as recording track

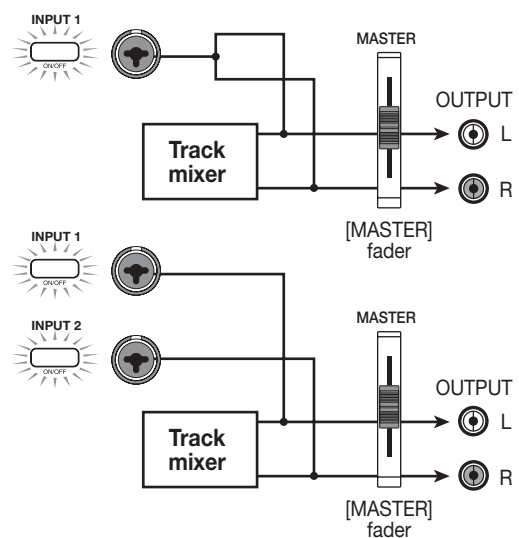

NOTE

The diagrams above show the signal flow when the insert effect has not been inserted into the input mixer. For details on the signal flow when the insert effect is inserted, refer to page 102.

Adjusting the depth of the send/return effects

The depth of the send/return effects can be adjusted by setting the volume (send level) of the signal that is sent from the input mixer to each send/return effect (chorus/delay, reverb).

In normal operation, sending the signal from the input mixer to the send/return effect will only apply the effect to the signal that is sent from the MASTER OUTPUT jacks, and will not affect the signal that is recorded on a track.

HINT

To record the signal processed by the send/return effect on a track, you can use bounce recording while the respective [INPUT 1]/[INPUT 2] key is on (→ p. 39).

1. Press the [CHORUS/DELAY] key or [REVERB] key to select a patch for the send/return effect.

The display changes and shows the currently selected patch of the selected effect (chorus/delay or reverb).

2. Turn the dial to select the patch you want to use.

You can also select a patch by using the PATCH SELECT [▲]/[▼] keys in the effect section.

When you have selected the patch, press the [EXIT] key to return to the main screen.

3. Press the [TRACK PARAMETER] key in the track parameter section and use the cursor up/down keys to bring the following indication onto the display.

- To adjust the chorus/delay send level

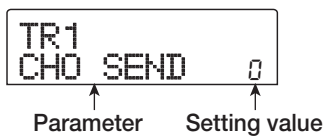

- To adjust the reverb send level

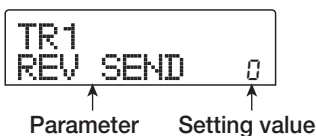

4. Press the [INPUT 1] or [INPUT 2] key in the input section.

The input mixer (INPUT) is selected as target for setting the send level.



5. Turn the dial to select the effect depth.

Higher values result in more effect depth (stronger effect).

The range and default values for the parameters are shown below.

- CHORUS/DELAY SEND: 0 - 100 (default: 0)
- REVERB SEND: 0 - 100 (default: 0)

HINT

When the send level is shown on the display, pressing the [ENTER] key will turn the signal output to the send return effect off. Pressing the key once more will turn the signal on again.

6. When you have finished making settings, press the [EXIT] key.

The unit returns to the main screen.

Adjusting the pan/balance

This section explains how to adjust the pan (stereo position) of the signal sent from the input mixer to the MASTER OUTPUT jacks and the recording tracks, or the balance (the volume balance between two channels).

1. Press the [TRACK PARAMETER] key in the track parameter section and use the cursor up/down keys to bring the following indication onto the display.



2. Press the [INPUT 1] or [INPUT 2] key in the input section.

The input mixer (INPUT) is selected as target for panning adjustment.



3. Turn the dial to edit the value of the PAN parameter.

The PAN parameter can be adjusted in a range of L100 (far left) - 0 (center) - R100 (far right).

4. When you have finished adjusting the panning value, press the [EXIT] key.

The unit returns to the main screen. The function of the PAN parameter changes as follows, depending on the number of inputs that are currently turned on, and on the number of recording tracks that are currently selected.

- **When no recording track is selected**

For the signal that is sent from the input mixer to the L/R channels of the MASTER OUTPUT jacks, the PAN parameter will adjust the panning position (if the input is in mono) or the balance (if the input is in stereo).

- **When two mono tracks are selected as recording tracks**

For the signal that is sent from the input mixer to the two tracks, the PAN parameter will adjust the panning position (if the input is in mono) or the balance (if the input is in stereo).

- **When one mono track is selected as recording track**

The PAN parameter will have no effect.

Basic operation of the track mixer

Adjusting the volume/pan/EQ

For each channel, you can adjust the volume, panning (stereo position between L/R channels), and EQ (equalizer).

- 1.** To adjust the volume of the audio track or the drum track, operate the respective fader.
- 2.** To adjust the panning position of a track or the drum track, press the [TRACK PARAMETER] key in the track parameter section and use the cursor up/down keys to bring the following indication onto the display.



TR1
PAN

- 3.** Press the status key for the audio track or the drum track, and turn the dial to edit the value of the PAN parameter.

The PAN parameter can be adjusted in a range of L100 (far left) - 0 (center) - R100 (far right).

To adjust the pan of another track or the drum track, repeat steps 2 - 3.

HINT

- If the stereo link function (→ p. 73) is activated for the selected target track (audio track or drum track), the PAN parameter adjusts the left/right channel balance.
- In the parameter screen you can also use the cursor left/right keys to select the audio track or the drum track and the cursor up/down keys to switch parameters.

- 4.** To adjust EQ, use the cursor up/down keys to bring up the following screen and then use the dial to adjust the setting.

- EQ HI G parameter



TR1
EQ HI G

Adjusts the amount of high-range boost/cut.

Range: -12 - 0 - 12 (dB)

Default: 0

- EQ HI F parameter

```
TR1
EQ HI F 8000
```

Adjusts the turnover frequency for high-range boost/cut.

Range: 500 - 18000 (Hz)

Default: 8000

- EQ LO G parameter

```
TR1
EQ LO G 0
```

Adjusts the amount of low-range boost/cut.

Range: -12 - 0 - 12 (dB)

Default: 0

- EQ LO F parameter

```
TR1
EQ LO F 125
```

Adjusts the turnover frequency for low-range boost/cut.

Range: 40 - 1600 (Hz)

Default: 125

HINT

- If you press the [ENTER] key while the EQ HIGH parameter is displayed, EQ HIGH is turned off. Pressing the key once more turns EQ HIGH on again. In the same way, you can switch EQ LOW between on and off with the [ENTER] key while the EQ LOW parameter is displayed.
- Immediately after switching the display, the audio track or the drum track that was selected before will still be selected. If necessary, switch to another track.

5. Set the EQ parameter for other audio tracks or the drum track in the same way.

6. When you have finished adjusting settings, press the [EXIT] key.

The unit returns to the main screen.

Adjusting depth of send/return effect

This section explains how to adjust the effect depth by setting the volume that is sent from each channel to the send/return effects (chorus/delay, reverb). Raising the send level will produce a deeper effect.

1. Press the [CHORUS/DELAY] key or [REVERB] key to select a patch for the send/return effect.

The display changes and shows the currently selected patch of the selected effect (chorus/delay or reverb).

2. Turn the dial to select the patch you want to use.

You can also select a patch by using the PATCH SELECT [▲]/[▼] keys in the effect section.

When you have selected the patch, press the [EXIT] key.

3. Press the [TRACK PARAMETER] key in the track parameter section and use the cursor up/down keys to bring the following indication onto the display.

- Adjusting the chorus/delay send level

```
TR1
CHO SEND 0
```

- Adjusting the reverb send level

```
TR1
REV SEND 0
```

4. Press the status key for the audio track or the drum track to which you want to apply the effect.

5. Turn the dial to select the effect depth.

Higher values result in more effect depth (stronger effect). The range and default values for the parameters are shown below.

- CHORUS/DELAY SEND: 0 - 100 (default: 0)
- REVERB SEND: 0 - 100 (default: 0)

HINT

When the send level is shown on the display, pressing the [ENTER] key will turn the signal output to the send return effect off. Pressing the key once more will turn the signal on again.

6. When you have finished making settings, press the [EXIT] key.

The unit returns to the main screen.

Linking odd-numbered/even-numbered channels (stereo link)

Adjacent odd-numbered/even-numbered mono channels (1/2, 3/4, 5/6, 7/8) can be linked and used as a pair of stereo tracks. (This is referred to as “stereo link”.) The parameters and status keys of two stereo-linked channels will operate in tandem. The setting procedure is as follows.

- 1.** Press the [TRACK PARAMETER] key in the track parameter section.
- 2.** Press the status key (1 - 8) for one of the two channels that you want to stereo-link.
- 3.** Press the cursor down key several times.

The following screen appears.

```
TR7
ST LINK  off
```

4. Turn the dial to switch the setting ON.

Stereo linking will be enabled for the selected channel and the adjacent odd-numbered/even-numbered channel. To defeat the stereo link, turn this parameter OFF.

```
TR7/8
ST LINK  on
```

5. When the setting is complete, press the [EXIT] key.

The unit returns to the main screen.

HINT

The PAN parameter of two stereo-linked channels will function as a BALANCE parameter that adjusts the volume balance between the odd-numbered / even-numbered channels.

NOTE

To adjust the volume of stereo-linked channels, use the odd-numbered fader. (The even-numbered fader will have no effect.)

Using the solo function

If desired, you can mute all other tracks except one during playback of the recorder section. This is called the “solo function”. It is convenient for example to fine-tune the parameters for a certain track.

- 1.** From the main screen, perform playback of the recorder section and press the [SOLO] key in the fader section.

The key lights up.

- 2.** Use the status key (except for MASTER) to select the track for solo monitoring.

The status key lights up in green, and only the corresponding track is heard.

- 3.** To cancel the solo function, press the [SOLO] key once more.

The key goes out.

Saving/recalling mixer settings (Scene function)

The current mixer and effect settings can be saved as a “scene” in a special area of memory, and recalled either manually or automatically when desired. This is convenient when you want to compare various mixes, or when you want to automate mix operations.

A scene contains the following data.

- Track parameters (except for currently selected V-take number)
- Insert effect patch number/input source
- Send/return effect (chorus/delay, reverb) patch number
- The state of all status keys 1 - 8 and the [DRUM] status key (play, mute)
- Fader settings

Up to 100 different scenes can be stored in memory. Scene data stored in memory are saved on the internal hard disk as part of the currently selected project.

Saving a scene

This section explains how to save the current settings as a scene.

- 1.** Press the [SCENE] key in the control section.
- 2.** Turn the dial to select the scene number (0 - 99) in which the data will be saved.

If you select a number where scene data are already saved, the existing data will be erased and overwritten by the new data.

- 3.** Press the [STORE] key.

In this condition, you can specify a name for the scene.

- 4.** Use the cursor left/right keys to move the flashing position to the character you want to change, and turn the dial to select a character.

For information on available characters, refer to page 34.

5. Repeat step 4 as necessary to complete the new name.

6. To carry out the store process, press the [STORE] key or the [ENTER] key.

The current mixer and effect settings will be saved as a scene. When the process is completed, the unit returns to the screen of step 2. If you wish to cancel the process, you can press the [EXIT] key to return to the previous screen.

7. Press the [EXIT] key to return to the main screen.

Recalling a saved scene

This section explains how to recall a scene that was saved to memory.

1. Press the [SCENE] key in the control section.

The right side of the display indicates the scene number that will be recalled.

2. Turn the dial to select the scene to recall.

3. To recall the selected scene, press the [ENTER] key. If you wish to cancel the process, press the [EXIT] key.

If you press the [ENTER] key, the scene is recalled and the unit returns to the condition of step 1. If you press the [EXIT] key, the unit returns to the main screen.

By pressing the [EDIT] key after selecting a scene, you can edit the name of the scene.

Switching scenes automatically

By assigning a scene to a mark (→ p. 42) that was placed at a desired location in the song, you can cause scenes to switch automatically. This is convenient when you want to change the mix or the effect settings as the song progresses.

1. Move to the point in the song where you want to change the mix, and press the [MARK] key in the control section.

A mark is entered at this point. Repeat this step to enter

marks at all other points where you want to change the mix.

2. Save the mix to be used at the start of the song as well as all other mix settings as scenes.

When creating a mix for a specific range, using functions such as the marker function to locate points (→ p. 43) and the A-B repeat function (→ p. 44) is convenient.

3. Verify that the recorder is stopped, and press the ZERO [◀◀] key in the transport section to return to the beginning of the song.

The beginning of the song (counter zero location) already contains the mark number zero. First you will assign the starting scene to this mark.

4. Press the [MARK] key.

When you press the [MARK] key at a location where a mark has been assigned, a screen will appear in which you can assign a scene to the corresponding mark.

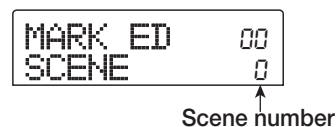

HINT

- If you press the [MARK] key at a location where a mark has not yet been assigned, a new mark will be assigned to that location.
- If a dot is shown at the lower right of the mark number, this means that the mark matches the current location.

5. Turn the dial to select the number of the scene you want to assign to this mark, and press the [ENTER] key.

The scene will be assigned to the mark. The following screen shows an example of scene number 1 being assigned to mark number 0.

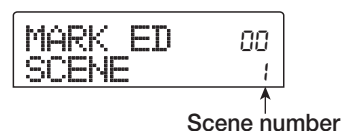

HINT

To cancel a scene assignment, turn the dial to make the display indicate "--".

6. Locate the next mark at which you want the mix to change, and repeat steps 4 - 5.
7. When scenes have been assigned to all marks, press the ZERO [◀◀] key to return to the beginning of the song, and then press the PLAY [▶] key to start playback.

Each time the song reaches a mark to which a scene has been assigned, that scene will be recalled.

Deleting certain parameters from a scene

If desired, you can disable a group of parameters saved in a scene. Such parameters will not change even if that scene is recalled. The following groups of parameters can be specified and made active or inactive.

Group	Item
TRACK PARAMETER	EQ HI
	EQ LO
	Chorus send
	Reverb send
	Pan
INSERT EFFECT	Patch number
	Input source
CHORUS/DELAY	Patch number
REVERB	Patch number
ALL FADER	Fader position

For example, after you have programmed a sequence of automatic scene changes, you may want to disable the TRACK PARAMETER group and set only the EQ and panning parameters manually for each track.

1. Press the [SCENE] key in the control section, and then press the [UTILITY] key in the display section.

The following screen appears on the display. In this condition, you can enable or disable the faders for each scene.



2. Turn the dial to set fader permission to ON or OFF.
3. Press the other keys for parameter groups, to enable or disable the group.

Except for the fader, scene control for the other groups can be enabled or disabled by pressing one of the keys listed below.

- **TRACK PARAMETER group**
Any status key except [MASTER] status key
- **INSERT EFFECT group**
Any [INSERT EFFECT] key
- **CHORUS/DELAY group**
[CHORUS/DELAY] key
- **REVERB group**
[REVERB] key

When a group is enabled, the respective keys are lit, and when the group is disabled, the keys are flashing.

HINT

- The TRACK PARAMETER group can be enabled or disabled for each audio track and the drum track separately.
- You can also use the cursor up/down keys to enable or disable all groups together.

4. When the setting is complete, press the [EXIT] key.

The unit returns to the scene menu.

5. To return to the main screen, press the [EXIT] key.

The parameter group on/off status is stored as part of the project.

Reference [Rhythm]

This section explains the functions and operation of the rhythm section, which uses internal drum sounds to generate backing performances.

About the rhythm section

The rhythm section of the MRS-802 contains a variety of drum sounds. The section can be operated in synchronization with the recorder or as an independent drum machine. Here we will explain the basic concepts and terms that you need to know in order to use the rhythm section.

Drum kits

The MRS-802 incorporates various drum and percussion sounds which are combined into drum kits. A drum kit is a set of 24 drum/percussion sounds. The MRS-802 contains 43 different drum kits of which you can select one at a time. A drum kit can be used as source for rhythm accompaniment, and it can also be played using an external MIDI keyboard or sequencer. The status keys on the top panel can also be used to play the drum/percussion sounds of the currently selected drum kit.

The output signal of the drum kit (drum track) is connected to the internal mixer. Similar to ordinary audio tracks 1 - 8, you can adjust parameters such as volume, balance, and EQ for the drum track and apply the send/return effect.

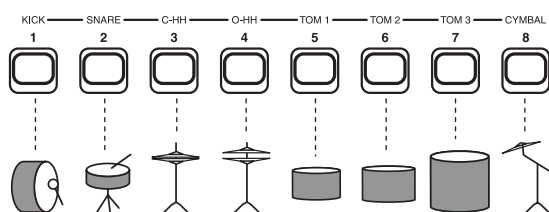

Rhythm patterns

A newly created project contains accompaniment patterns for up to 99 measures each. These accompaniment patterns are called “rhythm patterns”. The project has more than 400 such patterns to choose from.

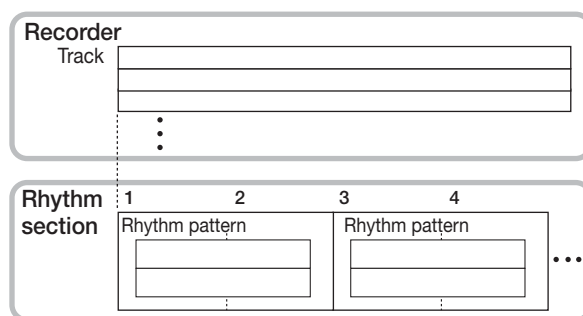

Besides using a pattern as is, you can edit a portion of it, or create your own patterns in empty rhythm pattern slots. The rhythm patterns you create or modify are saved on the hard disk as part of the project.

Rhythm songs

Multiple rhythm patterns arranged in a desired order of playback are collectively called a “rhythm song”. In a rhythm song, you can program the rhythm pattern data, beat data, tempo data etc. (as “events”), to create the accompaniment for an entire song.

Up to 10 rhythm songs can be saved in each project.

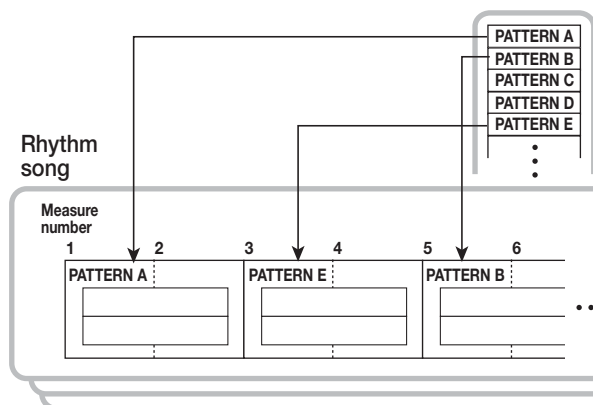

Rhythm pattern mode and rhythm song mode

The rhythm section can operate in one of two modes: “rhythm pattern mode”, in which you can create and play rhythm patterns, and “rhythm song mode”, in which you can create and play a rhythm song. One of these two modes will always be selected.

When the rhythm song mode is selected, the [SONG/PATTERN] key is lit, and when the rhythm pattern mode is selected, the key is out. Toggle between the two modes by pressing the [SONG/PATTERN] key.

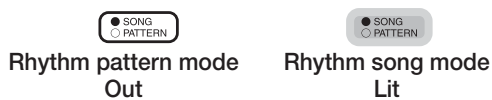

Synchronizing the recorder section and rhythm section

In the default condition of the MRS-802, the rhythm section will operate in synchronization with the recorder section. When you operate the transport section to start the recorder section running, the rhythm pattern or rhythm song will also begin playing. If desired, the rhythm section can be disconnected from the recorder section and used as an independent drum machine.

Pressing the [DRUM] key from the main screen so that the key lights up causes the rhythm section to be separated from the recorder section. In this state, operating the transport will cause only the rhythm section to begin playing, and the recorder section will remain stopped.

To restore the original condition, press the [EXIT] key so that the [DRUM] key goes out.

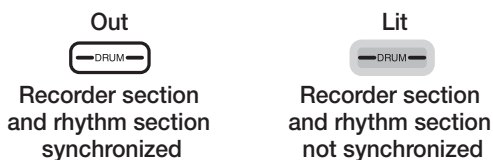

Playing rhythm patterns

This section explains how to play rhythm patterns and how to change the tempo and select a drum kit.

Selecting and playing a rhythm pattern

This section explains how to select and play one of the rhythm patterns in a project.

NOTE

Before you continue with the following procedure, make sure that the [DRUM] and [MASTER] faders on the top panel are raised, and that the [DRUM] status key is lit.

1. From the main screen, press the [DRUM] key.

The key lights up and the rhythm section is separated from the recorder section and can be used independently.

2. Verify that the [SONG/PATTERN] key is out. If the key is lit, press it so that it goes out.

When the [SONG/PATTERN] key is out, the rhythm pattern mode is selected as operation mode for the rhythm section. In rhythm pattern mode, the display shows various information about the currently selected rhythm pattern.

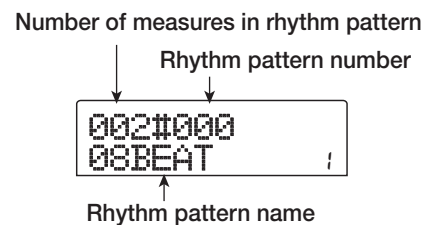

HINT

From the main screen, it is also possible to directly call up the above display by repeatedly pressing the [SONG/PATTERN] key. When you do this, the [DRUM] key flashes. This indicates that the recorder and rhythm section remain synchronized.

3. Turn the dial to select the rhythm pattern that you want to play.

You can also use the cursor up/down keys to select a pattern.

4. Press the PLAY [▶] key.

The rhythm pattern will begin playing, independently from the recorder section.

HINT

- If you use the dial to change the pattern while the rhythm section is playing, the new pattern will start after the end of the current pattern is reached.
- If you use the cursor up/down keys to change the pattern while the rhythm section is playing, the new pattern will start immediately.

5. If you want to mute the rhythm section, press the [DRUM] status key.

The key goes out, and the rhythm section will be muted. To defeat muting, press the [DRUM] status key once more.

6. To stop playback, press the STOP [■] key.

The rhythm pattern will stop.

7. To return to the main screen, press the [EXIT] key repeatedly.

The [DRUM] key goes out, and the recorder section and rhythm section are synchronized again.

HINT

- By pressing the PLAY [▶] key after bringing up the main screen, you can start playback of the recorder section at the same time.
- It is also possible to load rhythm pattern data from another project saved on the hard disk (→ p. 96).

Changing the tempo of the rhythm pattern

You can change the tempo of the rhythm pattern.

- 1. From the main screen, press the [DRUM] key so that the key lights up.**
- 2. Verify that the [SONG/PATTERN] key is out. If the key is lit, press it so that it goes out.**

3. In rhythm pattern mode, press the [TEMPO] key in the rhythm section.

The current tempo value will be displayed in BPM (beats per minute).

**4. Turn the dial to adjust the tempo.**

The tempo can be adjusted in steps of 0.1 over a range of 40 - 250 (BPM). The tempo can also be changed after playback of the rhythm pattern has been started by pressing the PLAY [▶] key.

5. To change the tempo manually, press the [TEMPO] key twice or more at the desired tempo.

The interval between the last two times you pressed the key will be detected automatically, and set as the new tempo.

6. To return to the main screen, press the [EXIT] key several times.**HINT**

- The tempo you specify here will apply to all rhythm patterns played in rhythm pattern mode, and to a rhythm song in which tempo data has not yet been input.
- The tempo can also be changed from the main screen.

NOTE

If you record on the recorder tracks while listening to the rhythm patterns, and then later change the tempo of the rhythm patterns, the two sets of performances will no longer be synchronized. If you want to record on the recorder while listening to rhythm patterns, you must decide on the tempo first.

Changing the drum kit

You can change the drum kit used by the rhythm section. The selected drum kit applies to all rhythm patterns and rhythm songs.

- 1. While the rhythm section is stopped, press the [DRUM] key at the main screen.**

2. Press the [UTILITY] key.

The utility menu for the rhythm section appears.

```
Utility
Drum Kit
```

3. Press the [ENTER] key.

The display changes as follows. In this condition, you can select a drum kit.

```
Drum Kit
00LIVE1
```

4. Turn the dial to select the desired drum kit, and press the [ENTER] key.

The selected drum kit is loaded and the unit returns to the condition of step 3. For a list of drum kits that can be selected, refer to the appendix at the end of this manual.

5. To return to the main screen, press the [EXIT] key several times.

Creating a rhythm song

The MRS-802 allows you to save up to 10 rhythm songs per project. Out of these, one is selected for editing or playing. One rhythm song can have up to 999 measures of rhythm patterns. After entering patterns, tempo and other information is added to complete the song.

Selecting a rhythm song

First, select a rhythm song in which to enter rhythm patterns.

HINT

When you create a new project on the MRS-802, all rhythm songs will be empty.

1. From the main screen, press the [DRUM] key, so that the key lights up.**2.** Press the [SONG/PATTERN] key, so that the key lights up.

When the [SONG/PATTERN] key is lit, the rhythm section is in rhythm song mode, allowing you to create and play rhythm songs. The name of the rhythm song (or "EMPTY") and the rhythm song number are shown on the display.

Rhythm song number

```
SongNo0E
EMPTY
```

HINT

From the main screen, it is also possible to directly call up the above display by repeatedly pressing the [SONG/PATTERN] key. When you do this, the [DRUM] key flashes. This indicates that the recorder and rhythm section remain synchronized.

3. Turn the dial to select a rhythm song number from 0 - 9.**4.** To return to the main screen, press the [EXIT] key several times.

Inputting rhythm pattern data

This section explains how to input rhythm pattern data into an empty rhythm song in the desired playback order. The following two input methods are available.

- **Step input**

With this method, you create rhythm patterns one by one by specifying a pattern number and number of measures. Input can be performed at any point in the song. It is also possible to switch to another rhythm pattern while the previous rhythm pattern is still playing. This method is suitable for specifying patterns in detail.

- **FAST (Formula Assisted Song Translator)**

This method uses simple formulas to specify rhythm pattern playback from start to end. The result is written to the rhythm song in a single operation. This method is suitable for mechanical input using a score and for frequently repeated rhythm patterns. Input midway through a song is not possible with this method.

Steps for the two methods are described below.

Step input

With this method, you specify the pattern number and number of measures to enter patterns one by one.

- 1. In rhythm song mode ([SONG/PATTERN] key lit), press the [DRUM] key so that it is lit.**

For rhythm pattern input and editing, the [DRUM] key must be lit, indicating that the rhythm section is separated from the recorder section.

- 2. Press the REC [●] key.**

The key lights up and rhythm pattern number as well as other information can be input. The display changes as follows.

```
EV→
EOS
```

During rhythm song step input, the first line of the display shows the currently selected item, and the second line the

setting value of that item. Because an empty rhythm song does not yet contain any information, the second line of the display indicates “EOS” (End Of Song) to show the end of the rhythm song.

- 3. Use the cursor up/down keys to bring up the indication “← PTN” on the first line of the display.**

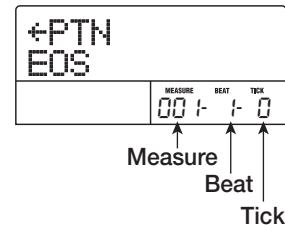

During step input, the cursor up/down keys are used to select an item, and the cursor left/right keys to move the current position. The following items can be selected with the cursor up/down keys.

Parameter	Description
EV →	Event information at current point
PTN	Rhythm pattern
TimSig	Beat
DrVOL	Drum kit volume
Tempo	Tempo

HINT

When an item other than “EV→” is selected and no information is input for the current position, the arrow “←” is shown before the item name (for example: “← PTN”). This indicates that information input at a preceding point is still valid.

Normally, when “PTN” is selected, the first line of the display shows the number of the pattern input for the current point, and the second line shows the pattern name. Because an empty rhythm song does not yet contain any information, the first line of the display shows “← PTN” and the second line is blank.

- 4. Press the [INSERT/COPY] key to bring up the indication “INSERT?”**

When “INSERT?” is displayed, new rhythm pattern data can be input at the current location.



5. Turn the dial to select the rhythm pattern that you want to input.

The number and length (in measures) of the currently selected rhythm pattern will be displayed.

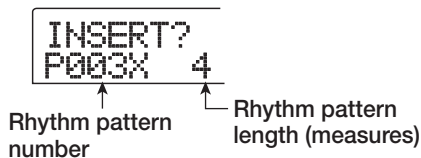

6. If necessary, use the cursor up/down keys to change the length of the rhythm pattern.

If you make the rhythm pattern longer, the same rhythm pattern will play repeatedly. If you shorten the rhythm pattern, the song will switch to the next rhythm pattern before the current pattern has finished playing.

HINT

This operation will not affect the original rhythm pattern.

7. To finalize the selected rhythm pattern, press the [ENTER] key.

The rhythm pattern data will be input at the current location. (The “EOS” indication is moved back by the number of input measures.)

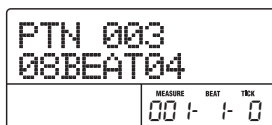

HINT

When you input rhythm pattern information, the events “TimSig” (beat) and “DrVOL” (drum track volume) are added automatically at the same point in the rhythm song. The values for these events can be changed later.

8. Repeatedly press the cursor right key to move to the location at which you will input the next rhythm pattern.

Each time you press a cursor left/right key, the current location will move one measure backward or forward. When

you advance to the end of the rhythm song, the display will indicate “EOS”.

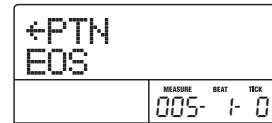

HINT

When you move to a point beyond the last measure where pattern information was input, the indication “←PTN” is shown. The arrow indicates that information (in this case pattern information) input at a preceding point is still valid.

9. Repeat steps 4 - 8 to input rhythm patterns for the entire song.

The rhythm song is extended for the number of measures that you have newly input, and the “EOS” indication moves accordingly.

10. Repeat this procedure to input rhythm patterns for the entire song.

11. When input for one rhythm song is completed, press the STOP [■] key.

The REC [●] key goes out, and the unit returns to the rhythm song screen. If you wish to check the input result, press the PLAY [▶] key.

12. To return to the main screen, press the [EXIT] key while the rhythm section is stopped.

To edit an input rhythm pattern, perform the following steps while the REC [●] key is lit.

NOTE

- If you play the rhythm song in this condition, the most recently selected drum kit and tempo will be used.
- To switch the drum kit, bring up the utility menu and select a new kit. (It is not possible to specify a drum kit for each rhythm song.)
- To specify tempo information for a particular rhythm song, enter the tempo information at the beginning (→ p. 86).

■ To re-select a pattern that you input

Use the cursor left/right keys to move to the desired rhythm pattern data, and turn the dial to select a new pattern.

If you go to a point where no pattern information is input (first line of display shows “←PTN”), you can add rhythm

pattern information to that point.

NOTE

Keep in mind that the newly added rhythm pattern information will remain valid until the next point where rhythm pattern information is input.

To insert a new pattern within the rhythm song

Use the cursor left/right keys to move to the location at which you want to insert rhythm pattern data, and execute steps 4 - 7. The new rhythm pattern data will be inserted at the current location, and subsequent rhythm pattern data will be moved backward according to the length of that pattern.

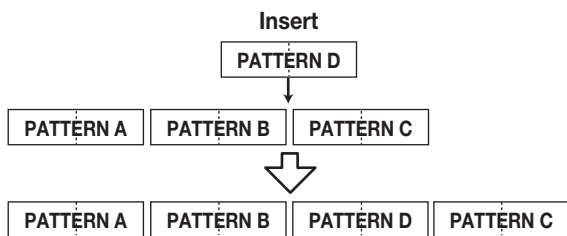

To delete rhythm pattern data

Use the cursor left/right keys to move to the location at which you want to erase rhythm pattern data, and press the [DELETE/ERASE] key. The rhythm pattern data will be deleted, and the display will change to "← PTN", indicating that the preceding pattern will continue playing.

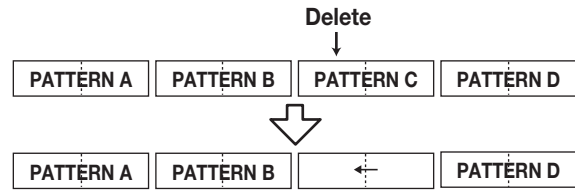

NOTE

Rhythm pattern information recorded at the beginning of the rhythm song cannot be deleted.

To delete a specific measure

Use the cursor left/right keys to move to the beginning of the measure that you want to delete. Repeatedly press the cursor up key to call up the indication "EV→". Then press the [DELETE/ERASE] key followed by the [ENTER] key. The current measure will be deleted, and subsequent rhythm pattern data will be moved forward. If you delete the first measure of a two-measure rhythm pattern, the second measure will remain, and the display will change to "← PTN".

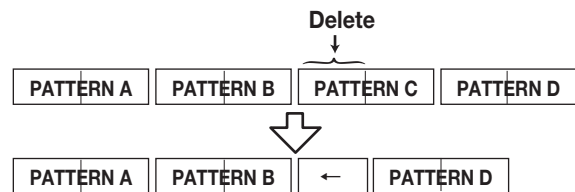

FAST input

The FAST (Formula Assisted Song Translator) method uses simple formulas to specify rhythm pattern playback from start to end. The status keys and the [SOLO] key in the fader

Serve to specify the pattern number and number of repetitions. The [DRUM] status key enters "0" and the 1 - 9 status keys enter the numbers "1" - "9".

Status key [DRUM]

Status keys 1 - 9

[SOLO] key

Serves to enter "x" (multiplication symbol), "+" (addition symbol), "(" (open bracket), and ")" (close bracket). The symbol changes with each push of the [SOLO] key.

section can be used for numeric input, as described below.

The basic rules for creating a rhythm pattern sequence are as follows.

• **Select the pattern**

Use status keys 1 - 9 and the [DRUM] key to enter a pattern number with up to 3 digits. The display shows the pattern number.

• **Line up patterns**

Use the “+” symbol to line up patterns. For example, entering **0 + 1 + 2** will result in the following play sequence.

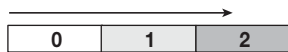

• **Repeat patterns**

Use the “x” symbol to specify pattern repetitions. As in regular arithmetic, multiplication symbols take precedence over addition symbols. For example, entering **0 + 1 x 2 + 2** will result in the following play sequence.



• **Link patterns**

Use the “(“ and “)” symbols to link a group of patterns for repetition. Strings enclosed by brackets are processed together as a unit. For example, entering **0 + 1 + 2 x 2 + (3 + 4) x 2** will result in the following play sequence.

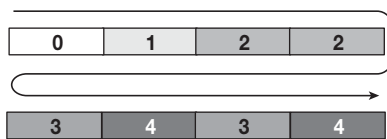

An example for creating the rhythm pattern sequence **0 → 1 → 2 → 3 → 2 → 3 → 4** is shown below.

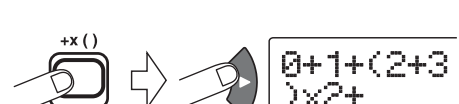
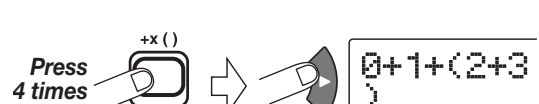
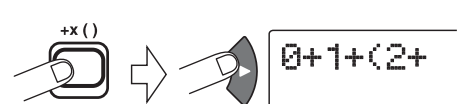
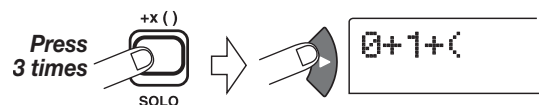
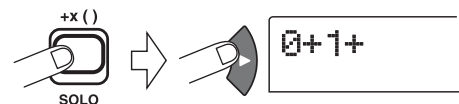
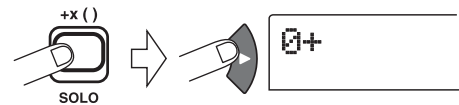

HINT

If the formula does not fit on two lines, the indication scrolls in steps of one character. If you use the cursor left/right keys

to move the input position, the line scrolls left and right accordingly.

After using the FAST input method to specify rhythm patterns for the entire song, press the [ENTER] key to write the rhythm patterns to the song.

NOTE

- The FAST method can only write a song in one go, from beginning to end. Writing only a partial song or editing the contents is not possible.
- If you wish to edit a rhythm song that was written with this method, edit the formula and then write the entire song again, or use step input.
- The FAST input method can also be used to program a phrase loop (→ p. 63).

1. In rhythm song mode ([SONG/PATTERN] key lit), verify that the [DRUM] key is lit.

2. Press the [EDIT] key.

The rhythm song edit mode appears.



3. Use the cursor left/right keys to bring up the indication "EDIT FAST" on the display, and press the [ENTER] key.

The input screen for FAST appears.



4. Use the status keys (1 - 9, [DRUM]) and the [SOLO] key to enter the formulas for creating the rhythm song.

The formula input principles are explained on page 84. If you make a mistake during input, correct it as follows.

Inserting a number/symbol

Use the cursor left/right keys to move to the position you want to insert and enter the new number/symbol.

Deleting a number/symbol

Use the cursor left/right keys to move to the position where you want to delete a number/symbol. Then press the [DELETE/ERASE] key. The number/symbol is deleted, and subsequent numbers and symbols are moved up.

5. When formula input is completed, press the [ENTER] key.

A screen for selecting the song to write to appears. Turn the dial to select the song.

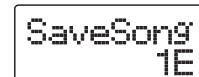

HINT

The second line of the display shows the rhythm song number. If an "E" is shown to the right of the number, the rhythm song is empty.

6. Press the [ENTER] key.

The write process is carried out and the unit returns to the condition of step 2. If you wish to check the input result, press the PLAY [▶] key.

HINT

- Formulas entered with the FAST method are saved for each project. If necessary, you can repeat steps 1 - 3 to call up the formulas, edit numbers or formulas, and write the song again.
- When you edit a song, the entire rhythm song is written again. Writing only a partial song or editing the contents is not possible.
- There is no difference in the completed rhythm song due to input method that was used, i.e. a song will be the same, regardless of whether it was created using step input or the FAST method. A song written with the FAST method can therefore be edited using step input.

7. To return to the main screen, press the [EXIT] key while the rhythm section is stopped.

NOTE

- If you play the rhythm song in this condition, the most recently selected drum kit and tempo will be used.
- To switch the drum kit, bring up the utility menu and select a new kit. (It is not possible to specify a drum kit for each rhythm song.)
- To specify tempo information for a particular rhythm song, enter the tempo information at the beginning (→ p. 86).

Inputting other event data

Once rhythm pattern information has been input to a rhythm song, you can add various other information such as tempo and rhythm section volume. Such data are called “event” information.

- 1. In rhythm song mode ([SONG/PATTERN] key lit), verify that the [DRUM] key is lit.**
- 2. Press the REC [●] key.**
Rhythm song step input becomes possible.
- 3. Press the cursor up key repeatedly to bring up the indication “EV→” on the display.**

This screen lets you check which event information is entered at the current point. The symbol after “EV→” (such as “Pt” or “TS”) denotes the type of event. Available events and their symbols are listed in the table below.

Type of event	Symbol	Content	Range
Ptn	Ptn	Rhythm pattern number	000 – 510
TimSig	TimSig	Time signature	1 – 8(1/4 – 8/4)
Tempo	Tempo	Tempo	40.0 – 250.0
DrVOL	DrVOL	Drum track volume	0 – 15

HINT

- If no tempo information is input for the rhythm song, the tempo currently set for the rhythm section will be used. To ensure that a rhythm song will always play with the same tempo, be sure to enter tempo information at the beginning of the song.
- If desired, you can also adjust the tempo while a song is playing by hitting the [TEMPO] key several times in succession. Check the display to verify that the desired tempo has been set.

- 4. Move to the location at which you want to input a new event.**

You can change the input location in the following three ways.

(1) Moving in steps of a measure

Use the cursor left/right keys to move to the beginning of the preceding or following measure.

(2) Specify the location in beats

Use the REW [◀◀]/FF [▶▶] keys to move to the beginning of the preceding or following beat.

(3) Specify the location in 16th note units

Repeatedly press the cursor up key to bring up the indication “EV→”, and turn the dial to move forward or backward in 12-tick (16th note) units. You can check the position using the counter display.

HINT

The current position is shown to the right of the counter in measures / beats / ticks.

- 5. Use the cursor up/down keys to select the type of event that you want to input.**

If the event you select here has been input at the current location, its value will be displayed. If there is no corresponding event, the display will indicate “←”. This means that the previously input event will apply.

- 6. Turn the dial to input the value.**

The event type “TimSig” can only be input in units of measures. When you turn the dial within a measure, the position automatically jumps to the start of the next measure, and the new event is input at that location.

NOTE

When you change the TimSig event, only the measure and beat division within the pattern changes. The duration of the entire rhythm pattern does not change.

- 7. Input the other events in the same way.**

If you make a mistake or want to change the information, the events can be edited in the following ways.

- **To change an event setting**

Display the event you want to change, and turn the dial to alter the setting.

- **To delete event information**

Display the event you want to delete, and press the [DELETE/ERASE] key. When an event was deleted, the preceding event of the same type will remain active until the next point where information for the same event type is input.

8. When you have finished, press the STOP [■] key.

The unit returns to the rhythm song screen. To return to the main screen, press the [EXIT] key.

Playing a rhythm song

This section explains how to play the rhythm song that you created by inputting rhythm pattern data and tempo data.

1. In rhythm song mode ([SONG/PATTERN] key lit), verify that the [DRUM] key is lit.

The recorder section and rhythm section are not linked.



HINT

From the main screen, it is also possible to directly call up the above display by repeatedly pressing the [SONG/PATTERN] key. When you do this, the [DRUM] key flashes. This indicates that the recorder and rhythm section remain synchronized.

2. Turn the dial to select a rhythm song to play.

3. Press the PLAY [▶] key.

The rhythm song will begin playing.

HINT

During playback of a rhythm song, the display shows information about the rhythm pattern number and other information at the current location.

4. To stop the rhythm song, press the STOP [■] key.

5. To return to the main screen, press the [EXIT] key.

The [DRUM] key goes out.

HINT

By pressing the PLAY [▶] key after bringing up the main screen, you can start playback of the recorder section at the same time.

Editing a rhythm song

This section explains how to edit a rhythm song that you created.

Copying a specific region of measures

Part of a rhythm song can be copied in measures and inserted into another location. This is convenient when you want to repeat a portion of a rhythm song.

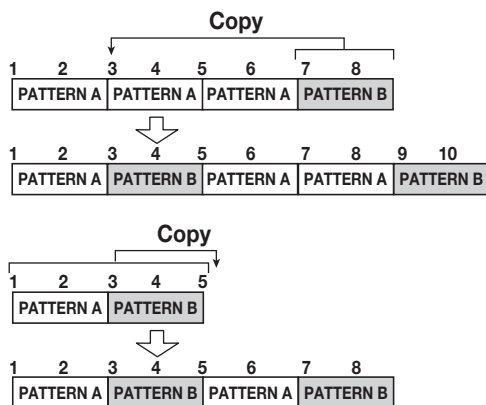

1. In rhythm song mode ([SONG/PATTERN] key lit), press the [DRUM] key so that it is lit.

```
SongNo0
SONG000
```

2. Turn the dial to select the rhythm song to be edited.
3. Press the REC [●] key.
4. Press the [INSERT/COPY] key two times.

The screen for selecting the copy start point appears.

```
COPY
START
MEASURE BEAT TICK
001 1 0
```

5. Turn the dial to select the copy source start measure, and press the [ENTER] key.

The screen for selecting the copy end point appears.

```
COPY
END
MEASURE BEAT TICK
003 1 0
```

6. Turn the dial to select the copy source end measure, and press the [ENTER] key.

The screen for selecting the copy destination point appears.

```
COPY
TO
MEASURE BEAT TICK
007 1 0
```

7. Turn the dial to select the copy destination start measure.

8. To execute the copy process, press the [ENTER] key. To cancel, press the [EXIT] key.

When you press the [ENTER] key, the copy will be executed, and the display returns to the screen of step 3. If the copy destination contains any event information, this will be overwritten.

HINT

If the copied region extends beyond the end of the rhythm song, the rhythm song will be lengthened automatically.

9. Press the STOP [■] key.

The unit returns to the rhythm song screen.

Copying a rhythm song

You can copy the contents of any rhythm song in a project to any other rhythm song. This is useful if you want to create variations of a song.

1. In rhythm song mode ([SONG/PATTERN] key lit), press the [DRUM] key so that it is lit.

2. Turn the dial to select the rhythm song to be copied.

3. Press the [INSERT/COPY] key.

The screen for selecting the number of the copy destination

rhythm song appears.

```
COPY
1→ 2E
```

4. Turn the dial to select the copy destination rhythm song, and press the [ENTER] key.

● NOTE ●

When you execute the copy, the contents of the destination rhythm song will be completely erased and overwritten by the copy source rhythm song. Take care not to accidentally erase a song that you wish to keep.

5. To execute the copy process, press the [ENTER] key. To cancel, press the [EXIT] key.

When you press the [ENTER] key, the copy will be executed, and the display returns to the rhythm song screen.

Erasing a rhythm song

This section explains how to erase a specific rhythm song, resetting it to a blank state.

1. In rhythm song mode ([SONG/PATTERN] key lit), press the [DRUM] key so that it is lit.
2. Turn the dial to select the rhythm song to be erased.
3. Press the [DELETE/ERASE] key.

The indication “DELETE SURE?” appears on the display.

● NOTE ●

Once you erase the rhythm song, it cannot be recovered. Use this operation with care.

4. Press the [ENTER] key to erase the rhythm song, or press the [EXIT] key to cancel.

If you press the [ENTER] key, the rhythm song will be erased and the display returns to the rhythm song screen.

Assigning a name to a rhythm song

You can edit the name of any rhythm song as follows.

1. In rhythm song mode ([SONG/PATTERN] key lit), press the [DRUM] key so that it is lit.
2. Turn the dial to select the rhythm song to be renamed.
3. Press the [EDIT] key.

The rhythm song edit menu appears on the display.

```
EDIT
Name
```

4. Use the cursor left/right keys to bring up the indication “EDIT Name” on the display, and press the [ENTER] key.

The rhythm song name is shown, and the first character flashes.

```
Name
Song000
```

5. Use the cursor left/right keys to move the flashing position to the character you want to change, and turn the dial to select a character.

For information on available characters, refer to page 34.

● HINT ●

When you enter information into an empty rhythm song, the name “Songxxx” (where xxx is the rhythm song number) is automatically assigned.

6. When the name has been input, press the [EXIT] key.

The rhythm song name is changed, and the display returns to the rhythm song edit menu.

7. To return to the main screen, press the [EXIT] key several times.

Creating an original rhythm pattern

This section explains how you can create your own original rhythm patterns. There are two ways of creating a rhythm pattern: step input where play is stopped and you enter the sounds one by one, and real-time input where you record your play on the status keys or a MIDI keyboard.

Preparations

Before starting to record, you must select a rhythm pattern number for input, and set the quantize value (shortest unit for recording), number of measures and beats, drum kit number etc.

1. From the main screen, verify that the [SONG/PATTERN] key is out.

If the key is lit, press it so that it goes out. When the [SONG/PATTERN] key is out, the rhythm pattern mode for playing or creating rhythm patterns is selected as operation mode for the rhythm section.

2. Press the [DRUM] key so that it is lit.

In this condition, the rhythm section and recorder section are not linked.

3. Turn the dial to select an empty rhythm pattern.

The indication “EMPTY” appears on the display when an empty pattern is selected.

```
---#510
EMPTY
```

HINT

If there is no empty rhythm pattern, erase an unneeded pattern (→ p. 96).

4. Press the [EDIT] key.

The rhythm pattern edit menu appears.

```
EDIT
Quantize
```

5. Verify that the indication “EDIT Quantize” is shown on the display, and press the [ENTER] key. (If anything else is shown, use the cursor left/right keys to bring up “EDIT Quantize”.)

The quantize value is the smallest unit for real-time input/step input of a pattern. The default setting is “16” (a sixteenth note). In this condition, each play instance is stored in the rhythm pattern as a sixteenth note.

```
Quantize
16
```

6. Turn the dial to select the desired quantize value.

The following settings are available.

- 4 Quarter note
- 8 Eighth note
- 12 Eighth triplet note
- 16 Sixteenth note
- 24 Sixteenth triplet note
- 32 Thirty-second note
- Hi 1 tick (quantize function off)

HINT

- 1 tick is 1/48 of quarter note
- The quantization setting applies to all rhythm patterns.
- When using step input to enter a rhythm pattern, the quantize value can be changed at any time, and the above operation is not necessary.

7. When the setting has been made, press the [EXIT] key.

The new quantization setting is accepted, and the unit returns to the rhythm pattern edit menu.

8. To set the rhythm pattern time signature, use the cursor left/right keys to bring up the indication “EDIT TimSig” on the display, and press the [ENTER] key.

The current time signature setting appears on the display.

```
TimSig
4 ← 4/4 beat
```

- 9.** Turn the dial to select the beat. The setting range is 1 - 8 (1/4 - 8/4). Then press the [EXIT] key.

The rhythm pattern edit menu reappears.

- 10.** To set the length (number of measures) of the rhythm pattern, use the cursor left/right keys to select the indication "EDIT BarLen", and press the [ENTER] key.

The current length of the pattern is shown as number of measures.

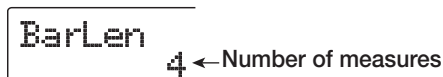

- 11.** Turn the dial to select the desired setting, and press the [EXIT] key.

The setting range is 1 - 99.

- 12.** Press the [EXIT] key twice. The display returns to the screen of step 3.

velocity value, use the "Velocity" item of the rhythm utility menu (→ p. 97).

If you only press the PLAY [▶] key, no playing information is entered, but the step advances by an interval corresponding to the current quantize value.

- 1.** In rhythm pattern mode ([SONG/PATTERN] key out), press the [DRUM] key so that it is lit.

- 2.** Turn the dial to select an empty rhythm pattern number.

- 3.** Press the REC [●] key.

The display changes as follows, and step input becomes possible.

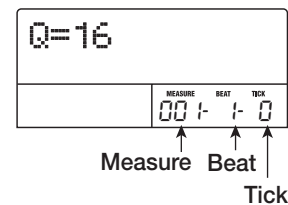

On the first line of the display, "Q = xx" shows the quantize value (possible values for xx: 4 - 32, Hi). In the bottom right of the display, the current position is shown in measures/beats/ticks.

- 4.** Use the cursor up/down keys to select the quantize value (length) of the note you want to enter (→ P. 90).

The quantize value that you select here becomes the length of one step during step recording. You can use the cursor up/down keys at any time to change the quantize setting.

HINT

The quantize value setting is linked to the quantize setting for real-time input. If you change one setting, the other will also change.

Step input

For step input, you enter each note separately, while the MRS-802 is in the stop condition.

For rhythm pattern step input, you specify the step length (interval to next note or rest) using the quantize value. Then you use the status keys 1 - 8 and the PLAY [▶] key to enter notes and rests.

When you press a status key to select a sound and then press the PLAY [▶] key, playing information is entered at that point, and the step advances by an interval corresponding to the current quantize value.

NOTE

If you use the status keys for input, the recorded note intensity (velocity value) will be constant. To change the

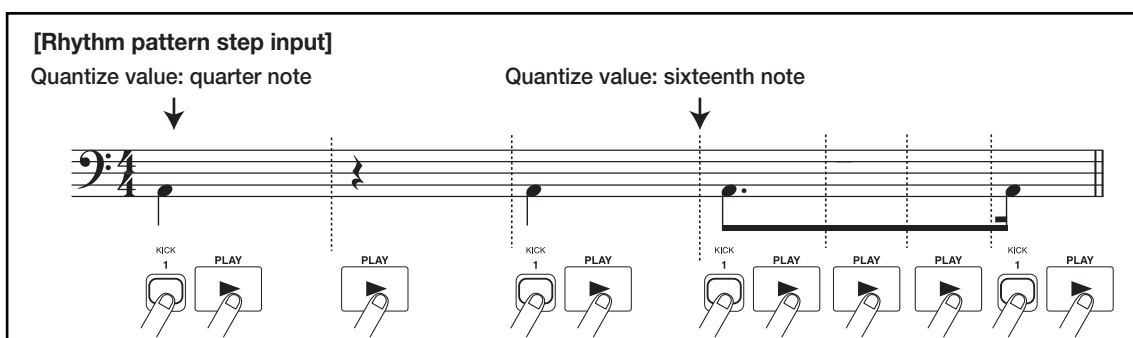

5. To enter a note, hit the status key corresponding to the note, and then press the PLAY [▶] key.

The note is recorded, and the unit advances by one step, corresponding to the quantize value set in step 4.

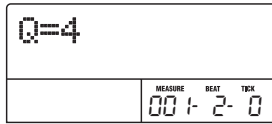

HINT

If you hit several status keys during input, multiple sounds will be recorded at the same position.

6. To enter a rest, press only the PLAY [▶] key.

If you press the PLAY [▶] key by itself, the position advances by one step (duration of quantize value) but no play information is recorded.

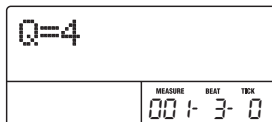

7. To switch the drum sounds assigned to the status keys 1 - 8, press the [SOLO] key and then turn the dial to select the instrument bank number.

A combination of eight sounds assigned to the status keys is called an "instrument bank". For one drum kit, you can use up to three instrument banks. (For information on which sounds are assigned to the status keys in the various banks, see page 161.)

If you press the [SOLO] key while the [DRUM] key is lit, the number of the currently selected instrument bank is shown.

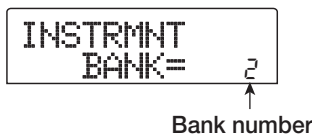

When you turn the dial to change the instrument bank number, the drum sounds assigned to status keys 1 - 8 are switched. To return to the original screen, press the [EXIT] key.

HINT

- For most drum kits, instrument bank 1 contains the basic drum sound. (The sound name is indicated by the letter

printed above the status keys 1 - 8.) When starting out with an empty rhythm pattern, selecting this bank is convenient.

- Depending on which drum kit is currently selected, the sound type assigned to status keys 1 - 8 may be different. Switch the drum kit if necessary (→P. 79).

8. Repeat steps 5 - 7 while changing the step length as necessary, to enter the desired rhythm pattern.

When you reach the end of the pattern, the unit automatically returns to the first measure, letting you enter more instrument sounds.

9. To edit the recorded contents after step input, proceed as follows.

- To erase the performance of a specific drum sound**
When you advance the record position with the PLAY [▶] key, the status key that is input at the current position lights up. By holding down the [DELETE/ERASE] key and pressing the lit key, you can erase the sound of that key. The key goes out, and the playing information is erased from the rhythm pattern.

NOTE

- When searching for a note to erase, set the quantize value to the same value as the smallest value used during recording, or to a smaller value. Otherwise the start of a note may be missed.
- Make sure that the sound to be erased is part of the currently selected instrument bank.

10. When you have finished step input, press the STOP [■] key.

The unit returns to the rhythm pattern screen. Press the PLAY [▶] key to hear the pattern that you recorded.

11. To terminate pattern recording and return to the main screen, press the [EXIT] key.

Real-time input

For real-time input, you use the status keys on the top panel or an external MIDI keyboard or similar to record the pattern while listening to the actual drum sounds.

This section explains how to use the status keys 1 - 8 on the MRS-802 to input a rhythm pattern in real time.

1. In rhythm pattern mode ([SONG/PATTERN] key out), press the [DRUM] key so that it is lit.

While the [DRUM] key is lit, pressing one of the status keys 1 - 8 produces the assigned drum sound.

NOTE

If you use the status keys 1 - 8 for real-time input, the intensity of producing a note (velocity value) is constant. When wishing to change the velocity, call up the "Velocity" item of the rhythm utility menu and select SOFT, MEDIUM, or LOUD. (The default setting is MEDIUM.)

2. Turn the dial to select an empty rhythm pattern number.

3. Press the [SOLO] key and turn the dial to select the instrument bank number.



Turning the dial to change the instrument bank number will switch the sound that is produced by each of the status keys 1 - 8. To return to the original display, press the [EXIT] key.

4. Press the PLAY [▶] key while holding down the REC [●] key.

You will hear a pre-count of four clicks (1 measure). When the pre-count ends, rhythm pattern recording will begin. The number of pre-count measures and the metronome volume can be changed as desired (→ P. 97).

5. While listening to the metronome, hit the status keys.

Your performance on the keys will be recorded according to the quantize setting (→ p. 90). When you reach the end of the pattern, the unit automatically returns to the first measure, and real-time input continues.

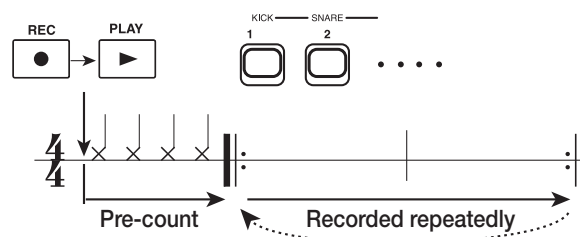

6. To change the drum sound bank assigned to status keys 1 - 8, press the [SOLO] key and then turn the dial to select the instrument bank number.

If you press the REC [●] key during recording, the REC [●] key flashes and recording is paused. You can now check the sounds assigned to the status keys 1 - 8. Press the REC [●] key once more to resume recording.

7. To edit the recorded contents during real-time input, proceed as follows.

• To erase the performance of a specific drum sound

While holding down the [DELETE/ERASE] key, press the status key whose drum sound you want erase. While you are holding down both keys, the sound is erased from the rhythm pattern.

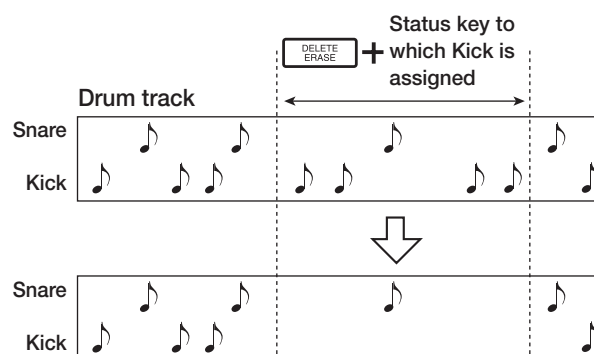

• To erase the play contents for all drum sounds

While holding down the [DELETE/ERASE] key, press the [DRUM] status key. While you are holding down both keys, the drum sound performance is erased from the rhythm section.

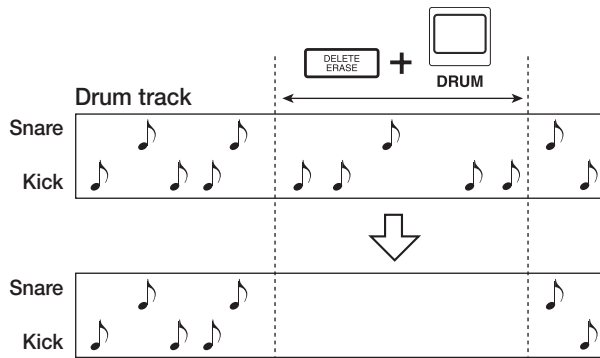

8. When you have finished recording, press the STOP [■] key.

Pattern recording will stop, and the unit returns to the rhythm pattern screen. Press the PLAY [▶] key to hear the pattern that you recorded.

When you select an empty pattern and record it, the pattern name "Patxxx" (where xxx is the pattern number) is automatically assigned. You can edit this pattern name as necessary (→ p. 95).

9. To terminate pattern recording and return to the main screen, press the [EXIT] key several times.

HINT

- If you use a MIDI keyboard connected to the MIDI IN connector for real-time input, you can add intensity information for each note. (For information on which drum sound corresponds to which note number, see p. 161.)
- When the MRS-802 is in the default condition, the MIDI receive channel for the drum kit is set to 10. For real-time input using a MIDI keyboard, set the MIDI send channel of the keyboard also to 10.
- The MIDI receive channel for the drum kit can be changed if desired (→ p. 130).
- After changing the quantize value (→ p. 90), you can restart real-time input. In this case, the timing of notes that have already been input does not change. For example, you could record hi-hat play with 32nd notes and then switch to 16th notes for snare and kick drum input.

Editing a rhythm pattern

This section explains how to edit an existing rhythm pattern.

Adjusting the drum volume balance

The volume of the drum kit can be adjusted with the [DRUM] fader in the mixer section. If necessary, the volume level of the drum kit can also be individually programmed for each rhythm pattern.

1. In rhythm pattern mode ([SONG/PATTERN] key out), press the [DRUM] key so that it is lit.

2. Press the [EDIT] key.

The rhythm pattern edit menu appears on the display.

```
EDIT
Quantize
```

3. Use the cursor left/right keys to bring up the indication "EDIT Dr Level" on the display, and press the [ENTER] key.

This screen allows you to specify the rhythm section volume.

```
Dr Level
  15
```

The display shows the current volume setting (0 - 15).

4. Turn the dial to select the desired setting, and then press the [EXIT] key.

The setting is accepted, and the rhythm pattern edit menu appears again.

5. To return to the main screen, press the [EXIT] key several times.

Copying a rhythm pattern

You can copy a rhythm pattern to another pattern number. This is useful if you want to create variations of a rhythm pattern.

1. In rhythm pattern mode ([SONG/PATTERN] key out), press the [DRUM] key so that it is lit.
2. Turn the dial to select the number of the rhythm pattern to use as copy source.
3. Press the [INSERT/COPY] key.

A screen for selecting the copy destination appears. An empty pattern is listed as “E”.

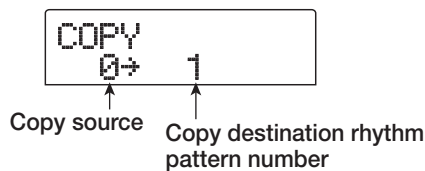

4. Turn the dial to select the number of the rhythm pattern to use as copy destination, and press the [ENTER] key.

The indication “SURE?” appears on the display.

5. To execute the copy process, press the [ENTER] key once more. To cancel, press the [EXIT] key.

When you press the [ENTER] key, the copy will be executed, and the display returns to the rhythm pattern selection screen, with the copy destination rhythm pattern as the selected pattern.

If the copy destination rhythm pattern contains any information, this will be overwritten.

6. To return to the main screen, press the [EXIT] key several times.

Editing the name of a rhythm pattern

This section explains how to edit the name of a rhythm pattern.

1. In rhythm pattern mode ([SONG/PATTERN] key out), press the [DRUM] key so that it is lit.
2. Turn the dial to select the number of the rhythm pattern whose name you want to edit.
3. Press the [EDIT] key.

The rhythm pattern edit menu appears on the display.



4. Use the cursor left/right keys to bring up the indication “EDIT Name” on the display, and press the [ENTER] key.

The rhythm pattern name is shown, and the first character flashes.



5. Use the cursor left/right keys to move the flashing position to the character you want to change, and turn the dial to select a character.

For information on available characters, refer to page 34.

HINT

When you select an empty pattern and record it, the pattern name “Patxxx” (where xxx is the pattern number) is automatically assigned.

6. When you have finished editing the name, press the [EXIT] key.

The rhythm pattern name will be updated, and the unit returns to the rhythm pattern edit menu.

7. To return to the main screen, press the [EXIT] key several times.

Erasing a rhythm pattern

This section explains how to erase all data from a specified rhythm pattern, returning it to a blank state.

- 1.** In rhythm pattern mode ([SONG/PATTERN] key out), press the [DRUM] key so that it is lit.
- 2.** Turn the dial to select the rhythm pattern to erase.
If the [SONG/PATTERN] key is lit, press it so that it goes out.
- 3.** Press the [DELETE/ERASE] key.
The indication “DELETE SURE?” appears on the display.
- 4.** Press the [ENTER] key to erase the rhythm pattern, or press the [EXIT] key to cancel.

When you press the [ENTER] key, the contents of the pattern will be erased, and the display returns to the rhythm pattern selection screen, with the now empty rhythm pattern as the selected pattern.



---#000
EMPTY

- 5.** To return to the main screen, press the [EXIT] key several times.

Importing rhythm patterns and rhythm songs from another project

This section explains how to import rhythm pattern data and rhythm song data from another project that was saved on the hard disk.

- 1.** From the main screen, press the [DRUM] key so that the key lights up.
- 2.** Press the [UTILITY] key in the display section.
The rhythm utility menu for various rhythm section settings appears.
- 3.** Use the cursor left/right keys to bring up the indication “UTILITY Import” on the display, and press the [ENTER] key.

The display shows the following screen.

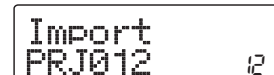

Import
PRJ012 12

- 4.** Turn the dial to select the project from which to import data, and press the [ENTER] key.
The indication “Import SURE?” appears on the display.
- 5.** Press the [ENTER] key.
The data are imported into the current project. When the process is completed, the screen of step 2 appears again.
- 6.** To return to the main screen, press the [EXIT] key several times.

Editing various settings of the rhythm section

This section explains how to edit various settings such as pre-count and metronome volume that affect the entire rhythm section.

Basic procedure

The basic procedure for editing the rhythm section settings is the same for most items, as described below.

HINT

You can use the same procedure in either rhythm pattern mode or rhythm song mode.

1. From the main screen, press the [DRUM] key so that the key lights up.

The rhythm section and recorder section are not linked.

2. Press the [UTILITY] key in the display section.

The rhythm utility menu for various rhythm section settings appears.

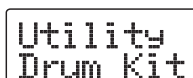

A screenshot of a digital display showing the text "Utility" on the top line and "Drum Kit" on the bottom line, both in a monospaced font.

3. Use the cursor left/right keys to select one of the following items to edit, and press the [ENTER] key.

- **Drum Kit**

Change the drum kit that is used for rhythm pattern and rhythm song playback (→ p. 79).

- **Count**

Change the length of the pre-count.

- **ClickVol**

Change the volume level of the metronome.

- **Velocity**

Change the velocity value for input of notes with the status keys.

- **MIDI**

Make MIDI-related settings (→ p. 129).

- **Import**

Import rhythm patterns and the rhythm song from a project saved on the hard disk (→ p. 96).

- **Memory**

Check the remaining amount of rhythm pattern and rhythm song memory.

5. Turn the dial to edit the setting.

The screen display and operation will be different for each item. For details refer to the sections that follow.

6. When the setting procedure is complete, press the [EXIT] key several times.

The unit returns to the main screen.

Changing the length of the pre-count

You can change the length of the pre-count that is heard when you record a rhythm pattern. Select "Count" from the rhythm utility menu and press the [ENTER] key. Then turn the dial to choose one of these settings.

- **OFF**

The pre-count is turned off.

- **1**

A one-measure pre-count is heard (default setting).

- **2**

A two-measure pre-count is heard.

- **KEY**

The pre-count is off, and recording will begin at the instant you play a key on the MIDI keyboard or press a status key.

Changing the metronome volume

You can change the volume of the metronome that is heard when you record a rhythm pattern in real time. Select “ClickVol” from the rhythm utility menu and press the [ENTER] key. Then turn the dial to choose the settings (OFF, 1 - 15).

Specifying the sound dynamics

You can specify the volume that is produced when you use the status keys to input notes. Select “Velocity” from the rhythm utility menu and press the [ENTER] key. Then turn the dial to choose the SOFT, MEDIUM, or LOUD setting.

When you are using a MIDI keyboard to input notes instead of the status keys, this setting has no effect. The entered velocity value will be recorded.

Checking the remaining amount of memory

The remaining amount of recording memory for rhythm patterns and the rhythm song will be displayed as a percentage (%). Select “Memory” from the rhythm utility menu and press the [ENTER] key. This screen is for display only. There is no setting that can be edited.

Reference [Effects]

This section explains the functions and operation of the effect section built into the MRS-802.

About the effects

The MRS-802 has two types of effects, “insert effects” and “send/return effects”. The two types can be used simultaneously. The two types of effect are described below in detail.

Insert effect

The insert effect is used by inserting it into a specific signal route. You can select one of the following locations for inserting the effect.

- (1) Input mixer
- (2) Any channel of the track mixer
- (3) Immediately before the [MASTER] fader

For example if you insert the effect into the input mixer, the input signal is directly processed by the effect and the result

is recorded on a track of the recorder. Alternatively, if you insert the effect into a channel of the track mixer, the effect processes the playback signal from the audio track or drum kit.

By selecting a point immediately before the [MASTER] fader, you can use the effect to process the final mix before recording on the master track.

Send/return effects

The send/return effects are internally connected to the send/return of the mixer section. The MRS-802 has two send/return effects, reverb (REVERB) and chorus/delay (CHORUS/DELAY), which can be used simultaneously.

The send levels of the input mixer or track mixer adjust the effect depth of the send/return effects. Raising the send level will send the corresponding signal to the input of the effect, and the signal processed by the effect will be returned immediately before the [MASTER] fader, and mixed with the other signals.

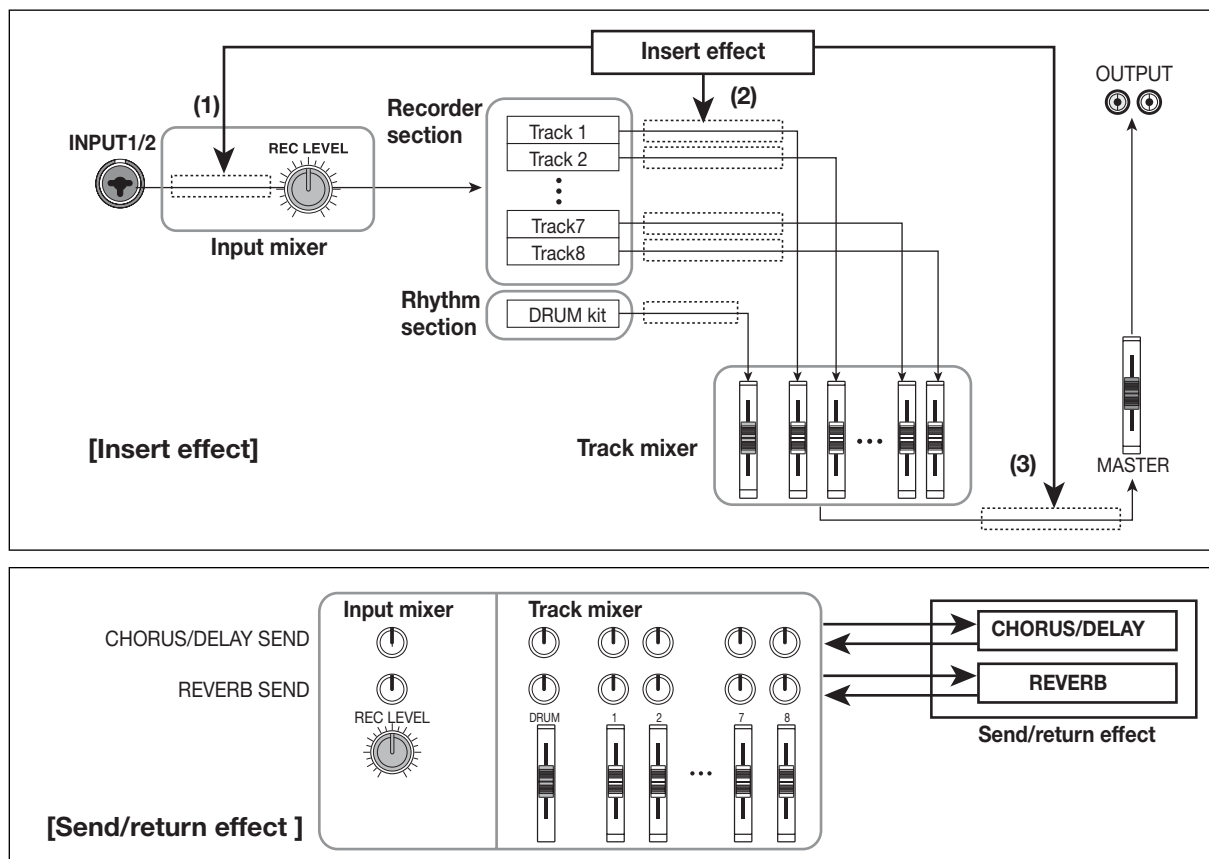

Using the insert effect

This section explains how to select the insert point for the insert effect, how to select a patch, and how to edit the patch.

About insert effect patches

The insert effect is a multi-effect unit that contains a number of single effects such as compressor, distortion, and delay, connected in series. Each of these separate effects is called an "effect module".

For the insert effect, you can use up to six effect modules simultaneously. A combination of such effect modules is called an "algorithm".

The MRS-802 incorporates the following algorithms.

- **CLEAN**
- **DIST**
- **ACO/BASS SIM**
- **BASS**

These algorithms are for recording guitar/bass.

- **MIC**

An algorithm for vocals or microphone recording.

- **Dual MIC**

An algorithm for two entirely separate mono input and mono output channels.

- **LINE**

An algorithm mainly for recording line-level output instruments such as synthesizer or electric piano.

- **MASTERING**

An algorithm for processing a stereo mix signal, such as during mixdown.

The arrangement of the effect modules and the signal flow for each algorithm is shown in the diagram below.

HINT

There are three types of algorithms: mono input/stereo output, stereo input/stereo output, and mono input x 2/mono output x 2. This difference will affect the signal flow when the insert effect is inserted. For details, refer to p. 102.

Each effect module comprises various parameters that adjust the effect type and the effect depth. Settings for the parameters of each effect module and an overall volume setting (patch level) are collectively referred to as a "patch".

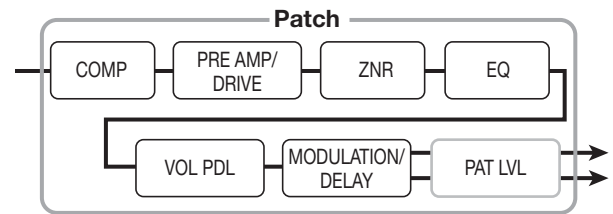

A newly created project contains 190 patches, and these patches are organized according to the eight algorithms. You can instantly switch insert effect settings simply by selecting the appropriate algorithm, and then selecting a patch.

The table below shows the algorithm types and the patch numbers for each type.

Algorithm	Effect module arrangement	Input/output type
CLEAN DIST ACO/BASS SIM BASS	COMP → PRE AMP/DRIVE → ZNR → EQ → VOL PDL → MODULATION/DELAY	Mono → stereo
MIC	COMP/LIM → MIC PRE+DE-ESSER → ZNR → EQ → VOL PDL → MODULATION/DELAY	Mono → stereo
DUAL MIC	COMP/LIM → MIC PRE → ZNR → EQ → VOL PDL → DOUBLING COMP/LIM → MIC PRE → ZNR → EQ → VOL PDL → DOUBLING	Mono → mono x 2
LINE	COMP/LIM → ISOLATOR → ZNR → EQ → VOL PDL → MODULATION/DELAY	Stereo → stereo
MASTERING	3BAND COMP/LO-FI → NORMALIZE → ZNR → EQ → VOL PDL → DIMENSION/RESONANCE	

Algorithm	Patch number	Algorithm	Patch number
CLEAN	0 – 24	MIC	0 – 49
DIST	0 – 44	DUAL MIC	0 – 49
ACO/BASS SIM	0 – 14	LINE	0 – 49
BASS	0 – 14	MASTERING	0 – 29

Changing the insert location of the insert effect

When the project is in its initial state, the insert effect is applied to the input mixer. However, you may change the insert location as necessary. The procedure is as follows.

1. From the main screen, press the [INPUT SOURCE] key in the effect section.

The currently selected insert location appears on the display.

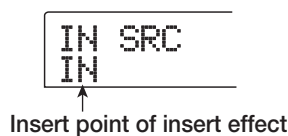

The following points are available.

- **IN**
Input mixer (default setting)
- **DRUM**
Drum kit output
- **TR1 - TR8**
Track 1 - 8 output
- **TR1/2, TR3/4, TR5/6, TR7/8**
Track 1/2, 3/4, 5/6, 7/8 output
- **MASTER**
Immediately before [MASTER] fader

2. Use the dial to select the insert location.

HINT

While the display of step 1 is shown, you can select the insert point by pressing the [INPUT 1]/[INPUT 2] keys and the status keys. To select the track pairs 1/2, 3/4, 5/6, and 7/8, press two status keys simultaneously.

3. When the insert point has been selected, press the [EXIT] key.

The unit returns to the main screen.

HINT

When the insert effect is applied to a point other than the input mixer, the [INPUT SOURCE] key will be lit at the main screen.

Selecting the patch for the insert effect

This section explains how to select the patch for the insert effect.

1. Press the [INSERT EFFECT] keys in the display section.

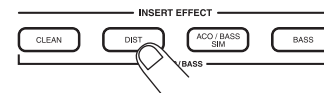

The key lights up, and the display indicates the patch currently selected for this algorithm.

To select a patch for the insert effect, start by selecting the algorithm (effect module combination). When you press the [INSERT EFFECT] keys, the first line of the display shows “INSERT” and the second line shows the patch for the insert effect in this algorithm.

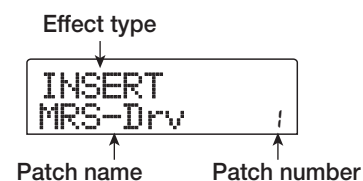

HINT

When the send/return effect was operated, the first line of the display shows “SEND REV” or “SEND CHO”.

2. Use the PATCH SELECT [▲]/[▼] keys or turn the dial to select the patch.

The selected patch becomes active immediately.

HINT

The indication “EMPTY” appears instead of the patch name if the patch is empty. Selecting this will have no effect.

3. If you want to temporarily turn the insert effect off, press the [BYPASS/TUNER] key in the effect section.

The [BYPASS/TUNER] key lights up, and the insert effect is bypassed. Pressing the [BYPASS/TUNER] key once more enables the effect again.

HINT

Pressing the [ENTER] key in the bypass condition activates the tuner function (→ p. 136).

4. To return to the main screen, press the [EXIT] key.

The flow of the signal that passes through the insert effect will change as shown below, depending on the insert location, the number of input signal channels, and the input/output type of the insert effect. (“M → S” indicates mono input/stereo output, “S → S” indicates stereo input/output, “Dual” indicates mono input/output x 2.)

When inserted into the input mixer

• Recording on mono tracks (tracks 1 - 8)

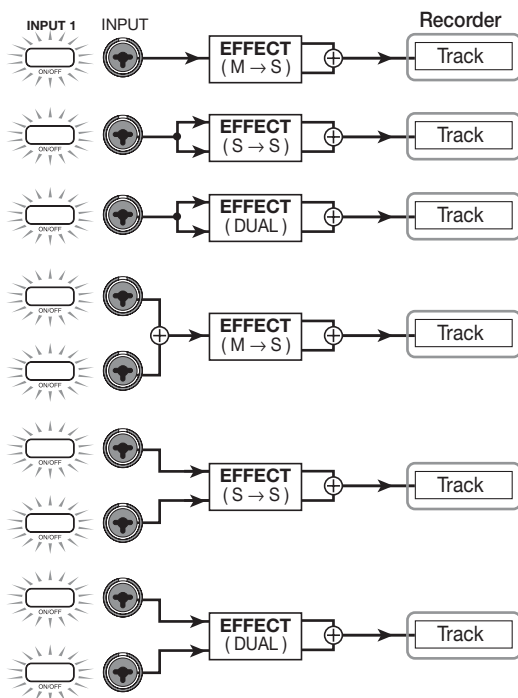

• Recording on two mono tracks (1/2, 3/4, 5/6, 7/8)

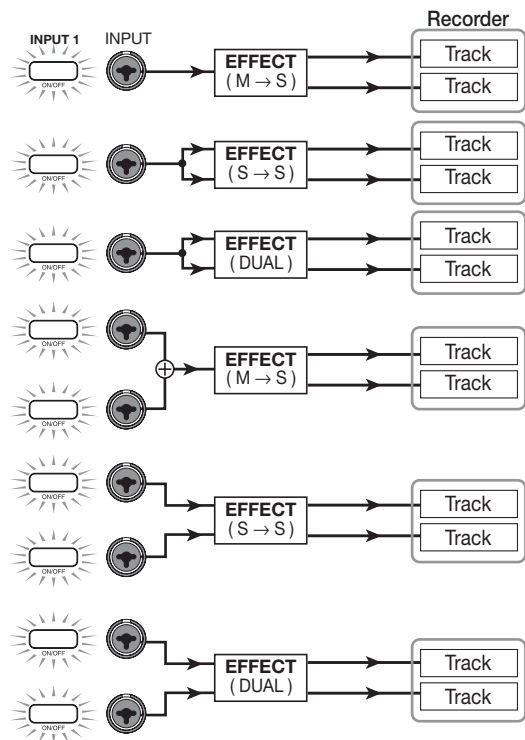

HINT

When no recording track is selected, the output signal of the insert effect is sent to a point directly before the [MASTER] fader and mixed with the track mixer signal.

When inserted into the track mixer

• Mono track (track 1 - 8) selected as insert location

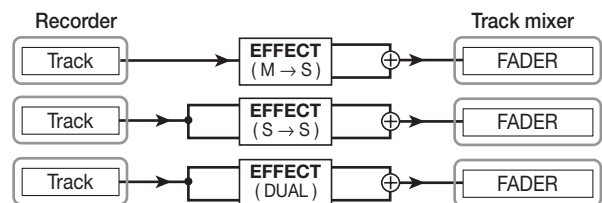

- Two mono tracks (1/2, 3/4, 5/6, 7/8) or drum track selected as insert location

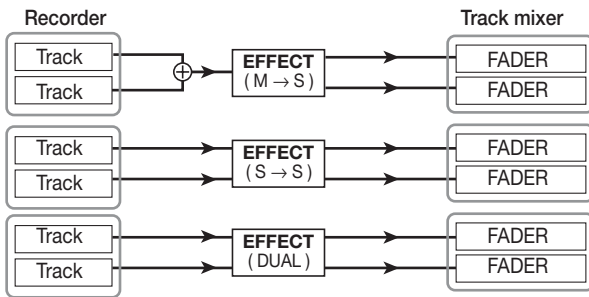

■ When inserted immediately before [MASTER] fader

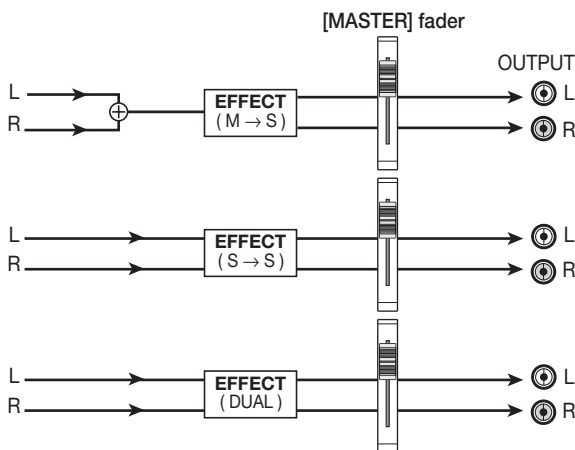

Editing the insert effect patch

The effect modules of the insert effect have various “effect parameters” that can be adjusted to make detailed changes to the character of the effect. By editing the effect parameters, you can obtain the desired tone or effect.

For some effect modules, you can change the “effect type”. For example in the MIC algorithm, the MODULATION/DELAY effect module provides ten effect types such as chorus, flanger, and phaser, and use any one of these.

When you change the effect type, the effect parameters will also change.

Effect module	MODULATION/DELAY		
Effect type	CHORUS	FLANGER	PHASER
Effect parameters	DEPTH RATE MIX	DEPTH RATE FB	POSITION RATE COLOR

This section explains how to edit the effect type and effect parameters for the currently selected patch.

1. Use the [INSERT EFFECT] keys to select an algorithm, and use the PATCH SELECT [▲]/[▼] keys or the dial to select the patch that you want to edit.

It is not possible to change the algorithm of a patch. For this reason, you must first begin by selecting a patch that uses the desired algorithm, even when you want to create a patch from scratch.

HINT

The indication “EMPTY” appears instead of the patch name if the patch is empty. To create a patch from scratch, select an empty patch in the desired algorithm.

2. Press the [EDIT] key.

The first line of the display will show “EDIT”. This indicates that the patch can now be edited.

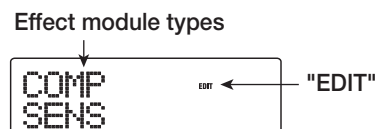

3. Use the cursor left/right keys to select the effect module that you want to edit.

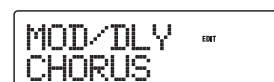

The first line of the display shows the following indications for each effect module.

Algorithm	Module/Display				
CLEAN DIST ACO/BASS SIM BASS	COMP → COMP	PRE/DRV → PRE AMP/DRIVE	3BandEQ → EQ	MOD/DLY → MODULATION/DELAY	TOTAL → ZNR, VOL PDL, PAT LVL
MIC	COMP/LIM → COMP/LIM	MIC PRE → MICPRE+DE-ESSER	3BandEQ → EQ	MOD/DLY → MODULATION/DELAY	TOTAL → ZNR, VOL PDL, PAT LVL
DUAL MIC	COMP Lch → COMP/LIM	MicPre L → MICPRE	EQ Lch → EQ	DOUBLE L → DOUBLING	TOTAL → ZNR, VOL PDL, PAT LVL
LINE	COMP/LIM → COMP/LIM	ISOLATOR → ISOLATOR	3BandEQ → EQ	MOD/DLY → MODULATION/DELAY	TOTAL → ZNR, VOL PDL, PAT LVL
MASTERING	CMP/LoFi → 3BAND COMP/ Lo-Fi	NORMLZR → NORMALIZER	3BandEQ → EQ	DIM/RESO → DIMENSION/ RESONANCE	TOTAL → ZNR, VOL PDL, PAT LVL

NOTE

The table above shows the condition when the effect module is On. When the effect module is Off, the second line of the display shows “-OFF-”.



4. If you want to switch the effect type for the selected module, turn the dial to select the desired effect type.

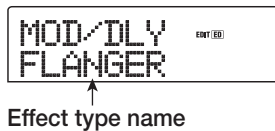

HINT

- If the contents of a patch have been edited, the “EDIT” indicator in the upper part of the display will change to “EDITED”.
- If “TOTAL” is shown on the display, you can use the cursor up/down keys to select PAT LVL, ZNR, or VOL PDL.

NOTE

Some effect modules have only one effect type. For such modules, there will be no screen for selecting the effect type.

5. Use the cursor up/down keys to select the effect parameter that you want to edit.

When you use the cursor up/down keys, a setting screen for the effect types and parameters for this module is shown. The following diagram shows an example of what appears on the display when you have selected the DEPTH parameter of the “FLANGER” effect.

6. Turn the dial to change the setting.

For details on the effect types that can be selected for each effect module, and on the effect parameters of each type, refer to the appendix (→ p. 145 – 153) at the end of this manual.

7. To switch the module On/Off setting, bring the module onto the display and press the [ENTER] key.

When the effect module has been set to Off, the effect type name is shown as “-OFF-” on the display. If you press the [ENTER] key once more in this condition, the setting is returned to On.



NOTE

If “TOTAL” is shown on the first line of the display, you can adjust the ZNR/VOL PDL module setting and the patch level. Switching the effect module On/Off is not possible in this case.

8. Repeat steps 3 - 7 to make the desired edits for other modules.

- 9.** If you want to adjust the patch level (the final volume of the patch), use the cursor up/down keys to bring up the indication "TOTAL PAT LVL", and turn the dial.

The patch level can be adjusted in a range of 1 - 30.



- 10.** When you have finished editing, press the [EXIT] key.

The unit returns to the patch select screen.

NOTE

Keep in mind that if you return to the patch select screen and select another patch without first storing the patch, the edited contents will be lost. If you want to keep the results of your editing session, refer to the following section.

Storing an insert effect patch

A patch that you have edited can be stored in any location of the same algorithm. You can also store an existing patch in another location to create a copy of that patch.

- 1.** Press the [INSERT EFFECT] keys in the display section, and then press the [EDIT] key.

The currently selected patch can now be edited. Perform any editing steps that you wish to make.

- 2.** When editing is complete, press the [STORE] key in the control section.

A screen for specifying the store target location appears on the display.



- 3.** Turn the dial to select the store destination patch number.

- 4.** To store the patch, press the [STORE] key once more.

The patch will be stored, and the unit returns to the patch select screen.

HINT

- Patches that you have stored are saved on the hard disk as part of the project.
- Patch data included in an already existing project can be loaded into the current project (→ p. 110).

Editing the name of an insert effect patch

This section explains how to edit the name of the currently selected patch.

- 1.** Press the [INSERT EFFECT] keys which includes the target patch. Then use the PATCH SELECT [▲]/[▼] keys or the dial to select the patch that you want to edit.

- 2.** Press the [EDIT] key.

The currently selected patch can now be edited.

- 3.** Use the cursor left/right keys to bring up the indication "TOTAL PAT LVL".



- 4.** Repeatedly press the cursor down key to bring up the indication "PAT NAME".

The name of the selected patch can now be edited. The character currently selected for editing flashes.



- 5.** Use the cursor left/right keys to move the flashing position to the character you want to change, and turn the dial to select a character.

For information on available characters, refer to page 34.

- 6.** Repeat step 5 as necessary to complete the new name.

- 7.** To confirm the new name, press the [STORE] key in the control section twice.

The new name is stored, and the unit returns to the patch selection screen.

● NOTE ●

Keep in mind that the name will revert to the previous setting if you switch to another patch without storing the edited patch name.

Applying the insert effect only to the monitor signal

Normally when the insert effect is placed into the input mixer, the signal processed by the effect will be recorded on the track. If necessary, however, you can apply the insert effect only to the monitor signal, and record the unprocessed input signal on the track. For example when recording the unprocessed sound of a vocal performance, the vocalist may be more comfortable singing if an insert effect suitable for mic recording is applied to the monitor signal.

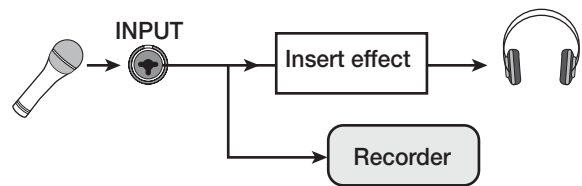

- 1.** Set the insert effect point to the input mixer.
- 2.** Press the [UTILITY] key in the display section.

The utility menu appears.

```
UTILITY
TR EDIT
```

- 3.** Use the cursor left/right keys to call up the indication "UTILITY REC SRC", and press the [ENTER] key.

The display changes as follows.

In this condition, you can select one of the following two signal types to be recorded on the track.

```
REC SRC
WET
```

- **WET**

The input signal that has passed through the insert effect will be recorded on the track (default setting).

- **DRY**

Only the unprocessed input signal will be recorded on the track. Even in this case, however, the insert effect will be applied to the monitor signal.

4. Turn the dial to change the setting to “DRY”.
5. When you have finished adjusting settings, press the [EXIT] key several times.

The unit returns to the main screen.

● NOTE ●

The “UTILITY REC SRC” setting is stored for the entire project. Before you begin recording other parts, change the setting back to “WET”.

Using the send/return effects

This section explains how to select and edit patches for the send/return effects (chorus/delay, reverb).

About the send/return effect patches

The “reverb” and “chorus/delay” send/return effects are separate and independent.

Reverb and chorus/delay each have an “effect type” that determines the type of effect, and various parameters that let you adjust the character of the effect. Settings for the effect type and parameters, together with a name, are collectively called send/return effect “patches”.

A newly created project contains 20 different reverb patches and 20 different chorus/delay patches. You can instantly switch reverb or chorus/delay settings simply by choosing the effect for which you want to select a patch (reverb or chorus/delay), and then selecting a patch. The patch number are assigned as follows.

Effect	Patch number
REVERB	0 – 19
CHORUS/DELAY	0 – 19

Selecting a send/return effect patch

This section explains how to select a reverb or chorus/delay patch.

1. Press the [REVERB] key or [CHORUS/DELAY] key in the effect section.

Press the [REVERB] key if you want to select a reverb patch, or the [CHORUS/DELAY] key if you want to select a chorus/delay patch.

The currently selected patch will be displayed. The following display shows an example of what you see when the [REVERB] key is pressed.

```

SEND REV
TightHal  0
  
```

↑ Patch name ↑ Patch number

2. Use the PATCH SELECT [▲]/[▼] keys or the dial to select the new patch.

As you turn the dial, new patches will be recalled immediately. If the track mixer REVERB SEND and CHORUS/DELAY SEND parameter settings are raised, you can press the PLAY [▶] key to play back the song, and listen to the result of the newly selected patch.

HINT

- For details on track mixer operations, refer to p. 71.
- The lit/out status of the [REVERB] or [CHORUS/DELAY] key shows the on/off status of that module. Each push of the key toggles the status.

3. To return to the main screen, press the [EXIT] key.

Editing a send/return effect patch

This section explains how to edit a send/return effect patch.

1. Press the [REVERB] key or [CHORUS/DELAY] key in the effect section.

2. If necessary, turn the dial to select the patch that you want to edit. The following screen is an example of the display indication when the [CHORUS/DELAY] key was pressed.



```
SEND CHO
DeepCho  7
```

3. Press the [EDIT] key.

The display will indicate “EDIT”, and a screen will appear in which you can edit the patch. When the [EDIT] key is pressed, the effect type selected for that send/return effect is shown.



```
TYPE
CHORUS  EDIT
```

↑
Effect type

4. If you want to change the effect type, turn the dial.

When the effect type is changed, the effect parameters will also change accordingly.

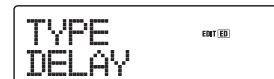

```
TYPE
DELAY  EDIT
```

HINT

If the contents of a patch have been edited, the “EDIT” indicator in the upper part of the display will change to “EDITED”.

5. Use the cursor up/down keys to select the effect parameter that you want to edit.

The first line of the display shows the effect type, and the second line the effect parameter name.

The current setting is shown to the right of the parameter name.

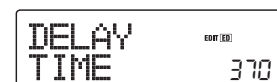

```
DELAY
TIME  EDIT 370
```

↑ Effect parameter ↑ Setting value

6. Turn the dial to change the setting.

For details on the effect types that can be selected for reverb or chorus/delay, and on the range of each effect parameter, refer to the appendix (→ p. 145 – 153) at the end of this manual.

7. Repeat steps 5 - 6 as necessary to edit other effect parameters.

8. When you have finished editing, press the [EXIT] key.

The unit returns to the patch select screen.

NOTE

Keep in mind that if you select another patch without first storing the patch, the edited contents will be lost. If you want to keep the results of your editing session, refer to the following section.

Storing a send/return effect patch

A patch you have edited can be stored in any location of the same send/return effect. You can also store an existing patch in another location to create a copy of that patch.

1. Press the [REVERB] key or [CHORUS/DELAY] key in the effect section, and then press the [EDIT] key.

The currently selected patch can now be edited. Perform the necessary steps for editing.

2. When editing is complete, press the [STORE] key in the control section.

A screen for specifying the store target location appears on the display.



Store
DeepCho 7

3. Turn the dial to select the store destination patch number.

4. Press the [STORE] key once more.

The patch will be stored, and the unit returns to the patch select screen.

HINT

- Patches that you have stored are saved on the hard disk as part of the project.
- Patch data included in an already existing project can be loaded into the current project (→ p. 110).

Editing the name of a send/return effect patch

This section explains how to edit the name of the patch that is currently selected for a send/return effect.

1. Press the [REVERB] key or [CHORUS/DELAY] key in the effect section.

If necessary, use the PATCH SELECT [▲]/[▼] keys or turn the dial to select the patch whose name you want to edit.

2. Press the [EDIT] key, and repeatedly press the cursor down key to bring up the indication "PAT NAME".

The name of the selected patch can now be edited. The character currently selected for editing flashes.



PAT NAME
DeepCho

3. Use the cursor left/right keys to move the flashing position to the character you want to change, and turn the dial to select a character.

For information on available characters, refer to page 34.

4. Repeat step 3 as necessary to complete the new name.

5. To confirm the new name, press the [STORE] key in the control section twice.

The new name is stored, and the unit returns to the patch selection screen.

Importing patches from another project

This section explains how to import (load) all patches for the internal effects from another project that is already saved on the hard disk.

NOTE

Keep in mind that importing patches in this way will overwrite all patches in the current project. Take care not to accidentally erase patches that you wish to keep.

- 1.** Press the [INSERT EFFECT] keys, [REVERB] key, or [CHORUS/DELAY] key to bring up an effect related parameter on the display.

To import a patch, an effect related parameter must be shown on the display.

- 2.** Press the [UTILITY] key.

The utility menu for the effect appears on the display.



```
UTILITY
Import
```

- 3.** Press the [ENTER] key.

In this condition, you can select the project from which to import.

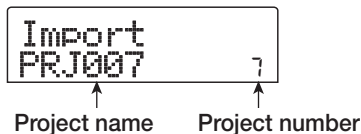

```
Import
PRJ007
```

Project name Project number

- 4.** Turn the dial to select the import source project, and press the [ENTER] key.

The indication “Import SURE?” appears on the display.

- 5.** To carry out the import process, press the [ENTER] key once more. To cancel the process, press the [EXIT] key.

The patches of the selected project are imported into the current project. When the import process is completed, the screen of step 1 appears again.

Reference [Creating a CD]

This section describes how to use the CD-R/RW drive in the MRS-802.

NOTE

- On a MRS-802 without preinstalled CD-R/RW drive, creating a CD is not possible.
- Mixed mode CDs or copy controlled CDs cannot be played or used as data source.

Writing audio data

The MRS-802 lets you write the contents of the master track of any project to a CD-R/RW disc in CD-DA (audio data) format. The result is an audio CD that can be played in a CD player. As with the other tracks of the MRS-802, the master track also has ten V-takes. The most recently selected V-take will be used as source material for the audio CD.

There are two ways of writing audio data on a CD-R/RW disc, as described below.

• Writing by project

This method writes the master track of a single project to the disc. When using this method, it is possible to add audio data later, until the disc has been finalized.

• Writing by album

This method involves first creating a list for the audio CD (called an “album”) which contains information about master tracks from various projects that are to be included. The CD is then written in one operation, and finalizing is automatically performed, so that no more audio data can be added later.

HINT

“Finalizing” an audio CD refers to the procedure of making it playable on an ordinary CD player. After it has been finalized, no more data can be added to a CD-R/CD-RW disc.

NOTE

The waveform data of the currently selected V-take of the master track are recorded as is on the audio CD. It is not possible to edit it during recording. To cut off blank portions before or after the audio material, use the master track trimming function (→ p. 49) beforehand.

About CD-R/RW discs

For creating an audio CD, you can select either CD-R or CD-RW discs as media. The features of the two disc types are described below.

• CD-R

This media type allows only one-time recording or adding of data. Once data have been written, they cannot be changed or erased. CD-R discs are available in 650 MB and 700 MB capacities.

To newly write audio data of the MRS-802 to disc, a blank CD-R is required. As long as the disc has not been finalized, it is possible to add further audio data up to the maximum capacity of the disc. After being finalized, the disc can be played on an ordinary CD player.

• CD-RW

This media type allows recording, adding, and bulk-erasing of data. CD-RW discs are also available in 650 MB and 700 MB capacities.

To newly write audio data of the MRS-802 to disc, a blank or completely erased CD-RW is required. As long as the disc has not been finalized, it is possible to add audio data up to the maximum capacity of the disc. The disc can usually only be played on CD players designed to read CD-R/RW discs.

Disc	Write	Add data	Erase	Playback on normal CD player
CD-R	Once only	Yes	No	Yes
CD-RW	Many times (after erasing)	Yes	Yes	No

NOTE

When using commercially available pre-formatted CD-RW discs, perform an erase operation first, as described on page 117.

Recording audio data by project

You can select one project and write the contents of its master track to a CD-R/CD-RW disc.

NOTE

Before starting the procedure described below, use the trimming function on the master track to make sure that it does not include unwanted blank portions at the beginning and end (→ p. 49).

1. Insert a CD-R/RW disc into the CD-R/RW drive.

To newly write audio data, use a blank CD-R/RW disc or a CD-RW disc that has been completely erased.

To add audio data, use a CD-R/RW disc that has not yet been finalized.

2. Select the project to be used as write source.

For details on loading projects, refer to page 125.

3. Verify that the V-take that you want to write to the audio CD is selected for the master track of that project.

4. From the main screen, press the [CD-R/RW] key in the display section.

The CD-R/RW menu appears.

```

CD-R/RW
AUDIO CD
  
```

5. Verify that the indication “CD-R/RW AUDIO CD” is shown on the display, and press the [ENTER] key.

The audio CD menu appears.

```

AUDIO CD
BURN CD
  
```

6. Verify that “AUDIO CD BURN CD” is shown, and press the [ENTER] key.

The duration of the source master track appears on the display in hours (H), minutes (M), seconds (S), and milliseconds (MS).

```

BURN CD
TIME
0 53 4250
  
```

↑
Master track length

7. To check the available write time on the inserted disc, press the cursor down key.

The remaining disc time is shown in the lower part of the display (in minutes/seconds/milliseconds).

```

BURN CD
REMAIN
0 740 00
  
```

↑
Available write time

Press the cursor up key to return to the previous screen.

8. To audition the source master track, press the PLAY [▶] key. To stop playback, press the STOP [■] key.

9. Press the [ENTER] key twice.

The display changes as follows.

Write target track number

```

CDtrk01
SURE?
0 740 00
  
```

10. To carry out the write process, press the [ENTER] key.

Writing on the CD-R/RW disc starts. During the write process, the indication “wait...” is shown on the display. The counter displays the write progress.

When writing is complete, the display shows “CDtrkxx COMPLETE” (where xx is the track number).

HINT

By pressing the [EXIT] key instead of the [ENTER] key, you can cancel the write process and return to the previous display screen.

11. When writing is complete, press the [EXIT] key.

The unit returns to the condition of step 4. To add more audio data, load the next project and repeat the above procedure.

HINT

- When using this method, a blank gap of 2 seconds will automatically be inserted between tracks on the disc.
- As long as the finalizing operation has not been performed, the CD-R/RW disc cannot be played on an ordinary CD player. (For information on how to audition an unfinalized CD-R/RW disc, refer to page 115.)

12. To return to the main screen, press the [EXIT] key several times.**Recording audio data by album**

This method involves creating a list for the audio CD (called an “album”) which contains information about master tracks from multiple projects saved on the hard disk. The CD-R/CD-RW disc containing these master tracks is then written in a single operation.

NOTE

Before starting the procedure described below, use the trimming function on the master track to make sure that it does not include unwanted blank portions at the beginning and end.

1. Insert a CD-R/RW disc into the CD-R/RW drive.

To newly write audio data, use a blank CD-R/RW disc or a CD-RW disc that has been completely erased.

To add audio data, use a CD-R/RW disc that has not yet been finalized.

2. Verify that the correct V-takes are selected for the master tracks of the projects to be recorded.**NOTE**

Projects in which an unrecorded V-take is selected for the master track cannot be used as source material.

3. From the main screen, press the [CD-R/RW] key in the display section.

The CD-R/RW menu appears.

4. Verify that the indication “CD-R/RW AUDIO CD” is shown on the display, and press the [ENTER] key.

The audio CD menu appears.

```
AUDIO CD
BURN CD
```

5. Use the cursor left/right keys to bring up the indication “AUDIO CD ALBUM” on the display, and press the [ENTER] key.

In this condition, you can register projects for the album. The indication “END OF PROJ” denotes the end of the album list of projects. When the album display is first called up, no project has been registered, therefore the indication “END OF PROJ” appears.

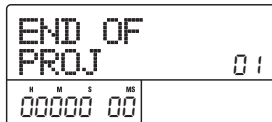

6. Turn the dial to select the project to be used as track 1 of the album.

The indication "END OF PROJ" moves up to the next track, and the screen changes as follows.

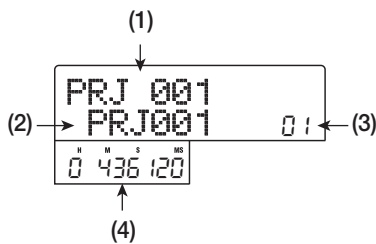

(1) Project number

(2) Project name

This shows the name and number of the project to be used as recording source.

(3) Track number

This shows the track number to be used as write target on the CD-R/RW disc.

(4) V-take duration

This shows the length (in hours/minutes/seconds/milliseconds) of the currently selected V-take of the master track in the selected project.

NOTE

Projects with a master track for which an unrecorded V-take is selected cannot be selected as source. If a desired project name does not come up, check whether a recorded V-take was selected for its master track.

7. When the project for track 1 has been selected, use the cursor right key to move to track 2.

The screen changes as follows.



8. Turn the dial to select the project to be used as

track 2 of the album.

9. In the same way, select projects for track 3 and subsequent tracks.

The maximum allowable number of tracks is 99, provided that there is enough free capacity on the disc.

• To audition the master track

Press the PLAY [▶] key. The master track of the project currently shown on the display is played. To stop playback, press the STOP [■] key.

• To change projects in an album

Use the cursor left/right keys to select the track number for which you want to change the project and use the dial to select another project.

• To delete a project from an album

Use the cursor left/right keys to select the track number whose project you want to delete and press the [DELETE/ERASE] key. The indication "DELETE SURE?" appears on the display. To delete the project from the album list, press the [ENTER] key. If you wish to cancel the process, press the [EXIT] key instead. When a project is deleted, the following tracks are moved up by one position.

• To delete all projects from an album

In the condition for registering projects in an album, press the [DELETE/ERASE] key and then the cursor down key. The indication "ALL DEL SURE?" appears on the display. To delete all projects from the album list, press the [ENTER] key. If you wish to cancel the process, press the [EXIT] key instead.

• To check the capacity of a CD-R/RW disc

Press the cursor down key. The remaining time of the disc appears in the lower part of the display. To return to the previous screen, press the cursor up key.

10. When you have stored all desired projects in the album, press the [ENTER] key twice.

The display changes as follows.



HINT

If you press the [ENTER] key once more, the indication “xx Tracks BURN?” (where xx is the number of tracks) appears on the display. You can check the total number of tracks from this screen.

11. To carry out the burn process, press the [ENTER] key once more.

Writing on the CD-R/RW disc starts. During the write process, the indication “wait...” is shown on the display. The counter displays the write progress.

When the write process is completed, the disc is ejected, and the message “ALBUM NEXT?” appears on the screen. If you wish to write another disc with the same content, insert a blank CD-R/RW disc or a CD-RW disc which has been completely erased, and press the [ENTER] key. To terminate the process, press the [EXIT] key.

12. To return to the main screen, press the [EXIT] key several times.

Playing an audio CD

To play an audio CD inserted in the CD-R/CD-RW drive, proceed as follows. This method can also be used to audition a CD-R/CD-RW disc which has not been finalized yet.

NOTE

A CD-R/CD-RW disc which has not been finalized can only be played with this method.

- 1. Insert an audio CD in the CD-R/RW drive.**
- 2. From the main screen, press the [CD-R/RW] key in the display section.**

The CD-R/RW menu appears.

- 3. Verify that the indication “CD-R/RW AUDIO CD” is shown on the display, and press the [ENTER] key.**

The audio CD menu appears.

```
AUDIO CD
BURN CD
```

- 4. Use the cursor left/right keys to bring up the indication “AUDIO CD PLAYER” on the display, and press the [ENTER] key.**

The display shows the track number and playback method for the inserted audio CD. If a non-finalized disc is inserted, an “*” is shown.

```

(2)
  ↓
PLAYER
TRK01 D* ← (3)
  ↑
  0 332 120
  ↑
(4)

```

(1) Track number

The number of the currently selected track on the audio CD is shown.

(2) Playback method

Indicates the currently selected audio CD playback method. “D” stands for digital playback and “A” for analog playback.

(3) Finalize status

When a “*” symbol is shown here, a non-finalized CD-R/RW disc has been inserted.

(4) Current position in track

The location in the current track is shown here in hours (H), minutes (M), and seconds (S).

5. Use the FF [▶▶] and REW [◀◀] keys to select the track to be played.

While the track number is shown, the FF [▶▶] and REW [◀◀] keys can be used to select the track on the CD. The FF [▶▶] key selects the next track and the REW [◀◀] key selects the previous track.

6. Use the cursor up/down keys to select the playback method for the audio CD.

Each push of the cursor up/down keys toggles between the following two methods.

- **D (Digital playback)**

The digital audio signal of the CD is read by the MRS-802 in the digital domain and becomes available as an audio signal at the rear panel MASTER OUTPUT jacks, and front panel MASTER PHONES jack. (Default setting)

- **A (Analog playback)**

The audio signal of the CD is reproduced via the headphone output of the CD-R/RW drive.

7. To start playback of the audio CD, press the PLAY [▶] key.

Playback of the selected track starts. When the track is finished, playback continues with the next track. During audio CD playback, all faders except for the [MASTER] fader as well as the EQ, reverb, chorus/delay, and pan settings are disabled.

8. For track selection and for controlling playback stop/pause, use the transport section keys.

PLAY [▶] key

Playback of the selected track starts. Pressing the key during playback sets the system to pause mode.

STOP [■] key

Playback stops, and the system returns to the beginning of the current track.

FF [▶▶] key

Playback stops, and the system jumps to the beginning of the next track.

REW [◀◀] key

Playback stops, and the system jumps to the beginning of the current track.

9. To return to the main screen, press the [EXIT] key several times.

Erasing a CD-RW Disc

The entire information on a CD-RW disc (audio data or backup data) can be erased, thereby returning the disc to the blank state.

- 1.** Insert the disc to erase into the CD-R/RW drive.
- 2.** From the main screen, press the [CD-R/RW] key in the display section.
- 3.** Verify that the indication “CD-R/RW AUDIO CD” is shown on the display, and press the [ENTER] key.

The audio CD menu appears.



```
AUDIO CD
BURN CD
```

- 4.** Use the cursor left/right keys to bring up the indication “AUDIO CD CDRW ERS” on the display, and press the [ENTER] key.

The display shows “CdrwErs NORMAL”.



```
CdrwErs
NORMAL
```

- 5.** Use the cursor up/down keys to select one of the following two CD-RW erase methods.

- **NORMAL (Default setting)**

Information from all areas of the disc is erased. This takes longer than the QUICK erase operation, but all contents of the disc are reliably erased. This method is recommended. (Required time is max. 74 minutes for a 650 MB disc and 80 minutes for a 700 MB disc.)

- **QUICK**

Only the track information on the CD-RW disc is erased. This requires less time than the NORMAL erase operation.

- 6.** Press the [ENTER] key.

The display now shows the indication “CdrwErs SURE?”.

- 7.** To carry out the erase process, press the [ENTER] key once more.

The erase process starts. During the operation, the display shows “CdrwErs wait...”.

When the erasing process is finished, the display indication changes to “CdrwErs COMPLETE”.

- 8.** To return to the main screen, press the [EXIT] key several times.

 **HINT** 

Erasing a CD-RW disc is also possible from the backup menu (→ p. 119). After you bring up “BACKUP CDRW ERS” on the display and press the [ENTER] key, the disc can be erased in the same way as described above.

Finalizing a CD-R/RW Disc

“Finalizing” a CD-R/RW to which audio data were written refers to the procedure of turning it into a finished audio CD. After a disc has been finalized, no more tracks can be added to it. When a CD-R disc has been finalized, it will be playable on an ordinary CD player. (A CD-RW will normally not be playable on an ordinary CD player, even if it has been finalized.)

1. Insert the disc to finalize into the CD-R/RW drive.

2. From the main screen, press the [CD-R/RW] key in the display section.

The CD-R/RW menu appears.

3. Verify that the indication “CD-R/RW AUDIO CD” is shown on the display, and press the [ENTER] key.

The audio CD menu appears.

4. Use the cursor left/right keys to bring up the indication “AUDIO CD FINALIZE” on the display, and press the [ENTER] key.

The display indicates the total number of tracks on the CD-R/RW disc. The counter indicates the total playing time of all tracks on the disc (including pauses) in hours (H), minutes (M), and seconds (S).

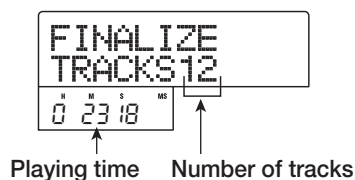

5. Press the [ENTER] key.

The indication “FINALIZE SURE?” appears on the display.

6. To carry out the finalizing process, press the [ENTER] key once more. To cancel the operation, press the [EXIT] key.

When you press the [ENTER] key, the finalizing process starts. During the operation, the display shows “FINALIZE wait...”. When the process is finished, the display indication changes to “FINALIZE COMPLETE”.

HINT

By erasing the entire disc, a CD-RW disc can be used again also after finalizing. For details, refer to page 117.

7. To return to the main screen, press the [EXIT] key several times.

Loading data from an audio CD

The MRS-802 can read audio data from an ordinary audio CD inserted in the CD-R/RW drive and record these data on any track of the internal recorder. The data can then be handled and edited in the same way as other tracks. This is convenient for example to use drum or guitar phrases from a sampling CD.

Data can be read only as entire audio CD tracks. Specifying a range is not possible. If you want to use only a part of a track, perform trimming of unwanted portions after loading (→ p. 49).

- 1.** Insert the disc from which to load audio data into the CD-R/RW drive.
- 2.** Perform steps 2 - 5 of “Playing an audio CD” and select the desired track of the CD.
- 3.** Press the REC [●] key.

```
READ DST
TR 1/2
```

- 4.** Turn the dial to select the track for recording the data.

Only odd-numbered/even-numbered pairs of mono tracks (1/2, 3/4, 5/6, 7/8) or the master track (MASTER) can be selected.

- 5.** Press the [ENTER] key.

The recording destination is selected, and the indication “READ CD SURE?” appears on the display. (When the track already contains data, the indication “OverWrt?” is shown.)

- 6.** To carry out the read process, press the [ENTER] key once more.

Loading data from the audio CD starts. When loading is complete, the unit returns to the condition of step 4.

- 7.** To return to the main screen, press the [EXIT] key several times.

Backup and restore

This section explains how you can use the CD-R/RW drive in the MRS-802 to back up a project to a CD-R/RW disc and how to restore a project from a disc backup.

NOTE

On a MRS-802 without preinstalled CD-R/RW drive, creating a backup CD as described here is not possible.

Saving a single project to CD-R/RW disc

You can select any project and save it on a CD-R/RW disc for backup.

HINT

If the size of the project is larger than the capacity of the CD-R/RW disc, you can create a backup spanning multiple volumes.

- 1.** Insert a CD-R or CD-RW into the CD-R/RW drive.

To back up a project, use a blank CD-R/RW disc or a CD-RW disc that has been completely erased.

- 2.** From the main screen, press the [CD-R/RW] key in the display section.

The CD-R/RW menu appears.

- 3.** Use the cursor left/right keys to bring up the indication “CD-R/RW BACKUP” on the display, and press the [ENTER] key.

The display shows the backup/restore menu.

```
BACKUP
SAVE
```

- 4.** Verify that “BACKUP SAVE” is shown on the display, and press the [ENTER] key.

The display changes to a screen for selecting the project to be backed up.

```
SAVE
PRJ001
```

↑ ↑
Project name Project number

5. Turn the dial to select the project, and press the [ENTER] key.

This selects the project that will be backed up. The display now shows the space required for the backup in MB (megabytes).

```
PRJ SIZE
108MB
```

6. Press the [ENTER] key.

The name of the directory to be used for backup appears. A “directory” (also called “folder”) is a hierarchical unit that will be created on the backup media when the backup is executed. All data for one project are stored in the same directory.

When the backup is executed, a new directory is created on the CD-R/RW disc with the name “PROJxxx” (where xxx is the project number). This name can be edited if desired.

```
DirName
PROJ001
```

7. If you want to edit the backup destination directory name, use the cursor left/right keys to move the flashing position and turn the dial to select a character.

The following characters can be used.

Numerals: 0 - 9

Letters: A - Z

Symbols: _ (underscore)

8. Press the [ENTER] key.

The indication “SAVE SURE?” appears on the display.

HINT

If you press the [EXIT] key at any point during steps 4 - 7, you can return to the previous step.

9. To execute the backup, press the [ENTER] key. To cancel, press the [EXIT] key instead.

When backup starts, the disc number and the indication “BURNING” appear on the display.

Disc number
↓
DISC001
BURNING

When backup is finished, the display shows “SAVE COMPLETE”.

If the project size is larger than the capacity of one CD-R/RW disc, the disc will be ejected after it has been filled up, and the display changes as follows.

```
CHANGE
DISC002
```

10. When the above message appears, insert a new CD-R/RW disc, and press the [ENTER] key.

The backup operation resumes. If more than two discs are required, the above steps will be repeated. When backup is finished, the display indication changes to “SAVE COMPLETE”.

NOTE

When a backup spans several discs, the discs must be used in the same order for restore. Be sure to note the disc number on the case and label of the disc.

HINT

When the disc has been ejected, it also is possible to abort the backup operation. To do this, press the [EXIT] key while the indication “CHANGE DISCxxx” (where xxx is the disc number) is shown. The indication will change to “SAVE CANCEL?”. Press the [ENTER] key to terminate the process.

11. To return to the main screen, press the [EXIT] key several times.

Saving all projects to CD-R/RW disc

You can save all projects on the hard disk to CD-R/RW media for backup.

If the total size of all projects is larger than the capacity of one CD-R/RW disc, the backup will automatically extend over multiple volumes, with lower-numbered projects being placed on lower-numbered discs.

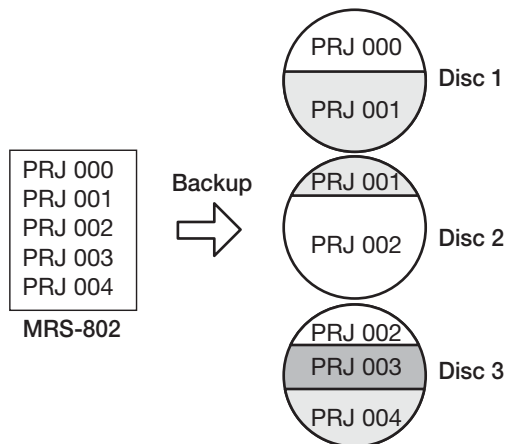

NOTE

Also if all projects were saved in one operation, restoring will be on a single-project basis.

1. Insert a CD-R or CD-RW into the CD-R/RW drive.

To back up projects, use a blank CD-R/RW disc or a CD-RW disc that has been completely erased.

2. From the main screen, press the [CD-R/RW] key in the display section.

The CD-R/RW menu appears.

3. Use the cursor left/right keys to bring up the indication "CD-R/RW BACKUP" on the display, and press the [ENTER] key.

The display shows the backup/restore menu.

```

BACKUP
SAVE
  
```

4. Use the cursor left/right keys to bring up the indication "BACKUP ALL SAVE" on the display, and press the [ENTER] key.

The display shows the space required for the backup of all projects in MB (megabytes).

```

SIZE
478MB
  
```

5. Press the [ENTER] key.

The indication "ALL SAVE SURE?" appears on the display.

```

ALL SAVE
SURE?
  
```

6. To execute the backup, press the [ENTER] key. To cancel, press the [EXIT] key instead.

When you press the [ENTER] key, backup starts from the project with the lowest number. The display shows the disc number, the project number, and the indication "BURNING".

When backup is finished, the display indication changes to "ALL SAVE COMPLETE".

```

Disc number
↓
DISC001
BURNING      4
↑
Project currently being saved
  
```

If the backup size is larger than the capacity of one CD-R/RW disc, the disc will be ejected after it has been filled up, and a message prompting the user to insert the next CD-R/RW disc appears.

```

CHANGE
DISC002      5
↑
Projects already saved
  
```

The number at bottom right indicates up to which project is saved on this disc.

7. When the above message appears, insert a new CD-R/RW disc, and press the [ENTER] key.

The backup operation resumes. If more than two discs are required, the above steps will be repeated. When the backup

is finished, the display indication changes to “ALL SAVE COMPLETE”.

NOTE

When a full backup spans several discs, restoring a single project requires you to first insert the disc on which it is saved. Be sure to note the disc number and the projects saved on the disc on the case and label of the disc.

HINT

When the disc has been ejected, it also possible to abort the backup operation. To do this, press the [EXIT] key while the indication “CHANGE DISCxxx” (where xxx is the disc number) is shown. The indication will change to “ALL SAVE CANCEL?”. Press the [ENTER] key to terminate the process.

8. To return to the main screen, press the [EXIT] key several times.

Loading a project from CD-R/RW disc

To restore a project saved on CD-R/RW disc to the hard disk of the MRS-802, proceed as follows.

1. From the main screen, press the [CD-R/RW] key in the display section.

The CD-R/RW menu appears.

2. Use the cursor left/right keys to bring up the indication “CD-R/RW BACKUP” on the display, and press the [ENTER] key.

The display shows the backup/restore menu.



3. Use the cursor left/right keys to bring up the indication “BACKUP LOAD” on the display, and press the [ENTER] key.

The indication “LOAD InsDisc1” appears on the display.



4. Insert the CD-R or CD-RW where the project is saved into the CD-R/RW drive.

- If project was backed up as single project

Insert disc number 1.

- If project was backed up as part of a full backup of all projects

Insert the disc where the project is stored. (If there are multiple discs, insert the first disc that contains data of the desired project.)

NOTE

- Also when you have backed up all projects in a single operation, restore is performed for single projects.
- If the backup of the project spans multiple discs, be sure to insert the first disc that contains data of the desired project first. If you insert another disc, the project data will not be read correctly.

5. Press the [ENTER] key.

The name of the project on the disc, and the number which is to be assigned to the project are shown on the display.

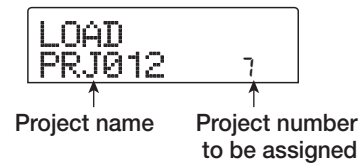

HINT

When being restored to the MRS-802, an empty project number is automatically assigned to the project. Even if a project with the same name already exists on the hard disk, it will not be overwritten.

6. To check the name of the directory from which the project will be read, press the cursor down button.

The display shows the directory name.

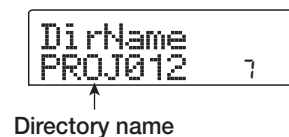

Press the cursor up key to restore the original display.

- 7.** Turn the dial to select the project to load, and press the [ENTER] key.

The indication “LOAD SURE?” appears on the display.

- 8.** To execute the load operation, press the [ENTER] key. To cancel, press the [EXIT] key instead.

When you press the [ENTER] key, the project data are read from the disc and loaded to the hard disk. When the operation is finished, the display indication changes to “LOAD COMPLETE”.

If the backup spans multiple discs, the disc will be automatically ejected when the data have been loaded, and the following message appears on the display.



```
CHANGE  
DISC002
```

- 9.** When the above message appears, insert the next CD-R/RW disc, and press the [ENTER] key.

The load operation resumes. If more than two discs are required, the above steps will be repeated. When the load operation is finished, the display indication changes to “LOAD COMPLETE”.

● **NOTE** ●

If the backup of the project spans multiple discs, be sure to insert the discs in the correct order. Otherwise the project data will not be read correctly.

■ **HINT** ■

When the disc has been ejected, it is also possible to abort the load operation. To do this, press the [EXIT] key while the indication “CHANGE DISCxxx” (where xxx is the disc number) is shown. The indication will change to “LOAD CANCEL?”. Press the [ENTER] key to terminate the process.

- 10.** To return to the main screen, press the [EXIT] key several times.

Reference [Projects]

This section describes how to perform operations for entire projects.

About projects

On the MRS-802, the data needed to reproduce a song you create are managed in units called “projects”. By loading a project from the hard disk, you can always go back to exactly the same condition that existed when the project was saved. A project contains the following information.

- Audio data recorded on V-takes 1 - 10 of tracks 1 - 8 and the master track
- Track parameter Settings
- Number of selected V-take for each track
- Mixer section settings
- Settings saved in scene numbers 0 - 99
- Scene parameter enabled/disabled settings
- Numbers and settings of patches currently selected for insert effect and send/return effect
- Rhythm patterns
- Rhythm songs
- Drum kit currently selected for rhythm section
- MIDI-related settings
- Audio data in phrase pool
- Other file settings

● NOTE ●

On the MRS-802, recording/playback operations can be performed only for the currently loaded project. It is not possible to operate multiple projects simultaneously.

Project operations

This section explains operations such as loading or saving a project. The procedure is the same for most project operations. The basic procedure is as follows.

Basic procedure

1. From the main screen, press the [PROJECT] key.

The project menu appears on the display, allowing you to select the desired project operation.



■ HINT ■

When you press the [PROJECT] key, the current project is automatically saved on the hard disk.

2. Use the cursor left/right keys to select one of the following operations.

- **PROJECT SELECT**

Load a previously saved project from the internal hard disk.

- **PROJECT NEW**

Create a new project.

- **PROJECT SIZE**

View the size of the currently loaded project.

- **PROJECT COPY**

Duplicate a specified project on the hard disk.

- **PROJECT ERASE**

Erase a specified project from the hard disk.

- **PROJECT NAME**

Edit the name of the currently loaded project.

- **PROJECT PROTECT**

Write-protect the currently loaded project.

3. Press the [ENTER] key to execute the operation (or change the setting) that you selected.

For details on the procedure, refer to the sections that follow.

4. To return to the main screen, press the [EXIT] key several times.

Loading a project

You can select a project that was saved on the hard disk, and load it.

1. Refer to steps 1 - 2 of “Basic procedure” to bring up the indication “PROJECT SELECT” on the display. Then press the [ENTER] key.

The project to load is shown on the display.

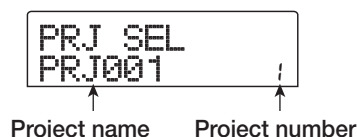

2. Turn the dial to select the desired project.
3. Press the [ENTER] key to load the project, or press the [EXIT] key to cancel.

When loading is completed, the unit returns to the main screen.

HINT

- When you press the [ENTER] key, the current project will be automatically saved on the hard disk before the new project is loaded.
- When power to the MRS-802 is turned on, the project that you were last working on will be loaded automatically.

Creating a new project

This operation creates a new project.

1. Refer to steps 1 - 2 of “Basic procedure” to bring up the indication “PROJECT NEW” on the display. Then press the [ENTER] key.

The project to create is shown on the display.

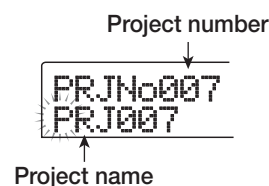

The lowest free project number is automatically selected, and a default name of “PRJxxx” (where xxx is a project number in the range of 000 - 999) will be assigned.

2. If necessary, edit the project name.

To edit the name, use the cursor left/right keys to move the flashing position to the character you want to change, and turn the dial to select a character. The project name can also be edited later (→ p. 127).

3. Press the [ENTER] key to create the project, or press the [EXIT] key to cancel.

When the new project has been loaded, the unit returns to the main screen.

Checking the project size/available hard disk capacity

This displays the size of the currently loaded project, the available capacity of the internal hard disk, and the remaining recording time.

1. Refer to steps 1 - 2 of “Basic procedure” to bring up the indication “PROJECT SIZE” on the display. Then press the [ENTER] key.
2. Use the cursor up/down keys to select the desired screen from one the following options.

- REMAIN (MB units)

This shows the remaining space on the internal hard disk in MB (megabyte) units.



• **REMAIN (h/m units)**

The approximate recordable time remaining for each track is shown in hours (h)/minutes (m)/seconds.



• **PRJ SIZ (MB units)**

This shows the size of the currently loaded project in MB (megabyte) units.



• **PRJ SIZ (h/m units)**

This shows the size of the currently loaded project in terms of the recorded time per track, in hours (h)/minutes (m)/seconds.



■ **HINT** ■

- These screens are for display only, and contain no items that can be edited.
- The remaining recordable time is an approximation.

Duplicating a project

This operation copies a specified project that is saved on the hard disk.

1. Refer to steps 1 - 2 of “Basic procedure” to bring up the indication “PROJECT COPY” on the display. Then press the [ENTER] key.

The name and number of the project to copy are shown on the display.

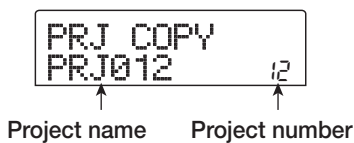

2. Turn the dial to select the copy source project, and press the [ENTER] key.

The screen for selecting the copy destination project appears on the display.

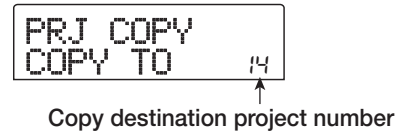

3. Turn the dial to select the copy destination project number, and press the [ENTER] key.

The indication “SURE?” appears on the display.

4. Press the [ENTER] key to copy the project, or press the [EXIT] key to cancel.

When copying is completed, the unit returns to the main screen.

Erasing a project

This operation erases the specified project from the hard disk.

1. Refer to steps 1 - 2 of “Basic procedure” to bring up the indication “PROJECT ERASE” on the display. Then press the [ENTER] key.

The project to erase is shown on the display.

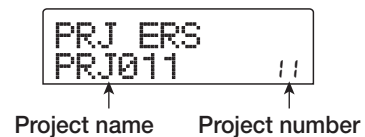

2. Turn the dial to select the project to be erased.
3. Press the [ENTER] key to erase the project, or press the [EXIT] key to cancel.

To return to main screen after erasing is completed, press the [EXIT]key.

● **NOTE** ●

- Once a project has been erased, it cannot be recovered. Use this operation with care.
- This item cannot be selected for projects with the protect ON setting.

HINT

It is also possible to erase the currently loaded project. In this case, the lowest-numbered project will automatically be loaded after the erase operation has been completed.



Editing the project name

This lets you edit the name of the currently loaded project.

1. Refer to steps 1 - 2 of “Basic procedure” to bring up the indication “PROJECT NAME” on the display. Then press the [ENTER] key.

The current project name is shown on the display.



2. To edit the name, use the cursor left/right keys to move the flashing position to the character you want to change, and turn the dial to select a character.

For information on available characters, refer to page 34.

To return to the main screen after editing the name, press the [EXIT] key.

Protecting/unprotecting a project

This operation lets you write-protect the currently loaded project or turn previously enabled protection off. When protect is ON, the following operations will be impossible.

- Deleting a project
- Editing or recording on the recorder
- Changing the V-take
- Editing a patch (including module on/off)
- Recording or editing a rhythm pattern or rhythm song
- Saving scenes, making marker settings, etc.

1. Refer to steps 1 - 2 of “Basic procedure” to bring up the indication “PROJECT PROTECT” on the display. Then press the [ENTER] key.

The screen for setting the protect status to ON/OFF is shown on the display.

2. Turn the dial to select ON (write-protect enabled) or OFF (write-protect disabled).

When write-protect is ON for a project, a lock symbol  is shown to the right of the project number.



Lock symbol

A change in the protect status becomes active immediately. To return to the main screen, press the [EXIT] key several times.

NOTE

If a project is loaded for which write-protect is not enabled, and you select another project, the current project's mix settings will be overwritten, because the existing project is automatically saved on the hard disk before loading the new project. If you do not want a completed mix to be changed further, it is recommended to set write-protect to ON.

HINT

The various track parameters such as EQ and panning can be adjusted also when the project is protected (but the settings will not be stored).

Reference [MIDI]

This section explains the MIDI-related settings of the MRS-802.

About MIDI

MIDI (Musical Instrument Digital Interface) is a standard that allows messages such as performance data (collectively called “MIDI messages”) to be exchanged between devices such as electronic musical instruments and computers. The MRS-802 supports MIDI and is equipped with the following two MIDI connectors.



- **MIDI IN connector**

Serves for receiving MIDI messages sent from an external MIDI device. This connector is used mainly to receive Note messages from an external MIDI device in order to play a drum kit.

- **MIDI OUT connector**

Serves for transmitting MIDI messages from the MRS-802. Note messages that represent the content played by a rhythm pattern or rhythm song can be transmitted from this connector, and it can be used to synchronize playback of an external MIDI device to the MRS-802.

What you can do using MIDI

On the MRS-802, you can use MIDI for the following functions.

- **Receive play information**

You can use an external MIDI keyboard or a computer to send play information (Note On/Off messages) to the MRS-802, to play a drum kit of the rhythm section. When creating a rhythm pattern, you can use an external MIDI keyboard to input play information.

- **Send play information**

You can send Note On/Off messages from the MRS-802 when playing a rhythm song/rhythm pattern. These can be used to play an external MIDI sound source.

- **Send sync information**

The MRS-802 can output MIDI Timing Clock, Song Position Pointer, and Start/Stop/Continue messages to synchronize operation with an external MIDI device. Playback and other transport operations as well as locate operations can be synchronized.

- **Send/receive control change information**

The MRS-802 can receive Control Change messages from an external MIDI device to perform a control change, set the drum kit level, and so on. The MRS-802 also can send out Control Change messages according to drum level information contained in a rhythm song.

For a list of supported Control Change messages, see the appendix at the end of this manual.

- **SMF playback**

The MRS-802 can read Format 0 SMFs (Standard MIDI Files) from a CD-R/RW/ROM disc and load the contents into a project. Once loaded, an SMF can use internal or external sound sources and perform playback in sync with the recorder section or rhythm section (SMF player function).

Making MIDI-related settings

This section explains how to make MIDI-related settings. The procedure is the same for most settings. The basic steps are as follows.

Basic procedure

1. Press the [DRUM] key in the rhythm section, and then press the [UTILITY] key.

The rhythm utility menu for making various rhythm section settings appears.

2. Use the cursor left/right keys to bring up the indication "UTILITY MIDI" on the display.

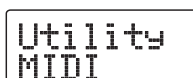

A rectangular display showing the text "Utility" on the top line and "MIDI" on the bottom line.

3. Press the [ENTER] key.

Now you can select MIDI-related setting items.



A rectangular display showing the text "MIDI" on the top line and "DRUM CH" on the bottom line.

4. Use the cursor left/right keys to select one of the following items, and press the [ENTER] key.

- **DRUM CH**

Set the MIDI channel of the drum track.

- **SPP**

Turn Song Position Pointer transmission on/off.

- **COMMAND**

Turn Start/Stop/Continue message transmission on/off.

- **CLOCK**

Turn Timing Clock transmission on/off.

- **HINT** ■

There is no parameter for turning Control Change on or off. When the drum kit is set to send and receive MIDI messages,

Control Change send/receive is also enabled.

5. Press the [ENTER] key to display the setting of the selected item, and turn the dial to change the setting.

For details on each item, refer to the following explanation.

- **NOTE** ●

Operation steps related to SMF are explained on page 131.

6. When you have finished making settings, press the [EXIT] key several times.

The unit returns to the main screen.

Setting the drum kit MIDI channel

You can specify the MIDI channel for the drum kit. Refer to steps 1 - 4 of “Basic procedure” to bring up the indication “MIDI DRUM CH” on the display. Then turn the dial to select one of the following settings.



- **1 - 16CH**

MIDI channels 1 - 16 (default: 10)

- **OFF**

Channel messages (Note On/Off messages) will not be transmitted or received.

If you specify a MIDI channel (1 - 16) for the drum track, you can transmit Note On/Off messages from an external MIDI device on that MIDI channel to play the sounds of the MRS-802's drum kit. Also, when you play back a rhythm pattern (or rhythm song) on the MRS-802, the content of the drum track will be transmitted as Note On/Off messages.

NOTE

If the “DRUM CH” setting is OFF, Note On/Off messages as well as Control Change messages will not be transmitted or received.

Specifying transmission of Timing Clock messages

This setting specifies whether the MIDI synchronization message Timing Clock will be transmitted.

Refer to steps 1 - 4 of “Basic procedure” to bring up the indication “MIDI CLOCK” on the display. Then turn the dial to select one of the following settings.

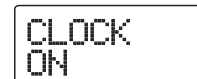

- **ON (Transmission on)**

MIDI Timing Clock will be transmitted when the MRS-802 is running (default setting).

- **OFF (Transmission off)**

Timing Clock will not be transmitted.

Timing Clock will be output according to the tempo of the rhythm pattern/rhythm song that is playing. In order for the external MIDI device to play back in synchronization at an appropriate tempo, you will need to specify the tempo and time signature of the rhythm pattern (rhythm song) even if you are not using the rhythm section.

NOTE

Timing Clock will be transmitted even if the drum track is muted (DRUM status key out).

HINT

- When using MIDI Timing Clock messages transmitted from the MRS-802 to synchronize the operation of an external MIDI device, you should also turn on transmission for Song Position Pointer and Start/Stop/Continue messages as well as Timing Clock.
- When transmitting Timing Clock from the MRS-802, it is recommended to turn the drum MIDI channel OFF. Synchronization may become unstable if MIDI messages other than Timing Clock are also being transmitted.

Specifying transmission of Song Position Pointer messages

You can specify whether Song Position Pointer messages will be transmitted. Song Position Pointer is a MIDI message that indicates the current position as a beat count from the start. Normally it is used in conjunction with Timing Clock.

Refer to steps 1 - 4 of “Basic procedure” to bring up the indication “SPP” on the display. Then turn the dial to select one of the following settings.



- **ON (Transmission on)**

MIDI Song Position Pointer messages will be transmitted when a Locate operation is performed on the MRS-802 (default setting).

- **OFF (Transmission off)**

Song Position Pointer messages will not be transmitted.

Specifying transmission of Start/Stop/Continue messages

You can specify whether Start/Stop/Continue messages will be transmitted. Start/Stop/Continue are MIDI messages that control the transport of a device, causing it to run or stop. Normally these messages are used in conjunction with Timing Clock.

Refer to steps 1 - 4 of “Basic procedure” to bring up the indication “MIDI COMMAND” on the display. Then turn the dial to select one of the following settings.



- **ON (Transmission on)**

The appropriate Start/Stop/Continue message will be transmitted when the MRS-802 stops or begins running (default setting).

- **OFF (Transmission off)**

Start/Stop/Continue messages will not be transmitted.

Using the SMF player

Using the SMF player function, the MRS-802 can read Format 0 SMF (Standard MIDI Files) from a CD-ROM/RW disc and load the contents into a project. Once loaded, an SMF can use internal or external sound sources and perform playback in sync with the recorder section or rhythm section. This section explains how to use this function.

HINT

“Format 0” is a type of SMF that contains all MIDI channel playing information in a single track. The MRS-802 can only read this type of SMF.

NOTE

The following SMF types cannot be read.

- Format 1 or Format 2
- Files not conforming to ISO 9660 Level 2 or with an extension other than “.MID”
- Files written to disc in an open session

Reading an SMF into a project

By performing the following steps, you can read an SMF from a CD-ROM/RW disc and load it in a project. The maximum number of SMFs per project is 100.

HINT

By using an option board (UIB-01/UIB-02), it is possible to directly copy SMFs from a computer to a project (PROJxxx folder). For details, see the information in the appendix of this manual.

1. Insert the CD-ROM or CD-R/RW disc containing the SMF into the CD-R/RW drive.

2. From the main screen, press the [UTILITY] key in the display section.

The utility menu appears.

3. Use the cursor left/right keys to bring up the indication “UTILITY SMF” on the display, and press the [ENTER] key.

The SMF menu appears.

SMF
IMPORT

- 4.** Verify that “SMF IMPORT” is shown on the display and press the [ENTER] key.

The names of SMFs on the CD-ROM/R/RW disc are shown.

IMPORT
SEQ1

↑
File names

- 5.** Turn the dial to select the SMF to import.

NOTE

If the desired file is not shown, check whether the file is in Format 0.

- 6.** To execute the import process, press the [ENTER] key.

When import is completed, the unit returns to the condition of step 4. To import other SMFs, repeat steps 5 - 6.

- 7.** To return to the main screen, press the [EXIT] key several times.

Selecting the SMF output destination

When playing an SMF, the MRS-802 can use either an internal or external sound source or both. The SMF output destination is specified using the following two parameters.

- **SMF OUTPUT**

Determines whether SMF playing information is supplied at the MIDI OUT connector.

- **SMF ChToDrum**

Selects which MIDI channel (1 - 16) of the SMF playing information is directed to the internal drum kit of the MRS-802. Information for the channel selected here will not be present at the MIDI OUT connector. When this parameter is set to OFF, no playing information is sent to the drum kit.

The diagram below shows a setting example for using the MRS-802 as an SMF player and using external sound sources. In this example, the SMF playing information is sent only to the MIDI OUT connector.

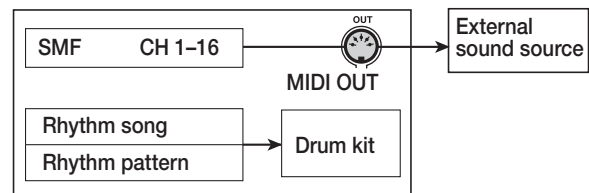

NOTE

When an SMF is played in the above condition, the rhythm song or rhythm pattern of the MRS-802 will be played at the same time. If you do not want to play the drum kit sound, set the [DRUM] status key to OFF or select an empty rhythm song/rhythm pattern.

The diagram below shows a setting example for using the MRS-802 as an SMF player and using internal and external sound sources together. In this example, MIDI channel 10 of the SMF playing information is sent to the drum kit, and the other MIDI channels to the MIDI OUT connector.

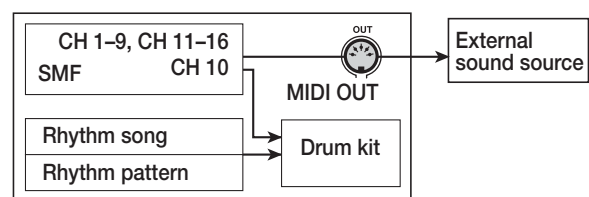

NOTE

When an SMF is played in the above condition, the SMF playing information and the rhythm song or rhythm pattern information of the MRS-802 will be sent to the internal drum kit at the same time. If you want to use the drum kit only for the SMF, you must first select an empty rhythm song/rhythm pattern.

HINT

Control Change information in the SMF acts directly on the drum kit.

- 1.** From the main screen, press the [UTILITY] key in the display section.

The utility menu appears.

- 2.** Use the cursor left/right keys to bring up the indication "UTILITY SMF" on the display, and press the [ENTER] key.

The SMF menu appears.

- 3.** To control SMF output from the MIDI OUT connector, use the cursor left/right keys to bring up the indication "SMF OUTPUT" on the display, and press the [ENTER] key.



OUTPUT
ON

- 4.** Turn the dial to select ON (output enabled) or OFF (output disabled). Then press the [EXIT] key.

The display returns to the SMF menu.

HINT

The factory default setting is "ON".

- 5.** To select the MIDI channel to be assigned to the internal drum kit, use the cursor left/right keys to bring up the indication "SMF ChToDrum" on the display, and press the [ENTER] key.



ChToDrum
10CH

- 6.** Turn the dial to select one of the settings listed below, and press the [EXIT] key.

- OFF**

No SMF playing information is sent to the drum kit.

- 1 - 16**

The playing information of the selected MIDI channel is sent to the drum kit and not to the MIDI OUT connector.

HINT

The factory default setting is "10" (MIDI channel 10).

- 7.** To return to the main screen, press the [EXIT] key several times.

SMF playback

You can select any SMF imported into a project and play it as follows.

- 1.** From the main screen, press the [UTILITY] key in the display section.

The utility menu appears.

- 2.** Use the cursor left/right keys to bring up the indication "UTILITY SMF" on the display, and press the [ENTER] key.

The SMF menu appears.

- 3.** Use the cursor left/right keys to bring up the indication "SMF FILE SEL" on the display.



- 4.** Press the [ENTER] key.

The display changes as follows, allowing you to select an imported SMF for playback.



- 5.** Turn the dial to select the SMF, and press the [ENTER] key.

The file is selected, and the display returns to the condition of step 3.

- 6.** To return to the main screen, press the [EXIT] key several times.

- 7.** To play the SMF, press the PLAY [▶] key.

The SMF is played in conjunction with the recorder section/rhythm section.

NOTE

- When playing an SMF, the recorder section/rhythm section will always be activated and linked to the SMF, regardless of the [DRUM] key status (on/off).
- When playing an SMF including tempo information, locating a measure/beat in the song of the MRS-802 may therefore lead to a mismatch with the measure/beat of the SMF.

Reference [Other Functions]

This section explains various other functions of the MRS-802.

Changing the function of the foot switch

With the default settings of the MRS-802, a foot switch connected to the CONTROL IN jack can be used to control play/stop of the recorder. If you want to use the foot switch to control manual punch-in/out recording (→ p. 35), use the following procedure to change the internal setting.

- 1.** From the main screen, press the [UTILITY] key in the display section.

The utility menu appears.

```
UTILITY
TR EDIT
```

- 2.** Use the cursor left/right keys to bring up the indication "UTILITY SYSTEM" on the display, and press the [ENTER] key.

The system utility menu for making various system settings appears.

```
SYSTEM
FOOT SW
```

- 3.** Verify that the indication "SYSTEM FOOT SW" is on the display, and press the [ENTER] key.

The function currently assigned to the foot switch will be displayed.

```
FOOT_SW
PLY_STP
```

- 4.** Turn the dial to select "PLY_STP" or "PUNCH IO".

The settings are as follows.

- **PLY_STP**

Each push of the foot switch toggles between play and stop of the recorder section (default setting).

- **PUNCH IO**

The foot switch can be used to perform manual punch-in/out. (Pressing the foot switch has the same effect as pressing the REC [●] key.)

- 5.** To return to the main screen, press the [EXIT] key several times.

Using the tuner function

The MRS-802 has a built-in chromatic tuner that can be used when tuning an instrument connected to the GUITAR/BASS or INPUT 1/2 jacks. This section explains how to use the tuner.

1. Connect the instrument that you want to tune to the GUITAR/BASS jack or one of the INPUT 1/2 jacks, and activate the corresponding key ([INPUT 1] key or [INPUT 2] key.)

HINT

If you activate both the [INPUT 1] and [INPUT 2] keys, the input signals are mixed and sent to the tuner.

2. Press the [BYPASS/TUNER] key in the effect section, and press the [ENTER] key.

The indication "TUNER" appears on the display, and the tuner is activated. While the tuner function is on, the insert effect and send/return effect are temporarily disabled.

The right side of the second line on the display shows the current reference pitch. In the default condition, this is Center A = 440 Hz.

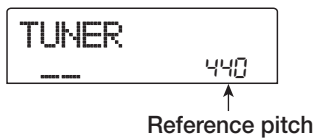

3. Play the note that you want to tune, and tune your instrument so that the desired note name (C, C#, D, D#, E...) appears on the display.

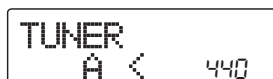

4. When the desired note name appears, watch the ">" and "<" symbols on the display, and make fine adjustments to the tuning.

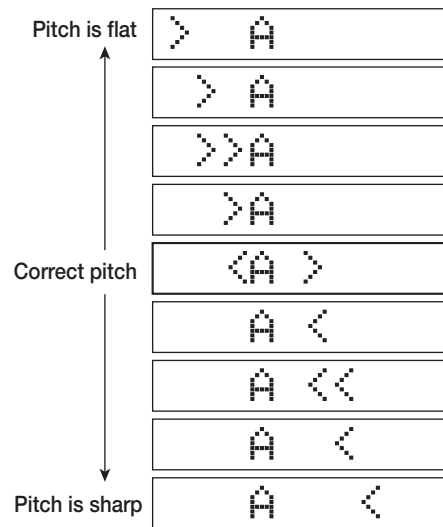

5. If you want to change the reference pitch of the tuner, turn the dial.

The reference pitch of the tuner can be adjusted in the range of 435 - 445 Hz.

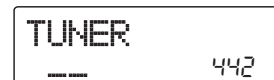

6. When you have finished tuning, press the [EXIT] key.

The unit returns to the previous condition, but with the effects still bypassed. When you press the [EXIT] key once more, the insert effect and send/return effect will revert to the original condition.

Switching the level meter display type

The level meter below the display can indicate the level of the signal before passing through the level controls/faders (pre-fader) or after passing through the level controls/faders (post-fader). You can change the setting as follows.

1. From the main screen, press the [UTILITY] key in the display section.

The utility menu appears.

```
UTILITY
TR EDIT
```

2. Use the cursor left/right keys to bring up the indication "UTILITY SYSTEM" on the display, and press the [ENTER] key.

The system utility menu for making various system settings appears.

```
SYSTEM
FOOT SW
```

3. Use the cursor left/right keys to bring up the indication "SYSTEM LVL MET" on the display, and press the [ENTER] key.

The current level meter setting will be displayed.

```
LVL MET
POST
```

The setting has the following meaning.

- **POST**

The meters show the level of the signal after passing through the [REC LEVEL] controls/faders (default setting).

- **PRE**

The meters show the level of the signal before passing through the [REC LEVEL] controls/faders.

4. Turn the dial to change the setting.
5. To return to the main screen, press the [EXIT] key several times.

Hard disk maintenance

This section describes how to test and restore the integrity of data on the internal hard disk, and how to perform other hard disk maintenance functions.

Basic maintenance procedure

The procedure for hard disk maintenance is the same for most operations. The basic procedure is as follows.

1. Turn power to the MRS-802 off. While holding down the [CLEAR] key, turn power on again.

The MRS-802 starts up in "ROM utility mode" which serves for performing special functions.

```
ROM UTY
MRS-802
```

2. Press the [MARK] key in the control section.

The indication "ExtFunc" appears on the display.

```
ExtFunc
<Select>
```

3. Use the cursor left/right keys to select the desired command.

The following commands are available.

- **ScanDisk**

Test and repair the integrity of data stored on the internal hard disk.

- **Init Fac (Factory Initialize)**

Restore files and data necessary for operation such as the system files. Data created by the user will not be erased.

- **Init ALL (All Initialize)**

Format the internal hard disk and then restore files and data necessary for operation such as the system files. All existing projects on the hard disk will be erased.

4. Press the [ENTER] key to execute the command. Subsequent display indications and operation steps differ for the individual commands. See the respective section below.

- When the command has been executed, turn the unit off and then turn it on again.

The MRS-802 will operate in normal mode.

Test/restore integrity of data on internal hard disk (ScanDisk)

This action serves to test the disk and perform restorative action if necessary. Try using this function when operation of the MRS-802 has become unstable.

NOTE

ScanDisk may not be able in all cases to restore damaged files. To guard against data loss, it is recommended to regularly back up data from the hard disk onto CD-R/RW discs.

- Refer to steps 1 - 3 of “Basic maintenance procedure” to bring up the indication “ScanDisk” on the display. Then press the [ENTER] key.

The ScanDisk menu for selecting the test function appears.

```
AutoRepr
<-ENT->
```

- Use the cursor left/right keys to select the ScanDisk function.

- AutoRepr (Auto Repair)**

This function tests all files on the hard disk and automatically repairs damaged files.

- ChekFile (Check File)**

This function only tests all files, but does not automatically repair them. If a problem is found, a message is displayed on the screen.

- To execute the selected function, press the [ENTER] key.

The ScanDisk operation starts.

Once ScanDisk has started, it cannot be interrupted by the user. Never turn power to the unit off while ScanDisk is running. Otherwise the hard disk may be destroyed.

- When ScanDisk is completed, press the [EXIT] key.

The unit returns to the condition of step 1.

Rewriting system file data (Factory Initialize)

This action restores only the system files and other data necessary for operation of the MRS-802. Audio data created by the user are not affected by this operation. Try using this function if operation of the MRS-802 is still unstable even after using the ScanDisk function.

- Refer to steps 1 - 3 of “Basic maintenance procedure” to bring up the indication “Init Fac” on the display. Then press the [ENTER] key.

The indication “Init Fac SURE?” appears on the display to confirm the operation.

```
Init Fac
Sure?
```

- To carry out the initialization process, press the [ENTER] key once more.

The factory initialize process starts. When it is complete, the unit returns to the condition of step 1.

Formatting the hard disk (All Initialize)

This action formats the hard disk of the MRS-802 and then restores the system files and other data necessary for operation of the MRS-802. All existing projects on the hard disk including the demo songs will be erased.

NOTE

Once erased, projects cannot be restored. Use this function with extreme care. If you want to preserve projects, back them up to CD-R/RW disc first (→ p. 119).

- Refer to steps 1 - 3 of “Basic maintenance procedure” to bring up the indication “Init ALL” on the display. Then press the [ENTER] key.

The indication “Init ALL SURE?” appears on the display to confirm the operation.

```
Init ALL
Sure?
```

- 2. To carry out the initialization process, press the [ENTER] key once more.**

The all initialize process starts. When it is complete, the unit returns to the condition of step 1.

Hard disk maintenance using supplied CD-ROM

Certain hard disk maintenance functions can be performed using the CD-ROM supplied with the MRS-802.

■ Restoring the unit to the factory default condition (RECOVER)

This action restores the entire hard disk of the MRS-802 (including the demo songs) to the factory default condition. All data created by the user will be erased.

■ Factory initialize (VER UP)

This action restores the system files and other data necessary for operation of the MRS-802.

- 1. With the supplied CD-ROM inserted in the CD-R/RW drive, turn the MRS-802 on by pressing the [POWER] switch on the rear panel.**
- 2. Use the cursor left/right keys to select "RECOVER?" (to return the unit to the factory default condition) or "VER UP" (to perform factory initialize) and press the [ENTER] key.**

The indication "Sure?" appears for confirmation of the action. If you wish to cancel the action, press the [EXIT] key. When the indication "Please PowerOff" is shown, set the [POWER] switch to OFF to turn the unit off.

- 3. To carry out the action, press the [ENTER] key once more.**

The maintenance process starts. When it is complete, the indication "Done" is shown. Remove the CD-ROM from the drive and turn the unit off and on again.

Connecting to a computer with an option card

If the optional USB board UIB-01/UIB-02 is installed in the MRS-802, the internal hard disk of the MRS-802 can be recognized by a computer, for audio data editing, project backup etc. To make this possible, connect the computer and MRS-802 with a USB cable and start the MRS-802 in USB mode.

■ HINT ■

Depending on the computer and the operating system, driver installation may be required. For details, see the on-line manual supplied with the UIB-01/UIB-02.

- 1. Verify that power to the MRS-802 is turned off. Then connect the option board to the computer with a USB cable.**
- 2. While holding down the [CLEAR] key in the control section, turn power to the MRS-802 on.**

The following screen appears on the display.

```
ROM UTY
MRS-802
```

- 3. Press the [AUTO PUNCH IN/OUT] key in the control section.**

The following screen appears on the display, and the MRS-802 switches to USB mode.

```
I/F
WORKING
```

When USB is activated, the computer automatically recognizes the internal hard disk of the MRS-802 and goes into the on-line state.

For details on operation, see the on-line manual supplied with the UIB-01/UIB-02.

- 4.** To terminate the connection, cancel the on-line state at the computer.

The procedure for this differs depending on the computer system. For details, see the on-line manual supplied with the UIB-01/UIB-02.

- 5.** To terminate the USB mode and start the unit in normal mode, press the [EXIT] key.
- 6.** To turn off the power, set the [POWER] switch to OFF. When the following screen appears on the display, press the [ENTER] key.



```
PowrOFF
ENT/EXIT
```

Appendix

MRS-802 Specifications

● Recorder

Number of physical tracks	10
Number of virtual tracks	100 (10 V-takes per track)
Drum track	1 (stereo)
Number of simultaneous recording tracks	2
Number of simultaneous playback tracks	10 (8 audio tracks + stereo drum)
Recording data format	16-bit linear (non-compressed)
Maximum recording time	Approx. 3 hours/gigabyte (referred to mono tracks)
Number of projects	1000
Marker function	100 mark points per project
Locate function	Hour/Min/Sec/mSec/Meas/Beat/Tick
Track edit functions	Copy, move, erase, exchange, trim, fade-in/out, reverse, time stretch/compression
Punch-in/out function	Manual, auto
Other functions	Bounce, scrub/preview, A-B repeat, capture/swap, phrase loop

● Mixer

Faders	10 (1-8 mono, drum, stereo master)
Level meter indication	Post fader/pre fader (selectable), fader value monitor function
Track parameters	Equalizer, effect send, panning (balance)
Equalizer	HIGH (f: 500 Hz - 18 kHz, gain: ±12 dB) LOW (f: 40 Hz - 1.6 kHz, gain: ±12 dB)
Effect send	Chorus/delay, reverb
Stereo linking	Tracks 1/2, 3/4, 5/6, 7/8 selectable
Scene function	100 scenes per project

● Effects

Algorithms	8 types (CLEAN, DIST, ACO/BASS SIM, BASS, MIC, DUAL MIC, LINE, MASTERING)
Number of patches	Insert effect 280, send/return 40
Number of effect modules	Insert effect 6, send/return 2
Tuner principle	Chromatic auto tuner

● Rhythm section

Number of voices	8
Sound source principle	16-bit linear PCM
Drum kits	43
Drum sound sources	24 per drum kit (8 x 3 banks)
Resolution	48 PPQN
Beat range	1/4 - 8/4
Rhythm patterns	511/project

Rhythm songs	10/project
Maximum number of measures	999/song, 99/pattern
Number of notes	approx. 20000/song
Tempo range	40.0 - 250.0 BPM

Hard disk	3.5 inch E-IDE type
A/D converter	24-bit, 64-times oversampling
D/A converter	24-bit, 128-times oversampling
Sampling frequency	44.1 kHz
Signal processing	24-bit
Frequency response	20 Hz - 20 kHz ±1 dB (10-kilohm load)
S/N ratio	93 dB (IHF-A)
Dynamic range	97 dB (IHF-A)
THD + N	0.02% (400 Hz, 10-kilohm load)
Display	66 x 52 mm, custom LCD (with backlight)
Guitar/bass input	Standard mono phone jack, input impedance 500 kilohms
Balanced/unbalanced inputs	XLR/standard phone combo jack Balanced operation: input impedance 1 kilohm, pin 2 hot Unbalanced operation: input impedance 50 kilohms, unbalanced
Phantom power supply	48 V (with on/off switch)
Input level	-50 dBm to +4 dBm (continuously variable)
Master output	RCA type phono jacks (L/R)
Output impedance	1 kilohm
Rated output level	-10 dBm
Headphone output	Standard stereo phone jack, 50 mW (into 32-ohm load)
MIDI connectors	IN, OUT
Control input	FS01/FP02 combined
Expansion board slot	1
Dimensions	430 (W) x 270 (D) x 105 (H) mm
Weight	5 kg (with CD-R/RW drive) 4 kg (without CD-R/RW drive)
Power supply	12 V DC, 2 A (from supplied AC adapter AD-0009)
Power consumption	20W (12 V, 1 A) typ.
Supplied accessories	Warranty card, instruction manual, demo song list, AC adapter, AC cable, CD-ROM
Optional accessories	Foot Switch FS01 Expression Pedal FP02 USB Interface Board UIB-01/ UIB-02

0 dB = 0.775 Vrms

Design and specifications subject to change without notice.

Troubleshooting

If there are problems during operation of the MRS-802, check the following points first.

Problems during playback

■ No sound, or sound is very weak

- Check the connections to your audio system, and the volume of your audio system.
- Make sure that the status keys in the mixer section are lit in green and that the faders are raised. If a key is out, press the it to make it light up in green.
- If a scene with the volume lowered has been assigned to a mark, the volume will automatically be lowered when that mark is reached. Delete the scene that is assigned to the mark (→ p. 76).
- The recorder will not operate when the [DRUM] key is lit. Press the [EXIT] key so that the [DRUM] key goes out.

■ Operating the fader does not affect the volume

- On channels for which stereo link is turned on, the fader of the even-numbered channel will have no effect. Either turn stereo link off (→ p. 73), or operate the fader of the odd-numbered channel.

■ The display indicates "Don't Play" and playback is not possible

- The recorder will not operate in the current screen. Press the [EXIT] key several times to switch to the main screen.

■ No sound from input signal, or sound is very weak

- Make sure that the [INPUT 1]/[INPUT 2] key is lit.
- Make sure that the respective [INPUT] control is raised.
- Make sure that the [REC LEVEL] control is raised. If it is raised, temporarily turn it down and then up again.

■ The indication "STOP RECORDER" is shown on the display, and operation is not possible.

The current operation is not possible while the recorder is operating. Press the STOP [■] key to stop the recorder.

Problems during recording

■ Cannot record on a track

- Make sure that you have selected a recording track.
- Check whether you have run out of free space on the hard disk (→ p. 125).
- Recording is not possible if the project is write-protected. Either turn protect off (→ p. 127), or use a different project.

■ The signal from an instrument or microphone connected to the INPUT 1 jack is not input

- When something is connected to both the INPUT 1 jack and the GUITAR/BASS jack, the GUITAR/BASS jack has priority.

■ The recorded sound is distorted

- Check whether the input sensitivity setting ([INPUT control]) and recording level setting ([REC LEVEL] control) are appropriate.
- Lower the fader so that the 0 (dB) dot of the level meter does not light.
- If the EQ gain of the track mixer is set extremely high, the sound may be audibly distorted even if the fader is lowered. Set the EQ to an appropriate value.

Problems with effects

■ Insert effect does not apply

- Make sure that the [BYPASS/TUNER] key is out.
- Make sure that the insert effect is sent to the desired location (→ p.101).

■ Send/return effect does not apply

- Make sure that the [CHORUS/DELAY] or [REVERB] key is lit. If it is out, press the key several times to make it light.

- For each channel of the mixer, make sure that the REVERB SEND or CHORUS/DELAY SEND parameter is turned on. If it is on, make sure that the send level is raised (→ p. 72).

Problems with the rhythm section

■ Cannot hear the rhythm pattern play back

- Make sure that the [DRUM] status key is lit in green.
- Make sure that the [DRUM] fader is raised. If the fader is already raised, lower it and then raise it once more.
- Make sure that you have not selected a blank rhythm pattern (pattern name "EMPTY").

■ Cannot hear the rhythm song play back

- In the case of a new project, all rhythm songs will be empty, so you will hear no sound. Either create a new rhythm song, or load a project for which a rhythm song has already been created.
- When using Control Change signals sent from an external MIDI device, the drum kit volume may be lowered. Set the MIDI channel for the drum kit to OFF or check the setting at the external MIDI device.

■ Cannot record or edit a rhythm pattern/ rhythm song

- When the [DRUM] key is out or blinking, it is not possible to record or edit a rhythm pattern or rhythm song. Press the [DRUM] key to make the key light.
- If the display indicates "FULL", this means that you have used up the rhythm section memory. Please delete unneeded rhythm patterns.

■ Sounds recorded in the rhythm pattern do not play

- Sounds that exceed the maximum polyphony will not be played. Either delete some of the other notes that have already been recorded (→ p. 93), or stay within the maximum polyphony when you record.

Problems with MIDI

■ The drum kit of the MRS-802 cannot be played from an external MIDI device

- Make sure that a MIDI cable is correctly connected from the MIDI OUT connector of the external device to the MIDI IN connector on the MRS-802.
- Make sure that the MIDI send channels of the external device match the MIDI receive channels for the drum kit at the MRS-802.

■ Cannot synchronize with an external MIDI device

- Make sure that a MIDI cable is correctly connected from the MIDI OUT connector of the MRS-802 to the MIDI IN connector of the external device.
- At the MRS-802, make sure that output is enabled for the Timing Clock, Song Position Pointer, and Start/Stop/Continue messages (→ p. 130).
- Make sure that the external MIDI device is set to receive the Timing Clock and synchronize to it.
- Make sure that the external MIDI device is in playback mode.

■ Cannot load SMF from CD-ROM or CD-R/RW disc

- Make sure that the SMF is Format 0 and that the file name and extension are appropriate.
- Files written to a CD-R/RW disc in an open session will not be recognized. Close the session and then try the load process again.

■ Cannot play SMF

- Make sure that SMF output is set to "ON" (SMF playing information is output from the MIDI OUT connector) (→ p. 132).

Problems with CD-R/RW drive

■ Cannot play audio CD created with MRS-802 on ordinary CD player

- Check whether the disc was finalized.
- Check whether the CD player is an old model.
On some old CD players, CD-R/RW discs will not play properly as audio CDs, even if the disc was finalized.
- Discs created using CD-RW media will not be playable on an ordinary CD player.

■ Cannot write audio data to CD-R/RW disc

- Check whether the disc was already finalized.

■ Cannot perform backup

- Check whether audio data have already been written to the disc.

■ Cannot restore a project spanning several discs

- Check whether the proper disc has been inserted.
- When a project backup spans several discs, insert disc number 1. When the entire hard disk was backed up, insert the first disc that contains data of the desired project.

Other problems

■ Connection with other equipment leads to noise.

- Grounding using the screw on the bottom of the chassis may be helpful.

■ Cannot save the project

- The project cannot be saved if the Protect setting is on. Turn Protect off (→ p. 127).

■ Cannot create a new project or copy a project

- If the display indicates "FULL", this means that no further projects can be created. Delete projects that are no longer needed.

■ One of the following messages is shown when attempting to execute a command.

FULL

There is not enough free space on the CD-R/RW disc.

INSERT

DISCxxx

Insert the disc with the number xxx.

NO AUDIO

The disc in the CD-R/RW drive is not an audio disc.

NO DATA

The specified data do not exist.

NO DISC

No disc is inserted in the CD-R/RW drive.

NotBLANK

The CD-R/RW disc is not empty.

NOT CD-R

The disc inserted in the CD-R/RW drive is not a CD-R/RW disc.

HDD FULL

There is not enough free space on the internal hard disk.

PRJ FULL

No more projects can be created on the internal hard disk.

Effect Type/Parameter List

Insert effect

■ CLEAN, DIST, ACO/BASS SIM, BASS algorithm

● COMPRESSOR module

Type	Parameter		
COMP	SENS	ATTACK	LEVEL
	Compressor for keeping dynamic range consistent.		

[Parameter Description]

Parameter Name	Setting Range	Parameter Description
SENS	0 – 10	Adjusts the compression input sensitivity.
ATTACK	0 – 10	Adjusts the compression attack speed.
LEVEL	1 – 8	Adjusts the module output level.

● PREAMP/DRIVE module

Type	Parameter						
J-CLN	GAIN	TONE	LEVEL				
	Clean sound that models a transistor combo amp.						
US-CLN	GAIN	TONE	LEVEL				
	Clean sound that models a built-in type vacuum tube amp.						
US-DRV	GAIN	TONE	LEVEL				
	Drive sound that models a built-in type vacuum tube amp.						
Tweed	GAIN	TONE	LEVEL				
	Model of a small built-in vacuum tube combo amp with dry distortion.						
Class A	GAIN	TONE	LEVEL				
	Unique crunch sound that models a British-style combo amp.						
UK-CRU	GAIN	TONE	LEVEL				
	Crunch sound that models a British-style vacuum tube stack amp.						
UK-DRV	GAIN	TONE	LEVEL				
	Drive sound that models a British-style vacuum tube stack amp.						
CMB 335	GAIN	TONE	LEVEL				
	Models a vacuum tube combo amp characterized by long sustain.						
MTL PNL	GAIN	TONE	LEVEL				
	High-gain drive sound that models a vacuum tube stack amp.						
BLK BTM	GAIN	TONE	LEVEL				
	Model of a vacuum tube stack amp, characterized by fat bass and delicate distortion.						
MD LEAD	GAIN	TONE	LEVEL				
	Drive sound that models a high-gain amp suitable for lead guitar.						
FZ-STK	GAIN	TONE	LEVEL				
	60's sound typical of a Fuzz unit played through an amp stack.						
TE Bass	GAIN	TONE	LEVEL				
	Model of a bass amp with a distinctively clean low-mid range.						
FD Bass	GAIN	TONE	LEVEL				
	Model of a bass amp with vintage-style drive.						
SnsBass	GAIN	TONE	LEVEL	CABINET	SPEAKER	DEPTH	
	Trebly drive sound for bass.						
CR+CAB	GAIN	TONE	LEVEL	CABINET	SPEAKER	DEPTH	
	Combination of crunch and cabinet simulator.						
TS+CAB	GAIN	TONE	LEVEL	CABINET	SPEAKER	DEPTH	
	Combination of vintage overdrive and cabinet simulator.						
GV+CAB	GAIN	TONE	LEVEL	CABINET	SPEAKER	DEPTH	
	Combination of vintage distortion and cabinet simulator.						
MZ+CAB	GAIN	TONE	LEVEL	CABINET	SPEAKER	DEPTH	
	Combination of metal-style distortion and cabinet simulator.						
9002+CB	GAIN	TONE	LEVEL	CABINET	SPEAKER	DEPTH	
	Combination of the Zoom 9002 distortion and cabinet simulator.						

Aco.Sim	TOP	BODY	LEVEL	CABINET	SPEAKER	DEPTH
	Transforms the sound of an electric guitar into an acoustic-guitar-like tone.					
E-AcPRE	COLOR	TONE	LEVEL	CABINET	SPEAKER	DEPTH
	Pre-amp for electric-acoustic.					
BassSim	TONE	LEVEL				
	Transforms the sound of an electric guitar into a bass-guitar-like tone.					
CABINET	CABINET	SPEAKER	DEPTH			
	Simulation of the cabinet of a guitar/bass amp.					

Parameter Description

Parameter Name	Setting Range	Parameter Description
GAIN	1 – 30	Adjusts the amount of gain.
TONE	0 – 10	Adjusts the tone.
LEVEL	1 – 8	Adjusts the module output level.
TOP	1 – 30	Adjusts the resonance of the strings.
BODY	0 – 10	Adjusts the resonance of the body.
CABINET	CM	Combo: Simulation of a combo-type cabinet.
	br	Bright Combo: Produces a brighter tone than Combo.
	Ft	Flat: A cabinet with a flat response.
	St	Stack: Produces the character of a stack-type cabinet.
	bC	BassCombo: The sound of a combo-type cabinet for bass.
SPEAKER	bS	BassStack: The sound of a stack-type cabinet for bass.
	C1	Combo 1: The sound of a combo-type guitar amp with one 12 inch speaker.
	C2	Combo 2: The sound of a combo-type guitar amp with two 12 inch speakers.
	C3	Combo 3: The sound of a combo-type guitar amp with one 10 inch speaker.
	GS	Gt Stack: The sound of a stack-type guitar amp with four 10 inch speakers.
	GW	Gt Wall: The sound of multiple stack-type amps placed together.
	bC	Bs Combo: The sound of a combo-type bass amp with one 15 inch speaker.
bS	Bs Combo: The sound of a stack-type bass amp with four 6.5 inch speakers.	
DEPTH	0 – 10	Adjusts the cabinet resonance of the speaker.
COLOR	1 – 4	Adjusts the character of the electric-acoustic preamp.

● **3 BAND EQ module**

Type	Parameter			
3BandEQ	HIGH	MID	LOW	LEVEL
	Three-band equalizer.			

Parameter Description

Parameter Name	Setting Range	Parameter Description
HIGH	-12 – 12	Boosts/cuts the high-frequency range.
MID	-12 – 12	Boosts/cuts the mid-frequency range.
LOW	-12 – 12	Boosts/cuts the low-frequency range.
LEVEL	1 – 8	Adjusts the module output level.

● **ZNR module**

Type	Parameter
ZNR	THRSHOLD
	Zoom's proprietary noise reduction that minimizes noise in play pauses.

Parameter Description

Parameter Name	Setting Range	Parameter Description
THRSHOLD	OFF, 1 – 30	Adjusts the sensitivity of ZNR. For best results, set this as high as possible without allowing the attacks or decays to sound unnatural.

● VOL PDL module

Type	Parameter
VOL PDL	MIN VOL
	You can use an expression pedal to control the volume.

Parameter Description

Parameter Name	Setting Range	Parameter Description
MIN VOL	0 – 10	When using an expression pedal as a volume pedal, this parameter specifies the minimum volume.

● MODULATION/DELAY module

Type	Parameter			
CHORUS	DEPTH	RATE	MIX	
	Stereo chorus with clear sound and great spaciousness.			
FLANGER	DEPTH	RATE	FB	
	An effect that adds a pronounced character and modulation to the sound.			
PHASER	POSITION	RATE	COLOR	
	An effect that adds a swooshing modulation to the sound.			
TREMOLO	DEPTH	RATE	CLIP	
	An effect that cyclically varies the volume.			
PDL-WAH	POSITION	FREQ	LEVEL	RTM
	An effect that lets you use an expression pedal to control wah manually.			
AutoWah	FLT TYPE	POSITION	RESO	SENS
	An effect in which wah is applied according to your playing dynamics.			
PITCH	SHIFT	STONE	BALANCE	
	An effect that modifies the pitch of the direct sound.			
RingMod	POSITION	RATE	BALANCE	
	An effect that produces a metallic resonance.			
EXCITER	FREQ	DEPTH	LowBoost	
	An effect that gives the sound more focus and spatial definition.			
AIR	SIZE	STONE	MIX	
	Simulates the effect of air on the room resonance, giving the sound spatial depth.			
WIDE	TIME	WET LVL	DRY LVL	
	An effect that produces the sound of a stereo recording made with two mics.			
DELAY	TIME	FB	MIX	
	A delay effect with a maximum of 500 ms.			

Parameter Description

Parameter Name	Setting Range	Parameter Description
DEPTH	0 – 10	Adjusts the depth of the effect.
RATE	1 – 30	Adjusts the speed of the effect.
MIX	0 – 30	Adjusts the mix amount of the effect.
FB	TYPE = FLANGER : -10 – 10	Adjusts the amount of feedback.
	TYPE = DELAY : 0 – 10	
POSITION	AF / bF	Exchanges the effect locations of the PREAMP/DRIVE module and MODULATION/DELAY module.
COLOR	1 – 4	Specifies the type of phase tone.
CLIP	0 – 10	Emphasizes the effect.
FREQ	TYPE = PDL-WAH : 1 – 50	Adjusts the frequency.
	TYPE = EXCITER : 1 – 5	
LEVEL	1 – 8	
RTM	OFF / On	Adjusts the module output level.
FLT TYPE	bPF / LPF	Specifies whether the expression pedal will be used as a wah pedal.
RESO	1 – 10	Specifies the type of filter.
SENS	-10 – 10	Adds character to the sound.
SHIFT	-12.0 – 24.0	Adjusts the sensitivity with which the effect is applied.
STONE	0 – 10	Adjusts the amount of shift produced by the pitch shifter.
BALANCE	0 – 30	Adjusts the tone.
LowBoost	0 – 10	Adjusts the balance between the direct sound and effect sound.
SIZE	1 – 10	Emphasizes the low-frequency range.
TIME	TYPE = WIDE : 1 – 64	Adjusts the spatial width.
	TYPE = DELAY : 1 – 50	Adjusts the delay time.
WET LVL	0 – 30	Adjusts the mix amount of the effect sound.
DRY LVL	0 – 30	Adjusts the mix amount of the direct sound.

■ MIC algorithm

● COMP/LIM module

Type	Parameter		
COMP	SENS	ATTACK	LEVEL
	Compressor for keeping dynamic range consistent.		
LIMITER	THRSHOLD	RELEASE	LEVEL
	Limiter for controlling signal peaks.		

Parameter Description

Parameter Name	Setting Range	Parameter Description
SENS	0 – 15	Adjusts the compression input sensitivity.
ATTACK	0 – 15	Adjusts the compression attack speed.
LEVEL	1 – 8	Adjusts the module output level.
THRSHOLD	0 – 15	Adjusts the limiter action threshold.
RELEASE	0 – 15	Adjusts the time delay between the threshold crossing point and compression finish.

● MIC PRE module

Type	Parameter			
MIC PRE	COLOR	TONE	LEVEL	DE-ESSER
	Preamp for use with external mic			

Parameter Description

Parameter Name	Setting Range	Parameter Description
COLOR	1 – 6	1. Flat response
		2. Lowcut only
		3. Acoustic guitar characteristics
		4. Acoustic guitar characteristics with low cut
		5. Vocal characteristics
		6. Vocal characteristics with low cut
TONE	0 – 10	Adjusts the tone.
LEVEL	1 – 8	Adjusts the module output level.
DE-ESSER	0 – 10	Adjusts the amount by which vocal sibilants will be cut.

● 3 BAND EQ module

For an explanation of types and parameters, see the CLEAN, DIST, ACOU/BASS SIM, BASS algorithm.

● ZNR module

For an explanation of types and parameters, see the CLEAN, DIST, ACOU/BASS SIM, BASS algorithm.

● VOL PDL module

For an explanation of types and parameters, see the CLEAN, DIST, ACOU/BASS SIM, BASS algorithm.

● MODULATION/DELAY module

Type	Parameter		
CHORUS	DEPTH	RATE	MIX
	Stereo chorus with clear sound and great spaciousness.		
FLANGER	DEPTH	RATE	FB
	An effect that adds a pronounced character and modulation to the sound.		
PHASER	RATE	COLOR	
	An effect that adds a swooshing modulation to the sound.		
TREMOLO	DEPTH	RATE	CLIP
	An effect that cyclically varies the volume.		
PITCH	SHIFT	TONE	BALANCE
	An effect that modifies the pitch of the direct sound.		
RingMod	RATE	BALANCE	
	An effect that produces a metallic resonance.		
EXCITER	FREQ	DEPTH	LowBoost
	An effect that gives the sound more focus and spatial definition.		
AIR	SIZE	TONE	MIX
	Simulates the effect of air on the room resonance, giving the sound spatial depth.		
DELAY	TIME	FB	MIX
	A delay effect with a maximum of 500 ms.		
DOUBLE	TIME	TONE	MIX
	A doubling effect that allows the delay time to be set in 1-ms steps up to 100 ms.		

Parameter Description

Parameter Name	Setting Range	Parameter Description
DEPTH	0 – 10	Adjusts the depth of the effect.
RATE	1 – 30	Adjusts the speed of the effect.
COLOR	1 – 4	Specifies the type of phase tone.
CLIP	0 – 10	Emphasizes the effect.
SHIFT	-12.0 – 24.0	Adjusts the amount of pitch shift produced by the pitch shifter. 1.0 corresponds to a semitone.
BALANCE	0 – 30	Adjusts the balance between the direct sound and effect sound.
FREQ	1 – 5	Adjusts the frequency.
LowBoost	0 – 10	Emphasizes the low-frequency range.
SIZE	1 – 10	Adjusts the spatial width.
FB	TYPE = FLANGER : -10 – 10	Adjusts the feedback amount.
	TYPE = DELAY : 0 – 10	
TIME	TYPE = DELAY : 1 – 50	Adjusts the delay time (x 10 ms)
	TYPE = DOUBLE : 1 – 100	Adjusts the delay time (x 1 ms)
TONE	0 – 10	Adjusts the tone.
MIX	0 – 30	Adjusts the mix amount of the effect sound.

■ DUAL MIC algorithm

● COMP/LIM module

For an explanation of types and parameters, see the MIC algorithm.

● MIC PRE module

Type	Parameter		
MIC PRE	COLOR	TONE	LEVEL
	Preamp for use with external mic		

Parameter Description

Parameter Name	Setting Range	Parameter Description
COLOR	1 – 6	1. Flat response
		2. Lowcut only
		3. Acoustic guitar characteristics
		4. Acoustic guitar characteristics with low cut
		5. Vocal characteristics
		6. Vocal characteristics with low cut
TONE	0 – 10	Adjusts the tone.
LEVEL	1 – 8	Adjusts the module output level.

● 3 BAND EQ module

For an explanation of types and parameters, see the CLEAN, DIST, ACO/BASS SIM, BASS algorithm.

● ZNR module

For an explanation of types and parameters, see the CLEAN, DIST, ACO/BASS SIM, BASS algorithm.

● VOL PDL module

For an explanation of types and parameters, see the CLEAN, DIST, ACO/BASS SIM, BASS algorithm.

● DOUBLING module

Type	Parameter		
DOUBLING	TIME	TONE	MIX
	A doubling effect that allows the delay time to be set in 1-ms steps up to 100 ms.		

Parameter Description

Parameter Name	Setting Range	Parameter Description
TIME	1 – 100	Adjusts the delay time (x 1 ms)
TONE	0 – 10	Adjusts the tone.
MIX	0 – 30	Adjusts the module output level.

■ LINE algorithm

● COMP/LIM module

For an explanation of types and parameters, see the MIC algorithm.

● ISOLATOR module

Type	Parameter				
ISOLATOR	XOVER_Lo	XOVER_Hi	MIX_HIGH	MIX_MID	MIX_LOW
	An effect that divides the signal into three frequency bands, and lets you specify the mix amount.				

Parameter Description

Parameter Name	Setting Range	Parameter Description
XOVER_Lo	50 – 16000	Adjusts the frequency for bass/midrange division.
XOVER_Hi	50 – 16000	Adjusts the frequency for midrange/treble division.
MIX_HIGH	OFF, -24 – 6	Adjusts the treble mix amount.
MIX_MID	OFF, -24 – 6	Adjusts the midrange mix amount.
MIX_LOW	OFF, -24 – 6	Adjusts the bass mix amount.

● 3 BAND EQ module

For an explanation of types and parameters, see the CLEAN, DIST, ACO/BASS SIM, BASS algorithm.

● ZNR module

For an explanation of types and parameters, see the CLEAN, DIST, ACO/BASS SIM, BASS algorithm.

● VOL PDL module

For an explanation of types and parameters, see the CLEAN, DIST, ACO/BASS SIM, BASS algorithm.

● MODULATION/DELAY module

Type	Parameter		
CHORUS	DEPTH	RATE	MIX
	Stereo chorus with clear sound and great spaciousness.		
FLANGER	DEPTH	RATE	FB
	An effect that adds a pronounced character and modulation to the sound.		
PHASER	RATE	COLOR	
	An effect that adds a swooshing modulation to the sound.		
TREMOLO	DEPTH	RATE	CLIP
	An effect that cyclically varies the volume.		
PITCH	SHIFT	TONE	BALANCE
	An effect that modifies the pitch of the direct sound.		
RingMod	RATE	BALANCE	
	An effect that produces a metallic resonance.		
DOUBLE	TIME	TONE	MIX
	A doubling effect that allows the delay time to be set in 1-ms steps up to 100 ms.		

Parameter Description

Parameter Name	Setting Range	Parameter Description
DEPTH	0 – 10	Adjusts the depth of the effect.
RATE	1 – 30	Adjusts the speed of the effect.
MIX	0 – 30	Adjusts the mix amount of the effect sound.
FB	TYPE = FLANGER : -10 – 10	Adjusts the feedback amount.
	TYPE = DELAY : 0 – 10	
COLOR	1 – 4	Specifies the type of phase tone.
CLIP	0 – 10	Emphasizes the effect.
SHIFT	-12.0 – 24.0	Adjusts the amount of pitch shift produced by the pitch shifter. 1.0 corresponds to a semitone.
TONE	0 – 10	Adjusts the tone.
BALANCE	0 – 30	Adjusts the balance between the direct sound and effect sound.
SIZE	1 – 10	Adjusts the spatial width.
TIME	1 – 100	Adjusts the delay time (x 1 ms).

■ MASTERING algorithm

● 3 BAND COMP/Lo-Fi module

Type	Parameter							
MLT CMP	XOVER_Lo	XOVER_Hi	SNS_HIGH	SENS_MID	SENS_LOW	MIX_HIGH	MIX_MID	MIX_LOW
	An effect that divides the input signal into three frequency bands and lets you specify a compressor and mix amount for each band.							
Lo-Fi	CHARA	COLOR	DIST	TONE	EFX LVL	DRY LVL		
	An effect that intentionally degrades the audio quality of the sound.							

Parameter Description

Parameter Name	Setting Range	Parameter Description
XOVER_Lo	50 – 16000	Adjusts the frequency for bass/midrange division.
XOVER_Hi	50 – 16000	Adjusts the frequency for midrange/treble division.
SNS_HIGH	0 – 15	Adjusts the compressor input sensitivity for the treble range.
SENS_MID	0 – 15	Adjusts the compressor input sensitivity for the midrange.
SENS_LOW	0 – 15	Adjusts the compressor input sensitivity for the bass range.
MIX_HIGH	OFF, -24 – 6	Adjusts the treble mix amount.
MIX_MID	OFF, -24 – 6	Adjusts the midrange mix amount.
MIX_LOW	OFF, -24 – 6	Adjusts the bass mix amount.
CHARA	0 – 10	Specifies the character of the filter.
COLOR	1 – 10	Specifies the color.
DIST	0 – 10	Adjusts the degree of distortion.
TONE	0 – 10	Adjusts the tone.
EFX LVL	0 – 30	Adjusts the mix amount of the effect sound.
DRY LVL	0 – 30	Adjusts the mix amount of the direct sound.

● NORMALIZER module

Type	Parameter
NORMMLZR	GAIN
	Lets you set the output level of the 3 BAND COMP/Lo-Fi module.

Parameter Description

Parameter Name	Setting Range	Parameter Description
GAIN	-12 – 12	Adjusts the level.

● 3 BAND EQ module

For an explanation of types and parameters, see the CLEAN, DIST, ACO/BASS SIM, BASS algorithm.

● ZNR module

For an explanation of types and parameters, see the CLEAN, DIST, ACO/BASS SIM, BASS algorithm.

● VOL PDL module

For an explanation of types and parameters, see the CLEAN, DIST, ACO/BASS SIM, BASS algorithm.

● DIMENSION/RESONANCE module

Type	Parameter						
DIMENSN	RISE_1	RISE_2					
	An effect that produces spatial width.						
RESONNC	DEPTH	FreqOFST	RATE	TYPE	RESO	EFX LVL	DRY LVL
	A resonance filter with LFO.						

Parameter Description

Parameter Name	Setting Range	Parameter Description
RISE_1	0 – 30	Adjusts the degree to which the stereo component is emphasized.
RISE_2	0 – 30	Adjusts the spaciousness that includes the monaural component.
DEPTH	0 – 10	Adjusts the depth of the effect.
FreqOFST	1 – 30	Adjusts the LFO offset.
RATE	1 – 30	Adjusts the speed of the effect.
TYPE	HPF / LPF / bPF	Specifies the type of filter.
RESO	1 – 30	Adds character to the effect.
EFX LVL	0 – 30	Adjusts the mix amount of the effect sound.
DRY LVL	0 – 30	Adjusts the mix amount of the direct sound.

Send/return effect

● CHORUS/DELAY module

Type	Parameter				
CHORUS	LFO TYPE	DEPTH	RATE	PRE DLY	EFX LVL
	Stereo chorus with clear sound and great spaciousness.				
DELAY	TIME	FB	DAMP	EFX LVL	REV_SEND
	A delay effect of up to 1000 ms.				
DOUBLE	TIME	TONE	EFX LVL		
	A doubling effect of up to 100 ms.				

Parameter Description

Parameter Name	Setting Range	Parameter Description
LFO TYPE	Mn / St	Selects the LFO phrase: Mn (monaural) or ST (stereo).
DEPTH	0 – 10	Adjusts the depth of the effect.
RATE	1 – 30	Adjusts the speed of the effect.
PRE DLY	1 – 30	Adjusts the pre-delay time.
EFX LVL	0 – 30	Adjusts the mix amount of the effect sound.
TIME	TYPE = DELAY : 1 – 1000 TYPE = DOUBLE : 1 – 100	Adjusts the delay time (x 1 ms).
FB	0 – 10	Adjusts the amount of feedback.
DAMP	0 – 10	Adjusts the amount of high-frequency decay for the delay sound.
REV_SEND	0 – 30	Adjusts the amount of delay sound that is sent to reverb.
TONE	0 – 10	Adjusts the tone.

● REVERB module

Type	Parameter					
HALL	PRE DLY	REV TIME	EQ_HIGH	EQ_LOW	E/R MIX	EFX LVL
	A reverb effect that produces the reverberation characteristic of a concert hall.					
ROOM	PRE DLY	REV TIME	EQ_HIGH	EQ_LOW	E/R MIX	EFX LVL
	A reverb effect that simulates the reverberation of a room.					

Parameter Description

Parameter Name	Setting Range	Parameter Description
PRE DLY	1 – 100	Adjusts the pre-delay time.
REV TIME	1 – 30	Adjusts the reverb time.
EQ_HIGH	-12 – 6	Adjusts the high-frequency volume of the reverb sound.
EQ_LOW	-12 – 6	Adjusts the low-frequency volume of the reverb sound.
E/R MIX	0 – 30	Adjusts the volume of early reflections.
EFX LVL	0 – 30	Adjusts the mix amount of the effect sound.

Effect Patch List

Insert effect

■ CLEAN algorithm

No.	Patch Name	Comment
0	Standard	Basic sound touched up for recording
1	J-Chorus	JC clean sound
2	Phaser	Clean sound emulating a vintage phase effect
3	DryComp	Line input clean sound with a hint of doubling
4	RiffCLN	Rock'n roll sound that brings out differences between guitars
5	WideCLN	Wide clean sound with crunch
6	PunchCLN	Airy, normal sound with a punch
7	Arpeggio	Clean sound suitable for arpeggios
8	CleanCH	Clean channel sound of an American-made vintage tube amp
9	50sRNB	Tremolo sound suitable for rhythm & blues
10	StrmBeat	Basic sound suitable for strummed backing
11	CompCLn	Natural compression sound
12	12-Clean	Clean sound with an upper octave mixed in
13	Funky	Funky cutting sound
14	FDR-CLn	Clean sound of American-made vintage tube amp
15	Rockbily	Rockabilly sound with short delay
16	NYFusion	Clean sound suitable for direct-line recording
17	Wet-Rhy	Cutting sound suitable for ballads
18	JazzTone	Clean sound suitable for jazz
19	DeepFLG	Clean flanging sound
20 – 24	EMPTY	

■ DIST algorithm

No.	Patch Name	Comment
0	MRS-Drv	Full distortion + rich sound
1	RCT-BG	High-gain amp sound of American-made "Rectifier" series
2	CrnchCmp	Crunch sound with a touch of compression
3	9002Lead	The original 9002 sound
4	F-Tweed	Sound of a small, American-made vintage tube amp
5	BlackPnl	Heavy metal sound of "5100 series" American-made stack amp
6	MatchCru	Crunch sound of a modern class-A amp
7	Sticky	Tight crunch sound
8	HardPick	Hard crunch sound
9	RockDrv	Straight rock drive sound
10	Duplex	Spacious lead guitar sound with dual overlay effect
11	MadBass	Distortion bass sound for high range chord playing and lead
12	Straight	Straight lead sound for all genres
13	JetSound	Versatile jet sound
14	Combo-BG	Overdrive sound with detailed long sustain
15	FDR-Twin	Drive channel sound of an American-made vintage tube amp
16	Beatle	Class-A type Mersey Beat sound
17	WildFuzz	Vintage fuzzbox sound
18	JB.Style	Octaver simulation. An indispensable effect for guitar and bass unison riffs
19	Pitch-5	Even single notes sound like power chords.
20	BRT-Drv	Great sound of British "900 series" stack amps
21	Soldan	High-gain amp sound ideal for single coil half-tone settings
22	MatchDrv	Drive sound of a modern class-A amp
23	Snake	Heavy metal sound with a solid bottom
24	Crunch	800 series crunch sound ensemble
25	Ballad	Warm lead sound

26	Metal-X	Good metal sound with subtle overtones
27	DP-Drv	70's hard rock sound
28	WetDrive	Simple "wet" overdrive sound
29	Mellow	Lead sound with a sweet tone
30	MultiDst	Strong all-around sound
31	Bright	Crisp sound
32	Melody	Tastefully seasoned sound, ideal for melodies
33	V-Blues	Vintage blues sound
34	BlueFngr	Bluesy sound suitable for finger picking
35	HDR-Drv	Wet hard rock sound
36	Cry-Lead	Zoom's original "cry effect" sound
37	ZakWah	Lead sound with auto-wah
38	LA-Std	L.A. studio-style big chorus sound
39	TheRing	Ring modulator also usable as a sound effect for recording
40 – 44	EMPTY	

■ ACO/BASS SIM algorithm

No.	Patch Name	Comment
0	AcoSIM 1	Simulation of unadorned acoustic guitar sound
1	AcoSIM 2	Simulation of acoustic guitar sound with beautiful chorus
2	AcoSIM 3	Shimmering detuned sound with no modulation
3	FullSize	Simulation of acoustic guitar with full-sized body
4	Light12	Light 12 string guitar type sound
5	BsSIM 1	Simulation of a tight picked bass
6	BsSIM 2	Chorus bass simulation, effective with melody lines
7	BsSIM 3	Simulation of an auto-wah bass
8	FingBass	Flanging sound as often used in 80's fusion
9	UniSolo	Guitar and bass unison sound usable for backing or lead
10 – 14	EMPTY	

■ BASS algorithm

No.	Patch Name	Comment
0	BS-Pick	Tight sound for playing with a pick
1	BS-Od	Rock sound with retro distortion
2	BS-Drv	Sound with hard distortion
3	BS-Fingr	Allround sound for finger picking
4	BS-Slap	Crisp slap sound
5	BS-Comp	Nice-feeling sound with attack controlled by picking dynamics
6	BS-Edge	Tight sound with an edge
7	BS-Solo	Sound suitable for melody, with chorus
8	BS-Octve	Sound with an upper octave mixed in, useful in an ensemble
9	BS-Wah	Funky bass with auto-wah
10 – 14	EMPTY	

■ MIC algorithm

No.	Patch Name	Comment
0	Vo-Stnd	Standard vocal effect
1	Vo-Rock	Rock vocal effect
2	Vo-Balld	Ballade vocal effect with depth created by detuned chorus
3	Vo-Echo	Vocal echo effect
4	Vo-PreC1	Smooth, listenable sound for condenser mics
5	Vo-PreC2	Doubling sound that adds depth for condenser mics
6	Vo-PreD1	Effect that improves definition for dynamic mics
7	Vo-PreD2	Effect that makes the sound fatter and wetter for dynamic mics
8	Vo-Robot	Robot voice as in SF movies

9	AG-Live	Sound for mic recording with a live feel. Broadly usable, not only for guitar.
10	AG-Brgh	Sound for mic recording; bright and crisp
11	AG-Solo	Gorgeous solo sound
12	AG-Edge	Acoustic guitar recording sound with enhanced edge
13	AG-Strum	Acoustic guitar recording sound for strumming
14	ForWind	Sound with good presence and distinctive mid-range
15	ForBrass	Overall crisp-sounding short delay
16	ForPiano	Sound with enhanced depth and definition
17	AG-Mix 1	Enhanced sound for mixdown (strumming)
18	AG-Mix 2	Enhanced sound for mixdown (arpeggio)
19	SweeperX	Effect with sharp sweep for one-shot percussion
20	FXgroove	Rhythm machine type sound with processed drums
21	Lo&Hi	Tinny drum track with boosted highs and lows and attenuated midrange
22	Lo-Boost	Drum sound with emphasized low end by pitch shifter
23	FanFan	Sound like talking into a fan
24	Alien	Space creature type sound effect for vocals
25	TapeComp	Patch which simulates analog multi-recording
26	Duet??	Adds a child voice to female vocal or a female voice to male vocals
27	Active	Effect with emphasized attack
28	Psyche	Vocal gimmick effect in the psychedelic style
29	DeepDLY	Effective delay for vocals, useful when cutting shouts or sound
30 – 49	EMPTY	

■ DUAL MIC algorithm

No.	Patch Name	Comment	Recommended uses for INPUT 1 / 2
0	Vo/Vo 1	Patch suitable for duets	Vocal / Vocal
1	Vo/Vo 2	Chorus suitable for main vocal	Vocal / Vocal
2	Vo/Vo 3	Patch suitable for harmony	Vocal / Vocal
3	AG/Vo 1	Patch that creates a street-like character	Acoustic guitar / Vocal
4	AG/Vo 2	Patch with differing vocal character than AG/Vo 1	Acoustic guitar / Vocal
5	AG/Vo 3	Patch that aggressively modifies vocal character	Acoustic guitar / Vocal
6	ShortDLY	Short delay with effective use of doubling	Mic / Mic
7	FatDrum	Suitable for drums recording using single point stereo microphone	Mic / Mic
8	BothTone	Condenser type sound tuned for male on INPUT 1 and female on INPUT 2	Vocal / Vocal
9	Condnsr	Simulates condenser mic sound with dynamic mic input	Vocal / Vocal
10	DuoAtack	Patch with emphasized attack and chorus effect for lead vocals	Vocal / Vocal
11	Warmth	Warm sound with prominent midrange	Vocal / Vocal
12	AM Radio	Simulation of an AM radio	Vocal / Vocal
13	Pavilion	Patch for narration sound at expo booths and events	Vocal / Vocal
14	TV News	TV newscaster sound	Vocal / Vocal
15	F-Vo/Pf1	Patch for female pop song vocal with piano accompaniment	Vocal / Piano
16	JazzDuo1	Jazz session LP record simulation with low fi sound	Vocal / Piano
17	Cntmprry	All-round clear sound with modern sound processing	Vocal / Piano
18	JazzDuo2	JazzyDuo1 male vocal sound	Vocal / Piano
19	Ensemble	Patch for guitar with strong attack and mellow piano	Acoustic guitar / Piano
20	Enhanced	Patch with clear, strong outline for ballads	Acoustic guitar / Vocal
21	Warmy	Patch to compensate for overbright ambience	Acoustic guitar / Vocal
22	Strum+Vo	Smooth fat sound with midrange compensation	Acoustic guitar / Vocal
23	FatPlus	Patch for sprucing up a thin midrange	Acoustic guitar / Vocal
24	Arp+Vo	Overall solid sound	Acoustic guitar / Vocal
25	ClubDuo	Simulation of live sound in small club	Acoustic guitar / Acoustic guitar
26	BigShape	Patch for enhancing overall clarity	Acoustic guitar / Acoustic guitar
27	FolkDuo	Patch with fresh and clean sound	Acoustic guitar / Acoustic guitar
28	GtrDuo	Patch suitable for guitar duos	Acoustic guitar / Acoustic guitar
29	Bright	Patch with a bright and sharp outlook	Acoustic guitar / Acoustic guitar
30 – 49	EMPTY		

■ LINE algorithm

No.	Patch Name	Comment
0	Syn-Lead	Synthesizer single tone lead effect
1	OrganPha	Phaser effect for synthesizer/organ
2	OrgaRock	Boomy distortion sound for rock organ
3	EP-Chor	Beautiful resonance and chorus, effective for electric piano
4	ClavFlg	Sound for clavinet
5	Concert	Concert hall effect for piano
6	Honkey	Honky-tonk piano simulation
7	PowerBD	An effect that gives a bass drum more power
8	DrumFlng	Conventional flanger for drums
9	LiveDrum	Simulation of outdoor live doubling
10	JetDrum	Phaser sound effective on 16-beat hi-hat
11	AsianKit	Transforms a standard kit into an Asian kit
12	BassBost	Boost patch that emphasizes the low range
13	Mono->St	An effect that gives spaciousness to a monaural source
14	AM Radio	AM radio simulation
15	WideDrms	Wide stereo effect good for internal drums
16	DanceDrm	Powerful effect with reinforced bass for dance rhythms
17	Octaver	SFX type effect adding a one-octave lower sound
18	Percushn	Gives air, presence, and stereo spread to percussion sounds
19	MoreTone	Distortion guitar sound with emphasized midrange body
20	SnrSmack	Gives presence to internal drums by emphasizing snappy snare sound
21	Shudder!	Stereo sound great for techno tracks
22	SwpPhase	Phaser effect with powerful resonance
23	DirtyBiz	Low-fi distortion using ring modulator
24	Doubler	Doubling effect great for vocal track
25	SFXlab	Forced SFX sound for synthesizer
26	SynLead2	Old-style jet sound good for synthesizer lead
27	Tekepiko	Effect for sequence phrases and guitar mute (single note)
28	Soliner	Analog string ensemble simulation
29	HevyDrum	Hard rock type drum track
30 – 49	EMPTY	

■ MASTERING algorithm

No.	Patch Name	Comment
0	PlusAlfa	Mastering that enhances the overall power
1	All-Pops	Conventional mastering
2	StWide	Wide-range mastering
3	DiscoMst	Mastering for club sound
4	Boost	Mixdown effect with hi-fi finish
5	Power	For mixes with a big and powerful low range
6	Live	Add a live feel to the overall mix
7	WarmMst	Mastering that adds an overall warm feeling
8	TightUp	Mastering with an overall hard feel
9	1930Mst	Mastering with 1930's sound
10	LoFi Mst	Lo-fi mastering
11	BGM	Mastering for background music
12	RockShow	Mastering for making a rock style mix sound "live"
13	Exciter	Lo-fi mastering with slight distortion in mid and upper range
14	Clarify	High-end mastering with wide range and universal appeal
15	VocalMax	Mastering for bringing vocals to the foreground
16	RaveRez	Special sweep effect using strong filter
17	FullComp	Strong compression over full frequency range
18	ClearPWR	Power tuning with emphasized midrange, strong impact and clear sound
19	ClearDMS	Sound with enhanced clarity and spaciousness
20 – 29	EMPTY	

Send/return effect

■ CHORUS/DELAY

No.	Patch Name	Comment
0	Vocal	Chorus effective for adding color to vocals
1	GtChorus	Chorus effect useful for weak guitar sound
2	Doubling	Versatile doubling effect
3	Echo	Flamboyant analog-style delay for guitar or vocal
4	Delay375	Delay matching the commonly-used 120 BPM tempo
5	LongDLY	Long delay ideal for ballads
6	FastCho	Fast chorus for adding depth to the sound
7	DeepCho	Versatile deep chorus effect
8	ShortDLY	Versatile short delay
9	DeepDBL	Deep doubling effect
10	SoloLead	Effect for keeping fast phrases tight, especially for guitar or synthesizer solos
11	WarmyDly	Analog delay simulation with warm sound
12	EnhanCho	Enhancer effect using phase shift doubling
13	Detune	Great effect for instruments with strong harmonics such as digital electric piano or synthesizer
14	Natural	Chorus with low modulation, for guitar or piano backing
15 – 19	EMPTY	

■ REVERB

No.	Patch Name	Comment
0	TightHal	Hall reverb with a hard tonal quality
1	BrgtRoom	Room reverb with a hard tonal quality
2	SoftHall	Hall reverb with a mild tonal quality
3	LargeHal	Simulates the reverberation of a large hall
4	SmallHal	Simulates the reverberation of a small hall
5	LiveHous	Simulates the reverb of a club
6	TrStudio	Simulates the reverberation of a rehearsal studio
7	DarkRoom	Room reverb with a mild tonal quality
8	VcxRev	Reverb tuned to enhance vocals
9	Tunnel	Simulates the reverberation of a tunnel
10	BigRoom	Simulates the reverberation of a large venue such as a gym
11	PowerSt.	Gate reverb type effect
12	BrittHall	Simulates a bright concert hall
13	BudoKan	Simulates the reverberation at Budokan in Tokyo
14	Ballade	Reverb effect for slow ballads
15 – 19	EMPTY	

Rhythm Pattern List

No.	Pattern Name	No.	Pattern Name	No.	Pattern Name	No.	Pattern Name
0	08BEAT01	61	ROCK32	122	R'nB 06	183	DANCE 07
1	08BEAT02	62	ROCK33	123	R'nB 07	184	DANCE 08
2	08BEAT03	63	HROCK 01	124	R'nB 08	185	HOUSE 01
3	08BEAT04	64	HROCK 02	125	R'nB 09	186	HOUSE 02
4	08BEAT05	65	HROCK 03	126	R'nB 10	187	HOUSE 03
5	08BEAT06	66	HROCK 04	127	R'nB 11	188	HOUSE 04
6	08BEAT07	67	HROCK 05	128	R'nB 12	189	HOUSE 05
7	08BEAT08	68	HROCK 06	129	FUNK 01	190	HOUSE 06
8	08BEAT09	69	HROCK 07	130	FUNK 02	191	TECHNO01
9	08BEAT10	70	HROCK 08	131	FUNK 03	192	TECHNO02
10	08BEAT11	71	HROCK 09	132	FUNK 04	193	TECHNO03
11	08BEAT12	72	METAL 01	133	FUNK 05	194	TECHNO04
12	16BEAT01	73	METAL 02	134	FUNK 06	195	TECHNO05
13	16BEAT02	74	METAL 03	135	FUNK 07	196	TECHNO06
14	16BEAT03	75	METAL 04	136	FUNK 08	197	TECHNO07
15	16BEAT04	76	METAL 05	137	FUNK 09	198	TECHNO08
16	16BEAT05	77	METAL 06	138	FUNK 10	199	TECHNO09
17	16BEAT06	78	THRASH01	139	FUNK 11	200	TECHNO10
18	16BEAT07	79	THRASH02	140	FUNK 12	201	TECHNO11
19	16BEAT08	80	PUNK 01	141	FUNK 13	202	D'nB 01
20	16FUS 01	81	PUNK 02	142	FUNK 14	203	D'nB 02
21	16FUS 02	82	PUNK 03	143	FUNK 15	204	D'nB 03
22	04JAZZ01	83	PUNK 04	144	FUNK 16	205	D'nB 04
23	04JAZZ02	84	FUSION01	145	16BEAT09	206	D'nB 05
24	04JAZZ03	85	FUSION02	146	16BEAT10	207	D'nB 06
25	04JAZZ04	86	FUSION03	147	16BEAT11	208	TRIP 01
26	BOSSA	87	FUSION04	148	HIP 01	209	TRIP 02
27	COUNTRY	88	FUSION05	149	HIP 02	210	TRIP 03
28	68BLUS	89	FUSION06	150	HIP 03	211	AMB 01
29	DANCE	90	FUSION07	151	HIP 04	212	AMB 02
30	ROCK01	91	FUSION08	152	HIP 05	213	AMB 03
31	ROCK02	92	FUSION09	153	HIP 06	214	AMB 04
32	ROCK03	93	FUSION10	154	HIP 07	215	AMB 05
33	ROCK04	94	FUSION11	155	HIP 08	216	AMB 06
34	ROCK05	95	FUSION12	156	HIP 09	217	BALD 01
35	ROCK06	96	FUSION13	157	HIP 10	218	BALD 02
36	ROCK07	97	FUSION14	158	HIP 11	219	BALD 03
37	ROCK08	98	FUSION15	159	HIP 12	220	BALD 04
38	ROCK09	99	INDUST01	160	HIP 13	221	BALD 05
39	ROCK10	100	INDUST02	161	HIP 14	222	BALD 06
40	ROCK11	101	POP 01	162	HIP 15	223	BALD 07
41	ROCK12	102	POP 02	163	HIP 16	224	BALD 08
42	ROCK13	103	POP 03	164	HIP 17	225	BALD 09
43	ROCK14	104	POP 04	165	HIP 18	226	BALD 10
44	ROCK15	105	POP 05	166	HIP 19	227	BALD 11T
45	ROCK16	106	POP 06	167	HIP 20	228	BALD 12
46	ROCK17	107	POP 07	168	HIP 21	229	BALD 13
47	ROCK18	108	POP 08	169	HIP 22	230	BLUES 01
48	ROCK19	109	POP 09	170	HIP 23	231	BLUES 02
49	ROCK20	110	POP 10	171	HIP 24	232	BLUES 03
50	ROCK21	111	POP 11	172	HIP 25	233	BLUES 04
51	ROCK22	112	POP 12T	173	HIP 26	234	BLUES 05
52	ROCK23	113	POP 13	174	HIP 27	235	BLUES 06
53	ROCK24	114	POP 14	175	HIP 28	236	BLUES 07
54	ROCK25	115	POP 15	176	HIP 29	237	BLUES 08
55	ROCK26	116	POP 16	177	DANCE 01	238	COUNTR01
56	ROCK27	117	R'nB 01	178	DANCE 02	239	COUNTR02
57	ROCK28T	118	R'nB 02	179	DANCE 03	240	COUNTR03
58	ROCK29	119	R'nB 03	180	DANCE 04	241	COUNTR04
59	ROCK30	120	R'nB 04	181	DANCE 05	242	COUNTR05
60	ROCK31	121	R'nB 05	182	DANCE 06	243	COUNTR06

No.	Pattern Name
244	JAZZ 01
245	JAZZ 02
246	JAZZ 03
247	JAZZ 04
248	JAZZ 05
249	JAZZ 06
250	JAZZ 07P
251	JAZZ 08
252	JAZZ 09
253	SHUFFL01
254	SHUFFL02
255	SHUFFL03
256	SHUFFL04
257	SHUFFL05
258	SHUFFL06
259	SHUFFL07
260	SKA 01
261	SKA 02
262	SKA 03
263	SKA 04
264	REGGAE01
265	REGGAE02
266	REGGAE03
267	REGGAE04
268	REGGAE05
269	REGGAE06
270	AFRO 01
271	AFRO 02
272	AFRO 03
273	AFRO 04
274	AFRO 05
275	AFRO 06
276	AFRO 07
277	AFRO 08
278	LATIN 01
279	LATIN 02
280	LATIN 03
281	LATIN 04
282	LATIN 05
283	LATIN 06
284	LATIN 07
285	LATIN 08
286	LATIN 09
287	LATIN 10
288	LATIN 11
289	LATIN 12
290	LATIN 13
291	LATIN 14
292	LATIN 15
293	BOSSA 01
294	SAMBA 01
295	SAMBA 02
296	MIDE 01
297	MIDE 02

No.	Pattern Name
298	MIDE 03
299	MIDE 04T
300	MIDE 05
301	MIDE 06
302	INTRO 01
303	INTRO 02
304	INTRO 03
305	INTRO 04
306	INTRO 05
307	INTRO 06
308	INTRO 07
309	INTRO 08
310	INTRO 09
311	INTRO 10
312	INTRO 11
313	INTRO 12
314	INTRO 13
315	INTRO 14
316	INTRO 15
317	INTRO 16
318	INTRO 17
319	INTRO 18
320	COUNT
321	ROCK F1
322	ROCK F2
323	ROCK F3
324	ROCK F4
325	ROCK F5
326	ROCK F6
327	ROCK F7
328	ROCK F8
329	ROCK F9
330	HROCK F1
331	HROCK F2
332	HROCK F3
333	HROCK F4
334	METAL F1
335	METAL F2
336	THRAS F1
337	THRAS F2
338	FUSE F1
339	FUSE F2
340	FUSE F3
341	FUSE F4
342	FUSE F5
343	FUSE F6
344	INDST F1
345	POPS F1
346	POPS F2
347	POPS F3
348	POPS F4
349	POPS F5
350	R'nB F1
351	R'nB F2

No.	Pattern Name
352	FUNK F1
353	FUNK F2
354	FUNK F3
355	FUNK F4
356	HIP F1
357	HIP F2
358	HIP F3
359	DANCE F1
360	DANCE F2
361	DANCE F3
362	DANCE F4
363	HOUSE F1
364	HOUSE F2
365	TECHN F1
366	TECHN F2
367	D'nB F1
368	D'nB F2
369	AMB F1
370	GROOV F1
371	GROOV F2
372	BALAD F1
373	BALAD F2
374	BLUES F1
375	BLUES F2
376	CNTRY F1
377	CNTRY F2
378	JAZZ F1
379	JAZZ F2
380	SHFL F1
381	SHFL F2
382	SHFL F3
383	REGGA F1
384	REGGA F2
385	AFRO F1
386	AFRO F2
387	LATIN F1
388	LATIN F2
389	LATIN F3
390	LATIN F4
391	MIDE F1
392	MIDE F2
393	ENDING01
394	ENDING02
395	ENDING03
396	ENDING04
397	ENDING05
398	ENDING06
399	ENDING07
400	METRO4/4
401	METRO3/4
402	ALL MUTE

Drum Kit List

	Display	Pattern Name
LIVE ROCK	00LIVE1	Live Rock 1
	01LIVE2	Live Rock 2
STUDIO DRUMS	02STDIO1	Studio 1
	03STDIO2	Studio 2
STANDARD KIT	04STNDR1	Standard 1
	05STNDR2	Standard 2
VARIATION	06ELE_DR	Electric
	07ENHPWR	Enhanced Power
GENERAL DRUMS	08GENERL	General
	09DRUM9	Drum#9
FUNK TRAP	10FUNK1	Funk Trap 1
	11FUNK2	Funk Trap 2
JAZZ DRUMS	12JAZZ	Jazz
	13BRUSH	Brush
EPIC ROCK	14EPIC1	Epic rock 1
	15EPIC2	Epic rock 2
BALLAD SET	16BALAD1	Ballad 1
	17BALAD2	Ballad 2
DANCE	18DANCE1	Dance 1
	19DANCE2	Dance 2
RAP/HIPHOP	20HIPHP1	Rap/Hiphop 1
	21HIPHP2	Rap/Hiphop 2

	Display	Pattern Name
TECHNO BEAT	22TECH1	Techno Beat 1
	23TECH2	Techno Beat 2
LO-FI KIT	24LO_FI	Lo-Fi
	25DIST	Distortion
PERCUSSION	26GNPERC	General Percussion
	27DRSKIN	Drum Skin
ENSEMBLE PARTS	28CLKSTK	Clicks and Sticks
	29LOPERC	Low Percussion
PROCESSABLE	30HIPERC	High Percussion
	31DRY1	Dry 1
	32DRY2	Dry 2
	33DRY3	Dry 3
	34DRY4	Dry 4
	35ROOM1	Room 1
	36ROOM2	Room 2
	37STD1	Room 3
	38HUMAN	Human Dry
	39LONGRM	Long Room
	40LIGHT	Light Pop
	41HITUNE	High Tune
	42TIGHT	Tight Rock

Instrument/MIDI Note Number Table

● KIT No. 1 – 25, 31 – 42

Key	Bank 1		Bank 2		Bank 3	
	Instrument Name	Note #	Instrument Name	Note #	Instrument Name	Note #
KICK	Kick	36	Cowbell	56	Agogo	67
SNARE	Snare	38	Mute high conga	62	Tambourine	54
C-HH	Closed Hihat	42	Open high conga	63	Clap	39
O-HH	Open Hihat	46	Low conga	64	Short guiro	73
TOM 1	Tom 1	50	Stick	37	High timbale	65
TOM 2	Tom 2	47	High bongo	60	Low timbale	66
TOM 3	Tom 3	43	Low bongo	61	Shaker	70
CYMBAL	Crash cymbal	49	Ride cymbal	51	Cup	53

* Some instruments are different for JAZZ DRUMS.

● KIT No. 26:General Percussion

Key	Bank 1		Bank 2		Bank 3	
	Instrument Name	Note #	Instrument Name	Note #	Instrument Name	Note #
KICK	Metronome click	36	Short guiro	56	Wood block high	67
SNARE	Metronome bell	38	Long guiro	62	Wood block low	54
C-HH	Scratch 1	42	Agogo 1	63	Jingle bell	39
O-HH	Scratch 2	46	Agogo 2	64	Castanet	73
TOM 1	High Q	50	Claves	37	Mute surdo	65
TOM 2	Square click	47	Cabasa	60	Open surdo	66
TOM 3	Short click	43	Whistle 1	61	Mute triangle	70
CYMBAL	Vibraslap	49	Whistle 2	51	Open triangle	53

● KIT No.27:Drum Skin

Key	Bank 1		Bank 2		Bank 3	
	Instrument Name	Note #	Instrument Name	Note #	Instrument Name	Note #
KICK	Live conga 1	36	Hand tom	56	Wood block high	67
SNARE	Live conga 2	38	Doumbek 1	62	Wood block low	54
C-HH	Timbales 1	42	Doumbek 2	63	Jingle bell	39
O-HH	Timbales 2	46	Doumbek 3	64	Castanet	73
TOM 1	Bongo reverb 1	50	Latin sell	37	Mute surdo	65
TOM 2	Bongo reverb 2	47	Cabasa	60	Open surdo	66
TOM 3	Tumba 1	43	Whistle 1	61	Mute triangle	70
CYMBAL	Tumba 2	49	Whistle 2	51	Open triangle	53

● KIT No.28:Click and Sticks

Key	Bank 1		Bank 2		Bank 3	
	Instrument Name	Note #	Instrument Name	Note #	Instrument Name	Note #
KICK	Stick reverb	36	Latin sell	56	Wood block high	67
SNARE	Studio click	38	Castanet 1	62	Wood block low	54
C-HH	Cross stick	42	Castanet 2	63	Jingle bell	39
O-HH	Short guiro	46	Castanet 3	64	Castanet	73
TOM 1	Claves	50	Brush slap	37	Mute surdo	65
TOM 2	Wood click 1	47	Cabasa	60	Open surdo	66
TOM 3	Wood click 2	43	Whistle 1	61	Mute triangle	70
CYMBAL	Wood click 3	49	Whistle 2	51	Open triangle	53

● KIT No.29:Low Percussion

Key	Bank 1		Bank 2		Bank 3	
	Instrument Name	Note #	Instrument Name	Note #	Instrument Name	Note #
KICK	Doumbek 1	36	Loose conga 1	56	Wood block high	67
SNARE	Doumbek 2	38	Loose conga 2	62	Wood block low	54
C-HH	Doumbek 3	42	Tabla 1	63	Jingle bell	39
O-HH	Timbales	46	Tabla 2	64	Castanet	73
TOM 1	Tumba 1	50	Latin sell	37	Mute surdo	65
TOM 2	Tumba 2	47	Cabasa	60	Open surdo	66
TOM 3	Tumba 3	43	Whistle 1	61	Mute triangle	70
CYMBAL	Hand tom	49	Whistle 2	51	Open triangle	53

● KIT No. 30:High Percussion

Key	Bank 1		Bank 2		Bank 3	
	Instrument Name	Note #	Instrument Name	Note #	Instrument Name	Note #
KICK	Tambourine 1	36	Long guiro 1	56	Wood block high	67
SNARE	Tambourine 2	38	Long guiro 2	62	Wood block low	54
C-HH	Tambourine 3	42	Agogo 1	63	Jingle bell	39
O-HH	Claves	46	Agogo 2	64	Castanet	73
TOM 1	Shaker 1	50	Short guiro	37	Mute surdo	65
TOM 2	Shaker 2	47	Cabasa	60	Open surdo	66
TOM 3	Shaker 3	43	Whistle 1	61	Mute triangle	70
CYMBAL	Viblaslap	49	Whistle 2	51	Open triangle	53

Phrase List

			No.	Name	Comments	
Rhythm	Drum Loops	1	1	Ry-01-1A	Drum loop 1	
			2	Ry-01-1B	Drum loop 2	
			3	Ry-01-1C	Drum fill 1	
			4	Ry-01-1D	Drum variation 1	
			5	Ry-01-1E	Drum fill 2	
			6	Ry-01-1F	Drum variation 2	
			7	Ry-01-1G	Drum end	
		2	8	Ry-01-2A	Drum intro	
			9	Ry-01-2B	Drum loop 1	
			10	Ry-01-2C	Drum loop 2	
			11	Ry-01-2D	Drum break	
			12	Ry-01-2E	Drum variation 1	
			13	Ry-01-2F	Drum fill	
			14	Ry-01-2G	Drum variation 2	
	Beats Variation			15	Ry-02-1A	Drum loop 1
				16	Ry-02-1B	Drum loop 2
	Breakbeats			17	Ry-03-1A	Drum loop 1
				18	Ry-03-1B	Drum loop 2
				19	Ry-03-1C	Drum loop 3
				20	Ry-03-1D	Drum loop 4
				21	Ry-03-1E	Drum loop 5
	Latin Loops		1	22	Ry-04-1A	Percussion loop 1
				23	Ry-04-1B	Percussion loop 2
				24	Ry-04-1C	Percussion loop 3
				25	Ry-04-1D	Percussion loop 4
			2	26	Ry-04-2A	Percussion loop 1
				27	Ry-04-2B	Percussion loop 2
				28	Ry-04-2C	Percussion loop 3
			3	29	Ry-04-2D	Percussion loop 4
				30	Ry-04-3A	Percussion loop 1
				31	Ry-04-3B	Percussion loop 2
	Asian Loops			32	Ry-05-1A	Asian percussion loop 1-1
				33	Ry-05-1B	Asian percussion loop 1-2
				34	Ry-05-1C	Asian percussion loop 1-3
				35	Ry-05-1D	Asian percussion loop 2
				36	Ry-05-1E	Asian percussion loop 3
Songs	Hardcore Loop		1	37	Sg-01-1A	Industrial drum loop
				38	Sg-01-1B	Industrial break
				39	Sg-01-1C	Industrial G & B break
				40	Sg-01-1D	Industrial guitar
			2	41	Sg-01-2A	BigBeat drum loop
	42	Sg-01-2B		BigBeat bass loop		
	43	Sg-01-2C		BigBeat FX loop		
	Kontrol Variations		1	44	Sg-02-1A	Hiphop Track 1-1
				45	Sg-02-1B	Hiphop Track 1-2
			2	46	Sg-02-2A	Hiphop Track 2-1
	47	Sg-02-2B		Hiphop Track 2-2		
	Drum Bass Loops		1	48	Sg-03-1A	Drum loop
	49	Sg-03-1B		Bass loop		
	Reggae Variations		1	50	Sg-04-1A	Dub drum loop
				51	Sg-04-1B	Dub bass loop
				52	Sg-04-1C	Dub guitar loop
			2	53	Sg-04-2A	Dub drum loop
				54	Sg-04-2B	Dub bass loop
				55	Sg-04-2C	Dub guitar solo loop

		No.	Name	Comments				
Bass	in A	56	EB-01-1A	Old Funk loop 1				
		57	EB-01-1B	Old Funk loop 2				
	in B	58	EB-02-1A	Old-school bass loop 1				
		59	EB-02-1B	Old-school bass loop 2				
	in C	60	EB-03-1A	Old House bass loop				
		61	EB-03-1B	Pops bass loop				
	in D	62	EB-04-1A	Funk bass loop 1				
		63	EB-04-1B	Funk bass loop 2				
	in E	64	EB-05-1A	Dark bass loop 1-1				
		65	EB-05-1B	Dark bass loop 1-2				
	in G	66	EB-06-1A	Funk bass loop 1-1				
		67	EB-06-1B	Funk bass loop 1-2				
	Guitar		68	Gt-01-1A	Acoustic guitar loop on Amaj			
			69	Gt-01-1B	Acoustic guitar loop on Amin			
70			Gt-01-1C	Electric guitar loop on Cmin				
71			Gt-01-1D	RockBilly guitar loop on Amin				
72			Gt-01-1E	Funk guitar loop on A7#9				
73			Gt-01-1F	Funk guitar loop on Dmin9				
74			Gt-01-1G	Hard Rock guitar loop on Bmin				
75			Gt-01-1H	Rock guitar loop on Amin				
Analog			Synth Bass		76	AG-01-1A	Analog bass loop 1	
					77	AG-01-1B	Synth bass loop 1	
		78			AG-01-1C	Synth bass loop 2		
		79			AG-01-1D	Synth bass loop 3		
		Synth Rhythm		80	AG-01-1E	Analog bass loop 2		
				81	AG-01-1F	Analog bass loop 3		
				82	AG-01-1G	Synth bass loop 4		
				83	AG-02-1A	Synth loop 1		
				84	AG-02-1B	Synth loop 2		
				85	AG-02-1C	Synth loop 3		
		Synth Textures		86	AG-02-1D	Synth loop 4		
				87	AG-02-1E	Synth loop 5		
88	AG-02-1F			Synth loop 6				
89	AG-03-1A			String & Synth loop				
90	AG-03-1B			String loop 1				
91	AG-03-1C			String loop 2				
92	AG-03-1D			String loop 3				
FX loops		93	FX-01-1A	Fx loop 1				
		94	FX-01-1B	Fx loop 2				
		95	FX-01-1C	Fx loop 3				
		96	FX-01-1D	Fx loop 4				

With the factory default settings, project 001 contains these phrases.

MRS-802 hard disk contents

The hard disk in the MRS-802 comprises two partitions called "MSR-USR" and "MSR-FAC". The "MSR-FAC" partition contains files that are needed for performing hard disk maintenance. Never attempt to manipulate the files in this partition.

"MSR-USR" contains the following files and folders.

● PRJINIT folder

Contains data such as rhythm song/rhythm pattern data and drum kit data that are read when creating a new project. The following files are located in this folder.

PRJDATA.INI

Project data

RHYTHM.SEQ

Rhythm pattern and rhythm song data

● SYS folder

Contains the system files.

MAC_PRM.INI

Number of most recently edited project

BURNLIST.CDT

Album data

● PROJxxx folder

Contains the individual data for each project. The following files are located in this folder.

TRACKx_x.DAT

Audio data for each track/V-take

PHRASExx.PH

Audio data for each phrase (mono or stereo left channel)

PHRASExx.PHR

Audio data for each phrase (stereo right channel)

LOOPxx.LSQ

Formula data entered when creating phrase loops

RHYTHM.FST

Formula data entered when creating rhythm song with FAST method.

PRJDATA.INI

Project settings data

RHYTHM.SEQ

Rhythm pattern and rhythm song data

● WAV_AIFF folder

Folder for storing WAV/AIFF files. Used when importing phrases from the internal hard disk.

To use this folder, install the optional USB card (UIB-01/UIB-02) and copy WAV/AIFF files from a computer.

● SOUNDS folder

Drum kit data

xxxx.DRM

Sound data for each drum kit

● SYSTEM.ZEX

MRS-802 system file

Compatibility With MRS-1044/MRS-1266 Series

The MRS-802 can exchange project data with the MRS-1044/CD and MRS-1266/CD models. However, certain limitations exist regarding supported functions.

■ When loading MRS-1044/CD projects into the MRS-802

● The following data will not be read:

- Audio data for tracks 9/10
- Scenes
- Effect patches
- Bass sound parameters
- Pad sensitivity settings

■ When loading MRS-1266/CD projects into the MRS-802

● The following data will not be read:

- Audio data for tracks 9/10
- Scenes
- Sub out settings
- Drum kits
- Bass sound parameters
- Pad sensitivity settings

- The effect patches of the GUITAR/BASS algorithm will be divided and assigned to the CLEAN, DIST, ACO/BASS SIM, and BASS algorithms in numerical order.

- In DUAL algorithm patches, the parameters of G/B&Mic type and of Gtr&Bass type will be changed.

■ When loading MRS-802 projects into the MRS-1044/CD

- The following data will not be read:

- Scenes
- Rhythm pattern numbers 255 - 510
- Rhythm song numbers 1 - 9
- Effect patches

■ When loading MRS-802 projects into the MRS-1266/CD

- The following data will not be read:

- Scenes
- Drum kits

- **CLEAN, DIST, ACO/BASS**

The effect patches of the CLEAN, DIST, ACO/BASS SIM and BASS algorithms will be integrated as GUITAR/BASS algorithm patches.

MIDI implementation

1. Recognized Messages

Status	1st	2nd	Description
8nH	kk	vv	Note Off kk: note number vv: velocity will be ignored
9nH	kk	00H	Note Off kk: note number
9nH	kk	vv	Note On kk: note number (See NOTE 1) vv: velocity
BnH	07H	vv	Channel Volume vv: volume value
BnH	0BH	vv	Channel Expression vv: expression value
BnH	78H	xx	All Sounds Off
BnH	79H	xx	Reset All Controllers
BnH	7BH	xx	All Notes Off

NOTE: n = MIDI Channel Number (0 - F)

- Note On messages can be recorded into a rhythm pattern.

2. Transmitted Messages

Status	1st	2nd	Description
8nH	kk	40H	Note Off kk: note number
9nH	kk	00H	Note Off kk: note number
9nH	kk	vv	Note On kk: note number vv: velocity
BnH	07H	vv	Channel Volume vv: volume value
BnH	7BH	00H	All Notes Off
F2H	sl	sh	Song Position Pointer shsl: song position
F8H			Timing Clock
FAH			Start
FBH			Continue
FCH			Stop

NOTE: n = MIDI Channel Number (0 - F)

3. System Exclusive Messages

No SysEx messages are recognized/transmitted.

MIDI implementation chart

[HardDisk Recorder] Date : 28.Jan.2003
 Model MRS-802 MIDI Implementation Chart Version :1.00

Function ...		Transmitted	Recognized	Remarks
Basic Channel	Default Changed	1-16,OFF 1-16,OFF	1-16,OFF 1-16,OFF	Memorized
Mode	Default Messages Altered	3 x *****	3 x	
Note Number	True voice	32-73 *****	32-73	
Velocity	Note ON Note OFF	o x	o x	
After Touch	Key's Ch's	x x	x x	
Pitch Bend		x	o	
Control Change		7	7 11 120 121	Volume Expression All Sounds Off Reset All Ctrls
Prog Change	True #	x *****	x	
System Exclusive		x	x	
System Common	Song Pos Song Sel Tune	o x x	x x x	
System Real Time	Clock Commands	o o	x x	
Aux Messages	Local ON/OFF All Notes OFF Active Sense Reset	x o x x	x o x x	
Notes				

Mode 1 : OMNI ON, POLY Mode 2 : OMNI ON, MONO o : Yes
 Mode 3 : OMNI OFF, POLY Mode 4 : OMNI OFF, MONO x : No

INDEX

Symbols

(64, 84
)	64, 84
+	64, 84
x	64, 84

A

A-B repeat	44
ADJUST BAR	66
ADJUST BAR&LEN	66
ADJUST OFF	66
Adjusting the panning	28
Adjusting the volume	28
AIFF file	
Reading a WAV/AIFF file	59
Album	111
Changing the project	114
Deleting a single project	114
Deleting all projects	114
Algorithm	24, 100
All Initialize	138
Applying the send/return effect	29
Selecting a patch	30
Audio CD	
Importing data from	119
Playback	115
Auto punch-in/out	36

B

Backup	119
Load	122
Save	119, 121
Balance	70
Bounce function	39
Settings	39
Bounce	
Execute	40

C

Capture	
Track capture and swap	55
CD-R	111
CD-R/RW disc	111
Checking free capacity	114
Finalizing	118
Loading a project	122
Saving a single project	119
Saving all projects	121
CD-R/RW drive problems	144
CD-R/RW drive	
Installation	17

CD-RW	111
CD-RW disc	
Erasing a CD-RW disc	117
Connections	15
Copying	46
Copying a data range	47
Copying a phrase	62
Copying a rhythm pattern	95
Copying a rhythm song	88
Copying a V-take	54
Creating a CD	111
Recording audio data as an album	113
Recording audio data as a project	112

D

Demo song	19
Play	20
Protect	19
Select	19
Directory	120
Display section	12
Drum kit	77
Drum kit list	161
Drum kit	
Changing the drum kit	79
MIDI channel	130
Drum track	10, 77
DrVOL	81, 86

E

EDIT	103, 108
EDITED	104, 108
Effect	99
Effect module	100
Effect patch list	
Insert effect	154
Send/return effect	158
Effect related problems	142
Effect section	10, 12
Effect type/parameter list	
Insert effect	145
Send/return effect	153
EOS	81
EQ adjustment	28
Erase	46
Erase	
CD-RW disc	117
Event	87
Play contents of a specific drum sound	93
Range of data	49
Rhythm pattern	83

- Rhythm pattern 96
 - Rhythm song 89
 - V-take 54
 - EV→ 81
 - Event 77
- F**
- Factory Initialize 138
 - Fade-in/out 46
 - Fade-in/out of a specified data range 50
 - FAST input (rhythm song) 83
 - FAST input method (phrase loop) 63
 - Finalizing 111, 118
 - Foot switch 135
 - Front panel 14
- H**
- Hard disk
 - Checking/repairing internal hard disk structure 138
 - Formatting 138
 - Hard disk maintenance with supplied CD-ROM 139
 - Maintenance 137
 - MRS-802 hard disk contents 164
 - Rewriting system file data 138
- I**
- IN point 36
 - Input mixer 67
 - Adjusting panning/balance 70
 - Adjusting send/return effect depth 69
 - Assigning an input signal to a track 68
 - Basic operation 68
 - Input section 12
 - Input sensitivity 24
 - Insert effect 10, 24, 99, 100
 - Changing the insert position 101
 - Changing the insert target 31
 - Changing the patch name 105
 - Editing a patch 103
 - Effect type/parameter list 145
 - Saving a patch 105
 - Selecting a patch 101
 - Using effects only on monitor signal 106
 - Instrument bank 92
 - Instrument/MIDI note number table 161
- L**
- Level meter 137
 - Locate function 35
- M**
- Main screen 19
 - Maintenance
 - Basic operation 137
 - Checking/repairing internal hard disk
 - structure 138
 - Formatting the hard disk 138
 - Hard disk maintenance with supplied
 - CD-ROM 139
 - Rewriting system file data 138
 - Using an option card for connection to
 - a computer 139
 - Manual punch-in/out 35
 - Mark 42
 - Marker function 42
 - Erasing 43
 - Erasing a mark 43
 - Locating a mark 43
 - Setting a mark 42
 - Master track 10, 31, 37
 - Playback 38
 - Record 37
 - MEAS X 61
 - MIDI 128
 - Changing settings 129
 - Control change 128
 - Instrument/MIDI note number table 162
 - MIDI implementation 166
 - MIDI implementation chart 167
 - Note on/off message 128
 - Song Position Pointer 128
 - Start/Stop/Continue 128
 - Timing Clock 128
 - MIDI channel 130
 - MIDI problems 143
 - Mixdown function 37
 - Mixer 67
 - Mixer section 10
 - Move 46
 - Moving a range of data 48
 - Moving a V-take 54
 - MRS-1044
 - Compatibility with MRS-1044/MRS-1266
 - series 164
 - MRS-1266
 - Compatibility with MRS-1044/MRS-1266
 - series 164
- N**
- NORMAL 117
 - OUT point 36
- P**
- Panning 70
 - Parameters 100
 - Patch

- Changing a send/return effect patch name 109
 Changing an insert effect patch name 105
 Insert effect patches 100
 Loading a patch from another project 110
 Saving a send/return effect patch 109
 Saving an insert effect patch 105
 Phrase list 163
 Phrase loop 57
 Adjusting phrase parameters 61
 Copying a phrase 62
 Creating 63
 Loading a phrase 58
 Loading a phrase from another project 60
 Loading a V-take from current project 58
 Loading a WAV/AIFF file 59
 Writing a phrase loop to a track 65
 Phrase pool 57
 Ping-pong recording 39
 Playback problems 142
 Project 124
 Changing the project name 127
 Checking project size/hard disk free capacity 125
 Copying a project 126
 Creating a new project 125
 Erasing a project 126
 Loading a project 125
 Loading an SMF 131
 Protecting/unprotecting a project 127
 Save 121
 Protect 127
 Ptn 86
 PTN 81
 Punch-in/out function 35
 Manual punch-in/out 35
 Punch-in/out
 Auto punch-in/out 36
- Q**
- Quantize 90, 91
 QUICK 117
 Quick Tour 21
- R**
- Real-time input (rhythm pattern) 93
 Rear panel 14
 Recorder section 9
 Recording problems 142
 Recording
 Mixdown 28
 Overdubbing 27
 Preparations 21
 Recording the first track 24
 Repeat playback 44
 Reverse 46
- Rhythm 77
 Rhythm pattern 10, 77
 Assigning a name to a rhythm pattern 95
 Beat 90
 Changing the drum kit 79
 Changing the drum sound balance 94
 Changing the tempo 79
 Copying a rhythm pattern 95
 Creating your own rhythm pattern 90
 Edit 94
 Erasing a rhythm pattern 96
 Erasing all drum sound play data 94
 Erasing play contents of a specific drum sound 93
 Load from another project 96
 Number of measures 91
 Real-time input 93
 Select 22
 Selecting an playing a rhythm pattern 78
 Step input 91
 Rhythm pattern list 159
 Rhythm pattern mode 78
 Rhythm recording 41
 Rhythm section 10, 77
 Changing settings 97
 Changing the metronome volume 98
 Changing the pre-count duration 97
 Checking the remaining memory capacity 98
 Recording drum sound playing 41
 Setting sound intensity 98
 Rhythm section problems 143
 Rhythm song 10, 77
 Assigning a name to a rhythm song 89
 Changing event settings 86
 Copying a rhythm song 88
 Copying a specific measure 88
 Edit 88
 Entering a rhythm pattern 81
 Erasing a rhythm pattern 83
 Erasing a rhythm song 89
 Erasing a specific measure 83
 Erasing an event 87
 FAST input method 83
 Inputting an event 86
 Inserting a rhythm pattern 83
 Loading from another project 96
 Playback 87
 Selecting a rhythm song 80
 Step input 81
 Rhythm song mode 78
- S**
- Save
 Erasing a project 126
 Saving a scene 74
 Saving a send/return effect patch 109

- Saving a single project on CD-R/RW disc 119
 Saving all projects on CD-R/RW disc 121
 Saving an insert effect patch 105
 Scan disc 138
 Scene function 74
 Saving a scene 74
 Scene
 Automatic scene switching 75
 Excluding a specific parameter 76
 Recalling a scene 75
 Scrub/preview function 44
 Send/return effect 11, 99
 Adjusting the effect depth 69, 72
 Adjusting the effect depth for each track 30
 Changing the patch name 109
 Editing a patch 108
 Effect patch list 158
 Effect type/parameter list 153
 Patch 107
 Saving a patch 109
 Selecting a patch 107
 Shutdown 20
 SMF player 131
 SMF
 Loading 131
 Output selection 132
 Playback 134
 Song Position Pointer 131
 Specifications 141
 Standard MIDI file 128
 Start/Stop/Continue 131
 Step input (rhythm pattern) 91
 Step input (rhythm song) 81
 Stereo link 73
 Swap
 Swapping track data and capture data 56
- T**
 Tempo 81, 86
 Tick 90
 Time stretch/compression 46
 Timing clock 130
 TIMSIG 61
 TimSig 81, 86
 Top panel 12
 Track 9
 Track editing 46
 Capturing a track 55
 Capturing and swapping a track 55
 Compression/expansion of a specified data range 51
 Copying a specified data range 47
 Copying a V-take 54
 Editing a specified data range 46
 Erasing a specified data range 49
 Erasing a V-take 54
 Fade-in/out of a specified data range 50
 Moving a specified data range 48
 Moving a V-take 54
 Reversing a specified data range 51
 Swapping track data and capture data 56
 Swapping V-takes 55
 Trimming a specified data range 49
 V-take editing 53
- Track mixer 67
 Adjusting send/return effect depth 72
 Adjusting volume/panning/EQ 71
 Basic operation 71
 Linking odd/even channels 73
 Track parameter 28
 Transport section
 Basic operation 26
 Trimming 46
 Tuner function 136
 Turning off the power 20
 Turning on the power 19
- U**
 UIB-01 139
 UIB-02 139
 USB 139
 USB mode 139
 Using the solo function 74
- V**
 V-take 9, 33
 Copying 54
 Erasing 54
 Moving 54
 Renaming 33
 Swapping 55
 Switching 33
- W**
 WAV file
 Loading a WAV/AIFF file 59
 Writing
 Phrase loop to a track 65



ZOOM CORPORATION

NOAH Bldg., 2-10-2, Miyanishi-cho, Fuchu-shi, Tokyo 183-0022, Japan

PHONE: +81-42-369-7116 FAX: +81-42-369-7115

Web Site: <http://www.zoom.co.jp>

MRS-802- 5000-1