

**User
Manual**

Cooker

**Model
ZKC5540**

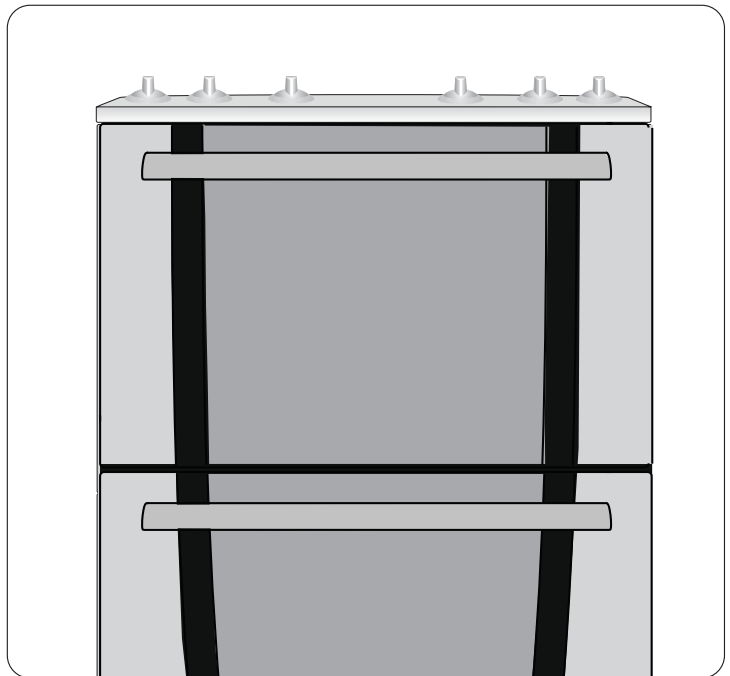

The following symbols are used in this user manual:



WARNING!

Important information concerning your personal safety and information on how to avoid damaging the appliance.

IMPORTANT!

General information and tips



Environmental information

Contents

Important safety instructions.....	3	Oven cooking chart.....	21
Product description.....	5	Roasting chart.....	23
Controls and their functions.....	5	Defrost.....	24
Before first use.....	6	Main oven light.....	25
Grill and oven furniture.....	7	Slow cook.....	25
The electronic minute minder.....	8	Care and cleaning.....	27
The hob.....	13	Troubleshooting.....	32
The grill.....	14	Installation instructions.....	34
Grilling chart.....	16	Technical data.....	36
The top oven.....	17	Environment.....	36
The main oven.....	19	Guarantee / Customer care.....	37

Important safety instructions

These warnings are provided in the interests of your safety. Ensure that you understand them all before installing or using the appliance. Your safety is of paramount importance. If you are unsure about any of the meanings of these warnings please contact customer care.

Installation

- The appliance must be installed according to the instructions supplied.
- The installation work must be undertaken by a qualified electrician or competent person.
- The appliance should be serviced by an authorised service engineer and only genuine approved spare parts should be used.
- The appliance must be installed in an adequately ventilated room.
- If the appliance is to be placed on a base, measures must be taken to prevent the appliance from slipping.
- This appliance is heavy and care must be taken when moving it.
- Do not attempt to lift or move this appliance by the handles.
- All packaging, both inside and outside the appliance must be removed before the appliance is used.
- It is dangerous to alter the specifications or modify the appliance in any way.

Child safety

- Do not allow children to play with any part of the packaging.
- Do not allow children to sit or climb on the drop down doors.
- This appliance is not intended for use by children and other persons whose physical, sensory or mental capabilities or lack of experience and knowledge prevents them

from using the appliance safely without supervision or instruction by a responsible person to ensure that they can use the appliance safely.

- Children should be supervised to ensure that they do not play with the appliance.

WARNING!

Accessible parts may be hot during use. Young children should be kept away.

During use

- This appliance is not intended to be operated by means of an external timer or separate remote control system.
- This appliance has been designed for domestic use to cook edible foodstuffs only and must not be used for any other purposes.
- Take great care when heating fats and oils, as they will ignite if they become too hot.
- Never place plastic or any other material, which may melt in or on the oven.
- Do not leave the grill pan handle in position when grilling, as it will become hot.
- Always support the grill pan when it is in the withdrawn or partially withdrawn position.
- Always use oven gloves to remove and replace the grill pan handle when grilling.
- Always use oven gloves to remove and place food in the oven.
- Ensure cooking utensils are large enough to contain foods to prevent spillage and boil over.
- The handles of saucepans, which are smaller than the heated area on the hob, will become hot.
- Ensure your hand is protected before handling the pan.

- Do not use the appliance if the ceramic glass is damaged. If a fault or crack becomes visible, disconnect the appliance immediately from the electricity supply and contact your local service force centre.
- During use the appliance becomes hot. Care should be taken to avoid touching heating elements inside the oven.
- Ensure that all vents are not obstructed to ensure ventilation of the oven cavity.
- Never line any part of the appliance with foil.
- Always stand back from the appliance when opening the doors to allow any build up of steam or heat to release.
- Do not leave the cookware containing foodstuff, e.g. fat or oil in the appliance in case it is inadvertently switched on.
- Extreme care must be taken when using a ceramic hob scraper.
- Always allow the appliance to cool before switching off at the wall prior to carrying out any cleaning/maintenance work.
- Only clean this appliance in accordance with the instructions given in this book.
- Never use steam or high-pressure steam cleaners to clean the appliance.



WARNING!

Never leave the appliance unattended when the oven door is open.

- Do not place sealed cans or aerosols inside the oven. They may explode if they are heated.
- Ensure that all control knobs are in the off position when not in use.
- Do not stand on the appliance or on the open oven doors.
- Do not hang towels, dishcloths or clothes from the appliance or its handles.
- Do not use this appliance if it is in contact with water.
- Never operate it with wet hands.

Cleaning and maintenance



WARNING!

For hygiene and safety reasons this appliance should be kept clean at all times. A build-up of fat or other foodstuff could result in a fire especially in the grill pan.

Product description

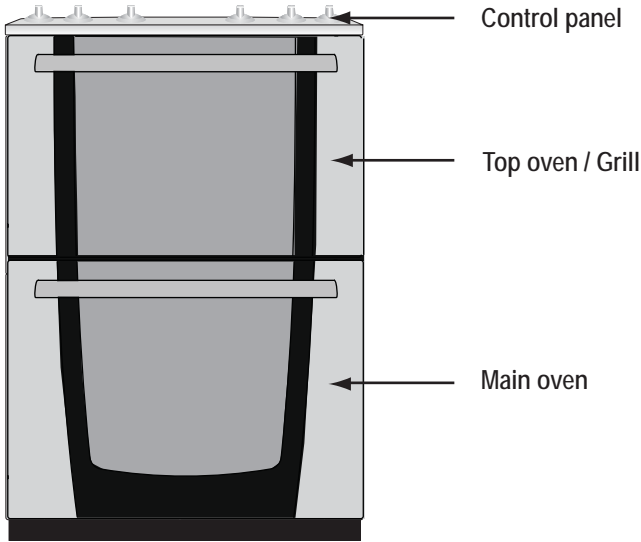

Controls and their functions

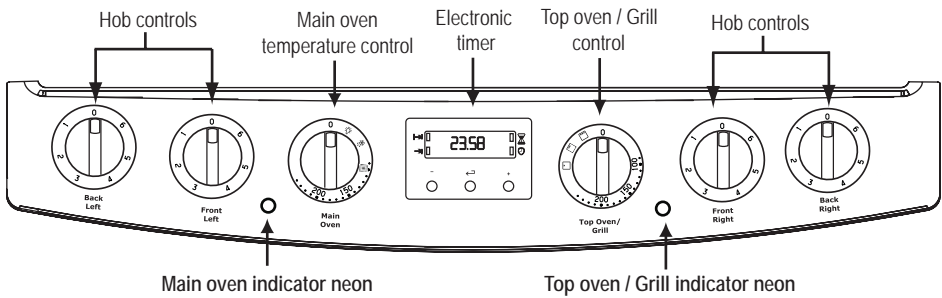

Before using the appliance

Rating plate

- This is situated on the lower front frame of the appliance and can be seen upon opening the door. Alternatively the rating plate may also be found on the back or top of some models (where applicable).
- The appliance must be protected by a suitably rated fuse or circuit breaker.
- The rating of the appliance is given on the rating plate.
- **Do not remove the rating plate from the appliance as this may invalidate the guarantee.**

Preparing to use your appliance

- Wipe over the base of the oven(s) with a soft cloth using hot soapy water. Wash the furniture before use.
- We suggest that you run the oven(s) and grill for 10 – 15 minutes at maximum temperature, to burn off any residue from their surfaces. Accessible parts may become hotter than in normal use. Children should be kept away. During this period an odour may be emitted, it is therefore advisable to open a window for ventilation.

The cooling fan for the controls

- The cooling fan comes on immediately when the grill/top oven is switched on and after a short time when the main oven is in use. It may run on after the controls are switched off until the appliance has cooled.
- During the initial period the cooling fan may turn on and off, this is quite normal.



WARNING!

Always allow the cooling fan to cool the appliance down before switching off at the wall prior to carrying out any cleaning or maintenance work.

Control panel indicator neon(s)

- The indicator neon will operate when the grill (where applicable) or oven(s) is switched on. The indicator neon will glow. It may turn on and off during use to show that the setting is being maintained. If the neon does not operate as the instructions indicate the controls have been incorrectly set. Return all controls to zero and reset following the instructions for the required setting.

Condensation and steam

- When food is heated it produces steam similar to a boiling kettle. The vents allow some of this steam to escape. However, always stand back from the appliance when opening the door(s) to allow any build up of steam or heat to release.
- If the steam comes into contact with a cool surface on the outside of the appliance, e.g. a trim, it will condense and produce water droplets. This is quite normal and is not caused by a fault on the appliance.
- To prevent discolouration, regularly wipe away condensation and foodstuff from surfaces.
- For your safety wall coverings at the rear of the appliance should be securely fixed to the wall.

Cookware

- Baking trays, dishes etc., should not be placed directly against the grid covering the fan at the back of the oven.
- Do not use baking trays larger than 30cm x 35cm (12" x 14") as they will restrict the circulation of heat and may affect performance.

Grill and oven furniture

- The following items of grill and oven furniture have been supplied with the appliance. If you require replacements of any of the items listed below please contact your local service force centre.

1 grill pan

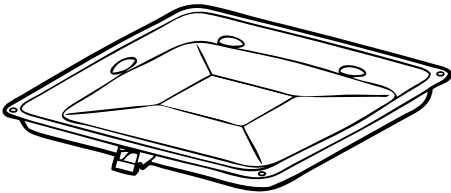

1 grill pan handle

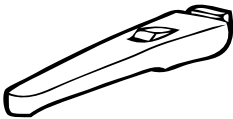

1 grill pan grid

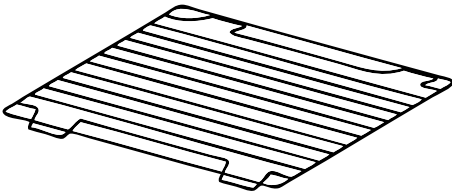

1 straight shelf (For grilling and top oven cooking)

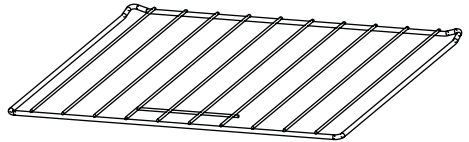

2 straight shelves (For main oven cooking)

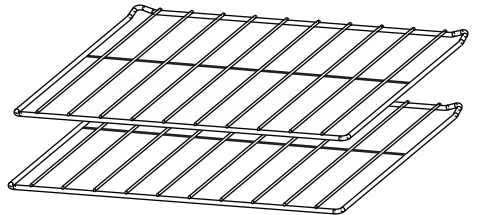

The electronic timer

This oven has a 24-hour clock.

In the event of an interruption of the electricity supply, the clock will stop and you will not be able to use the main oven.

To set the time of day

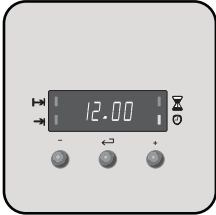

When the electricity is first switched on, the display will show 12.00 and the time indicator neon will flash.



Press the increase buttons until the correct time is showing.

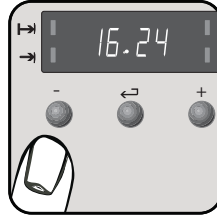

If necessary press the decrease button to help set the correct time.

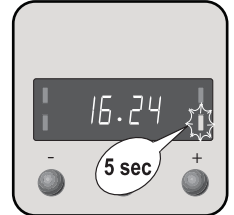

The time indicator neon will flash for 5 seconds then go out.

IMPORTANT!

The increase and decrease control buttons operate slowly at first and then more rapidly. They should be pressed separately.

To set the countdown

The 'Countdown' gives an audible reminder at the end of any period of cooking.

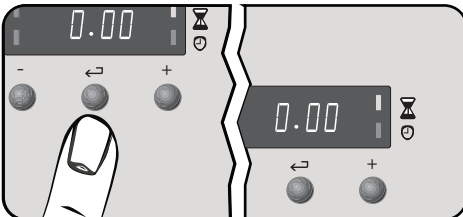

Press the selector control button until the countdown indicator neon is illuminated and the display reads 0.00

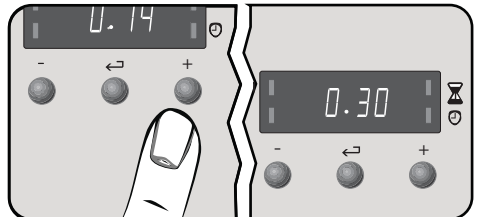

Press the increase button. Release the button once the interval to be timed is reached e.g. 30 minutes.

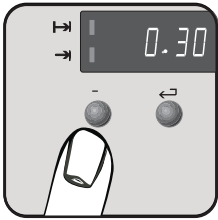

If necessary press the decrease button to achieve the correct time interval.

IMPORTANT!

This must be completed within 5 seconds of first pressing the selector control button

During the operation of the countdown the remaining time period will show in the display

At the end of the timed period a sound will be heard intermittently for up to 2 minutes.

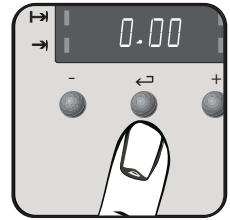

The sound can be stopped by pressing any button.

To cancel the countdown

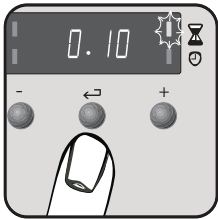

Press the selector control button until the countdown indicator neon flashes.

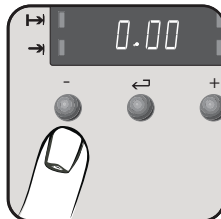

Press the decrease button until 0.00 is shown in the display.

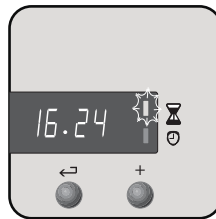

The countdown indicator neon will continue to flash for a few seconds and then return to the time of day.

Setting the oven timer control

Only the main oven can be automatically timed. When using the timer control for the very first time, it is advisable to let it operate while you are at home.

The display can be checked to show that it is operating correctly and you will feel confident to leave a meal to cook automatically in the future.

To set the timer to switch on and off automatically

Ensure the electricity supply is switched on and that the correct time of day is displayed.

Place food in oven.

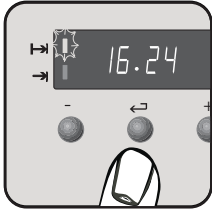

To set the length of cooking time. Press the Selector Control button until the cook time indicator neon is illuminated.

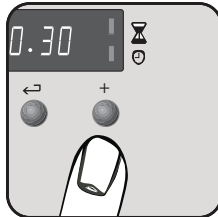

Press the increase control until the required length of cooking time is displayed.

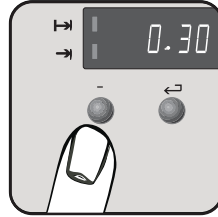

If necessary press the decrease control until the correct time interval is achieved.



Release the buttons. The cook time indicator neon will be illuminated.

IMPORTANT!

Remember, this must be completed within 5 seconds of first pressing the Selector Control button.

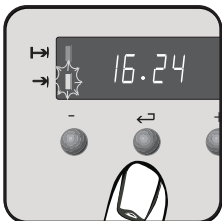

To set the 'End Time'. Press the Selector Control button until the 'End Time' indicator neon flashes.

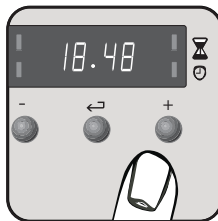

Press the increase control until the required stop time is displayed.

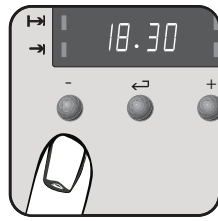

If necessary press the decrease control until the required time interval is achieved.

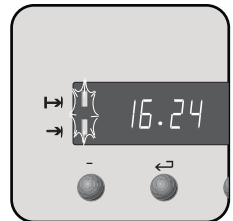

Release the buttons. The time of day will be displayed after 5 seconds. The cook time and end time indicator neons will be illuminated.

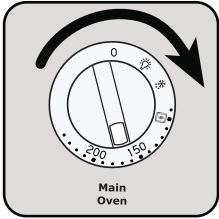

Set the main oven control to the required temperature.

To set the timer to switch off only

Ensure the electricity supply is switched on and that the correct time of day is displayed.

Place food in oven.

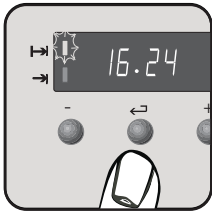

To set the length of cooking time. Press the Selector Control button until the cook time indicator neon is illuminated.

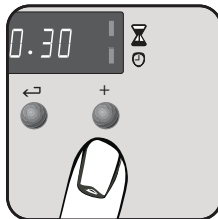

Press the increase control until the required length of cooking time is displayed.

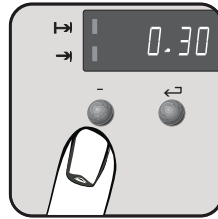

If necessary press the decrease control until the correct time interval is achieved.

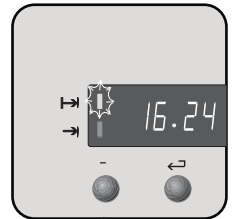

Release the buttons. The cook time indicator neon will be illuminated and the time of day will be displayed after 5 seconds.

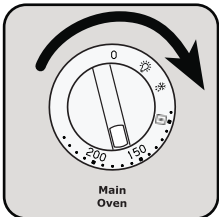

Set the main oven control to the required temperature.

To cancel an automatic programme

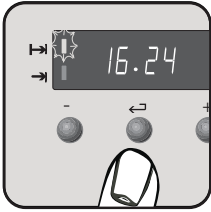

Press the selector control button until the cook time indicator neon flashes.

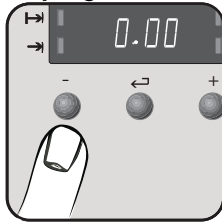

Press the decrease button until 0.00 is shown in the display.

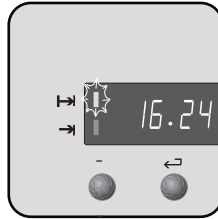

The cook time indicator neon will continue to flash for a few seconds and then return to the time of day.

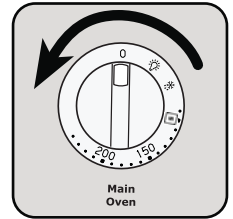

Turn off the oven controls.

To return the appliance to manual

At the end of a timed cooking period, the 'End Time' indicator neon will flash and an alarm will sound for up to 2 minutes.

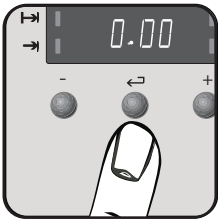

To stop the sound, press any of the three buttons.



The display will return to the time of day.

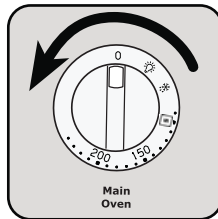

Turn off the oven controls.

Things to note

In the event of an interruption of the electricity supply, the timer will reset itself to zero and all programming will be cancelled.

Your timer has an energy save mode which allows you to switch the display off. For setting details please refer to the environmental chapter of this manual.

Automatic cooking

It is advisable to leave food in the oven for as short a time as possible before automatic cooking. Always ensure commercially prepared food is well within its use by date and that home prepared food is fresh and of good quality.

When cooking is complete, do not leave food to stand in the oven, but remove and cool it quickly if the food is not to be consumed immediately. Always ensure food in the oven has been covered before cooking if it is not possible to remove food immediately after cooking.

The hob

WARNING!

Do not use the appliance if the ceramic glass is damaged. If a fault or crack becomes visible, disconnect the appliance immediately from the electricity supply and contact your local service force centre.

Using the hob

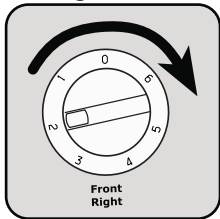

Turn the hob control knob to the required setting.

The highest number represents the hottest setting and the lowest number represents the coolest setting. Choose a setting appropriate to the quantity and type of food to be cooked.

Recommended saucepans

- Only saucepans with flat bases and close fitting lids are recommended. The saucepan base should be approximately the same size as the cooking area.
- Ensure that new saucepans are well scrubbed to remove edges and take off any deposits left from manufacture.
- Traditional round-bottomed Woks must not be used even with a stand. Woks with flat-bottomed bases are available and do comply with the above recommendations.

IMPORTANT!

Occasionally the heated areas may be seen to switch on and off when higher heat settings are being used. This is due to a safety device, which prevents the glass from overheating.

- Some switching on and off when cooking at high temperatures, e.g. deep fat frying is quite

normal, causes no damage to the hob and little delay in cooking times.

- Excessive switching may however be caused by the use of an unsuitable saucepan or a saucepan which is smaller than the heated area. If excessive switching occurs, discontinue use of the saucepan.

Hints and tips when using the hob

- Lift, rather than slide saucepans on and off the hob. This will reduce the risk of scratches and metal marks from saucepans with aluminium bases. Metal marks can be easily cleaned off providing they are not allowed to burn on.
- Follow any guidelines provided by the saucepan manufacturer, particularly those relating to recommended heat settings.
- Avoid using thin, badly dented or distorted saucepans. Those with uneven bases should not be used.

- Never leave the hotplates on when not covered with a saucepan.
- Ensure that the hob and saucepans are clean and dry before the start of cooking.
- Follow the cleaning instructions very closely to keep the hob looking like new.
- If spillage occurs with sugar solutions, e.g. jams and syrups, it must be wiped from the hob before it sets and becomes hard otherwise damage to the hob will occur.

IMPORTANT!

Do not allow hot pans or baking trays to touch the controls as damage may occur.

The grill

! CAUTION!

Accessible parts may be hot when the grill is in use. Young children should be kept away.

The grill is a dual circuit grill which means that the full area of the grill can be used, or for economy purposes, the centre section only can be used when cooking smaller quantities of food.

Using the grill

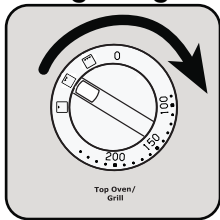

Turn the top oven/grill to the required setting.

The grill settings are as follows:-



Full grill area at $\frac{1}{4}$ power.



Centre grill area at full power.



Full grill area at full power.

Things to note

- To ensure optimal cooking performance the elements have been carefully designed, so that only the inner element glows red. The outer element is hot, but will remain dark in colour. This gives you the best possible cooking results.
- The cooling fan for the controls may operate after a time.

- Some smoke from fat splashes may be evident as the grill cleans itself.

! WARNING!

Never cover the grill pan or grid with foil as this can lead to grill fires.

The grill pan and handle

The grill pan has a removable handle. Attach and remove as described below

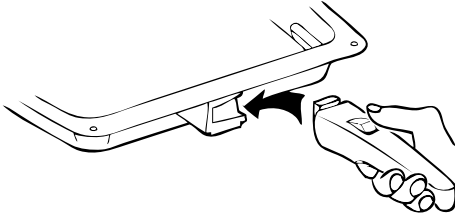

To attach. Press the button on the handle with the thumb and insert the lip into the widest part of the bracket.

Slide the handle towards the left and release the button.

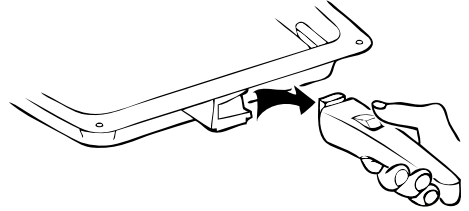

To Remove. Press the button on the handle with the thumb and slide the handle towards the right.

Release the button.

WARNING!

Ensure the handle is properly located.

Place the grill pan on the shelf so that the pan is positioned centrally beneath the grill. Ensure that the cut out on the underside of the handle bracket locates between the bars of the shelf and over the cross bar on the shelf.

WARNING!

Protect your hands when removing the grill pan handle. Always remove the grill pan handle during grilling.

IMPORTANT!

To check the progress of the food being grilled, the grill pan should be withdrawn on the shelf to attend to food during cooking.

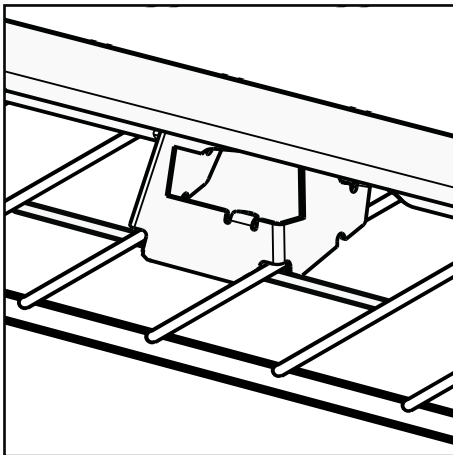

Hints and tips

- Most foods should be placed on the grid in the grill pan to allow maximum circulation of air to lift the food out of the fats and juices.
- Adjust the grid and grill pan runner position to allow for different thicknesses of food.
- Food should be thoroughly dried before grilling to minimise splashing. Brush lean meats and fish lightly with a little oil or melted butter to keep them moist during cooking.
- Accompaniments such as tomatoes and mushrooms may be placed underneath the grid when grilling meats.
- When toasting bread use the shelf in position 3 with the grid in the high position.
- When using the centre section grill, ensure food is placed centrally on the grilling grid directly beneath the grill element.
- Preheat the grill on a full setting for a few minutes before sealing steaks or toasting. Adjust the heat setting and the shelf as necessary during cooking.
- The food should be turned over during cooking as required.

Grilling chart

FOOD	GRILL TIME (mins in total)
Bacon Rashers	5 - 6
Beef Burgers	10 - 15
Chicken Joints	30 - 40
Lamb Chops	15 - 20
Pork Chops	20 - 30
Whole Trout/Mackerel	15 - 25
Plaice/Cod Fillets	10 - 15
Kebabs	20 - 30
Kidneys – Lamb/Pig	8 - 12
Liver – Lamb/Pig	10 - 20
Sausages	20 - 30
Steak – Rare	6 - 12
Steak – Medium	12 - 16
Steak – Well Done	14 - 20
Toasted Sandwiches	3 - 4

IMPORTANT!

The times quoted above are given as a guide and should be adjusted to suit personal taste.

The top oven

The top oven is the smaller of the two ovens. It is designed for cooking smaller quantities of food. It gives especially good results if used to cook fruitcakes, sweets and savoury flans or quiche.

The top oven is also ideal for use as warming compartment to warm dishes and keep food hot. Use the top oven when you want to warm plates. Use the lowest setting on the second oven temperature control.

Using the top oven

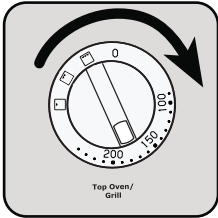

Turn the top oven/grill control to the required setting.

Things to note

- The indicator neon will glow. It may turn ON and OFF during use to show that the setting is being maintained.
- The cooling fan for the controls may operate after a time.



WARNING!

Do not place dishes, tins and trays directly on the oven base as it becomes very hot and damage will occur.

To fit the top oven shelf

The shelf should be fitted with the straight rods uppermost on the frame and the forms towards the back of the oven. To remove a shelf slide the shelf towards you until the shelf stop is reached. Tilt shelf up at the front so that the stops clear the side supports. Lift shelf clear. To install a shelf, reverse the above steps.

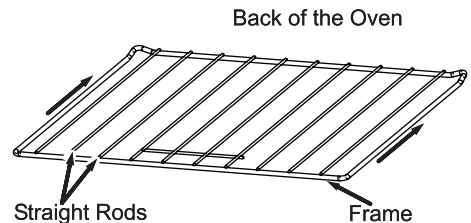

Hints and tips

- Arrange the shelves in the required positions before switching the oven on. Shelf positions are counted from the bottom upwards.

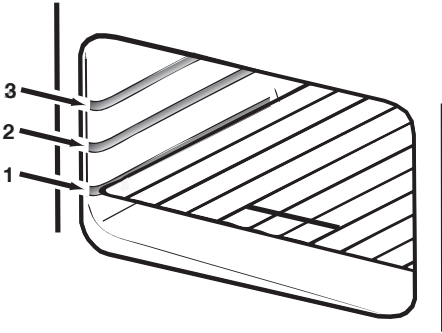

- There should always be at least 2.5cm (1") between the top of the food and the element. This gives best cooking results and allows room for rise in yeast mixtures, Yorkshire puddings etc. When cooking cakes, pastry, scones bread etc., place the tins or baking trays centrally on the shelf.
 - Ensure that food is placed centrally on the shelf and there is sufficient room around the baking tray/dish to allow for maximum circulation.
 - Stand dishes on a suitably sized baking tray on the shelf to prevent spillage onto the oven base and to help reduce cleaning.
- The material and finish of the baking tray and dishes used affect base browning. Enamelware, dark, heavy or non-stick utensils increase base browning. Shiny aluminium or polished steel trays reflect the heat away and give less base browning.
 - Because of the smaller cooking space and lower temperatures, shorter cooking times are sometimes required. Be guided by the recommendations given in the cooking chart.
 - Do not place baking trays directly on the oven base as it interferes with the oven air circulation and can lead to base burning; use the lower shelf position.
 - For economy leave the door open for the shortest possible time, particularly when placing food into a pre-heated oven.



WARNING!

Do not place cookware and cooking pots with rough bases e.g. cast iron on the oven door as damage to the glass may occur.

The main oven

The fan oven is particularly suitable for cooking larger quantities of food. The advantages of fan oven cooking are:

Preheating

The fan oven quickly reaches its temperature, so it is not usually necessary to preheat the oven. Without preheating however, you may need to add an extra 5 – 10 minutes on the recommended cooking times. For recipes needing high temperatures, e.g. bread, pastries, scones, soufflés etc., best results are achieved if the oven is preheated first. For best results when cooking frozen or cooked chilled ready meals always preheat the oven first.

Cooking temperatures

Fan oven cooking generally requires lower temperatures than conventional cooking. Follow the temperatures recommended in the cooking chart. As a guide reduce temperatures by about 20°C – 25°C for your own recipes, using a conventional oven.

Using the main oven

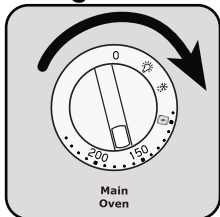

Turn the main oven temperature control to the required setting.

Batch baking

The fan oven cooks evenly on both shelf levels, especially useful when batch baking.

To fit the main oven shelves

The shelf should be fitted with the straight rods uppermost on the frame and the forms towards the back of the oven. To remove a shelf slide the shelf towards you until the shelf stop is reached. Tilt shelf up at the front so that the stops clear the side supports. Lift shelf clear. To install a shelf, reverse the above steps.

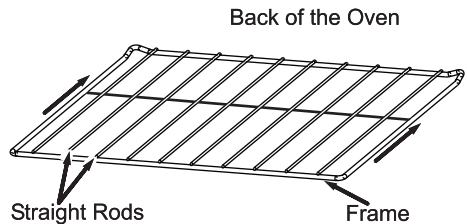

Things to note

- The oven light will illuminate.
- The indicator neon will glow. It may turn on and off during use to show that the setting is being maintained.
- The cooling fan for the controls may operate after a time.
- The oven fan will operate.
- If an automatic programme has been set, the oven light will not come on until cooking begins.

Hints and tips

- Arrange the shelves in the required positions before switching the oven on. Shelf positions are numbered from the bottom upwards.

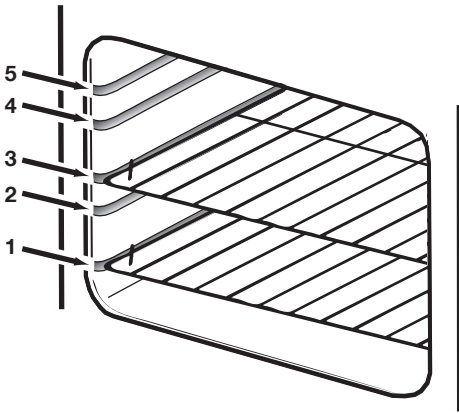

- It is recommended that when baking larger quantities the shelf positions should be evenly spaced to suit the load being cooked. A slight increase in cooking time may be necessary.
- Do not place baking trays directly on the oven base as it interferes with the oven air circulation and can lead to base burning; use the lower shelf position.



WARNING!

Do not place cookware and cooking pots with rough bases e.g. cast iron on the oven door as damage to the glass may occur.

- When cooking more than one dish in the fan oven, place dishes centrally on different shelves rather than cluster several dishes on one shelf, this will allow the heat to circulate freely for the best cooking results.
- When batch baking one type of food, e.g. Victoria sandwich cakes, those of similar size will be cooked in the same time.

Oven cooking chart

The oven temperatures are intended as a guide only. It may be necessary to increase or decrease the temperatures to suit individual preferences and requirements.

FOOD	FAN OVEN	TOP OVEN		APPROX COOK TIME (m)
	COOKING TEMP °C	POS	COOKING TEMP °C	
Biscuits	180 - 190	3	170 - 190	10 - 20
Bread	200 - 220	1	200 - 220	25 - 30
Bread rolls/buns	200 - 220	1	200 - 220	15 - 20
Small / Queen Cakes	160 - 170	2	170 - 180	18 - 25
Sponges	160 - 170	2	160 - 170	18 - 20
Victoria Sandwich	160 - 170	2	160 - 170	18 - 25
Madeira Cake	140 - 150	1	140 - 150	1¼ - 1½h
Rich Fruit Cake	130 - 140	1	140 - 150	2¼ - 2½h
Christmas Cake	130 - 140	1	130 - 140	3 - 4½h
Gingerbread	140 - 150	2	140 - 150	1¼ - 1½h
Meringues	90 - 100	2	90 - 100	2½ - 3h
Flapjack	170 - 180	2	170 - 180	25 - 30
Shortbread	130 - 140	2	140 - 150	45 - 65
Fruit Pies, Crumbles	190 - 200	2	190 - 200	40 - 50
Milk Puddings	130 - 140	2	140 - 150	1½ - 2h
Scones	210 - 220	2	220 - 230	8 - 12

Oven cooking chart continued

FOOD	FAN OVEN	TOP OVEN		APPROX COOK TIME (m)
	COOKING TEMP °C	POS	COOKING TEMP °C	
Choux Pastry	190 - 200	3	180 - 190	30 - 35
Éclairs / Profiteroles	170 - 180	3	170 - 180	20 - 30
Flaky Pastry	210 - 220	3	210 - 220	25 - 40
Mince Pies	190 - 200	2	190 - 200	15 - 20
Pasta Lasagne etc.	190 - 200	2	170 - 180	40 - 45
Meat Pies	190 - 210	2	190 - 210	25 - 35
Quiche, Tarts, Flans	180 - 210	2	180 - 200	25 - 45
Shepherd's Pie	190 - 200	1	190 - 200	30 - 40
Soufflés	170 - 180	2	170 - 180	20 - 30
Fish	170 - 190	2	170 - 190	20 - 30
Fish Pie	190 - 200	1	190 - 200	20 - 25
Beef Casserole	140 - 160	1	140 - 160	2½ - 3h
Lamb Casserole	140 - 160	1	140 - 160	2½ - 3h
Convenience Foods	Follow manufacturer's instructions			
Baked Potatoes	180 - 190	2	180 - 190	1 - 1½h
Roast Potatoes	180 - 190	2	180 - 190	1 - 1½h
Large Yorkshire Puddings:	210 - 220	2	200 - 210	25 - 40
Individual Yorkshire Puddings	200 - 210	2	200 - 210	15 - 25

Note: Shelf positions are counted from the bottom of the oven.

Note: Main oven shelf positions are not critical but ensure that they are evenly spaced when more than one is used.

Roasting chart

Meat	Temperature	Cooking time
Beef/ Beef boned	160 – 180 °C	20-35 minutes per ½kg (1lb) and 20-35 minutes over
Mutton/Lamb	160 – 180 °C	25-35 minutes per ½kg (1lb) and 25-35 minutes over
Pork/Veal/Ham	160 – 180 °C	30-40 minutes per ½kg (1lb) and 30-40 minutes over
Chicken	160 – 180 °C	20-25 minutes per ½kg (1lb) and 20 minutes over
Turkey/Goose	160 – 180 °C	20-25 minutes per ½kg (1lb) up to 3½kg (7lb) then 10 minutes per ½kg (1lb) over 3½kg (7lb)
Duck	160 – 180 °C	25-35 minutes per ½kg (1lb) and 25-30 minutes over
Pheasant	160 – 180 °C	35-40 minutes per ½kg (1lb) and 35-40 minutes over
Rabbit	160 – 180 °C	20 minutes per ½kg (1lb) and 20 minutes over

INTERNAL TEMPERATURES –

Rare: 50-60°C; Medium: 60-70°C; Well done: 70-80°C

The roasting temperatures and times given in the chart should be adequate for most joints, but slight adjustments may be required to allow for personal requirements and the shape and texture of the meat. However, lower temperatures and longer cooking times are recommended for less tender cuts or larger joints.

Wrap joints in foil if preferred, for extra browning uncover for the last 20 – 30 min. cooking time.

Defrost

This main oven function defrosts most foods faster than more conventional methods. It is particularly suitable for delicate frozen foods which are to be served cold e.g. cream filled gateaux, cakes covered with icings or frostings, cheesecakes, biscuits, scones, etc.

Using defrost

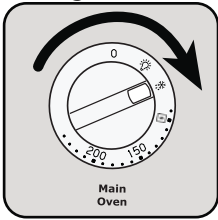

Turn the main oven temperature control to the required setting.

Things to note

- The oven fan and interior light will come on.

Hints and tips

- Place the frozen food in a single layer where possible and turn it over half way through the defrosting process.
 - The actual speed of defrosting is influenced by room temperature. On warm days defrosting will be faster than on cooler days.
 - It is preferable to thaw fish, meat and poultry slowly in the fridge. However, this process can be accelerated by using the defrost function. Small or thin fish fillets, frozen peeled prawns, cubed or minced meat, liver, thin chops, steaks etc., can be thawed in 1 – 2 hours.
 - A 1kg/2¼lb oven ready chicken will be thawed in approximately 5 hours. Remove the giblets as soon as possible during the thawing process.
- Joints of meat up to 2kg/4½lb in weight can be thawed using the defrost function.
 - All joints of meat and poultry must be thawed thoroughly before cooking.
 - Always cook thoroughly immediately after thawing.
 - Do not leave food at room temperature once it is defrosted. Cook raw food immediately or store cooked food in the fridge, once it has cooled.
 - Care must always be taken when handling foods in the home. Always follow the basic rules of food hygiene to prevent bacterial growth and cross contamination when defrosting, preparing, cooking, cooling and freezing foods.

Main oven light

It is possible to turn the light on in your main oven.

Using main oven light

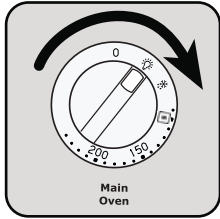

Turn the main oven temperature control to the required setting.

Slow cook

The slow cook setting gives a very low heat in the oven. It is particularly useful when you are cooking soups, stews and casseroles because the long slow cooking will make cheaper, tougher cuts of meat more tender.

Some foods such as pastry and biscuits are not suitable for slow cooking because the temperature is too low. Cover all food during cooking to prevent it from drying out. You can uncover food for the last half hour if it is normally served golden brown.

Using slow cook

You need to cook food at 170°C for 30 minutes before you turn the oven down to the slow cook setting. This makes sure that the temperature of the food gets hot enough to start the food cooking.

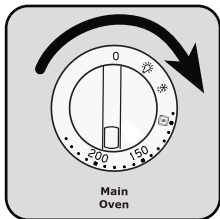

Turn the main oven control knob to the required setting

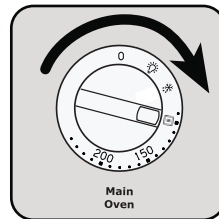

After 30 minutes turn the main oven control to the slow cook setting

Food preparation – slow cooking

Joins of meat and poultry

- Do not cook meat joints over 2.7kg (6lb).
- Do not cook poultry over 2 kg (4lb 8oz).
- Cook on the middle shelf of the oven or above.
- Cook stuffing separately.
- Cook for at least six hours.
- Only cook joints of pork if you can make sure, by using a meat thermometer, that the temperature inside the joint is at least 88° C.
- For good air circulation always stand joints on a rack in a roasting tin or casserole.
- Thaw all frozen meat and poultry before you cook it.
- Prime cuts of meat do not benefit from slow cooking.
- Remove excess fat and skin unless it is browned first.

Soups, casseroles and stews

- Do not cook casseroles over 2.7 kg (6lb).
- Bring to the boil on the hob then cook on slow cook.
- Cook on the middle shelf of the oven or above.
- Cover food with a tight fitting lid or tin foil.

Vegetables

- Cut into small pieces.
- Dried beans must be pre-soaked then boiled in an open pan for 15 minutes before adding to any dish.
- Place vegetables under meat in casseroles.
- Cover food with a tight fitting lid or tin foil.

Milk puddings

- Cover the cereal with boiling water and leave it to stand for 30 minutes.
- Drain and make the pudding in the usual way.

General points

Frozen Foods

Thaw thoroughly before cooking.

Thickening

Toss meat in flour for casseroles.

Alternatively blend cornflour with water and add it at the end of cooking.

Flavouring

Flavours are held in the food because there is little evaporation. Adjust flavouring at the end of the cooking time.

Liquid

Use slightly less liquid as there is little evaporation during cooking. Always add milk and milk products, for example cream towards the end of cooking to prevent them from curdling.

Reheating

Cool left over food quickly and then put it in the fridge. Do not reheat food using the slow cook setting. Reheat food in the usual way or in a microwave. Only reheat food once.

Care and cleaning



WARNING!

Before cleaning always allow the appliance to cool down before switching off at the electricity supply.

Cleaning materials

- Before using any cleaning materials on your appliance, check that they are suitable and that their use is recommended by the manufacturer.
- Cleaners that contain bleach should not be used as they may dull the surface finishes. Harsh abrasives and scourers should also be avoided. Multi-surface anti-bacterial cleaning products should not be used on the ceramic hob or on the surrounding trims.

Cleaning the outside of the appliance

- Do not use abrasive cleaning materials e.g. abrasive cream cleaners, wire wool pads or scourers on painted or printed finishes as damage may occur. Regularly wipe over the control panel, control knobs, handles, doors and appliance sides using a soft cloth and hot soapy water. To prevent streaking, finish with a soft cloth.
- Stainless Steel cream cleaners are abrasive and should be avoided as they may dull the surface finish. **Any spillage on the stainless steel finish must be wiped off immediately.**



WARNING!

Do not attempt to remove any of the control knobs from the appliance as this may cause damage and is a safety hazard.

Cleaning the ceramic hob

- Make sure the ceramic glass is cool before cleaning. It is important to clean the ceramic hob daily to prevent foodstuff being burnt on.
- Take care to avoid the hob trims when cleaning the ceramic glass as they may be damaged by the cleaning agents.

Daily cleaning

- Use a hob-cleaning product specifically designed for ceramic hobs daily. If foodstuff is not allowed to burn on it will be much easier to clean off.
- Apply a small amount of hob cleaner in the centre of each area to be cleaned.
- Dampen a clean paper towel or a plastic pad designed for non-stick saucepans and rub vigorously until all marks are removed. This may take a few minutes.
- Wipe off residues of cleaner with another damp paper towel and polish dry with a soft cloth.
- If hob cleaner is unavailable, one or more of the cleaning agents below may be used temporarily:
 - Cream Cleaner
 - Baking Soda

To remove more stubborn marks

- Cream cleaner may be used to clean off more stubborn stains or to remove discolouration.
- It may be necessary to rub the marks hard for several minutes.
- Use a plastic pad designed for non-stick saucepans with cream cleaner for removal of more stubborn stains.

To remove burnt on foodstuff

- We strongly recommend the use of a Ceramic Hob Scraper (incorporating a single edge razor blade) to remove spillage on the hob, in particular sugar solutions, which if not removed can cause permanent damage.
- Make sure the ceramic glass is cool.
- Use a ceramic hob scraper with care at an angle of 30° to remove as much foodstuff as possible.
- Use hob cleaner or cream cleaner to finish off as directed above.

To remove discolourations or white and silver marks

- These marks sometimes give the impression of being in or underneath the hob glass. They can almost always be removed provided they have not become excessively burnt on. Follow the instructions above under 'To remove more stubborn marks'.
- If this is unsuccessful, make up a paste of one part water to three parts Cream of Tartar and leave on the discoloured areas overnight. The marks should be easily removable the next day provided they have not been excessively burnt on. The paste should be thoroughly washed off afterwards.

IMPORTANT!

To reduce marking of the hob

- Make sure the bottom of the saucepan and the cooking area is clean and dry before cooking begins.
- Ensure saucepans are large enough to accommodate food to avoid boil-over.
- If possible, wipe up spills and splatters as they occur, but take care to avoid steam burns.

- Avoid using a dishcloth or sponge to clean the hob. These may leave a layer of soiled detergent on the hob surface, which will burn and discolour the next time the hob is used.

Avoid the use of:

- Household detergents and bleaches.
- Impregnated plastic or nylon pads that are not described as suitable for non-stick saucepans.
- Abrasive cleaning pads, scourers and steel wool pads.
- Chemical oven cleaners, e.g. aerosols and oven pads.
- Rust stain, bath and sink stain removers.
- Any of the above products may cause damage to the hob.
- It is dangerous to mix different cleaning products. The chemicals in them may react with each other with hazardous results.
- Sugar solutions must be removed from the hob before the syrup has set otherwise damage to the hob surface will occur.
- Avoid placing plastic items, foil or dishes on the hot surface as this will cause damage to the hob

Cleaning the grill/oven furniture

- All removable parts, except the grill pan handle can be washed in the dishwasher.
- The grill pan, grill pan grid and oven shelves may be cleaned using a soap impregnated steel wool pad. Soaking first in hot soapy water will make cleaning easier.

Cleaning inside the grill and oven compartments

- The sides and back of the main oven compartment are coated with a special Stay-clean coating. They should not be cleaned manually.
- The vitreous enamel grill/second oven and main oven base and grill compartment base can be cleaned using normal oven cleaners with care. Ensure that the manufacturers instructions are followed and that all parts are well rinsed afterwards.

WARNING!

Aerosol cleaners must not come into contact with elements, the door seal, or any painted finishes as this may cause damage.

WARNING!

Aerosol cleaners must not be used on Stay-clean surfaces.

- To carry out the cleaning cycle, remove the oven shelves and set the oven to 220°C.
- It is a good idea to run the oven for an hour or two per week to ensure continued good performance from the Stay-clean finish.
- Slight discolouration and polishing of the Stay-clean surfaces may occur in time. This does not affect the Stay-clean properties in any way.
- Use minimal, if any, extra oil or fat when roasting meat, potatoes only require brushing with fat before cooking. Extra fat in the oven during roasting will increase splashing and staining of the cavity.
- It is not necessary to add water to a meat tin when roasting. The water and the fat juices from the joint create excessive splattering during cooking – even at normal

temperatures, as well as causing condensation.

- Covering joints during cooking will also prevent splashing onto the interior surfaces. Removing the covering for the last 20-30 minutes will allow extra browning if required. Some large joints and turkeys especially benefit by this method of cooking, allowing the joint to cook through before the outside is over-browned.

Cleaning the door(s)

WARNING!

To prevent damaging or weakening the door glass panels avoid the use of the following:

- Household detergents and bleaches
- Soap impregnated pads unsuitable for non-stick saucepans.
- Abrasive cleaning pads, scourers and steel wool pads.
- Chemical oven pads or aerosols.
- Rust removers.
- Bath/Sink stain removers.

Cleaning between the outer and inner door glass

IMPORTANT!

The inner door glass is removable for cleaning.

IMPORTANT!

Please note that the door glass on your product may differ in type and shape from that shown in the diagrams.

To remove the glass

Open the oven door to gain access to the top of the oven door.

Top Oven:

- Carefully push the trim towards the oven and lift off.
- Hold the door glass securely in place with one hand before sliding the glass out with the other hand.

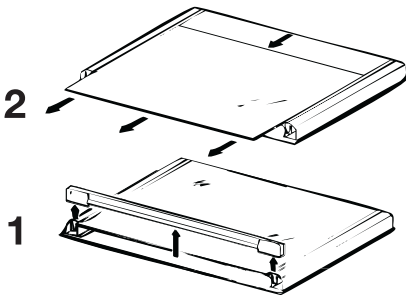

Main Oven:

- Carefully push the trim towards the oven.
- Hold the door glass securely in place with one hand before sliding the glass out with the other hand.

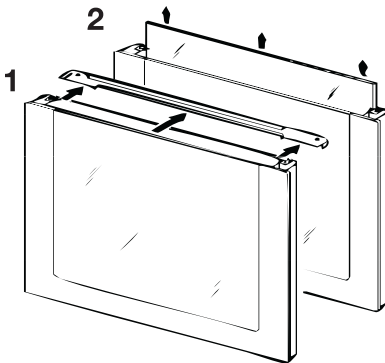

! WARNING!

If the door glass panel becomes chipped or has deep scratches the glass will be weakened and must be replaced to prevent the possibility of the panel shattering. Please contact your local service force centre who will be pleased to advise further.

To replace the door glass

To ensure the glass is properly located the text should be facing towards you at the top edge of the door and facing into the cavity.

Holding the glass with both hands, gently slide the glass into the side trims of the oven door.

Always ensure that the glass is returned to the same side trim it was removed from.

To replace the trim, line up the clips on the underside of the trim with the connectors at the top of the door.

Carefully slide the trim towards the door.

Ensure the trim is securely in place before closing the oven door.

! WARNING!

Do not attempt to use the oven without the glass being in place.

To clean the glass door panels

Clean the inner glass door panels using hot soapy water, hob cleaner may also be used. Do not use hob cleaner on the stainless steel or painted surfaces. Ensure that all parts are well rinsed and thoroughly dried before attempting to replace the glass.

Replacing an oven light bulb

- The type of bulb required is a 300°C 25 watt small Edison Screw.

WARNING!

Disconnect the appliance from the electricity supply before replacing the bulb.

- Make sure the appliance is cool before replacing the bulb.
- Open the door and remove the shelves.
- Remove the glass cover by turning it to the left.
- Unscrew the bulb by turning it to the left.
- Fit a new bulb and then replace the glass bulb cover.
- Replace the shelves.
- Restore the electricity supply and reset the time of day.

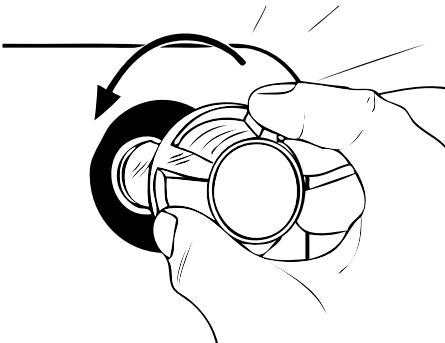

Troubleshooting

Please carry out the following checks on your appliance before calling a Service Engineer. It may be that the problem is a simple one which you can solve yourself without the expense of a service call.

In-guarantee customers should make sure that the checks have been made as the engineer will make a charge if the fault is not a mechanical or electrical breakdown.

Please note that proof of purchase is required for in-guarantee service calls.

PROBLEM	POSSIBLE SOLUTION
The grill, ovens and timer do not work.	Check that the appliance has been wired in to the appliance supply and is switched on at the wall. Check that the main appliance fuse is working.
	If you have checked the above: Allow the appliance to cool for a couple of hours. The appliance should now be working normally.
The grill and top oven work but the main oven does not.	Check that the time of day has been set on the clock.
The grill does not work or cuts out after being used for a long period of time.	Ensure the cooling fan is running when the grill is on. If the cooling fan fails, the grill will not operate correctly. Contact your local service force centre. Leave the grill door open and allow the grill to cool. After a couple of hours check that the grill works as normal
The timer does not work.	Check that the instructions for the operation of the timer are being closely followed.
The oven is not cooking evenly.	Check that the appliance is correctly installed and is level. Check that the recommended temperatures and shelf positions are being used.
The indicator neons are not working correctly.	Check that you have selected only the function you require. Ensure all other controls are in the off position.

PROBLEM	POSSIBLE SOLUTION
The oven light fails to illuminate.	The oven light bulb may need replacing.
	If the Main Oven is set for automatic cooking the light will illuminate when the cook time begins.
The oven fan is noisy.	Check that the oven is level.
	Check that the shelves and bakeware are not vibrating in contact with the oven back panel.
The oven temperature is too high or too low.	Check that the recommended temperatures and shelf positions are being used. Be prepared to adjust the temperature up or down to achieve the results you want.

Installation instructions

WARNING!

This appliance must be earthed

- If your appliance has been damaged in transit, contact your supplier immediately. Do not attempt to install it.
- Your appliance left the factory fully packaged to protect it from damage. If it is delivered without packaging and damage has occurred, the manufacturer cannot accept responsibility. Contact your supplier for advice.
- Once the packaging has been removed the appliance should only be moved by hand. Do not use a sack barrow or any other aid to lift the appliance as damage may occur.
- To move the appliance, open the oven door and lift the appliance by holding inside the top of the compartment.
- This is a type Y appliance, which means it is freestanding and can be fitted with cabinets on one or both sides. It may also be fitted in a corner setting.
- Sidewalls, which are above hob level, should be protected by heat resistant non-combustible material and must not be nearer than 40mm to the hob side.
- A nominal air gap of 2mm at either side of the appliance is required to enable the appliance to be moved into position.
- Always ensure an air gap is maintained at hotplate level. Tiles or other forms of deep wall covering should not obscure this gap.

- Overhanging surfaces or a cooker hood should be a minimum of 685mm above the hob.

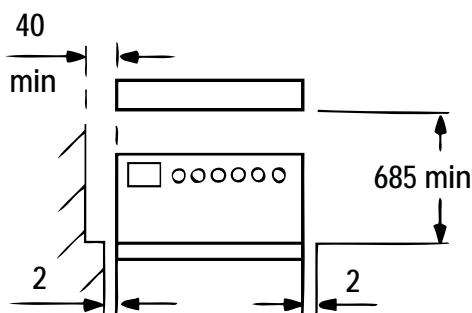

- It is important to ensure that the appliance is level after installation. Levelling feet are fitted to the appliance to accommodate uneven floors.

Connecting to the electricity supply

WARNING!

This appliance must be earthed. Do not earth this appliance to gas supply piping. Connect to 230 - 240V AC supply only.

- Connection to the electricity supply must be carried out by a qualified electrician/competent person.
- The electrical connection should be made using a double pole isolating switch (cooker socket) with at least 3mm contact separation in all poles. The cable must have conductors of sufficiently high cross-sectional area to prevent overheating and deterioration.

- We recommend you use a new length of 6mm² twin core earthed cable to ensure your safety.
- Make connection by proceeding as follows: -

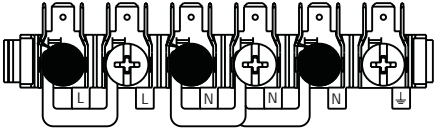

Note: Blanking plates not to be removed.

Ensure that the links are fitted as shown

- Pre-form wires to the appropriate shape to suit fitting into the mains terminal block.
- Strip inner insulation on wires using wire strippers.
- Twist the bared wires using pliers.
- Cut bared wires 10mm away from the end of the inner insulation.
- Where uninsulated Earth wires are used ensure they are suitably sheathed to leave 10mm bare wire to fit into the terminal.
- Clamp bare wires into the relevant terminal and check they are held by tugging each one in turn.
- Ensure all screws are securely tightened.
- Clamp the mains cable securely ensuring 5mm of the outer insulation is inside the terminal block and that the wires are not taut but not so slack as to cause any fouling.
- Connect the remaining end of the mains cable to the appliance to the appliance point / junction box.
- Place fuse / miniature circuit breaker in circuit and switch on at mains.

- When refitting the mains terminal cover, ensure that the lower tabs are located inside the bottom edge of the aperture, before fixing the two screws into the top edge of the mains terminal cover.

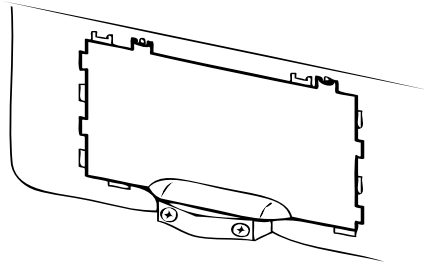
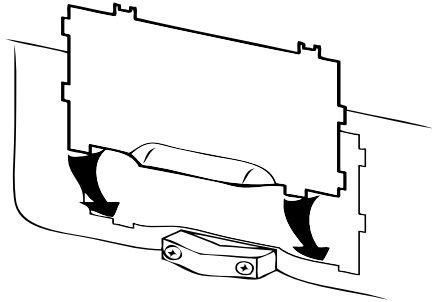

- Ensure that the cover is securely fastened.

Note: House circuit

Earth leakage / continuity tests must be carried out before the appliance is connected to the mains supply and re-checked after fitting.

Technical data

Voltage:	230-240 Volts AC 50Hz
Wattage:	9.5 - 10.3 kW
Height:	900mm
Width:	550mm
Depth: (excluding handles and knobs)	600mm
Weight	58.0kg



This appliance complies with: European Council Directive 73/23/EEC, EMC Directive 89/336/EEC, CE Marking Directive 93/68/EEC, Energy Label Directive 2002/40/EC

Environment



After installation please dispose of the packaging with due regard for safety and the environment. Your local authority can arrange this.

Energy save mode

By switching off the time display you can save energy.

Switching off the time display

Press and hold any two buttons until the display switches off.

Switching on the time display

Press any button to switch on the display.

IMPORTANT!

The display can only be switched off if none of the timer functions, 'Cooktime', 'Endtime', or 'Countdown', is in use.



At the end of the appliances life

The symbol  on the product or on its packaging indicates that this product may not be treated as household waste. Instead it shall be handed over to the applicable collection point for the recycling of electrical and electronic equipment. By ensuring this product is disposed of correctly, you will help prevent potential negative consequences for the environment and human health, which could otherwise be caused by inappropriate waste handling of this product. For more detailed information about recycling of this product, please contact your local city office, your household waste disposal service or the shop where you purchased the product.

Guarantee / Customer care

Standard guarantee conditions

We, Electrolux, undertake that if within 12 months of the date of the purchase this Electrolux appliance or any part thereof is proved to be defective by reason only of faulty workmanship or materials, we will, at our option repair or replace the same FREE OF CHARGE for labour, materials or carriage on condition that:

- The appliance has been correctly installed and used only on the electricity supply stated on the rating plate.
- The appliance has been used for normal domestic purposes only, and in accordance with the manufacturer's instructions.
- The appliance has not been serviced, maintained, repaired, taken apart or tampered with by any person not authorised by us.
- Electrolux Service Force Centre must undertake all service work under this guarantee
- Any appliance or defective part replaced shall become the Company's property.
- This guarantee is in addition to your statutory and other legal rights.

Exclusions

- Damage or calls resulting from transportation, improper use or neglect, the replacement of any light bulbs or removable parts of glass or plastic.
- Costs incurred for calls to put right an appliance which is improperly installed or calls to appliances outside the United Kingdom.
- Appliances found to be in use within a commercial environment, plus those which are subject to rental agreements.
- Products of Electrolux manufacturer that are not marketed by Electrolux

Service and Spare Parts

In the event of your appliance requiring service, or if you wish to purchase spare parts, please contact your local Service Force Centre by telephoning

0870 5 929 929

Your telephone call will be automatically routed to the Service Force Centre covering your postcode area. For the address of your local Service Force Centre and further information about Service Force, please visit the website at

www.serviceforce.co.uk

Before calling out an engineer, please ensure you have read the details under the heading "Something not working"

When you contact the Service Force Centre you will need to give the following details:

1. Your name, address and postcode.
2. Your telephone number.
3. Clear concise details of the fault.
4. The model and Serial number of the appliance (found on the rating plate).
5. The purchase date.

Please note a valid purchase receipt or guarantee documentation is required for in guarantee service calls.

Customer Care

For general enquiries concerning your Electrolux appliance, or for further information on Electrolux products please contact our Customer Care Department by letter or telephone at the address below or visit our website at www.electrolux.co.uk

Customer Care Department
Electrolux Major Appliances
Addington Way
Luton
Bedfordshire, LU4 9QQ
Tel: 08705 950 950 (*)

(*) Calls may be recorded for training purposes



Notes

Notes

ZANUSSI

 Electrolux

www.electrolux.com

www.zanussi-electrolux.co.uk