

A-S700

Integrated Amplifier
Amplificateur Intégré

OWNER'S MANUAL
MODE D'EMPLOI

IMPORTANT SAFETY INSTRUCTIONS

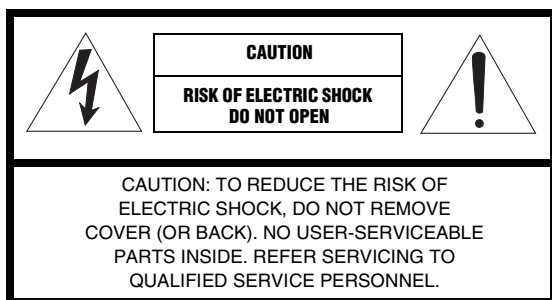

• Explanation of Graphical Symbols



The lightning flash with arrowhead symbol, within an equilateral triangle, is intended to alert you to the presence of uninsulated "dangerous voltage" within the product's enclosure that may be of sufficient magnitude to constitute a risk of electric shock to persons.



The exclamation point within an equilateral triangle is intended to alert you to the presence of important operating and maintenance (servicing) instructions in the literature accompanying the appliance.

IMPORTANT

Please record the serial number of this unit in the space below.

MODEL:

Serial No.:

The serial number is located on the rear of the unit.

Retain this Owner's Manual in a safe place for future reference.

FOR CANADIAN CUSTOMERS

To prevent electric shock, match wide blade of plug to wide slot and fully insert.

This Class B digital apparatus complies with Canadian ICES-003.

- 1 Read these instructions.
- 2 Keep these instructions.
- 3 Heed all warnings.
- 4 Follow all instructions.
- 5 Do not use this apparatus near water.
- 6 Clean only with dry cloth.
- 7 Do not block any ventilation openings. Install in accordance with the manufacturer's instructions.
- 8 Do not install near any heat sources such as radiators, heat registers, stoves, or other apparatus (including amplifiers) that produce heat.
- 9 Do not defeat the safety purpose of the polarized or grounding-type plug. A polarized plug has two blades with one wider than the other. A grounding type plug has two blades and a third grounding prong. The wide blade or the third prong are provided for your safety. If the provided plug does not fit into your outlet, consult an electrician for replacement of the obsolete outlet.
- 10 Protect the power cable from being walked on or pinched particularly at plugs, convenience receptacles, and the point where they exit from the apparatus.
- 11 Only use attachments/accessories specified by the manufacturer.
- 12 Use only with the cart, stand, tripod, bracket, or table specified by the manufacturer, or sold with the apparatus. When a cart is used, use caution when moving the cart/apparatus combination to avoid injury from tip-over.
- 13 Unplug this apparatus during lightning storms or when unused for long periods of time.
- 14 Refer all servicing to qualified service personnel. Servicing is required when the apparatus has been damaged in any way, such as power-supply cable or plug is damaged, liquid has been spilled or objects have fallen into the apparatus, the apparatus has been exposed to rain or moisture, does not operate normally, or has been dropped.



We Want You Listening For A Lifetime

Yamaha and the Electronic Industries Association's Consumer Electronics Group want you to get the most out of your equipment by playing it at a safe level. One that lets the sound come through loud and clear without annoying blaring or distortion – and, most importantly, without affecting your sensitive hearing. Since hearing damage from loud sounds is often undetectable until it is too late, Yamaha and the Electronic Industries Association's Consumer Electronics Group recommend you to avoid prolonged exposure from excessive volume levels.



FCC INFORMATION (for US customers)

1 IMPORTANT NOTICE: DO NOT MODIFY THIS UNIT!

This product, when installed as indicated in the instructions contained in this manual, meets FCC requirements. Modifications not expressly approved by Yamaha may void your authority, granted by the FCC, to use the product.

2 IMPORTANT: When connecting this product to accessories and/or another product use only high quality shielded cables. Cable/s supplied with this product **MUST** be used. Follow all installation instructions. Failure to follow instructions could void your FCC authorization to use this product in the USA.

3 NOTE: This product has been tested and found to comply with the requirements listed in FCC Regulations, Part 15 for Class "B" digital devices. Compliance with these requirements provides a reasonable level of assurance that your use of this product in a residential environment will not result in harmful interference with other electronic devices.
This equipment generates/uses radio frequencies and, if not installed and used according to the instructions found in the users manual, may cause interference harmful to the operation of other electronic devices.

Compliance with FCC regulations does not guarantee that interference will not occur in all installations. If this product is found to be the source of interference, which can be determined by turning the unit "OFF" and "ON", please try to eliminate the problem by using one of the following measures:

Relocate either this product or the device that is being affected by the interference.

Utilize power outlets that are on different branch (circuit breaker or fuse) circuits or install AC line filter/s.

In the case of radio or TV interference, relocate/reorient the antenna. If the antenna lead-in is 300 ohm ribbon lead, change the lead-in to coaxial type cable.

If these corrective measures do not produce satisfactory results, please contact the local retailer authorized to distribute this type of product. If you can not locate the appropriate retailer, please contact Yamaha Electronics Corp., U.S.A. 6660 Orangethorpe Ave., Buena Park, CA 90620.

The above statements apply **ONLY** to those products distributed by Yamaha Corporation of America or its subsidiaries.

■ For U.K. customers

If the socket outlets in the home are not suitable for the plug supplied with this appliance, it should be cut off and an appropriate 3 pin plug fitted. For details, refer to the instructions described below.

Note

The plug severed from the mains lead must be destroyed, as a plug with bared flexible cord is hazardous if engaged in a live socket outlet.

■ Special Instructions for U.K. Model

IMPORTANT

THE WIRES IN MAINS LEAD ARE COLOURED IN ACCORDANCE WITH THE FOLLOWING CODE:

Blue: NEUTRAL

Brown: LIVE

As the colours of the wires in the mains lead of this apparatus may not correspond with the coloured markings identifying the terminals in your plug, proceed as follows:

The wire which is coloured **BLUE** must be connected to the terminal which is marked with the letter **N** or coloured **BLACK**. The wire which is coloured **BROWN** must be connected to the terminal which is marked with the letter **L** or coloured **RED**.

Making sure that neither core is connected to the earth terminal of the three pin plug.

CAUTION: READ THIS BEFORE OPERATING YOUR UNIT.

- 1 To assure the finest performance, please read this manual carefully. Keep it in a safe place for future reference.
- 2 Install this sound system in a well ventilated, cool, dry, clean place – away from direct sunlight, heat sources, vibration, dust, moisture, and/or cold. Allow ventilation space of at least 30 cm (11-13/16 in) on the top, 20 cm (7-7/8 in) on the left and right, and 20 cm (7-7/8 in) on the back of this unit.
- 3 Locate this unit away from other electrical appliances, motors, or transformers to avoid humming sounds.
- 4 Do not expose this unit to sudden temperature changes from cold to hot, and do not locate this unit in an environment with high humidity (i.e. a room with a humidifier) to prevent condensation inside this unit, which may cause an electrical shock, fire, damage to this unit, and/or personal injury.
- 5 Avoid installing this unit where foreign objects may fall onto this unit and/or this unit may be exposed to liquid dripping or splashing. On the top of this unit, do not place:
 - Other components, as they may cause damage and/or discoloration on the surface of this unit.
 - Burning objects (i.e. candles), as they may cause fire, damage to this unit, and/or personal injury.
 - Containers with liquid in them, as they may fall and liquid may cause electrical shock to the user and/or damage to this unit.
- 6 Do not cover this unit with a newspaper, tablecloth, curtain, etc. in order not to obstruct heat radiation. If the temperature inside this unit rises, it may cause fire, damage to this unit, and/or personal injury.
- 7 Do not plug in this unit to a wall outlet until all connections are complete.
- 8 Do not operate this unit upside-down. It may overheat, possibly causing damage.
- 9 Do not use force on switches, knobs and/or cords.
- 10 When disconnecting the power cable from the wall outlet, grasp the plug; do not pull the cable.
- 11 Do not clean this unit with chemical solvents; this might damage the finish. Use a clean, dry cloth.
- 12 Only voltage specified on this unit must be used. Using this unit with a higher voltage than specified is dangerous and may cause fire, damage to this unit, and/or personal injury. Yamaha will not be held responsible for any damage resulting from use of this unit with a voltage other than specified.
- 13 To prevent damage by lightning, keep the power cable disconnected from a wall outlet or the unit during a lightning storm.
- 14 Do not attempt to modify or fix this unit. Contact qualified Yamaha service personnel when any service is needed. The cabinet should never be opened for any reasons.
- 15 When not planning to use this unit for long periods of time (i.e. vacation), disconnect the AC power plug from the wall outlet.
- 16 Install this unit near the AC outlet and where the AC power plug can be reached easily.
- 17 Be sure to read the “TROUBLESHOOTING” section in the owner’s manual on common operating errors before concluding that this unit is faulty.
- 18 Before moving this unit, press POWER to turn off this unit and then disconnect the AC power plug from the wall outlet.
- 19 **VOLTAGE SELECTOR** (Asia and General models only)
The VOLTAGE SELECTOR on the rear panel of this unit must be set for your local main voltage BEFORE plugging into the wall outlet. Voltages are:
 - Asia model.....AC 220/230-240 V, 50/60 Hz
 - General modelAC 110/120/220/230-240 V, 50/60 Hz
- 20 The batteries shall not be exposed to excessive heat such as sunshine, fire or like.
- 21 Excessive sound pressure from earphones and headphones can cause hearing loss.

As long as this unit is connected to the AC wall outlet, it is not disconnected from the AC power source even if you turn off this unit by POWER or set it to the standby mode by \odot button on the remote control.

WARNING
TO REDUCE THE RISK OF FIRE OR ELECTRIC SHOCK, DO NOT EXPOSE THIS UNIT TO RAIN OR MOISTURE.

This unit enters the standby mode when you press POWER inward to the ON position and then press \odot button on the remote control. In this state, this unit is designed to consume a very small quantity of power.

CONTENTS

INTRODUCTION

FEATURES.....	1
SUPPLIED ACCESSORIES.....	1
CONTROLS AND FUNCTIONS.....	2
Front panel.....	2
Remote control.....	3
Installing batteries in the remote control.....	4
Using the remote control.....	4
Rear panel.....	5

PREPARATION

CONNECTIONS.....	6
Connecting speakers and other components.....	6
Connecting the supplied power cable.....	8

OPERATION

PLAYING AND RECORDING.....	9
Playing a source.....	9
Adjusting the tonal quality.....	10
Recording a source.....	11

ADDITIONAL INFORMATION

TROUBLESHOOTING.....	12
SPECIFICATIONS.....	15

INTRODUCTION

PREPARATION

OPERATION

ADDITIONAL
INFORMATION

■ About this manual

-  indicates a tip for your operation.
- Some operations can be performed by using either the buttons on the main unit or on the remote control. In cases when the button names differ between the main unit and the remote control, the names of the buttons on the remote control are given in parentheses.
- This manual is printed prior to production. Design and specifications are subject to change in part as a result of improvements, etc. In case of differences between the manual and the product, the product has priority.

FEATURES

- ◆ Highly dynamic power, low impedance drive capability
- ◆ Continuously variable loudness control
- ◆ CD DIRECT AMP switch used to obtain the highest sound quality of compact discs
- ◆ PURE DIRECT switch used to reproduce the purest source sound
- ◆ Minimum RMS output power
90 W + 90 W (8 Ω), 0.019% THD, 20 Hz to 20 kHz
- ◆ REC OUT selector independent of input source selection
- ◆ Remote control capability

SUPPLIED ACCESSORIES

Please check that you received all of the following parts:

Remote control

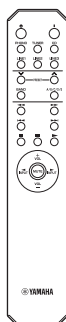

Batteries (x 2)
(AA, R6, UM-3)

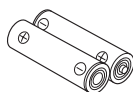

Power cable

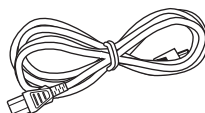

English

CONTROLS AND FUNCTIONS

Front panel

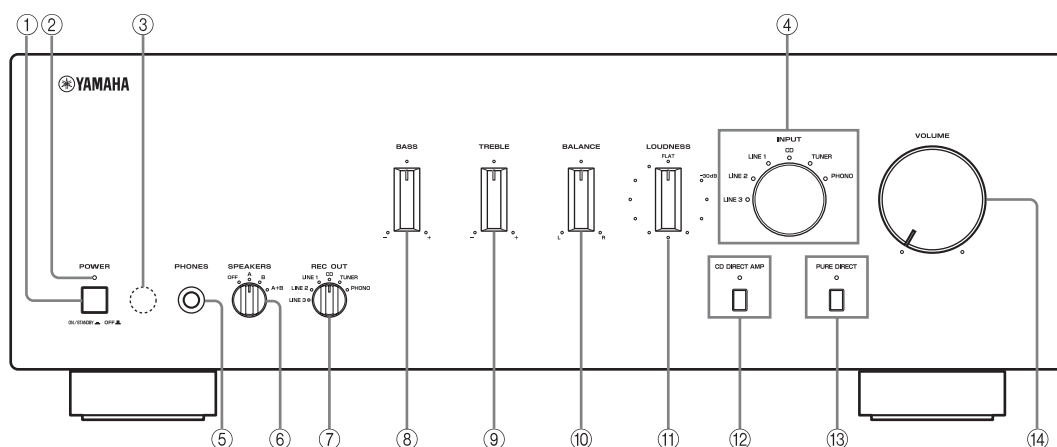

① POWER

Press inward to the ON position to turn on the power of this unit. You can set this unit to standby mode by pressing \odot button on the remote control or turn on the unit by pressing I button on the remote control when this unit is turned on.

Press again to release it outward to the OFF position to turn off this unit.

Note

Even when this unit is turned off, this unit consumes a small amount of power to preserve the memory.

② POWER on indicator

Lights up as follows:

ON: Bright

Standby mode: Dark

OFF: Off

③ Remote control sensor

Receives signals from the remote control.

④ INPUT selector and indicators

Select the input source you want to listen to.

The input source indicators light up when the corresponding input sources are selected.



The input source names correspond to the names of the connection jacks on the rear panel.

Note

The input setting is retained for about 1 week after the power cable is unplugged.

⑤ PHONES jack

Connect headphones for private listening.

Rotate the SPEAKERS selector on the front panel to the OFF position to turn off the sound from the speakers.

⑥ SPEAKERS selector

Turn on or off the speaker set connected to the SPEAKERS A and/or B terminals on the rear panel each time the corresponding SPEAKERS selector is set to A, B or A+B.

⑦ REC OUT selector

Select a source for recording independently of the INPUT selector setting, allowing you to record the selected source while listening to another source.

See page 11 for details.

⑧ BASS

Increase or decrease the low frequency response.

See page 10 for details.

⑨ TREBLE

Increase or decrease the high frequency response.

See page 10 for details.

⑩ BALANCE

Adjust the sound output balance of the left and right speakers. See page 10 for details.

⑪ LOUDNESS

Retain a full tonal range at any volume level.

See page 11 for details.

⑫ CD DIRECT AMP and indicator

Reproduces CD sound in the highest signal quality regardless of the INPUT selector setting.

The indicator above it lights up when this function is turned on. See page 10 for details.

⑬ PURE DIRECT and indicator

Reproduces any input source in the purest sound possible. The indicator above it lights up when this function is turned on. See page 10 for details.

⑭ VOLUME

Control the sound output level. This does not affect the REC level for recording.

Remote control

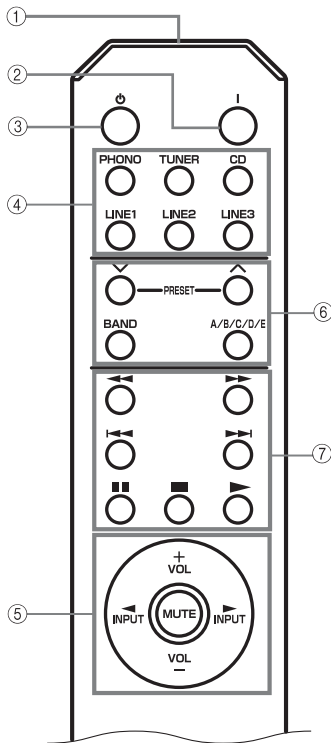

■ Controlling this unit

① Infrared signal transmitter

Sends signals to the main unit.

② POWER (I)

Turn on the unit.

Note

This button is operational only when POWER on the front panel is pressed inward to the ON position.

③ STANDBY (⏻)

Set this unit to the standby mode.

Notes

- This button is operational only when POWER on the front panel is pressed inward to the ON position.
- In the standby mode, this unit consumes a small amount of power in order to receive infrared-signals from the remote control.

④ Input selector buttons

Select the input source you want to listen to.

⑤ Amplifier control buttons**INPUT </>**

Select the input source you want to listen to.

VOL +/-

Control the sound output level.

This does not affect the REC level for recording.

MUTE

Mute the sound output. Press MUTE again to resume the audio output. Selected Input indicator blinks when the sound is muted.

■ Controlling other components

The functions of the buttons to control other Yamaha components are the same as those of the corresponding buttons on those components. Refer to the components' instruction manuals for details.

⑥ Yamaha tuner control buttons

Control various functions of Yamaha tuner. Refer to the owner's manual of your tuner for details.

Note

Not all Yamaha tuners or functions can be controlled by this remote control.

⑦ Yamaha CD player control buttons

Control various functions of Yamaha CD player. Refer to the owner's manual of your CD player for details.

Note

Not all Yamaha CD players or functions can be controlled by this remote control.

Installing batteries in the remote control

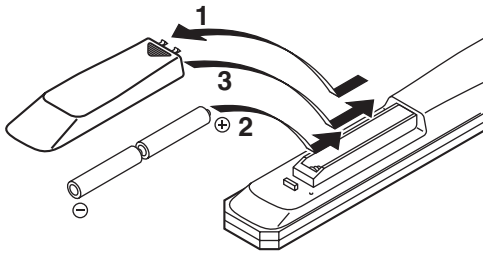

- 1** Press the ▼ part and slide the battery compartment cover off.
- 2** Insert two supplied batteries (AA, R6, UM-3) according to the polarity markings (+ and -) on the inside of the battery compartment.
- 3** Slide the cover back until it snaps into place.

■ Notes on batteries

- Change both batteries when the operation range of the remote control decreases.
- Use AA, R6, UM-3 batteries.
- Make sure that the polarities are correct. See the illustration inside the battery compartment.
- Remove the batteries if the remote control is not to be used for an extended period of time.
- Do not use old batteries together with new ones.
- Do not use different types of batteries (such as alkaline and manganese batteries) together. Read the packaging carefully as these different types of batteries may have the same shape and color.
- If the batteries have leaked, dispose of them immediately. Avoid touching the leaked material or letting it come into contact with clothing, etc. Clean the battery compartment thoroughly before installing new batteries.
- Do not throw away batteries with general house waste; dispose of them correctly in accordance with your local regulations.

Using the remote control

The remote control transmits a directional infrared beam. Be sure to aim the remote control directly at the remote control sensor on the front panel of this unit during operation.

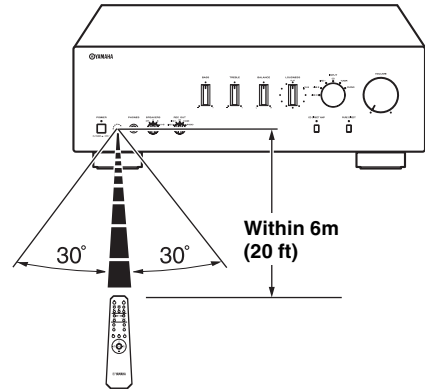

■ Handling the remote control

- The area between the remote control and this unit must be clear of large obstacles.
- Do not spill water or other liquids on the remote control.
- Do not drop the remote control.
- Do not leave or store the remote control in the following types of conditions:
 - high humidity, such as near a bath
 - high temperature, such as near a heater or a stove
 - extremely low temperatures
 - dusty places
- Do not expose the remote control sensor to strong lighting, in particular, an inverter type fluorescent lamp; otherwise, the remote control may not work properly. If necessary, position the unit away from direct lighting.

Rear panel

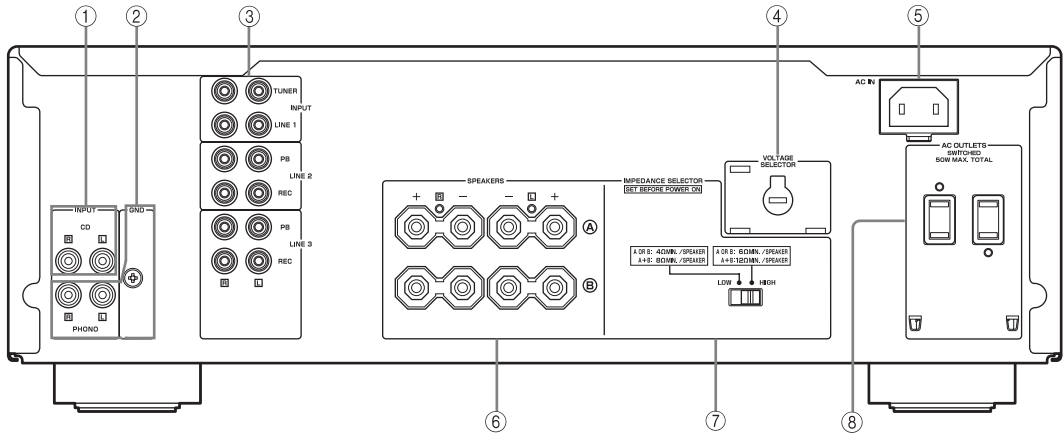

(Asia and General models)

① **CD input jacks**

Connect a CD player.
See page 6 for connection information.

② **PHONO jacks and GND terminal**

The PHONO jacks are designed to connect a turntable with an MM cartridge.
See page 6 for connection information.

③ **Audio input/output jacks**

Connect external components, such as a tuner, etc.
See page 6 for connection information.

④ **VOLTAGE SELECTOR**

(Asia and General models only)

The VOLTAGE SELECTOR must be set to your local main voltage before plugging the supplied power cable into the wall outlet.
See page 8 for details.

⑤ **AC IN**

Use to plug in the supplied power cable.
See page 8 for connection information.

⑥ **SPEAKERS terminals**

Connect one or two speaker sets.
See page 6 for connection information.

⑦ **IMPEDANCE SELECTOR switch**

See IMPEDANCE SELECTOR switch on this page.

⑧ **AC OUTLET(S)**

Use to supply power to your other audio/video components.
See page 8 for details.

■ IMPEDANCE SELECTOR switch

CAUTION

Do not change the IMPEDANCE SELECTOR switch while the power of this unit is turned on, as doing so may damage the unit.

If the unit fails to turn on, the IMPEDANCE SELECTOR switch may not be fully slid to either position. If this is the case, slide the switch all the way to either position when this unit's power supply is completely cut off. Select the switch position (LOW or HIGH) according to the impedance of the speakers in your system.

Switch position	Impedance level
HIGH	<ul style="list-style-type: none"> If you use one set (A or B), the impedance of the speaker must be 6 Ω or higher. If you use two sets (A and B) simultaneously, the impedance of each speaker must be 12 Ω or higher. (Except for U.S.A and Canada models) If you make bi-wire connections, the impedance of the speaker must be 6 Ω or higher. See page 7 for details.
LOW	<ul style="list-style-type: none"> If you use one set (A or B), the impedance of the speaker must be 4 Ω or higher. If you use two sets (A and B) simultaneously, the impedance of each speaker must be 8 Ω or higher. If you make bi-wire connections, the impedance of the speaker must be 4 Ω or higher. See page 7 for details.

CONNECTIONS

Connecting speakers and other components

CAUTION

- Do not connect this unit or other components to the main power until all connections between components are complete.
- All connections must be correct: L (left) to L, R (right) to R, “+” to “+” and “-” to “-”. If the connections are faulty, no sound will be heard from the speakers, and if the polarity of the speaker connections is incorrect, the sound will be unnatural and lack bass. Also, refer to the owner’s manual for each of your components.
- Use RCA stereo cable for audio units except speakers.

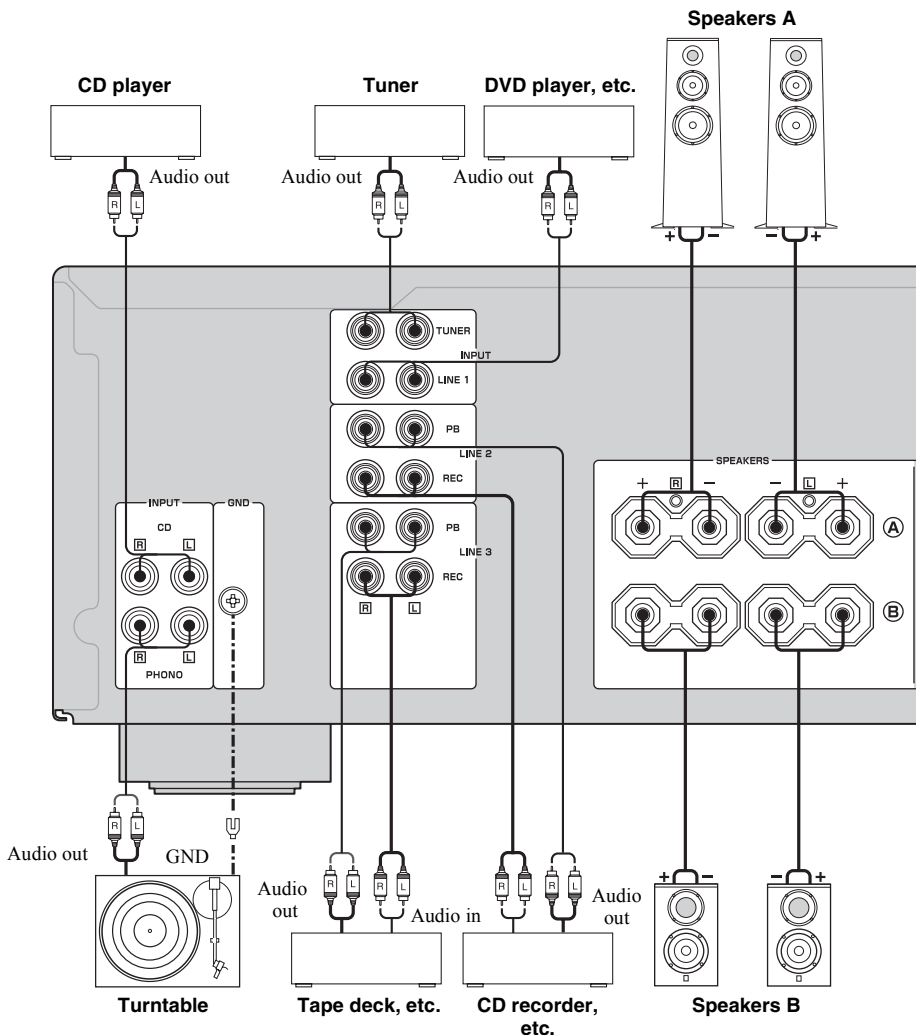

- The PHONO jacks are designed to connect a turntable with an MM cartridge.
- Connect your turntable to the GND terminal to reduce noise in the signal. However, you may hear less noise without the connection to the GND terminal for some turntable(s).

CAUTION

- The IMPEDANCE SELECTOR must be set to the appropriate position before connecting one or two speaker sets. See page 5 for details.
- Do not let the bare speaker wires touch each other or do not let them touch any metal part of this unit. This could damage this unit and/or the speakers.
- Do not connect this unit or other components to the main power until all connections between components are complete.

1 Remove approximately 10 mm (3/8 in) of insulation from the end of each speaker cable and twist the exposed wires of the cable together to prevent short circuits.

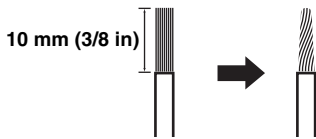

2 Connect the speaker cable.

- ① Unscrew the knob.
- ② Insert one bare wire into the hole in the side of each terminal.
- ③ Tighten the knob to secure the wire.

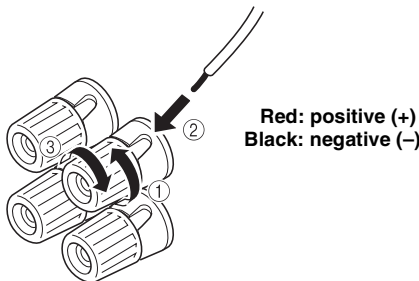

■ Connecting via banana plug (Except for Asia, Korea, U.K. and Europe models)

First, tighten the knob and then insert the banana plug into the end of the corresponding terminal.

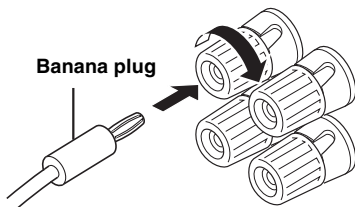

Note

One or two speaker sets can be connected to this unit.

■ Bi-wire connection

The bi-wire connection separates the woofer from the combined midrange and tweeter section. A bi-wire compatible speaker has four binding post terminals. These two sets of terminals allow the speaker to be split into two independent sections. With these connections, the mid and high frequency drivers are connected to one set of terminals and the low frequency driver to another set of terminals.

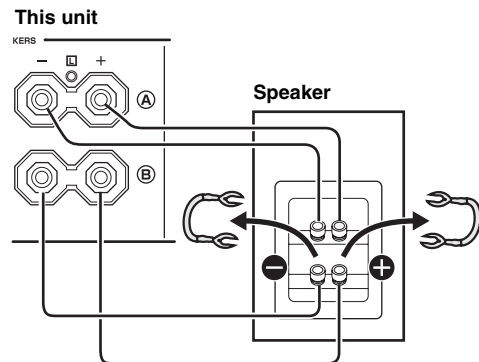

Connect the other speaker to the other set of terminals in the same way.

CAUTION

When making bi-wire connections, set the IMPEDANCE SELECTOR switch to HIGH or LOW depending on the impedance of your speakers:
 6 Ω or higher: HIGH
 4 Ω or higher: LOW
 See page 5 for IMPEDANCE SELECTOR switch.

Note

When making bi-wire connections, remove the shorting bridges or cables on the speaker.



To use the bi-wire connections, switch the SPEAKERS selector to the A+B position.

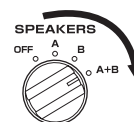

Connecting the supplied power cable

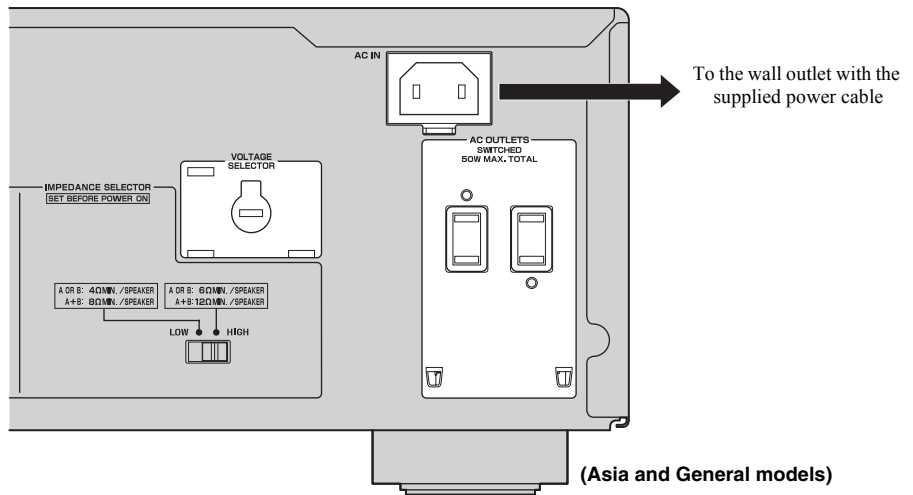

■ VOLTAGE SELECTOR (Asia and General models only)

The VOLTAGE SELECTOR on the rear panel of this unit must be set for your local main voltage BEFORE plugging the supplied power cable into the wall outlet.

Improper setting of the VOLTAGE SELECTOR may cause damage to this unit and create a potential fire hazard.

Rotate the VOLTAGE SELECTOR clockwise or counterclockwise to the correct position using a straight slot screwdriver.

Voltages are as follows:

Asia model AC 220/230–240 V, 50/60 Hz

General model AC 110/120/220/230–240 V, 50/60 Hz

■ AC OUTLET(S) (SWITCHED)

U.K. and Australia models 1 outlet

Korea model None

Other models 2 outlets

Use these outlets to connect the power cables from your other components to this unit. The power to the AC OUTLET(S) is controlled by POWER on the front panel of this unit (or on the remote control). The outlet(s) supply power to any connected component whenever the power of this unit is turned on. For information on the maximum power (total power consumption of components), see “SPECIFICATIONS” on page 15.

Note

Do not connect components with a built-in amplifier, such as a subwoofer, etc.

■ Connecting the supplied power cable

Plug the supplied power cable into the AC IN on the rear panel of this unit and then, plug the power cable into the wall outlet after all other connections are complete.

PLAYING AND RECORDING

Playing a source

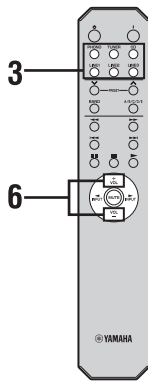
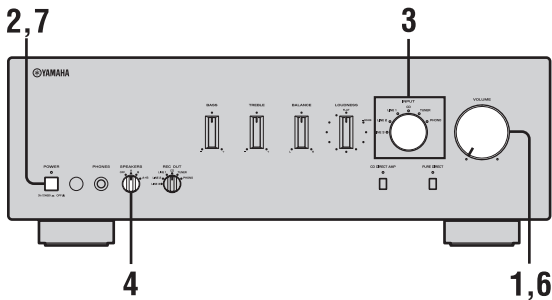

- 1 Rotate **VOLUME** on the front panel to the extreme counterclockwise position.

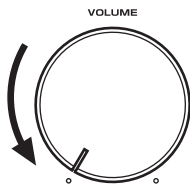

- 2 Press **POWER** on the front panel inward to the **ON** position.



- 3 Rotate the **INPUT** selector on the front panel (or press one of the input selector buttons on the remote control) to select the input source you want to listen to.

The indicator of the selected input source lights up.

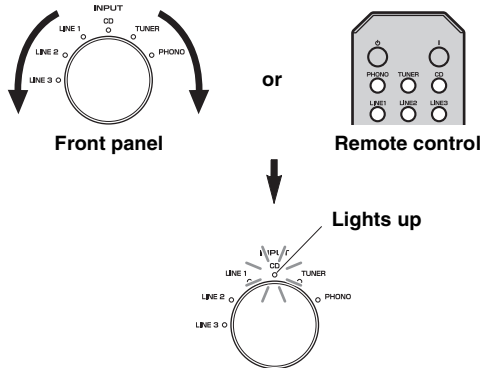

- 4 Rotate the **SPEAKERS** selector on the front panel to select **SPEAKERS A, B** or **A+B**.

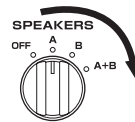

Notes

- Switch the **SPEAKERS** selector to the **A+B** position when making bi-wire connections, or when using two sets of speakers simultaneously (**A** and **B**).
- If you listen with headphones, rotate the selector to the **OFF** position.

- 5 Play the source.

- 6 Rotate VOLUME on the front panel (or press VOL +/- on the remote control) to adjust the sound output level.**

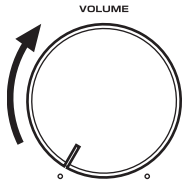

Front panel

or

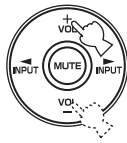

Remote control



You can adjust the tonal quality by using the BASS, TREBLE, BALANCE and LOUDNESS controls, the CD DIRECT AMP switch, or the PURE DIRECT switch on the front panel.

- 7 After using, press POWER on the front panel to turn off the power.**



You can turn on the power by pressing the **|** button on the remote control if you set this unit to standby mode by pressing the **⏻** button on the remote control.

Adjusting the tonal quality

Using the CD DIRECT AMP switch

Routes input signals directly to the power amplifier from your CD player, regardless of the INPUT selector setting. As a result, the input signals bypass the INPUT selector and the BASS, TREBLE, BALANCE and LOUDNESS controls. The gain is also adjusted appropriately for CD so that the purest possible sound is reproduced without any alterations to the CD signals.

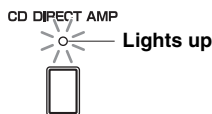

Notes

- The BASS, TREBLE, BALANCE, LOUDNESS controls and INPUT selector do not function while the CD DIRECT AMP switch is turned on.
- Be sure to connect the CD player to the CD input jacks if you use the CD DIRECT AMP switch.

Using the PURE DIRECT switch

Routes input signals from your audio sources. As a result, the input signals bypass the BASS, TREBLE, BALANCE and LOUDNESS controls, thus eliminating any alterations to the audio signals to produce more direct and high-grade sound from all input sources.

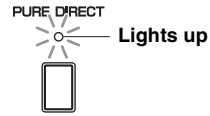

Note

The BASS, TREBLE, BALANCE and LOUDNESS controls do not function while the PURE DIRECT switch is turned on.

Adjusting the BASS and TREBLE controls

Adjust the high and low frequency response. The center position produces a flat response.

BASS

When you feel a lack of bass sound, rotate clockwise to boost. When you feel excessive bass sound, rotate counterclockwise to suppress.

Control range: -10 dB to +10 dB (20 Hz)

TREBLE

When you feel a lack of treble sound, rotate clockwise to boost. When you feel excessive treble sound, rotate counterclockwise to suppress.

Control range: -10 dB to +10 dB (20 kHz)



Adjusting the BALANCE control

Adjust the sound output balance of the left and right speakers to compensate for sound imbalance caused by speaker locations or listening room conditions.

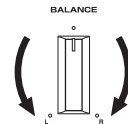

■ Adjusting the LOUDNESS control

Retain a full tonal range at any volume level, thus compensating for the human ears' loss of sensitivity to high and low-frequency ranges at low volume.

CAUTION

If the CD DIRECT AMP switch (or the PURE DIRECT switch) is turned on with the LOUDNESS control set at a certain level, the input signals bypass the loudness control, resulting in a sudden increase in the sound output level. To prevent your ears or the speakers from being damaged, be sure to press the CD DIRECT AMP switch (or the PURE DIRECT switch) AFTER lowering the sound output level or AFTER checking that the LOUDNESS control is properly set.

1 Set the LOUDNESS control to the FLAT position.

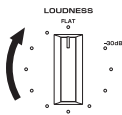

2 Rotate VOLUME on the front panel (or press VOL +/- on the remote control) to set the sound output level to the loudest listening level that you would listen to.

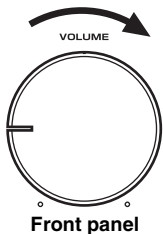

Front panel

or

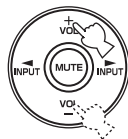

Remote control

3 Rotate the LOUDNESS control until the desired volume is obtained.

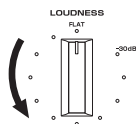

After setting the LOUDNESS control, enjoy listening to music at your preferred volume level by controlling VOLUME. If the effect of the loudness control is too strong or weak, readjust the LOUDNESS control.

Recording a source

Notes

- The audio signals are not output via the LINE 2 REC or LINE 3 REC output jacks when LINE 2 or LINE 3 is selected with the REC OUT selector.
- The audio signals are output at both LINE 2 REC and LINE 3 REC output jacks if you select PHONO, TUNER, CD or LINE 1.
- The VOLUME, BASS, TREBLE, BALANCE and LOUDNESS controls and the CD DIRECT AMP switch (and the PURE DIRECT switch) have no effect on the source being recorded.
- Check the copyright laws in your country to record from records, CDs, radio, etc. Recording copyright-protected material may infringe on copyright laws.

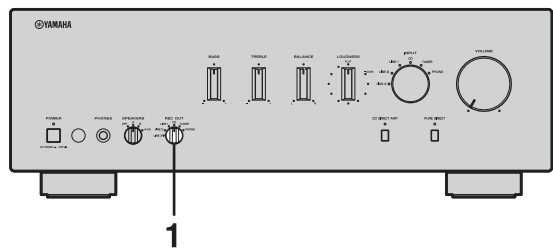

1 Rotate the REC OUT selector on the front panel to select the source you want to record.

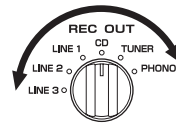

2 Play the source and begin recording on recording device connected to the REC output jacks (LINE 2 and/or LINE 3) on the rear panel. See page 6.



- If you select the same source with the INPUT selector as you select with the REC OUT selector, you can monitor the recording.
- To listen to another input source without affecting the current record out signal, select the source with the INPUT selector.

TROUBLESHOOTING

Refer to the chart below if this unit does not function properly. If the problem you are experiencing is not listed below or if the instructions below do not help, set this unit to the standby mode, disconnect the power cable, and contact the nearest authorized Yamaha dealer or service center.

■ General

Problems	Possible Causes	Solutions	Refer to page
Pressing the POWER switch on the front panel does not turn on this unit. The POWER on indicator also does not light up.	The supplied power cable is not connected or the cable is not completely inserted.	Connect the supplied power cable firmly.	8
	The POWER (I) button is pressed on the remote control while this unit is turned off.	Press POWER on the front panel to ON.	3
	There is a problem with the internal circuitries of this unit.	Disconnect the AC power cable and contact the nearest authorized Yamaha dealer or service center. If an unusual odor or noise is generated from the unit, do not turn on the power, disconnect the AC power cable, and contact a service center for repair.	—
The power of this unit is turned off suddenly and the POWER on indicator blinks. This unit is turned off after several seconds of turning on, and the POWER on indicator blinks.	The speaker wires are touching each other or shorting out against the rear panel.	Connect the speaker cables properly and press the power button ON again. The VOLUME is decreased automatically and this unit is turned on after the INPUT indicator blinks for about 15 seconds. Confirm normal sound output from speakers by increasing the volume gradually, then you can operate this unit normally.	7
	The speaker is a malfunction.	Replace the speaker set and press the power button ON again. The VOLUME is decreased automatically and this unit is turned on after the INPUT indicator blinks for about 15 seconds. Confirm normal sound output from speakers by increasing the volume gradually, then you can operate this unit normally.	—
	The protection circuitry has been activated because of excessive input or excessive volume level.	Rotate the VOLUME control on the front panel to decrease the volume level and then turn the power on again.	—
	The protection circuitry has been activated due to excessive internal temperature.	Allow about 30 minutes for the temperature inside this unit to decrease, rotate the VOLUME control on the front panel to lower the volume and then turn the power on again. Set the unit in a place where heat can readily dissipate from the unit.	—
	The IMPEDANCE SELECTOR switch may not be fully slid to either position.	Turn the power off and slide the IMPEDANCE SELECTOR switch all the way to either position.	5
	The impedance setting is incorrect.	Set the impedance to match your speakers.	5
	This unit has been exposed to a strong external electric shock (such as lightning or strong static electricity).	Set this unit to the standby mode, disconnect the power cable, plug it back in after 30 seconds, then use it normally.	—
	There is a problem with the internal circuitries of this unit.	Disconnect the AC power cable and contact the nearest authorized Yamaha dealer or service center. If an unusual odor or noise is generated from the unit, do not turn on the power, disconnect the AC power cable, and contact a service center for repair.	—

Problems	Possible Causes	Solutions	Refer to page
No sound	Sound is muted.	Press MUTE on the remote control to resume the audio output.	3
	Incorrect cable connections.	Connect the stereo cable for audio units and the speaker wires properly. If the problem persists, the cables may be defective.	6
	No appropriate input source has been selected.	Select an appropriate input source with the INPUT selector on the front panel (or one of the input selector buttons on the remote control).	9
	The SPEAKERS selector is not set properly.	Set the corresponding SPEAKERS selector to A, B or A+B position.	9
The sound suddenly goes off.	The protection circuitry has been activated because of a short circuit, etc.	Check that the IMPEDANCE SELECTOR setting is correct.	5
		Check that the speaker wires are not touching each other or shorting out against the rear panel of this unit, and then turn the power of this unit back on.	6
Only the speaker on one side can be heard.	Incorrect cable connections.	Connect the cables properly. If the problem persists, the cables may be defective.	6
	Incorrect setting for the BALANCE control.	Set the BALANCE control to the appropriate position.	10
There is a lack of bass and no ambience.	The + and – wires are connected in reverse at the amplifier or the speakers.	Connect the speaker wires to the correct + and – phase.	6
A “humming” sound can be heard.	Incorrect cable connections.	Connect the audio plugs firmly. If the problem persists, the cables may be defective.	6
	No connection from the turntable to the GND terminal.	Make the GND connection between the turntable and this unit.	6
The volume level is low while playing a record.	The turntable is connected to the jacks other than the PHONO jacks.	Connect the turntable to the PHONO jacks.	6
	The record is being played on a turntable with an MC cartridge.	Use a turntable equipped with an MM cartridge.	—
The volume level cannot be increased, or the sound is distorted.	The component connected to LINE 2 REC or LINE 3 REC terminals of this unit is turned off.	Turn on the power of the component.	—
The sound is degraded when listening with the headphones connected to the CD player or the tape deck connected to this unit.	The power of this unit is turned off, or this unit is set to the standby mode.	Turn on the power of this unit.	9
The sound level is low.	The LOUDNESS control is functioning.	Set the LOUDNESS control to the FLAT position.	11
The input source cannot be changed although the INPUT selector is rotated.	The CD DIRECT AMP switch is turned on.	Turn off the CD DIRECT AMP switch.	10
Using the BASS, TREBLE, BALANCE and LOUDNESS controls does not affect the tonal quality.	The CD DIRECT AMP switch or the PURE DIRECT switch is turned on.	The CD DIRECT AMP switch or the PURE DIRECT switch must be turned off to use those controls.	10

■ Remote control

Problems	Possible Causes	Solutions	Refer to page
The remote control does not work nor function properly.	The remote control is too far away or tilted too much.	The remote control will function within a maximum range of 6 m (20 ft) and no more than 30 degrees off-axis from the front panel.	4
	Direct sunlight or lighting (from an inverter type of fluorescent lamp, etc.) is striking the remote control sensor of this unit.	Reposition this unit or lightning.	—
	The batteries are weak.	Replace all batteries.	4

SPECIFICATIONS

POWER SECTION

- Minimum RMS output power
(8 Ω, 20 Hz to 20 kHz, 0.019% THD)..... 90 W + 90 W
(6 Ω, 20 Hz to 20 kHz, 0.03% THD)..... 105 W + 105 W
- Dynamic Power (IHF)
(8/6/4/2 Ω) 135/160/200/240 W
- Maximum Output Power
[Europe model only]
(1 kHz, 0.7% THD, 4 Ω) 160 W
[Asia and General models only] (JEITA)
(1 kHz, 10% THD, 8/6 Ω) 140/160 W
- IEC Output Power [Europe model only]
(1 kHz, 0.019% THD, 8 Ω) 105 W
- Power Band Width
(0.03% THD, 50 W, 8 Ω) 10 Hz to 50 kHz
- Damping Factor
1 kHz, 8 Ω 240 or more
- Maximum Input Signal
PHONO (1 kHz, 0.019% THD) 70 mV or more
CD, etc. (1 kHz, 0.019% THD) 2.2 V or more
- Frequency Response
CD, etc. (20 Hz to 20 kHz) 0 ± 0.5 dB
CD DIRECT AMP ON (10 Hz to 100 kHz) 0 ± 1.0 dB
- RIAA Equalization Deviation
PHONO ± 0.5 dB
- Total Harmonic Distortion
PHONO to OUT (REC)
(20 Hz to 20 kHz, 3 V) 0.008% or less
CD, etc. to SP OUT
(20 Hz to 20 kHz, 50 W, 8 Ω) 0.012% or less
- Signal to Noise Ratio (IHF-A Network)
PHONO (5 mV input shorted) 87 dB or more
CD DIRECT AMP (200 mV input shorted) 110 dB or more
- Residual Noise (IHF-A Network)
CD DIRECT AMP ON 30 μV
PURE DIRECT ON 110 μV
- Gain Tracking Error (0 to -60 dB) 2 dB or less

CONTROL SECTION

- Input Sensitivity/Input Impedance
PHONO 3.0 mV/47 kΩ
CD, etc. 200 mV/47 kΩ
- Output Level/Output Impedance
REC level 200 mV/1.2 kΩ or less
- Headphone Output/Impedance
(Input 1 kHz, 200 mV, 8 Ω, 0.015% THD)
CD, etc. 0.47 V/470 Ω
- Channel Separation
CD, etc. (5.1 kΩ input shorted, 1/10 kHz) 65/50 dB or more
- Tone Control Characteristics
BASS
Boost/Cut (20 Hz) ±10 dB
Turnover Frequency 350 Hz
TREBLE
Boost/Cut (20 kHz) ±10 dB
Turnover Frequency 3.5 kHz
- Continuous Loudness Control
Attenuation (1 kHz) -30 dB

GENERAL

- Power Supply
[U.S.A. and Canada models] AC 120 V, 60 Hz
[Asia model] AC 220/230-240 V, 50/60 Hz
[General model] AC 110/120/220/230-240 V, 50/60 Hz
[China model] AC 220 V, 50 Hz
[Korea model] AC 220 V, 60 Hz
[Australia model] AC 240 V, 50 Hz
[U.K. and Europe models] AC 230 V, 50 Hz
- Power Consumption
[U.S.A. and Canada models] 260 W, 360 VA
[Other models] 260 W
- Standby Power Consumption 0.1 W
- Maximum Power Consumption [General model only]
(6 Ω, 1 kHz, 10% THD)..... 650 W
- AC Outlets
[U.K. and Australia models] 1 (Total 100 W maximum)
[Korea model] None
[General model] 2 (Total 50 W maximum)
[Other models] 2 (Total 100 W maximum)
- Dimensions (W × H × D) 435 × 151 × 382 mm
(17-1/8 in × 5-15/16 in × 15-1/16 in)
- Weight 10.9 kg (24 lbs.)

Specifications are subject to change without notice.

Limited Guarantee for European Economic Area (EEA) and Switzerland

Thank you for having chosen a Yamaha product. In the unlikely event that your Yamaha product needs guarantee service, please contact the dealer from whom it was purchased. If you experience any difficulty, please contact Yamaha representative office in your country. You can find full details on our website (<http://www.yamaha-hifi.com/> or <http://www.yamaha-uk.com/> for U.K. resident).

The product is guaranteed to be free from defects in workmanship or materials for a period of two years from the date of the original purchase. Yamaha undertakes, subject to the conditions listed below, to have the faulty product or any part(s) repaired, or replaced at Yamaha's discretion, without any charge for parts or labour. Yamaha reserves the right to replace a product with that of a similar kind and/or value and condition, where a model has been discontinued or is considered uneconomic to repair.

Conditions

1. The original invoice or sales receipt (showing date of purchase, product code and dealer's name) MUST accompany the defective product, along with a statement detailing the fault. In the absence of this clear proof of purchase, Yamaha reserves the right to refuse to provide free of charge service and the product may be returned at the customer's expense.
2. The product MUST have been purchased from an AUTHORISED Yamaha dealer within the European Economic Area (EEA) or Switzerland.
3. The product must not have been the subject of any modifications or alterations, unless authorised in writing by Yamaha.
4. The following are excluded from this guarantee:
 - a. Periodic maintenance and repair or replacement of parts due to normal wear and tear.
 - b. Damage resulting from:
 - (1) Repairs performed by the customer himself or by an unauthorised third party.
 - (2) Inadequate packaging or mishandling, when the product is in transit from the customer. Please note that it is the customer's responsibility to ensure the product is adequately packaged when returning the product for repair.
 - (3) Misuse, including but not limited to (a) failure to use the product for its normal purpose or in accordance with Yamaha's instructions on the proper use, maintenance and storage, and (b) installation or use of the product in a manner inconsistent with the technical or safety standards in force in the country where it is used.
 - (4) Accidents, lightning, water, fire, improper ventilation, battery leakage or any cause beyond Yamaha's control.
 - (5) Defects of the system into which this product is incorporated and/or incompatibility with third party products.
 - (6) Use of a product imported into the EEA and/or Switzerland, not by Yamaha, where that product does not conform to the technical or safety standards of the country of use and/or to the standard specification of a product sold by Yamaha in the EEA and/or Switzerland.
 - (7) Non AV (Audio Visual) related products.
(Products subject to "Yamaha AV Guarantee Statement" are defined in our website at <http://www.yamaha-hifi.com/> or <http://www.yamaha-uk.com/> for U.K. resident.)
5. Where the guarantee differs between the country of purchase and the country of use of the product, the guarantee of the country of use shall apply.
6. Yamaha may not be held responsible for any losses or damages, whether direct, consequential or otherwise, save for the repair or replacement of the product.
7. Please backup any custom settings or data, as Yamaha may not be held responsible for any alteration or loss to such settings or data.
8. This guarantee does not affect the consumer's statutory rights under applicable national laws in force or the consumer's rights against the dealer arising from their sales/purchase contract.

■ For U.K. customers

Information for Users on Collection and Disposal of Old Equipment and Used Batteries



These symbols on the products, packaging, and/or accompanying documents mean that used electrical and electronic products and batteries should not be mixed with general household waste.

For proper treatment, recovery and recycling of old products and used batteries, please take them to applicable collection points, in accordance with your national legislation and the Directives 2002/96/EC and 2006/66/EC.



By disposing of these products and batteries correctly, you will help to save valuable resources and prevent any potential negative effects on human health and the environment which could otherwise arise from inappropriate waste handling.



For more information about collection and recycling of old products and batteries, please contact your local municipality, your waste disposal service or the point of sale where you purchased the items.

[Information on Disposal in other Countries outside the European Union]

These symbols are only valid in the European Union. If you wish to discard these items, please contact your local authorities or dealer and ask for the correct method of disposal.



Note for the battery symbol (bottom two symbol examples):

This symbol might be used in combination with a chemical symbol. In this case it complies with the requirement set by the Directive for the chemical involved.

Pb

Garantie Limitée pour l'Espace Économique Européenne et la Suisse

Merci d'avoir porté votre choix sur un produit Yamaha. Dans l'hypothèse où vous devriez recourir au service de notre garantie après-vente, veuillez contacter votre revendeur Yamaha. Si vous rencontrez la moindre difficulté, n'hésitez pas à contacter directement Yamaha dans votre pays de résidence. Vous pouvez trouver toutes informations complémentaires sur notre site Web (<http://www.yamaha-hifi.com/> ou <http://www.yamaha-uk.com/> pour les résidents au Royaume-Uni).

Yamaha garantit votre produit contre tout défaut de fabrication, pièces et main d'oeuvre, pour une durée de 2 ans à compter de la première date de vente au détail. Yamaha s'engage, dans les conditions décrites ci-après, à procéder à la réparation du produit défectueux (ou d'un quelconque de ses composants) ou à son remplacement à l'appréciation de Yamaha en prenant à sa charge les coûts relatifs aux pièces détachées et à la main d'oeuvre. Yamaha se réserve le droit de remplacer le produit par un modèle semblable, de par sa valeur et ses caractéristiques, dès lors que la commercialisation dudit produit a cessé ou bien lorsque sa réparation s'avère économiquement injustifiée.

Conditions

1. La facture d'achat originelle ou un justificatif d'achat correspondant (indiquant la date d'achat, la référence du produit et le nom du revendeur) DOIT accompagner le produit défectueux, ainsi qu'une description précise du dysfonctionnement constaté. En l'absence de cette preuve d'achat, Yamaha se réserve le droit de refuser le service de la garantie et le produit peut être restitué aux frais du consommateur.
2. Le produit DOIT avoir été acheté par un distributeur agréé Yamaha au sein de l'Espace Economique Européen ou en Suisse.
3. Le produit doit n'avoir fait l'objet d'aucune modification ou altération, sauf accord écrit de Yamaha.
4. Les cas suivants font obstacle à l'application de la garantie :
 - a. Entretien périodique et réparation ou remplacement de pièces ayant subi une usure ou défaillance normale.
 - b. Dommages résultant de :
 - (1) Réparation effectuée par le consommateur lui-même ou par un tiers non autorisé.
 - (2) Emballage ou manutention inadéquats lors du transport du produit pour réparation. Veuillez noter qu'il est de la responsabilité de l'expéditeur de s'assurer que le produit est correctement emballé.
 - (3) Utilisation non-conforme du produit, correspondant aux cas non limitatifs (a) d'utilisation non-conforme à l'objet normal du produit ou non conforme aux instructions d'utilisation, de maintenance ou d'installation publiées par Yamaha, (b) ou d'utilisation du produit incompatible avec les normes techniques ou de sécurité en vigueur au sein du pays d'utilisation.
 - (4) Accidents, foudre, dégât des eaux, incendie, ventilation incorrecte, fuite de pile ou toute autre cause échappant au contrôle de Yamaha.
 - (5) Les défauts de la configuration dans laquelle ce produit est incorporé et/ou l'incompatibilité avec des produits tiers.
 - (6) Produit importé au sein de l'EEE, et/ou en Suisse, par une autre entité que Yamaha, dès lors que ce produit n'est pas conforme aux normes techniques ou de sécurité du pays d'utilisation et/ou aux normes des produits commercialisés par Yamaha au sein de l'EEE et/ou en Suisse.
 - (7) Produits non audiovisuels.
(Les produits soumis à une « Déclaration de Garantie AV de Yamaha » sont indiqués sur notre site Web à l'adresse <http://www.yamaha-hifi.com/> ou <http://www.yamaha-uk.com/> pour les résidents au Royaume-Uni.)
5. Lorsque la garantie diffère entre le pays d'achat et le pays d'utilisation du produit, la garantie du pays d'utilisation est applicable.
6. Yamaha ne saurait être tenu pour responsable de quelconques pertes ou dommages, directs, consécutifs ou autres, sa responsabilité au titre de la garantie étant strictement limitée à la réparation ou au remplacement du produit.
7. Nous vous invitons à sauvegarder toutes les données ou réglages personnalisés de votre produit, Yamaha ne pouvant être tenu responsable de leur modification ou perte.
8. La présente garantie laisse intégralement subsister les droits que le consommateur peut détenir au titre de la garantie légale en vigueur ou au titre du contrat de vente conclu avec son revendeur.

■ Pour la clientèle au Royaume-Uni

Information concernant la Collecte et le Traitement des piles usagées et des déchets d'équipements électriques et électroniques



Les symboles sur les produits, l'emballage et/ou les documents joints signifient que les produits électriques ou électroniques usagés ainsi que les piles ne doivent pas être mélangés avec les déchets domestiques habituels.

Pour un traitement, une récupération et un recyclage appropriés des déchets d'équipements électriques et électroniques et des piles usagées, veuillez les déposer aux points de collecte prévus à cet effet, conformément à la réglementation nationale et aux Directives 2002/96/EC et 2006/66/EC.



En vous débarrassant correctement des déchets d'équipements électriques et électroniques et des piles usagées, vous contribuerez à la sauvegarde de précieuses ressources et à la prévention de potentiels effets négatifs sur la santé humaine qui pourraient advenir lors d'un traitement inapproprié des déchets.



Pour plus d'informations à propos de la collecte et du recyclage des déchets d'équipements électriques et électroniques et des piles usagées, veuillez contacter votre municipalité, votre service de traitement des déchets ou le point de vente où vous avez acheté les produits.



[Information sur le traitement dans d'autres pays en dehors de l'Union Européenne]

Ces symboles sont seulement valables dans l'Union Européenne. Si vous souhaitez vous débarrasser de déchets d'équipements électriques et électroniques ou de piles usagées, veuillez contacter les autorités locales ou votre fournisseur et demander la méthode de traitement appropriée.

Pb

Note pour le symbole « pile » (deux exemples de symbole ci-dessous) :

Ce symbole peut être utilisé en combinaison avec un symbole chimique. Dans ce cas il respecte les exigences établies par la Directive pour le produit chimique en question.



YAMAHA CORPORATION
Printed in Malaysia Y WQ01790