

# Trace™ TM500A Battery Status Monitor



## Installation & Operator's Guide

## About Xantrex

Xantrex Technology Inc., is a world-leading supplier of advanced power electronics and controls with products from 50 watt portables to 1 megawatt utility-scale systems for wind, solar, batteries, fuel cells, microturbines, and backup power applications in both grid-connected and stand-alone systems. Xantrex products include inverters, battery chargers, programmable power supplies, and variable speed drives that convert, supply, control, clean, and distribute electrical power.

## Trademarks

Trace is a trademark of Xantrex Technology Inc. Xantrex is a registered trademark of Xantrex Technology Inc.

## Notice of Copyright

Xantrex TM500A Battery Status Monitor © May 2001 Xantrex Technology. All rights reserved.

## Disclaimers

While every precaution has been taken to ensure the accuracy of the contents of this guide, Xantrex Technology Inc., assumes no responsibility for errors or omissions. Note as well that specifications and product functionality may change without notice.

Since the use of this manual and the conditions or methods of installation, operation, use and maintenance of the unit are beyond the control of Xantrex Technology Inc., the company does not assume responsibility and expressly disclaims liability for loss, damage, or expense arising out of or any way connected with such installation, operation, use, or maintenance.

Due to continual improvement through product updates, photographs and/or illustrations used in this manual may not *exactly* match your unit. Xantrex Technology Inc., reserves the right to update this product without notice or releasing an updated manual when *fit, form or function* are not affected.

## Date and Revision

May 2001, Revision A





## Part Number

**973-0012-01-02**

## Contact Information

Web: [www.xantrex.com](http://www.xantrex.com)  
Email: [tracewarranty@traceengineering.com](mailto:tracewarranty@traceengineering.com)  
Phone: 360/435.8826  
Fax: 360/474.0616

# Table of Contents

<b>1.0 INTRODUCTION .....</b>	<b>1</b>
The TM500A .....	1
Unpacking and Inspection .....	2
TM500A (12/24 Volt) .....	2
TM500A - NS (12/24 Volt) .....	2
TM48 (48 Volt) .....	2
<b>2.0 INSTALLATION .....</b>	<b>3</b>
Required Tools .....	3
Pre-Installation .....	3
Mounting .....	3
Surface Mounting .....	4
Flush Mounting .....	6
Extended Length Installations .....	8
Deltec™ Shunt .....	9
Mounting/Wiring the Shunt .....	9
Mounting Circuit Board to an Existing Shunt .....	10
Connecting the Shunt Board .....	11
<b>3.0 CONFIGURATION .....</b>	<b>12</b>
Setup .....	12
Restoring the Factory Defaults .....	12
Setting Parameters .....	13
Charge Efficiency  .....	14
Setting the Charge Efficiency Factor .....	14
Amp Hours  .....	15
Setting the Amp Hours .....	15
CHARGED Indicator Setup  .....	17
Trigger on Voltage Only .....	17
Trigger on Voltage and Amperage .....	19
Trigger on Voltage and Time .....	21
Charger Considerations .....	23
Relay Chargers .....	23
Taper Chargers .....	23
Three-stage Chargers .....	23
Low-Voltage Indicator  .....	24
Configuring the Low-Voltage Alarm .....	24

## Table of Contents (continued)

<b>4.0 OPERATION .....</b>	<b>25</b>
Indicators and Controls .....	25
Buttons .....	25
Select Button .....	25
Reset Button .....	25
INVERTER ON/OFF Button .....	25
Basic Meters .....	26
Available Meters .....	26
% (state-of charge) .....	26
V (Volts) .....	26
A (AMPS) .....	26
Ah (AMP HOURS) .....	27
Power Saving Mode .....	27
Data Monitors .....	28
Reminders and Indicators .....	30
Amp-hour Reminder .....	30
Low-Voltage Indicator .....	31
CHARGED Indicator .....	32
<b>5.0 TROUBLESHOOTING .....</b>	<b>33</b>
<b>6.0 SERVICE INFORMATION .....</b>	<b>34</b>
<b>7.0 SPECIFICATIONS .....</b>	<b>35</b>
<b>8.0 WARRANTY .....</b>	<b>36</b>

## IMPORTANT SAFETY INSTRUCTIONS

This manual contains important safety instructions that should be followed during the installation and maintenance of this product.

To reduce the risk of electrical shock, and to ensure the safe installation and operation of this product, the following safety symbols have been placed throughout this manual to indicate dangerous conditions and important safety instructions.



**WARNING** - A dangerous voltage or condition exists in this area. Use extreme caution when performing these tasks.

**AVERTISSEMENT** - Une tension ou condition dangereuse existe dans cette zone. Faire preuve d'extrême prudence lors de la réalisation de ces tâches.



**CAUTION** - This procedure is critical to the safe installation or operation of the unit. Follow these instructions closely.

**ATTENTION** - Cette procédure est essentielle à l'installation ou l'utilisation de l'unité en toute sécurité. Suivre ces instructions de près.



**NOTE** - This statement is important. Follow instructions closely.

**NOTE** - Cette déclaration est importante. Suivre les instructions de près.

- All electrical work must be done in accordance with local, national, and/or international electrical codes.
- Before installing or using this device, read all instructions and cautionary markings located in (or on) the TM500A, the manual, the batteries, the inverter, the PV array, etc.
- Do not expose this unit to rain, snow or liquids of any type. This product is designed only for indoor mounting.
- To reduce the chance of short-circuits when installing or working with the inverter, the batteries, or the PV array, use insulated tools.
- Remove all jewelry such as rings, bracelets, necklaces, etc., while installing this system. This will greatly reduce the chance of accidental exposure to live circuits.
- The inverter contains more than one live circuit (batteries, PV array, and AC). Power may be present at more than one source.
- This product contains no user-serviceable parts. Do not attempt to repair this unit.

## **BATTERY SAFETY INFORMATION**

- Always wear eye protection, such as safety glasses, when working with batteries.
- Remove all loose jewelry before working with batteries.
- Never work alone. Have someone assist you with the installation or be close enough to come to your aid when working with batteries.
- NEVER smoke in the vicinity of a battery or generator.
- Always connect the batteries first, then connect the cables to the inverter via a DC disconnect switched OFF. This will greatly reduce the chance of spark in the vicinity of the batteries.
- Use insulated tools when working with batteries.
- When connecting batteries, always verify proper voltage and polarity.
- Do not short-circuit battery cables. Fire or explosion can occur.
- In the event of exposure to battery electrolyte, wash the area with soap and water. If acid enters the eyes, flood them with running cold water for at least 15 minutes and get immediate medical attention.

**SAVE THESE INSTRUCTIONS**

## The TM500A

The TM500A features six data monitoring functions and three indicators including:

- State of charge/amp-hour content (full or percent of capacity)
- State of charge/voltage (real-time voltage level, historical high and low system voltage)
- Amps (real-time amps, total charging amps, total load amps)
- Amp hours removed
- Days since fully charged
- Cumulative amp hours
- Recharge indicator
- Low-voltage indicator
- Full-charge indicator

The unit is configurable for specific system or application functions such as setting the CHARGED indication parameters, battery capacity, charging efficiency, low-battery warning conditions and a recharge reminder. The TM500A can monitor any battery supply from approximately 8 to 65 volts, track energy consumption and estimate remaining battery life.

In addition to its status monitoring features, the unit can act as a remote control, switching the inverter OFF or ON (only on inverters incorporating an RC4/RC8 compatible remote control jack).

The TM500A operates on 12-, 24-, or 48-volt battery systems (48-volt systems require an optional shunt board).



**Figure 1-1**  
**The TM500A**

# 1.0 INTRODUCTION

## Unpacking and Inspection

Upon receiving the TM500A, check that the following items are included.

### TM500A (12/24 Volt)

- TM500A (meter panel, adaptor and mounting bracket)
- Manual
- 50-foot communications cable
- Deltec™ 500 amp/50 mV shunt
- 12/24 volt shunt-printed circuit board with in-line 2-amp fuse

### TM500A - NS (12/24 Volt)

- TM500A (meter panel, adaptor and mounting bracket)
- Manual
- 50-foot communications cable
- Shunt-printed circuit board with in-line 2-amp fuse

### TM48 (48 Volt)

- 48-volt shunt-printed circuit board with in-line 2-amp fuse



### Required Tools

- Phillips screw driver
- 3/32" and 3/16" drill bits
- Hole saw

If the TM500A will also function as a remote control (INVERTER ON/OFF), an additional cable must be ordered. Available lengths are:

10 feet–TC/10  
50 feet–TC/50

25 feet–TC/25  
100 feet–TC/100

### Pre-Installation

Before installing the TM500A, read all instructions and cautionary markings located in this manual. The unit should be mounted in a clean, dry, protected environment.

Determine the wire route to the batteries (and inverter, if the remote INVERTER ON/OFF function is desired).

---

 **NOTE:** Check for existing electrical, plumbing or other potential areas of accidental damage prior to making cuts in structural surfaces.

---

### Mounting

The unit can be surface mounted (using the adaptor supplied) or flush mounted into a rectangular opening. Provide at least one inch clearance behind the meter circuit board for the cabling when flush mounting.

The TM500A ships in three sections:

- TM500A
- Adaptor for surface mounting
- Mounting Bracket

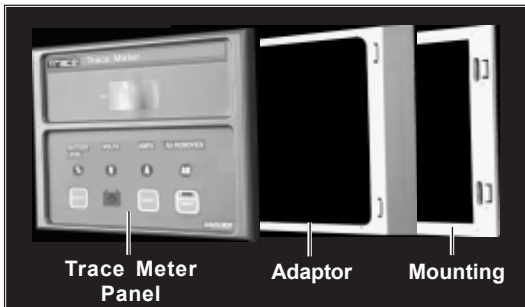

**Figure 2-1**  
**TM500A and Mounting Components**

## 2.0 INSTALLATION

### Surface Mounting

- Using the mounting bracket as a template, mark the positions for the screw holes and an area where the cable(s) will feed through.
- Drill out the four screws holes (if required) and wire access opening. Use a 3/16" bit if the supplied plastic anchors are used. If placing the screws directly into the backing material, use a 3/32" bit. The wire access hole should be at least 1/2" diameter to allow the connector to pass through.
- Mount the bracket using the screws (and anchors if necessary) supplied. See Figure 2-2. Do not overtighten the screws.
- Install the adaptor onto the bracket by pressing it tightly into place.
- Connect the communications cable (from the shunt) to the "J1 TO SHUNT ONLY" jack on the TM500A. See Figure 2-3.
- If the TM500A is to function as an ON/OFF remote control for the inverter, connect the remote control cable (not supplied) to the "J2 INVERTER ONLY" jack. This connector only functions if the inverter contains a REMOTE jack that allows operation with an RC4 or RC8 remote control.



**CAUTION: Do not reverse these cables or the TM500A circuit board will be permanently damaged.**

---

- Install the meter onto the adaptor by pressing it tightly into place.

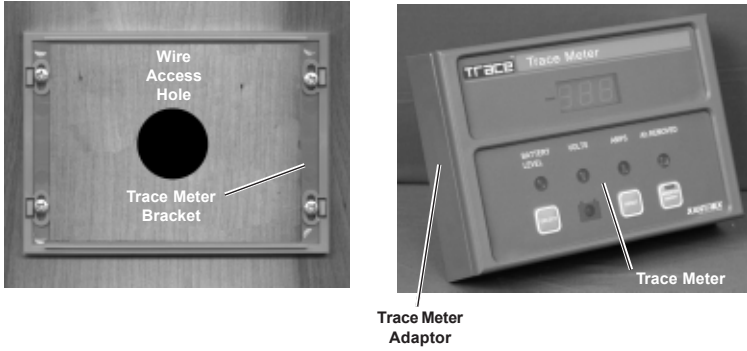

**Figure 2-2**  
**Surface Mounting the TM500A Using the Adaptor**

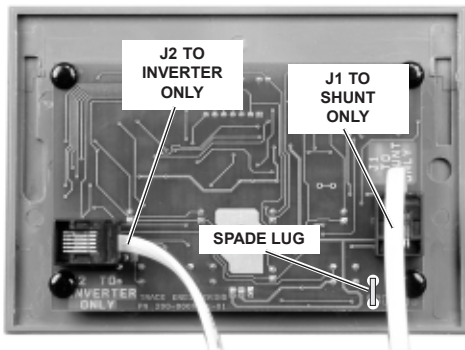

**Figure 2-3**  
**Communication and Remote Cable Connections**

## 2.0 INSTALLATION

### Flush Mounting

To flush mount the TM500A, an opening must be cut in the backing material to allow room for the circuit board, wires and connectors. Allow at least one inch depth behind the circuit board for the connectors and wires.

- Use the bracket as a template and mark the positions for the screw holes. Mark the open area to be cut out for the circuit board.



*NOTE: Carefully cut out the circuit board area from the backing material (i.e., wallboard). Cut inside the lines so there is enough area left to securely hold the screws.*

---

- Drill out the four screw's holes (if required) and wire access opening. Use a 3/16" bit if the supplied plastic anchors are used. If placing the screws directly into the backing material, use a 3/32" bit.
- Mount the bracket using the screws (and anchors if necessary) supplied. See Figure 2-4. Do not overtighten the screws.
- Connect the *communications* cable (from the shunt) to the "J1 TO SHUNT ONLY" jack (Figure 2-5).
- If the TM500A is to function as an ON/OFF remote control for the inverter, connect the remote control cable (not supplied) to the "J2 INVERTER ONLY" jack. This connector only functions if the inverter contains a REMOTE jack that allows operation with an RC4 or RC8 remote control.



**CAUTION: Do not reverse these cables or the TM500A circuit board will be permanently damaged. This is not covered under warranty.**

---

- Install the meter onto the bracket by pressing it tightly into place.

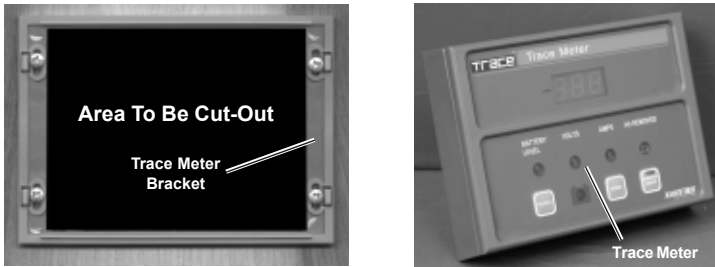

**Figure 2-4**  
**Flush Mounting the TM500A**

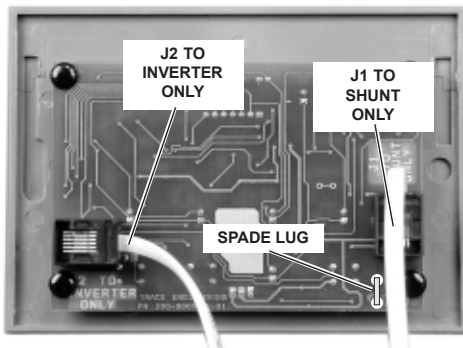

**Figure 2-5**  
**Communication and Remote Cable Connections**

## 2.0 INSTALLATION

### Extended Length Installations

If the TM500A is mounted in excess of 100 feet from the inverter, an additional wire (with a spade lugs on both ends) must be connected between the TM500A and shunt spade lugs. This wire acts as a ground reference and ensures the meter will read accurately.

Use the following gauge wire for the distance the TM500A is mounted from the inverter.

<u>Maximum Distance</u>	<u>Wire Gauge</u>
250 feet	#16 AWG
400 feet	#14 AWG
630 feet	#12 AWG
1000 feet	#10 AWG

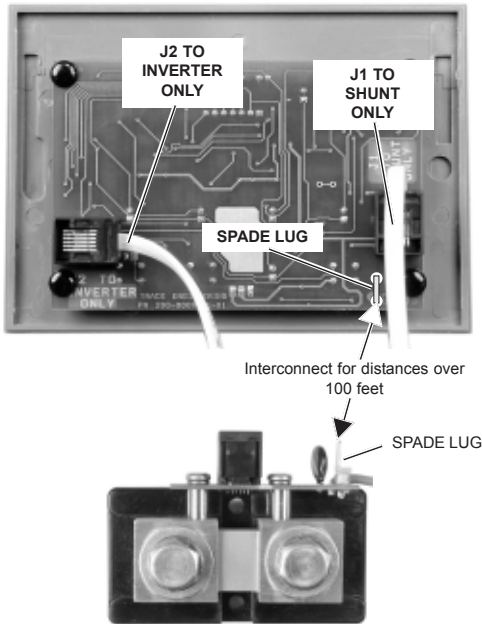

**Figure 2-6**  
**Extended Length Ground Wire**

### Deltec™ Shunt



**WARNING: BEFORE WIRING THE SHUNT TO THE BATTERIES, SWITCH THE DC DISCONNECT TO OFF AND/OR REMOVE THE DC FUSE.**

### Mounting/Wiring the Shunt

The shunt connects between the inverter and batteries in the negative (-) line (Figure 2-10).

- Mount the shunt on or near the battery enclosure close to the negative (-) battery terminal. Use appropriate screws to secure the shunt to the battery enclosure.
- Disconnect the NEGATIVE cable (that connects between the inverter and battery) from the battery's negative (-) terminal.
- Connect the free end of the negative cable to the shunt's terminal labeled "INVERTER." Ensure all connections are tight.
- Connect a short length of cable (same gauge) between the battery's negative(-) terminal and the shunt's terminal labeled "BAT MINUS." Ensure all connections are tight.
- Connect the cables and hardware to the shunt as shown in Figure 2-7.



**NOTE:** The cable connection must be flat against the shunt block with nothing between it for a good connection.

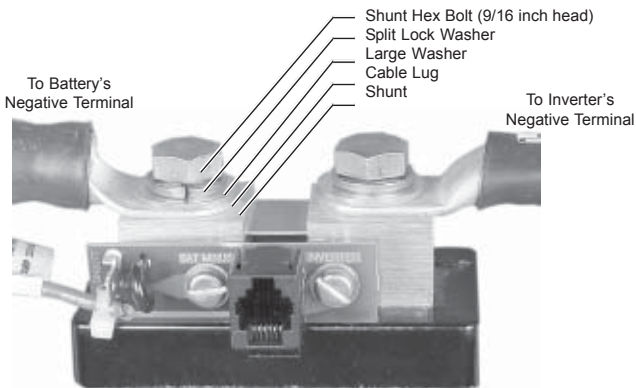

**Figure 2-7**  
**Shunt Connections**

## 2.0 INSTALLATION

### Mounting Circuit Board to an Existing Shunt

Model TM500A - NS is supplied without a shunt and is intended to be wired to an existing shunt. The kit includes two brass 8-32 x 5/8 inch machine screws, two lock-washers and two metal standoffs.

---

 **NOTE:** The shunt must be of the proper type (50 mV/500 amps) and have the necessary threaded screw holes to accommodate the shunt board.

---

- Remove the existing two machine screws (if installed) and hardware from the side of the shunt.
- Install the shunt circuit board and supplied hardware exactly as shown in Figure 2-8.

---

 **NOTE:** Use only the hardware supplied in the kit.

---

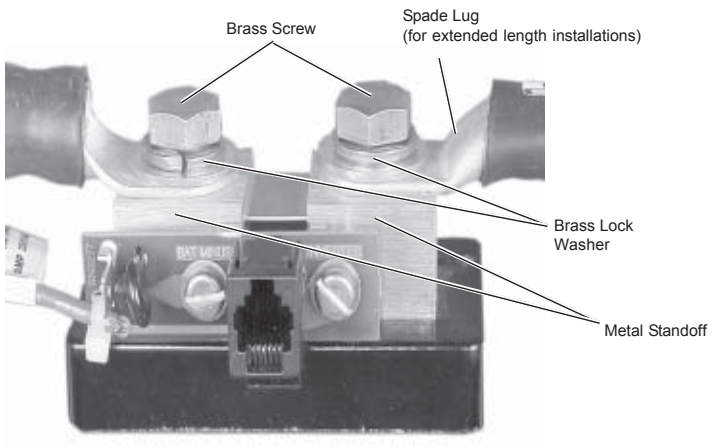
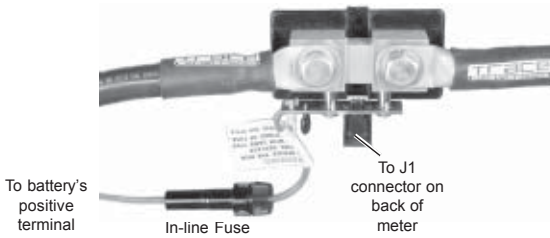

**Figure 2-8**  
**Shunt Circuit Board and Hardware**



### Connecting the Shunt Board

- Remove the fuse from the in-line fuse holder by rotating the fuse holder cap counterclockwise.
- Connect the ring terminal from the fuse holder to the battery's positive terminal.
- Connect the shunt communications cable into the RJ11 jack on the shunt board. This cable can be extended up to 100 feet (30 meters).
- Replace the fuse in the fuse holder. Replace the fuse holder cap by pushing and rotating it clockwise.



**Figure 2-9**  
**In-line Fuse**

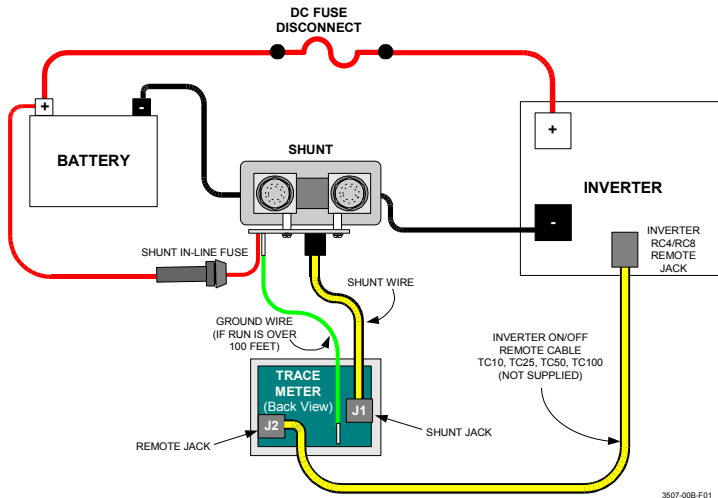

**Figure 2-10**  
**Circuit Diagram**

## 3.0 CONFIGURATION

### Setup

The TM500A is configured at the factory for monitoring a 12 VDC system. These settings can be changed to meet specific system parameters.

The default settings are:

<b>%</b>	Charge Efficiency	94 %
<b>V</b>	Voltage (full-charge)	14.4 volts DC
<b>A</b>	Amperage DC	35 amps
<b>Ah</b>	Amp Hours	200 Hours
	Low-Voltage Indicator	11.2 volts DC
	Recharge Reminder	OFF

### Restoring the Factory Defaults

The factory defaults can be restored to their original settings if desired. The default values will return to those listed above and are for a 12 VDC system.

To restore the factory defaults:

1. Set the TM500A into the power saving mode by repeatedly pressing the SELECT button until the LED display goes blank.
2. Press and hold the RESET button. The display will indicate "ALL" flashing in the display. Continue to hold the RESET button until the LED display remains blank.

The factory defaults are now restored.

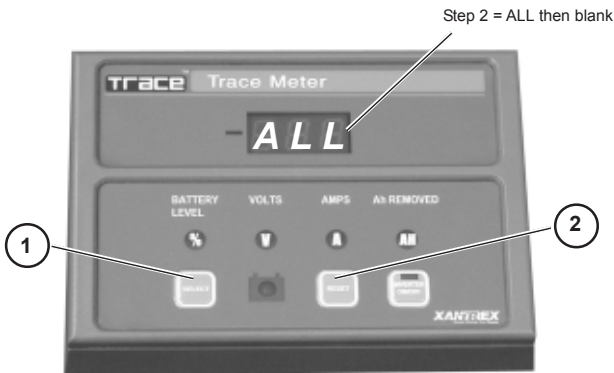
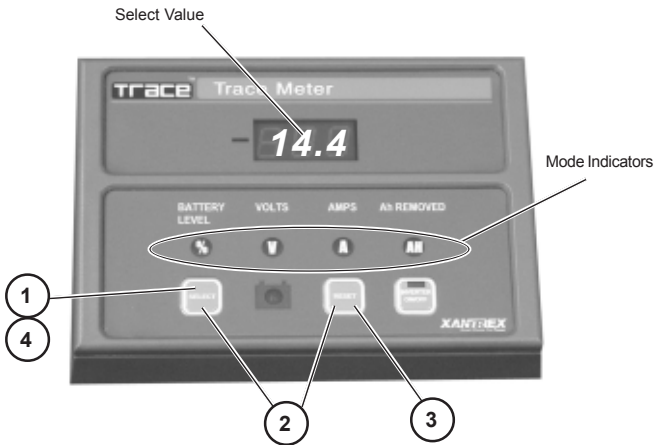

**Figure 3-1**  
**Resetting to Factory Defaults**

### Setting Parameters

Individual system parameters can be set by the following procedure:

1. Press the SELECT button until the mode selection indicator to be set is illuminated.
2. Press the SELECT and RESET buttons simultaneously. Release both buttons when the LED display flashes.
3. Press and release the RESET button to scroll through the selections (or values) slowly, or hold the RESET button to scroll rapidly.
4. When the desired value is shown in the LED display, press the SELECT button to accept it.



**Figure 3-2**  
**Setting Parameters**

## 3.0 CONFIGURATION

### Setting Parameters (continued)

#### Charge Efficiency %

Since batteries are not 100 percent efficient, more energy is required to charge them than can be extracted. Some of this energy is lost in the form of heat and gassing. An efficiency factor of 94 to 98% is typical for lead-acid batteries. Consult the battery manufacturer's specifications for other battery types.

Set this value to 96% for new batteries and 94% (or lower) for batteries already in service. The default setting is 94%. Changing this setting affects the % State-of-Charge meter. The setting range is from 60 to 100%.

#### Setting the Charge Efficiency Factor

If the charge efficiency factor is not known and lead-acid batteries are used in the system, set the charge efficiency factor to 94%. After the batteries have been discharged and then fully recharged, the amp-hour reading should be approximately 000. If this reading is negative when the CHARGED LED (  ) flashes, increase the efficiency factor. If the numbers are substantially going above zero before the CHARGED LED flashes, decrease the efficiency factor. The setting is correct when the CHARGED LED flashes and the reading is slightly positive.

1. Press the SELECT button until the BATTERY LEVEL LED (  ) is illuminated.
2. Press the SELECT and RESET buttons simultaneously until the LED display flashes.
3. Press the RESET button to change the displayed efficiency factor.
4. Press the SELECT button to accept the value.

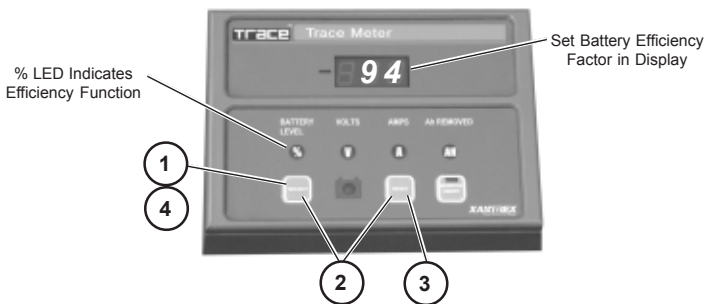

Figure 3-3  
Setting Charger Efficiency

### Setting Parameters (continued)

#### Amp Hours

The amp-hour setting should be set to a value equal or lower than the actual amp-hour capacity of the system's battery bank. Using a number that is lower than the actual amp-hour capacity allows the % Battery State-of-Charge meter to provide a more conservative indication for the use of the batteries to avoid excessively discharging them.

Also note the temperature at which the battery capacity is rated. The amp-hour capacity of the batteries decreases at temperatures lower than the rated value.

The amp-hour rating is usually printed on the battery's label. If the system contains batteries in parallel, then the amp-hour rating of the parallel batteries is added together (i.e., two 120 amp-hour rated batteries in parallel equals 240 amp hours). The amp-hour capacity of a bank does not increase for series-wired batteries and is equal to the lowest rated battery in the series string. If the amp-hour capacity is not listed on the battery, consult the battery manufacturer or dealer for assistance.

#### Setting the Amp Hours

1. Press the SELECT button until the AMP-HOURS LED  is illuminated.
2. Press the SELECT and RESET buttons simultaneously until the LED display flashes.
3. Press the RESET button to change the displayed amp hours to a value slightly lower than the system's total battery amp-hour capacity.
4. Press the SELECT button to accept the new value. The selection range is between 10 (010.) to 2,550 (2.55) Ah.



*NOTE: When the flashing display indicates between 010. to 990. (decimal point after the right most digit), read the display directly. When the flashing display indicates between 1.00 to 2.55 (decimal point two places to the left), multiply the reading by 1000 (i.e., a flashing 160. equals 160 amp hours; a flashing 1.60 in the display equals 1,600 amp hours).*

---

## 3.0 CONFIGURATION

### Setting Parameters (continued)

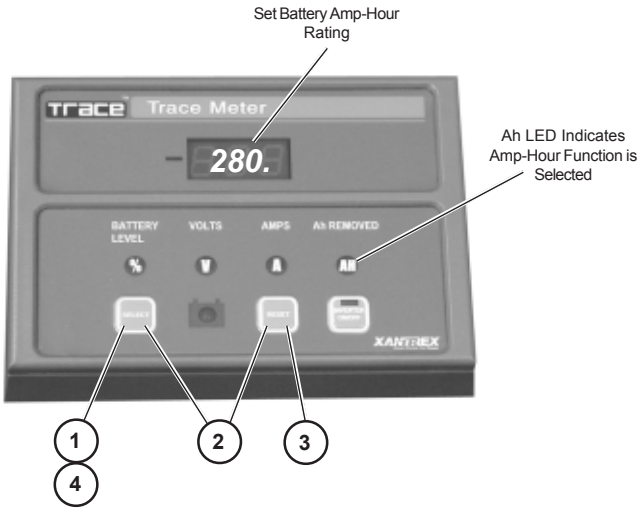

**Figure 3-4**  
**Setting the Amp Hours**

### Setting Parameters (continued)

#### CHARGED Indicator Setup

The CHARGED indicator LED can be programmed to light when the batteries are fully charged based on several different parameters:

- Trigger the LED when *voltage only* parameters are met
- Trigger the LED when *voltage and current* parameters are met
- Trigger the LED when *voltage and time* parameters are met

#### Trigger on *Voltage Only*

When the TM500A is setup to trigger on *voltage only*, the CHARGED LED illuminates when the voltage reaches the level programmed into the TM500A.

---

 **NOTE:** *This mode must be setup first before setting the Voltage and Current or Voltage and Time modes.*

---

#### Step A Setting the Fully-Charged Voltage Level

- 1A.** Press the SELECT button until the Voltage LED () is illuminated.
- 2A.** Press the SELECT and RESET buttons simultaneously until the LED display flashes.
- 3A.** Press the RESET button to change the displayed voltage to the desired fully-charged voltage level:
  - For a 12 VDC system, set this voltage between 14.3–14.9 volts for lead-acid batteries.
  - For a 24 VDC system, set this voltage between 28.6–29.6 volts for lead-acid batteries.
  - For a 48 VDC system, set this voltage between 57.2–59.2 volts for lead-acid batteries.

Refer to the battery manufacturer's recommendation for other types of batteries.

- 4A.** Press the SELECT button to accept the new value. The selection range is between 10 to 64.9 VDC.
- 5A.** Proceed to Step B.

---

 **NOTE:** *In 32–48 VDC systems, whenever a voltage above 35.0 volts is selected, the display multiplies the actual voltage by 2 for the TM48 (48 V shunt adapter).*

---

## 3.0 CONFIGURATION

### Setting Parameters (continued)

### CHARGED Indicator Setup (continued)

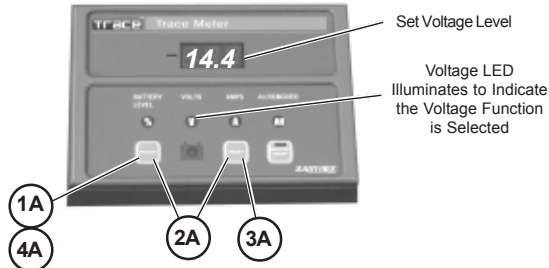

**Figure 3-5**  
**Setting the CHARGED Indicator Voltage Level**

The fully-charged voltage parameters are now set. To allow the *voltage only* setting to trigger the fully-charged LED, the amperage setting must be switched OFF.

#### Step B Switching OFF the Amperage Detection

- 1B. Press the SELECT button until the Amperage LED (  ) is illuminated.
- 2B. Press the SELECT and RESET buttons simultaneously until the LED display flashes.
- 3B. Press the RESET button until the display indicates OFF.
- 4B. Press SELECT button to accept.

The TM500A is now setup to trigger the CHARGED indicator LED (  ) when the voltage level equals or exceeds the value programmed in Step A. When this voltage parameter is met, the CHARGED indicator LED flashes approximately every four seconds.

---

 **NOTE:** The CHARGED indicator remains ON (solid) even when the batteries are discharging, until reset.

---

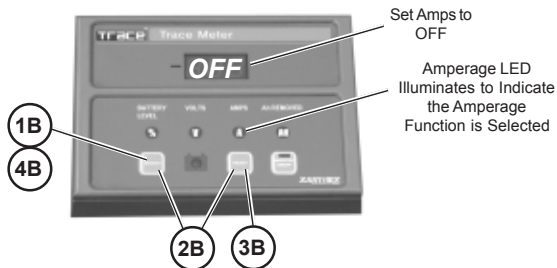

**Figure 3-6**  
**Turn Amps OFF for VOLTAGE ONLY Detection**



### Setting Parameters (continued)

### CHARGED Indicator Setup (continued)

#### Trigger on *Voltage and Amperage*

When this mode is selected, the CHARGED indicator LED illuminates when the *voltage* reaches the programmed level (Step A) **and** the *amperage* decreases to the value set in Step B.

As batteries charge, their voltage slowly increases and the charging current decreases. Setting these parameters allows the CHARGED indicator LED to illuminate when specified conditions are met. However, if a sufficiently high amperage is being drawn from DC loads during charging, the meter detects this current, and it prevents the TM500A from illuminating the CHARGED indicator LED. To set the meter to illuminate the CHARGED LED, the amperage trigger level must be increased to account for the additional DC loads.



---

**NOTE:** *The batteries may not be fully charged if DC loads are in the system and the current level is increased.*

---

To determine the appropriate fully charged amperage for the system, divide the battery bank amp-hour capacity by 20. For example; if the battery bank's amp-hour rating equals 880 amp hours, divide this value by 20 for an amperage setting of 44 amps.

#### Step A Setting the Fully-Charged Voltage Level

- 1A. Press the SELECT button until the Voltage LED () is illuminated.
- 2A. Press the SELECT and RESET buttons simultaneously until the LED display flashes.
- 3A. Press the RESET button to change the displayed voltage to the desired fully charged voltage level:
  - For a 12 VDC system, set this voltage between 14.3–14.9 volts for lead-acid batteries.
  - For a 24 VDC system, set this voltage between 28.6–29.6 volts for lead-acid batteries.
  - For a 48 VDC system, set this voltage between 57.2–59.2 volts for lead-acid batteries.

Refer to the battery manufacturer's recommendation for other types of batteries.

- 4A. Press the SELECT button to accept the new value. The selection range is between 10 to 64.9 VDC.

## 3.0 CONFIGURATION

### Setting Parameters (continued)

#### CHARGED Indicator Setup (continued)

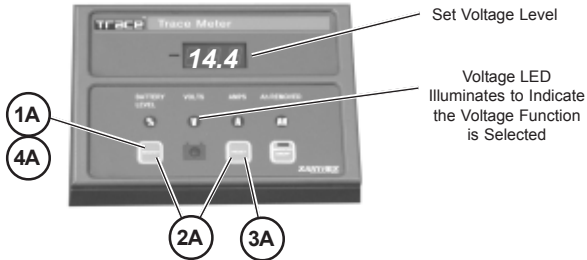

**Figure 3-7**  
**Setting the CHARGED Indicator Voltage Level**

#### Step B Setting the Amperage Trigger Level

- 1B. Press the SELECT button until the Amperage LED (  ) is illuminated.
- 2B. Press the SELECT and RESET buttons simultaneously until the LED display flashes.
- 3B. Press the RESET button until the display indicates the desired amperage.
- 4B. Press SELECT button to accept.

The selectable amperage values are from 1 to 99 amps.

The TM500A is now setup to trigger the CHARGED indicator LED (  ) when the voltage level equals or exceeds the value programmed in Step A and the amperage level falls below the value programmed in Step B. When these parameters are met, the CHARGED indicator LED flashes approximately every four seconds. Whenever the current goes negative (discharge) the timer resets to zero. The CHARGED indicator must be manually reset to turn it OFF.

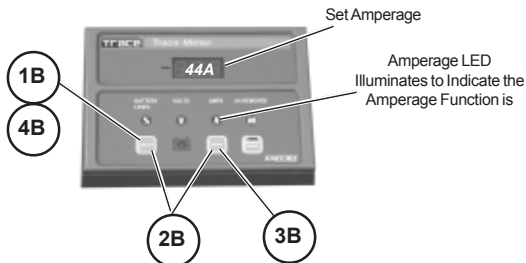

**Figure 3-8**  
**Trigger on Voltage and Amperage**

## Setting Parameters (continued)

### CHARGED Indicator Setup (continued)

#### Trigger on *Voltage and Time*

When this mode is selected, the CHARGED indicator LED illuminates when the *voltage* reaches the programmed level (Step A) **and** the *amperage* remains positive for the *specified time* (Step B).

#### Step A Setting the Fully-Charged Voltage Level

- 1A. Press the SELECT button until the Voltage LED () is illuminated.
- 2A. Press the SELECT and RESET buttons simultaneously until the LED display flashes.
- 3A. Press the RESET button to change the displayed voltage to the desired fully charged voltage level.
  - For a 12 VDC system, set this voltage between 14.3–14.9 volts for lead-acid batteries.
  - For a 24 VDC system, set this voltage between 28.6–29.6 volts for lead-acid batteries.
  - For a 48 VDC system, set this voltage between 57.2–59.2 volts for lead-acid batteries.

Refer to the battery manufacturer's recommendation for other types of batteries.

- 4A. Press the SELECT button to accept the new value.  
The selection range is between 10 to 64.9 VDC.
- 5A. Proceed to Step B.

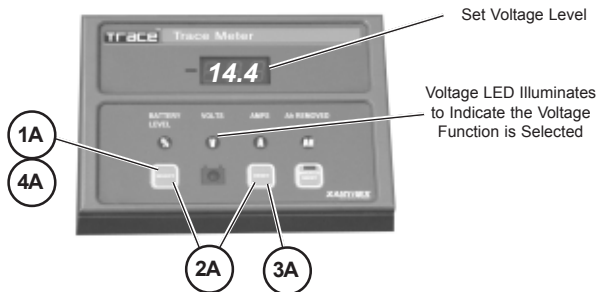

**Figure 3-9**  
Setting the CHARGED Indicator Voltage Level

## 3.0 CONFIGURATION

### Setting Parameters (continued)

#### CHARGED Indicator Setup (continued)

##### Step B Setting the Time Duration

- 1B. Press the SELECT button until the Amperage LED  is illuminated.
- 2B. Press the SELECT and RESET buttons simultaneously until the LED display flashes.
- 3B. Press the RESET button until the display reaches the hour settings. These selections are available following the amperage settings. Select the desired time (in hours or tenths of hours); the voltage must remain at this level to trigger the CHARGED LED.
- 4B. Press SELECT button to accept. The selectable amperage values are from 0.2H to 2.0H (12 minutes to 2 hours).

The TM500A is now setup to trigger the CHARGED indicator LED  when the voltage level equals or exceeds the value programmed in Step A and the current remains positive for the time duration programmed in Step B. When these parameters are met, the CHARGED indicator LED flashes approximately every four seconds. Whenever the current goes negative (discharging), the timer will reset to zero. The CHARGED indicator LED must be manually reset to turn it OFF.

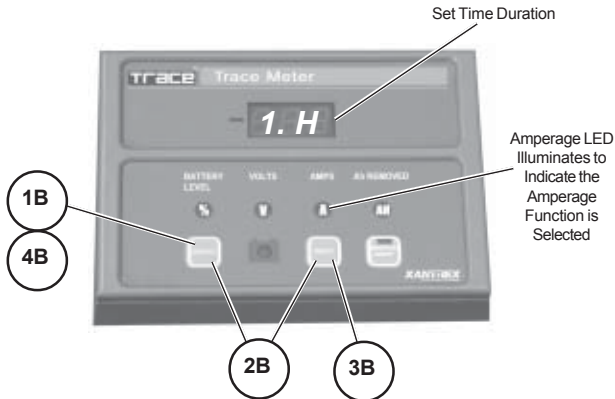

**Figure 3-10**  
Trigger on Voltage and Time

### Setting Parameters (continued)

### CHARGED Indicator Setup (continued)

#### Charger Considerations

There are several different types of chargers (relay, taper or three-stage) which can affect the settings and prevent the CHARGE LED from illuminating.

#### Relay Chargers

Relay type chargers raise the battery to a set voltage level then shut OFF using only voltage as their parameter. Set the TM500A to the voltage only mode and set the voltage slightly below the charger turnoff setting.

#### Taper Chargers

Taper type chargers raise the battery to a specified voltage and shut OFF when the amperage decreases to a specified level. When using taper type chargers (pulse-width-modulated), set the voltage and taper amperage parameters slightly below that of the charger.

If the taper charger is a type that charges up to a certain level and then waits for a period of time to determine if the batteries are charged, then set the TM500A to a voltage slightly below the charger's settings. Set the time a little shorter than the charger's time period.

#### Three-stage Chargers

Three-stage chargers raise the battery to a specified voltage level and then maintain the batteries at a "Float" voltage and trickle current. Adjust the TM500A's voltage parameters slightly below the charger's float voltage setting. Set the amperage slightly below the charger's float amperage setting.

## 3.0 CONFIGURATION

### Setting Parameters (continued)

#### Low-Voltage Indicator

The TM500A should be set to trigger on a user specified low DC voltage level. When the battery voltage falls below this level, the VOLTAGE indicator  flashes approximately once every four seconds. This meter is useful to determine if the batteries are being over-discharged. Refer to the battery manufacturer's specifications for the proper low-voltage level.

A voltage between 10 and 35 volts (10 and 64.9 volts for 48-volt systems) can be specified to activate the low-voltage alarm.

---

 **NOTE:** Disconnecting the TM500A from the shunt (DC voltage) will cause this setting to be reset to 0.00. It must be re-configured again for the proper system low voltage level.

---

#### Configuring the Low-Voltage Alarm

1. Press and hold the SELECT button until the dSF message is displayed, then release.
2. Press and release the SELECT button until the bLO message is displayed in the LED display.
3. Press and release the SELECT and RESET button simultaneously.

---

 **NOTE:** Pressing the RESET button alone while bLO is displayed will reset the meter to the current battery voltage.

---

4. Press the RESET button until the desired voltage level is displayed.
5. Press the SELECT button to accept this value.
6. Press the SELECT button to return to the metering mode.

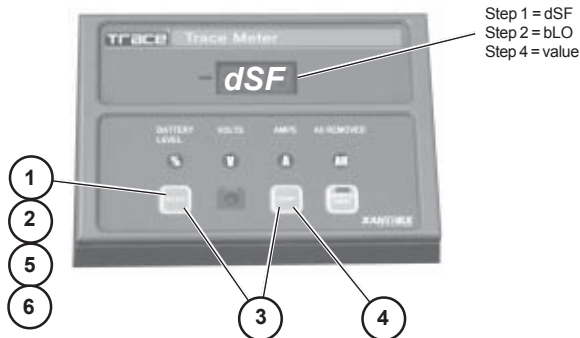

**Figure 3-11**  
Low-Voltage Indicator

## Indicators and Controls

The TM500A contains the following controls and indicators.

- Large three-digit LED display
- Four red mode indicators
- One green CHARGED indicator
- One green INVERTER ON/OFF indicator
- Three pressure sensitive push-buttons

The three-digit LED displays alphanumeric messages with a resolution to 0.00. A negative value (–) indicator is positioned to the left of the display.

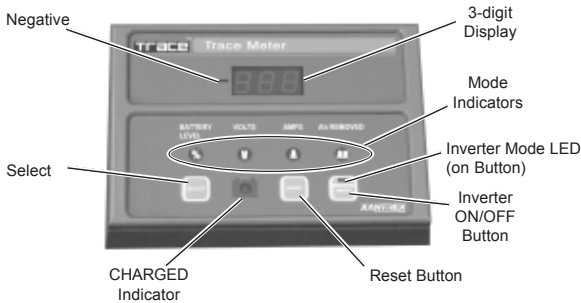

**Figure 4-1**  
**Front Panel Controls and Indicators**

## Buttons

### SELECT Button

The SELECT button is used to switch the TM500A between the different meters and modes. One of the LEDs located above the buttons illuminate, indicating the active function.

### RESET Button

The RESET button is used to change the metering parameters and to reset the CHARGED indicator.

### INVERTER ON/OFF Button

The INVERTER ON/OFF button remotely controls the inverter's ON/OFF function via the RC4 or RC8 remote control jack. This button duplicates the function of the inverter's power switch. The LED duplicates the indications of the RC8 remote control. Refer to the RC4/RC8 documentation (supplied with the cable) for LED indications and modes available (depends on inverter). Remote control cables are available in 10, 25, 50 and 100 foot lengths. This button/LED does not function if a remote control cable is not connected or if the inverter does not support an RC4 or RC8 remote control.

## 4.0 OPERATION

### Indicators and Controls (continued)

#### Basic Meters

To display one of the four meters;

- Press the SELECT button until the desired indicator illuminates.
- The LED display indicates the values for the selected function.

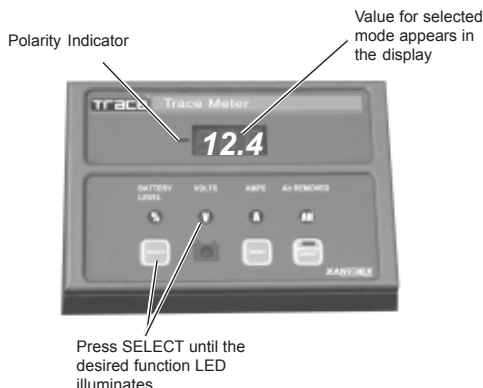

**Figure 4-2**  
**Meter Selection and LED Indicators**

#### Available Meters

##### % (state-of charge)

When this indicator is illuminated, the LED display shows the battery's state-of-charge based upon the amp-hour reading divided by the amp-hour capacity of the batteries (or battery bank). The values displayed are:

LO (when battery is below 27.5%)

30 to 90% numerical value (in 5% increments)

FULL when the battery's state-of-charge is over 92.5% capacity

##### V (VOLTS)

When this indicator is illuminated, the LED display shows the real time voltage from 08.0 to 35 volts (for 12- to 24-volt systems)  $\pm 0.1$  volt accuracy, or 16.0 to 69.9 volts (for 48-volt systems)  $\pm 0.2$  volt accuracy.

##### A (AMPS)

When this indicator is illuminated, the LED display shows the real-time charge or load current in amps. The range is from  $\pm 0.1$  to  $\pm 999$  amps with a refresh rate of one second. The accuracy is  $\pm 1.5\%$ .



## Indicators and Controls (continued)

### Ah (AMP HOURS)

When this indicator is illuminated, the LED display shows the total amp hours used since the last time the amp-hour meter was reset. The range is from  $\pm 0.00$  to  $\pm 167,000$  amp hours. When the decimal point flashes, multiply the reading by 1000 (i.e., 111. = 111,000). This meter automatically resets to zero approximately one minute after the CHARGED LED remains ON solid (stops flashing).

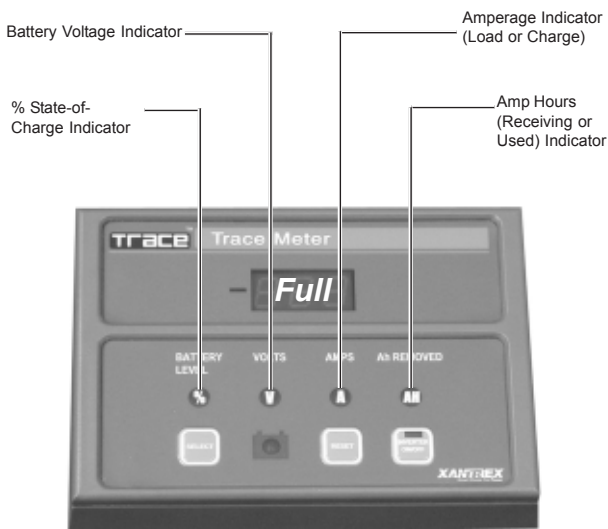

**Figure 4-3**  
Mode Indicator LEDs

### Power Saving Mode

The TM500A can be put into a low-power/power-saving mode by repeatedly pressing the SELECT button until the display goes blank. In this mode, none of the LED indicators illuminate. The power consumption of the unit is reduced from 32 mA maximum to approximately 18 mA. Pressing the SELECT button again exits the power-saving mode.

## 4.0 OPERATION

### Indicators and Controls (continued)

#### Data Monitors

There are several additional data displays available, accessed by pressing and holding the SELECT button until "dSF" appears in the display. Pressing and releasing the SELECT button alternates between its value, then scrolls to the next menu item.

The available data monitor functions are:

#### **dSF (Days Since Full)**

This meter shows the number of days since the batteries were fully charged. The range on this meter is from 0.00 to 655 days. The value resets to zero when the battery is recharged (CHARGE LED flashes) or is manually reset.

#### **cAH (Cumulative Amp Hours)**

This meter measures the cumulative amp hours used from the batteries. This function can be used as a battery life indicator. The range is from 00.0 to 999,000. Multiply the displayed value by 1000 when the decimal point flashes. The cumulative value remains in memory even if the TM500A is disconnected. This meter can be manually reset to zero.

#### **bHI (High Battery Voltage)**

This meter displays the highest battery voltage detected. Use this meter to determine if an overvoltage condition occurred or that the charging sources are charging to the voltage setting of the charger. The meter resets to the *current* battery voltage value when it is disconnected and reconnected to the DC shunt or is manually reset.

#### **bLO (Low Battery Voltage)**

This meter displays the lowest battery voltage detected. Use this meter to determine if the batteries are being over-discharged. This meter resets to the current battery voltage value when the RESET button is pressed and must be manually reconfigured after the DC power is cycled or when first installed.

### Indicators and Controls (continued)

#### To access the Data Monitor Function:

- Press and hold the SELECT button until dSF appears in the LED display. The display alternates between the data monitor function and its data.
- Press the RESET button to display the value for the selected function.
- Continue pressing the SELECT button to scroll through all the available displays and their data.
- When the “bLO” data has been accessed, another press of the SELECT button returns to the basic meters function.

To reset the data monitor values to zero (or the present value) press and hold the RESET button for approximately 5 seconds (the data monitor value flashes three times and then updates).

## 4.0 OPERATION

### Reminders and Indicators

The TM500A features a programmable recharge reminder as well as low-voltage and charged indicators.

### Amp-Hour Reminder

The Amp-Hour LED can be configured to flash at a specified interval following recharge as a reminder that it is time to charge the batteries. The range is from 1 to 99 days or it can be turned off. When the number of days programmed into this counter is exceeded, the Amp-Hour (Ah) LED flashes. The specified value remains in memory until power is removed from the TM500A. Recharging the batteries synchronizes the % State-of-Charge and Amp-hours meters.

#### To configure this function:

1. Press and hold the SELECT button until the dSF message is displayed in the LED display, then release the button.
2. Press and release the SELECT and RESET buttons together.
3. Press the RESET button repeatedly until the desired value appears in the display.
4. Press the SELECT button to accept the value. The range is from 1 to 99 days or OFF.

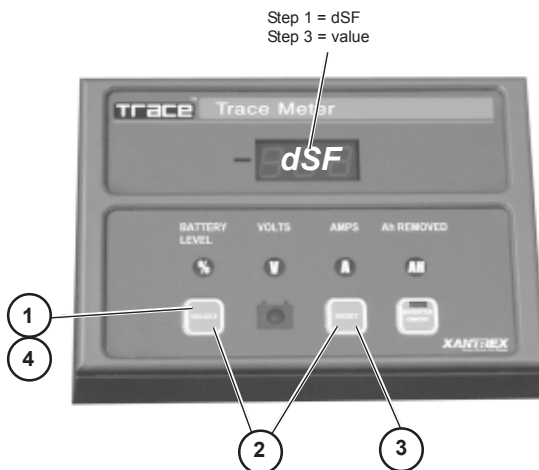

**Figure 4-4**  
**Meter Selection and LED Indicators**

## Reminders and Indicators (continued)

### Low-Voltage Indicator

A voltage between 10 and 35 volts (10 and 64.9 volts for 48-volt systems) can be specified to activate the low-voltage alarm. When the battery voltage falls below this level, the voltage indicator (V) flashes approximately once every four seconds.

#### To configure this alarm:

1. Press and hold the SELECT button until the dSF message is displayed, then release.
2. Press and release the SELECT button until the bLO message is displayed in the LED display.
3. Press and release the SELECT and RESET button together.
4. Press the RESET button until the desired voltage level is displayed.
5. Press the SELECT button to accept this value.
6. Press the SELECT button to return to the metering mode.

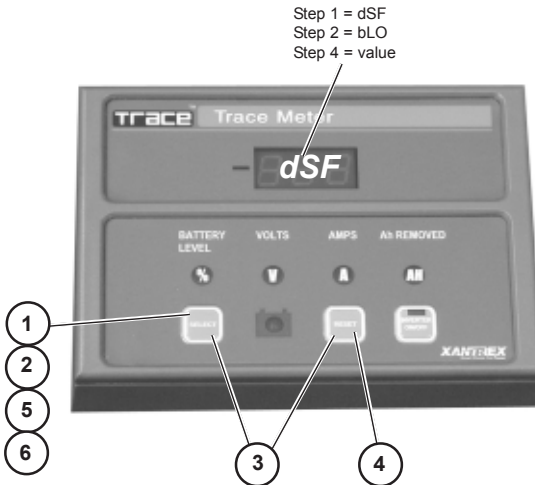

**Figure 4-5**  
Low Voltage Indicator

## 4.0 OPERATION

### Reminders and Indicators (continued)

#### CHARGED Indicator

The CHARGED indicator (  ) can be programmed to flash every four seconds when specified charging criteria are met. This can be *voltage only*, *voltage and current*, or *voltage and time*. When the programmed conditions are met for a minimum of 30 seconds, the CHARGED indicator flashes. The CHARGED indicator stops flashing and remains ON solid when the "charged" conditions are no longer met (i.e., the current flow is negative (battery discharging) continuously for one minute). The Amp-Hour Meter also resets to zero at this time.

#### To reset the CHARGED LED:

1. Press the RESET button while the , , or  LED is ON.

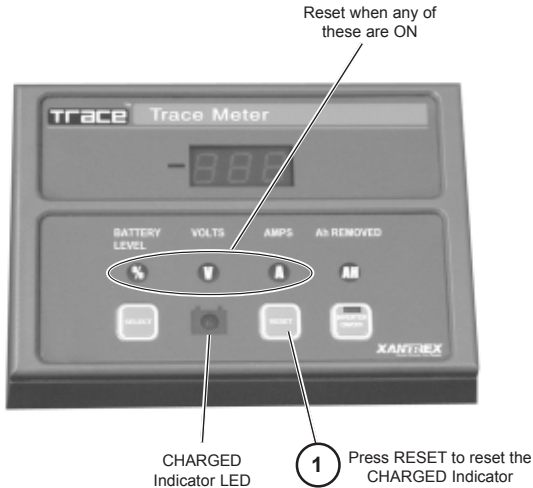

**Figure 4-6**  
Resetting the CHARGED Indicator

## 5.0 TROUBLESHOOTING

Symptom	Possible Cause	Solution
LED in INVERTER ON/OFF switch does not light.	J2 plug not plugged into TM500A or the inverter.  Inverter does not have a compatible Jack.	Plug cable into TM500A and Inverter's RC4/RC8 remote control jack.  The inverter remote control only operates on models equipped with an RC4/RC8 remote control input.
Voltage displayed on meters is not correct.	The TM500A voltage is configured above 35.0 volts for a 12- or 24-volt system.  The TM500A voltage is configured below 35.0 volts for a 48-volt system.	Reconfigure the TM500A for the correct system voltage (see Section 3, Configuration, Charged Indicator Set-up).
Battery State-of-Charge displays "FULL" when voltage is low.	Amp-hour setting is too low.	Reconfigure the amp hours to the correct setting - Battery bank size (see Section 3, Configuration, Setting Parameters, Amp Hours).
bLO displays a voltage of 00.0.	The bLO meter was not configured during set-up, or after being disconnected from the shunt.	Reconfigure the Low-Voltage Indicator (bLO) for the correct low-battery voltage (see Section 3, Configuration, Setting Parameters, Low-Voltage Indicator).
CHARGED LED continues to flash even though the current flow is negative (battery discharging) continuously for one minute.	VOLTAGE ONLY configuration for the Charged Indicator Setup may be set too low.	Reconfigure the CHARGED voltage to an appropriate value (i.e., 12.6 V for a 12-volt system ), (see Section 3, Configuration, Setting Parameters, Charged Indicator Setup).  The CHARGED indicator must be manually reset to turn it OFF.

973-0012-D-001A

## 6.0 SERVICE INFORMATION

Xantrex Technology Inc., takes great pride in its products and makes every effort to ensure your unit fully meets your independent powering needs.

If your product needs repair, contact our Customer Service department at: (360) 435-8826 to obtain an RMA# and shipping information; or, fax this page with the following information to: (360) 474-0616. Or contact the Xantrex Warranty Department at [Tracewarranty@traceengineering.com](mailto:Tracewarranty@traceengineering.com).

Please provide:

Model Number: \_\_\_\_\_

Serial Number: \_\_\_\_\_

Purchase Date: \_\_\_\_\_

Problem: \_\_\_\_\_

Include a telephone number where you can be reached during business hours and a complete return shipping address (P.O. Box numbers are not acceptable).

Name: \_\_\_\_\_

Address: \_\_\_\_\_

City: \_\_\_\_\_

State / Province: \_\_\_\_\_

Zip / Postal Code: \_\_\_\_\_

Country: \_\_\_\_\_

Phone: (\_\_\_\_) \_\_\_\_\_

FAX: (\_\_\_\_) \_\_\_\_\_

E-mail Address: \_\_\_\_\_

**XANTREX**  
*Smart Choice For Power*

---

visit our website at: [www.xantrex.com](http://www.xantrex.com)

or e-mail us at: [xantrex.com](mailto:xantrex.com)



## Specifications

<b>Function</b>	<b>Range</b>	<b>Accuracy</b>
<b>Battery Volts</b>	8.0–35 volts	± 0.1 volt
	16.0–70 volts	± 0.2 volt
<b>Battery Amps</b>	0.1–999 amps	± 1.5% (+ least significant digit)
<b>Battery Amps Resolution</b>		
0.1 to 99.9 amps	± 0.1 amp	
100 to 999 amps	± 1.0 amp	
<b>Battery Level %</b>	Low (< 27.5%)	~ 2.5% accuracy
	30–90%	in 5% increments
	FULL (> 92.5%)	
<b>Current Draw</b>		
Power Saving Mode		18 mA maximum
All other modes		32 mA maximum
<b>Amp Hours</b>		
Battery Capacity		-0.00 to ±167,000 amp hours 10 to 2550 amp hours
<b>Data Monitoring Functions</b>		
dSF–Days Since Full		0.01–655 days
cAH–Cumulative Ah Removed		0–999,000 in nonvolatile memory
bHI–Battery High Volts		to 35.1 VDC resettable (12–24 VDC) to 70.2 VDC (w/optional 48 VDC adaptor)
bLO–Battery Low Volts		8.0 volts, resettable (12–24 VDC) 16.0 volts, resettable (w/48 VDC adaptor)
<b>LED Display</b>		
		3-digit, 7-segment red LED with 5 additional indicators
<b>LED Indicators</b>		
		State of Charge(SOC)/Battery Efficiency Battery Voltage Amps Amp Hours Removed/Battery Capacity Recharge Reminder (adjustable) Low Battery Voltage (adjustable)
<b>Dimensions</b>		
		3-7/8" H x 5-3/8" W x 1-1/4" D (14 cm H x 9.5 cm W x 3.2 cm D)
<b>Weight</b>		
		approximately 3 lb (1.36 kg)
<b>Mounting</b>		
Surface		using molded plastic adaptor
Flush		using plastic mounting bracket

Specifications @ 25 °C.

Specifications subject to change without notice.

## 8.0 WARRANTY

### Limited Warranty

Xantrex Technology Inc., warrants its power products against defects in materials and workmanship for a period of two (2) years from the date of purchase, established by proof of purchase or formal warranty registration, and extends this warranty to all purchasers or owners of the product during the warranty period. Xantrex does not warrant its products from any and all defects:

- arising out of material or workmanship not provided by Xantrex or its Authorized Service Centers;
- when the product is installed or exposed to an unsuitable environment as evidenced by generalized corrosion or biological infestation;
- resulting from abnormal use of the product, alteration, or use in violation of the instructions;
- in components, parts, or products expressly warranted by another manufacturer.

Xantrex agrees to supply all parts and labor to repair or replace defects covered by this warranty with parts or products of original or improved design, at the company's option. Xantrex also reserves the right to improve the design of its products without obligation to modify or upgrade those previously manufactured. Defective products must be returned to Xantrex or its Authorized Service Center in the original packaging or equivalent. The cost of transportation and insurance on items returned for service is the responsibility of the customer. Return transportation (UPS Ground or equivalent) as well as insurance on all repaired items is paid by Xantrex.

All remedies and the measure of damages are limited to the above. Xantrex shall in no event be liable for consequential, incidental, contingent, or special damages, even if Xantrex has been advised of the possibility of such damages. Any and all other warranties, expressed or implied, arising by law, course of dealing, course of performance, usage of trade or otherwise, including, but not limited to, implied warranties of merchantability and fitness for a particular purpose, are limited in duration for a period of two (2) years from the original date of purchase.

Some states or countries do not allow limitations on the term of an implied warranty, or the exclusion or limitation of incidental or consequential damage, which means the limitations and exclusions of this warranty may not apply to you. Even though this warranty gives you specific legal rights, you may also have other rights which vary from state to state.



5916 - 195th Street N.E., Arlington, WA 98223 Phone: (360) 435-8826 Fax: (360) 435-2229

visit our website at: [www.xantrex.com](http://www.xantrex.com)



**Xantrex** Technology Inc.  
5916 195th Northeast  
Arlington, WA 98223  
U.S.A.  
t: 360/435.8826  
f: 360/435.3945  
[www.xantrex.com](http://www.xantrex.com)

© 2001 Xantrex Technology Inc.  
P/N 973-0012-01-02 Rev. A 05/01

Printed in U.S.A.

**XANTREX**  
Smart Choice For Power