

X-10[®] POWERHOUSE[™]

Supervised Security System Owner's Guide

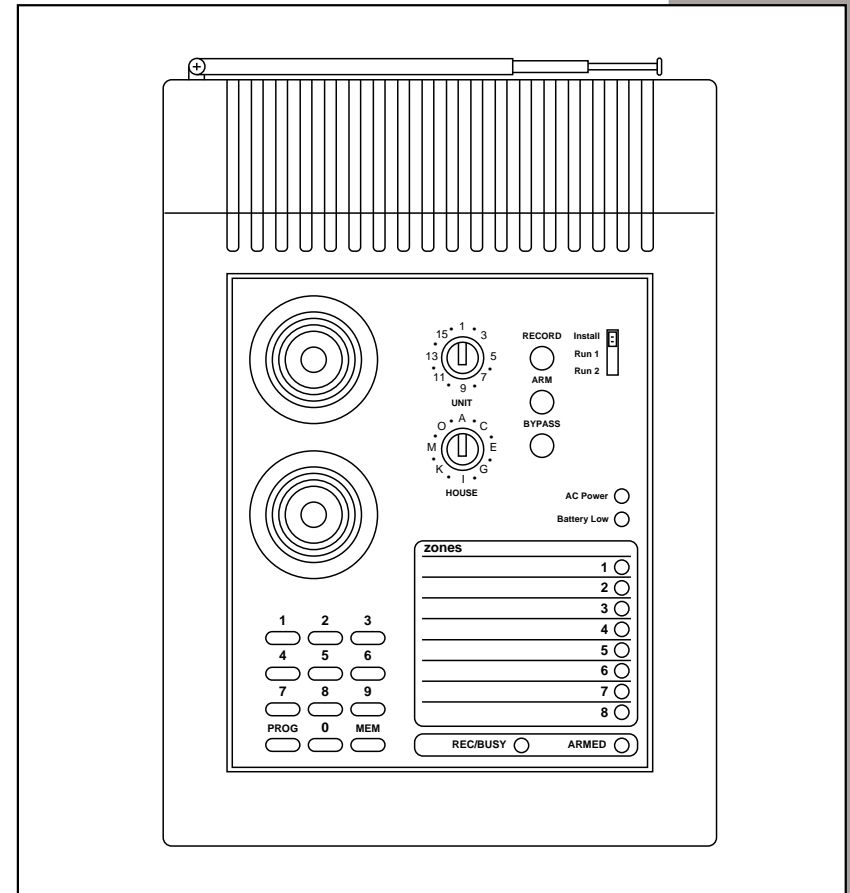

Supervised Security System DS7000

READ THIS FIRST

This equipment generates and uses radio frequency energy, and if not installed and used properly, that is, in strict accordance with the manufacturers instructions, may cause interference to radio and television reception. It has been type tested and found to comply with the limits for remote control security devices in accordance with the specifications in Sub-Parts B and C of Part 15 of *FCC Rules*, which are designed to provide reasonable protection against such interference in a residential installation. However, there is no guarantee that interference will not occur in a particular installation. If this equipment does cause interference to radio or television reception, which can be determined by unplugging the equipment, try to correct the interference by one or more of the following measures.

- Reorient the antenna of the radio/TV experiencing the interference.
- Relocate the console with respect to the radio/TV.
- Move the console away from the radio/TV.
- Plug the console into an outlet on a different electrical circuit from the radio/TV experiencing the interference.

If necessary, consult X10 Technical Support for additional suggestions.

The Security Console's telephone dialer is designed to conform to federal regulations, and it can be connected to most telephone lines. However, each telephone or telephone device that is connected to the telephone line draws power from the telephone line. This is referred to as the device's ringer equivalence number, or REN.

If more than one telephone or other device is connected to the same line, add up all the RENs. If the total is more than five, the telephones might not ring. In rural areas, a total REN of three might impair ringer operation. If ringer operation is impaired, remove one of the devices from the line.

Note: The console must not be connected to:

- Coin-operated systems
- Party-line systems
- Most electronic key telephone systems

The console's telephone dialer complies with Part 68 of *FCC Rules*. You must, upon request, provide the FCC registration number and the REN to the local telephone company. Both numbers are shown on the bottom of the console.

The telephone portion of the Security Console has been tested and found to comply with all applicable UL and FCC standards.

In the unlikely event that the console causes problems on the telephone line, the telephone company can disconnect service. The telephone company attempts to notify you in advance. If advance notice is not practical, the telephone company notifies you as soon as possible and advises you of your right to file a complaint with the FCC.

Also, the telephone company can make changes to its lines, equipment, operations, or procedures that could affect the operation of this console. The telephone company notifies the owner of these changes in advance, so the necessary steps can be taken to prevent interruption of telephone service.

Note: The security functions of this system have not been tested by Underwriters Laboratories.

Contents

Introduction	4
Installation	5
Locating Security System components	5
Security Console	6
Security Remote	7
Keychain Remote	8
Door/Window Sensor	9
Motion Detector	10
Power Horn	12
Lamp Module	13
Other X10 Products	14
Setting Up the Dialer	15
Programming Phone Numbers	15
Recording a Voice Message	15
Using the Security System	16
Console Zone Indicators	16
Arming and Disarming the System	16
Battery Information	18
General	18
Security Console	18
Handheld and Keychain Remotes	18
Door/Window Sensor and Motion Detector	19
Clearing remotes & sensors from the console	19
Troubleshooting	20

Introduction

The X10 Supervised Security System is built around a Security Console with an automatic dialer that calls neighbors or friends in the event of a break in. Battery powered RF Door/Window Sensors and Motion Detectors are used to trigger the alarm, with RF Handheld and Keychain Remote controls for arming and disarming. All sensors and remotes incorporate random digital security coding.

The system may be configured with any combination of the following items:

- Up to 16* Keychain Remotes with arm/disarm/panic and security light functions.
- Up to 16* Handheld Security Remote with arm/disarm and panic functions, and buttons to control the security light and up to four additional X10 automation modules to operate lights and appliances around the home.
- Up to 16* magnetic switch operated wireless Door/Window Sensors.
- Up to 16* wireless PIR Motion Detectors.
- Remote PowerHorn™ sirens.
- Additional X10 automation modules such as plug-in lamp and appliance modules and wired-in replacement wall switches.

This manual describes the installation process for the security elements of the system, and does not cover the additional X10 automation modules which are supplied with their own installation instructions.

***Note:** Remotes may be added in any combination up to a total of 16. Door/Window Sensors and Motion Detectors may be added in any combination up to a total of 16.

Installation

Locating Security System components

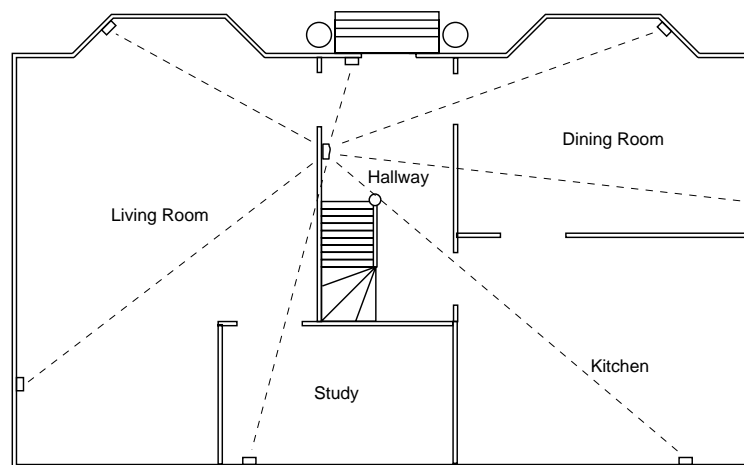

Locating the Security Console

Choose a location for the Security Console which is as central as possible in the house, while providing access to a modular telephone jack and an AC outlet. The console may be placed on a shelf or table, or may be fixed to a wall using the optional mounting bracket and screws.

Locating Door/Window Sensors and Motion Detectors

Plan the location of the Door/Window Sensors and Motion Detectors so that the RF path which runs in a straight line from sensor to console is not obstructed by large metal objects such as a refrigerators or freezers, and passes through as few walls as possible.

Door/Window Sensors may be hidden behind drapes for a more discreet installation.

Installation

Security Console

Mounting the console

The Security Console is designed to be installed free-standing on a table top or shelf. A wall mounting bracket is also available.

Fitting the backup battery

Slide off the battery compartment cover and clip a 9V battery onto the battery contacts. Slide the battery into the battery compartment and replace the cover. When AC power is applied the battery LED on the front panel will go out. It is not necessary to disconnect power to the console when fitting or replacing batteries.

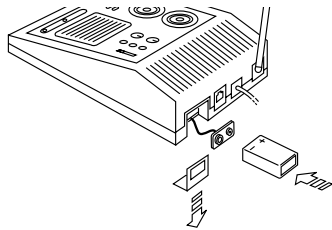

Attaching cables

A telephone cord terminated at each end in an RJ11 connector is provided for telephone connection. If possible, the console should be connected to its own telephone line to ensure that the line cannot be busy when the console attempts to dial out. For applications where this is not practical, the console may also share a line with an existing telephone using a "T" adapter.

Note: The X10 Security Console is not designed to operate with an RJ31X type telephone connection.

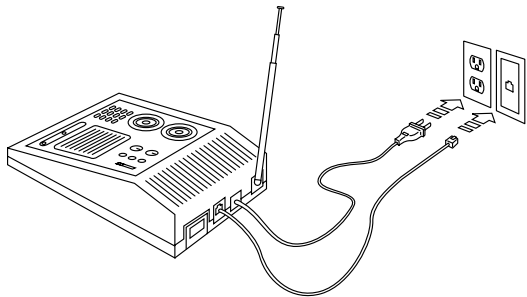

6

Installation

Security Remote

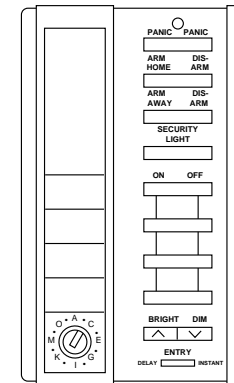

Registering the Security Remote with the Security Console

- Set the code wheel on the Security Remote to the same House Code as the Security Console.
- Fit four AAA Alkaline batteries in the battery compartment in the back of the remote.
- Set the slide switch on the Security Console to INSTALL.
- Press ARM on the remote. The console beeps once to confirm that the remote has been registered.
- Return the console slide switch to the RUN1 or RUN2 position.

Note: If the remote did not register, remove the label on the front and use a pencil or other pointed object to press the small CODE button to generate a new random code. Press ARM again to install the remote.

Testing the Security Remote

- Set the slide switch on the Security Console to RUN1 or RUN2.
- Press ARM AWAY on the remote. The console beeps once to confirm and the ARM indicator lights. Press DISARM.
- Press SECURITY LIGHT ON and OFF to control a light connected to a lamp module with codewheels set to the same House Code and Unit Code as set on the Security Console.

7

Installation

Keychain Remote

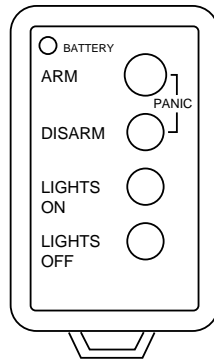

Registering the Keychain Remote with the Security Console

- Fit two AAA Alkaline batteries in the battery compartment in the back of the Keychain Remote.
- Press and hold the ARM button for about a second. The LED indicator flashes twice when you release it. This confirms the Keychain Remote has generated a new random security code.
- Set the slide switch on the Security Console to INSTALL.
- Press ARM. The console beeps once to confirm that the Keychain Remote has been registered.
- Return the console slide switch to the RUN1 or RUN2 position.

Testing the Keychain Remote

- Set the slide switch on the Security Console to RUN1 or RUN2.
 - Press ARM on the Keychain Remote. The console beeps once to confirm and the ARM indicator lights. Press DISARM.
- Note:** The Keychain Remote always arms the system instantly - there is no exit or entry delay.
- Press LIGHTS ON and LIGHTS OFF to turn on and off a light connected to a Lamp Module with the same House Code and Unit Code as set on the Security Console.
 - Press ARM and DISARM together to trip the panic alarm. Press DISARM to stop the alarm.

Installation

Door/Window Sensor

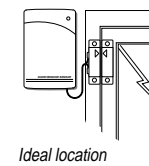
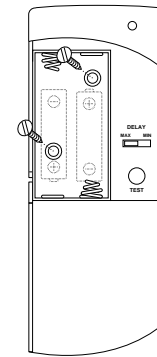

Ideal location

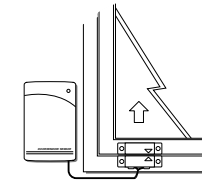

Sliding window

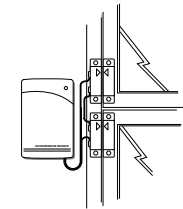

Two windows (requires accessory magnetic switch pair)

Installing the Door/Window Sensor

- Attach the Door/Window Sensor to the wall using the mounting screws provided.
- Fit the Door/Window Sensor as high as possible at the top of the door/window.
- Make sure the arrows on the magnetic switch halves are facing each other and that they separate cleanly when the door or window is opened.
- Set the DELAY slide switch to MIN to always trigger the alarm instantly (for windows), or to MAX to trigger the alarm after a preset entry delay when the system is armed in DELAY mode (for doors).

Registering the Door/Window Sensor with the Security Console

- Fit two AA Alkaline batteries in the battery compartment.
- Press and hold the TEST button for about a second. The LED flashes twice when you release it. This confirms it has generated a new random security code.
- Set the slide switch on the Security Console to INSTALL.
- Press the TEST button on the Door/Window Sensor. The console beeps once to confirm and the next available zone LED lights.
- Return the console slide switch to the RUN1 or RUN2 position.

Testing the Door/Window Sensor

- Set the slide switch on the Security Console to RUN2.
- Open the door or window with the sensor attached. The console beeps to acknowledge and the zone LED lights.

Installation

Motion Detector

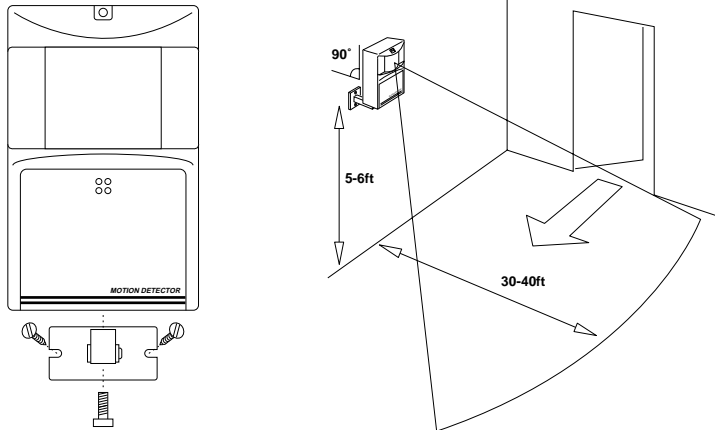

Installing the Motion Detector

- Attach the Motion Detector to a wall at a height of 5 to 6ft using the mounting bracket and screws provided.

Note: The Motion Detector has a special lens that 'looks' downwards. It must therefore be mounted to face outwards horizontally, i.e. do not 'aim' the sensor downwards.

- Set the slide switch to position 1 for instant triggering for maximum sensitivity or position 2 to trigger only after two movements have been sensed.

Registering the Motion Detector with the Security Console

- Fit four AA Alkaline batteries in the battery compartment.
- Press the CODE button on the back of the Motion Detector using a pencil or other pointed object to generate a new random security code.
- Set the slide switch on the Security Console to INSTALL.
- Press the TEST button on the Motion Detector. The console beeps once to confirm and the next available zone LED lights.

Note: If the Motion Detector senses movement before you press the TEST button it may register itself automatically.

Installation

Testing the Motion Detector

- Set the slide switch on the Motion Detector to position 1.
- Press and hold the TEST button for about a second. The LED flashes twice when you release it.
- Wait 20 seconds for the sensor to settle.
- Walk in front of the Motion Detector. The indicator LED lights each time it senses movement. Check the coverage area and reposition the sensor as required.
- Press the TEST button to return to normal operating mode.

Note: The Motion Detector will automatically return to normal operating mode after about 2 minutes.

Installation

Power Horn™ Remote Siren (sold separately)

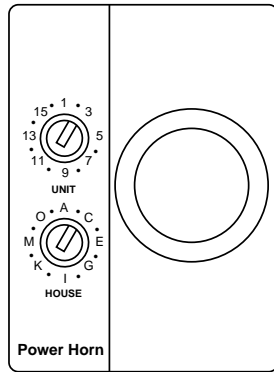

Installing the Power Horn

- Set the House Code dial to the same House Code as the Security System
- Set the Unit Code dial to an unused code.
- Plug the Power Horn into a convenient AC outlet, preferably an unswitched one to ensure that the Power Horn cannot be turned off accidentally.

Testing the Power Horn

- Press the ON button on any X10 controller or remote which corresponds to the same House Code and Unit Code as the Power Horn, hold the button pressed for several seconds. The siren will continue for 4 minutes, or until an OFF command is received.
- Trigger the security system by pressing the PANIC button on the console or on a remote. The Power Horn will be activated automatically in the next 4 seconds after the alarm has been triggered and will continue for around 4 seconds after the system is disarmed.

Installation

Lamp Module

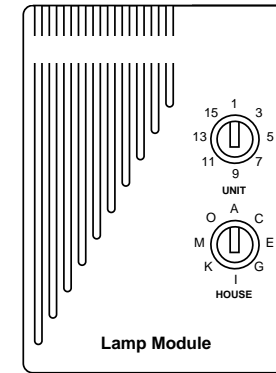

Installing the Lamp Module to control the security light

- Set the House Code and Unit Code dials to match the settings on the Security Console. This allows it to be controlled from the security light buttons on the remotes.
- Plug a lamp into the Lamp Module and plug the Lamp Module into a convenient AC outlet, preferably an unswitched one to ensure that the lamp will always operate when the alarm is triggered.

Installing the Lamp Module to control other lights

- Set the House Code dial to match the House Code set on the Security Console.
- Set the Unit Code dial to an unused code which can be controlled from the Security Remote (switches 1-4 control Unit Codes 1-4) or from any other remote or plug-in controller as required.
- Plug a lamp into the Lamp Module and plug the Lamp Module into a convenient AC outlet, preferably an unswitched one to ensure that the lamp will always operate when the alarm is triggered.

Local control

The Lamp Module includes circuitry to sense the lamp's own on/off switch to turn the lamp on locally. To switch a lamp on, turn the lamp's own switch off then on again.

Installation

Other X10 products (sold separately)

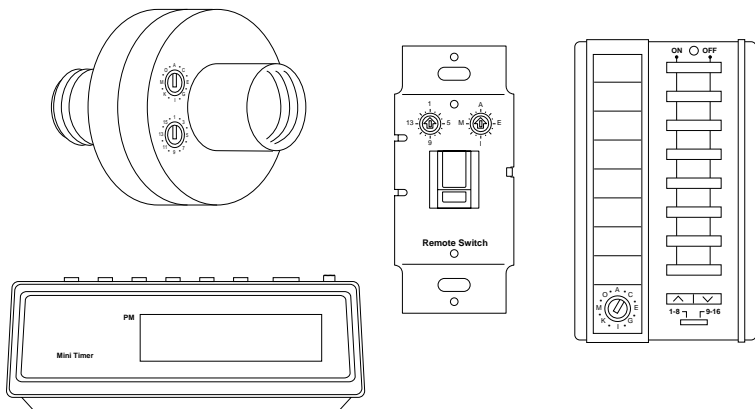

Modules

A wide range of switch and control modules are available from X10, all of which can be controlled from the same remote controls which are used to operate the security system. Modules available include replacement wall switches, X10 controlled AC outlets, screw-in lamp modules, plug-in appliance modules and many others.

Remotes

As well as being able to add up to 16 security remotes to the system, you can also add any number of Home Automation wireless remotes such as the handheld PalmPad™ remote which controls up to 16 modules around the home.

Controls

A range of plug-in controllers are available including the Mini Timer which controls up to four modules with two on/off times each day, the Touch-Tone Controller which lets you use any touch tone telephone to call home and control X10 modules, and products which allow any Windows™ based PC to control X10 Modules.

Special products

For special installation requirements a range of accessory products are available including powerline filters for multiple installations in close proximity, RF and powerline repeaters for larger installations and interface modules to tie-in X10 control with third party security products.

Setting up the Dialer

Programming Phone Numbers

Note: you should program the console to call a friend, relative or neighbor who can then listen-in to your home to determine if there is a real problem. The person can then call the Police if necessary, or call you back to see if everything is fine. You should NOT program the console to dial the Police directly.

1. Set the console to INSTALL.
2. Press the PROG button.
3. Enter the first phone number that you want the console to call in the event of a problem.
4. Press the MEM button.
5. Press 1 to store the phone number in memory location 1.
Press PROG, enter second phone number, press MEM, 2.
Press PROG, enter third phone number, press MEM, 3.
Press PROG, enter fourth phone number, press MEM, 4.

Repeat the above process to change a phone number.

Note: if you only want to program one phone number, you should store this number in all four memory locations.

Storing a Voice Message

1. Set the console to INSTALL.
 2. Press the RECORD button.
The BUSY light turns on.
 3. Speak clearly into the microphone on the front of the console. You can record up to 15 seconds of speech. For example: "There is a burglary in progress at (address). Press 0 to listen-in."
After 15 seconds the BUSY light turns off.
 4. Plug the earphone into the jack on the side of the console.
 5. Set the console to RUN. The console plays back your message through the earphone so you can hear what it sounds like (it sounds better when played back over the telephone line).
 6. If you want to hear the message again, set console to INSTALL then back to RUN.
- Repeat above steps to change the message.



Using the Security System

Console Zone Indicators

The console displays the status of the first eight zones. These indicators can display four states, as follows:

Steady on - means that particular door or window is open.

Steady off - means that particular door or window is closed.

Slow Flashing - means that particular Door/Window Sensor or Motion Detector is reporting a problem, low battery for example.

Fast Flashing - means that particular Door/Window Sensor or Motion Detector reported a problem and the fault was bypassed, or the door or window is open and has been bypassed.

Battery Light - Indicates battery in the Console is low and needs replacing.

Armed Light - Indicates the unit is armed and ready to activate.

All Door/Window Sensors and Motion Detectors report in to the Console every 90 minutes. If the Console does not receive a signal from the sensor within four hours, it reports a problem with that sensor by slowly flashing the appropriate zone indicator. If you try to arm the system with a zone indicator flashing, the Console sounds a repetitive trouble alarm. Either press DISARM, correct the problem and press ARM again, or press BYPASS while the trouble alarm is sounding, then press ARM. The zone(s) with a problem will not be armed and the zone indicator(s) will flash rapidly. All other zones will arm.

If you bypass an open window and arm the system, and later close the window, that zone will now be armed.

Arming and Disarming the System

When you arm the system in the RUN1 or RUN2 mode, and open a door or window the following happens:

- A loud (95db) siren sounds for 4 minutes.
- Lights connected to Lamp Modules and Wall Switch Modules flash on and off.
- The automatic dialer calls the telephone numbers programmed into the console and plays back the recorded message.

When armed, RUN 1 and RUN 2 modes are the same - opening a door or window trips the alarm. When the system is in the RUN 2 mode and *not* armed, the console sounds a pleasant chime when you open a door or window, or when the motion detector senses motion. In RUN 1 mode there are no chimes.



Using the Security System

INSTANT Mode

Note: *The Key Chain Remote always arms the system in the INSTANT mode.*

1. If using the Handheld Remote, set its Delay switch to MIN.
2. Press ARM. The Console emits two tones and the ARMED indicator turns on.

Open a door or window, the alarm instantly trips, the siren sounds, lights connected to Lamp Modules and Wall Switch Modules flash on and off, and the dialer dials out.

3. Press DISARM to stop the siren. The lights remain on.
4. Press LIGHT OFF on the remote control to turn off lights connected to modules which you set to the same House Code and Unit Code as the Console.

DELAY Mode

1. Set the Delay switch on the Handheld Remote to MAX.
2. Press ARM on the remote. Lamps connected to Modules set to the same House Code and Unit Code as the Console turn on. The console chimes for 1 minute while you leave the house. Then you hear a beep signifying that the system is armed, and the lamps(s) turn off.

Open a door (that has its sensor set to MAX), The console gives a pre-alarm beep, and lamps connected to modules set to the same House Code and Unit Code as the Console turn on. After a delay of approximately 30 seconds the alarm sounds, Lamp and Wall Switch Modules flash, and the automatic dialer calls the first telephone number and plays back the recorded message.

3. Press DISARM to stop the siren. The lights remain on.

ARM HOME/ARM AWAY

The Handheld Remote lets you arm the system with or without Motion Detectors armed.

If you press ARM AWAY on the Handheld Remote, all Door/Window Sensors AND Motion Detectors will be armed.

If you press ARM HOME on the Handheld Remote, ONLY Door/Window Sensors will be armed. Motion Detectors will NOT be armed. This lets you arm the system at night without accidentally tripping the system yourself when you move around the house.

The MIN/MAX switch on the Handheld Remote lets you set it to arm the system with or without an exit/entry delay. When set to MIN everything in the system will arm and trip instantly. When set to MAX Motion Detectors and Door/Window Sensors will have a 1 minute exit and 30 sec. entry delay.

Arming Without a Remote

You can arm the system without using a Remote by pressing the ARM button on the Console. Arming this way will ALWAYS arm the system in the Delay mode.



Battery Information

General

X10 Door/Window Sensors, Motion Detectors and Security and Keychain remotes are designed to operate for approximately two years when fitted with alkaline batteries. Since operating conditions vary from installation to installation however, it is recommended that all batteries are replaced once a year.

Security Console

Battery backup

The battery in the Security Console is used as a backup when there has been a power failure. The battery provides approx. 20 hours of backup time provided the alarm has not been triggered.

While on battery backup, the console will continue to operate, and will sound the siren and dial out if the alarm is triggered. It will not, of course, flash the house lights or trigger Power Horn sirens.

If both the AC supply and the battery fails, the console will no longer dial out or sound the siren, and will lose its telephone numbers and recorded message.

Battery Replacement

Batteries can be replaced at any time, even while the unit is powered up. There is no special procedure for battery replacement.

Handheld and Keychain Remotes

Battery Replacement

Providing the batteries have not already failed, they may be replaced with fresh batteries without the need to reinstall the remote. After removing the old batteries fresh batteries must be fitted within 30 seconds to ensure that the security code is retained.

Once the batteries have been replaced, confirm that the remote is still logged in by arming the system. If it does not arm, the code has been lost and you will need to proceed as described below.

If the batteries have failed completely, the security code will have been lost. To ensure proper system integrity it is recommended that the console is cleared and all sensors and remotes reinstalled following the procedures in the *Installation* chapter.



Battery Information

Door/Window Sensors and Motion Detectors

Battery Replacement

If any of the Console's zone indicators flash slowly, the Motion Detector or Door/Window Sensor for that zone has not reported in during the last four hours. This is most likely caused by a dead battery.

As with the remotes, as long as the batteries have not completely failed they may be replaced with fresh batteries without the need to reinstall the sensor. After removing the old batteries fresh batteries must be fitted within 30 seconds to ensure that the security code is retained.

Testing the Door/Window Sensor

Once the batteries have been replaced, the Door/Window Sensor should be tested as follows:

- Set the slide switch on the Security Console to RUN2.
- Open the door or window with the sensor attached. The console chimes to acknowledge and the zone LED lights.

Testing the Motion Sensor

To test the Motion Detector:

- Set the slide switch on the Security Console to RUN2.
- Press the TEST button on the back of the Motion Detector. The console chimes to acknowledge.

Clearing Remotes & Sensors from the Console

If you suspect that a neighboring system is causing false alarms, or if you need to reinstall remotes, Door/Window Sensors and Motion Detectors for any other reason, you can clear all sensors and remotes from the console's memory by unplugging it and removing the battery.

Note: You will need to reprogram telephone numbers and recorded message after doing this.

Troubleshooting

PROBLEM	SOLUTION
If the system does not arm.	<ul style="list-style-type: none"> Check that the Console's slide switch is set to RUN1 or RUN2. Check that the battery indicator on the Remote turns on when you press ARM. Replace the battery and reinstall the Remote if necessary.
If a zone indicator flashes slowly.	<p>One of the sensors/motion detectors has not reported in, in the last 4 hours.</p> <p>Check that the battery in the sensor/motion detector is good.</p> <p>If you need to arm the system and want to ignore a sensor/motion detector which is not functioning:</p> <ol style="list-style-type: none"> Press ARM on the Remote control. You hear a repetitive trouble alarm to alert you that there is a problem. While the trouble alarm is sounding, press BYPASS on the Console. The zone indicator flashes rapidly. <p>Then press ARM on the Remote. The problem zone is not protected but all other zones are armed.</p> <p>Note: if you bypass an open window and arm the system (as described above) and later close the window, that zone will now arm and its zone light will stop flashing.</p>
If a zone indicator flashes rapidly.	The BYPASS button was pressed to arm the system while a sensor/motion detector was reporting a problem

Troubleshooting

PROBLEM	SOLUTION
If you hear a repetitive trouble alarm when you try to arm the system, and it does not arm.	<p>Check the zone indicators. If a door or window is open, its zone indicator is on. If there is a problem with a Sensor or Motion Detector, its zone indicator flashes slowly. Either:</p> <ul style="list-style-type: none"> Press DISARM. Check each Door/Window Sensor is working properly and that no doors or windows are open. Then arm the system. <p>Or:</p> <ul style="list-style-type: none"> While the trouble alarm is sounding, press BYPASS to override the problem zone (its zone indicator then flashes rapidly). Then arm the system again.
If the alarm trips when you enter the house before you have time to disarm it.	<p>Arm the system in the delay mode.</p> <p>To do this: Set the MIN/MAX switch on the entrance Door/Window Sensor to MAX and the Handheld Remote to MAX and then press ARM.</p>
Lights will not turn on or off from the LIGHT ON or LIGHT OFF buttons on the Remote.	<ul style="list-style-type: none"> Be sure you set House and Unit Codes on the module(s) to the same letter and number as set on the Console. Be sure the light you are trying to control has its on/off switch in the on position. Be sure its bulb is good. Plug the module into another outlet near the Console. Check that the battery indicator on the Remote comes on when you press a button. Replace battery and reinstall remote if necessary.



Troubleshooting

PROBLEM	SOLUTION
You open a door or window and the alarm does not trip.	<ul style="list-style-type: none"> • Check that the system is armed. • Check that the console's slide switch is set to RUN1 or RUN2. • Check to see if the alarm trips when you press TEST on the Door/Window Sensor. • If the alarm does not trip when you press TEST, check that the indicator on the sensor comes on when you press TEST. <p>If the indicator does not come on, replace the battery and reinstall the sensor if necessary.</p>
If appliances turn off during an alarm.	<p>The system flashes lights by repetitively transmitting all lights on/all units off.</p> <p>Any appliance modules set to the same House Code as the Console will therefore turn off.</p>
If you do not hear a beep from the Console when you press ARM to install a Remote.	<p>Check to see if you can arm the system when the Console is in the RUN mode. If you can, the Remote is already installed and no further action is necessary. If not:</p> <ul style="list-style-type: none"> • Check that the Console's slide switch is set to INSTALL. • Re-initialize the remote (see page 7 & 8).

Troubleshooting

PROBLEM	SOLUTION
If you do not hear a beep from the Console when you press TEST to install a Door/Window Sensor or Motion Detector.	<p>With the Console in the RUN 2 mode, check that it chimes when you press TEST on the sensor/motion detector. If it does, then the sensor/motion detector is already installed and no further action is necessary. If not:</p> <ul style="list-style-type: none"> • Check that the console's slide switch is set to INSTALL. • Change the code on the sensor/motion detector (see Setting Up Door/Window Sensors and Setting Up Motion Detectors).
If the battery indicator on the Console is on.	Replace the console's battery. A 9V alkaline battery provides approximately 20 hours of backup. Replace battery at least once a year.
If you lose your remote control.	Reinstall your complete system to prevent someone else from using the lost remote control.
If the system Arms or Disarms by itself	A neighbor may have a compatible system. Reinstall the complete system so that it chooses different RF codes.
If the red light on the Handheld Remote stays on during installation.	Press CODE then press ARM . If it still stays on, remove the battery, wait a few seconds, then replace the battery. Press CODE then press ARM again.



Troubleshooting

PROBLEM	SOLUTION
If the armed indicator is flashing.	This indicates that there has been an intrusion. Also, if a zone indicator is on, this indicates which zone was violated. To turn the zone indicator off, and stop the armed indicator from flashing press ARM then DISARM on the Console or remote control. If a zone indicator is not lit, the violated zone may have been one of the second eight zones. Press BYPASS to see which zone was tripped.
If the PowerHorn does not trip when the alarm trips.	<ul style="list-style-type: none"> • Be sure you set the dials on the PowerHorn to the same House Code and Unit Code as set on the Console. • Plug the PowerHorn into another outlet near the Console.
The Motion Detector causes false alarms.	<ul style="list-style-type: none"> • All brands of motion detectors sense motion by detecting a change in temperature, therefore do not place the detector near any sources of heat such as over a heating vent or an air conditioner. • Do not place in a direct source of bright light, such as sunlight. • Do not place near cellular telephones or microwave ovens.



Troubleshooting

Special Notes

Intercom Systems

Intercom systems which send voice signals over existing electrical wiring may interfere with the ability to control modules from your X10 security system with the intercom in use. If the intercom system has its own separate wiring it will not cause a problem.

Arming

The ARM button on the Console arms the system in the delay mode only. Use a Remote if you want to arm the system in the instant (min) mode.

Outdoor infrared Motion Detector

The PR511 Outdoor Motion Detector will not trigger the X10 security system. It can, however, control the same lights that the security system controls.



Warranty

ONE YEAR LIMITED WARRANTY

X10 (USA) INC. (X10) WARRANTS ITS PRODUCTS TO BE FREE FROM DEFECTIVE MATERIAL AND WORKMANSHIP FOR A PERIOD OF ONE (1) YEAR FROM THE ORIGINAL DATE OF PURCHASE AT RETAIL. X10 AGREES TO REPAIR OR REPLACE, AT ITS SOLE DISCRETION, A DEFECTIVE X10 PRODUCT IF RETURNED TO X10 WITHIN THE WARRANTY PERIOD AND WITH PROOF OF PURCHASE.

IF SERVICE IS REQUIRED UNDER THIS WARRANTY:

1. RETURN THE DEFECTIVE UNIT POSTAGE PREPAID TO:
X10 (USA) INC., 91 RUCKMAN RD., CLOSTER, NJ 07624
2. ENCLOSE A CHECK FOR \$4.00 TO COVER HANDLING AND RETURN POSTAGE.
3. ENCLOSE A DATED PROOF OF PURCHASE.
4. ENCLOSE YOUR COMPLETED WARRANTY CARD.
5. X10 IS NOT RESPONSIBLE FOR SHIPPING DAMAGE. UNITS RETURNED SHOULD BE PACKED CAREFULLY.

THIS WARRANTY DOES NOT EXTEND TO ANY X10 PRODUCTS WHICH HAVE BEEN SUBJECT TO MISUSE, NEGLIGENCE, ACCIDENT, INCORRECT WIRING OR TO USE IN VIOLATION OF OPERATING INSTRUCTIONS FURNISHED BY US, NOR EXTEND TO ANY UNITS ALTERED OR REPAIRED FOR WARRANTY DEFECT BY ANYONE OTHER THAN X10. THIS WARRANTY DOES NOT COVER ANY INCIDENTAL OR CONSEQUENTIAL DAMAGES AND IS IN LIEU OF ALL OTHER WARRANTIES EXPRESSED OR IMPLIED AND NO REPRESENTATIVE OR PERSON IS AUTHORIZED TO ASSUME FOR US ANY OTHER LIABILITY IN CONNECTION WITH THE SALE OF OUR PRODUCTS.

SOME STATES DO NOT ALLOW LIMITATIONS ON HOW LONG AN IMPLIED WARRANTY LASTS, AND/OR THE EXCLUSION OR LIMITATION OF INCIDENTAL OR CONSEQUENTIAL DAMAGES SO THE ABOVE LIMITATIONS AND EXCLUSIONS MAY NOT APPLY TO THE ORIGINAL CUSTOMER. THIS WARRANTY GIVES YOU SPECIFIC RIGHTS AND YOU MAY ALSO HAVE OTHER RIGHTS WHICH VARY FROM STATE TO STATE.



Notes





X10 (USA) INC.,
91 RUCKMAN RD.,
CLOSTER, NJ 07624
WWW.X10.COM

DS7000-4/99DR
Supervised Security System

