

# WINEGARD®

## Pinnacle® RV Digital Satellite System Model RD-9946

### Installation Manual

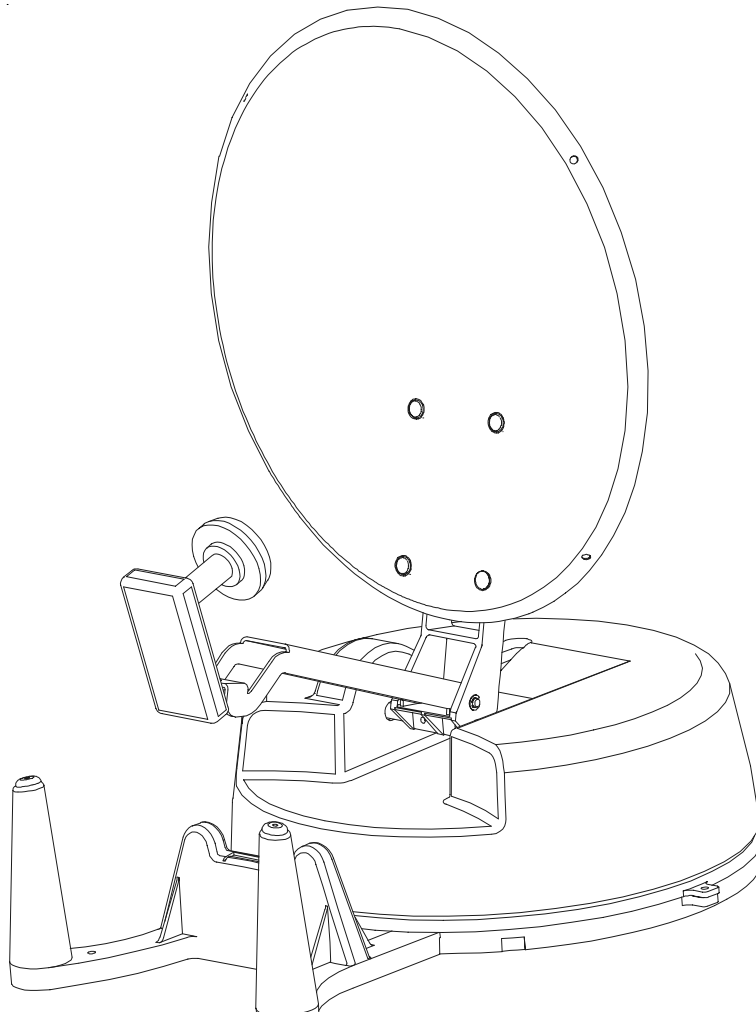

U.S. Patent No.  
5,532,710

**WARNING!**  
BEFORE ATTACHING OR REMOVING ANY CABLE/WIRES ON  
BACK OF POSITIONER, UNPLUG UNIT FROM 117 VAC SOURCE.

## IMPORTANT SAFEGUARDS

**WARNING:** THIS SYSTEM HAS BEEN ADJUSTED AT THE FACTORY FOR OPTIMUM PERFORMANCE. BEFORE MAKING ANY ADJUSTMENTS, CONTACT WINEGARD CUSTOMER SERVICE.

**WARNING:** TO REDUCE RISK OF FIRE OR ELECTRICAL SHOCK,  
DO NOT EXPOSE TO RAIN OR MOISTURE.  
(Not applicable to mount and antenna)

<b>CAUTION</b> <b>RISK OF ELECTRIC SHOCK</b> <b>DO NOT OPEN</b>		<b>Dangerous voltage</b> inside enclosure  <b>Refer to operating, maintenance</b> and safeguard literature accompanying unit.
<b>CAUTION:</b> TO REDUCE RISK OF ELECTRICAL SHOCK, DO NOT REMOVE COVER, NO USER-SERVICEABLE PARTS INSIDE. REFER SERVICING TO QUALIFIED PERSONNEL		

1. All the safety and operating instructions should be read before the appliance is operated.
2. The safety and operating instructions should be retained for future reference.
3. All warnings on the appliance and in the operating instructions should be adhered to.
4. All operating and use instructions should be followed.
5. Unplug this video or audio product from the wall outlet before cleaning. Do not use liquid cleaners or aerosol cleaners. Use a damp cloth for cleaning.
6. Do not use attachments not recommended by the video product manufacturer as they may cause hazards.
7. Do not use this video product near water - for example, near a bath tub, wash bowl, kitchen sink, or laundry tub, in a wet basement, or near a swimming pool, and the like.
8. If slots, holes and openings are located in the housing, they are provided for ventilation and to ensure reliable operation of the video product and to protect it from overheating. These openings should never be covered. The openings should never be blocked by placing the video product on a bed, sofa, rug, or other similar surface. This video product should never be placed near or over a radiator or heat register. This video product should not be placed in a built-in installation such as a bookcase or rack unless proper ventilation is provided or the manufacturer's instructions have been adhered to.
9. This video product should be operated only from the type of power source indicated in electrical rating printed on the appliance or power supply.
- 10A. If the appliance is equipped with a polarized alternating-current line plug (a plug having one blade wider than the other) this plug will fit into the power outlet only one way. This is a safety feature. If you are unable to insert the plug fully into the outlet, try reversing the plug. If the plug should still fail to fit, contact an electrician to replace your obsolete outlet. Do not defeat the safety purpose of the polarized plug.
- 10B. If the appliance is equipped with a 3-wire grounding-type plug, a plug having a third (grounding) pin, this plug will only fit into a grounding-type power outlet. This is a safety feature. If you are unable to insert the plug into the outlet, contact an electrician to replace your obsolete outlet. Do not defeat the purpose of the grounding-type plug.
11. Power-supply cord should be routed so that it is not likely to be walked on or pinched by items placed upon or against it, paying particular

attention to cord at plug, convenience receptacle and the point where cord exits from the appliance.

12. If an outside antenna or cable system is connected to this video product, be sure system is grounded so as to provide some protection against voltage surges and built-up static charges. Proper method is shown below.

### EXAMPLE OF ANTENNA GROUNDING AS PER NATIONAL ELECTRICAL CODE INSTRUCTIONS

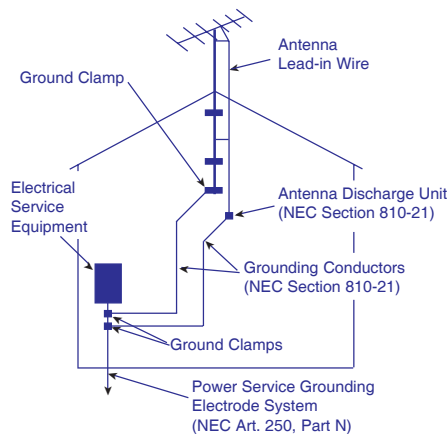

### NEC - NATIONAL ELECTRICAL CODE

13. An outside antenna system should not be located in the vicinity of overhead power lines or other electric light or power circuits, or where it can fall into such power lines or circuits. When installing an outside antenna system, extreme care should be taken to keep from touching such power lines or circuits as contact with them might be fatal.
14. For added protection for this video product during a lightning storm, or when it is left unattended and unused for long periods of time, unplug it from the wall outlet and disconnect the antenna or cable system.
15. Do not overload wall outlets and extension cords as this can result in a risk of fire or electric shock.
16. Never push objects of any kind into this video product through openings as they may touch dangerous voltage points or short-out parts that could result in a fire or electric shock. Never spill liquid of any kind on the video product.

17. Do not attempt to service this video product yourself as opening or removing covers may expose you to dangerous voltage or other hazards. Refer all servicing to qualified service personnel.

18. Unplug this video product from the wall outlet and refer servicing to qualified service personnel under the following conditions:

- a. When the power supply cord or plug is damaged.
- b. If liquid has been spilled or objects have fallen into the video product.
- c. If the video product, except for antenna mounted preamplifiers and downconverters, has been exposed to rain or water.
- d. If the video product does not operate normally by following the operating instructions. Adjust only those controls, when provided, that are covered by the operating instructions. An improper adjustment of other controls may result in damage that will often require extensive work by a qualified technician to restore the video product to its normal operation.
- e. If the video product has been dropped or the housing has been damaged.
- f. When the video product exhibits a distinct change in performance - this indicates a need for service.

19. When replacement parts are required, be sure the service technician has used replacement parts specified by the manufacturer or have the same characteristics as the original part. Improper substitutions may result in fire, electric shock or other hazards.

20. Upon completion of any service or repairs to this video product, ask the service technician to perform safety checks to determine that the video product is in proper operating condition.

21. Note to CATV system installer: This reminder is provided to call the CATV system installer's attention to Art. 820-40 of the NEC that provides guidelines for proper grounding and, in particular, specifies that the cable ground shall be connected to the grounding system of the building, as close to the point of cable entry as possible.

22. This product should be mounted to a wall or ceiling only as recommended by the manufacturer.

23. The product should be situated away from heat sources such as radiators, heat registers, stoves or other products (including amplifiers) that produce heat.

## Table Of Contents

---

Installation Requirements .....	4
Installation .....	6
RD-9901 Remote Wall Plate Control Installation (optional) .....	14
RD-9911 Warning Device Installation (optional) .....	15
Cable Roof-thru Plate Installation .....	16

## Unpacking/Inventory

---

After unpacking system verify that no parts have broken, bent etc., and that you have the following items:

1	Positioner .....	2750225
1	Ignition Wire Harness .....	2753254
1	Antenna Support Assembly .....	2762830
1	Mount Assembly .....	2762832
1	Mount Base Assembly .....	2762831
1	Antenna/Feed Assembly .....	2762833
1	35' Wire Harness .....	2753248
4	10-31 Washer .....	2160349
4	10-32 x 1-1/8" Hex Head Screw .....	2160170
4	Black Cable Ties .....	2190105
1	13 Pin Connector.....	2340149
1	FS-8100 Male to Male F-connector ....	2360060
1	18" RG-6 Coax Cable w/connectors ...	2753059
1	3 oz. Silicone Sealant.....	2460007
1	Dual cable roof-thru plate .....	3200159
10	#10 x 1" Screw .....	2160178

## FCC PART 15 STATEMENTS

**NOTE:** This equipment has been tested and found to comply with the limits for a Class B digital device, pursuant to Part 15 of the FCC Rules. These limits are designed to provide reasonable protection against harmful interference in a residential installation. This equipment generates, uses and can radiate radio frequency energy and, if not installed and used in accordance with the instructions, may cause harmful interference to radio communication. However, there is no guarantee that interference will not occur in a particular installation. If this equipment does cause harmful interference to radio or television reception, which can be determined by turning the equipment off and on, the user is encouraged to try to correct the interference by one or more of the following measures:

- Reorient or relocate the receiving antenna.
- Increase the separation between the equipment and receiver.
- Connect the equipment to an outlet on a circuit different from that to which the receiver is connected.
- Consult the dealer or an experienced radio/TV technician for help.

**CAUTION:** Any changes or modifications to this equipment not expressly approved by Winegard Company may void the user's authority to operate this equipment.

# Installation Requirements

To install the Winegard Pinnacle® RV Satellite System, Model RD-9946, you will need the following:

- A. An area on the RV/coach large enough to allow free movement of the antenna/mount. See Figures 1, 2 and 3 for mount/antenna clearance. **If you do not have an area large enough, you can build up the mount so that it will clear ALL obstructions.**
- B. A roof plan of your RV/coach showing the rib locations. This is required so that you may anchor the mount securely. Figure 4 shows bolt hole pattern and size.
- C. **You must level your RV/coach before you proceed to install the mount. This is required to properly level the mount on the roof.**

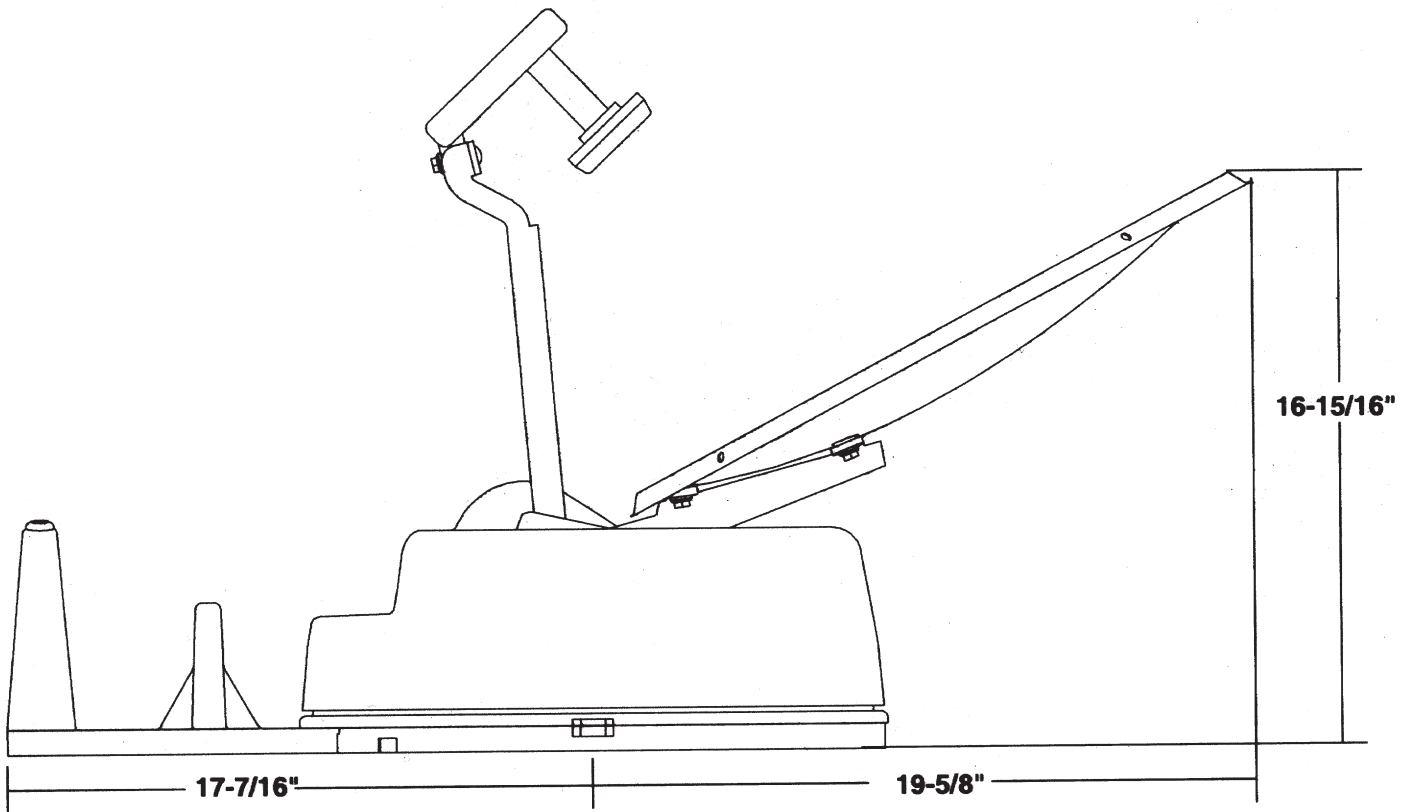

Figure 1

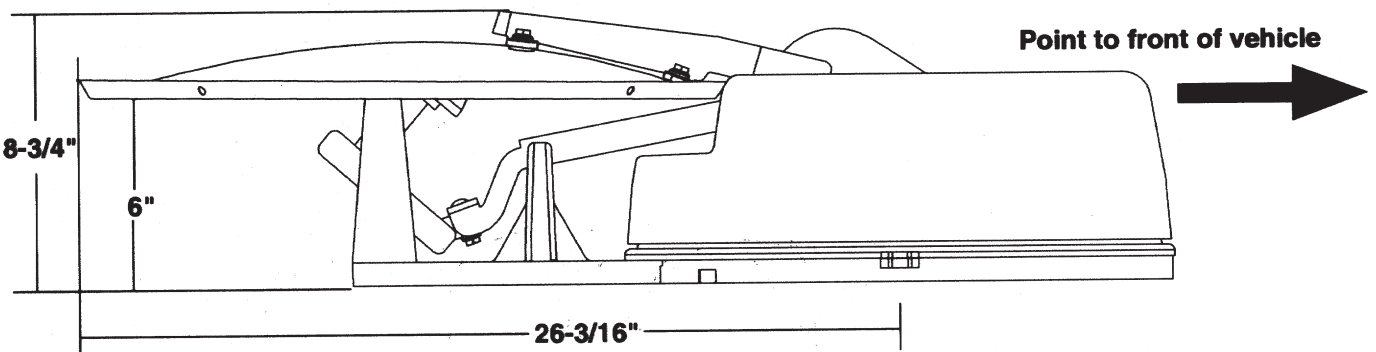

Figure 2

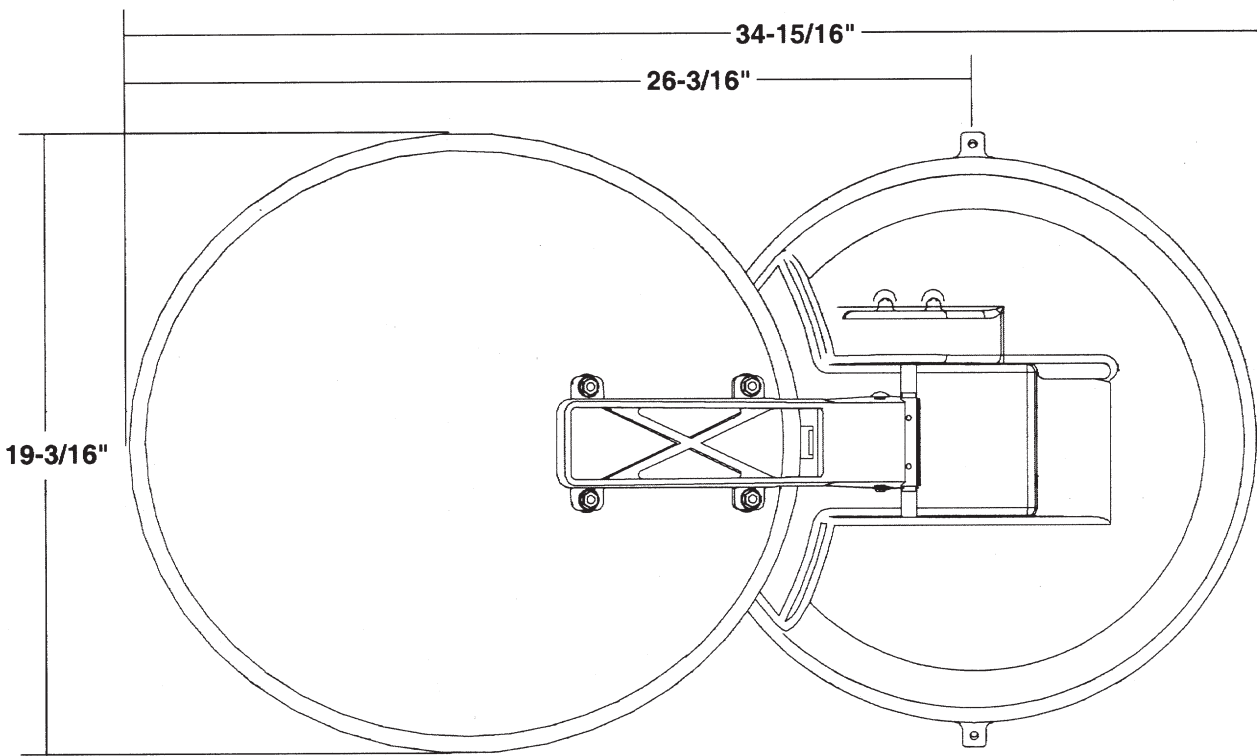

Figure 3

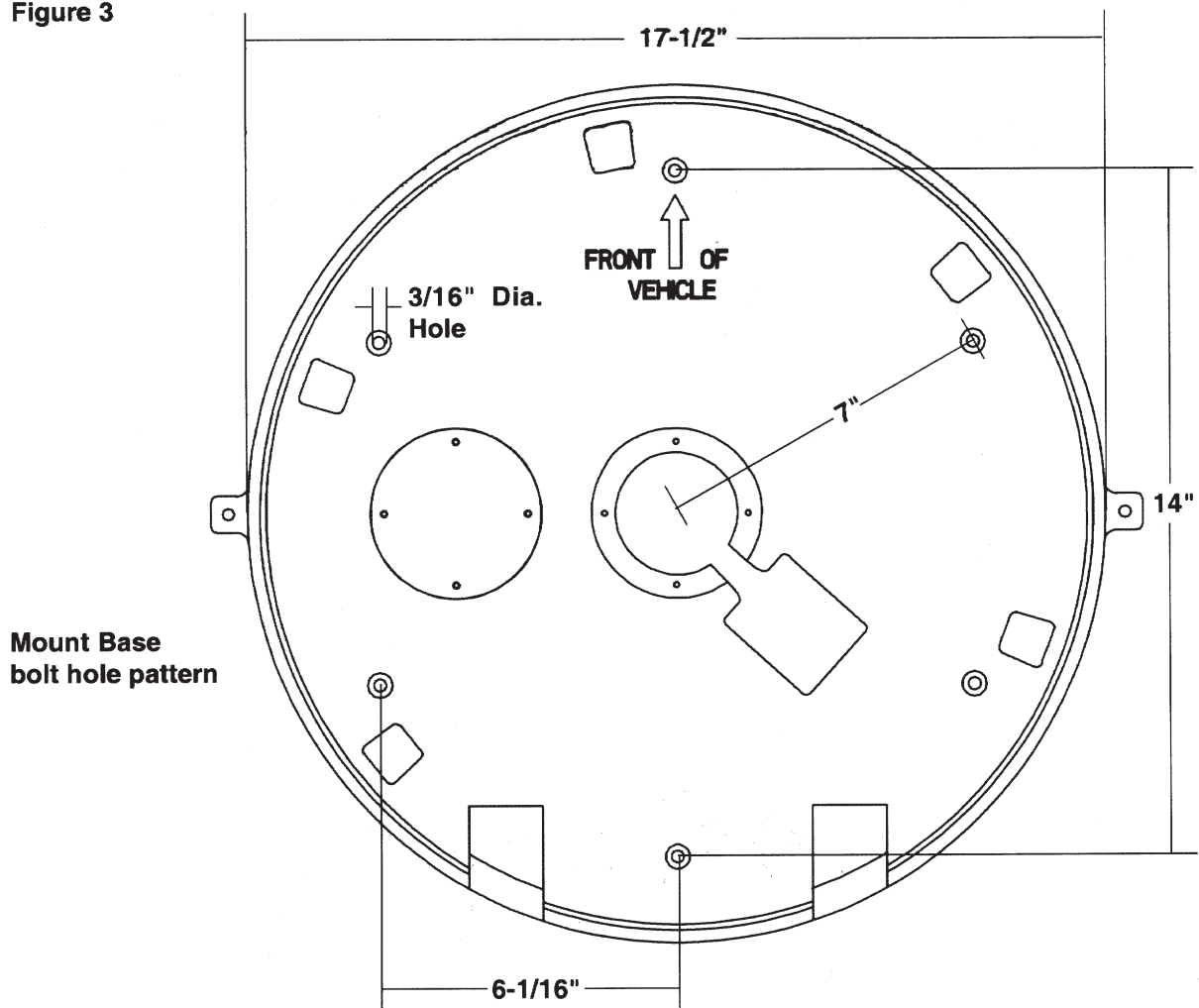

Figure 4

# Installation

**NOTE:** If your RV/coach has been prewired for the Winegard Pinnacle RV Satellite System, RD-9946 proceed to step 2.

1. Your RV/coach design (i.e. flat roof, rounded roof, obstructions, etc.) will determine how and where you mount the system. You have two options for running the control cable; Option A: Run the cable straight down from the mount (see Figure 5) or Option B (see page 15, cable roof-thru plate installation): Snap the knockouts on the base and run the cable to a different entry point (refrigerator vent, etc.)\*. Figure 6 shows the knock out location on the base..

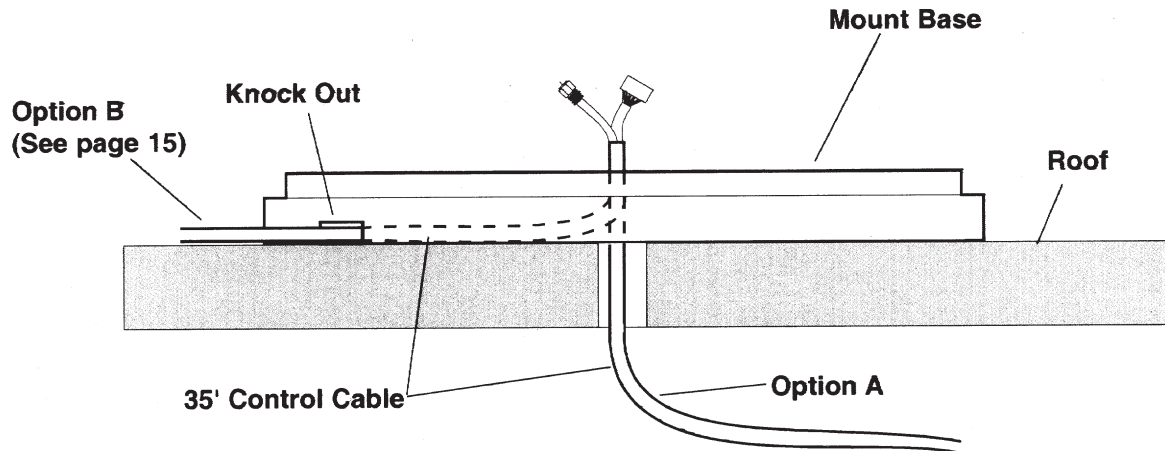

Figure 5

\*Use pliers or hammer and flat screwdriver to remove knockouts

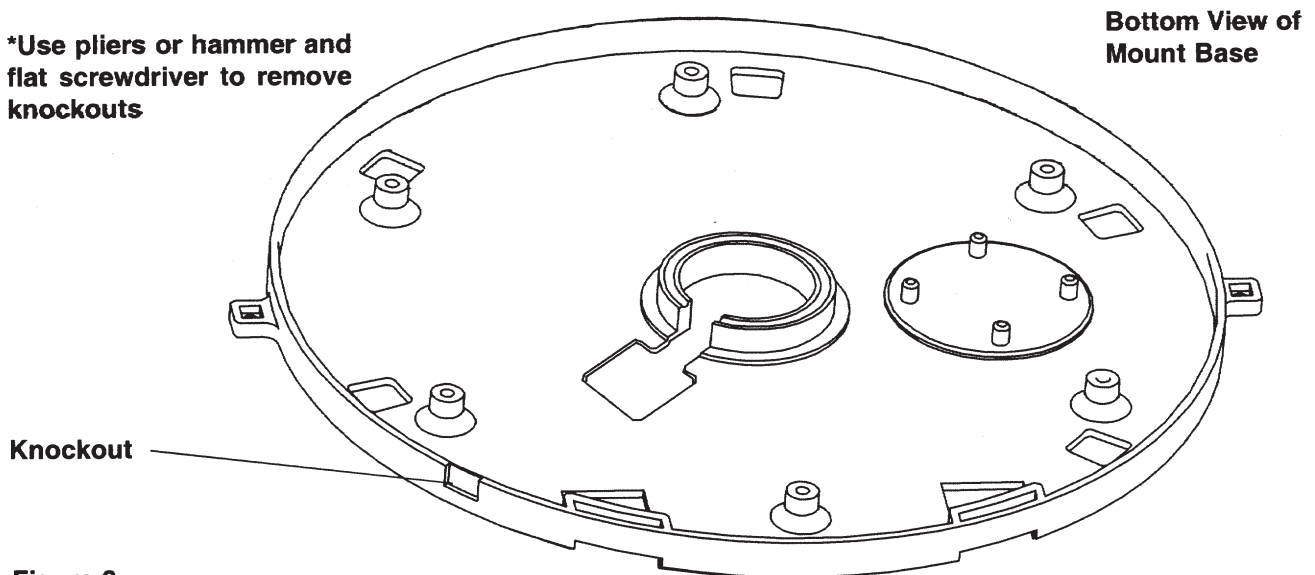

Figure 6

2. After determining how you want to run the control cable, you are ready to attach the mount base to the roof. Make sure the location you choose has adequate clearances; review Figures 1, 2 and 3. Figure 4 shows bolt hole pattern.

3. Attach mount base to roof (**DO NOT BEND MOUNT BASE!**). Remember to caulk all mounting holes and cable entry, see Figure 7. If running cable out through knockouts secure cable against whipping.

4. Make cable connections from 35' cable to mount assembly. Use FS-8100 to make coax connection. Use electrical tape to seal connections (Scotch® 33+ or 88 electrical tape is recommended). See Figure 7.

Seal connections from point to point indicated

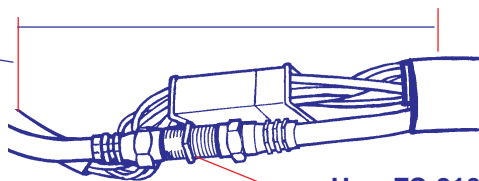

Use FS-8100 connector to connect coax cables

Figure 7

5. Set mount assy. onto the mount base, making sure to coil cables under mount base. Make cables do not make contact with the azimuth limit switches on the bottom of the mount assembly, Figure 9. Rotate mount assembly counterclockwise to lock mount onto mount base. Secure mount assy. to mount base using screws provided. See Figure 8.

Mount Assembly

(2) 10-32 x 5/8" Hex Head Screw

(2) 10-32 Washer

Set mount assy. onto the mount base and rotate so that it locks into place. Secure mount assy. to mount base with screws provided.

Point to front of vehicle

Caulk all mounting holes and cable entry.

DO NOT CAULK MOUNT BASE RING

Coil cables under mount base. Make sure cables do not make contact with the limit switches on the bottom of the mount assembly.

Mount Base

Antenna Support

Antenna Support mounting hole(s) 1/4" dia.

Figure 8



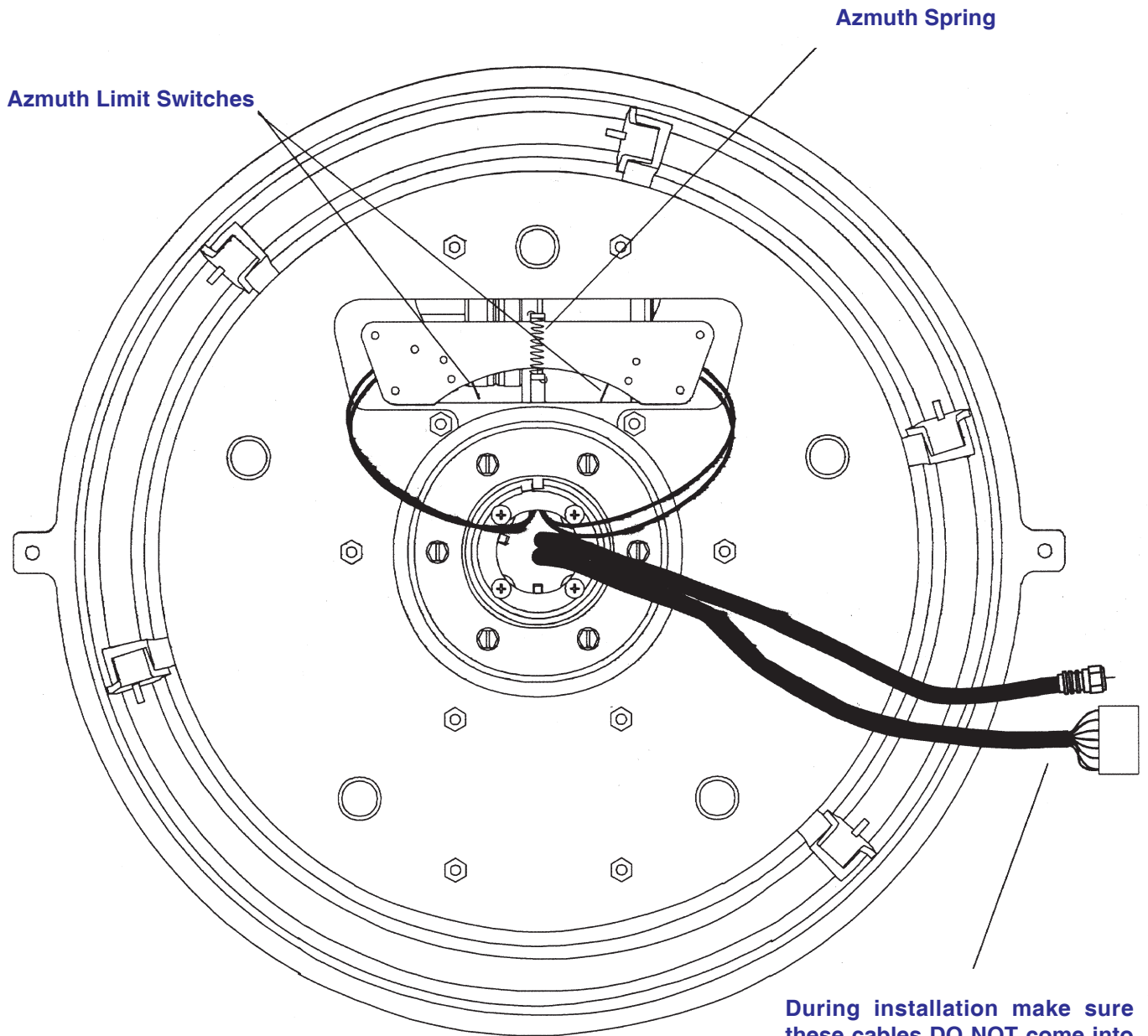

Azimuth Spring

Azimuth Limit Switches

During installation make sure these cables DO NOT come into contact with the azimuth spring of limit switches.

Figure 9



6. Attach coax cable from antenna assy. to jack on mount, see Figure 10. **Make sure to feed coax cable under the shaft.** Slide weather boot over boot collar.

7. Attach antenna/feed assembly to mount with (2) 10-32 x 1-1/8" screws and washers provided, see Figure 10. (Torque: 6 ft. lbs.)

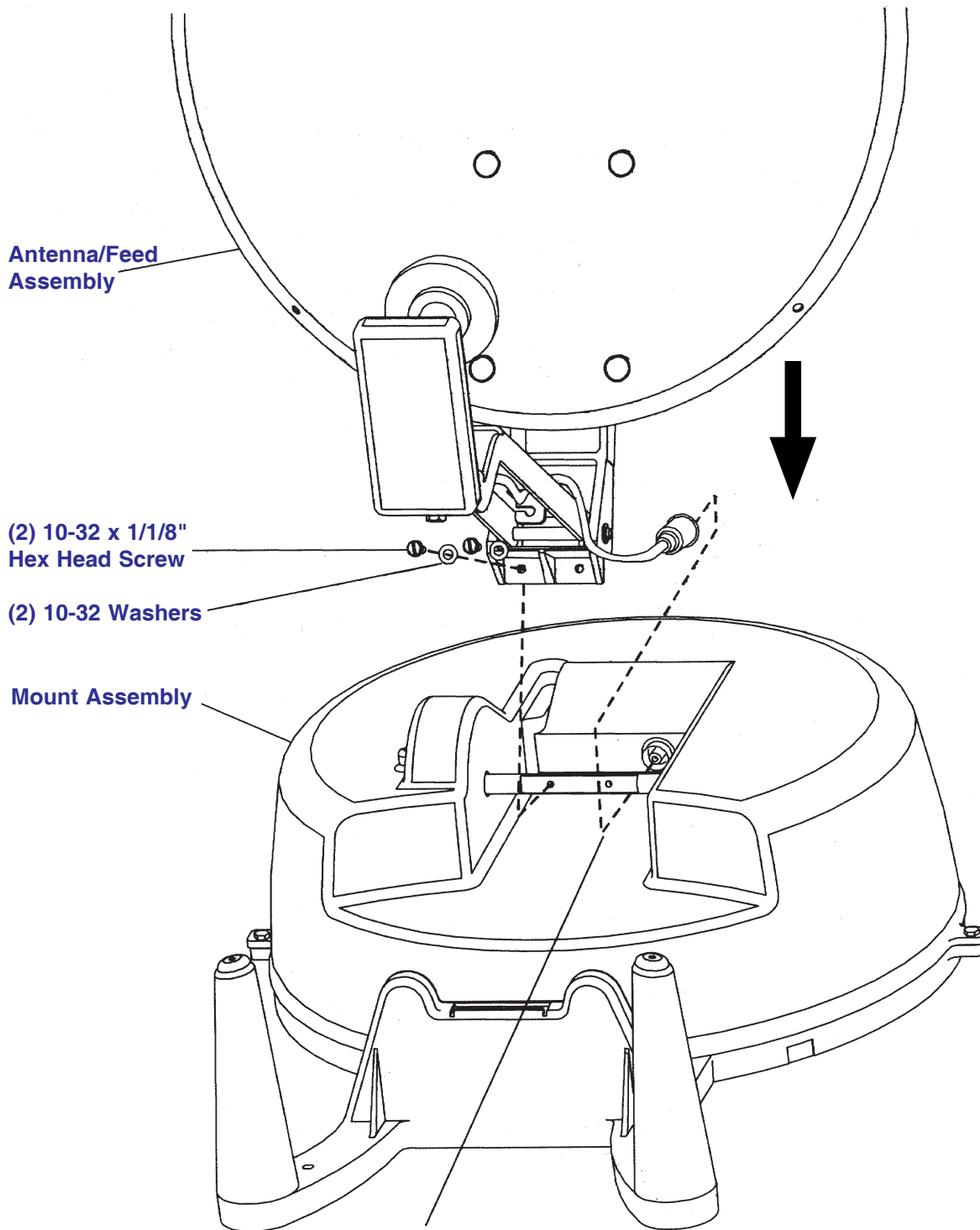

Figure 10

Feed coax under shaft.

8. After feeding cable to where you are going to install the positioner, strip 3/8" insulation off all wires in the 13 cable bundle.

9. Attach wires as shown in Figure 11 to the 13 pin connector supplied. Double check that wires will not pull out and that wire colors are correct.

**NOTE:** The first color is the primary color of the wire. Example; Red/White, means that the wire is red with a white stripe.

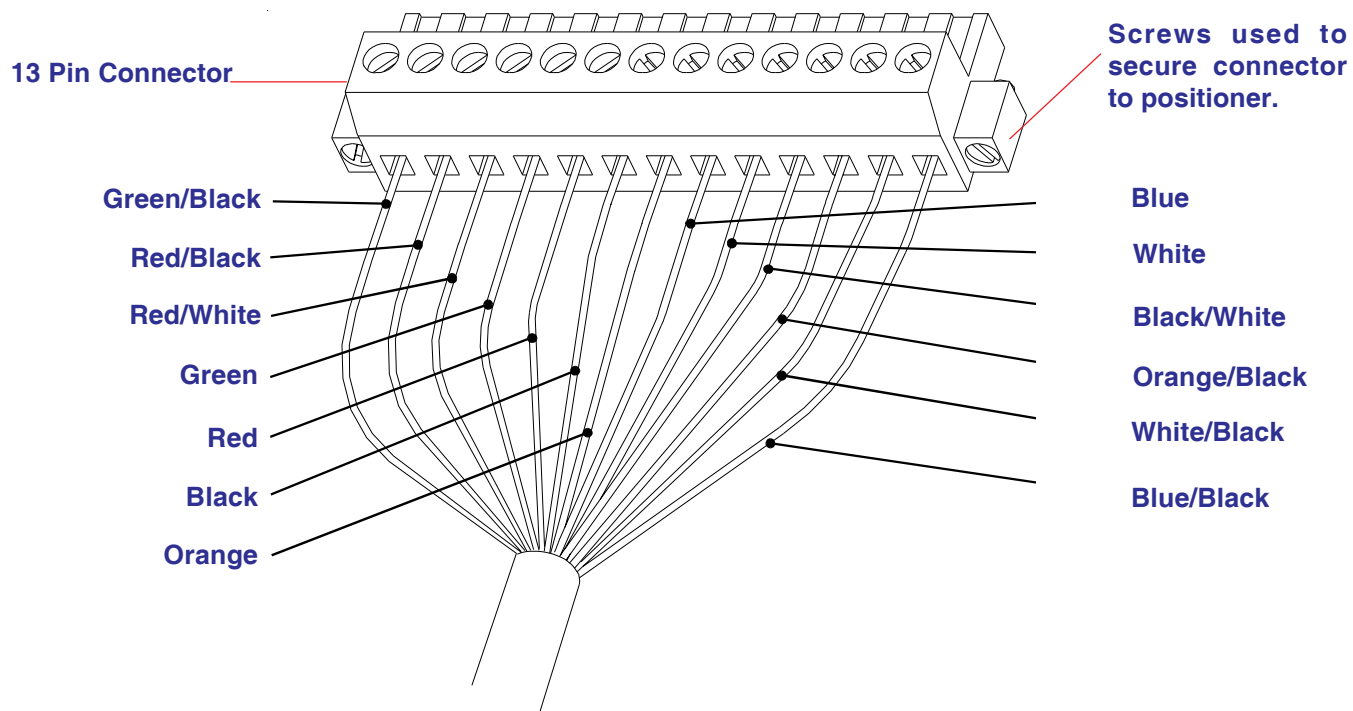

Figure 11

10. You are now ready to connect the mount to the positioner and the positioner to the receiver, see Figures 12 and 13. Make sure there is adequate ventilation. The positioner and the receiver produce heat.

**NOTE:** When connecting the 13 pin connector to the rear of positioner make sure to secure connector to positioner using the screws on the connector.

**CAUTION**  
**DO NOT CONNECT EITHER THE POSITIONER OR RECEIVER TO AC POWER UNTIL ALL CONNECTIONS HAVE BEEN MADE. BOTH UNITS ARE ON AS SOON AS THEY ARE CONNECTED TO POWER.**

Connect 75 ohm coaxial cable to SATELLITE IN jack on receiver.

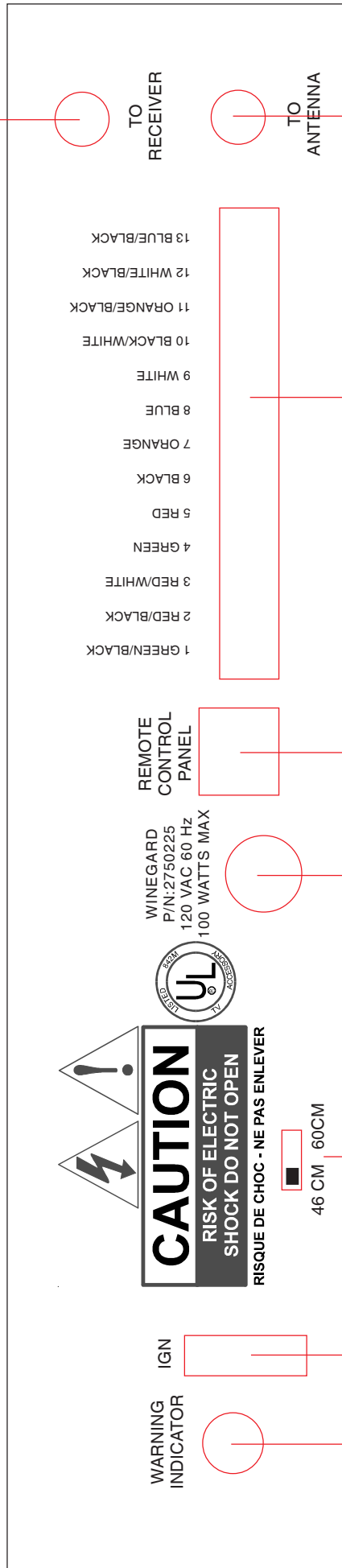

Connect 75 ohm coaxial cable from antenna.

Connect 13 pin connector here, making sure wire colors match. Secure connector to positioner with screws molded into connector.

After all other connections are made connect AC power cord to 120 VAC outlet.

Make sure switch is in the 46CM position. Switch removed 2/23/98.

Optional RD-9911 Warning Device Refer to Figure 15, Page 14 for operation and installation.

**SILVER** Connect to vehicle ground.

**GOLD** Connect to ignition +12 VDC.

This connection is optional. If used antenna will be put into travel position whenever the ignition is turned ON and there is AC power to the positioner.

Optional RD-9901 Remote Control Wall Plate. Connected by 25' telephone-type wire with modular plug-in connections.

Figure 12

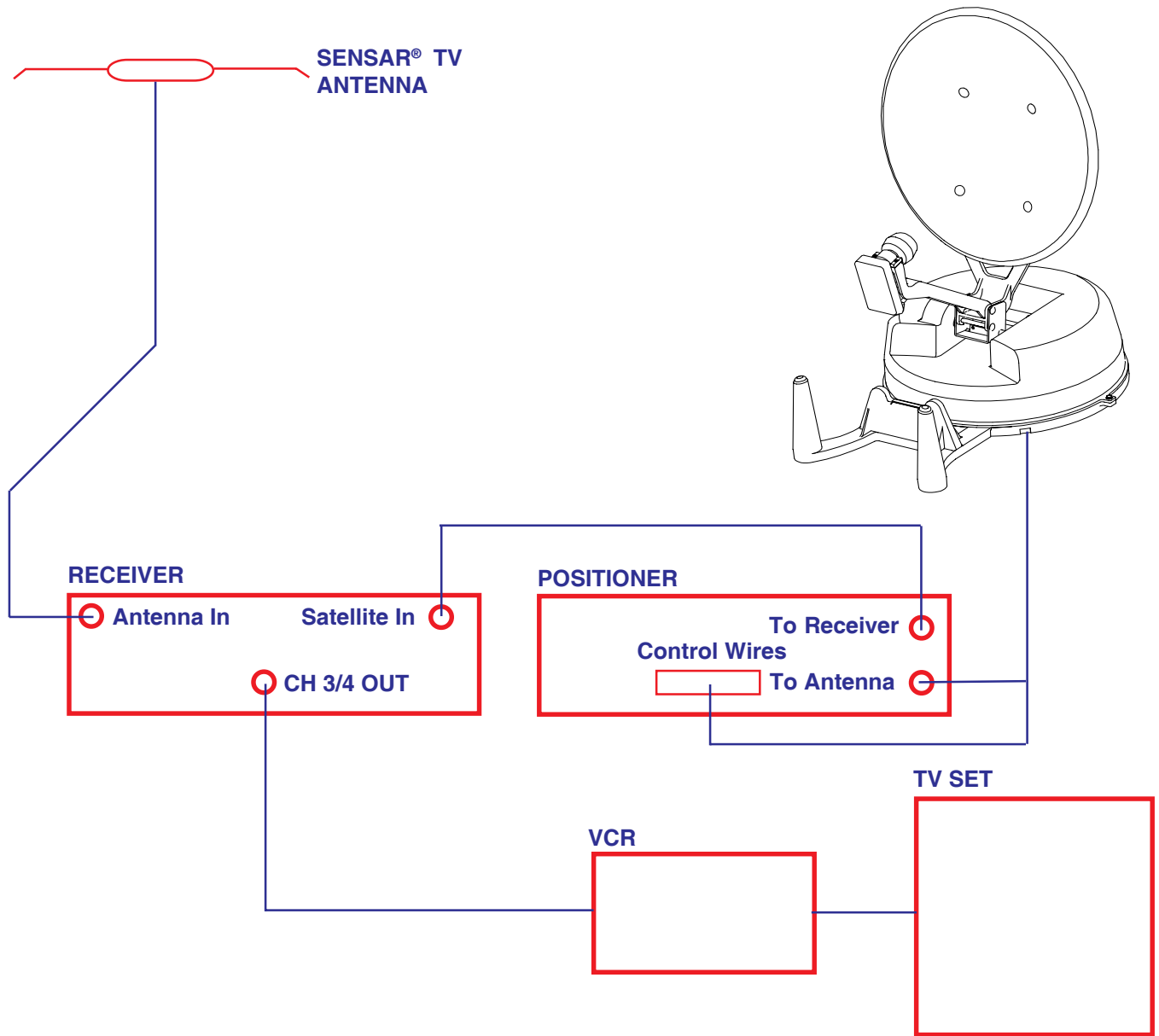

Figure 13

**NOTE: All commands will be shown in bold with brackets, example [SELECT A].**

11. Plug positioner into AC receptacle.

12. Press **[UP/DOWN]** arrow until you get **Park** displayed on positioner display. See Figure 14.

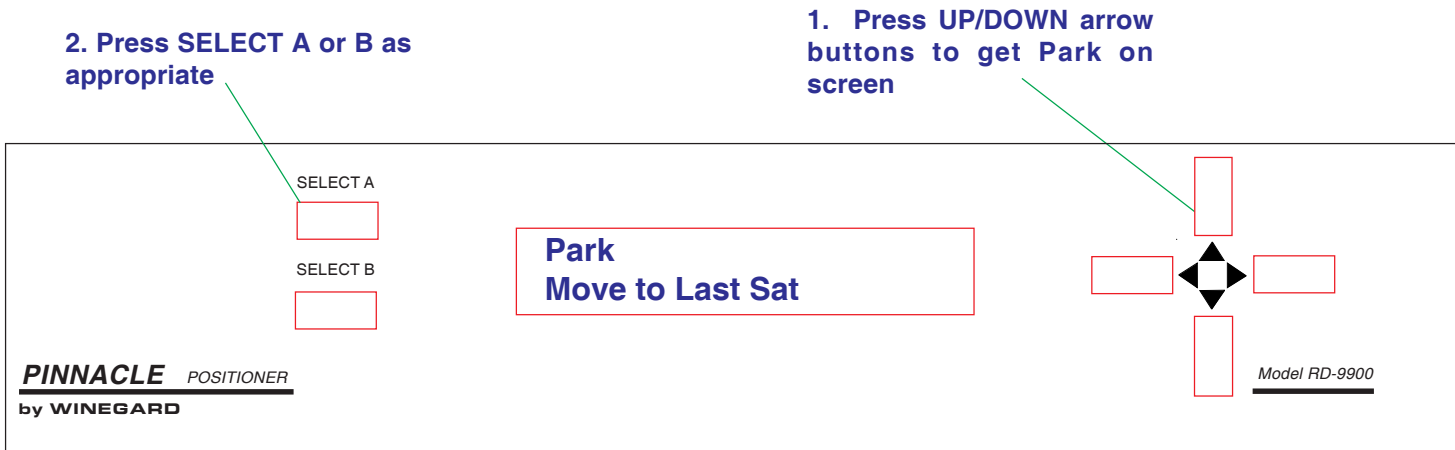

Figure 14

13. Press **[SELECT A or B] Park** to put antenna into park (travel) position. See Figure 14. The positioner will display **Collapsing System** while antenna is moving to travel position.

14. Verify that antenna is in the travel position (see Figures 2 and 3) when **Collapsing System** is replaced with normal menu, Figure 15.

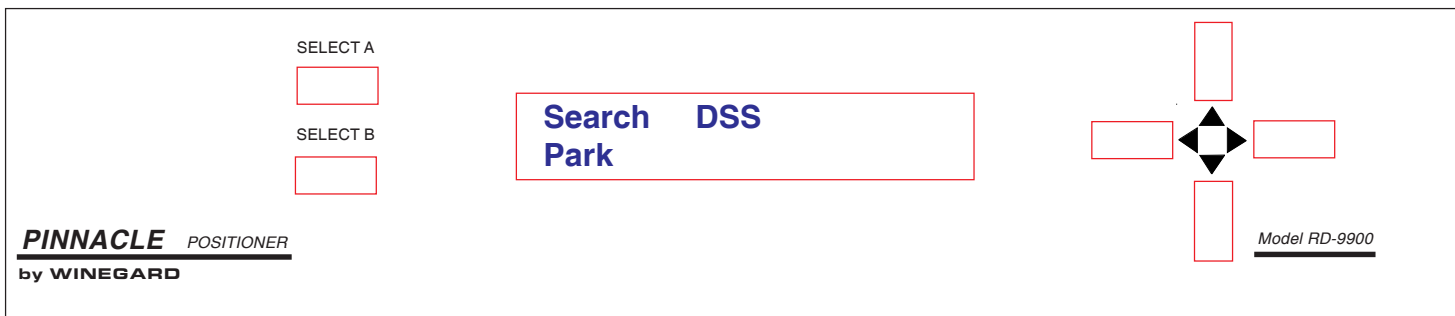

Figure 15

**You are now ready to enjoy satellite TV! Refer to Operation Manual on how to acquire the satellite signal.**

## RD-9901 Remote Control Wall Plate Installation

---

To install the optional RD-9901, proceed as follows:

1. Connect the 25' telephone cord to the REMOTE CONTROL PANEL plug on rear of positioner. See Figure 16.

**NOTE: The RD-9901 will fit into a standard electrical outlet box.**

2. Connect other end of telephone cord to plug on side of RD-9901. See Figure 16.

3. Secure RD-9901 with screws provided.

**NOTE: Refer to Operation Manual on how to operate the RD-9901.**

Positioner Rear Panel

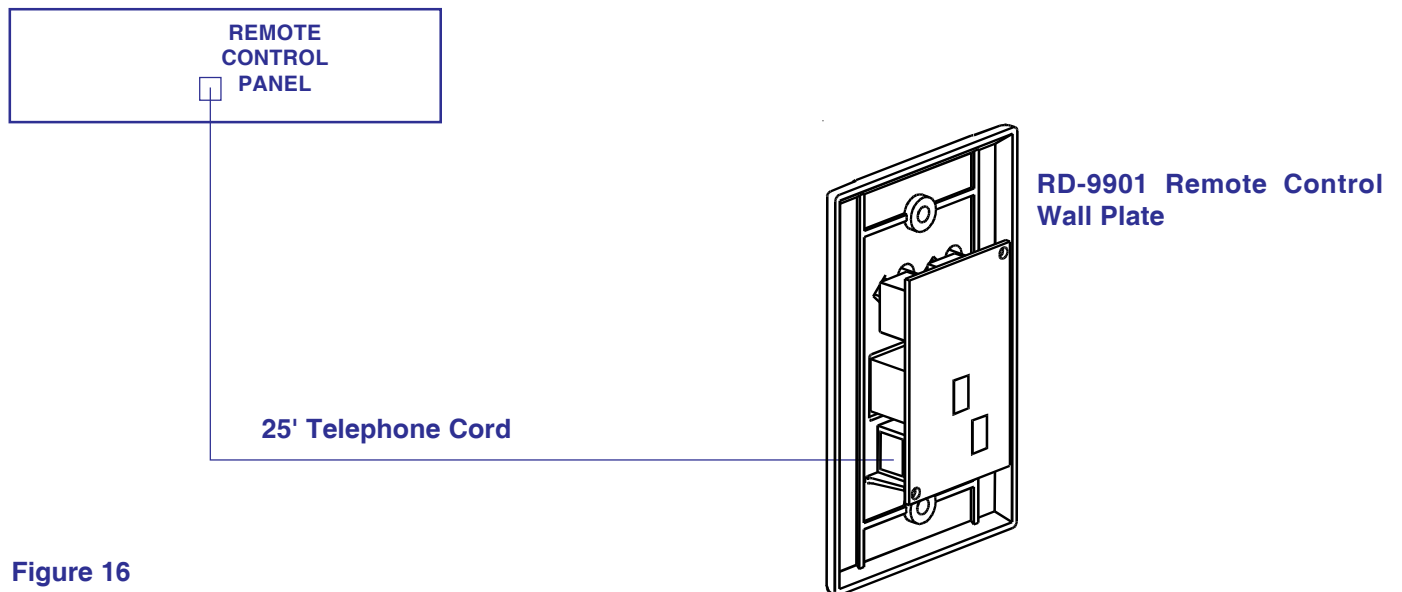

Figure 16

## RD-9911 Warning Device Installation/Operation

To install the Warning Device, proceed as follows:

1. Connect the gold colored wire of the warning device wire harness to ignition +12 VDC (there is only +12 VDC present when ignition is turned ON) See Figure 17.
2. Connect the silver colored wire to vehicle ground. See Figure 17.
3. Connect other end of wire (end with molded plug) to warning device. See Figure 17.
4. Insert the two "AA" batteries into the warning device.
5. Connect the single RCA cable to the **WARNING INDICATOR** jack on positioner (see Figure 11). Connect the other end to the warning device. See Figure 17.

**NOTE:** It is recommended that you place the warning device where it will be visible when you start your vehicle. There is no buzzer, only lights in the device. Velcro is provided to help in the placement of the device.

**Operation:** A red light indicates that the system is still in the raised position and not ready for travel. Red light goes off when in down position. A yellow light comes on when battery is low. Lights only come on when +12 VDC is applied to warning device.

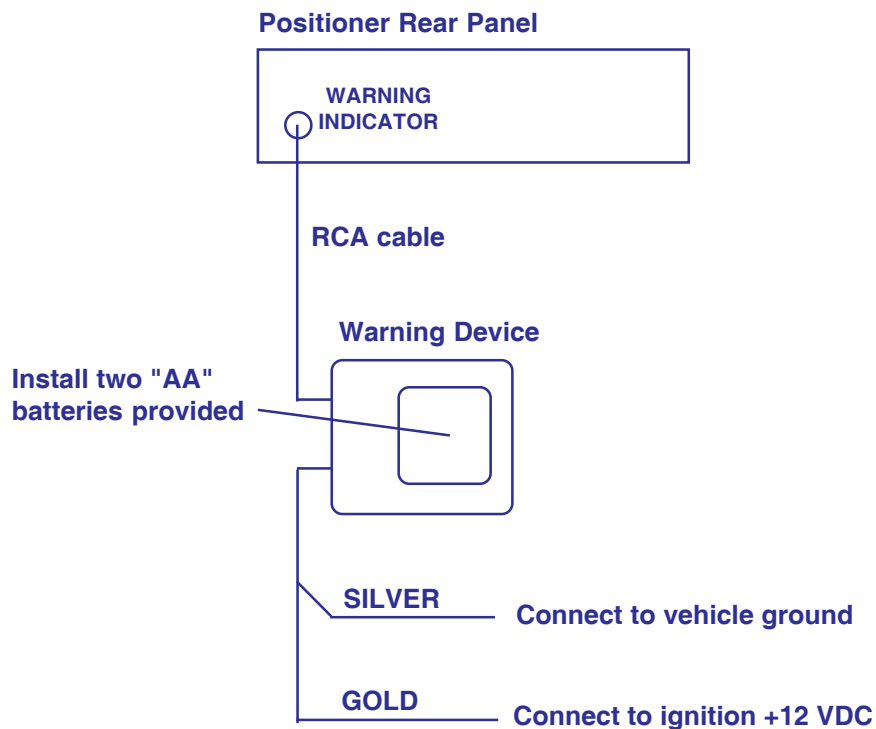

Figure 17



# Cable Roof-thru Plate Installation

---

If your going to use option B for you cable entry in to your RV/coach proceed to step 1.

1. To install the cable roof-thru plate make sure that you have the following:

QTY	Description	Part #	Use
1	3 oz. Silicone Sealant	2460007	Used to seal cable entry plates
1	Dual cable roof-thru plate	3200159	Seal dual cable entry
10	#10 x 1" Screw	2160178	Attach cable entry plate(s) to roof

3. Apply silicone sealant under lip of roof-thru plate and where cable enters roof. See Figure 18.

4. Attach plate to roof with screws provided. See Figure 18.

5. Apply silicone sealant over screws and around edge of roof-thru plate, making sure cable entry is sealed.

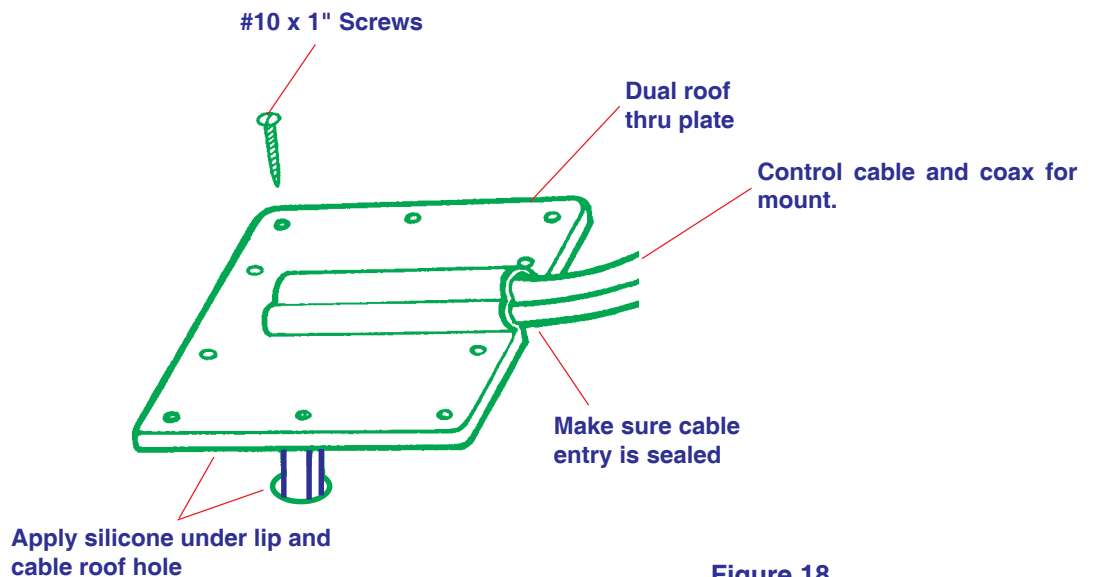

Figure 18

**MUST PERFORM!**

## **READ BEFORE PROCEEDING WITH SYSTEM INSTALLATION OR OPERATION**

### **RECEIVER & POSITIONER**

*When plugged in, the receiver & positioner are ON. When connecting or disconnecting any cables to receiver, positioner, or antenna, be sure to unplug from power source.*

**Do not install the receiver and/or positioner where there is no ventilation. The receiver/positioner must have adequate ventilation. Excessive heat can cause premature failure of components.**

**WINEGARD SERVICE DEPARTMENT (800) 788-4417  
MONDAY THRU FRIDAY, 7:00 - 3:00 PM CENTRAL TIME**

## **MUST PERFORM!**

**READ BEFORE PROCEEDING WITH POSITIONER REINSTALLATION.**

*After positioner reinstallation, you must put the antenna in the park (travel) position. **THIS MUST BE DONE EVEN IF THE ANTENNA IS ALREADY IN THE TRAVEL POSITION.** This is done so the positioner will know the antenna position. If not done, damage to the antenna may occur and the system will not operate properly. To park the antenna, refer to Operation Manual.*

**WINEGARD SERVICE DEPARTMENT (800) 788-4417**

# LOCATING THE SATELLITE

## SUGGESTIONS FOR AVOIDING SATELLITE SIGNAL ACQUISITION ERRORS

With the addition of several new U.S. satellites, your system may encounter some difficulty locating the correct satellite on the first attempt.

To reduce searching errors, it is recommended that you use the "ENTER ELEVATION" Search method on the Winegard Automatic Positioner. Refer to Pg. 9 in the Operation section of this manual.

Elevation can be acquired by entering your local ZIP code in the Receiver Set-up Menu. Once you find the correct elevation, subtract 3 degrees and enter this number. Example: If you are in an area that requires 41 degrees elevation, enter 38 degrees in the Elevation Search method.

# WINEGARD®

## Pinnacle® RV Digital Satellite System Models RD-9946

### Operation Manual

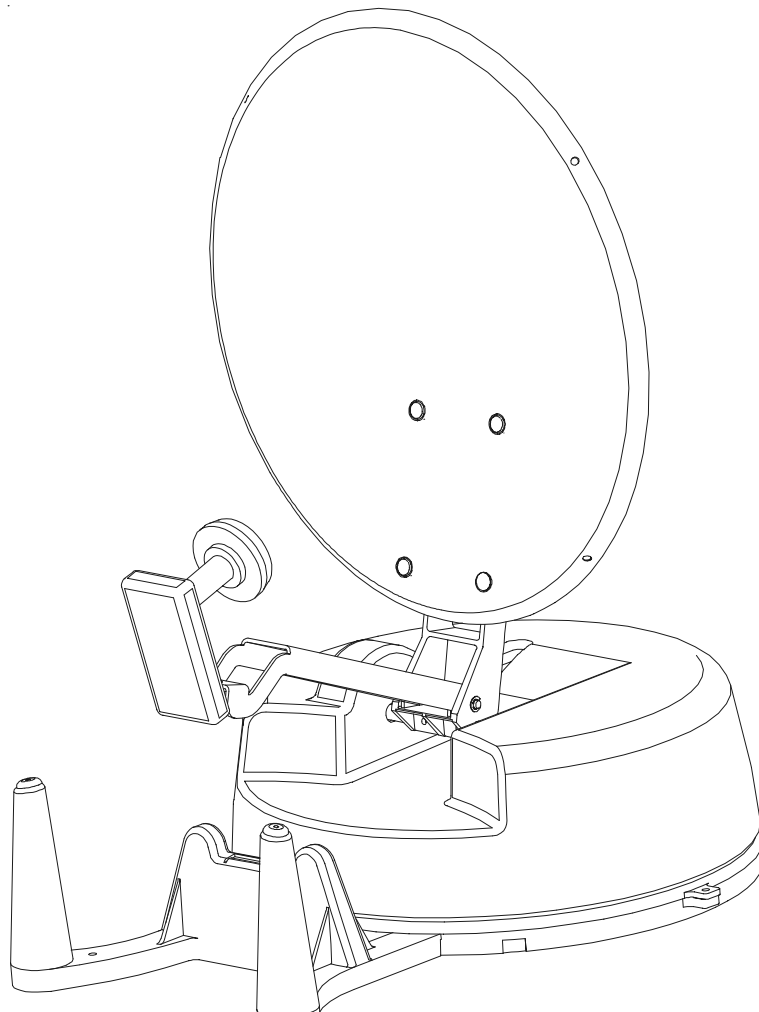

U.S. Patent No.  
5,532,710

***WARNING!***  
**BEFORE ATTACHING OR REMOVING ANY CABLE/WIRES ON  
BACK OF POSITIONER, UNPLUG UNIT FROM 117 VAC SOURCE.**

## IMPORTANT SAFEGUARDS

**WARNING:** THIS SYSTEM HAS BEEN ADJUSTED AT THE FACTORY FOR OPTIMUM PERFORMANCE. BEFORE MAKING ANY ADJUSTMENTS, CONTACT WINEGARD CUSTOMER SERVICE.

**WARNING:** TO REDUCE RISK OF FIRE OR ELECTRICAL SHOCK,  
DO NOT EXPOSE TO RAIN OR MOISTURE.  
(Not applicable to mount and antenna)

<b>CAUTION</b> <b>RISK OF ELECTRIC SHOCK</b> <b>DO NOT OPEN</b>		<b>Dangerous voltage</b> inside enclosure  <b>Refer to operating, maintenance</b> and safeguard literature accompanying unit.
<b>CAUTION:</b> TO REDUCE RISK OF ELECTRICAL SHOCK, DO NOT REMOVE COVER, NO USER-SERVICEABLE PARTS INSIDE. REFER SERVICING TO QUALIFIED PERSONNEL		

1. All the safety and operating instructions should be read before the appliance is operated.
2. The safety and operating instructions should be retained for future reference.
3. All warnings on the appliance and in the operating instructions should be adhered to.
4. All operating and use instructions should be followed.
5. Unplug this video or audio product from the wall outlet before cleaning. Do not use liquid cleaners or aerosol cleaners. Use a damp cloth for cleaning.
6. Do not use attachments not recommended by the video product manufacturer as they may cause hazards.
7. Do not use this video product near water - for example, near a bath tub, wash bowl, kitchen sink, or laundry tub, in a wet basement, or near a swimming pool, and the like.
8. If slots, holes and openings are located in the housing, they are provided for ventilation and to ensure reliable operation of the video product and to protect it from overheating. These openings should never be covered. The openings should never be blocked by placing the video product on a bed, sofa, rug, or other similar surface. This video product should never be placed near or over a radiator or heat register. This video product should not be placed in a built-in installation such as a bookcase or rack unless proper ventilation is provided or the manufacturer's instructions have been adhered to.
9. This video product should be operated only from the type of power source indicated in electrical rating printed on the appliance or power supply.
- 10A. If the appliance is equipped with a polarized alternating-current line plug (a plug having one blade wider than the other) this plug will fit into the power outlet only one way. This is a safety feature. If you are unable to insert the plug fully into the outlet, try reversing the plug. If the plug should still fail to fit, contact an electrician to replace your obsolete outlet. Do not defeat the safety purpose of the polarized plug.
- 10B. If the appliance is equipped with a 3-wire grounding-type plug, a plug having a third (grounding) pin, this plug will only fit into a grounding-type power outlet. This is a safety feature. If you are unable to insert the plug into the outlet, contact an electrician to replace your obsolete outlet. Do not defeat the purpose of the grounding-type plug.
11. Power-supply cord should be routed so that it is not likely to be walked on or pinched by items placed upon or against it, paying particular

attention to cord at plug, convenience receptacle and the point where cord exits from the appliance.

12. If an outside antenna or cable system is connected to this video product, be sure system is grounded so as to provide some protection against voltage surges and built-up static charges. Proper method is shown below.

### EXAMPLE OF ANTENNA GROUNDING AS PER NATIONAL ELECTRICAL CODE INSTRUCTIONS

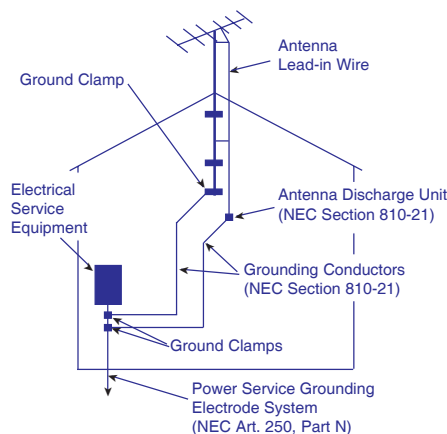

### NEC - NATIONAL ELECTRICAL CODE

13. An outside antenna system should not be located in the vicinity of overhead power lines or other electric light or power circuits, or where it can fall into such power lines or circuits. When installing an outside antenna system, extreme care should be taken to keep from touching such power lines or circuits as contact with them might be fatal.
14. For added protection for this video product during a lightning storm, or when it is left unattended and unused for long periods of time, unplug it from the wall outlet and disconnect the antenna or cable system.
15. Do not overload wall outlets and extension cords as this can result in a risk of fire or electric shock.
16. Never push objects of any kind into this video product through openings as they may touch dangerous voltage points or short-out parts that could result in a fire or electric shock. Never spill liquid of any kind on the video product.

17. Do not attempt to service this video product yourself as opening or removing covers may expose you to dangerous voltage or other hazards. Refer all servicing to qualified service personnel.

18. Unplug this video product from the wall outlet and refer servicing to qualified service personnel under the following conditions:

- a. When the power supply cord or plug is damaged.
- b. If liquid has been spilled or objects have fallen into the video product.
- c. If the video product, except for antenna mounted preamplifiers and downconverters, has been exposed to rain or water.
- d. If the video product does not operate normally by following the operating instructions. Adjust only those controls, when provided, that are covered by the operating instructions. An improper adjustment of other controls may result in damage that will often require extensive work by a qualified technician to restore the video product to its normal operation.
- e. If the video product has been dropped or the housing has been damaged.
- f. When the video product exhibits a distinct change in performance - this indicates a need for service.

19. When replacement parts are required, be sure the service technician has used replacement parts specified by the manufacturer or have the same characteristics as the original part. Improper substitutions may result in fire, electric shock or other hazards.

20. Upon completion of any service or repairs to this video product, ask the service technician to perform safety checks to determine that the video product is in proper operating condition.

21. Note to CATV system installer: This reminder is provided to call the CATV system installer's attention to Art. 820-40 of the NEC that provides guidelines for proper grounding and, in particular, specifies that the cable ground shall be connected to the grounding system of the building, as close to the point of cable entry as possible.

22. This product should be mounted to a wall or ceiling only as recommended by the manufacturer.

23. The product should be situated away from heat sources such as radiators, heat registers, stoves or other products (including amplifiers) that produce heat.

# TABLE OF CONTENTS

Introduction .....	4
System Operation (Finding the digital satellite system satellite(s) .....	5
Using the City Menu .....	5
Entering Elevation Angle .....	9
Entering Latitude & Longitude .....	11
Putting Antenna in Park Position .....	14
Move to Last Satellite .....	15
Manual Movement .....	16
Edit Menu .....	18
Select Search Satellite .....	19
Add/Edit Search Satellite .....	20
Set Motor Positions .....	22
Test Functions .....	22
Return to Defaults .....	22
System Information .....	22
Remote Control Panel Operation .....	23
Search for Satellite .....	23
Parking the Antenna .....	24
Latitude and Longitude Map .....	25
Positioner Controls & Indicators .....	26-27
Programmed City Locations .....	28
Specifications .....	29
Warranty Information .....	29

## FCC PART 15 STATEMENTS

**NOTE:** This equipment has been tested and found to comply with the limits for a Class B digital device, pursuant to Part 15 of the FCC Rules. These limits are designed to provide reasonable protection against harmful interference in a residential installation. This equipment generates, uses and can radiate radio frequency energy and, if not installed and used in accordance with the instructions, may cause harmful interference to radio communication. However, there is no guarantee that interference will not occur in a particular installation. If this equipment does cause harmful interference to radio or television reception, which can be determined by turning the equipment off and on, the user is encouraged to try to correct the interference by one or more of the following measures:

- Reorient or relocate the receiving antenna.
- Increase the separation between the equipment and receiver.
- Connect the equipment into an outlet on a circuit different from that to which the receiver is connected.
- Consult the dealer or an experienced radio/TV technician for help.

**CAUTION: Any changes or modifications to this equipment not expressly approved by Winegard Company may void the user's authority to operate this equipment.**



# INTRODUCTION/HOW DOES DIGITAL SATELLITE TV WORK?

## INTRODUCTION

Welcome to a new era in RV Satellite reception. A combination of the latest computer and microprocessor technology makes the Winegard Pinnacle® satellite positioner and your digital satellite system receiver the easiest to operate. A simple button stroke will automatically direct the antenna to the satellite.

## HOW DOES DIGITAL SATELLITE SYSTEM TV WORK?

Satellite programming originates from an "uplink" facility. The DBS satellites receive the uplink signal, amplify it and then transmit it back to earth in the Ku frequency band.

This signal is received by a satellite antenna whose shape reflects and concentrates the signal to the LNBF attached to the antenna. The LNBF is located at the "focal point" of signal reflection, that is, the point at which the maximum amount of signal is effectively concentrated. The LNBF amplifies and converts the signal to the 950 to 1450 MHz range. The signal is then passed thru a coaxial cable to the positioner, then to the receiver where individual channel selection and processing take place.

For Programming information call:  
**DISH NETWORK - 1-800-333-3474**  
**DSS®**  
**DIRECTV - 1-800-347-3288**  
**USSB - 1-800-204-8772**

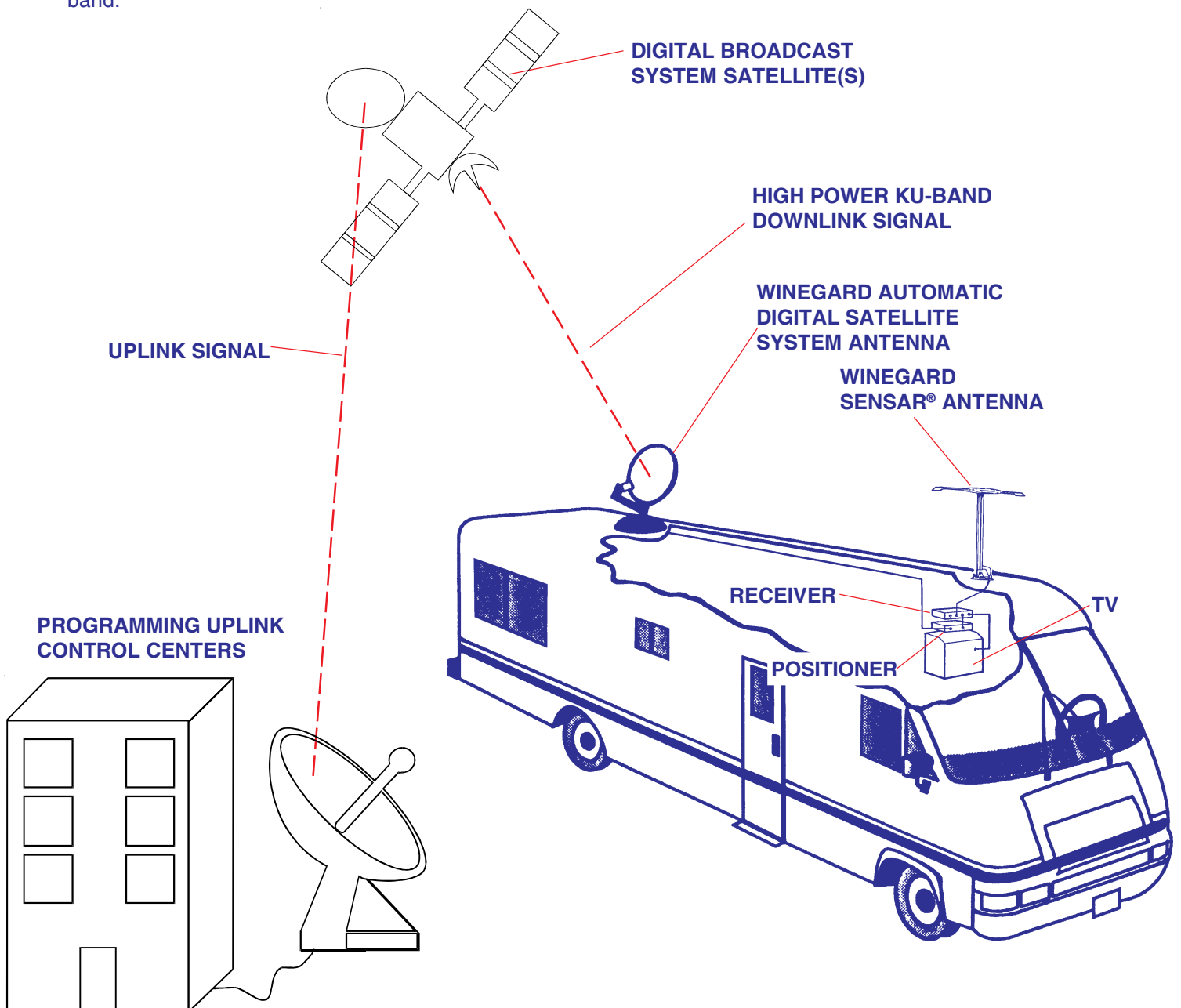

# SYSTEM OPERATION (FINDING THE SATELLITE(S))

Your new Winegard RV Digital Satellite System is an easy-to-install, easy-to-use satellite TV reception system. Because it mounts on the top of your recreational vehicle, it goes where you go and provides quality reception of digital satellite signal in the continental United States only.

**NOTE:** All commands will be shown in bold with brackets, example [SELECT A].

One requirement must be met to fully enjoy automatic system TV viewing. The RV must be reasonably level. Any of the leveling indicators available should be adequate for this purpose. If the RV is not leveled, the system may not find the high power satellites.

After the RV has been leveled, proceed as follows:

## Finding the Satellite Method 1: Using the City Menu

**NOTE:** SELECT A chooses top option, SELECT B chooses bottom option.

There are three ways to find the satellite(s). Using the city menu to find the closest city, entering the elevation angle for your location or entering the latitude and longitude for your location. Each is explained in the following paragraphs.

1. Turn TV ON and tune to channel 3 or 4 (output channel of receiver).
2. Press [POWER] on receiver remote to turn satellite receiver on.
3. On positioner press [UP/DOWN] arrow button until **Search DSS** appears on the positioner screen, Figure 1. If you want to search for a different satellite refer to Edit Menu on page 18 to change search satellites.

2. Press SELECT A

1. Press UP/DOWN arrow buttons to get Search DSS on screen

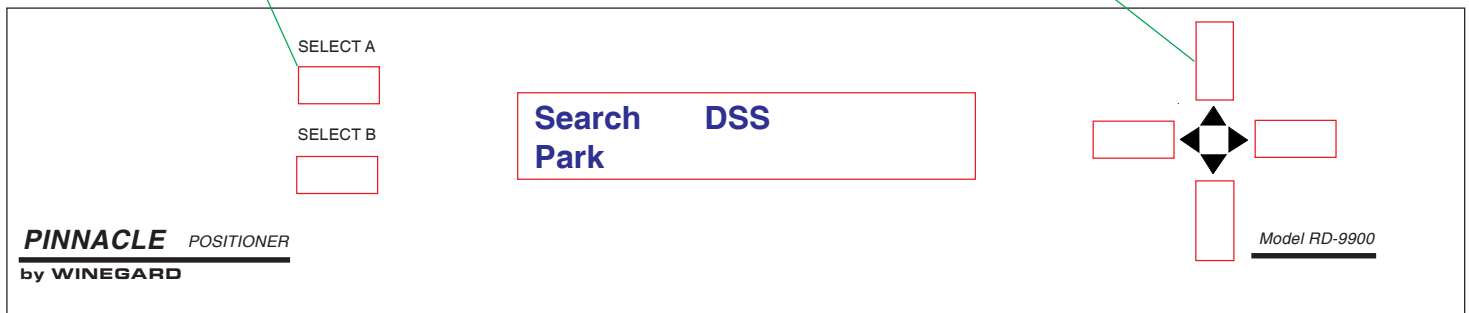

Figure 1

4. Press [SELECT A] to enter the search function, Figure 1. (Press [SELECT B] if **Search DSS** is bottom option on screen.

5. Press [SELECT A] **Select a City**, Figure 2. There is a list of 125 cities in the continental United States stored in the positioner memory. See Programmed City Locations, page 28.

3. Press SELECT A

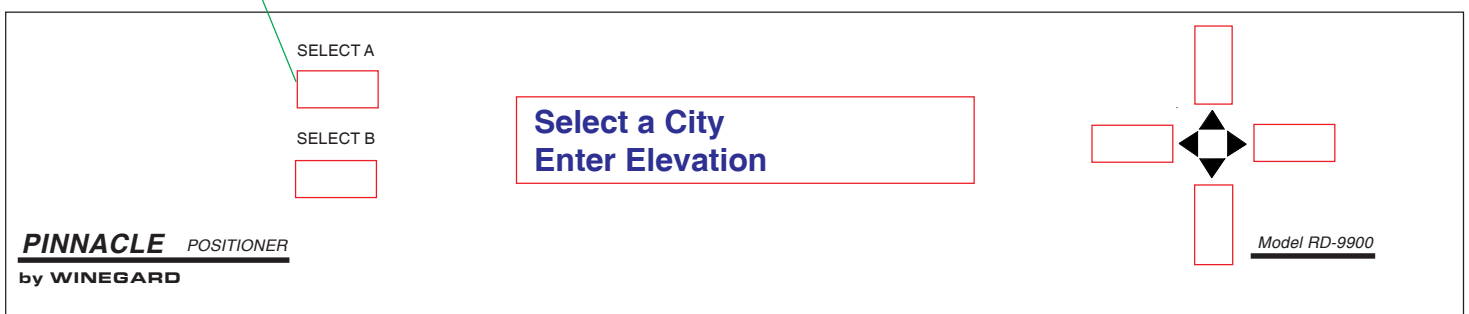

Figure 2

6. Press **[UP/DOWN]** arrow buttons to scroll cities, Figure 3. The cities are listed alphabetically by state. Pressing the **[RIGHT]** arrow button will scroll the list to the first entry of the next state. Pressing the **[LEFT]** arrow button will scroll the list to the last entry of the previous state.

5. Press **SELECT A** or **B** for the nearest city

4. Press **UP/DOWN** arrow buttons to scroll through City list

Press **RIGHT** arrow button to scroll list to the first entry of the next state

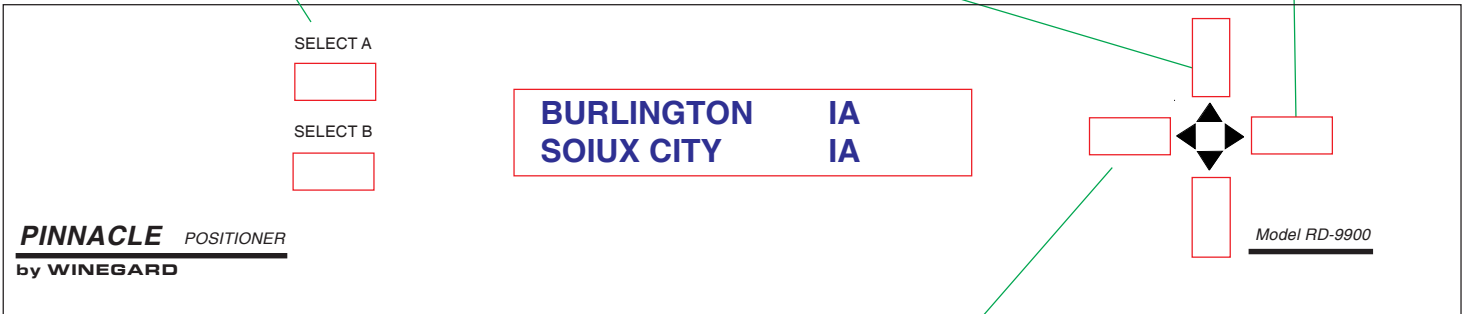

Figure 3

Press **LEFT** arrow button to scroll list to the last entry of the previous state

7. Press **[SELECT A or B]** once you have scrolled to the closest city to your location, Figure 3.

8. Press **[SELECT A] Start Search**, Figure 4. This will begin the search for satellite operation. If you selected the wrong city press **[SELECT B] Quit**, this will return you to step 3. Repeat 3 through 7 to select the correct city.

6. Press **SELECT A**

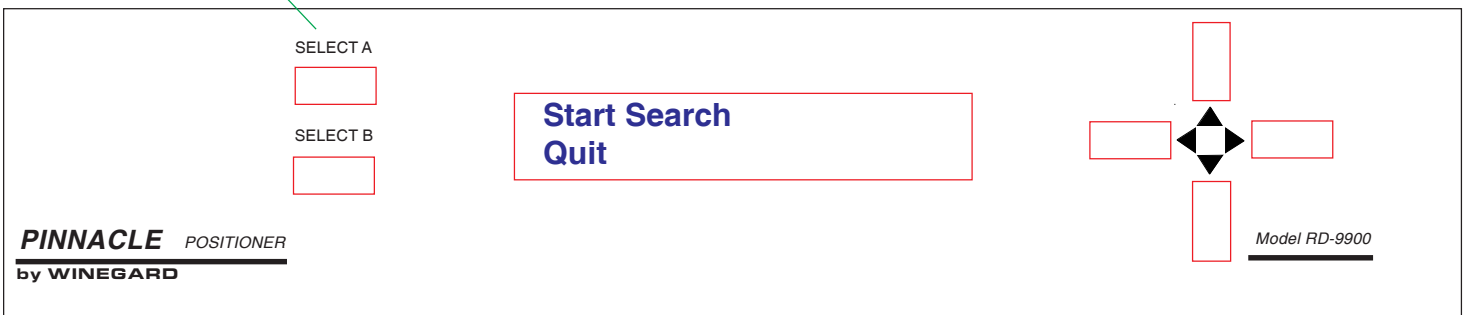

Figure 4

**NOTE:** When the system starts searching for the satellite, the following messages will be displayed on the positioner screen. No input is required.

Positioner is calculating correct elevation angle for antenna

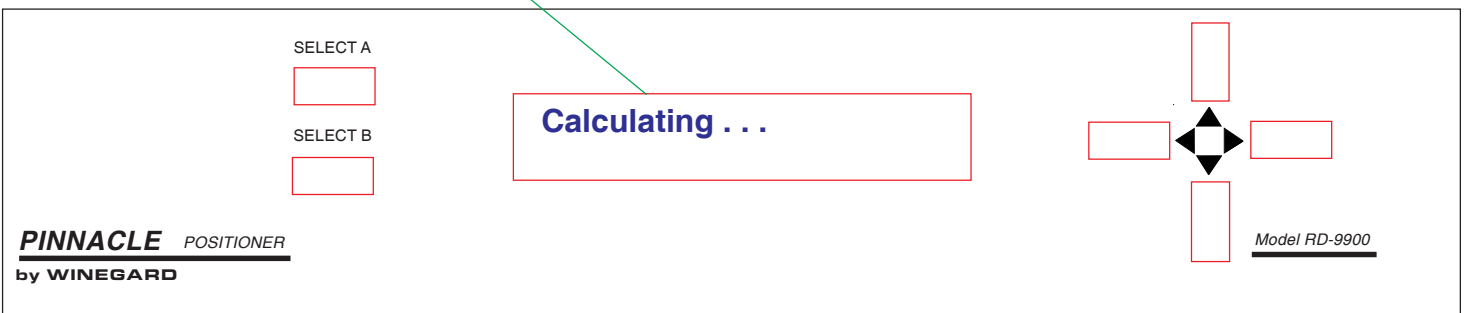

Figure 5

Positioner is setting appropriate detector level (amount of signal required)



Figure 6

Positioner is moving antenna to start position

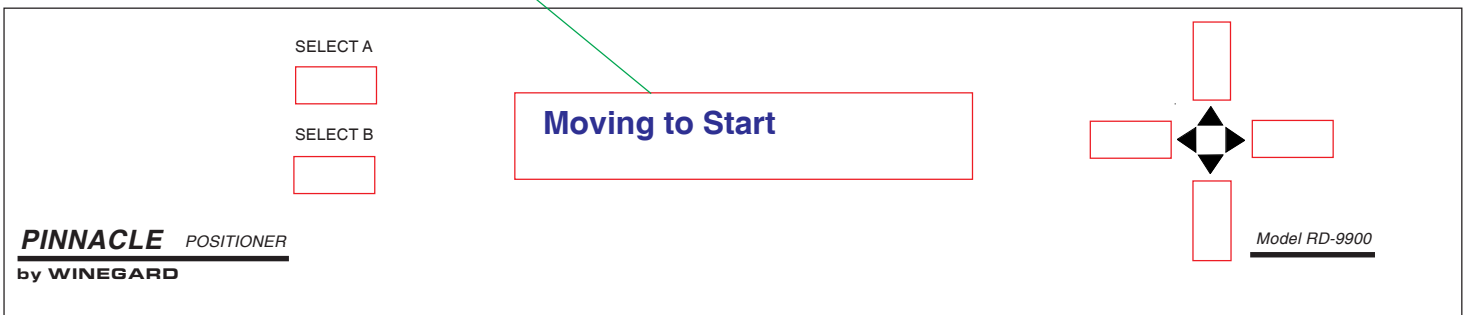

Figure 7

System is now searching for satellite

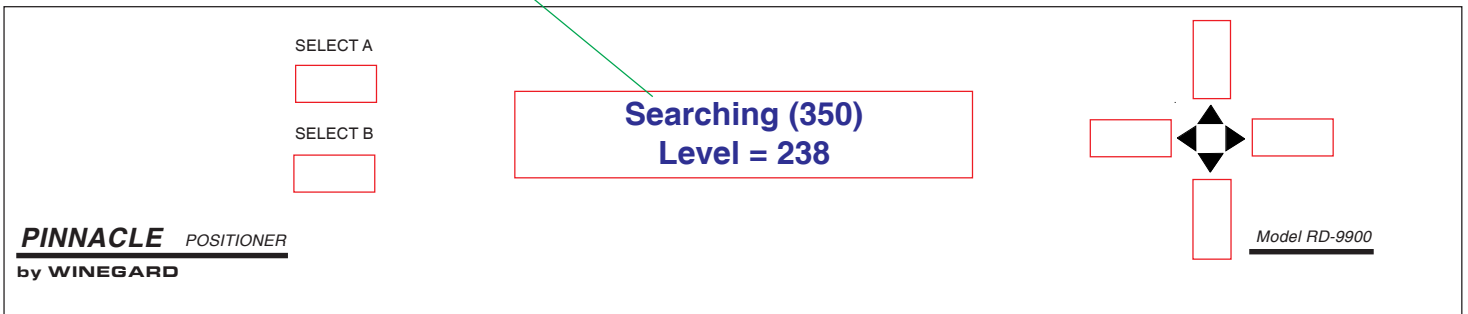

Figure 8

System has found the satellite and is fine tuning antenna position

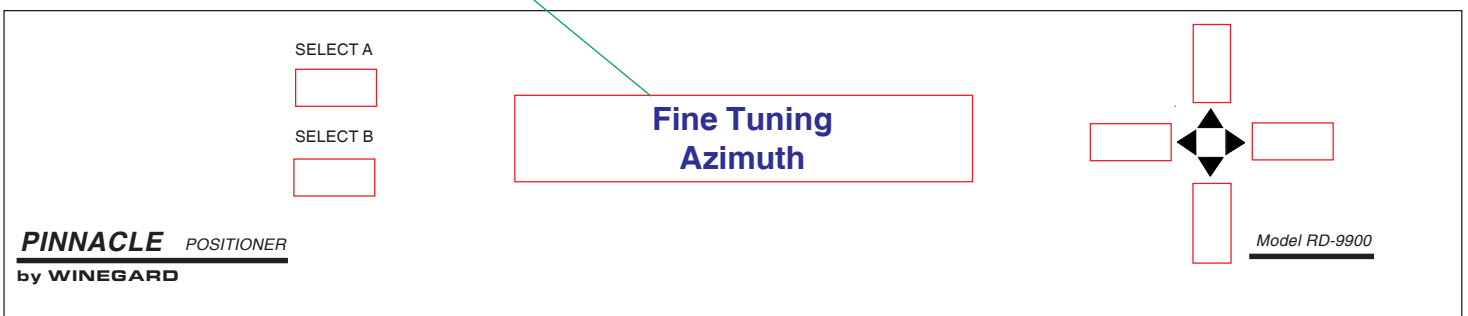

Figure 9

System has found a satellite and is fine tuning the signal

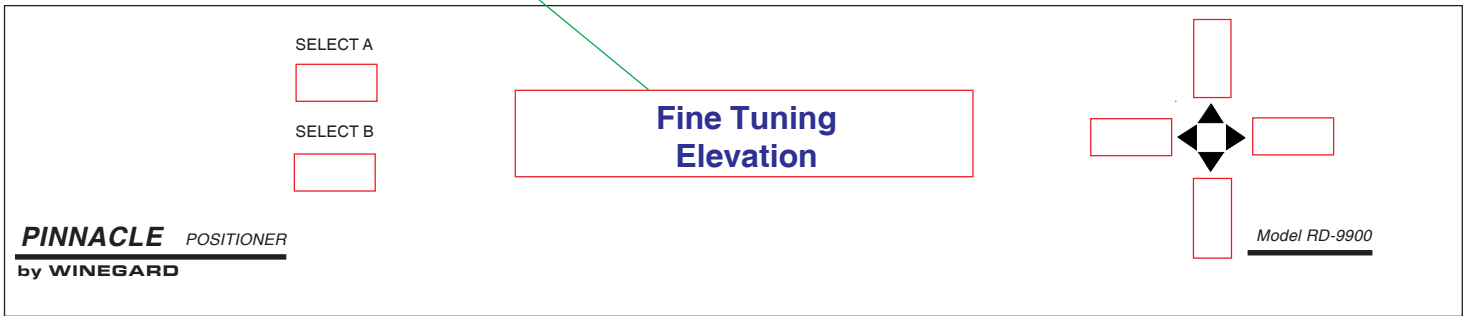
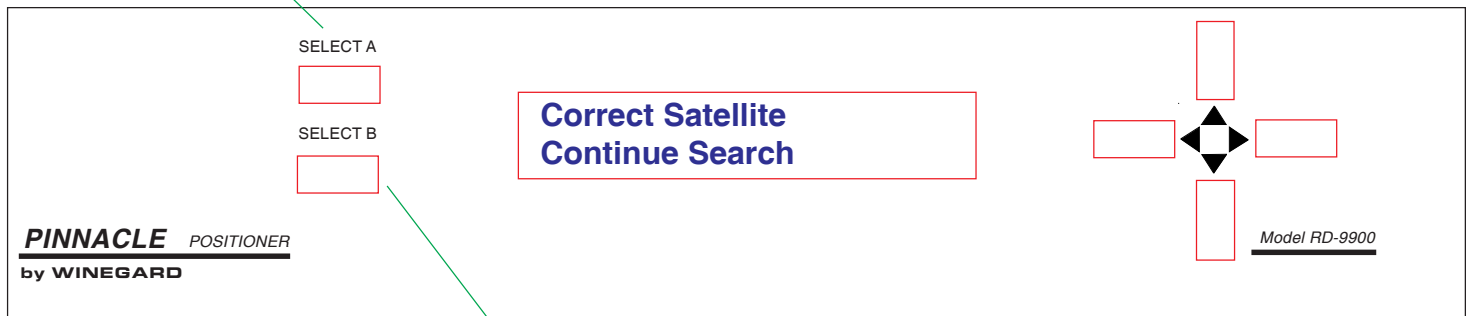

Figure 10

9. Verify that system has found correct satellite (you will see a picture). Since DBS services use a digital signal and the satellites are only separated by 9°, the system can find the wrong satellite. Press **[SELECT A]** if correct satellite was found, Figure 11. You are now ready to watch satellite TV! If the wrong satellite was found, press **[SELECT B]** to continue the search.

If no satellite is found the message **Satellite Not Found, Press Any Button**, will be displayed by the positioner. Press any button to return to the menu shown in Figure 1, page 4.

7. Press **SELECT A** if correct satellite was found



Press **SELECT B** if correct satellite was not found

Figure 11

**NOTE:** If after two (2) tries you still get "Satellite Not Found" check that:

1. The antenna has a clear view of the satellite(s), no trees, buildings, etc. blocking the view. The satellite signal will not pass through solid objects.
2. Your receiver is turned ON.
3. The positioner is connected to the receiver correctly, refer to Installation Manual.

If after checking the above, you still do not find a satellite refer to the Troubleshooting Manual.

**Finding the Satellite  
Method 2:  
Entering the Elevation**

One requirement must be met to fully enjoy automatic system TV viewing. The RV must be reasonably level. Any of the leveling indicators available should be adequate for this purpose. If the RV is not leveled, the system may not find the high power satellites.

After the RV has been leveled, proceed as follows:

To find the satellite by entering the elevation angle for your location, proceed as follows:

1. Turn TV ON and tune to channel 3 or 4 (output channel of receiver).
2. Press **[POWER]** on receiver remote to turn satellite receiver on. Determine correct elevation angle by entering the ZIP code for your location into receiver (refer to receiver manual).
3. On the positioner press **[UP/DOWN]** arrow button until **Search DSS** appears on the positioner screen, Figure 12.

**NOTE: SELECT A chooses top option, SELECT B chooses bottom option.**

2. Press **SELECT A**

1. Press **UP/DOWN** arrow buttons to get **Search DSS** on screen

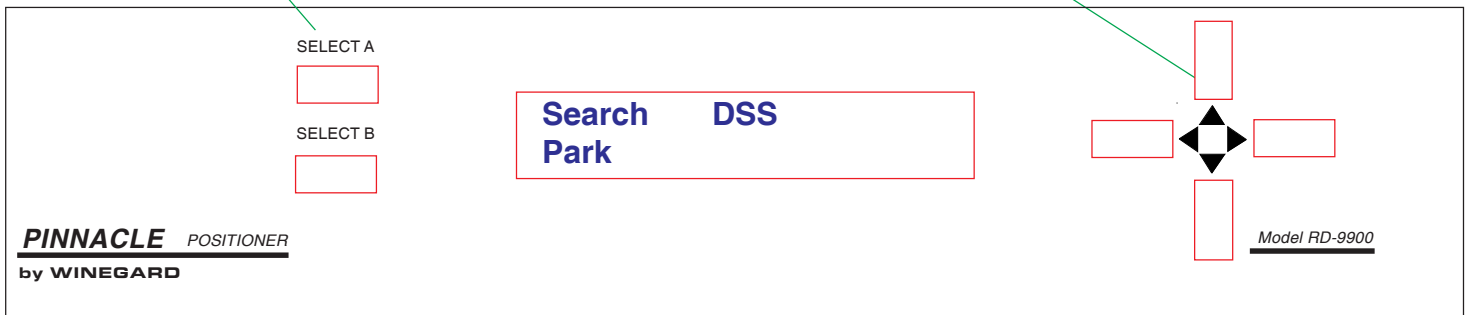

Figure 12

4. Press **[SELECT A]** to enter the search function, Figure 12. (Press **[SELECT B]** if **Search DSS** is bottom option on screen.

5. Press **[SELECT B]** Enter elevation, Figure 13.

3. Press **SELECT B**

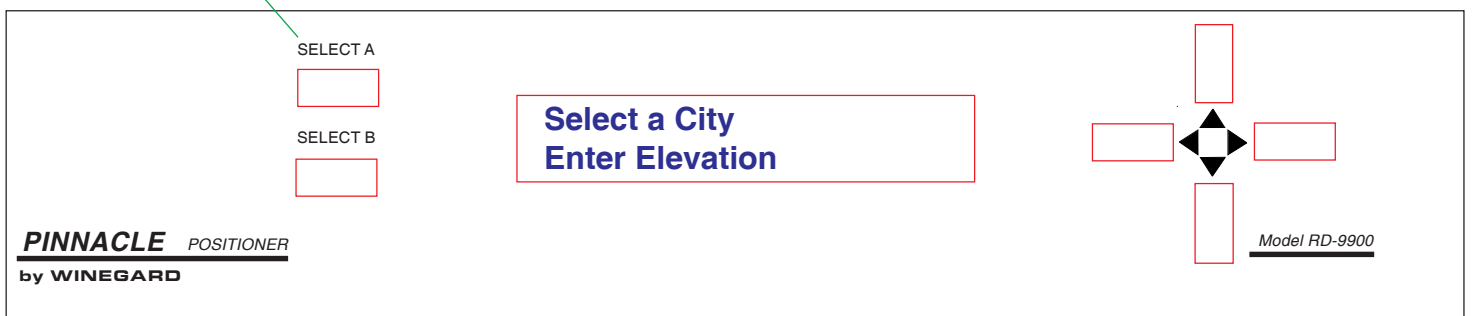

Figure 13

5. Press [ARROW BUTTONS] to enter correct elevation, Figure 14.

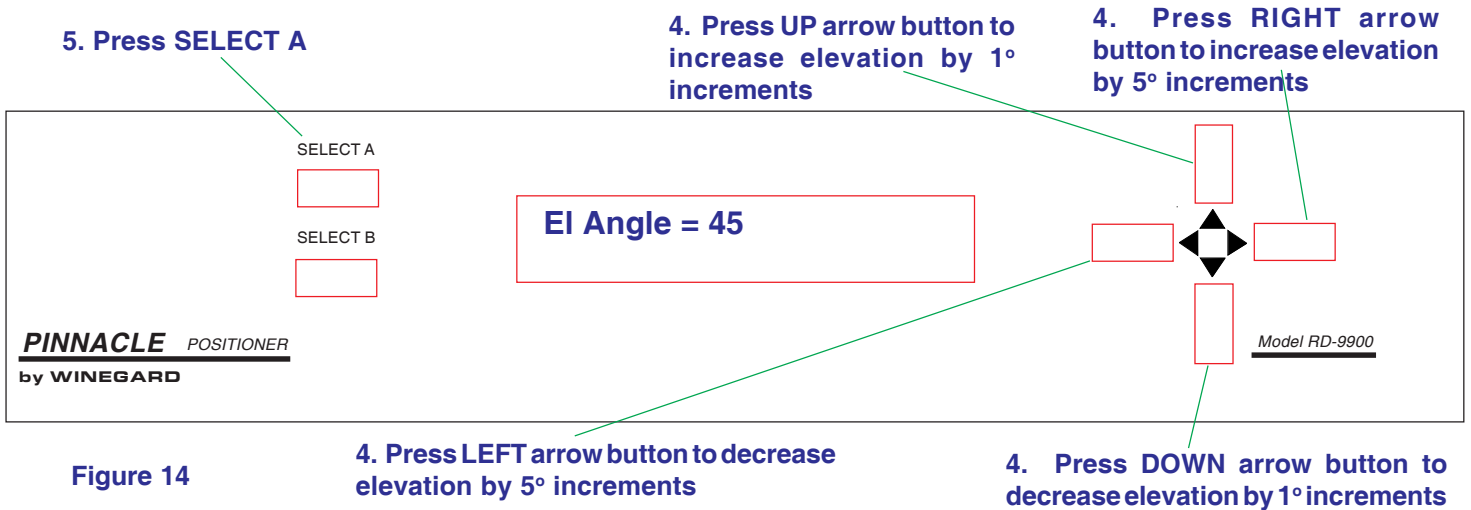

Figure 14

6. Press [SELECT A] Start Search, Figure 15. This will begin the search for the satellite. If you selected the wrong elevation, press [SELECT B] Quit, this will return you to step 3. Repeat 3 through 5 to select the correct elevation.

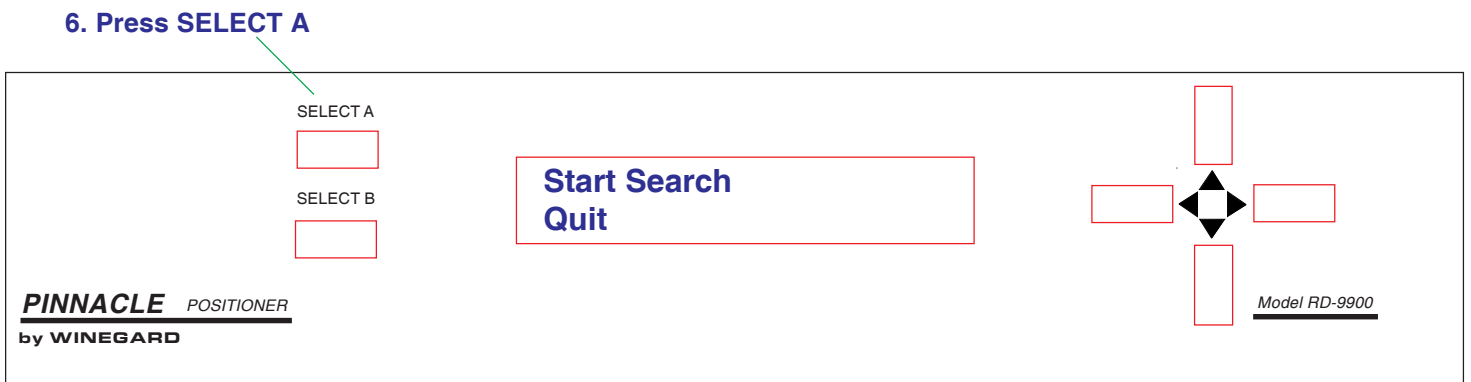

Figure 15

7. Verify that system has found correct satellite (you will get a picture). Since the DBS services use a digital signal and the satellites are only separated by 9°, the system can find the wrong satellite. Press [SELECT A] if correct satellite was found, Figure 16. You are now ready to watch satellite TV! If the wrong satellite was found, press [SELECT B] to continue the search.

If no satellite was found, the message **Satellite Not Found, Press Any Button**, will be displayed by the positioner. Press any button to return to the menu shown in Figure 12, page 9.

7. Press SELECT A if correct satellite was found

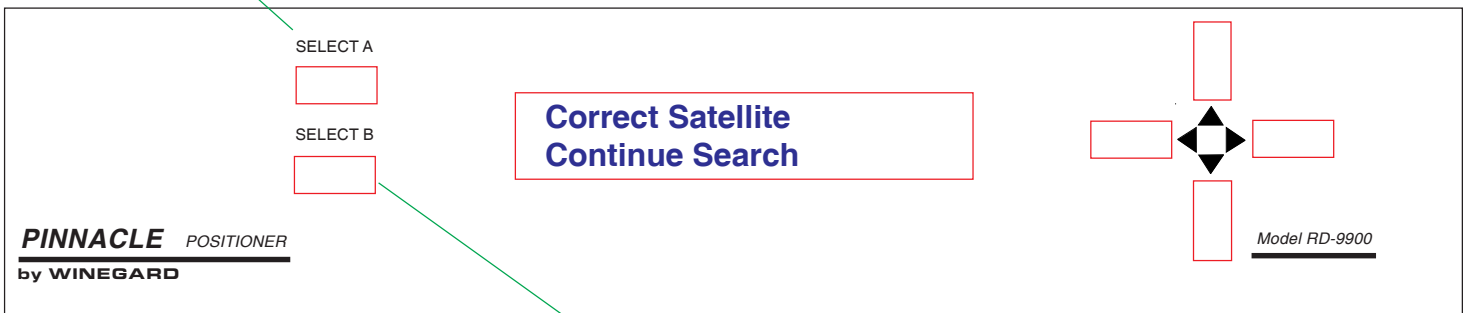

Figure 16

Press SELECT B if correct satellite was not found



**Finding the Satellite  
Method 3:  
Entering the Latitude  
and Longitude**

One requirement must be met to fully enjoy automatic system TV viewing. The RV must be reasonably level. Any of the leveling indicators available should be adequate for this purpose. If the RV is not leveled, the system may not find the high power satellites.

After the RV has been leveled, proceed as follows:

**NOTE:** Winegard does not warrant this system to work outside the continental United States (latitude 25° to 50°, longitude 65° to 125°).

To find the satellite by entering the latitude and longitude for your location proceed as follows:

1. Turn TV ON and tune to channel 3 or 4 (output channel of receiver).
2. Press **[POWER]** on receiver remote to turn satellite receiver on.
3. On the positioner press **[UP/DOWN]** arrow button until **Search DSS** appears on the positioner screen, Figure 17.

**NOTE: SELECT A chooses top option, SELECT B chooses bottom option.**

2. Press **SELECT A**

1. Press **UP/DOWN** arrow buttons to get **Search DSS** on screen

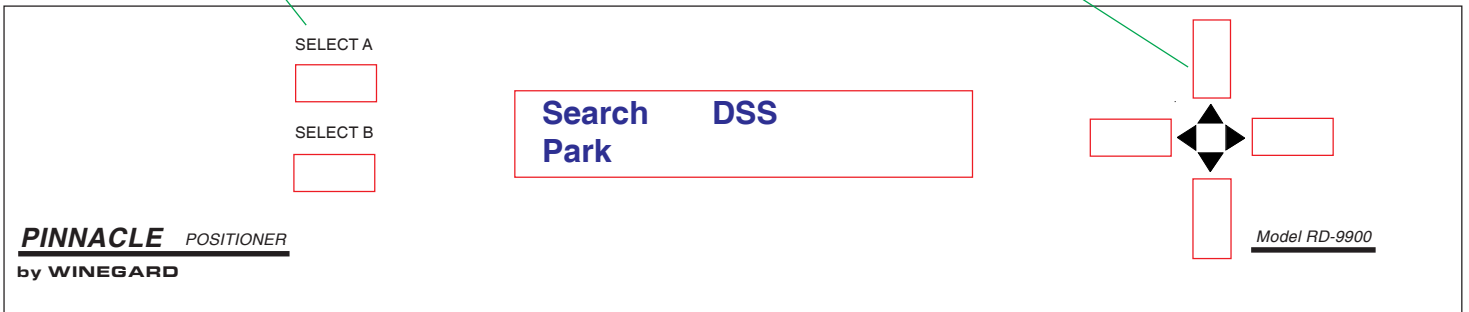

Figure 17

4. Press **[SELECT A]** to enter the search function, Figure 17. (Press **[SELECT B]** if **Search DSS** is bottom option on screen.

5. Press **[UP]** arrow button, Figure 18.

4. Press **SELECT B**

3. Press **UP** arrow button

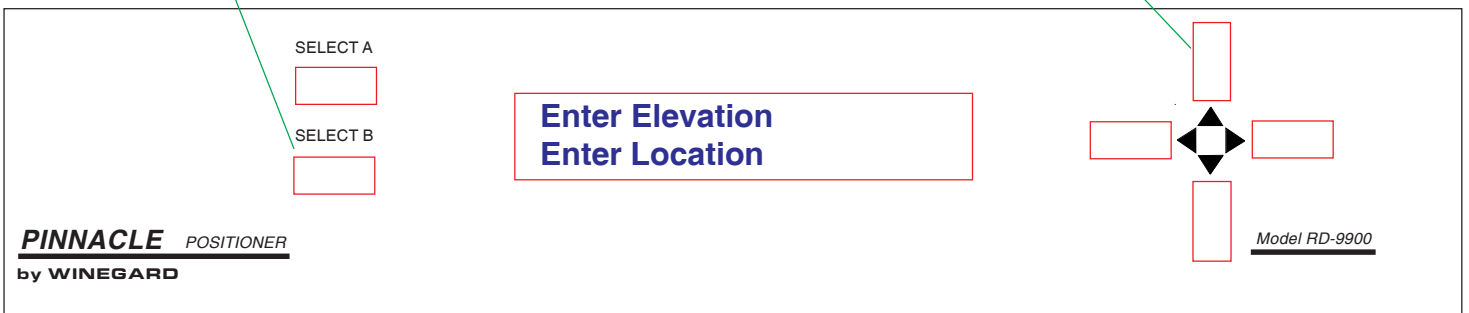

Figure 18

6. Press **[SELECT B]** **Enter Location**, Figure 18

**NOTE:** If you do not know your latitude and longitude you can refer to Figure 40, page 25.

7. Press [ARROW BUTTONS] to display correct latitude, Figure 19.

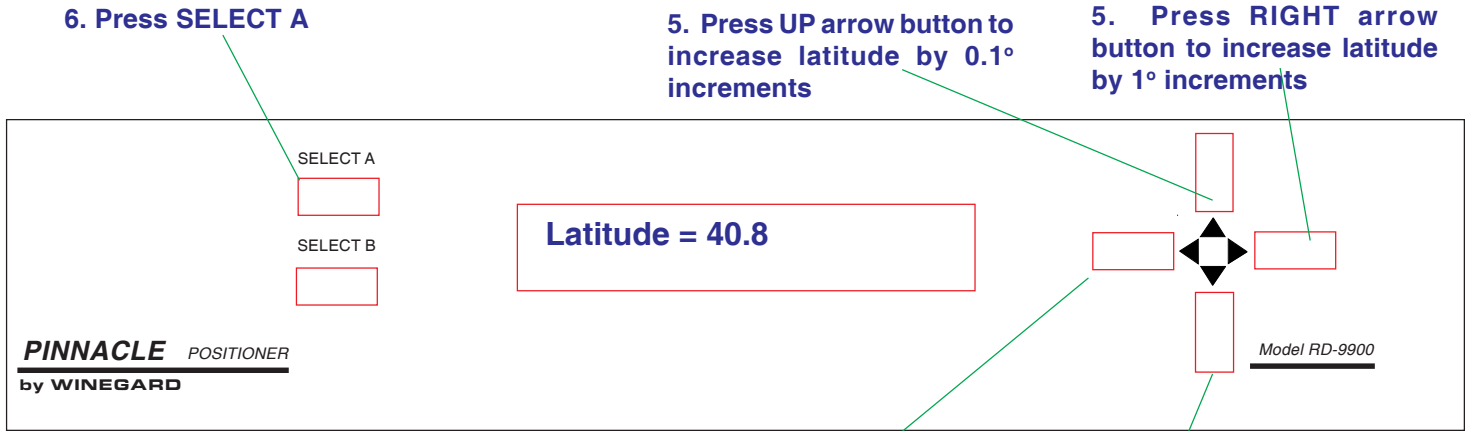

Figure 19

5. Press LEFT arrow button to decrease latitude by 1° increments

5. Press DOWN arrow button to decrease latitude by 0.1° increments

8. Press [SELECT A] to enter latitude, Figure 19.

9. Press [ARROW BUTTONS] to display correct longitude, Figure 20.

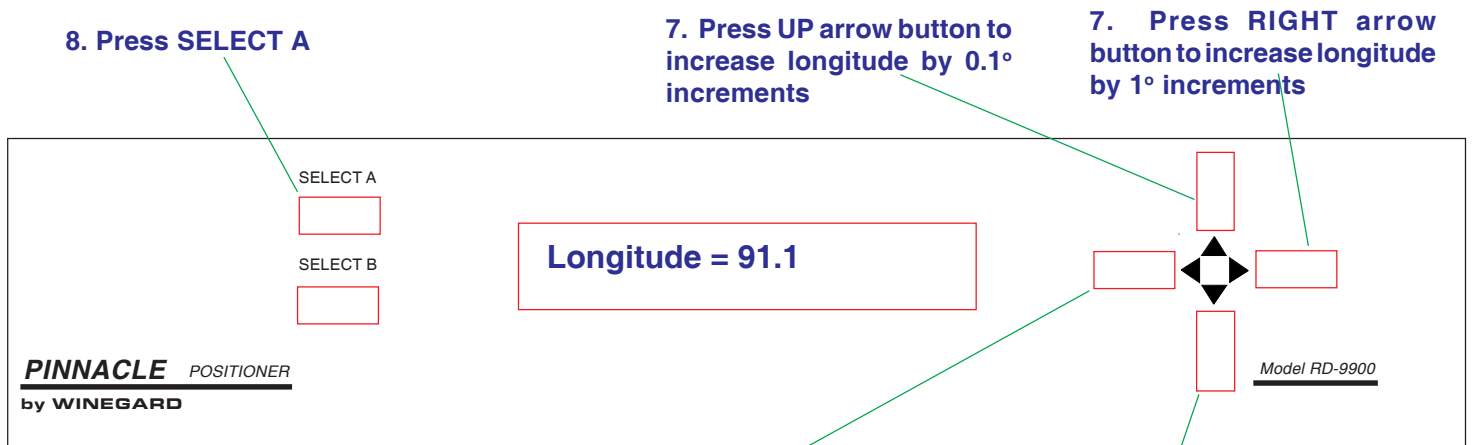

Figure 20

7. Press LEFT arrow button to decrease longitude by 1° increments

7. Press DOWN arrow button to decrease longitude by 0.1° increments

10. Press [SELECT A] to enter longitude, Figure 20.

11. Press **[SELECT A] Start Search**, Figure 21. This will begin the search for the satellite. If you entered the wrong latitude/longitude, press **[SELECT B] Quit**, this will return you to step 3. Repeat 3 through 10 to enter the correct latitude and longitude.

9. Press **SELECT A**

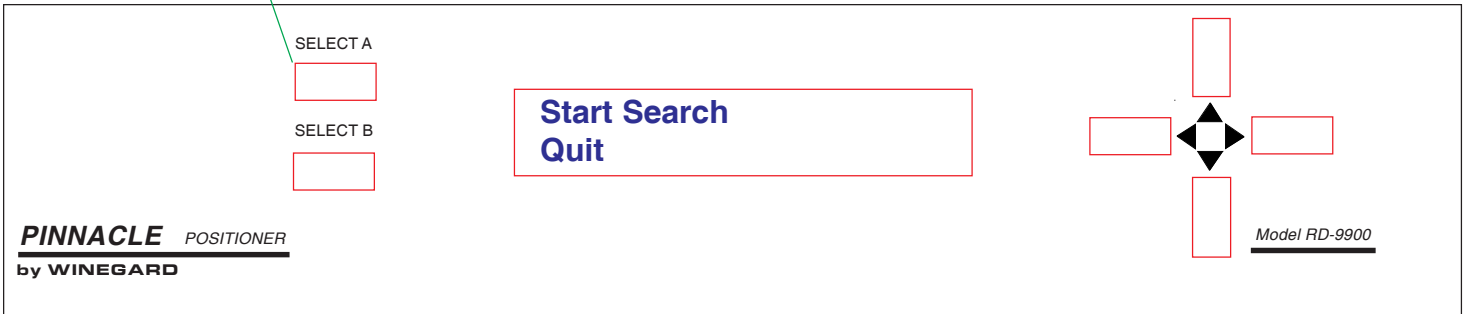

Figure 21

12. Verify that system has found correct satellite (you will get a picture). Since the DBS services use a digital signal and the satellites are only separated by 9°, the system can find the wrong satellite. Press **[SELECT A]** if correct satellite was found, Figure 22, You are now ready to watch satellite TV! If the wrong satellite was found, press **[SELECT B]** to continue the search.

If no satellite was found, the message **Satellite Not Found, Press Any Button**, will be displayed by the positioner. Press any button to return to the menu shown in Figure 17, page 11.

10. Press **SELECT A** if correct satellite was found

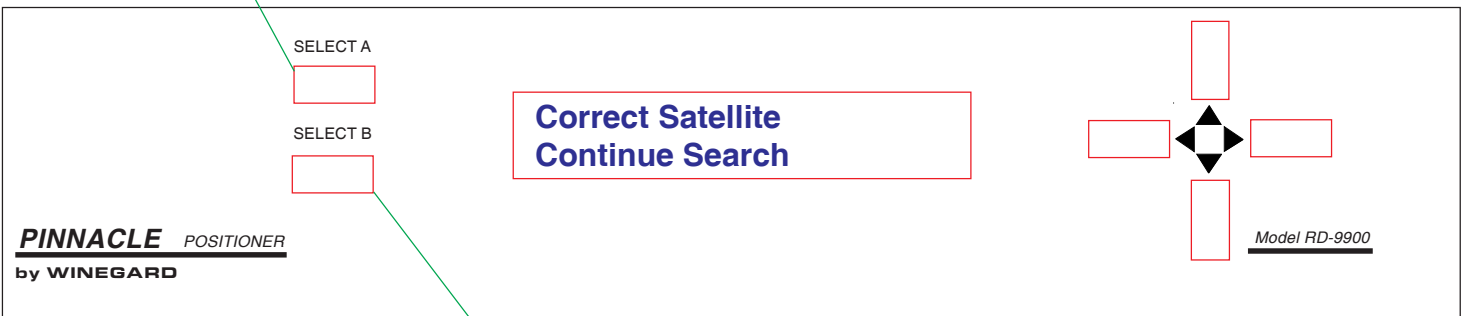

Figure 22

Press **SELECT B** if correct satellite was not found

# PUTTING ANTENNA IN PARK POSITION

**NOTE:** All commands will be shown in bold with brackets, example [SELECT A].

To put antenna in park (travel) position, proceed as follows:

1. Press [UP/DOWN] arrow until you get **Park** displayed on positioner display. See Figure 23.

2. Press **SELECT A** or **B** as appropriate

1. Press **UP/DOWN** arrow buttons to get **Park** on screen



Figure 23

2. Press [SELECT A or B] **Park** to put antenna into park (travel) position. You will get the message **Collapsing System** while antenna is moving to travel position.

3. Step out of the RV/coach and verify that antenna is in the travel position when **Collapsing System** is replaced with normal menu, Figure 24.

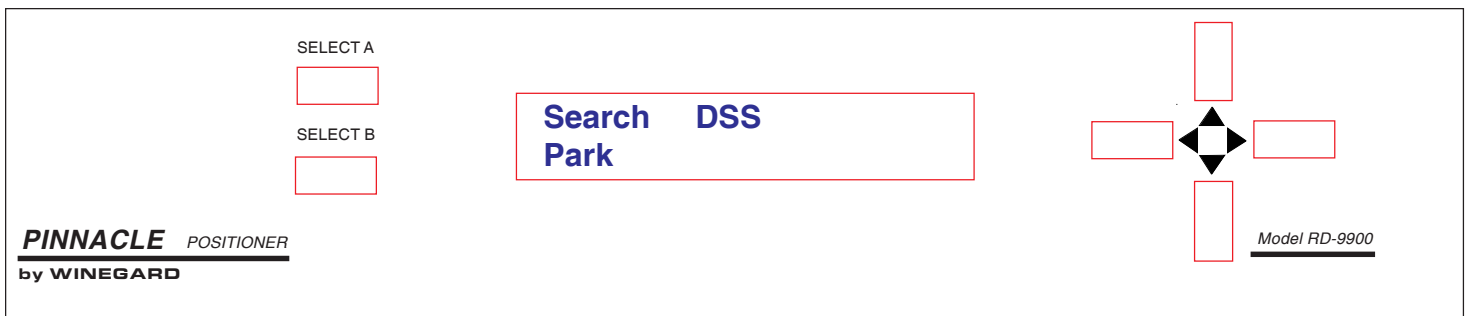

Figure 24

# MOVE TO LAST SATELLITE

**NOTE:** All commands will be shown in bold with brackets, example [SELECT A].

Move to Last Satellite: This function allows you to move the antenna to the last position that the system found a satellite. This feature is very useful. It allows you to put the antenna into the travel position and **if the RV/coach was not moved** return to watching TV without performing the search function. To move antenna to the last satellite position, proceed as follows:

1. Press [UP/DOWN] arrow until **Move to Last Sat** is displayed on positioner. See Figure 25.

2. Press **SELECT A or B** as appropriate

1. Press **UP/DOWN** arrow buttons to get **Move to Last Sat** on screen

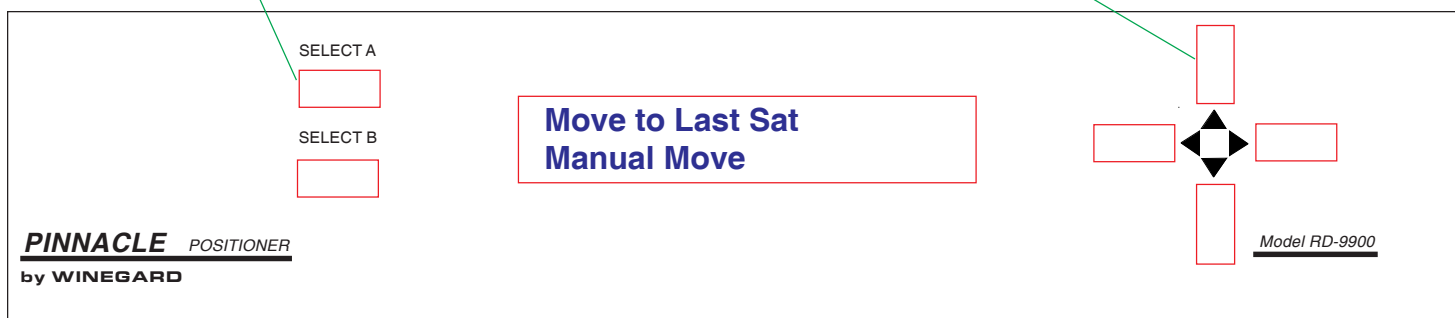

Figure 25

2. Press [SELECT A or B] **Move to Last Sat**, see Figure 25. The positioner will display the message **Moving to Satellite** while antenna is moving to last saved satellite position. When antenna stops moving, the system will acquire satellite signal (if you have not moved the RV/coach) and you will be watching TV!

# MANUAL MOVEMENT

**NOTE:** All commands will be shown in bold with brackets, example [SELECT A].

Manual Movement: This function allows you to manually move the antenna. This feature is not normally used. Since the satellite signals are digital, once the system acquires the signal, you cannot improve the picture, only increase the signal strength. To manually move the antenna, proceed as follows:

**NOTE:** To manually lower the antenna to the travel position, refer to the Troubleshooting Manual.

1. Press [UP/DOWN] arrow until **Manual Move** is displayed on positioner. See Figure 26.
2. Press [SELECT A or B] **Manual Move**, see Figure 26.

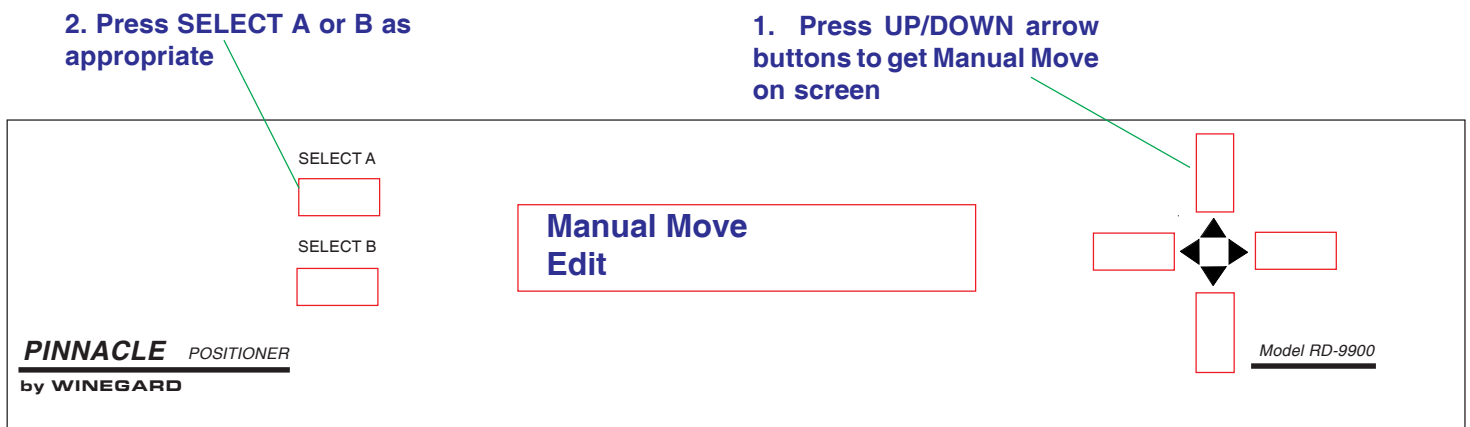

Figure 26

3. Press [ARROW BUTTONS] to move antenna in desired direction/position, see Figure 27. Figure 28 shows what the various numbers indicate on the positioner display.

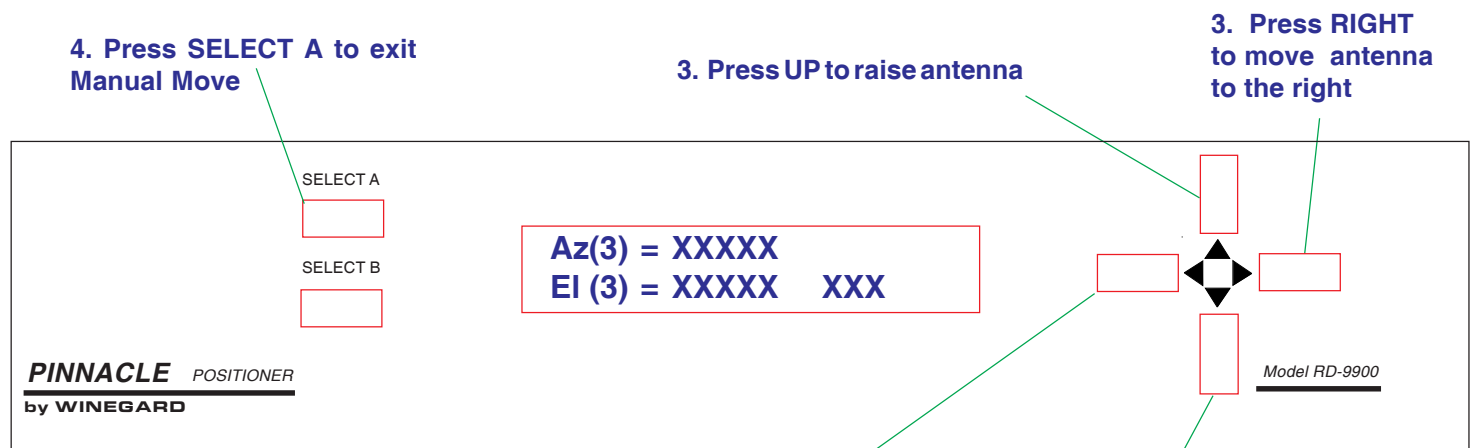

Figure 27

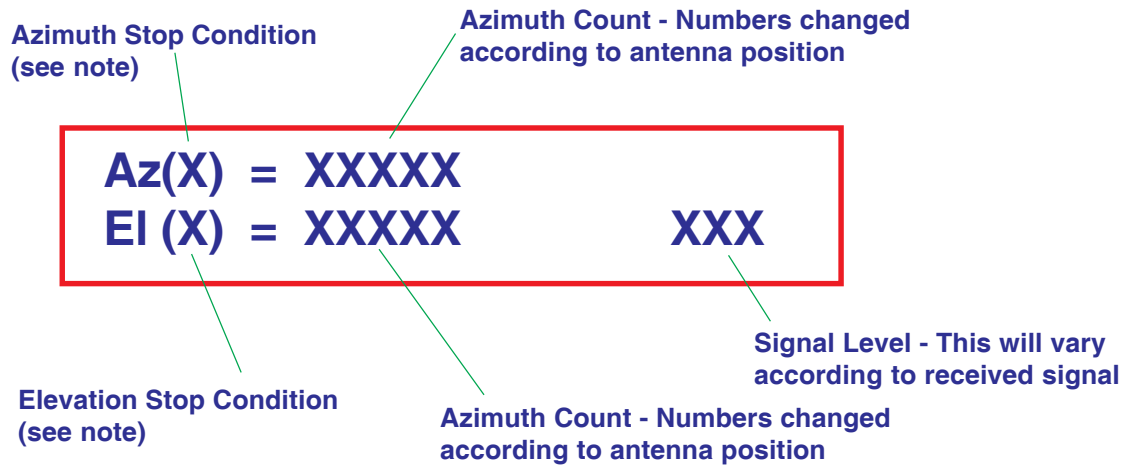

Figure 28

**NOTE:** There are five (5) motor stop conditions:

- 0 - Motor stopped under normal conditions.
- 1 - Motor stopped because a limit switch was encountered.
- 2 - Motor stopped because motor count limit was reached.
- 3 - Motor stopped because s button was pressed on the positioner.
- 4 - Motor stopped because of elevation/rotation constraints (antenna was physically stopped by an obstruction or other obstacle).

Under normal conditions the stop conditions will be 0, 1, 2, or 3. If you get number 4, refer to Troubleshooting section.



# EDIT MENU

**NOTE: All commands will be shown in bold with brackets, example [SELECT A].**

This Edit Menu allows you edit/perform the following functions: Select and edit the search satellite, return system to factory defaults, access the test functions menu, and display the system type and software version. To access the Edit Menu, proceed as follows:

1. Press **[UP/DOWN]** arrow until **Edit** is displayed on positioner. See Figure 29.
2. Press **[SELECT A or B]** Edit, see Figure 29.

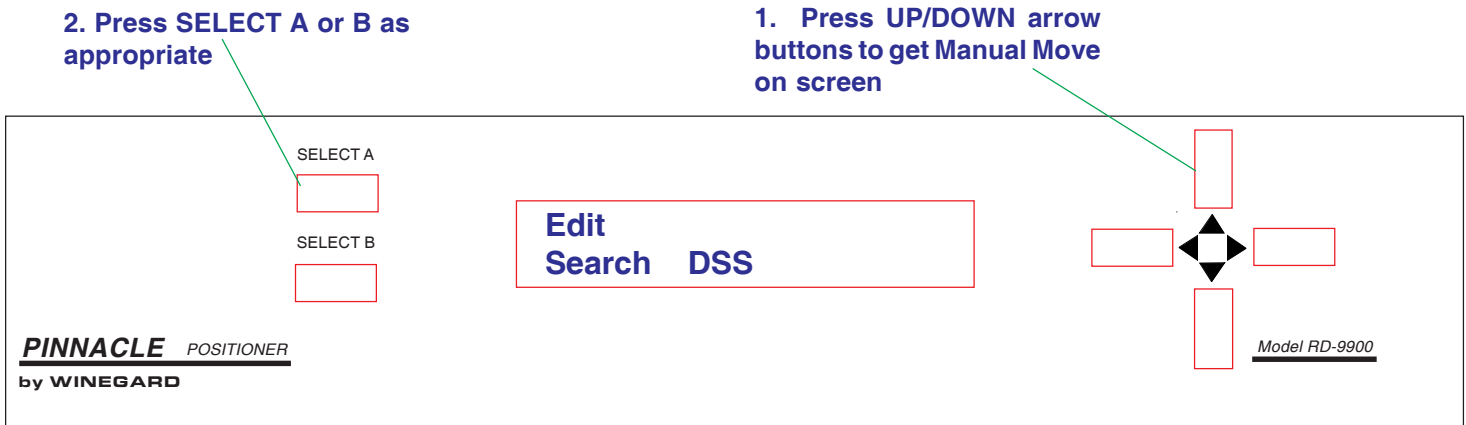

Figure 29

3. Press **[UP]** arrow button until positioner display shows **3000**. See Figure 30.

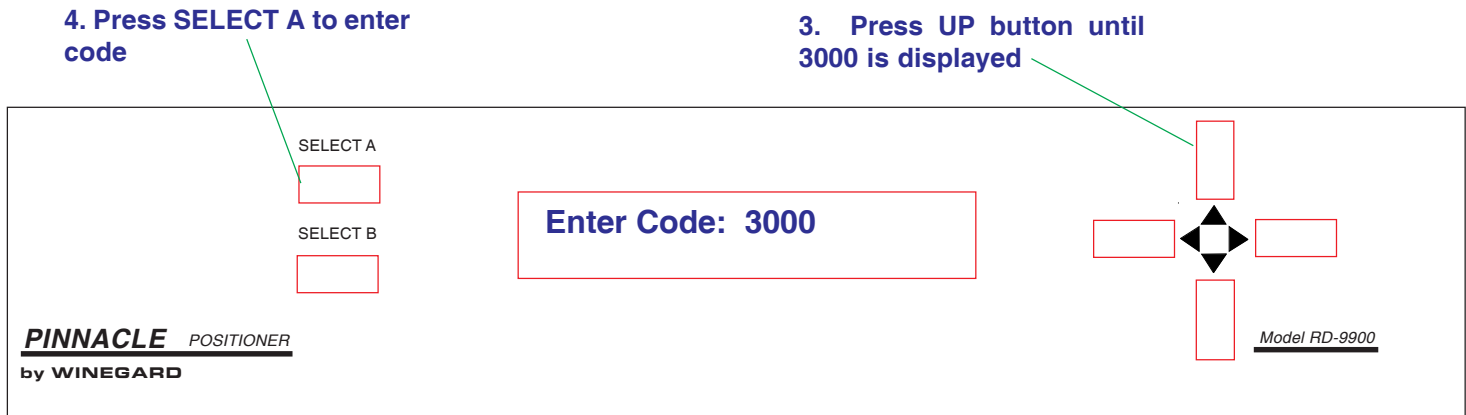

Figure 30

4. Press **[SELECT A]** **Enter Code: 3000** to access Edit Menu. See Figure 30

**NOTE: To exit Edit Menu, press [DOWN] arrow key, then [SELECT B] Quit to exit Edit Menu.**

## Select Search Satellite

The Select Search Satellite allows you to perform the following: Select which DBS satellite the system will search for, or edit the satellite name and position.

To change the search satellite, proceed as follows:

1. Press **[SELECT A]** Select Search Sat, see Figure 31.

### 1. Press SELECT A

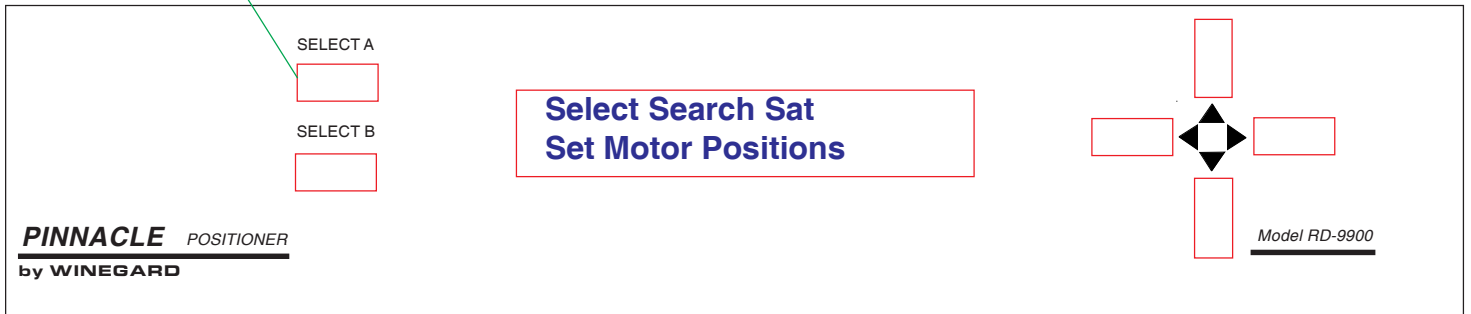

Figure 31

2. The display will show the current search satellite (factory default is the DSS® satellite(s) at 101.0 orbital position). Press **[UP]** arrow to scroll to next satellite, Figure 32.

### 2. Press UP arrow key to scroll to next satellite

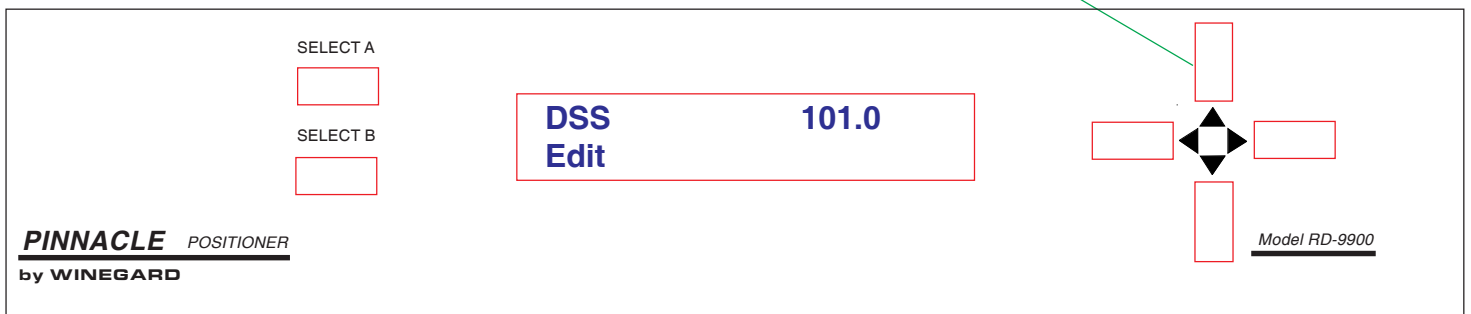

Figure 32

3. If you want to search for EchoStar® Dish Network™ satellite, press **[SELECT A]** to enter this satellite into the positioner memory as the search satellite, Figure 33. If this not the satellite you want to search for, press **[UP]** arrow key until you get the satellite you want, then press **[SELECT A]**. If the satellite you want is not in the positioner memory, proceed to Add/Edit Search Satellite, page 20.

### 3. Press SELECT A

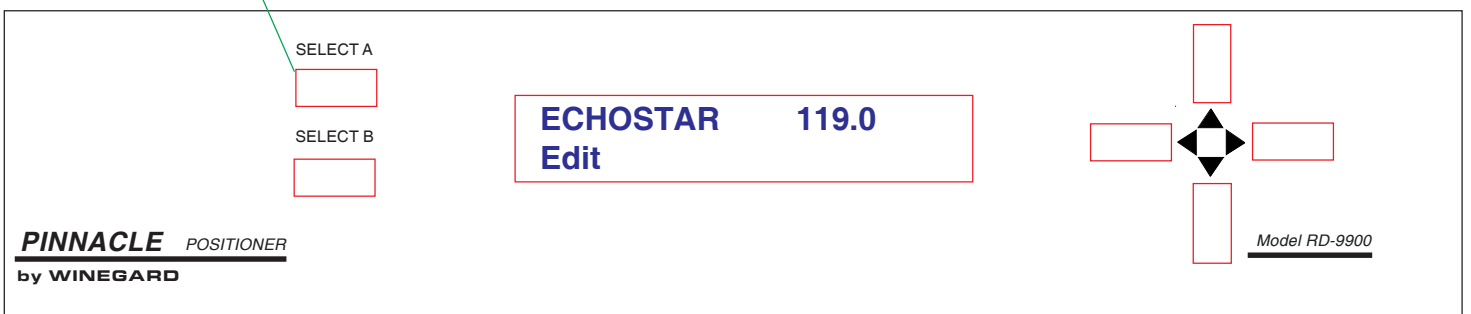

Figure 33  
38

## Add/Edit Search Satellite

If you cannot find the search satellite you want, you must add it to the positioner memory. To add/change the search satellite proceed as follows:

1. Perform steps 1 through 4 page 18 if you are not in the Edit Menu.
2. Press **[SELECT A] Select Search Sat**, see Figure 34.

### 1. Press SELECT A

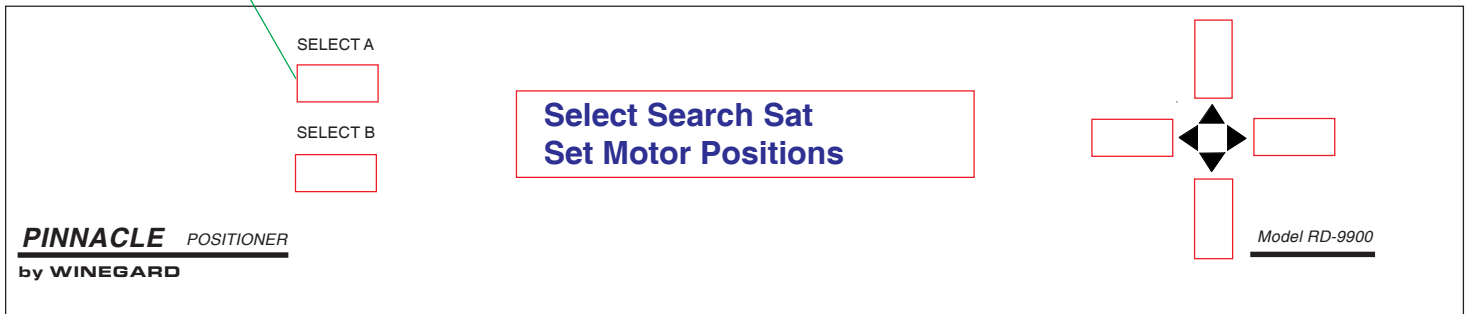

Figure 34

2. The display will show the current search satellite (factory default is the DSS satellite(s) at 101.0 orbital position). Press **[UP]** arrow to scroll to **Inactive**, Figure 35.

### 3. Press SELECT B Edit

### 2. Press UP arrow key to scroll to Inactive

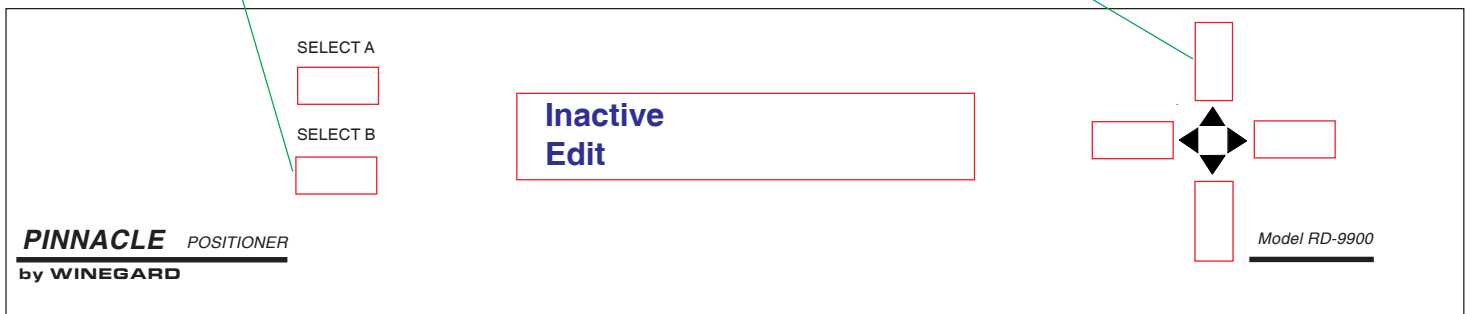

Figure 35

3. Press **[SELECT B]** to access edit menu. See Figure 35.
4. Use the **UP/DOWN/LEFT/RIGHT** arrow keys to enter the satellite name. The satellite name cannot be longer than eight (8) characters. See Figure 36.

No more than eight (8) characters for satellite name

4. Press UP arrow key to scroll to next character/number

4. Press RIGHT arrow key to scroll to next character position

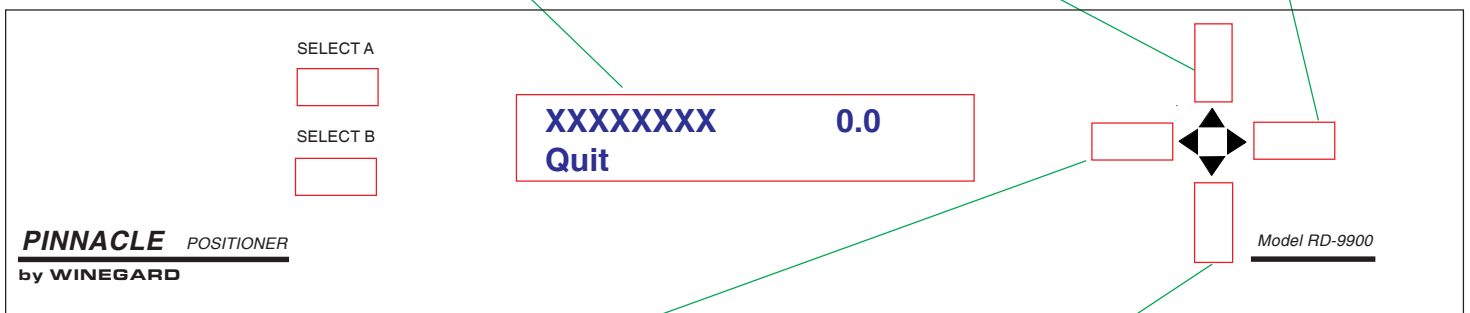

Figure 36

4. Press LEFT arrow key to scroll to previous character position

4. Press DOWN arrow key to scroll to previous character/number

5. After entering satellite name, you must enter satellite location. This is usually expressed in so many degrees west (ex. the DSS satellites are located at 101° west). Your receiver manual or program provider should tell you the satellite position. To enter satellite position, press **[RIGHT]** arrow key until satellite name is no longer highlighted, see Figure 37. Press **[UP/DOWN]** arrow keys to scroll to correct number. Numbers will scroll in .5° increments. If satellite location is XX.3, scroll number to XX.5. If number is XX.2, scroll number to XX.0. Valid satellite locations are 60 to 165 degrees.

6. Press **[SELECT A]** to enter new satellite into positioner memory. See Figure 37. If you do not want to enter satellite into the memory press **[Quit]** to return to previous menu.

5. Press **RIGHT** arrow key until satellite name is no longer highlighted

7. Press **SELECT A** to enter satellite into memory

6. Press **UP/DOWN** arrow keys to enter satellite position

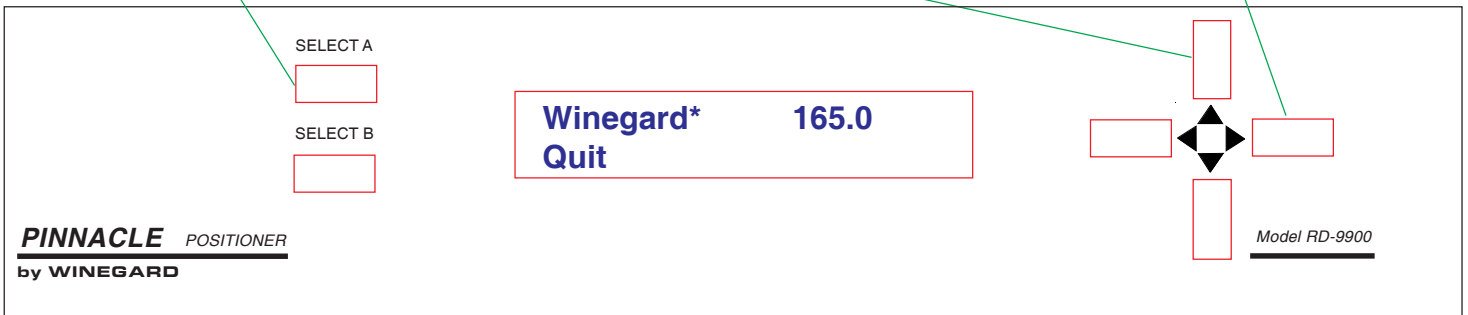

Figure 37

7. Press **[SELECT A]** again to enter your new satellite as the search satellite. See figure 38.

8. Press **SELECT A** to enter new satellite as search satellite

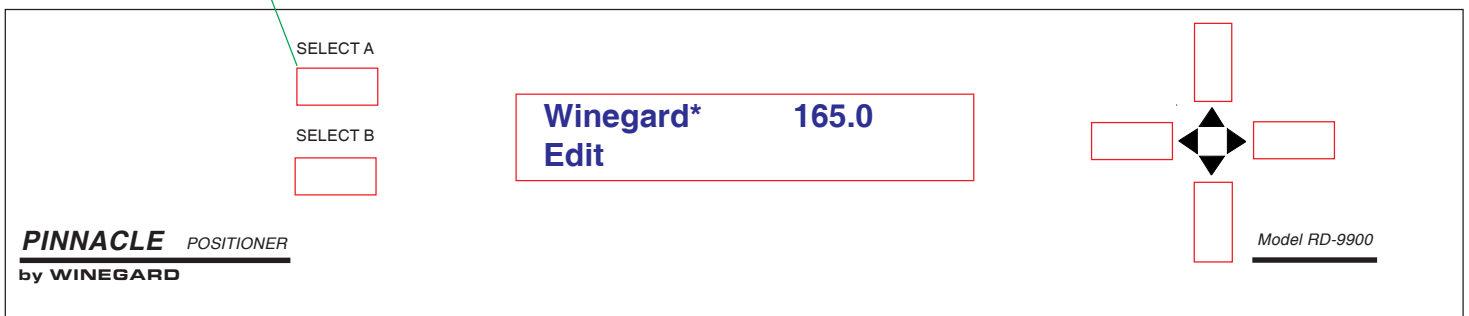

Figure 38

**\*NOTE: Wineward 165.0 is not a satellite, and is used only as an example.**

**Set Motor Positions**

Set Motor Positions is only used to lower antenna if limit switches have failed. Refer to troubleshooting section on how this procedure is performed.

**Test Functions**

Test functions is used to test various components of the system, refer to troubleshooting section on use.

**Return to Defaults**

Return to Defaults is used to return the positioner to factory settings. This should only be done when instructed to do so by a qualified technician. Refer to troubleshooting section on use.

**System Information**

System Information is used to determine what mount the positioner is set to operate and what firmware version is used in the positioner. Refer to troubleshooting section on use.

# REMOTE PANEL OPERATION

**NOTE: All commands will be shown in bold with brackets, example [SELECT A].**

The Remote Panel allows you to "hide" the positioner and still operate the system from the remote panel. Figure 39 shows the remote panel controls and operations.

**NOTE: Remote Control Panel will not work if the positioner is performing/ accessing any menu. Example: City menu, Manual Movement, Edit Menu, etc.**

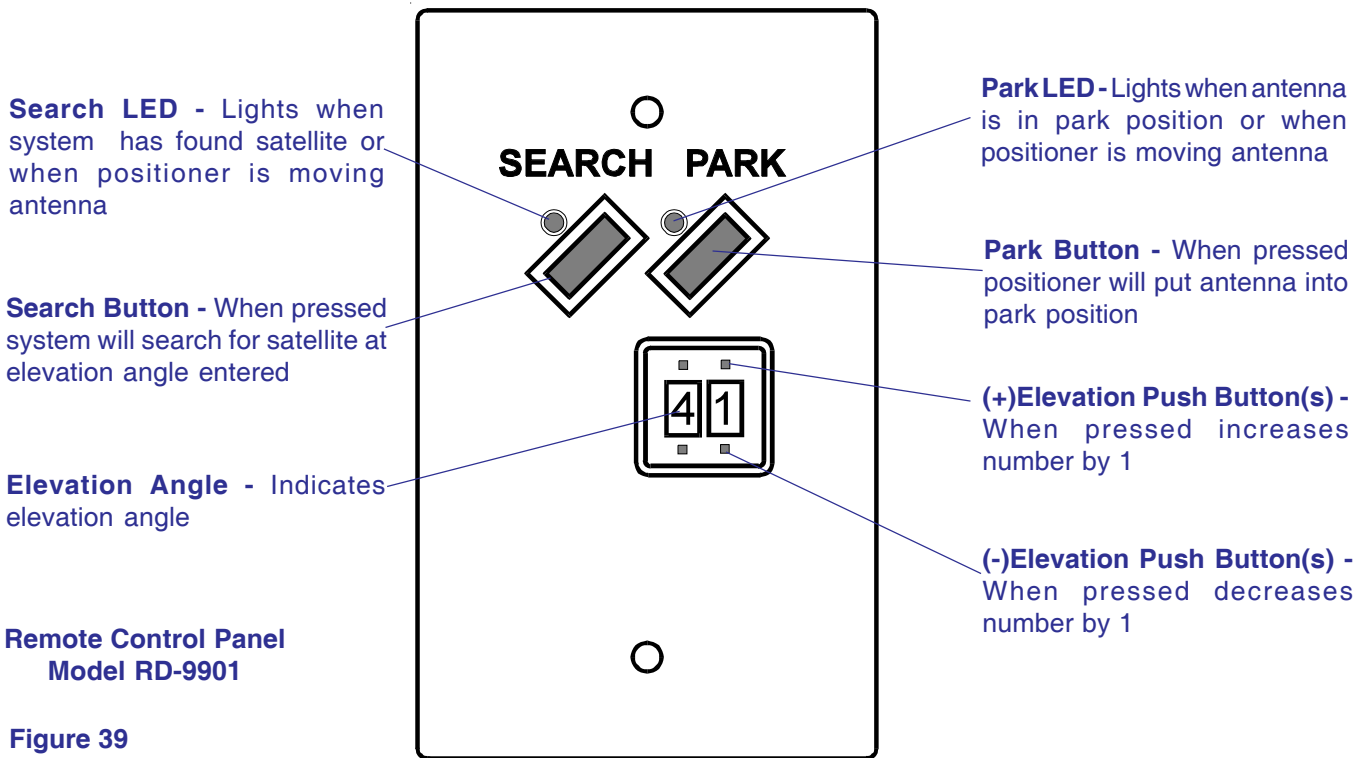

Figure 39

## Search For Satellite

To search for the satellite using the remote control proceed as follows:

1. Turn TV ON and tune to channel 3 or 4 (output channel of receiver).
2. Press **[POWER]** on receiver remote to turn satellite receiver on. Determine correct elevation angle by entering your locations ZIP code into receiver (refer to receiver manual).
3. On remote panel press **[+/-]** elevation buttons until you have the correct elevation angle, Figure 39.
4. Press **[SEARCH]** button to begin search function. Both LED's will light while antenna is moving. Only the search LED will light when the satellite is found.

**NOTE: If the wrong satellite was found, press [SEARCH] to start the search routine again.**

**NOTE: If both LED's go out, the system has not found a satellite. Verify that you have entered correct angle, and there is a clear view of the satellite.**

## Parking the Antenna

To park the antenna from the remote control panel, press **[PARK]** button. See Figure 39. Both LED's will light while antenna is moving; only the park LED will stay on once the antenna is in the park position. To stop the park function, press **[PARK or SEARCH]** button.

**NOTE: Remote Control Panel will not work if the positioner is performing/ accessing any menu.**

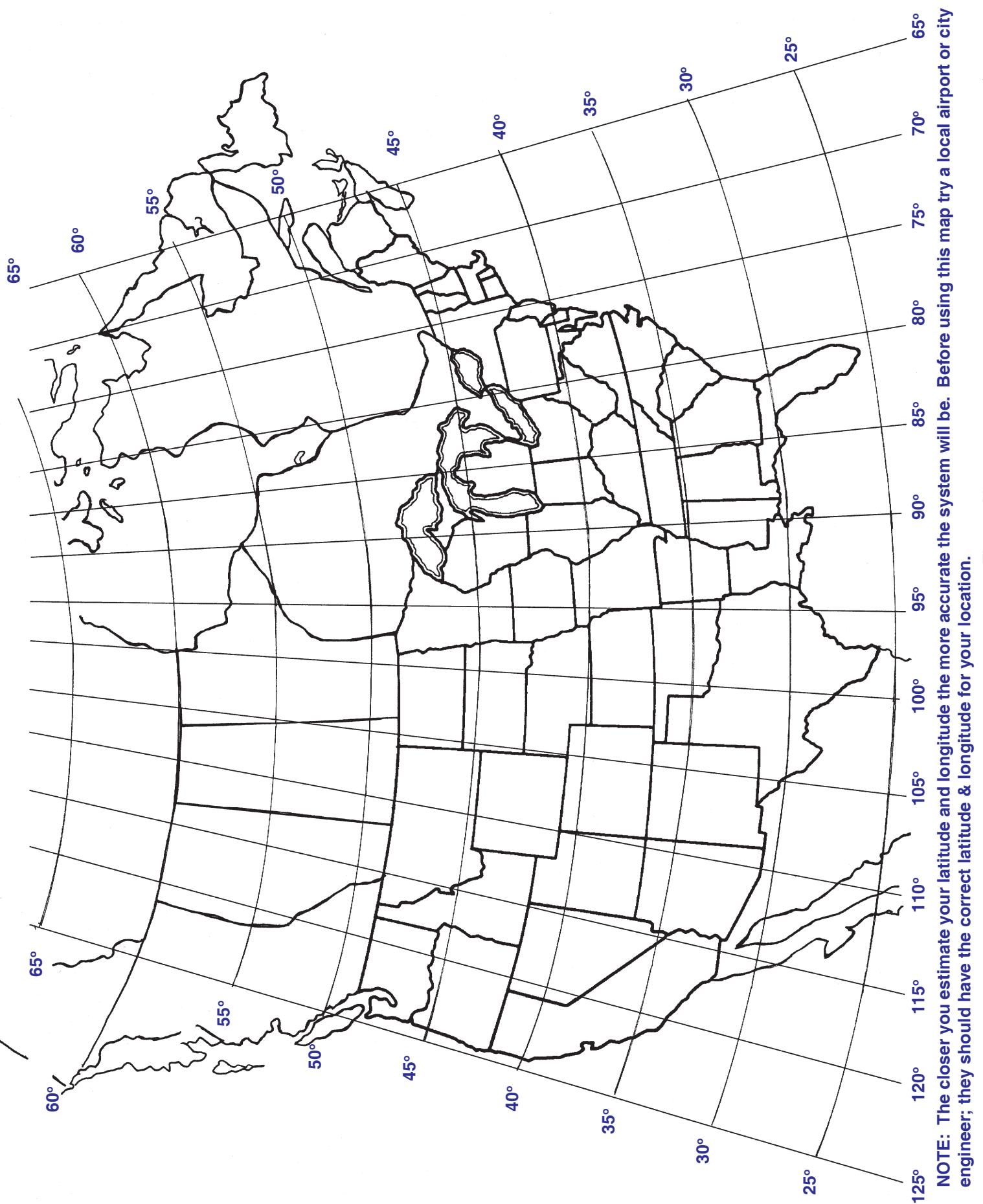

**NOTE:** The closer you estimate your latitude and longitude the more accurate the system will be. Before using this map try a local airport or city engineer; they should have the correct latitude & longitude for your location.

**Figure 40**



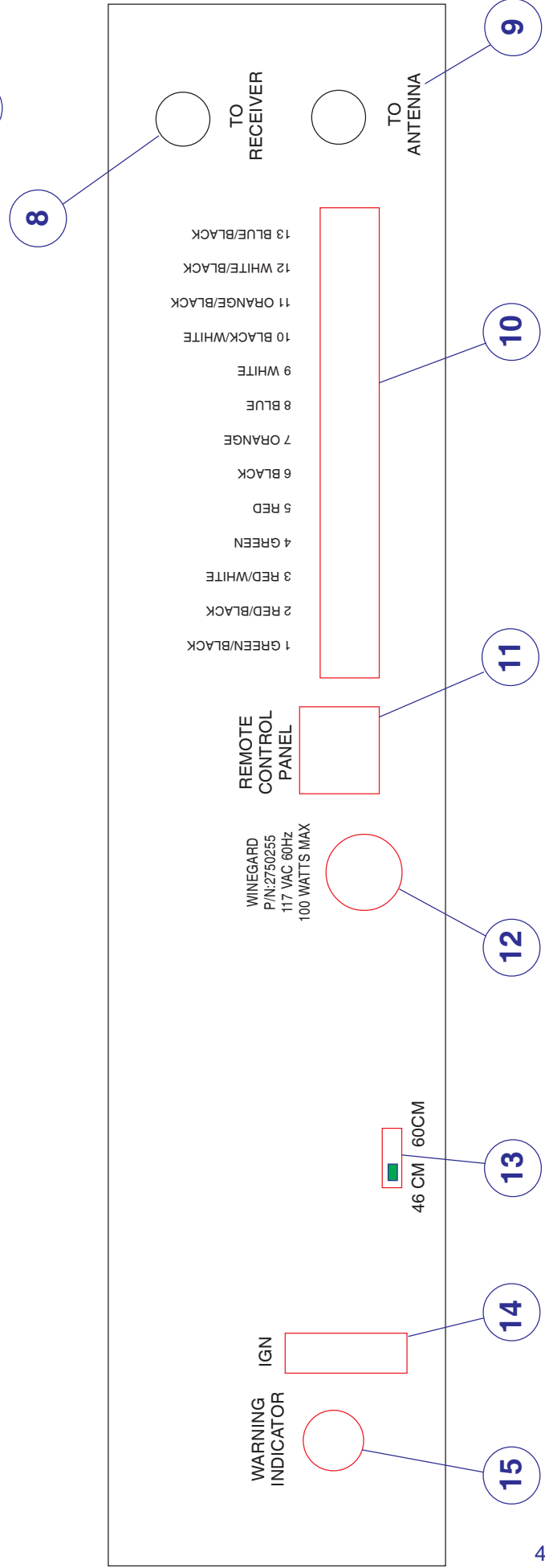
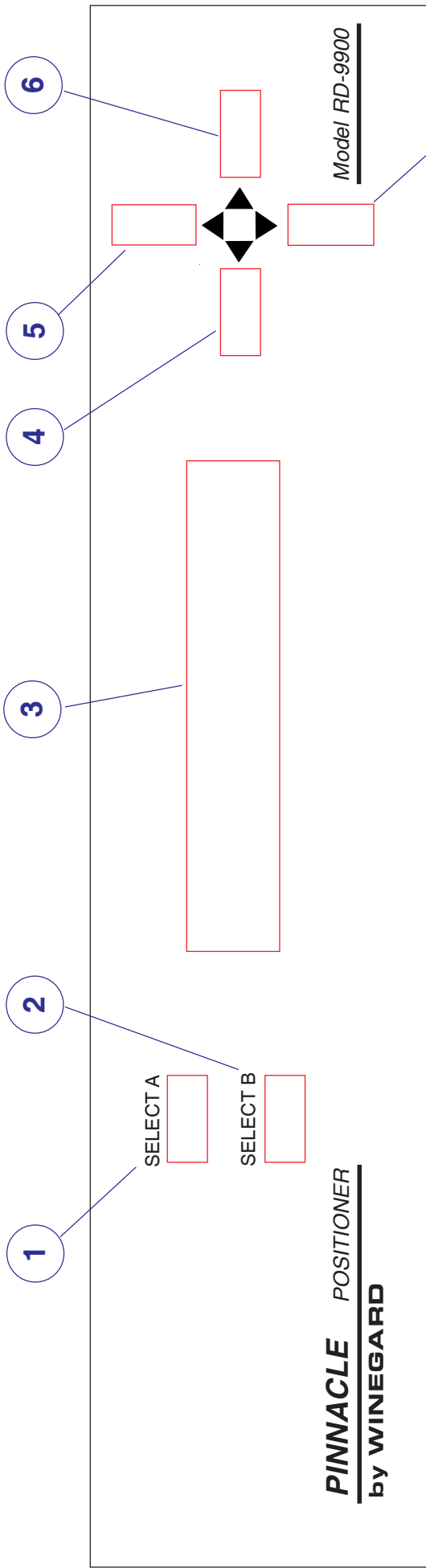

Figure 41

# POSITIONER CONTROLS & INDICATORS

---

## POSITIONER CONTROLS & INDICATORS

Positioner front and back panel wiring and controls. See Figure 41. The call-outs explain panel controls, indicators and wire connections. If you need information on system installation, refer to the Installation Manual.

1. **SELECT A:** Selects command/option displayed on top line of display.
2. **SELECT B:** Selects command/option displayed on bottom line of display.
3. **DISPLAY:** Liquid Crystal Display (LCD).
4. **LEFT:** Left arrow button, when pressed moves cursor left, or moves antenna left if in manual movement.
5. **UP:** Up arrow button, when pressed, causes screen/letter to scroll up or antenna to raise if in manual movement.
6. **RIGHT:** Right arrow button, when pressed, moves cursor to move right, or moves antenna to right if in manual movement.
7. **DOWN:** Down arrow button, when pressed causes screen/letter to scroll down or antenna to lower if in manual movement.
8. **TO RECEIVER:** 75 ohm connection to satellite receiver. There is +13 to +17 VDC present on the center conductor of this jack (used to power LNBF).
9. **TO ANTENNA:** 75 ohm satellite signal input from the LNBF on the antenna. There is +13 to +17 VDC present on the center conductor of this jack (used to power LNBF).
10. **Control Wires:** These 13 wires control the mount. There are various DC voltages present on these wires.
11. **REMOTE CONTROL PANEL:** This modular telephone type plug connects the positioner to the optional remote control wall plate (optional).
12. **AC POWER CORD:** Connect to 110 VAC outlet.
13. **46 CM - 60 CM:** Selects what size antenna the positioner is controlling (46cm = 18", 60cm = 24"). **Switch was removed 2/16/98.**
14. **IGN:** Ignition switch signal connection (optional).
15. **WARNING INDICATOR:** This jack connects the positioner to the Warning Device.

# PROGRAMMED CITY LOCATIONS

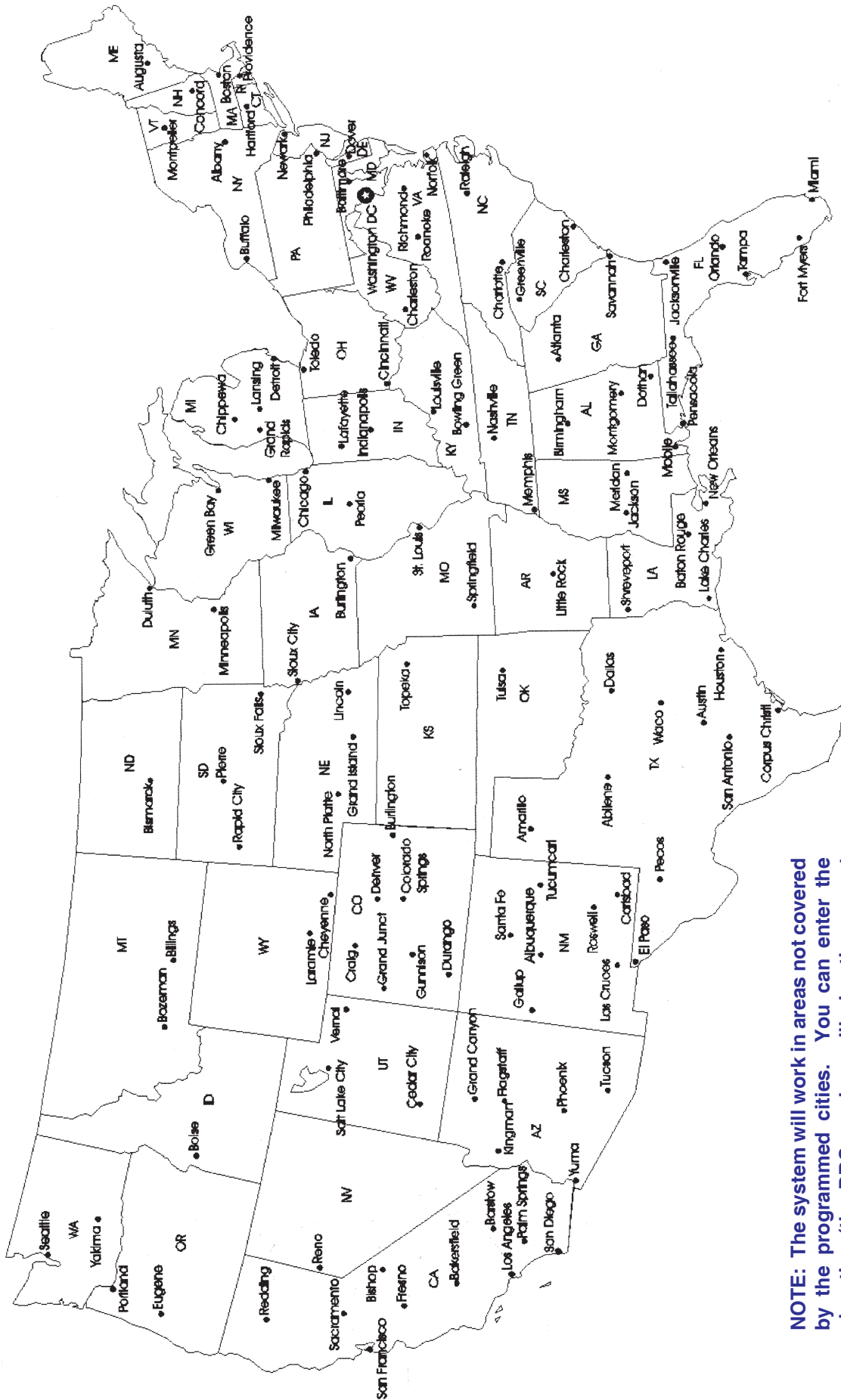

**NOTE:** The system will work in areas not covered by the programmed cities. You can enter the elevation (the DBS receiver will give the correct elevation) or the latitude and longitude of your location.

# SPECIFICATIONS/WARRANTY

## Positioner Specifications

### RF

Input Frequency ..... 950-1450 MHz  
Input Impedance ..... 75 ohms

### Power

Primary Power ..... 120 VAC, 60 Hz  
Power Consumption  
Maximum ..... 100 Watts  
Average ..... 25 Watts

### Environmental Conditions

Operating Temperature ..... 50° to 120°F  
Storage Temperature ..... -40° to +140° F  
Humidity ..... 90% noncondensing  
Size ..... 10-1/4"W x 2-5/8"H x 9-1/2"D  
Weight ..... 3.5 lbs.

### Mount Specifications

Height Lowered ..... 8-3/4"  
Height Raised ..... 30" vertical max.  
Roof space required ..... 34-15/16" x 19-3/16"  
Antenna Movement ..... 2 DC motors  
Weight ..... 25 lbs.  
Shipping Weight ..... 35.5 lbs  
Carton ..... 32"L x 20"W x 12"D

## Antenna Specifications

Reflector Diameter: ..... 46 cm (18")  
Gain at mid-range:  
11.2 GHz ..... 33.22 dBi  
12.1 GHz ..... 33.89 dBi  
12.6 GHz ..... 34.23 dBi  
Effective aperture ..... 46cm  
Aperture efficiency ..... 73%  
Cross polarization (on axis)... ..... -21 dB  
Beamwidth at -3 dB ..... 3.5°  
Beamwidth at -10 dB ..... 7.0°  
Antenna height ..... 53 cm  
Antenna width ..... 49 cm  
F/D Ratio: ..... 0.59  
Frequency Range: ..... 10.95-12.75GHz  
Offset angle: ..... 24°  
Gauge: ..... .22 gauge galvaneal steel  
Operating Temperature: ..... -40°F to +140°F  
Finish: ..... Textured thermoset powder coat

## TWO YEAR LIMITED WARRANTY

Winegard Company warrants this Winegard product (excluding receiver) against any defects in materials or workmanship within two (2) years from date of purchase. No warranty claim will be honored unless at the time the claim is made, you present proof of purchase to an authorized Winegard dealer (if unknown, please contact Winegard Company, 3000 Kirkwood Street, Burlington, Iowa 52601-2000, telephone 319-754-0600).

Winegard Company (at its option) will either repair or replace the defective product at no charge to you. This warranty covers parts, but does not cover any costs incurred in removal, shipping or reinstallation of the product. This limited warranty does not apply if the product is damaged, deteriorates, malfunctions or fails from: misuse, improper installation, abuse, neglect, accident, tampering, modification of the product as originally manufactured by Winegard, usage not in accordance with product instructions or acts of nature such as damage caused by wind, lightning, ice or corrosive environments such as salt spray and acid rain.

The Two Year Warranty is provided on the condition that the equipment is properly delivered with all handling and freight charges prepaid to your Winegard dealer for repair or return to our factory at the above address. Winegard dealers will arrange for the replacement or repair and return to you, without charge, the product which failed due to defective material or workmanship.

WINEGARD COMPANY WILL NOT ASSUME ANY LIABILITIES FOR ANY OTHER WARRANTIES, EXPRESS OR IMPLIED, MADE BY ANY OTHER PERSON.

ALL OTHER WARRANTIES WHETHER EXPRESS, IMPLIED OR STATUTORY INCLUDING WARRANTIES OF FITNESS FOR A PARTICULAR PURPOSE AND MERCHANTABILITY ARE LIMITED TO THE TWO YEAR PERIOD OF THIS WRITTEN WARRANTY.

The foregoing shall be the sole and exclusive remedy of any person whether in contract, tort or otherwise, and Winegard shall not be liable for incidental or consequential damage or commercial loss, or from any other loss or damage except as set forth above.

Some states do not allow limitations on how long an implied warranty lasts, or the exclusion of limitation of incidental or consequential damages, so the above limitations or exclusions may not apply to you.

This warranty gives you specific legal rights and you may also have other rights which vary from state to state.

# WINEGARD®

## Pinnacle® RV Digital Satellite System Models RD-9946

### Troubleshooting Manual

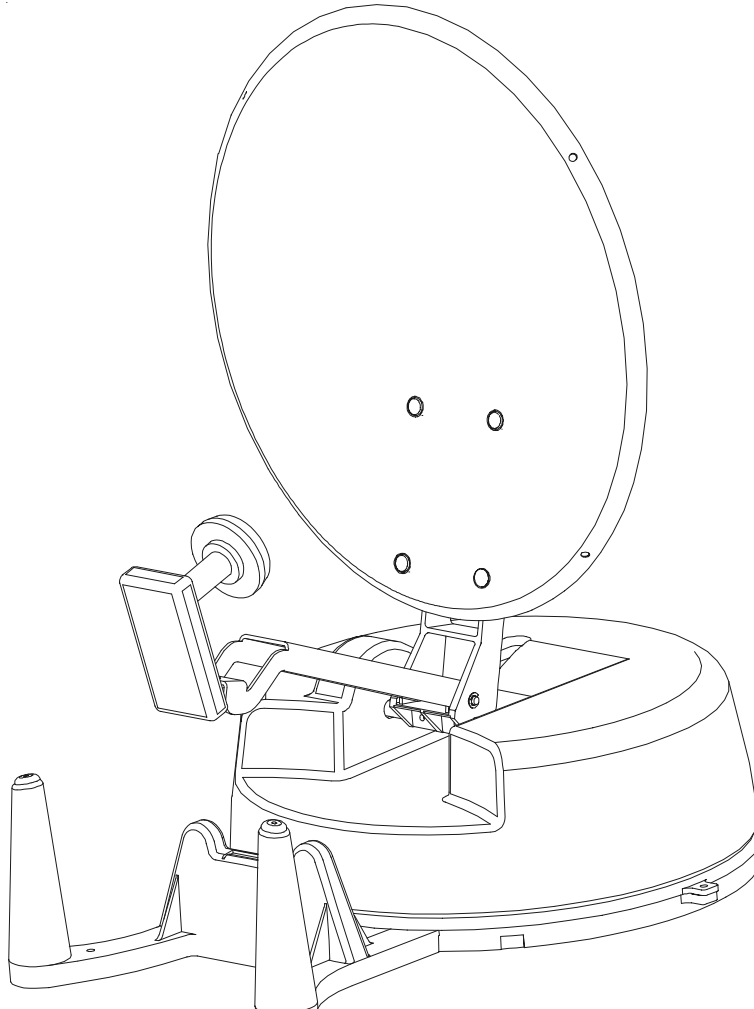

U.S. Patent No.  
5,532,710

**WARNING!**  
BEFORE ATTACHING OR REMOVING ANY CABLE/WIRES ON  
BACK OF POSITIONER, UNPLUG UNIT FROM 117 VAC SOURCE.

## IMPORTANT SAFEGUARDS

**WARNING: THIS SYSTEM HAS BEEN ADJUSTED AT THE FACTORY FOR OPTIMUM PERFORMANCE. BEFORE MAKING ANY ADJUSTMENTS, CONTACT WINEGARD CUSTOMER SERVICE.**

**WARNING: TO REDUCE RISK OF FIRE OR ELECTRICAL SHOCK, DO NOT EXPOSE TO RAIN OR MOISTURE.**  
(Not applicable to mount and antenna)

<b>CAUTION</b> <b>RISK OF ELECTRIC SHOCK</b> <b>DO NOT OPEN</b>		<b>Dangerous voltage</b> inside enclosure  <b>Refer to operating, maintenance</b> and safeguard literature accompanying unit.
<b>CAUTION: TO REDUCE RISK OF ELECTRICAL SHOCK,</b> <b>DO NOT REMOVE COVER, NO USER-SERVICEABLE PARTS INSIDE.</b> <b>REFER SERVICING TO QUALIFIED PERSONNEL</b>		

1. All the safety and operating instructions should be read before the appliance is operated.
2. The safety and operating instructions should be retained for future reference.
3. All warnings on the appliance and in the operating instructions should be adhered to.
4. All operating and use instructions should be followed.
5. Unplug this video or audio product from the wall outlet before cleaning. Do not use liquid cleaners or aerosol cleaners. Use a damp cloth for cleaning.
6. Do not use attachments not recommended by the video product manufacturer as they may cause hazards.
7. Do not use this video product near water - for example, near a bath tub, wash bowl, kitchen sink, or laundry tub, in a wet basement, or near a swimming pool, and the like.
8. If slots, holes and openings are located in the housing, they are provided for ventilation and to ensure reliable operation of the video product and to protect it from overheating. These openings should never be covered. The openings should never be blocked by placing the video product on a bed, sofa, rug, or other similar surface. This video product should never be placed near or over a radiator or heat register. This video product should not be placed in a built-in installation such as a bookcase or rack unless proper ventilation is provided or the manufacturer's instructions have been adhered to.
9. This video product should be operated only from the type of power source indicated in electrical rating printed on the appliance or power supply.
- 10A. If the appliance is equipped with a polarized alternating-current line plug (a plug having one blade wider than the other) this plug will fit into the power outlet only one way. This is a safety feature. If you are unable to insert the plug fully into the outlet, try reversing the plug. If the plug should still fail to fit, contact an electrician to replace your obsolete outlet. Do not defeat the safety purpose of the polarized plug.
- 10B. If the appliance is equipped with a 3-wire grounding-type plug, a plug having a third (grounding) pin, this plug will only fit into a grounding-type power outlet. This is a safety feature. If you are unable to insert the plug into the outlet, contact an electrician to replace your obsolete outlet. Do not defeat the purpose of the grounding-type plug.
11. Power-supply cord should be routed so that it is not likely to be walked on or pinched by items placed upon or against it, paying particular

attention to cord at plug, convenience receptacle and the point where cord exits from the appliance.

12. If an outside antenna or cable system is connected to this video product, be sure system is grounded so as to provide some protection against voltage surges and built-up static charges. Proper method is shown below.

### EXAMPLE OF ANTENNA GROUNDING AS PER NATIONAL ELECTRICAL CODE INSTRUCTIONS

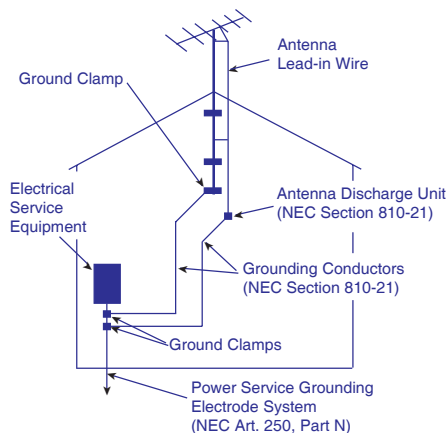

NEC - NATIONAL ELECTRICAL CODE

13. An outside antenna system should not be located in the vicinity of overhead power lines or other electric light or power circuits, or where it can fall into such power lines or circuits. When installing an outside antenna system, extreme care should be taken to keep from touching such power lines or circuits as contact with them might be fatal.
14. For added protection for this video product during a lightning storm, or when it is left unattended and unused for long periods of time, unplug it from the wall outlet and disconnect the antenna or cable system.
15. Do not overload wall outlets and extension cords as this can result in a risk of fire or electric shock.
16. Never push objects of any kind into this video product through openings as they may touch dangerous voltage points or short-out parts that could result in a fire or electric shock. Never spill liquid of any kind on the video product.

17. Do not attempt to service this video product yourself as opening or removing covers may expose you to dangerous voltage or other hazards. Refer all servicing to qualified service personnel.
18. Unplug this video product from the wall outlet and refer servicing to qualified service personnel under the following conditions:
  - a. When the power supply cord or plug is damaged.
  - b. If liquid has been spilled or objects have fallen into the video product.
  - c. If the video product, except for antenna mounted preamplifiers and downconverters, has been exposed to rain or water.
  - d. If the video product does not operate normally by following the operating instructions. Adjust only those controls, when provided, that are covered by the operating instructions. An improper adjustment of other controls may result in damage that will often require extensive work by a qualified technician to restore the video product to its normal operation.
  - e. If the video product has been dropped or the housing has been damaged.
  - f. When the video product exhibits a distinct change in performance - this indicates a need for service.
19. When replacement parts are required, be sure the service technician has used replacement parts specified by the manufacturer or have the same characteristics as the original part. Improper substitutions may result in fire, electric shock or other hazards.
20. Upon completion of any service or repairs to this video product, ask the service technician to perform safety checks to determine that the video product is in proper operating condition.
21. Note to CATV system installer: This reminder is provided to call the CATV system installer's attention to Art. 820-40 of the NEC that provides guidelines for proper grounding and, in particular, specifies that the cable ground shall be connected to the grounding system of the building, as close to the point of cable entry as possible.
22. This product should be mounted to a wall or ceiling only as recommended by the manufacturer.
23. The product should be situated away from heat sources such as radiators, heat registers, stoves or other products (including amplifiers) that produce heat.

# Table of Contents

No Satellite Found .....	4
Return To Defaults .....	6
Positioner Does Not Respond .....	8
Test RD-9901 Remote Control Wallplate .....	9
Test LNB .....	14
Positioner Does Not Come On .....	16
Get "Parking System, Fail - Please Check" Message .....	17
When Searching Positioner Displays "Search Stopped" Immediately .....	18

## INTRODUCTION

The above troubleshooting procedures covered in this manual are designed so that you will not need special tools. If after trying the above procedures you still have not corrected the problem, contact your dealer or Winegard Service Department at 1-800-788-4417. The Winegard Service Department is open 7:00 a.m. to 3:30 p.m. central time Monday through Friday.

# No Satellite Found

---

If the system will not find a satellite, perform ALL of the following:

1. Is the receiver is plugged in and turned on?
2. Do you have the correct location entered (city, elevation or longitude/latitude)?
3. Is the correct search satellite entered? Echostar or DSS should appear behind "Search" on display.
4. Verify that your RV/coach is reasonably level. If the mount is sitting at too much of an angle, the system may be looking too high or too low in the sky to see the satellite.
5. Check that there is no obstructions blocking the view of the satellites. The signal from the satellite(s) **WILL NOT** pass through trees, buildings, mountains etc. Remember that the antenna has a 24° offset, this means that when the antenna is straight up and down (90°) it is looking 24° into the sky. See Figure 1.

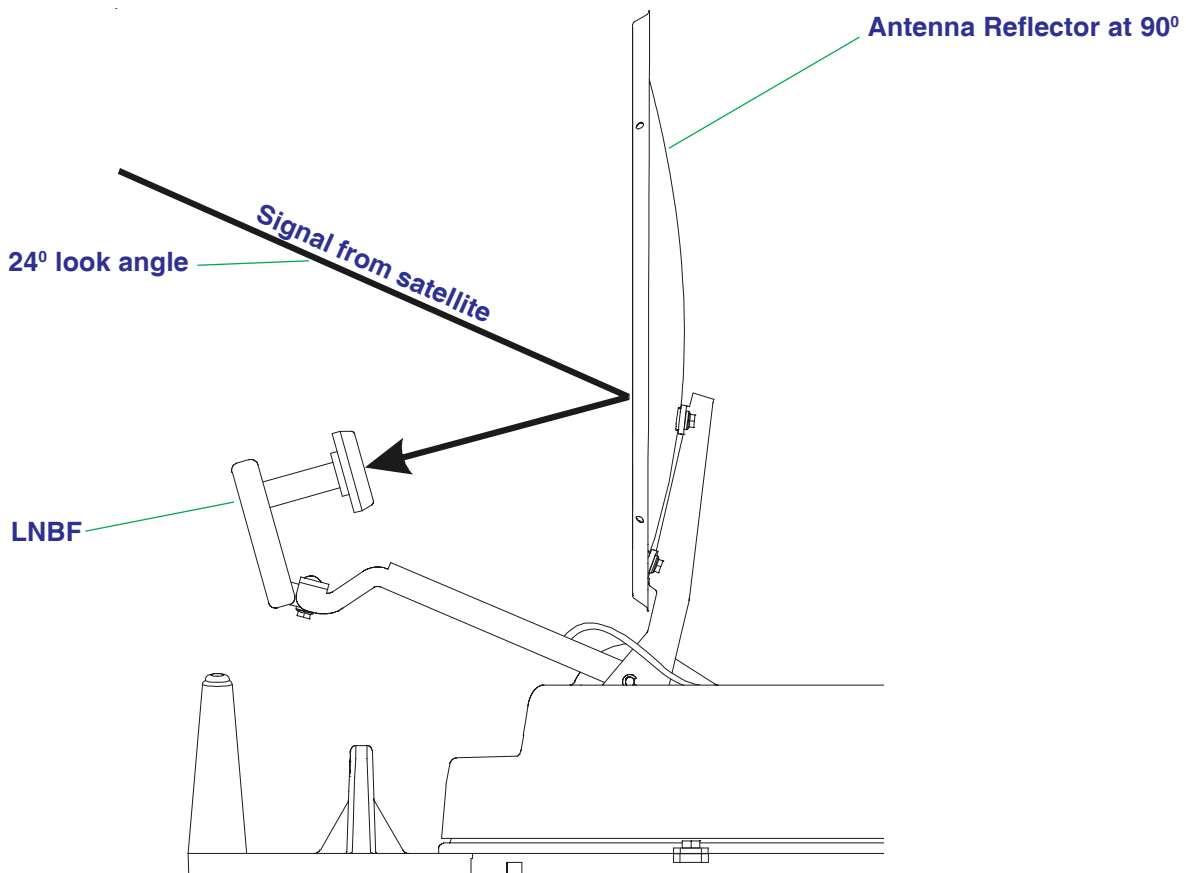

Figure 1



6. If search satellite and search method is correct (correct city, elevation, etc.) return the positioner to factory default. See Return To Defaults, page 6.

If after returning the positioner to factory defaults and reentering the correct city and satellite the system still does not find the satellite proceed to the next step. You will need a voltmeter or Winegard Model TE-1400 voltage tester for steps 7 through 10.

7. Check for +12 to +19 VDC at LNBF coax connector, see Figure 2. If correct voltage is present, proceed to step 11; if there is no voltage, proceed to next

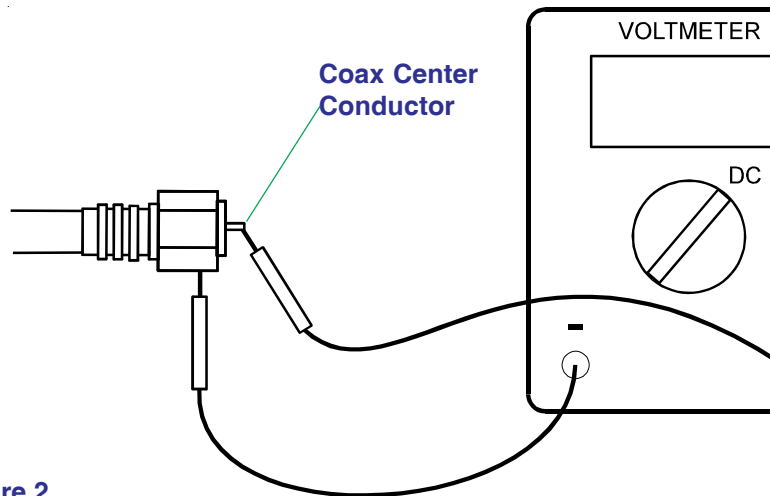

Figure 2

step.

8. Remove the coax download from the **SAT IN** jack on the rear of satellite receiver. Connect a short piece of coax to the **SAT IN** jack on receiver, check for +12 to +19 VDC. If voltage is correct proceed to step 9; if voltage is not present verify the receiver is plugged into AC power. If there is no voltage coming out of the **SAT IN** jack on the receiver, contact the manufacturer of the receiver. RCA 800-377-3399, Sony 800-838-7669, Dish Network 800-333-3474.

9. Remove coax download from **TO RECEIVER** jack on positioner. Check for +12 to +19 VDC at coax connector. If voltage is correct proceed to step 10; if voltage is not present verify the receiver is plugged into AC power and coax is connected to **SAT IN** jack on receiver. If there is no voltage, the coax is defective, repair/replace as required.

10. Reattach coax to **TO RECEIVER** jack on positioner. Remove the coax download from the **TO ANTENNA** jack on positioner. Connect a short piece of coax to the **TO ANTENNA** jack on positioner, check for +12 to +19 VDC. If voltage is correct, the coax coming from the antenna is defective. Repair/replace as required. If voltage is not present, verify the receiver is plugged into AC power. No voltage coming out of the **TO ANTENNA** jack on positioner indicates that positioner is defective. Contact Winegard Service Department before returning unit to be repaired.

11. Replace LNB with new one. If system still will not find satellite, replace positioner. If system still does not find a satellite, contact Winegard Service Dept.

# Return To Defaults

Perform the following commands to return the positioner to factory defaults:

1. Press **[UP/DOWN]** arrow until **Edit** is displayed on positioner. See Figure 3.
2. Press **[SELECT A or B]** Edit, see Figure 3.

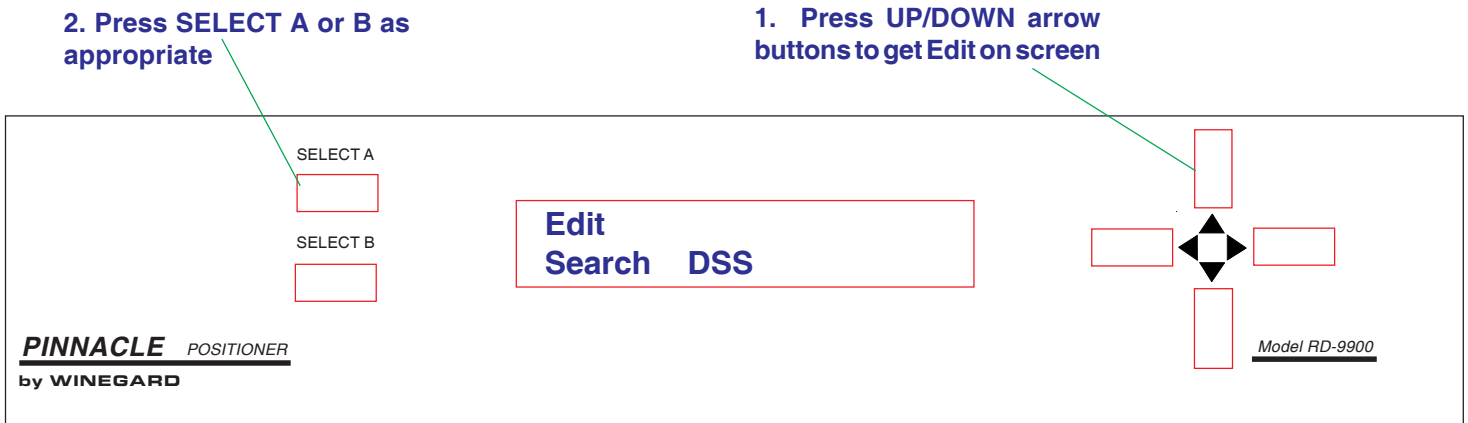

Figure 3

3. Press **[UP]** arrow button until positioner display shows **3000**. See Figure 4.

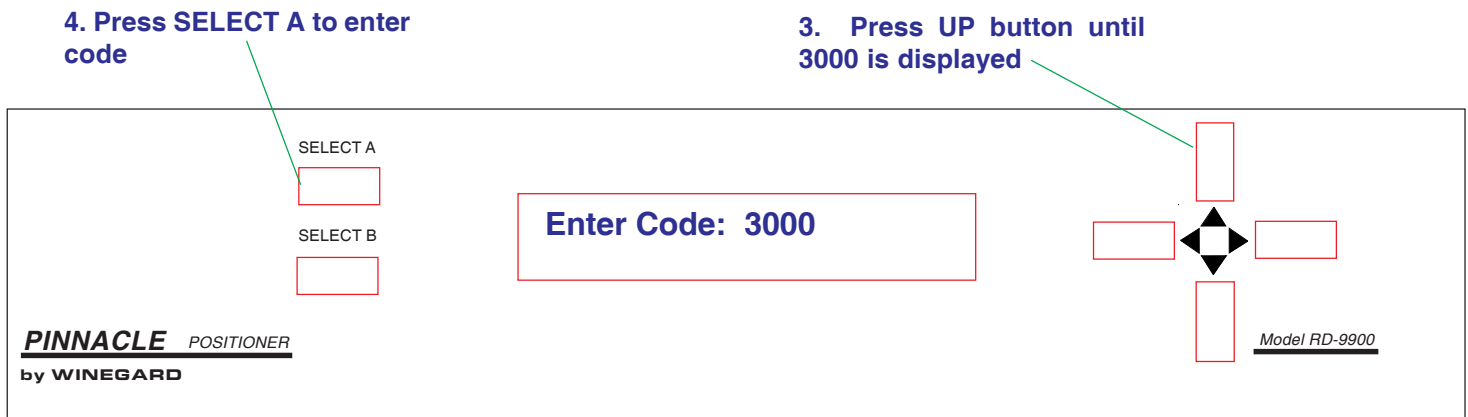

Figure 4

4. Press **[SELECT A]** Enter Code: 3000 to access Edit Menu. See Figure 4.

**NOTE:** To exit Edit Menu, press **[DOWN]** arrow key, then **[SELECT B]** Quit to exit Edit Menu.

5. Press **[UP/DOWN]** arrow until **Return to Defaults** is displayed on positioner. See Figure 5.
6. Press **[SELECT A or B]** **Return to Defaults**, see Figure 5.

6. Press **SELECT A or B** as appropriate

5. Press **UP/DOWN** arrow buttons to get **Return to Defaults** on screen

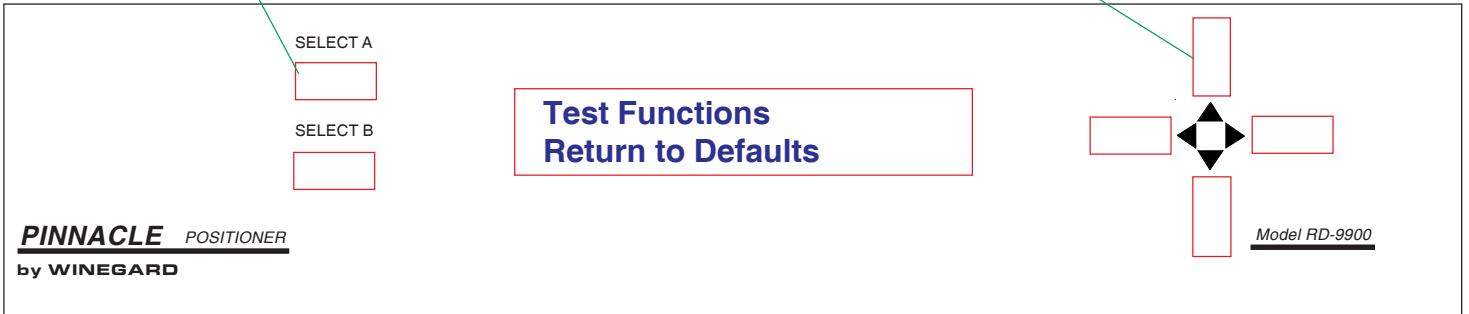

Figure 5

7. Press **[SELECT A]** **Set to Defaults**. See Figure 6.

7. Press **SELECT A**

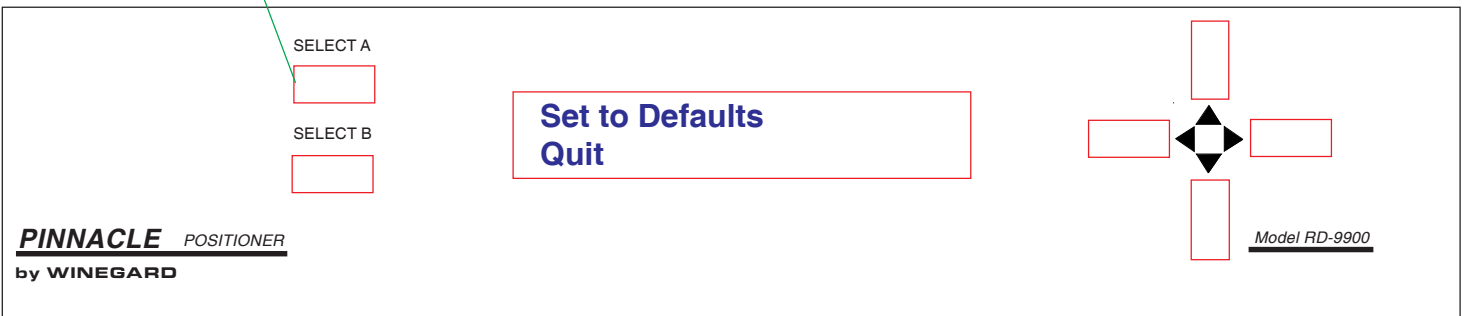

Figure 6

7. Press **[any key]** when **Memory Restored Press Any Key** is displayed on positioner, see Figure 7. If antenna is not in park position, positioner will put it in the park position. When system is park position, the main menu will be displayed.

8. Press any key

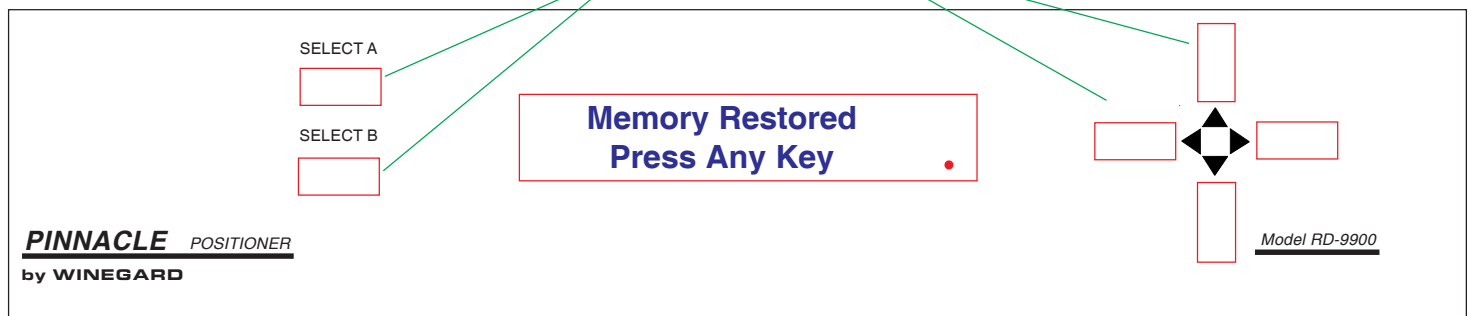

Figure 7

# Positioner Does Not Respond

If the positioner does not respond to commands, proceed as follows:

1. Unplug positioner from AC power for 3 seconds, then plug positioner back into AC power. The positioner will display the normal menu. See Figure 8.

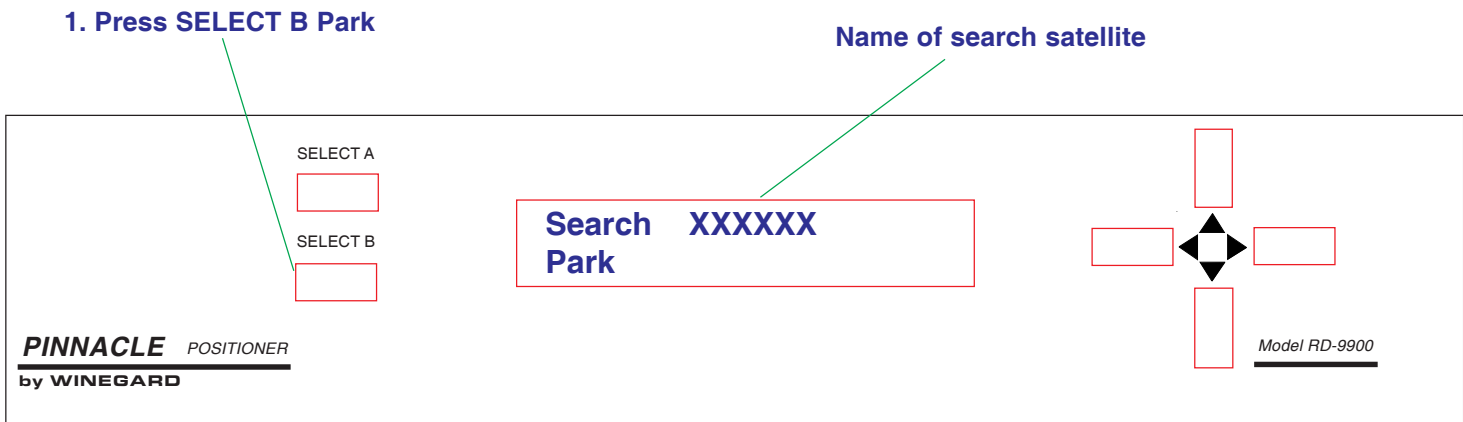

Figure 8

2. Press [SELECT B] Park to put antenna into the park position. See Fig. 8.
3. Visually verify that antenna is in correct park position.

If antenna does not go to the correct park position or fails to respond after being unplugged and then plugged in again, contact Winegrad Service Dept.

# Test RD-9901 Remote Control Wallplate

To check the Remote Control Wall Plate, proceed as follows:

1. Check that telephone-type cable is plugged securely into jack on positioner rear panel.
2. Check that telephone type cable is plugged securely into jack on side on remote control wall plate.
3. Access Edit Menu; press **[UP/DOWN]** arrow buttons until Edit is displayed on positioner display. See Figure 9.
4. Press **[SELECT A or B]** as appropriate to enter Edit Menu. See Fig. 9.

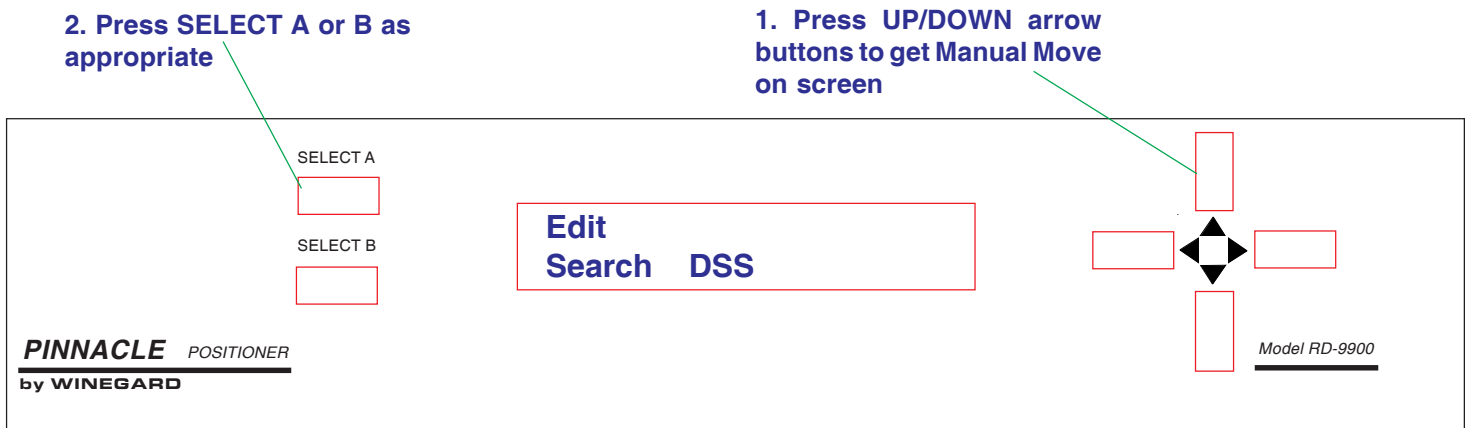

Figure 9

5. Press **[UP]** arrow button until 3000 is displayed. See Figure 10.
6. Press **[SELECT A]** to enter code. See Figure 10.
7. Press **[SELECT B]** Test Remote Panel, see Figure 11.

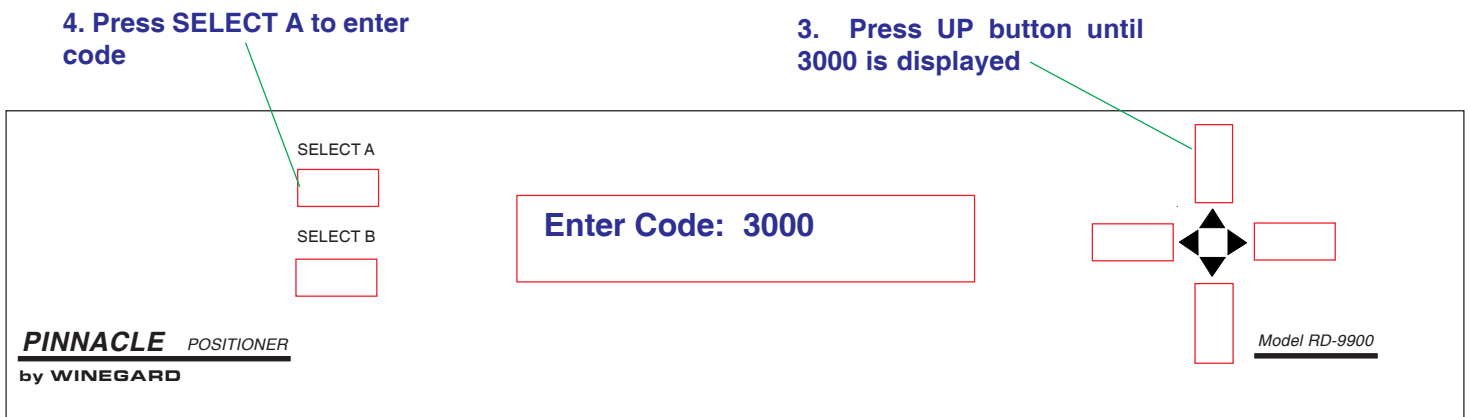

Figure 10

5. Press SELECT B Test Remote Panel

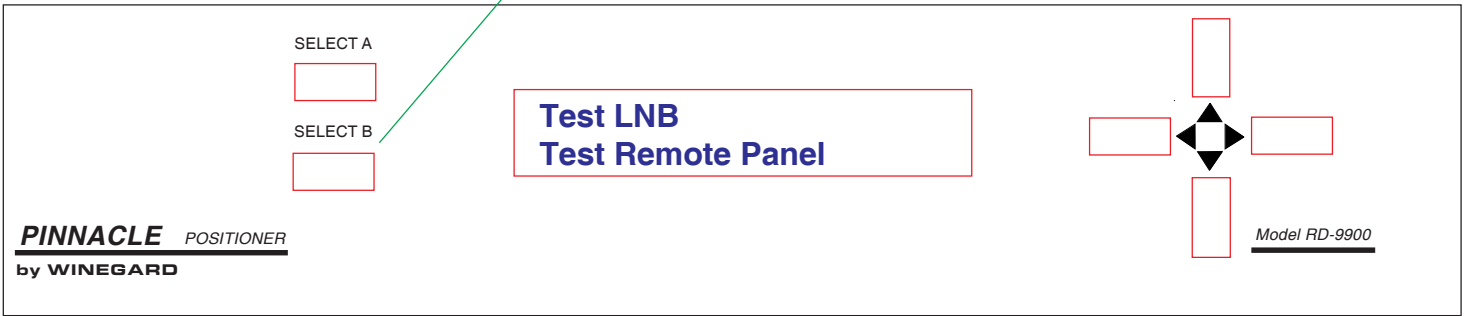

Figure 11

8. Press [SELECT A] Test Remote Panel, see Figure 12. The positioner will read the elevation from the remote panel. See Figure 13; verify that elevation is same as on remote panel.

6. Press SELECT A Test Remote Panel

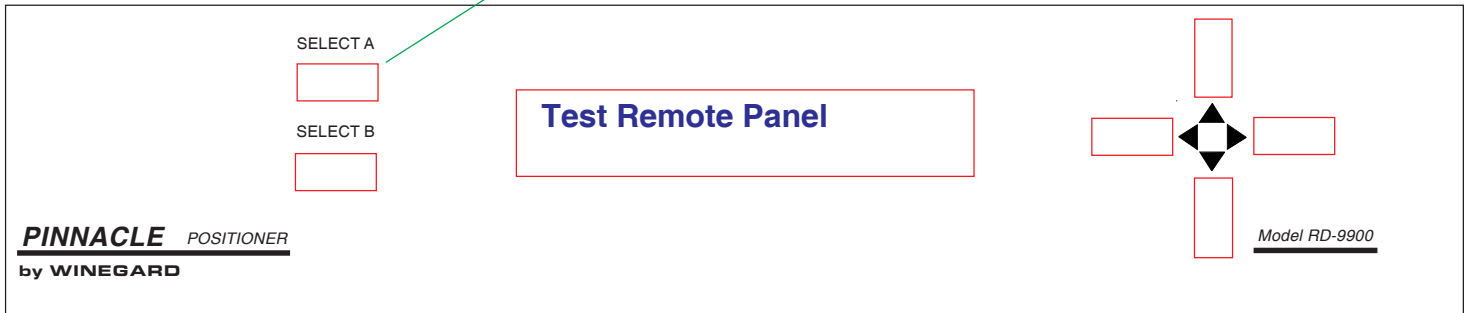

Figure 12

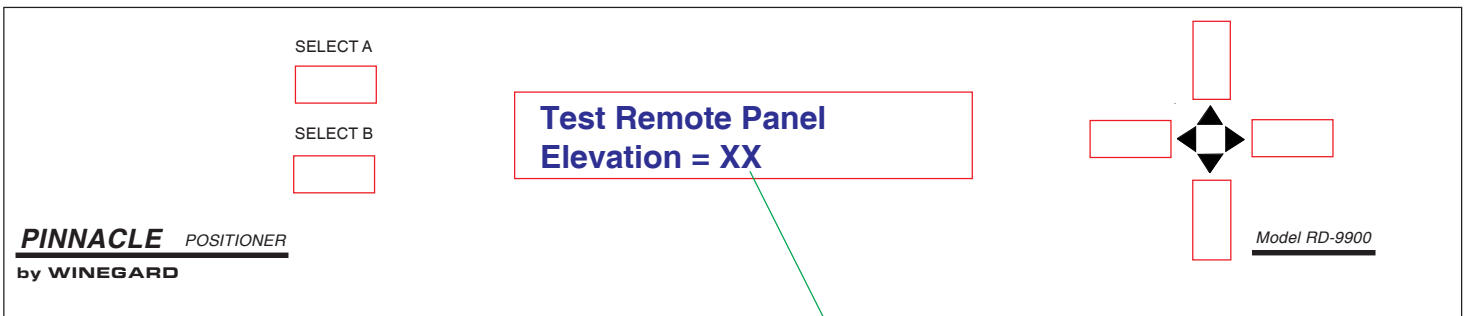

Figure 13

Elevation should be same as selected by remote panel

7. Press **[SELECT B]** to return to just **Test Remote Panel** being displayed, see Figure 14.

7. Press SELECT B

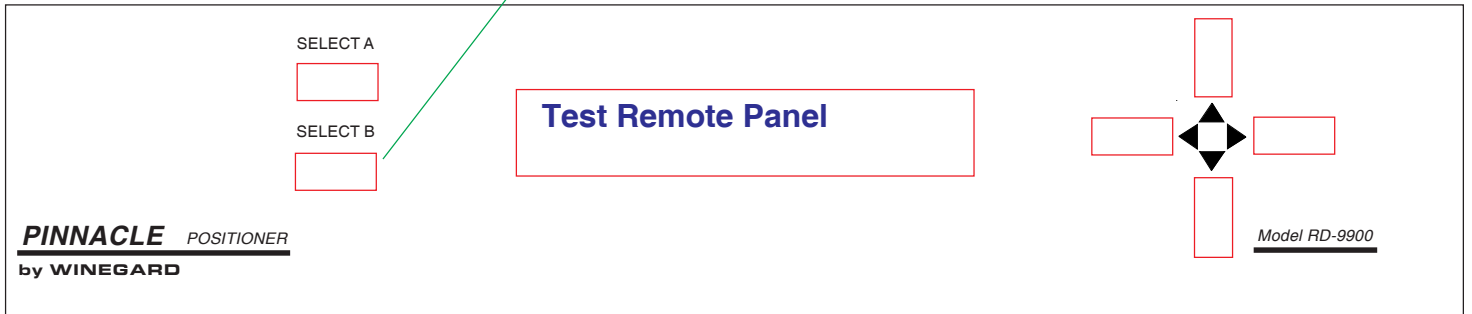

Figure 14

8. Press **[UP] arrow button** twice. Search LED will light on remote panel when **Search LED = On** is displayed on positioner. See Figure 15.

8. Press UP arrow button twice

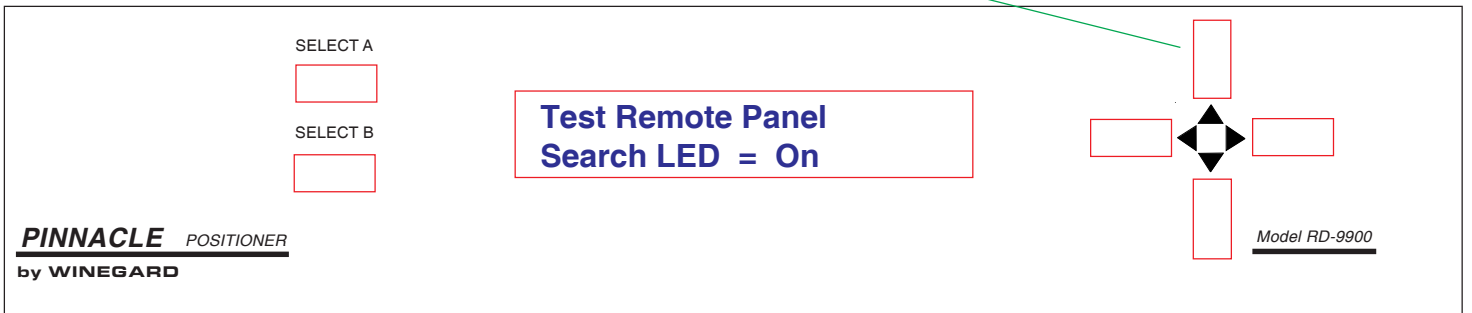

Figure 15

9. Press **[DOWN] arrow button** three times. Search LED will extinguish on remote panel when **Search LED = Off** is displayed on positioner. See Figure 16.

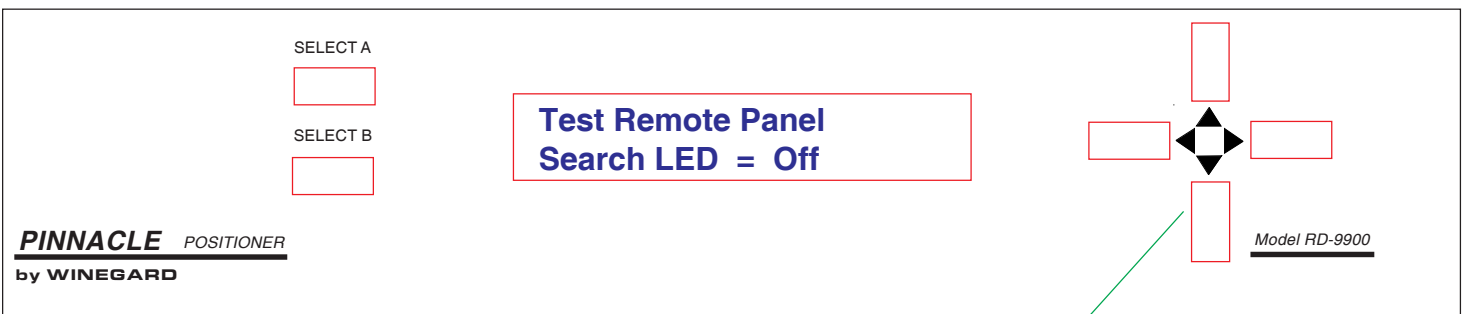

Figure 16

9. Press DOWN arrow button three times

10. Press **[RIGHT] arrow button** twice. Park LED will light on remote panel when **Park LED = On** is displayed on positioner. See Figure 17.

10. Press **RIGHT arrow button** twice

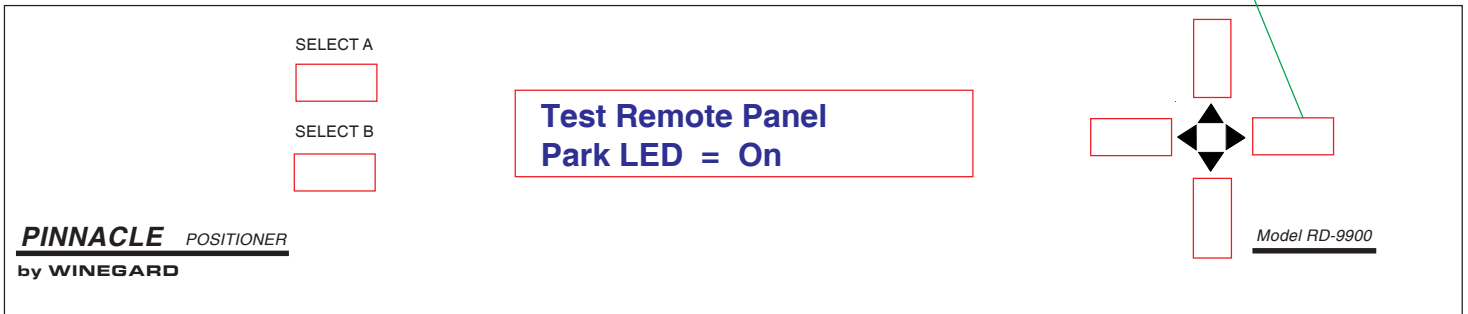

Figure 17

11. Press **[LEFT] arrow button** twice. Park LED will extinguish on remote panel when **Park LED = Off** is displayed on positioner. See Figure 18.

11. Press **LEFT arrow button** twice

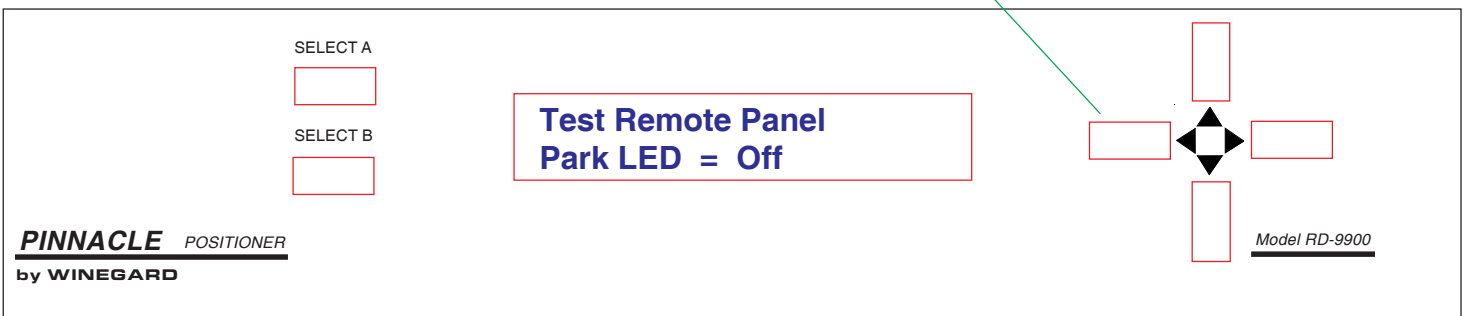

Figure 18

12. Press **[SEARCH] button** twice. **Search Key Pressed** will be displayed on positioner. See Figure 19.

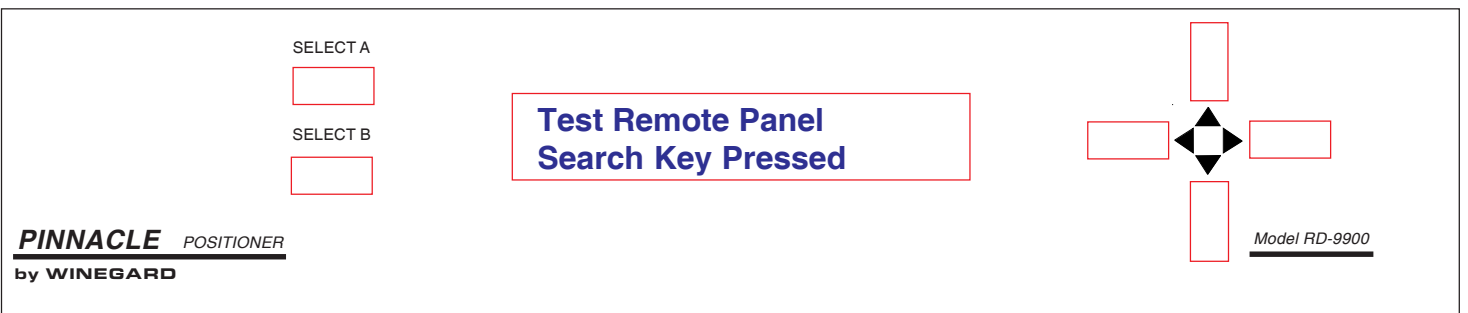
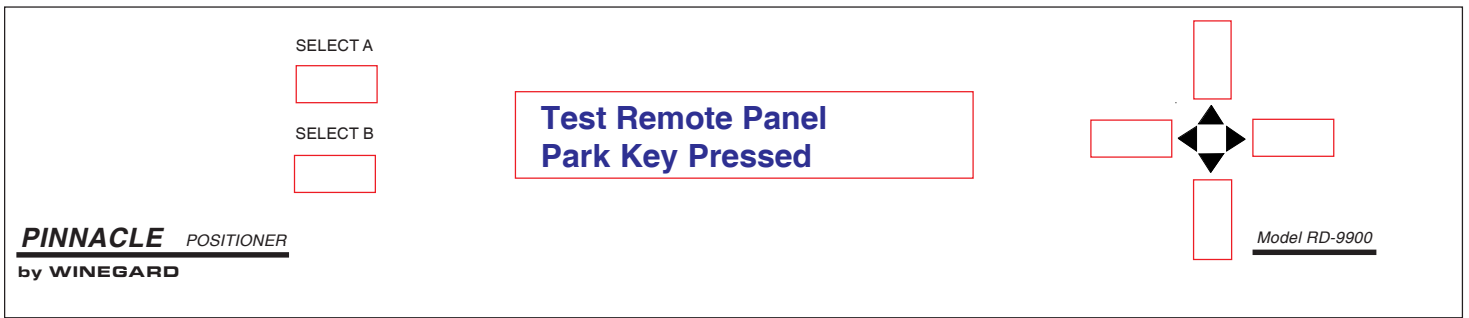

Figure 19



13. Press **[PARK]** button twice. **Park Key Pressed** will be displayed on positioner. See Figure 20.



**Figure 20**

If any of the preceding tests failed, check cable going from the remote panel to the positioner for cuts, abrasions, etc. If cable is defective, replace with 6-wire telephone type cable. If remote still does not work, contact Winegard Service Dept.

To exit test remote panel, press **[SELECT B]** twice.

# Test LNB

To test the LNB, proceed as follows:

1. Turn receiver ON. Make sure antenna is not pointed at a satellite (no picture or signal).
2. Access Edit Menu, press [UP/DOWN] arrow buttons until Edit is displayed on positioner display. See Figure 21.
3. Press [SELECT A or B] as appropriate to enter Edit Menu. See Figure 21.

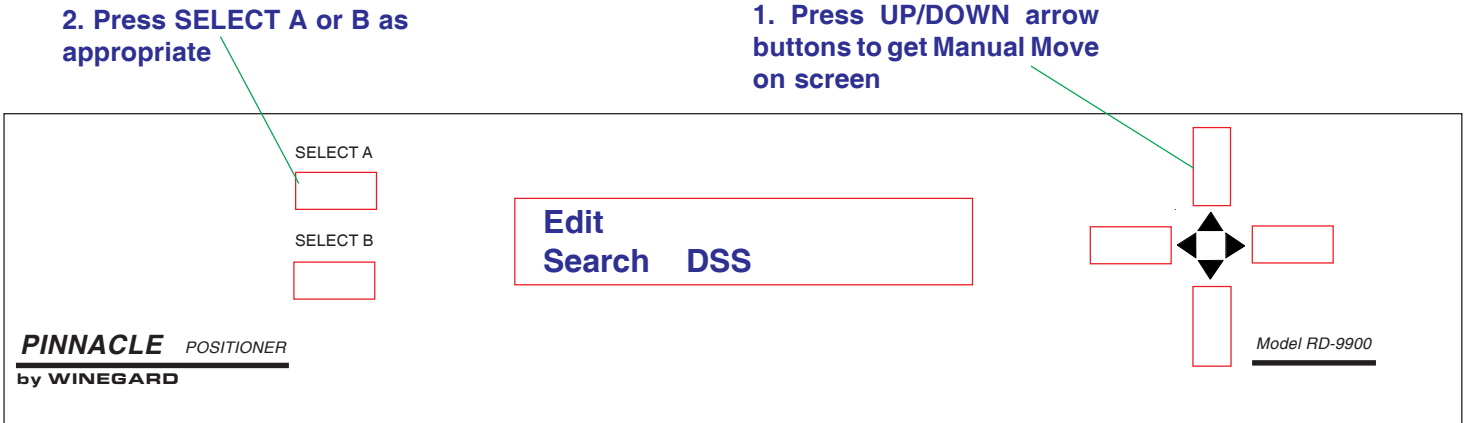

Figure 21

4. Press [UP] arrow button until 3000 is displayed. See Figure 22.
5. Press [SELECT A] to enter code. See Figure 22.

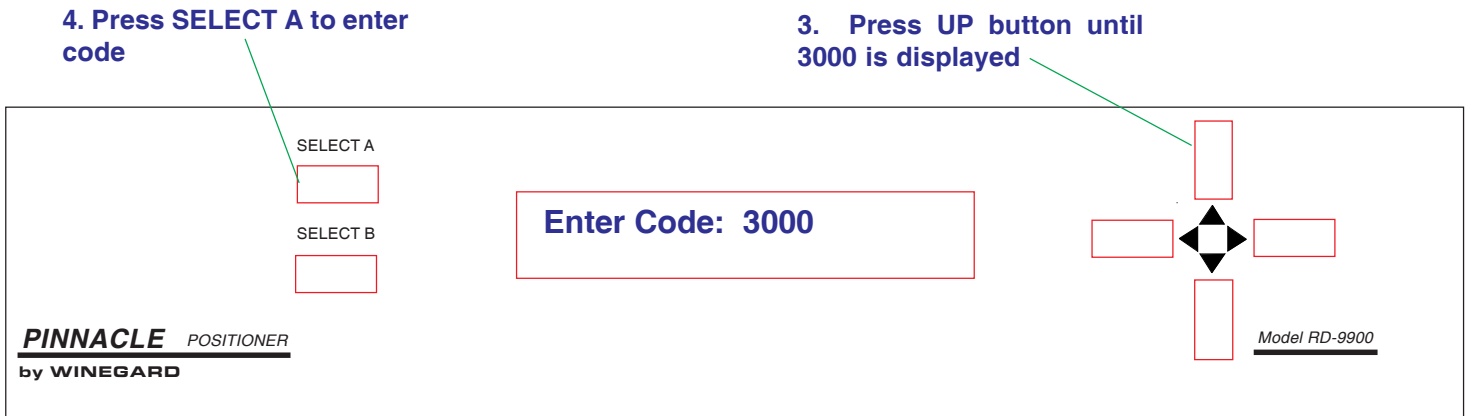

Figure 22

6. Press **[SELECT A] Test LNB**, see Figure 23. The positioner will display the menu shown by Figure 24.

5. Press **SELECT A Test LNB**

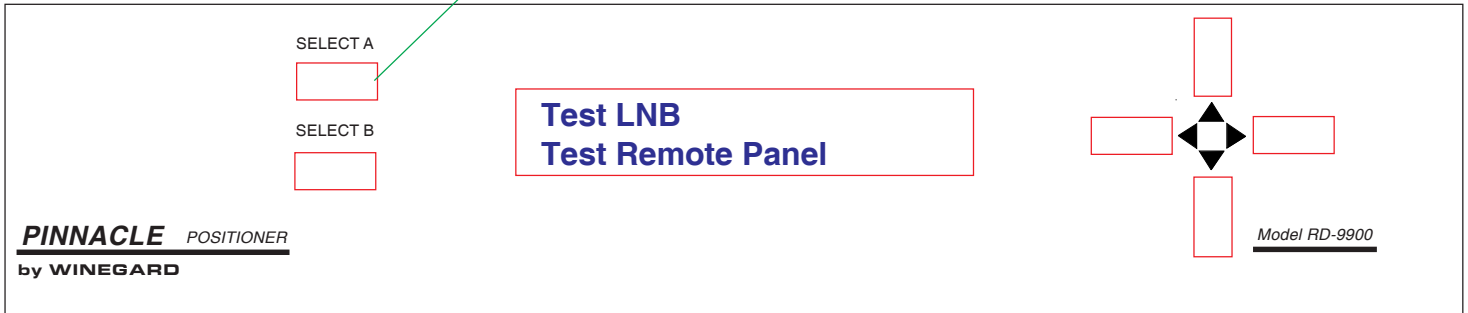

Figure 23

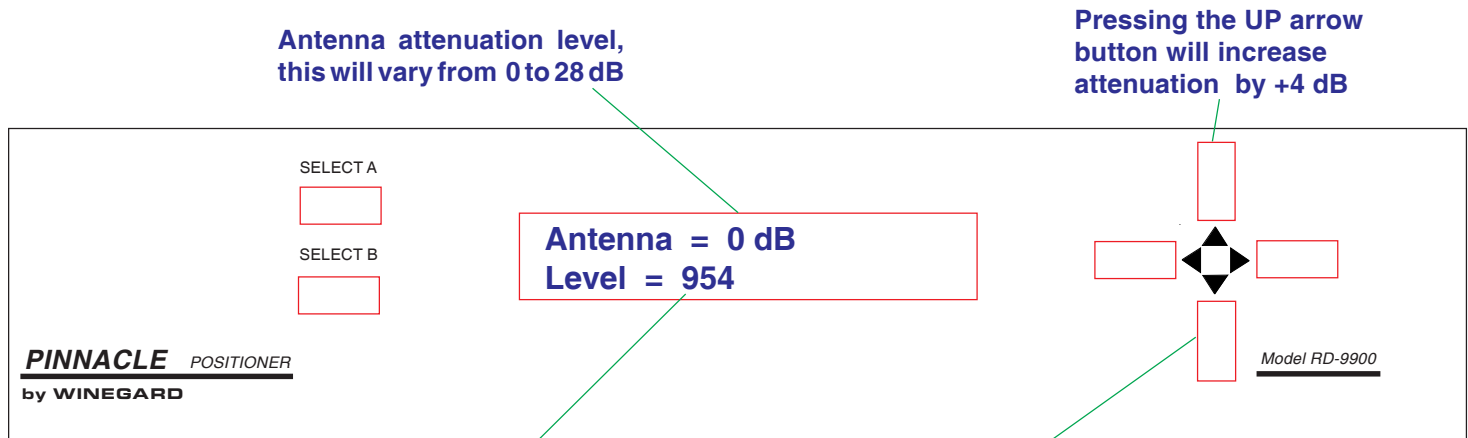

Figure 24

Signal level, max. is 1024  
min. is 0

Pressing the DOWN arrow button will decrease attenuation by -4 dB

7. The attenuation can be lowered or raised by pressing the UP/DOWN arrow buttons in 4 dB increments. With the attenuation set at 0 dB and the antenna NOT pointing at a satellite, the level should be greater than 900. As attenuation is added the signal level should drop. With the attenuation set at 28 dB, the signal level should be below 200.

If any of the above signal levels are not met, check that LNB is connected to coax download. If coax is connected to LNB, contact Winegard service Dept. for further troubleshooting assistance.

8. To exit the Test LNB menu, press either **[SELECT A or B]**.

9. To exit Edit menu, press **[UP/DOWN]** arrow button until **Quit** is displayed.

10. Press **[SELECT A or B]** as appropriate.

## Positioner Does Not Come On

If the positioner does not come on, proceed as follows:

1. Verify that the 46 CM - 60 CM switch (on the back panel) is all the way to the left or right. If switch is in the middle, positioner may not turn on. See Figure 25.

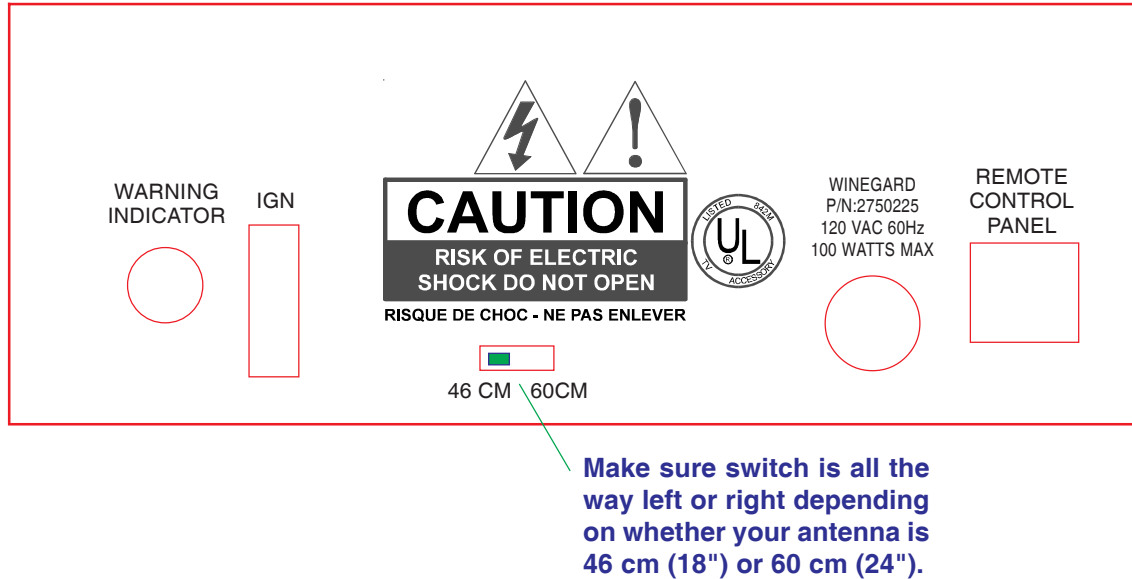

Figure 25

2. If switch is in the correct position, unplug positioner from AC power.
3. Inspect positioner AC power cord for cuts, abrasions, etc. If defective, return to Winegard Service Dept. If power cord is OK, proceed to next step.
4. Disconnect all cables from rear of positioner. Plug positioner back into AC power. If positioner comes on, there is a short in the cables that connect to the positioner; proceed to next step. If positioner does not come on, contact your dealer or Winegard Service Dept.
5. Reconnect one cable to positioner, then plug positioner back into AC power. If positioner turns on, repeat step until positioner does not turn on. The cable that shuts the positioner off is the one with the short.
6. If the cable with the short is the control cable, proceed to step 6. If one of the other cables is faulty, repair/replace cable as required to correct problem.
7. Unplug positioner. Remove mount from mount base. Disconnect the cable that is faulty at the mount.
8. Plug positioner back into AC power. If positioner does not turn on, then the 35' cable from positioner to the mount is faulty. Repair/replace as required to correct problem. If positioner does turn on, the faulty cable is in the mount. **Contact your dealer or Winegard Service Dept. before proceeding.**

## Parking System, Fail - Please Check

1. If the positioner displays the message shown in Figure 26, step out of your coach/RV and check the position of the antenna.

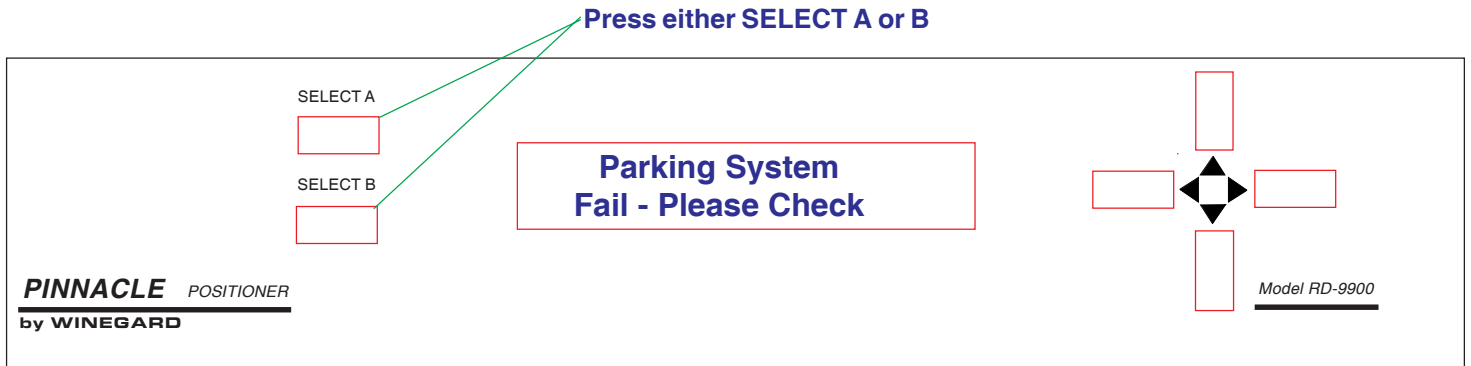

Figure 26

2. If the antenna is not in the travel position, you should climb up and verify that there are no obstructions blocking the antenna. After removing obstructions or if there are no obstructions, perform the park command again.
3. If the antenna still does not go the park position, perform the **Return To Defaults** procedure, page 6.

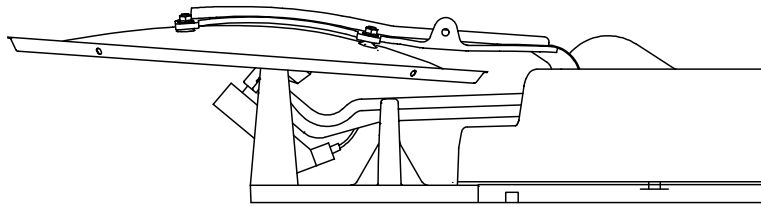

Figure 27

4. If the antenna is in the park/travel position, Figure 27, perform the park command again. If antenna Parking System Fail message still appears, perform the **Return to Defaults** procedure, page 6.
5. If problem persists, contact Winegard Service Department.

# When Searching Positioner Displays "Search Stopped"

If the antenna will not move, check the following.

1. If you have been in an ice storm or freezing rain the mount may be frozen in place. Before checking any of the following steps visually inspect the mount.
2. Double check wiring at the back of positioner. Make sure wires have good contact with the connector plug.
3. Park system and then go to manual movement. Use UP arrow button to move to antenna up. The numbers displayed will go higher as you hold the button down. Hold the button down until you get a number higher than 6000.
4. Press LEFT arrow button to move antenna counterclockwise. The numbers will decrease from 30000.

**NOTE: If either step 3 or 4 fails, you have a wiring problem. Proceed to step 5. If steps 3 and 4 pass, perform Return to Defaults, see page 6.**

5. Check that wires are attached correctly to the 13 pin connector. See

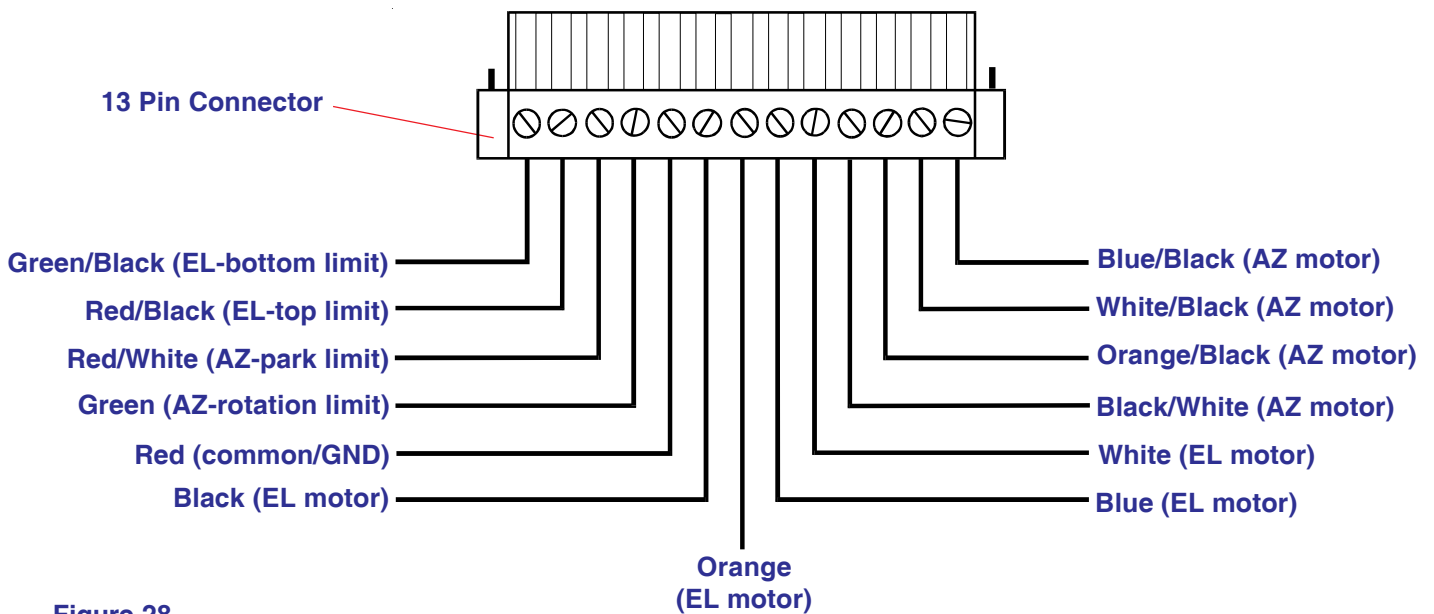

Figure 28

Figure 28.

6. Disconnect then reconnect the 13 pin connector on the positioner. Repeat steps 3 and 4.

7. Remove mount from mount base. Disconnect then reconnect the 13 pin connector on the mount. Repeat steps 3 and 4.

If problem still continues, contact Winegard Service Department.

# WINEGARD®

## Pinnacle® RV Digital Satellite System Models RD-9946

### Parts List

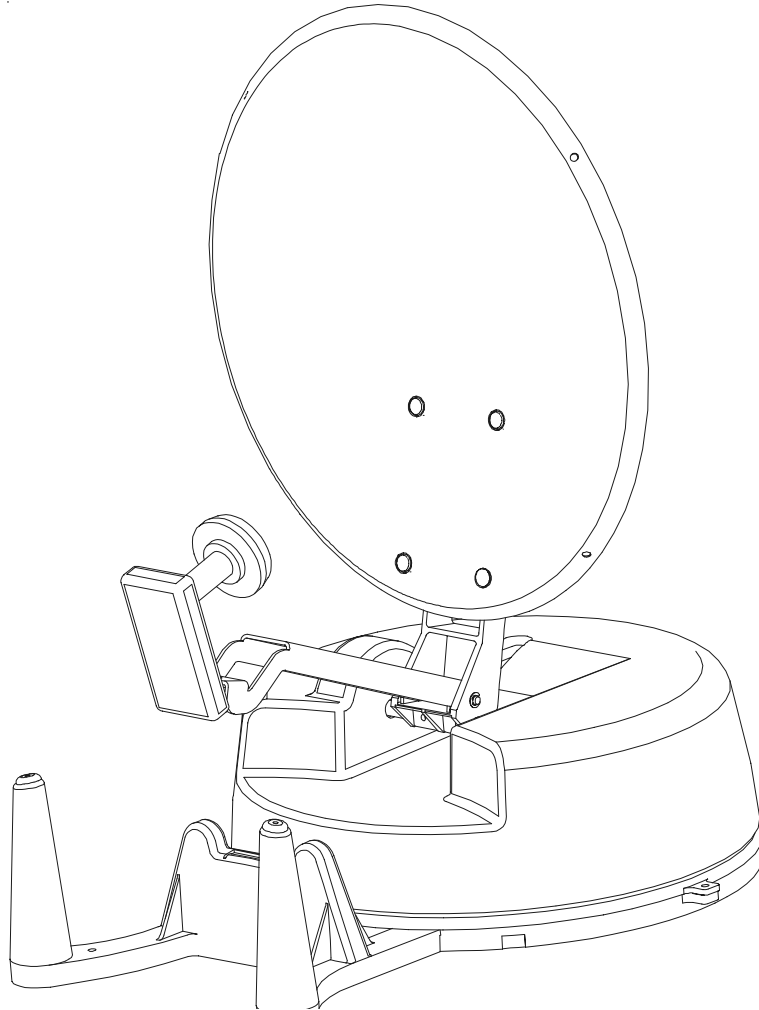

U.S. Patent No.  
5,532,710

#### **WARNING!**

**BEFORE ATTACHING OR REMOVING ANY CABLE/WIRES ON  
BACK OF POSITIONER, UNPLUG UNIT FROM 117 VAC SOURCE.**

## TABLE OF CONTENTS

Antenna Support .....	3
Mount Assembly .....	4
Mount Base .....	6
Positioner/Accessories .....	7
Antenna/Feed Assembly .....	8
35' Control Cable .....	10
Mount Wire Harness .....	11

## INTRODUCTION

We have organized this parts list to enable you to order any individual part. If you are ordering an electrical/electronic item, be sure it has actually failed before you order the replacement. Your dealer or the Winegard Service department can check this for you.

Parts under warranty will be shipped at no cost to you by Winegard. Unless directed otherwise, return defective parts still under warranty to Winegard Company. If the part is not returned, you will be billed for the replacement part, plus shipping charges.

Order replacement parts no longer under warranty by using a major credit card and calling 1-800-288-8094 or by sending check, or money order to **RV Parts, Winegard Company, 3000 Kirkwood Street, Burlington, IA 52601-2000**.



# ANTENNA SUPPORT ASSEMBLY

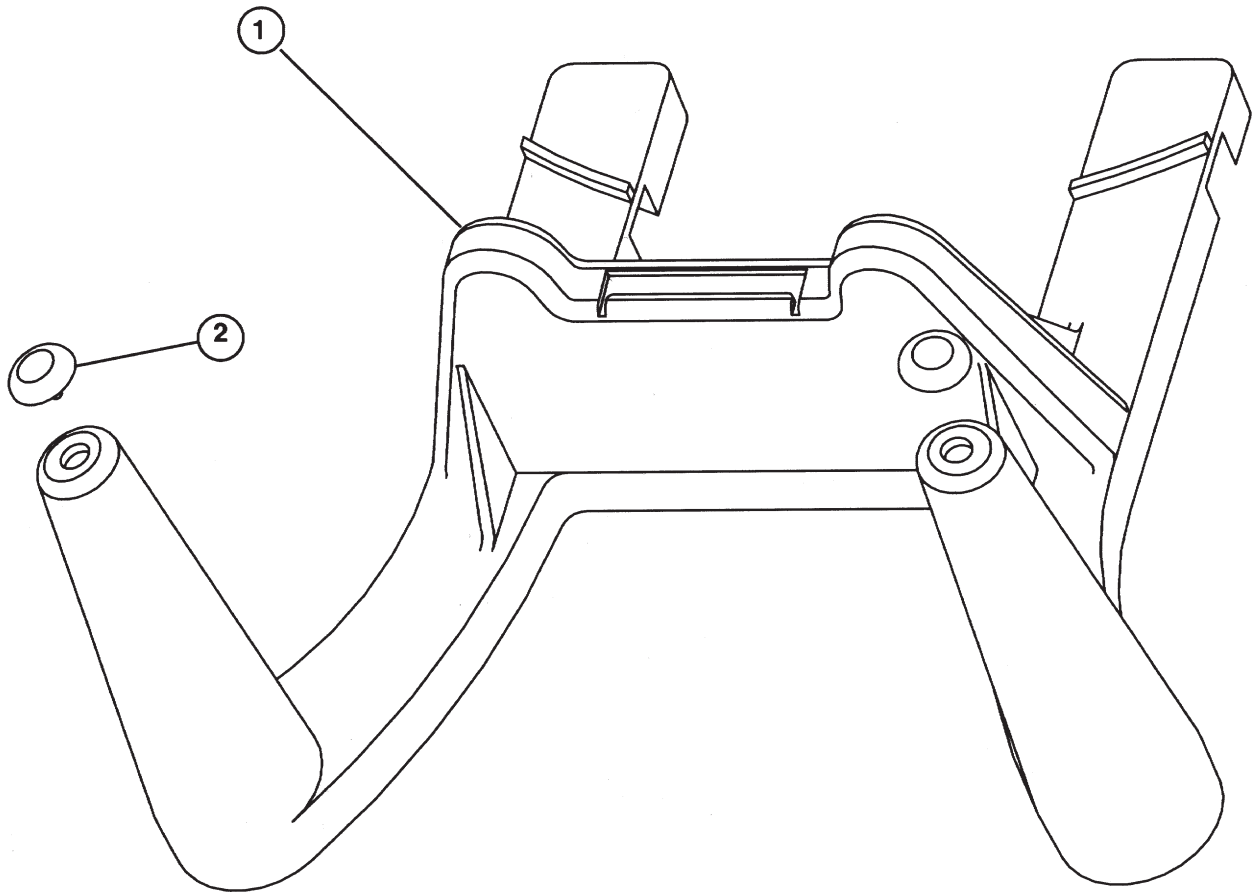

INDEX NO.	PART NUMBER	DESCRIPTION	QTY
	2762830	Antenna Support Assembly	1
1	2200945	Antenna Support, White	1
2	2240021	Antenna Support Bumper, White	2

# MOUNT ASSEMBLY

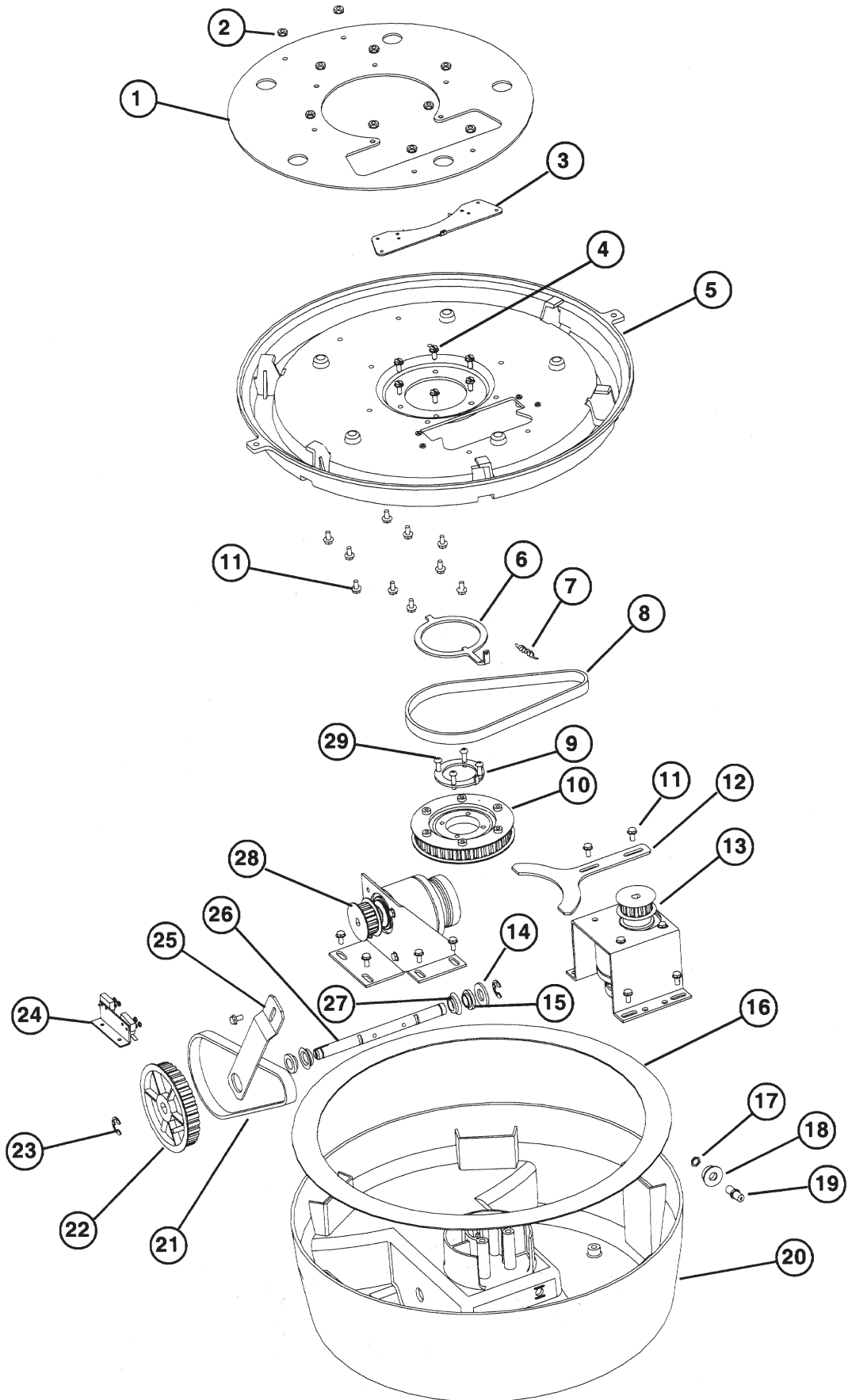

## MOUNT ASSEMBLY

INDEX NO.	PART NUMBER	DESCRIPTION	QTY
	2762832	Mount Assembly	1
1	3710300	Mount Base Stiffener	1
2	2160218	10-32 Nut	10
3	2762835	Rotation Switch Assembly	1
4	2160194	#10 x 1/2" Hex Head Bolt	6
5	2200946	Mount Base, White	1
6	3710260	Rotate Stop Ring	1
7	2160819	Spring	1
8	2200140	Rotation Drive Belt	1
9	3710261	Fixed Stop Ring	1
10	2201848	Rotation Pulley	1
11	2160185	10-32 x 3/8" Hex Head Bolt	19
12	3711303	Rotate Motor Tensioner	1
13	2762838	Rotation Motor Assembly	1
14	2160037	1/2" Flat Washer	1
15	2180509	Oil Lube Bushing	2
16	3710294	Stiffener Ring	1
17	2160223	3/8-32 Hex Nut	1
18	3200206	Boot Collar	1
19	2360060	F-8100 Male-to-Male F-connector	1
20	2200944	Top Cover, White	1
21	2200141	Elevation Drive Belt	1
22	2200850	Elevation Pulley	2
23	2160699	E-Clip	2
24	2762836	Elevation Switch Assembly	1
25	3711304	Elevation Motor Tensioner	1
26	2590345	Lift Arm Shaft	1
27	2200851	Seal	2
28	2762837	Elevation Motor Assembly	1
29	2160182	10-32 x 3/4" Phillips Head Screw	4
*NS	2753018	LNBF Coax Cable Jumper 4' RG-6	1

\*NS - Part not shown for clarity

# MOUNT BASE

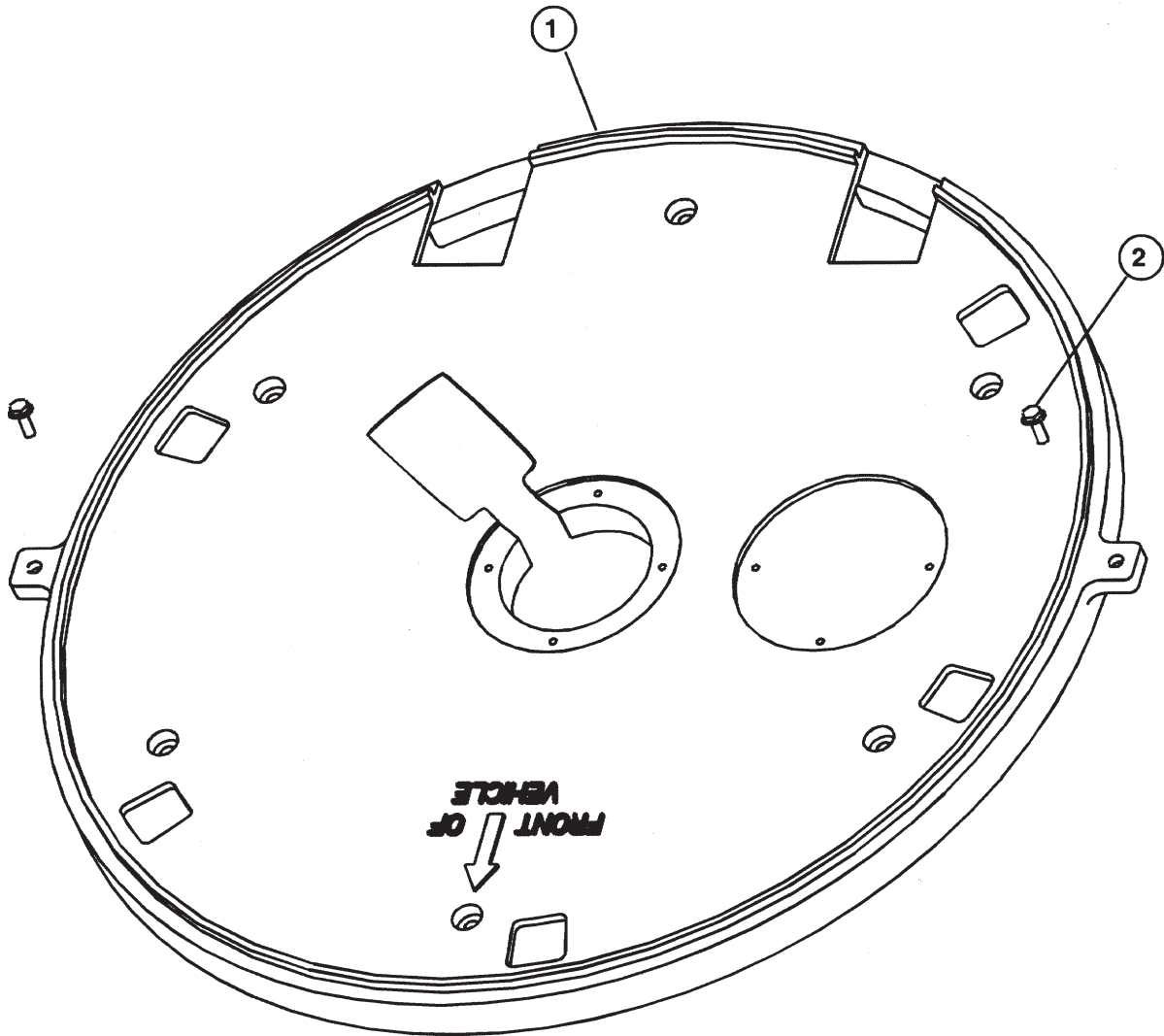

INDEX NO.	PART NUMBER	DESCRIPTION	QTY
1	3200947	Mount Base	1
2	2160183	10-32 x 1-1/2" Hex Screw	2

# POSITIONER/ACCESSORIES

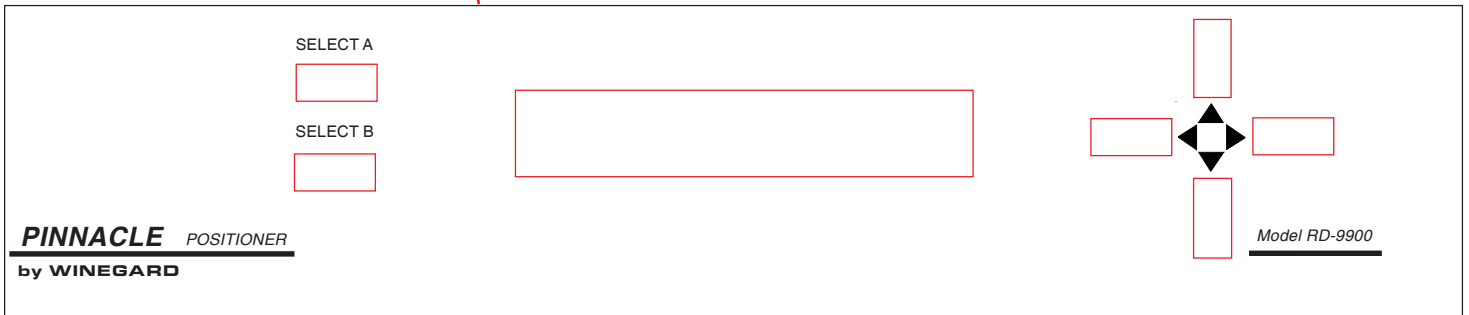
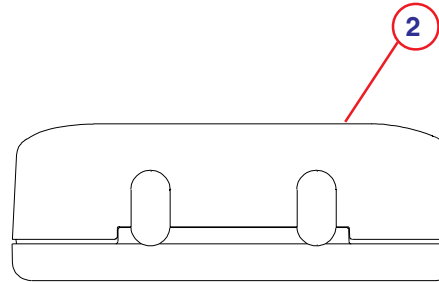
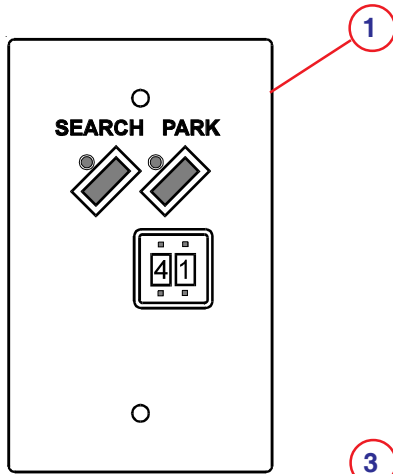

INDEX NO.	PART NUMBER	DESCRIPTION	QTY
1	RD-9901	Remote Control Wall Plate	*
2	RD-9911	Warning Device	**
3	2750225	Positioner	1
4	2753254	Ignition Wire Harness	1

\* Optional, comes with 25' 6-wire telephone type cord to connect to receiver.

\*\* Optional, comes with batteries and cables to connect to receiver and vehicle ignition.

# ANTENNA/FEED ASSEMBLY

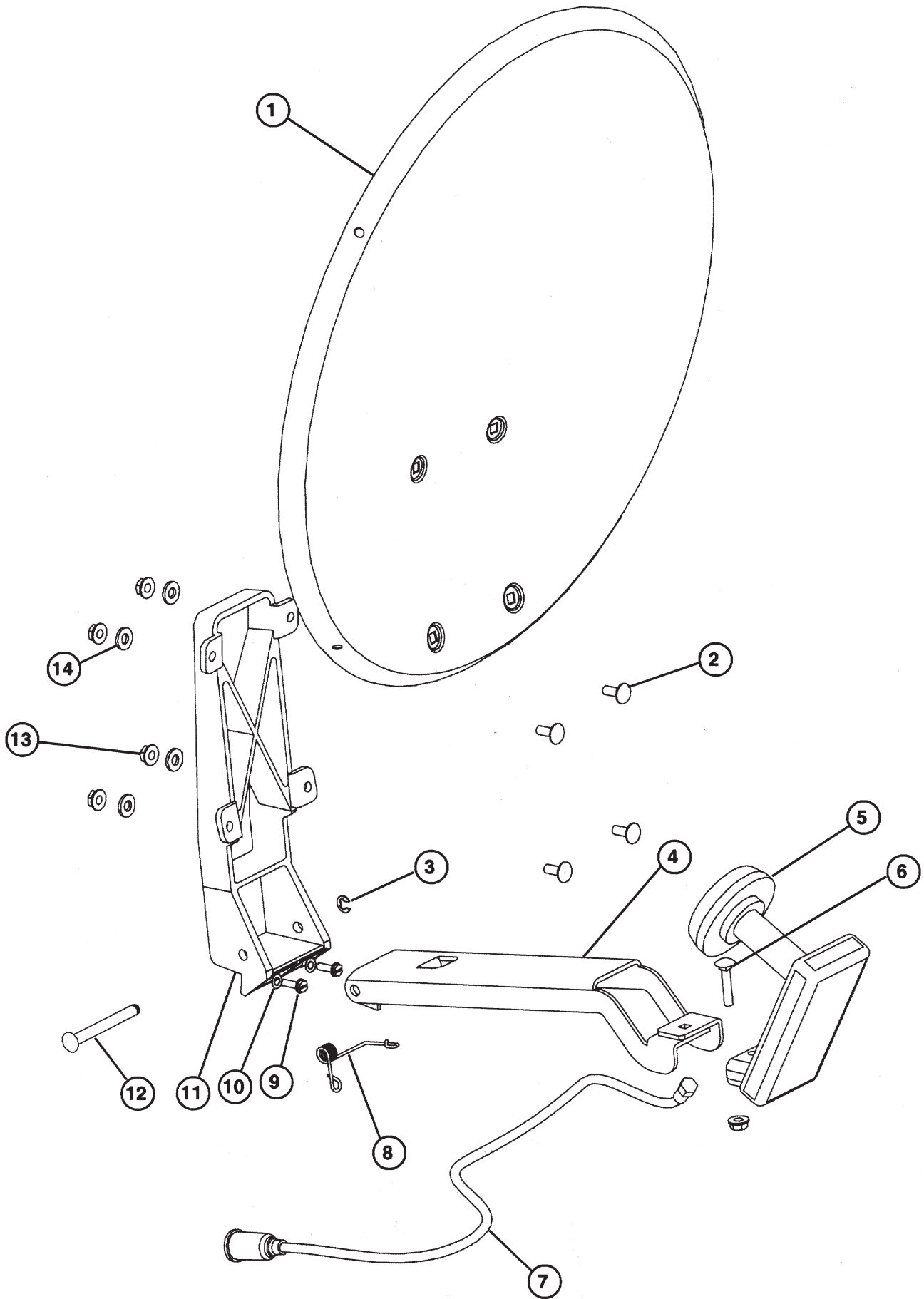

## ANTENNA/FEED ASSEMBLY

INDEX NO.	PART NUMBER	DESCRIPTION	QTY
	2762827	46 cm Antenna/Feed Assembly	
1	2745303	46 cm Reflector (18 inches), White	1
2	2160362	1/4-20 x 5/8" Carriage Bolt, White	4
3	2160696	E-Clip	1
4	2745287	Feed Support Arm, White	1
5	2780160	LNBF	1
6	2160353	1/4-20 x 1-1/4" Carriage Bolt	1
7	2753067	Coax Cable Assembly	1
8	2160821	Spring	1
9	2160170	10-32 x 1-1/8" Hex Head Bolt*	2
10	2160349	10-32 Washer	2
11	2745288	Reflector Backup, Cast, White	1
12	2160691	5/16" x 2.925 Round Head Pin	1
13	2160228	1/4-20 Hex Flange Lock Nut	5
14	2160024	1/4" Flat Washer	4
15	2190105	Cable Tie**	2

\* Not included with the 2762827 Antenna/Feed Assembly.

\*\* Not shown for clarity.

# 35' CABLE, PART NUMBER 2753248

WIRE CONNECTIONS - 24 GA			
PIN	WIRE	PIN	WIRE
1	Blue	8	Blue/Black
2	White	9	White/Black
3	Black	10	Black/White
4	Orange	11	Orange/Black
5	Green/Black	12	Red/Black
6	Green	13	Red/White
7	Not Used	14	Red

### NOTES:

1. 14 wire/coax cable to be jacketed together.
2. Jacket strip length 13 wire cable: 3.00 ±.25 both ends.
3. Wire strip length 13 wire cable: .25 ±.031 both ends.

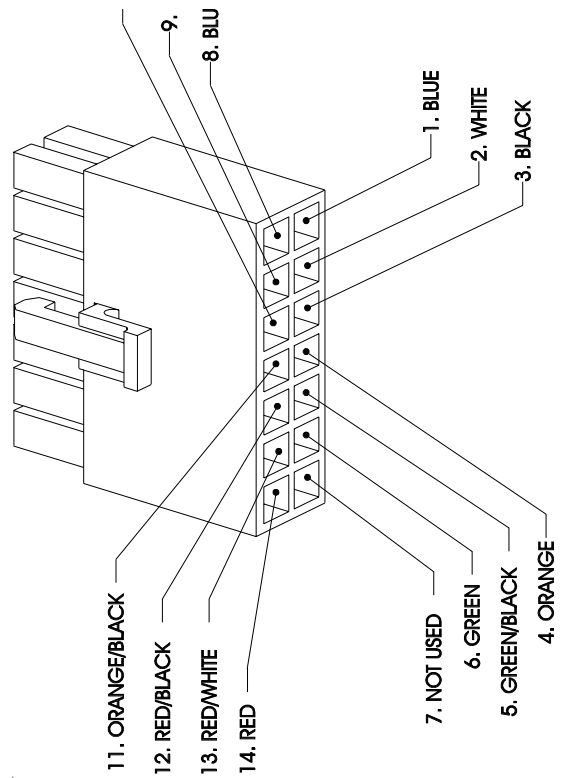



**MOUNT WIRE HARNESS, PART NUMBER 2753245**  
 For antenna mounts with a serial # of 10111 or higher.

Wire Connections for Molex #39-01-3143 (Connects to 35' Cable Harness)			
PIN	WIRE	PIN	WIRE
1	Blue	8	Blue w/Black Stripe
2	White	9	White w/Black Stripe
3	Black	10	Black w/White Stripe
4	Orange	11	Orange w/Black Stripe
5	Green w/Black Stripe	12	Red w/Black Stripe
6	Green	13	Red w/White Stripe
7	Not Used	14	Red & Red (2 wires)

Wire Connections for Molex #39-01-4046			
Elevation Motor		Azimuth Motor	
PIN	WIRE	PIN	WIRE
1	Blue	1	Blue w/Black Stripe
2	White	2	White w/Black Stripe
3	Black	3	Black w/White Stripe
4	Orange	4	Orange w/Black Stripe

Wire Connections for Molex #39-01-4037			
Elevation Switches		Azimuth Switches	
PIN	WIRE	PIN	WIRE
1	Red	1	Red
2	Green	2	Red w/White Stripe
3	Green w/Black Stripe	3	Red w/Black Stripe