

Westinghouse

Lightwave Toaster Oven



WST3028

You can be sure...if it's Westinghouse

IMPORTANT SAFEGUARDS

When using electrical appliances, basic safety precautions should always be followed including the following:

1. Read all instructions.
2. Do not touch hot surfaces. Use handles or knobs.
3. To protect against electrical shock do not immerse cord, plugs, or appliance in water or other liquid.
4. Close supervision is necessary when any appliance is used by or near children.
5. Unplug from outlet when not in use and before cleaning. Allow to cool before putting on or taking off parts.
6. Do not operate any appliance with a damaged cord or plug or after the appliance malfunctions or has been damaged in any manner. Contact Consumer Service for examination, repair or adjustment.
7. The use of accessory attachments not recommended by the appliance manufacturer may cause injuries.
8. Do not use outdoors.
9. Do not let cord hang over edge of table or counter, or touch hot surfaces.
10. Do not place on or near a hot gas or electric burner, or in a heated oven.
11. Extreme caution must be used when moving an appliance containing hot oil or other liquids.
12. To disconnect, press and hold Stop button until beep is heard, then remove plug from wall outlet.
13. Do not use appliance for other than intended use.
14. Oversize foods or metal utensils must not be inserted in the toaster-oven as they may create a fire or risk of electric shock.
15. A fire may occur if the toaster-oven is covered or touching flammable material, including curtains, draperies, walls and the like, when in operation. Do not store any items on top of the appliance when in operation.
16. Do not clean with metal scouring pads. Pieces can break off the pad and touch electrical parts creating a risk of electric shock.
17. Extreme caution should be exercised when using containers constructed of other than metal or glass.
18. Do not store any materials, other than manufacturer's recommended accessories, in this oven when not in use.
19. Do not place any of the following materials in the oven: paper, cardboard, plastic and the like.

20. Do not cover Crumb Tray or any part of the oven with metal foil. This will cause overheating of the oven.
21. Use extreme caution when removing tray or disposing of hot grease.
22. To turn oven Off during use, press and hold the Stop Button until beep is heard.

SAVE THESE INSTRUCTIONS
For Household Use Only

ADDITIONAL IMPORTANT SAFEGUARDS

CAUTION HOT SURFACES: This appliance generates heat and escaping steam during use. Proper precautions must be taken to prevent the risk of burns, fires, or other injury to persons or damage to property.

1. A person who has not read and understood all operating and safety instructions is not qualified to operate this appliance. All users of this appliance must read and understand this Owner's Manual before operating or cleaning this appliance.
2. If this appliance falls or accidentally becomes immersed in water, unplug it from the wall outlet immediately. **Do not reach into the water!**
3. When using this appliance, provide adequate air space above and on all sides for air circulation. Do not operate this appliance while it is touching or near curtains, wall coverings, clothing, dish towels or other flammable materials.
4. To reduce the risk of fire, do not leave this appliance unattended during use.
5. If this appliance begins to malfunction during use, immediately unplug the cord. Do not use or attempt to repair a malfunctioning appliance!
6. The cord to this appliance should only be plugged into a 120V AC electrical wall outlet.
7. Do not use this appliance in an unstable position.
8. Caution: Do not touch halogen heater with bare hands. Fingerprints may result in shorter heater life. To avoid the risks of burns or other injury, turn off power and allow halogen heater to fully cool before cleaning with a smooth dry cloth to avoid scratching the halogen heater.

Polarized Plug

This appliance has a polarized plug (one blade is wider than the other). To reduce the risk of electrical shock, this plug is intended to fit into a polarized outlet only one way. If the plug does not fit fully in the outlet, reverse the plug. If it still does not fit, contact a qualified electrician. Do not attempt to modify the plug in any way.

Short Cord Instructions

A short power-supply cord is provided to reduce the risk resulting from becoming entangled in or tripping over a longer cord.

Do not use an extension cord with this product.

Electric Power

If the electrical circuit is overloaded with other appliances, your appliance may not operate properly. It should be operated on a separate electrical circuit from other appliances.

Plasticizers Warning

CAUTION: To prevent Plasticizers from migrating from the finish of the countertop or tabletop or other furniture, place **NON-PLASTIC** coasters or placemats between the appliance and the finish of the countertop or tabletop.

Failure to do so may cause the finish to darken, permanent blemishes may occur or stains can appear.

Getting To Know Your Westinghouse WST3028 Lightwave Toaster Oven

The box containing your Westinghouse Lightwave Toaster Oven should include the following parts. If any of the following parts are missing, contact customer service.

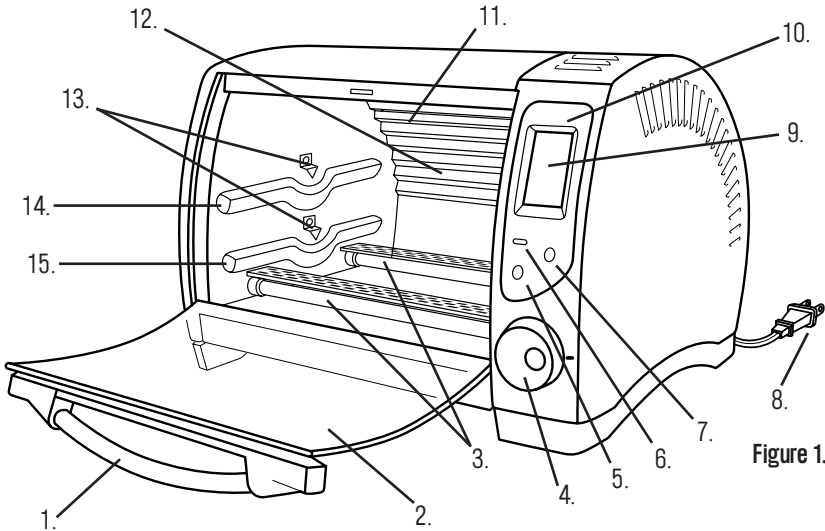

Figure 1.

- | | |
|------------------------------------|-----------------------------------|
| 1. Door Handle | 9. Display Window |
| 2. Curved Glass Door | 10. Control Panel |
| 3. Lower Infrared Heating Elements | 11. Upper Halogen Heating Element |
| 4. Time/Toast Color Dial | 12. Concave Oven Back |
| 5. Start/Stop Button | 13. Wire Rack Stop |
| 6. Operation Light | 14. Shelf Positions 1 and 2 |
| 7. Function Button | 15. Shelf Positions 3 and 4 |
| 8. Power Cord | 16. Crumb Tray (See Figure 2.) |

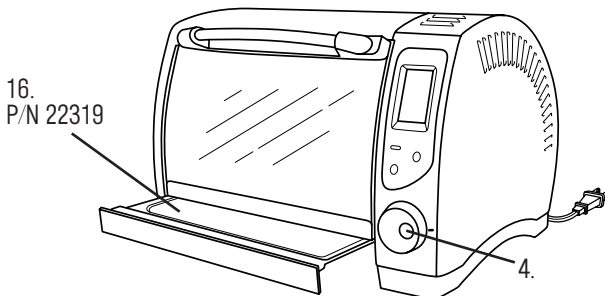

Figure 2.

TIME/TOAST COLOR DIAL

Turn to set the minutes of the Cooking Time of Toast Color after function is chosen.

Control Panel

DISPLAY WINDOW

Indicates time, function, toast color, amount of time left for completion of function.

FUNCTION BUTTON

Press the Function Button to change the Cooking Function. Press and hold the Function Button to scroll through the Cooking Functions more quickly.

START/STOP

After selecting the function and time (if necessary), press to start the function. Press and hold until beep is heard during use to cancel a function.

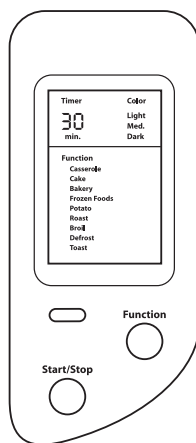

Function	Food	Default Time/Min.	Shelf Position	Color
Casserole	Casserole, Corn Bread, Appetizers, Frozen Pies	45	4	N/A
Cake	Cake, Cookies, Bars, Brownies, Muffins	25	4	N/A
Bakery	Biscuits, Crescent Rolls, Dinner Rolls, Danish Rolls	15	4	N/A
Frozen Foods	Frozen Convenience Foods, Pizza, Chicken Nuggets, Fish Sticks, Hors D'oeuvres	15	3	N/A
Potato	Baking Potatoes, Yams, Sweet Potatoes, Fresh and Frozen French Fries and Tater Tots, Potato Casserole	60	4	N/A
Roast	Beef, Pork, Poultry, Seafood	60	4	N/A
Broil	Beef, Chicken, Seafood	20	2 or 3	N/A
Defrost	Frozen Coffee Cakes, Dinner Rolls	30	4	N/A
Toast	Bread, Bagels, English Muffins, Toaster Pastries	- - - -	3	Light Medium Dark

Bake/Broil Pan, Broil Inserts, Wire Rack And Crumb Tray

For best results use Bake/Broil Pan to bake, defrost and top brown, to minimize clean up due to spills.

When **toasting**, place bread directly on Wire Rack. Place in Shelf Position #3. The Crumb Tray must be used.

When **baking** using the Casserole, Cake, Bakery, Frozen Foods, Potato, Roast, and Defrost Function, you may either use the Bake Pan provided, or your own pan with the wire rack. Place into Shelf Positions #3 or #4.

When **broiling**, the Bake/Broil Pan, one of the Inserts and the Wire Rack must be used. Place into Shelf Positions, #2 or #3 depending on thickness of food. The food should be approximately 3 inches from the top elements.

When **defrosting**, you may either use the Bake/Broil Pan or your own pan. Place pan directly on Wire Rack. Place in Shelf Position #4.

To insert or remove the empty Wire Rack, slide the Wire Rack in or out until it makes contact with the Wire Rack Stop. Lift up the front of the Wire Rack and slide the back corners under the Wire Rack Stop located on the left side of the oven wall.

The Crumb Tray must be in place during use.

CAUTION: APPLIANCE SURFACES ARE HOT DURING AND AFTER USE.

CAUTION: Always wear protective, insulated oven mitts on hands when touching hot oven, hot dishes or food, or when inserting or removing Wire Rack, Broil Inserts, Bake/Broil Pan and Crumb Tray.

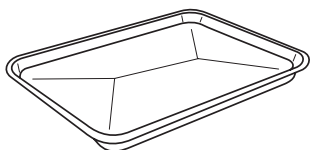

Bake/Broil Pan
P/N 22320

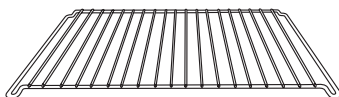

Wire Rack
Shelf Positions 1 and 3
P/N 22322

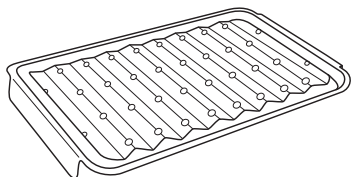

Broil Insert P/N 22491
Use for Seafood

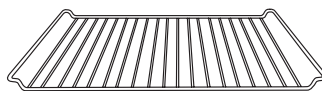

Inverted Wire Rack
Shelf Positions 2 and 4
P/N 22322

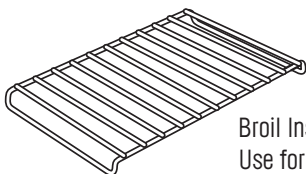

Broil Insert P/N 22321
Use for Beef, Pork or Poultry

Cooking Containers

- The Bake/Broil Pan included with the Lightwave Toaster Oven is suitable for items such as cookies, rolls and biscuits.
- A variety of standard baking dishes, such as an 8" round or square cake pan, a 6-cup muffin pan, and a 1 & 2 quart round, square, or rectangular casserole dish may be used for other foods.
- Choose bakeware made of metal, or glass/ceramic without lids.
- Dark or dull pans absorb heat faster; foods will bake more rapidly and crust will brown more easily than in shiny bake pans.
- Check package directions for the cooking container you wish to use, and/or with the ovenware manufacturer to determine if the container is suitable for use in a Toaster-Oven-Broiler.
- Do not use oven roasting bags in this Lightwave Toaster Oven, as they may come in contact with the heating elements.

CAUTION: Allow at least 1" air space between the top of the container and the upper heating element. Never use glass lids on glass or metal bakeware. If a lid is necessary, cover tightly with heavyduty aluminum foil.

OPERATING INSTRUCTIONS

Before First Use

1. Read all instructions in this manual carefully.
2. Carefully unpack your Lightwave Toaster Oven and remove all packaging materials.
3. Place your Lightwave Toaster Oven on a level surface such as a countertop or table. Be sure the sides, back, and top of the Lightwave Toaster Oven are at least four inches away from any walls, cabinets, or objects on the counter or table.
4. Remove all stickers from the Lightwave Toaster Oven except the rating label located on the bottom.
5. Remove Bake/Broil Pan, Wire Rack, Broil Inserts and Crumb Tray and wash in warm, soapy water. Rinse and dry thoroughly before placing in the Lightwave Toaster Oven.
6. Remove any dust that may have accumulated during packaging, simply wipe the Lightwave Toaster Oven exterior and interior with a clean, damp cloth.
7. Do not use abrasive cleaners.
8. Do not put the Lightwave Toaster Oven cord or plug in water.
9. When you are ready to use the Lightwave Toaster Oven, plug the cord into a 120V AC outlet. Close the Glass Door. The Operation Light and the Display Window will illuminate while the unit is plugged in.
10. To eliminate any protective substance or oil that may have been used for packing and shipping, select the Casserole Function by pressing the Function Button until the arrow is pointing toward the Casserole Function.

Before First Use (cont'd)

11. Set the Timer by turning the Timer/Toast Color Dial until 15 min. displays under Timer in the Display window.
12. Press the Start/Stop Button and the Lightwave Toaster Oven will begin the Casserole Function process. A small amount of smoke and odor may be detected. This is normal.
13. Condensation may build-up on the inside of the Glass Door, but will evaporate during the Casserole Function.
14. The Lightwave Toaster Oven will beep when the Casserole Function is complete.
15. Unplug oven and allow to cool completely before cleaning.
16. To avoid scratching, marring, or discoloration, do not store anything on top of the Lightwave Toaster Oven during operation.
See User Maintenance Instructions.
Unplug when not in use.

CAUTION: Appliance surfaces are hot during and after use.

CAUTION: Always wear protective, insulated oven mitts on hands when touching hot Lightwave Toaster Oven or hot dishes and food or when inserting or removing Wire Rack, Broil Inserts, Bake/Broil Pan and Crumb Tray.

Lightwave Toaster Oven Tips

- The Lightwave Toaster Oven has preset temperatures for each function to cook frequently prepared foods. The temperature can not be adjusted.
- The Lightwave Toaster Oven has a 2 hour timer.
- The Operation Light on the Control Panel will be on while the unit is plugged in.
- The oven will beep 5 times when the program is completed.
- The Lightwave Toaster Oven will automatically shut off once the timer has reached 0. The Operation Light and Display Window will remain illuminated while the unit is plugged in.
- The Lightwave Toaster Oven may be shut off at anytime during any function. To interrupt a function, press and hold the Start/Stop button until the unit beeps and shuts off.
- The Heating Elements also function as an interior light. During all functions, except the Broil Function, the Upper and Lower Heating Elements will cycle on and off. During Broil Function, only the top element will cycle on and off.

Preset Functions

NOTE: All of the functions, except for the toast function, are programmed with a default time and temperature. The default time may be changed by turning the Time/Toast Color Dial. No preheat is necessary.

1. Plug unit into a 120 V outlet. Place Wire Rack into desired Shelf Position. Close the Glass Door. The Operation Light and the Display Window will illuminate while the unit is plugged in.
2. Press the Function Button until the pointer is next to the desired cooking function.
3. The default time will appear in the Display Window under the Timer section. To change the time, turn Time/Toast Color Dial to select the desired time. The time will go up or down by 1 minute at a time. The maximum time is 120 minutes (2 hours).

Note: Some foods will cook up to 30% faster than the package time. Set the timer for lesser time, check food and continue cooking if necessary.

4. Open the Glass Door and place your food in the Lightwave Toaster Oven. Close Glass Door.
5. Press the Start/Stop button. The Timer will begin to count down and "min." will flash in the Display Window.
6. Condensation may build-up on the inside of the Glass Door, but will evaporate during Preset Function.
7. The Lightwave Toaster Oven will beep 5 times when the program is complete.

8. Open the Glass Door. Using oven mitts remove hot pan, Wire Rack and food. Close Glass Door.
9. Unplug oven and allow to cool completely before cleaning. See User Maintenance Instructions. Unplug when not in use.

NOTE: To change cooking time during baking process, you must start the programming sequence over. Press and hold the Stop button until beep is heard. The default time will appear in the Display Window. Reprogram the time and/or function and press the Start button to resume the cooking process.

Hints For Cooking

- Heavy-duty aluminum foil may be used to cover top of baking container to reduce over browning. Tuck ends of foil closely against edge of pan.
- Place food in the center of the Lightwave Toaster Oven for better browning.
- Food may cook faster than recipe or package time. Check for doneness prior to end of cook time.
- Rotate and turn food over for more even browning halfway through the cooking process.
- To prevent heat loss, avoid opening the Glass Door excessively.
- For best results, foods that contain a leavening agent should be baked on the lowest Shelf Position of the Lightwave Toaster Oven.
- Always use the Broil Inserts and Bake/Broil Pan with the Broil function.

Toast Function

1. Plug unit into a 120 V outlet. Open the Glass Door. Place Wire Rack into Shelf Position #3. Place Bread on Wire Rack. Close the Glass Door. The Operation Light and Display Window will illuminate while the Unit is plugged in.
2. Press the Function Button until the arrow is pointing toward the Toast Function. The default setting of medium (Med.) toast color will appear in the Display Window under Color.
3. To change the toast color, turn the Time/Toast Color Dial until the arrow is pointing to the desired color of toast Light, Med. or Dark.
4. Press the Start/Stop button. The display will flash (-- --) in the Timer section and the Lightwave Toaster Oven will begin the toasting process.
NOTE: The average time will range from 2-5 minutes, depending on the color chosen. Consecutive toasting times will be less, due to the Lightwave Toaster Oven cavity already being heated. Adjust the Color Control down one shade to toast the same color.
5. Condensation may build-up on the inside of the Glass Door, but will evaporate during toasting.
6. The Lightwave Toaster Oven will beep when the Toast function is complete.
7. Open Glass Door. Using oven mitts, carefully remove Wire Rack. Close Glass Door.

8. Unplug oven and allow to cool completely before cleaning.
See User Maintenance Instructions.
Unplug when not in use.

NOTE: To change the toast color during the toasting process, you must start the programming sequence over. Press and hold the Stop button until the unit beeps. The current selected Toast setting will appear in the Display Window. Select the desired toast color and press the Start button to resume the toasting process.

Hints For Toast

- Follow toaster food directions.
- Frozen and heavy breads require a darker setting (i.e. bagels and English muffins).
- Using oven mitts, remove Crumb Tray and empty after each use.

Top Brown Instructions

To top brown foods, follow the toasting instructions above but place the food on the Bake Pan on the Wire Rack.

Hints For Top Brown

- Watch food to avoid over-browning.
- You may brown the top of bagels (cut side up), English muffins or melt cheese on sandwiches or casseroles.

User Maintenance Instructions

This appliance requires little maintenance. It contains no user serviceable parts. Do not try to repair it yourself. Contact a qualified appliance repair technician if the product requires servicing.

Cleaning And Storing

ALWAYS UNPLUG THE UNIT AND ALLOW TO COOL COMPLETELY BEFORE CLEANING.

Clean-Up Of The Interior

1. Unplug oven and allow to cool before cleaning.
2. Remove all accessories from inside the oven cavity: Bake/Broil Pan, Broil Inserts, Wire Rack and Crumb Tray.
3. Clean interior with a mild or non-abrasive cleaner and plastic scouring pad after each use to avoid build-up. Do not rub too hard as the surface on the walls of the Lightwave Toaster Oven may become scratched.
4. Rinse and dry thoroughly before closing Glass Door.

CAUTION: DO NOT use spray-on or other oven cleaners. Using these types of cleaners may cause electrical damage.

Clean-Up Of Lightwave Toaster Oven Glass Door And Exterior

1. Unplug oven and allow to cool before cleaning.
2. Wipe exterior with a damp cloth after each use.
3. To clean the Glass Door, use a glass cleaner or mild detergent and a damp cloth or plastic scouring pad. Do not use an abrasive cleaner or pad as they might scratch the finish.
4. Rinse and dry thoroughly with a clean cloth. Allow to dry before closing the Glass Door.

Clean-Up Of Accessories

Bake/Broil Pan, Broil Inserts, Wire Rack, and Crumb Tray

1. Allow to cool before cleaning.
2. Hand wash with soap and water or a mild abrasive cleaner and plastic scouring pads or wash in the dishwasher.
3. Rinse and dry thoroughly.

Storing

- The Lightwave Toaster Oven should be completely cooled before storing.
- All removable parts should be thoroughly cleaned and dried.
- Store with Glass Door closed.

Time And Temperature Charts

The charts are used as a reference guide only. To be sure that the food is done, use a cooking thermometer. Cooking times are for fresh foods (not frozen foods) at refrigerator temperature.

NOTE: The United States Department of Agriculture recommends that meat and poultry be cooked to the following internal temperature to be sure any harmful bacteria has been killed. Ground turkey and chicken should be cooked to an internal temperature of 165°F and ground beef, veal, lamb and pork be cooked to an internal temperature of 160°F. Chicken and turkey should be cooked to an internal temperature of 170°F for white meat and 180°F for dark meat. Goose and duck should be cooked to an internal temperature of 180°F. Fresh Beef, veal and lamb, etc. should be cooked to an internal temperature of at least 145°F. Fresh pork should be cooked to an internal temperature of at least 160°F. When re-heating meat and poultry, they should also be cooked to an internal temperature of 165°F.

Roasting (Poultry Function)

When roasting, place the food on the Broil Insert inside the Bake/Broil Pan. Place on Wire Rack in Shelf Position #4.

Roasting

FOOD	TYPE OF CUT	AMOUNT / WEIGHT	TEMPERATURE °F ON MEAT THERMOMETER AT END OF COOKING TIME	TOTAL COOKING TIME FOR FRESH MEATS, POULTRY
Beef	Tenderloin	2 lbs.	145°F (R) 160°F (M)	3/4 to 1 hrs. 1 to 1-1/4 hrs.
Pork	Tenderloin	2 lbs.	160°F (M) 170°F (W)	3/4 to 1 hrs. 1 to 1-1/4 hrs.
Poultry	Chicken Breast Bone in - Skin on	3 breasts 12-16 oz. each	170°F	3/4 to 1-1/2 hrs.
	Whole Chicken	2-1/2 to 3 lbs.	180°F	1 to 1-1/2 hrs.
	Turkey Breast Tenderloin	2 lbs.	170°F	1 to 1-1/4 hrs.
Seafood	Steak	2 Steaks 1 to 1-1/2" thick	Flaky	10-15 min.
	Fillet	2 Fillets 1/2 to 3/4" thick	Flaky	8-14 min.

R= Rare M= Medium W= Well Done

Broil (Broil Function)

When broiling, place the food on the Broil insert inside the Bake/Broil Pan. Place on Wire Rack in Shelf Position #2 or #3. The top of the Food should be 2 to 3 inches from top element. Turn food halfway through cooking time.

Broiling

FOOD	TYPE OF CUT	AMOUNT / WEIGHT	TEMPERATURE °F ON MEAT THERMOMETER AT END OF COOKING TIME	TOTAL COOKING TIME FOR FRESH MEATS, POULTRY
Beef	Ribeye Steak	2 1 inch thick	145°F (R) 160°F (M) 170°F (W)	8 to 12 min. 12 to 16 min. 16 to 20 min.
	Top Sirloin Steak	2 1-1/4 inch thick	145°F (R) 160°F (M) 170°F (W)	12 to 16 min. 16 to 20 min. 20 to 24 min.
	NY/KC Strip Steak	3 3/4 inch thick	145°F (R) 160°F (M) 170°F (W)	8 to 12 min. 10 to 14 min. 12 to 16 min.
	T Bone	3 3/4 inch thick	145°F (R) 160°F (M) 170°F (W)	8 to 12 min. 12 to 16 min. 16 to 20 min.
	Hamburger Patties	6 3/4 inch thick	160°F (M) 170°F (W)	16 to 20 min. 18 to 22 min.
Pork	American Pork Chops	6 1/2 inch thick	160°F (M) 170°F (W)	12 to 16 min. 14 to 18 min.
	Pork Steaks	2 3/4 inch thick	170°F	22 to 26 min.
	Boneless Ham Steaks	4 4-oz. each	160°F	8 to 12 min.
	Sausage Patties, fresh	8 3/4 inch thick	160°F	12 to 16 min.
Poultry	Turkey Burgers	6 4-oz. each	165°F	10 to 14 min.
	Turkey Brats	6	165°F	10 to 14 min.
Seafood	Steak	2 Steaks 1 to 1-1/2" thick	Flaky	10 to 15 min.
	Fillet	2 Fillets 1/2 to 3/4" thick	Flaky	6 to 14 min.
	Shrimp	Jumbo	Flaky	3 to 10 min.
Misc.	Frankfurters	1 lb.	165°F	10 to 20 min.
	Fresh Bratwurst	1 lb.	160°F	10 to 14 min.

R= Rare M= Medium W= Well Done

Marinades

Marinate meat for added flavor and tenderizing. A marinade must include an acidic ingredient like lemon juice, vinegar, wine or salsa to tenderize. To prepare, blend all ingredients together. Marinate in refrigerator at least 30 minutes turning to coat meat completely. Pat dry before cooking.

RED WINE

- 1/4 cup red wine vinegar
- 2 tablespoons vegetable oil
- 1 tablespoon Dijon mustard
- 1 clove garlic, minced
- 1/2 teaspoon dried Italian seasoning
- 1/8 teaspoon pepper, coarsely ground

CURRY YOGURT

- 1/3 cup plain yogurt
- 2 tablespoons lemon juice
- 1 tablespoon vegetable oil
- 2 cloves garlic, minced
- 1/2 teaspoon curry powder
- 1/8 teaspoon red pepper, crushed

LEMON ORIENTAL

- 1/4 cup lemon juice
- 1 tablespoon soy sauce
- 1 tablespoon vegetable oil
- 2 tablespoons onion, chopped
- 1/4 teaspoon ground ginger
- 1/8 teaspoon red pepper, crushed

MEXICALI

- 1/2 cup prepared salsa
- 2 tablespoons lime juice
- 1 tablespoon vegetable oil
- 2 tablespoons cilantro, chopped

SZUECHUAN

- 1/4 cup soy sauce
- 3 tablespoons dry sherry
- 1 tablespoon sesame oil
- 2 tablespoons sugar
- 2 tablespoons cornstarch

SPICY HERB

- 1/2 cup dry wine
- 1/2 cup vegetable oil
- 2 tablespoons lemon juice
- 1/2 teaspoon Tabasco® pepper sauce
- 1/4 cup onions, chopped
- 1 clove garlic, minced
- 1/4 teaspoon salt
- 1/4 teaspoon dried basil leaves
- 1/8 teaspoon dried tarragon leaves
- 1/8 teaspoon dry mustard

Recipes

FIESTA CORN BREAD

- 1 cup all-purpose flour
- 1/2 cup corn meal
- 1/4 cup sugar
- 1-1/2 teaspoons baking powder
- 1/4 teaspoon salt
- 3/4 cup milk
- 3 tablespoons oil
- 1 egg, beaten
- 4 ounce can diced in shelf #4 green chilies, drained
- 2 ounce jar, diced pimento, drained

Combine dry ingredients, set aside. Mix wet ingredients together and stir into dry ingredients until moist. Pour batter into a greased 8x8-inch pan. Bake on Casserole, using Shelf Position #4, for 15-25 minutes or until done.

Yield 6-8 servings

PEACH PECAN COFFEE CAKE

- 1-1/2 cups self-rising flour
 - 1/2 cup sugar
 - 1/3 cup unsalted butter, softened
 - 1 large egg
 - 1/2 cup milk
 - 3 large ripe peaches, sliced
 - 1/3 cup soft brown sugar
 - 1/4 cup pecans broken into small pieces
 - 1-1/2 tablespoons butter, melted
 - 1/2 teaspoon ground cinnamon
- sour cream, crème fraîche, or whipped cream to serve

Grease and line with wax paper an 8x8-inch baking pan. Put the flour, sugar, butter, eggs and milk into a large bowl and beat with an electric mixer for a few minutes or until smooth. Spoon and spread batter evenly into the prepared baking pan. Arrange the peach slices over the batter. In a small bowl thoroughly mix the brown sugar, melted butter, pecans and cinnamon. Sprinkle the mixture over the peaches. Bake on Cake in Shelf Position #4 for 40 minutes, testing for doneness with a toothpick inserted and withdraw clean from the center. Serve warm or cool with cream topping of choice.

Yield 9 servings

Recipes

TOFFEE BARS

Layer 1:

- 1 8-ounce package Jiffy® yellow cake mix
- 1 egg
- 3 tablespoons butter, melted

Layer 2:

- 1 cup evaporated milk
- 1 egg
- 1 teaspoon vanilla extract

Layer 3:

- 1/2 cup nuts (optional)
- 5 ounces toffee chips

Spray an 8x8-inch baking pan with non-stick spray. Beat cake mix, egg and butter with an electric mixer for 2 minutes. Spread into prepared pan. Mix together milk, egg and vanilla, pour over first layer. Mix together nuts and toffee chips and sprinkle over top. Bake on Cake in Shelf Position #4 for 30 minutes, checking for doneness with a toothpick inserted and withdrawn clean from the center.

Yield 9 Servings

CRAB AND CHEESE MUFFINS

- 1/2 cup butter, softened
- 1 8-ounce jar Old English cheddar Cheese® spread, softened
- 1-1/2 teaspoons mayonnaise
- 1/2 teaspoon garlic salt
- 1/2 teaspoon seasoned salt
- 2 6-ounce cans crab meat, drained and rinsed
- 6 English muffins, split to make 12 halves

With and electric mixer, cream together butter and cheese spread. Mix in mayonnaise and salts, stir in crab. Spread on muffins. Place in the Bake/Broil Pan and Broil in Shelf Position #2 for 3-10 minutes or until hot and bubbly.

Yield 12 Servings

BRIE KISSES

- 1 pound Brie cheese
 - 1 can Hungry Jack Flaky Layer Biscuits
- hot pepper jelly

Cut Brie into 1/2 inch squares (leave the rind on if you like). Spray a mini-muffin pan with non-stick spray. Separate each biscuit into 3-4 layers pressing each layer into one section of a mini-muffin pan. Place a dab of pepper jelly in each cup, then top with a chunk of cheese. Bake on Casserole in Shelf Position #4 for 3-5 minutes or until cheese is melted and crust golden in color.

Yield 25-30 Servings

Recipes

CRAB AND SHRIMP MEDLEY

- | | | | |
|-----|---|-----|------------------------------------|
| 1 | cup bay or salad shrimp | 1/2 | cup sour cream |
| 1 | cup flaked crab meat | 3/4 | cup fresh bread crumbs |
| 1/2 | cup chopped red pepper | 2 | tablespoons Worcestershire sauce |
| 1/2 | cup chopped celery | 1 | tablespoon white pepper |
| 1/3 | cup chopped green onions & tops | 1/8 | teaspoon Cayenne pepper (optional) |
| 1/2 | cup mayonnaise | 1/2 | teaspoon salt |
| 6 | tablespoons Parmesan cheese, freshly grated | | |

Combine all ingredients except 1/4 cup of bread crumbs and 2 tablespoons of the Parmesan cheese. Mix well. Place crab and shrimp mixture in a 8x8-inch baking dish. Mix together the remaining bread crumbs and Parmesan cheese and sprinkle evenly over the seafood mixture. Bake on Casserole in Shelf Position #3 for 40 minutes or until the mixture is bubbling along the sides and the top is golden brown. Serve on crackers or as a dip.

Yield 15 Servings

BROILED SHRIMP SKEWERS

- 24 large shrimp, peeled and de-veined
 - 4 tablespoons olive oil
 - 3 tablespoons chopped fresh parsley
 - 3 medium garlic cloves, minced salt and freshly ground black pepper
- lemon wedges to serve

Rinse the shrimp in cold water and pat dry with paper towels. In a bowl, combine the olive oil, parsley, garlic, salt and pepper to season. Toss the shrimp in the mixture to coat thoroughly. Cover and marinate for 1 hour in the refrigerator. Thread 6 of the shrimps onto each of the four wood or metal skewers, through the shrimp tails front to back, so that the tails are curled and firmly held in place. Place the skewers on the Bake/Broil Pan assembly. Broil in Shelf Position #2 for 3-10 minutes on each side or until the shrimp become pink. Serve with lemon wedges.

Yield 4 Servings

HERB CRUSTED CHICKEN BREASTS

- | | | | |
|-----|--|-----|-----------------------------------|
| 4 | chicken breast halves, boneless-skinless | 2 | tablespoons chopped fresh parsley |
| 3 | tablespoons butter, melted | 2 | medium garlic cloves, minced |
| 1 | cup fresh bread crumbs | 1/4 | teaspoon Italian seasoning |
| 1/4 | cup freshly grated Parmesan cheese | | salt and fresh ground pepper |

Grease a 7x11-inch baking pan. Brush both sides of the chicken breasts with melted butter. Season with salt and freshly ground black pepper. In a small mixing bowl, combine the bread crumbs, Parmesan cheese, parsley, garlic and Italian seasoning until well blended. Coat each chicken breast thoroughly in the bread crumb mixture. Arrange in baking pan. Bake on Poultry in Shelf Position #4 for 35-45 minutes or until the juices run clear, and the crust is a light golden brown.

Yield 4 Servings

LIMITED ONE YEAR WARRANTY

Warranty: This Westinghouse product is warranted by Salton, Inc. to be free from defects in materials or workmanship for a period of (1) year from the original purchase date. This product warranty covers only the original consumer purchaser of the product.

Warranty Coverage: This warranty is void if the product has been damaged by accident in shipment, unreasonable use, misuse, neglect, improper service, commercial use, repairs by unauthorized personnel, normal wear and tear, improper assembly, installation or maintenance abuse or other causes not arising out of defects in materials or workmanship. This warranty is effective only if the product is purchased and operated in the USA, and does not extend to any units which have been used in violation of written instructions furnished with the product or to units which have been altered or modified or to damage to products or parts thereof which have had the serial number removed, altered, defaced or rendered illegible.

Implied Warranties: ANY IMPLIED WARRANTIES WHICH THE PURCHASER MAY HAVE ARE LIMITED IN DURATION TO ONE (1) YEAR FROM THE DATE OF PURCHASE. Some states do not allow limitations on how long an implied warranty lasts, so the above limitation may not apply to you.

Warranty Performance: During the above one-year warranty period, a product with a defect will be either repaired or replaced with a reconditioned comparable model (at our option) when the product is returned to the Repair Center, or the purchase price refunded. The repaired or replacement product will be in warranty for the balance of the one-year warranty period and an additional one-month period. No charge will be made for such repair or replacement.

Service and Repair: Should the appliance malfunction, you should first call toll-free 1 (800) 934-7455 between the hours of 9:00 am and 5:00 pm Central Standard Time and ask for CONSUMER SERVICE stating that you are a consumer with a problem. Please refer to model number WST3028 when you call.

In-Warranty Service (USA): For an appliance covered under the warranty period, no charge is made for service or postage. Call for return authorization (1 800 934-7455).

Out-of-Warranty Service: A flat rate charge by model is made for out-of-warranty service. Include \$15.00 (U.S.) for return shipping and handling. We will notify you by mail of the amount of the charge for service and require you to pay in advance for the repair or replacement.

For Products Purchased in the USA, but Used in Canada: You may return the product insured, packaged with sufficient protection, and postage and insurance prepaid to the USA address listed below. Please note that all customs duty / brokerage fees, if any, must be paid by you and we will require you to pay the cost of customs duty / brokerage fees to us in advance of our performing any service.

Risk During Shipment: We cannot assume responsibility for loss or damage during incoming shipment. For your protection, carefully package the product for shipment and insure it with the carrier. Be sure to enclose the following items with your appliance: any accessories related to your problem, your full return address and daytime phone number, a note describing the problem you experienced, a copy of your sales receipt or other proof of purchase to determine warranty status. C.O.D. shipments cannot be accepted.

To return the appliance, ship to:

Attn: Repair Center
Salton, Inc.
708 South Missouri Street
Macon, MO 63552

To contact us, please write to, call, or email:

Salton, Inc.
P.O. Box 6916
Columbia, MO 65205-1637
1(800) 934-7455
Email: Salton@Saltonusa.com

Limitation of Remedies: No representative or person is authorized to assume for Salton, Inc. any other liability in connection with the sale of our products. There shall be no claims for defects or failure of performance or product failure under any theory of tort, contract or commercial law including, but not limited to negligence, gross negligence, strict liability, breach of warranty and breach of contract. Repair, replacement or refund shall be the sole remedy of the purchaser under this warranty, and in no event shall Salton be liable for any incidental or consequential damages, losses or expenses. Some states do not allow the exclusion or limitation of incidental or consequential damages, so the above limitation or exclusion may not apply to you.

Legal Rights: This warranty gives you specific legal rights, and you may also have other rights which vary from state to state.

WESTINGHOUSE,  and "YOU CAN BE SURE...IF IT'S WESTINGHOUSE" are trademarks of WESTINGHOUSE ELECTRIC CORPORATION and used under license by Salton, Inc.

For more information on Salton products: Visit our website: www.eSalton.com

Patent Pending

© 2004 Salton, Inc. All Rights Reserved

Printed in China

P/N 61516