

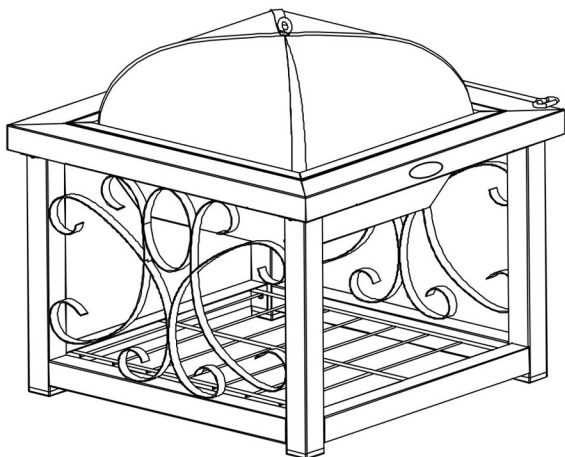







Fire Pit



Parts List

- | | | | | | |
|---|---|---------------------|---|---|-------------------|
| 1 |  | M6x15 screw (12PCS) | 5 |  | 6mm Washer (5PCS) |
| 2 |  | M5x10 screw (1PC) | 6 |  | Ring Screw (1PC) |
| 3 |  | M5 Nut(1PC) | 7 |  | M6 Nut (1PC) |
| 4 |  | M6x10 screw (4PCS) | | | |

Fire Pit



Assembly Instructions

Step 1

1. Use 4pcs screw (M6x15) to fix the left leg stand with the table frame;
2. Use 4pcs screw (M6x15) to fix the right leg stand with the table frame.

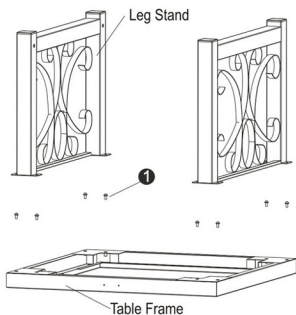

Step 2

- Use 4pcs screw (M6x15) to fix the fire wood bottom and the two leg stands.

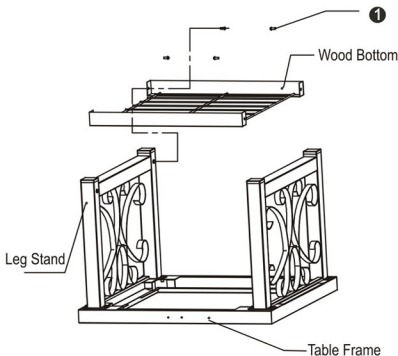

Step 3

1. Use 1pc screw (M5x10) and 1pc M5 nut to fix the vent door under the bowl. Make sure the vent door can be operated smoothly.
2. Use 4pcs M6x10 screw =4pcs and 4pcs 6 mm washers to fix the two bowl's handles in the respective holes.

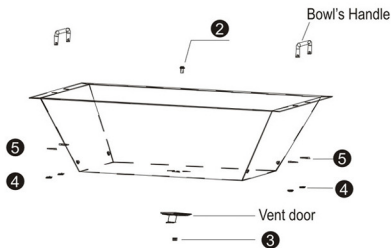

Step 4

- Fix M6 ring screw, M6 nut and the cover.

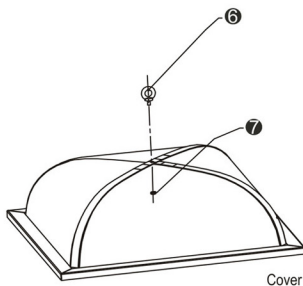

Fire Pit



Assembly Instructions

Step 5

1. Assemble the stand.
2. Place the fire bowl into the stand.
3. Place wood grate and cooking grate in fire bowl.
4. Place table top on the fire bowl. Note: Please rotate the table top at 90 degrees if the table top does not sit flush in the fire bowl.
5. Place cover on table top.
6. Use fire tool to move cover.

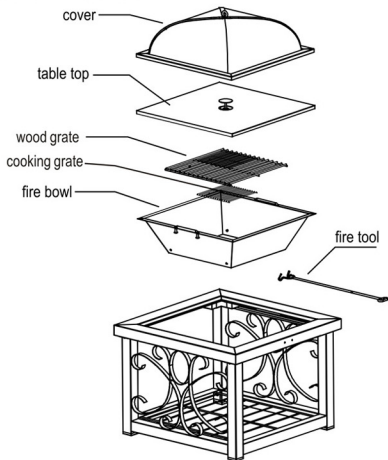

Step 6

Fully assembled product.

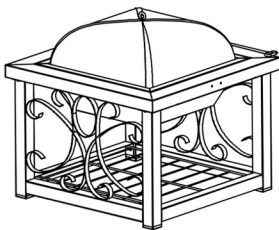

Caution

Warning: to avoid injury

1. For outdoor use only.
2. Do not use the fire pit indoors due to hazard of carbon monoxide fumes. Lack of ventilation can cause death.
3. Do not use gasoline or kerosene in this fire pit.
4. This unit is designed to burn charcoal and untreated wood only.
5. Do not use under unprotected combustible structures. Keep combustible materials at least 3 feet (36 inches) away from all sides of unit.
6. Protective gloves and long-handled tools are recommended for use with this fire pit.
7. Dispose of packaging materials properly.
8. The mesh cover must be kept on fire pit during use to prevent fires.
9. Do not use unit on wooden decks or other combustible surfaces.
10. Keep children away from hot fire pit.
11. Caution: fire pit remains very hot for a period of time after using.
12. Be sure fire pit has cooled down before attempting to move it.

Distributed By:
Well Traveled Living
716 S 8th Street
Amelia Island, FL
32034



Web: www.wtliving.com
Email: cservice@welltraveled.net

1 YEAR LIMITED WARRANTY – Customers in the Continental US

All components are warranted for a period of 1 year after date of purchase by the original owner against defects in materials and workmanship under normal use. This warranty does NOT cover normal wear and weathering, assembly and/or maintenance OR use in a commercial application. At Well Traveled Living's sole discretion, products under warranty will be repaired and/or replaced at no charge to the customer. Any returns sent back to Well Traveled Living must be sent via prepaid freight and in the original retail packaging.

For warranty service contact Well Traveled Living at the address, phone numbers or internet site and email listed in this owner's manual. Be sure to have your sales receipt, date of purchase and catalogue/model numbers available when calling. All warranty service will be coordinated by the Well Traveled Living's, Amelia Island, Florida service center.

This warranty is extended only to the original purchaser. Proof of purchase will be required before warranty service is rendered. The sales receipt is the only valid proof of purchase. This warranty only covers failures due to defects in materials or workmanship which occur during normal use. Failures and/or damage which result from accident, negligence, misuse, abuse, neglect, mishandling, alteration or modification, failure to maintain, improper assembly or maintenance, service by unauthorized agency or use of unauthorized components or damage that is attributable to acts of God are NOT covered.

*****THERE ARE NO EXPRESS WARRANTIES EXCEPT AS LISTED ABOVE*****

*****PURCHASER ASSUMES ALL RISKS IN THE ASSEMBLY AND OPERATION OF THIS UNIT*****

*****FAILURE TO FOLLOW WARNINGS AND OPERATIONAL INSTRUCTIONS CONTAINED IN THIS MANUAL CAN RESULT IN SEVERE PROPERTY DAMAGE AND/OR PERSONAL INJURY*****

IN NO EVENT WILL WELL TRAVELED LIVING, OR ITS DIRECTORS, OFFICERS OR AGENTS BE LIABLE TO THE PURCHASER OR ANY THIRD PARTY, WHETHER IN CONTRACT, IN TORT, OR ON ANY OTHER BASIS, FOR ANY INDIRECT, SPECIAL, PUNITIVE, EXEMPLARY, CONSEQUENTIAL, OR INCIDENTAL LOSS, COST, OR DAMAGE ARISING OUT OF OR IN CONNECTION WITH THE SALE, MAINTENANCE, USE, OR INABILITY TO USE THE PRODUCT, EVEN IF WELL TRAVELED LIVING OR ITS DIRECTORS, OFFICERS OR AGENTS HAVE BEEN ADVISED OF THE POSSIBILITY OF SUCH LOSSES, COSTS OR DAMAGES, OR IF SUCH LOSSES, COSTS, OR DAMAGES ARE FORESEEABLE. IN NO EVENT WILL WELL TRAVELED LIVING, OR ITS OFFICERS, DIRECTORS, OR AGENTS BE LIABLE FOR ANY DIRECT LOSSES, COSTS OR DAMAGES THAT EXCEED THE PURCHASE PRICE OF THE PRODUCT.

SOME JURISDICTIONS DO NOT ALLOW THE EXCLUSION OR LIMITATION OF INCIDENTAL OR CONSEQUENTIAL DAMAGES, SO THE ABOVE LIMITATION OR EXCLUSION MAY NOT APPLY TO THE PURCHASER.

This limited warranty gives you specific legal rights and you may also have other rights which vary from jurisdiction to jurisdiction. The provisions of the United Nations Convention on Contracts for the Sales of Goods shall not apply to this limited warranty or the sale of products covered by this limited warranty.

*****IMPORTANT NOTICE*****

-Do **NOT** return to place of purchase-
For customer service and warranty issues
contact our Customer Service Center at:
(866)-985-7877 OR

Email: cservice@welltraveled.net

Customer Service Hours: Mon. – Fri. 9:00 a.m. – 6:00

Fire Sense® and Well Traveled Living® are registered trademarks of Well Traveled Imports, Inc®. All assembly instruction presentations are the property of Well Traveled Imports, Inc.® and are protected by U.S. copyrights and trademarks. All rights reserved.