



intuos[®]4
professional pen tablet



User's manual for Windows[®] & Macintosh[®]

Intuos4 Wireless (model PTK-540WL)

Before you start

Wireless connection

Using the pen

Customizing your pen

Using the tablet

Customizing your tablet

Using the Radial Menu

Application-specific settings

Troubleshooting

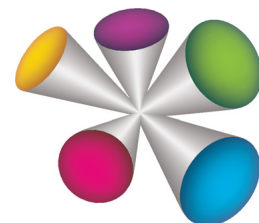



Intuos[®] 4 Wireless

User's Manual for Windows[®] & Macintosh[®]

Version 1.0, Rev L1709

Copyright © Wacom Co., Ltd., 2009

All rights reserved. No part of this manual may be reproduced except for your express personal use.

Wacom reserves the right to revise this publication without obligation to provide notification of such changes.

Wacom does its best to provide current and accurate information in this manual. However, Wacom reserves the right to change any specifications and product configurations at its discretion, without prior notice and without obligation to include such changes in this manual.

The above year indicates when this manual was prepared. However, the date of release to the users of the "manual" is simultaneous with the introduction into the market of the applicable Wacom product.

Tool ID and DuoSwitch are trademarks, and Intuos and Wacom are registered trademarks of Wacom Co., Ltd.

The Bluetooth[®] word mark and logo are registered trademarks and are wholly owned by the Bluetooth SIG, Inc. Any use of such marks by Wacom Co., Ltd. is under license.

Adobe, Photoshop, and Reader are either registered trademarks or trademarks of Adobe Systems Incorporated in the United States and/or other countries. Microsoft, Windows, and Vista are either registered trademarks or trademarks of Microsoft Corporation in the United States and/or other countries. Apple, the Apple logo, and Macintosh are registered trademarks of Apple Computer, Inc., registered in the U.S. and other countries. Any additional company and product names mentioned in this documentation may be trademarked and/or registered as trademarks.

Mention of third-party products is for information purposes only and constitutes neither an endorsement nor a recommendation. Wacom assumes no responsibility with regard to the performance or use of these products.

ExpressKey is a registered trademark of Ginsan Industries, Inc., and is used with permission.





Reuse, recycling, and recovery. You are urged to recycle this product when replacing it with a newer product or when it has outlived its useful life by bringing it to an appropriate collection point for recyclable materials in your community or region. By doing this, you can help improve the environment of your community as well as minimize the potential negative effects created should any hazardous substance that may possibly be present within waste material reach the environment during the disposal process.

Within the European Union, users are required not to dispose of Waste Electrical and Electronic Equipment (WEEE) as unsorted municipal waste, according to the Directive 2002/96/EC of the European Parliament and of the Council of 27 January 2003, or the corresponding local laws of the Member States. Products for which this is applicable will be marked with the WEEE symbol shown at the beginning of this note unless this is not feasible because of the size or the function of the product. Wacom products are subject to the Directive 2002/96/EC and therefore you should always collect them separately and bring them to the appropriate collection point in your community or region.

Wacom professional pen tablet products comply with the European Union RoHS Directive 2002/95/EC (RoHS Directive).

You are urged to properly dispose of any waste battery or accumulator by bringing it to an appropriate collection point for recyclable materials in your community or region. By doing this you can help improve the environment of your community as well as minimise the potential negative effects created for the environment and human health, should any of the substances used in batteries and accumulators reach the environment during the disposal process.

Within the European Union, items identified by the above symbol shall not be treated as unsorted municipal waste, according the Directive 2006/66/EC of the European Parliament and of the Council of the 6 September 2006, or the corresponding local laws of the Member States.

Batteries and accumulators for which this is applicable will be marked with the symbol shown at the beginning of this note unless this is not feasible because of the size or the function of the product. Batteries used in the Wacom products are subject to the Directive 2006/66/EC and therefore you should always collect them separately and bring them to the appropriate collection point in your community or region.



CONTENTS

About the manual	6	Working with tablet properties	36
Navigating the manual	7	Customizing the pen	37
YOUR INTUOS4 WIRELESS TABLET	8	Adjusting tip feel and double-click	38
Tablet features	8	Adjusting eraser feel	39
Intuos4 pen	10	Advanced tip and eraser pressure settings	39
Battery and power management	10	Customizing tool buttons	40
Battery activation	11	Customizing tilt sensitivity	41
Charging the battery	11	Customizing the optional mouse	41
Power saving features	13	Customizing the mouse buttons	42
Battery status and wireless connection lights	14	Customizing the tablet functions	43
Wireless connection	15	Customizing the ExpressKeys	44
Establishing a Bluetooth connection	16	Customizing the Touch Ring	45
Optimizing the Bluetooth connection	18	Tablet to screen mapping	46
USB data connection	18	Orientation	48
BEFORE YOU GET STARTED	19	Screen area	49
Ergonomics	19	Force proportions	50
Configuring the tablet orientation	20	Tablet area	50
Understanding the tablet active area	21	Button functions	51
Working with multiple monitors	22	Using and customizing the Radial Menu	57
WORKING WITH INTUOS4	23	Working with Display Toggle	58
Using the Grip Pen	23	Working with multiple tools	60
Holding the pen	24	Application-specific settings	61
Positioning	25	Creating an application-specific setting	62
Clicking	26	Changing application-specific settings	62
Dragging	26	Removing application-specific settings	62
Using the side switch	27	TROUBLESHOOTING	63
Drawing with pressure sensitivity	28	Testing your tablet	64
Drawing with tilt	28	Testing your tools	66
Erasing	29	Testing a pen	67
Eye-hand coordination exercise	29	Testing the Touch Ring	68
Working with the tablet	30	Testing the ExpressKeys	68
Using the ExpressKeys	31	Testing the optional mouse	69
Using the Touch Ring	32	Troubleshooting tables	70
CUSTOMIZING INTUOS4	33	Connection problems	70
Opening the control panel	33	General problems	72
Control panel overview	34	Windows-specific problems	76
		Mac-specific problems	77



Technical support options	79	Ordering parts and accessories	96
Obtaining driver downloads	80	Available parts and accessories	97
APPENDIX	81	Radio and television interference	99
Tablet installation	81	FCC notice	99
Battery life information	82	Industry Canada (Canada only)	100
Replacing the tablet battery	83	CE declaration	100
Caring for your tablet and tools	83	Precautions	101
Replacing the pen tip	84	Warnings	101
Uninstalling the software	85	Safety precautions for Lithium-Ion batteries	102
Managing your tablet preferences	85	Cautions	103
Changing the tablet mode options	86	License and Warranties	
Installing multiple tablets	86	(Worldwide, Except for Europe, Africa and Middle East)	104
Advanced options	87	Software License	104
Optimizing the ExpressKeys display	88	Limited Warranty	104
Using applications integrated for tablet control	88	Warranty Service in the U.S.A. and Canada	105
Using the optional Intuos4 Mouse	89	Warranty on Sales Outside of the U.S.A. and Canada	106
Using the optional Airbrush and Art Pen	90	Licence warranty conditions	
Pen and digital ink capabilities in Windows	91	(Europe, Africa and Middle East)	107
About the Windows Tablet PC Input Panel	92	Software Licence Agreement	107
Product specifications	93	Limited Warranty	108
Intuos4 Wireless tablet (model PTK-540WL)	93	GLOSSARY	110
Intuos4 Grip Pen (model KP-501E-01)	94	INDEX	113
Intuos4 Mouse (model KC-100)	94		
Intuos4 Airbrush (model KP-400E-01)	94		
Intuos4 Inking Pen (model KP-130-01)	95		
Intuos4 Art Pen (model KP-701E-01)	95		
Intuos4 Classic Pen (model KP-300E-01)	95		
Product information	96		



ABOUT THE MANUAL

This manual provides quick access to information about Intuos4. The information is common to Windows and Macintosh computers and Windows screen captures are shown, unless otherwise noted.

- Go directly to [contents](#) or [index](#) topics by clicking on them.
- [Your Intuos4 Wireless tablet](#) introduces you to the various features of your wireless pen tablet and input tools. Information is also included for battery and power management, and details on making a wireless connection.
- [Before you get started](#) provides knowledge points that will help you work more comfortably with the tablet, and to better understand how you and the tablet interact with your computer.
- [Working with Intuos4](#) is the learning chapter. It describes how to use your tablet and input tools and includes exercises for new users.
- [Customizing Intuos4](#) describes how to optimize your Intuos4 tablet and tools for the way you like to work.
- Want to test your tablet and tools? Need troubleshooting guidelines? [Troubleshooting](#) is where you will find the answers to most common questions.
- The [appendix](#) includes more information related to your tablet. Included are tips about getting the most from your tablet battery, tips on product care, a how-to on uninstalling the software, your license and warranty, and more. Also included is an overview of the pen and [digital inking](#) capabilities found in Microsoft Windows 7 and Vista.

Note: This manual does not describe how to install your Wacom tablet. Please refer to your product Quick Start Guide and to the automated software installer (located on the Intuos installation CD) for details.

If you are new to electronic documentation, read [navigating the manual](#).

- SMALL CAPITAL LETTERS are used to identify the names of keyboard keys, dialog boxes, and control panel options.
- You can use your viewer zoom-in tool to increase the size of the manual on your display screen.
- The following information is not included with this product: information about your specific computer hardware or operating system, information about another manufacturer's Bluetooth hardware or software, or information about your application software. Your best source for this information is the set of manuals and discs that came with your hardware, operating system, or application.
- Many applications have built-in support for Intuos4 features such as pressure sensitivity, tilt, and the pen eraser. You can find a listing of applications that support these features on Wacom's web site (see [product information](#)).
- For information on how best to use Intuos4 features within a specific application, see the instructions in that application's manuals.

Wacom's philosophy is to continually improve all of its products. As a result, engineering changes and improvements are made from time to time. Therefore, some changes, modifications, and improvements may not be covered in this manual.





NAVIGATING THE MANUAL

Use the navigation controls to move through the manual.



Go to front page.

Contents

Go to table of contents.

Index

Go to index.



Go back to previous view.



Page back, or page forward.

[topic](#)

Go to topic.



Topic continued.

Adobe® Reader® provides additional tools for using and printing the manual. See the Adobe Reader help for more information.



YOUR INTUOS4 WIRELESS TABLET

This section introduces you to the Intuos4 Wireless professional pen tablet. Intuos4 consists of two basic elements: a wireless tablet that serves as your work area, and the [input tools](#) you use on the tablet.

The quickest way to learn about Intuos4 is to become familiar with its appearance and features.

[Tablet features](#)

[Intuos4 pen](#)

[Battery and power management](#)

[Wireless connection](#)

[USB data connection](#)

TABLET FEATURES

Status LEDs

- An LED will glow dimly when the tablet is on, and brighten when a tool button is pressed.
- LEDs also indicate which of the four Touch Ring functions are active.

Touch Ring

Includes toggle button at center of ring. Press to:

- Toggle between Touch Ring functions.
- Wake tablet from auto sleep mode.

ExpressKeys

ExpressKeys display

Shows the current ExpressKey settings.

Wireless connection light

See [establishing a Bluetooth connection](#).

Battery status light

Active area

This is the active area for pen input. Learn about your [Intuos4 pen](#).

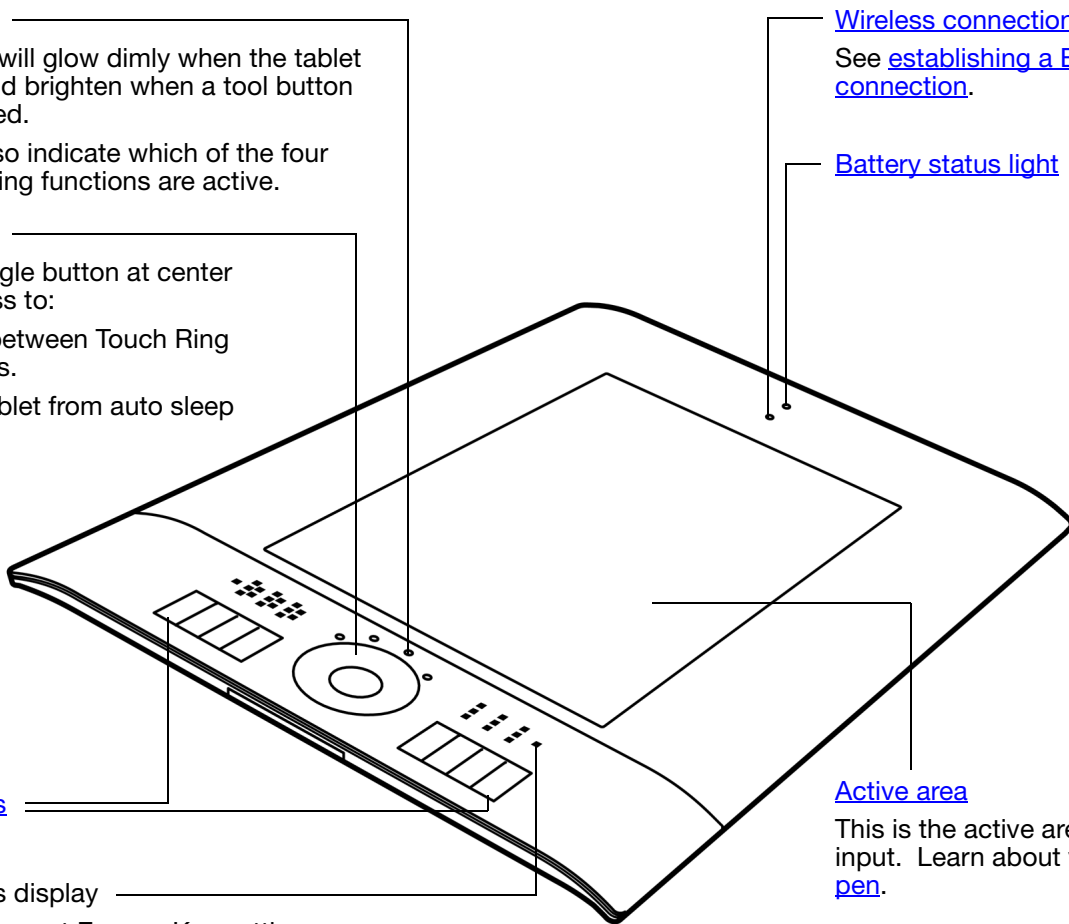

USB charging cable

To charge Intuos4, first plug the USB charging cable into the tablet. Connect the other cable end to a USB port located directly on your computer, or to a powered USB hub. See [charging the battery](#).

You can work while charging. See [USB data connection](#).

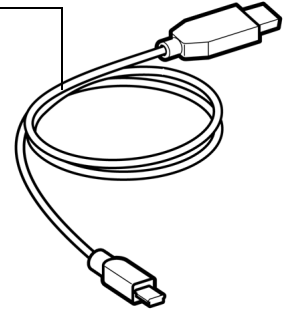

Power switch and indicator

Slide switch to turn tablet on and off. Indicator shows red when the switch is in the on position. Switch must be in the on position to use tablet.

Battery compartment

With your fingernail, press inward on the latch bar and flip cover outward to open.

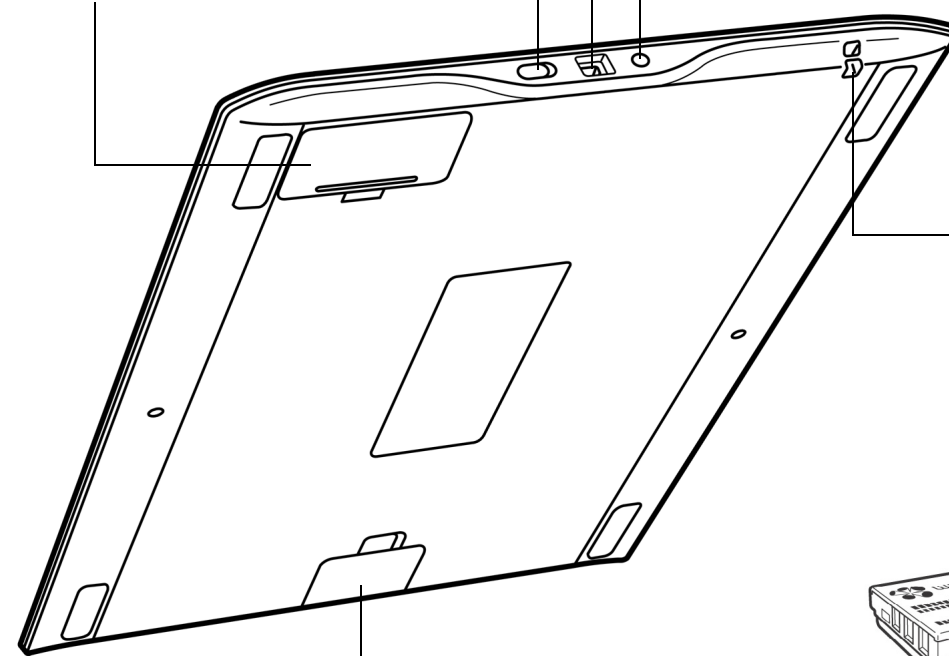

USB port
Power input and data connection.

Pairing button
See [establishing a Bluetooth connection](#).

Anchor point
The Intuos4 pen tether (sold separately) or aftermarket security cables can be connected to the anchor point.

Pen holder location

Cover unsnaps for easy removal and attachment of the optional pen holder.

[Pen holder](#), attachable.

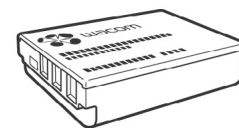
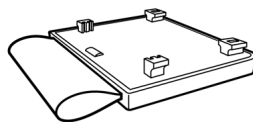

Rechargeable Lithium-ion (Li-Ion) battery
Pre-installed. To activate, see [battery activation](#). See also [charging the battery](#).

INTUOS4 PEN

All Intuos4 input tools are cordless and battery free.

[Eraser](#)

Grip area

[DuoSwitch](#)
(rocker style side switch)

[Replaceable nib](#)
(pen tip)

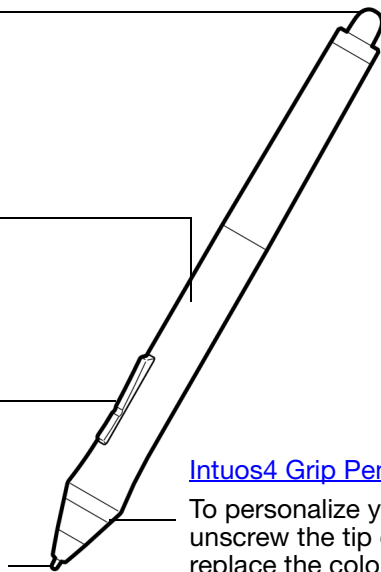

[Intuos4 Grip Pen](#)

To personalize your pen, unscrew the tip cone and replace the colored ring with one of another color (included).

Pen stand

Unscrew the base to access a nib extraction tool and assorted replacement nibs.



Nib extractor

Replacement nibs

- 5 standard nibs, black
- 1 flex nib, white and black
- 1 stroke nib, white
- 3 hard felt nibs, gray

See [available parts and accessories](#) for information on additional input tools and accessories. Also available is a travel sleeve that can be used to protect your tablet when traveling, or for storing the unit.

BATTERY AND POWER MANAGEMENT

This section contains important information about the battery and power management features of your Intuos4 pen tablet. Be sure to review the following items:

[Battery activation](#)

[Charging the battery](#)

[Power saving features](#)

[Battery status and wireless connection lights](#)

See also [working with the tablet](#) for more information about tablet features.

BATTERY ACTIVATION

Your wireless pen tablet uses a rechargeable Lithium-Ion (Li-Ion) battery. Before you can charge or work with Intuos4 you must first remove the insulating safety tag from between the battery and tablet contacts.

1. Turn the wireless tablet upside down and open the battery cover. Use your fingernail to press inward on the latch bar and flip the cover outward to open.
2. Making sure the battery stays in place, gently pull on the safety tag to remove it from between the battery and contact terminals. Discard the tag.
3. Close the battery cover. Move on to [charging the battery](#).

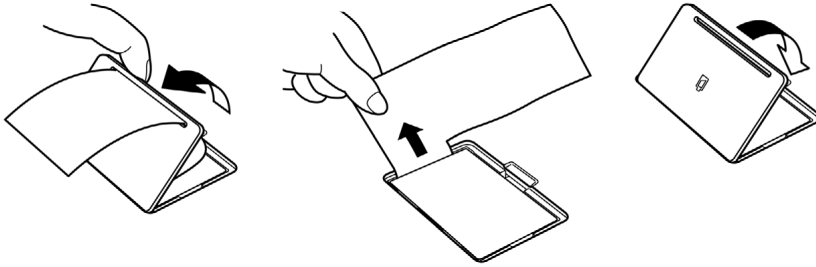

Warning: See the [safety precautions for Lithium-Ion batteries](#).

CHARGING THE BATTERY

Before using Intuos4 for the first time in wireless mode you should fully charge the tablet battery. Do this by connecting the USB cable between Intuos4 and a primary USB port (located directly on your computer), or to a powered USB hub.

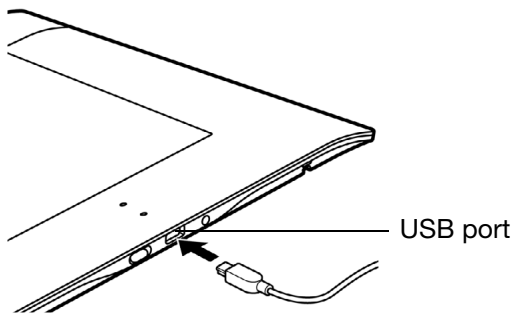

Tips:

You can continue with the tablet software installation process and use Intuos4 through the USB connection while the battery is charging. It will take about 5 hours to fully charge an empty battery when the tablet is off, and about 6 hours to fully charge it when the tablet is on. Actual charge time depends upon battery level and tablet use while charging.

Turning off the ExpressKeys display will reduce the charging time when using the tablet while it is charging. See [advanced options](#) for information on turning the ExpressKeys display on or off.

The battery status light glows yellow when charging, and glows green when fully charged.

See [battery status and wireless connection lights](#).

The USB cable is used for charging the battery, and to operate Intuos4 as a wired USB tablet. The battery will charge whenever the USB cable is connected and the battery is not fully charged.

Note: Whenever the tablet is connected using the USB cable, the Bluetooth antenna and any Bluetooth connection to the tablet will be automatically switched off.

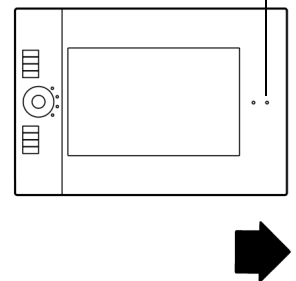



To check the current battery charge status, open the Wacom Tablet control panel and look at the tablet icon in the TABLET list of the control panel. See [working with tablet properties](#).

- To maximize battery operation time, consider turning off the ExpressKeys display (see [advanced options](#)).
- When you are done working, turn off the tablet using the tablet power switch in order to conserve battery power.
- The tablet will draw current from the battery whenever the power switch is in the on position. A small current is drawn even in auto sleep and tablet auto shut-down modes, and will slowly discharge the battery. It is a good idea to charge the battery and move the tablet power switch to the off position before leaving the tablet unused for a number of days.
- If the battery charge is low and the battery remains in the tablet for a long period of time (a week or longer) with the power switch in the on position, the small trickle of current used by the tablet is likely to discharge the battery so far that an internal protection circuit within the battery is activated. If this occurs you will no longer be able to charge the battery. To preserve your battery, move the tablet power switch to the off position before leaving the tablet unused for a week or longer.
- For extended storage (a month or longer), Wacom recommends that the battery be at least half full before you move the power switch to the off position. You do not need to remove the battery because the power switch disconnects the battery from the tablet circuit when in the off position.
- If your battery can no longer be charged or no longer holds a charge, the battery should be replaced. See [replacing the tablet battery](#).



Warning: See the [safety precautions for Lithium-Ion batteries](#).



POWER SAVING FEATURES

Intuos4 uses a number of power saving features designed to conserve the tablet battery charge and improve performance.

- Auto power save mode: Automatically reduces power to the Touch Ring status LEDs and ExpressKeys display as follows:

1 minute no user input:	Low LED and ExpressKeys display brightness
2.5 minutes no user input:	ExpressKeys display turns off Low LED brightness
Active user input:	Returns brightness to set level

- Auto sleep mode: To conserve battery power when the tablet is not in use, the tablet will automatically enter sleep mode after 30 minutes without user input. To resume operations, press the Touch Ring toggle button or move the power switch off and back on.

When there is no wireless connection for more than 5 seconds, such as when the computer is switched off or the tablet is moved out of range, Intuos4 also switches to sleep mode. To resume operations, ensure that your computer's Bluetooth support is working and that your tablet is within range. Then press the Touch Ring toggle button or move the power switch off and back on.

- Tablet auto shut-down: When the battery level is low, the tablet will automatically shut-down. When in tablet auto shut-down mode, the tablet will not function. Recharge the battery immediately, or move the power switch to the off position.

Important: If the power switch is left on (even in tablet auto shut-down mode) a small trickle of current will continue to flow, leading to eventual battery failure.

See also [working with tablet properties](#).



BATTERY STATUS AND WIRELESS CONNECTION LIGHTS

Observe the battery status and wireless connection lights to check the operational status of the tablet:

BATTERY STATUS LIGHT	TABLET AND BATTERY STATUS
Green	High battery charge (35% to 100%) remaining.
Red	Low battery charge (15% - 34%) remaining.
Red, flashing	Very low battery charge (less than 15%) remaining. You need to recharge the battery now!
Off	<p>Tablet has been turned off either manually or automatically, or no battery charge. Any of the following conditions can prompt the tablet to power off.</p> <ul style="list-style-type: none"> You move the power switch to the off position. After you press the pairing button, the tablet does not pair with a computer within 3 minutes. No user input for more than 30 minutes. Tablet enters sleep mode. No wireless connection for more than 5 seconds. Battery charge drops below operational level and no external power supply is connected to tablet. Connect the USB cable between Intuos4 and a primary USB port (located directly on your computer) or to a powered USB hub. If the LED still does not light, the battery should be replaced. See replacing the tablet battery. <p>If the tablet has automatically turned itself off and there is adequate battery or external power available, move the power switch off and then back on, or press the Touch Ring toggle button.</p>
Yellow	<p>Indicates that the USB cable is attached and the battery is charging. Light will change to green when battery is fully charged.</p> <p>Note: If the light does not go on, try turning on the tablet power switch. Some USB hubs will not supply power if the tablet is turned off.</p>

WIRELESS CONNECTION LIGHT	TABLET STATUS
Off	No Bluetooth connection between tablet and computer.
Blue, flashing	Discoverable mode (after pressing the pairing button or turning the tablet power on). Tablet is searching for a connection, or pairing with your computer. See establishing a Bluetooth connection .
Blue	Tablet is connected to computer using a Bluetooth wireless connection.





WIRELESS CONNECTION

The Intuos4 pen tablet connects to your computer via a wireless Bluetooth connection. Bluetooth is a radio-frequency technology, so it is not necessary for Intuos4 to be “in sight” of the Bluetooth antenna on your computer. The radio frequency can pass through non-metallic objects like desks.

Important: Intuos4 is a Class 2 Bluetooth enabled device, and can operate for up to 10 meters (33 feet) from the Bluetooth antenna of your computer.

Interference from other networks operating in the 2.4 GHz band, other Bluetooth enabled devices connected to your computer (especially audio devices), or metallic objects located in or along the line of sight can negatively impact the tablet performance and operating distance.

If you experience connection problems, see [optimizing the Bluetooth connection](#) for related tips and suggestions.

[Establishing a Bluetooth connection](#)

[Optimizing the Bluetooth connection](#)





ESTABLISHING A BLUETOOTH CONNECTION

Before connecting the tablet, ensure your computer has a working Bluetooth configuration that supports the Human Interface Device (HID) profile. If your computer does not have built-in Bluetooth support, obtain and install a commercially available USB-to-Bluetooth adapter (dongle).

The process whereby Intuos4 and the computer discover one another for the “first” time is called “[pairing](#)”. The following is an overview. For detailed instructions on pairing a Bluetooth enabled device to your computer and specific Bluetooth configuration, see the documentation that came with your operating system or Bluetooth support.

1. Turn on your computer and wait until the system has fully loaded.
2. Be sure the tablet power switch is in the on position and that the USB cable is not attached to an active USB port. Place the tablet in [discoverable](#) mode by pressing the pairing button located on the side of the tablet. The tablet wireless connection light will flash blue.

- The tablet will remain in discoverable mode for 3 minutes or until a pairing with your computer has been established. If pairing is not established within 3 minutes, the tablet will turn itself off.
- The tablet can only be paired (linked) to your computer while the tablet is in discoverable mode.
- The tablet can only be paired to a single computer at a time.

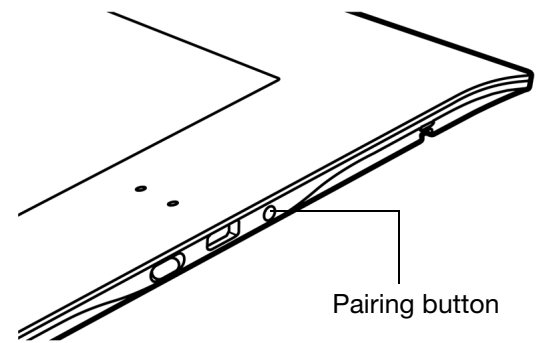

3. With the tablet in discoverable mode, open the Bluetooth devices control panel or select the Bluetooth icon from the menu bar or system tray. Turn on your Bluetooth support if necessary and choose to add a new device. Common options are ADD WIRELESS DEVICE or SET UP BLUETOOTH DEVICE. (In the control panel on a Mac, click the “+” icon to set up a new device.) Carefully follow all directions in the setup assistant.
 - If prompted for the device type to set up choose “tablet” (if available), otherwise choose “mouse”.
 - If prompted for an authentication code or passkey and your Bluetooth support complies with Bluetooth Specification v2.0, enter “0000”. Otherwise, select “don’t use” or “no”.
 - When successfully paired to your computer, Intuos4 will appear as a connected device in the Bluetooth devices control panel (showing in the device list as “PTK-540WL”) and the tablet wireless connection light will glow blue.
 - If the tablet is not listed in the control panel, refresh the assistant and again press the tablet pairing button.
4. Close the Bluetooth devices control panel. Check the connection by using the pen on the tablet to move the screen cursor.





If you have not already done so, install the Wacom tablet driver software. Insert the Intuos installation CD into your computer's CD-ROM drive, click on the INSTALL TABLET link, and follow the prompts to install the driver software.

Important: Remember that the Intuos4 Wireless tablet driver software must be installed before you can work with full tablet functionality and features such as pressure sensitivity with the pen.

After you have paired your wireless tablet and computer, they will remember the connection as if you had connected a virtual cable between them. The tablet will remember which computer it is connected to, and will reject all attempts by other computers to connect to it.

- When starting up your computer, wait until your operating system has completely loaded and then move the tablet power switch to the on position. The tablet and your computer will remember each other, and the Bluetooth connection will automatically be reestablished.
- If the link is broken for more than 5 seconds (e.g., you shut down your computer, unplug your USB-to-Bluetooth adapter (dongle) or otherwise switch off your Bluetooth support, or move the tablet too far away from the computer), the tablet will switch to sleep mode. To reestablish the connection, press the Touch Ring toggle button or turn the tablet power switch off and then on.

You can break the pairing between tablet and computer from either the tablet or from the computer to which it is linked. When the pairing is broken the tablet will once again become discoverable by any Bluetooth enabled computer. To disconnect the wireless tablet from a computer:

- From the tablet, simply press the pairing button located on the side of the tablet. A disconnect message will be sent to the computer.
- From the computer, open the Bluetooth devices control panel and delete the pairing for the tablet.

Important: The use of wireless devices is regulated in most countries. If you will be traveling with your wireless tablet, be sure to check with the appropriate regulatory authority for any restrictions that may apply to your product in the country of your destination.

 Products using wireless signals can interfere with the equipment on commercial aircraft, and regulations require that all wireless devices be turned off when traveling in an airplane. Turn off the Intuos4 tablet wireless signal by placing the power switch in the off position (the battery status light will be off) and do not move the power switch to the on position during takeoff, transit, or landing.

 Do not use Intuos4 in a facility control system or any other environment that requires extremely high reliability, or where the use of a wireless device may cause interference; the wireless tablet may interfere with or cause other electronic devices to malfunction, or other wireless devices may interfere with or cause the tablet to malfunction. Where use is prohibited, power off the tablet (ensuring the wireless signal has been turned off) to prevent the possibility of it interfering with or causing other electronic devices to malfunction. Wacom does not accept any liability for direct or consequential damages. For details, please refer to your Warranty, located at the end of this manual.



OPTIMIZING THE BLUETOOTH CONNECTION

If your screen cursor lags behind the pen movement on the tablet or frequently “jumps” about, or if you see excessive straight line segments when drawing in graphics applications, then your Bluetooth connection may not be able to transmit all of the data from the tablet with the necessary speed. This may be caused by interference from other radio sources, obstructions in the radio wave path, excessive distance from the computer, or a combination of the above.

Try the following actions to improve your Bluetooth connection and optimize tablet performance:

- Remove any metallic objects that may be in the line of sight between Intuos4 and your Bluetooth antenna or adapter.
- If you are using a USB-to-Bluetooth adapter (dongle), use a USB extension cable and place the adapter on your desktop or somewhere in sight of Intuos4.
- Use Bluetooth support that complies with Bluetooth Specification v2.1 and supports the EDR (Enhanced Data Rate) protocol. Contact the manufacturer of your Bluetooth support for details.
- Use a Class 1 Bluetooth adapter (dongle) on your computer.
- If you are using a computer with a built-in Bluetooth antenna, try reorienting the computer until you get a better data rate.
- Move the tablet closer to your computer’s Bluetooth antenna.
- Disconnect any Bluetooth audio devices, such as headsets, that may be connected to your computer.
- Switch off any other devices operating in the 2.4 GHz radio spectrum, such as WiFi networks, mobile telephones, etc., or move their antennas further away from your computer.

USB DATA CONNECTION

When using the tablet with a computer that is not Bluetooth enabled or in a situation where a wireless network is prohibited (such as on an airplane) you can use Intuos4 Wireless as a wired USB tablet.

Attach the USB cable to the tablet. Then connect the other end to a primary USB port located directly on your computer, or to a powered USB hub. Be sure to turn on the tablet power switch.

The tablet is fully functional when connected to your computer. The tablet battery charges through the cable.

Note: Whenever the tablet is connected using the USB cable, the Bluetooth antenna and any Bluetooth connection to the tablet will be automatically switched off.

Always be sure to use the USB cable that came with your Intuos4 Wireless tablet.

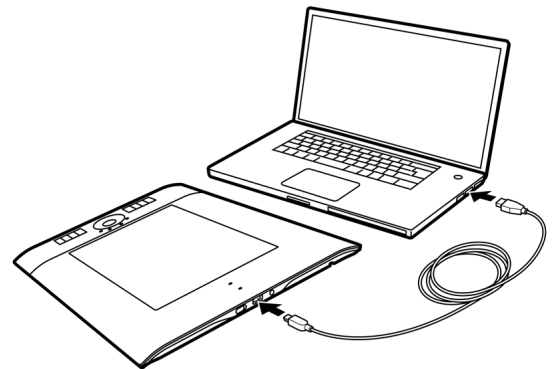

BEFORE YOU GET STARTED

This section provides information that will help you work more comfortably with the tablet, and to better understand how you and the tablet interact with your computer.

[Ergonomics](#)

[Configuring the tablet orientation](#)

[Understanding the tablet active area](#)

[Working with multiple monitors](#)

ERGONOMICS

To minimize fatigue, comfortably organize your work area. Position your tablet, input tools, and keyboard for easy access without unnecessary reaching. Adjust your monitor so you can view it comfortably with a minimum of eyestrain. For best results, position the tablet so the screen cursor follows the same direction as your hand movements on the tablet.



- Take short breaks between tasks to stretch and relax your muscles.
- Use a gentle grip when working with your tools.
- Alternate tasks and tools throughout the day.
- Maintain a good posture at all times. Minimize awkward postures and repetitive movements that cause discomfort.
- Change your position if you feel any discomfort due to your work position.
- For right-handed use, position the tablet so the drawing (active) area is located to the right of the ExpressKeys. If using the tablet as a primary pointing device and mouse replacement, consider placing it to the right of your keyboard.
- For left-handed use, position the tablet with the drawing area to the left of the ExpressKeys. See [configuring the tablet orientation](#) for details. If using the tablet as a primary pointing device and mouse replacement, consider placing it to the left of your keyboard.
- If using the tablet primarily as a creative tool, consider placing the tablet below the keyboard, centered with respect to your monitor.

Note regarding RSI: Wacom makes no representation, promise or guarantee that Wacom products will cure or prevent, in whole or in part, mouse-induced repetitive stress symptoms, injuries or conditions. Individual results may vary. Always obtain competent medical advice to determine the most appropriate treatment for your specific situation.

CONFIGURING THE TABLET ORIENTATION

You are prompted to choose a default tablet orientation when installing the tablet using the Intuos installation CD. At the log-in and user switching screens, the tablet orientation will use the default setting selected when the driver was installed. To change the default orientation, you must re-install the driver from the Intuos installation CD.

You can also change how your tablet is oriented using the following procedure. However, the default orientation used at the log-in screen will not be affected.

To set up Intuos4 for right-handed operation:

- Open the Wacom Tablet control panel and select the MAPPING tab. Choose the EXPRESSKEYS LEFT [orientation](#) option. The tablet driver automatically configures all aspects of the tablet (including the Wacom Tablet control panel options) for correct right-handed use.
- Next, physically rotate your tablet so the tablet ExpressKeys are positioned to the left.

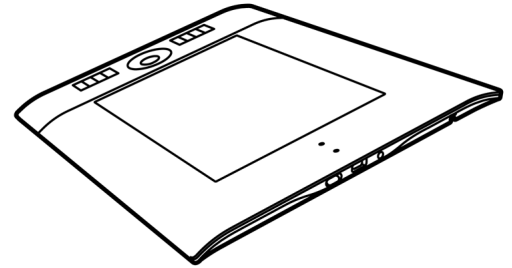

To set up Intuos4 for left-handed operation:

- Open the Wacom Tablet control panel and select the MAPPING tab. Choose the EXPRESSKEYS RIGHT [orientation](#) option. The tablet driver automatically configures all aspects of the tablet (including the Wacom Tablet control panel options) for correct left-handed use.
- Next, physically rotate your tablet so the tablet ExpressKeys are positioned to the right.

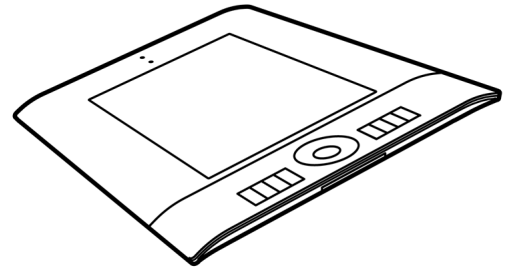

UNDERSTANDING THE TABLET ACTIVE AREA

Your Intuos4 pen and other input tools work only on the active area of the tablet.

Wherever you place the pen on the tablet, the screen cursor (pointer) will appear at the corresponding point on the screen. The screen cursor indicates pen position, and follows the movement of the pen across the tablet surface. This is the default setting for the pen.

Learn about [using the Grip Pen](#).

The active area is a mapped representation of your computer screen(s). By default it uses the entire screen, or all screens if you have multiple displays. You can customize the mapping relationship by setting the [tablet to screen mapping](#).

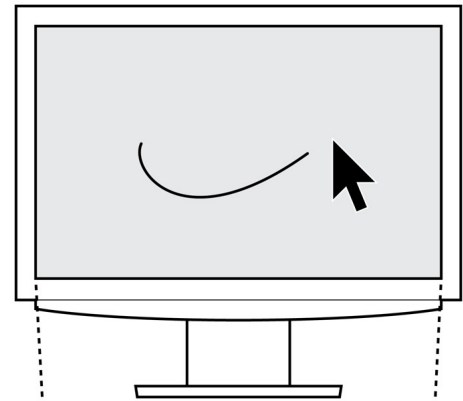

Tablet active area

The area of the tablet that senses pen movement.

Your Intuos4 input tools work only on the active area of the tablet.

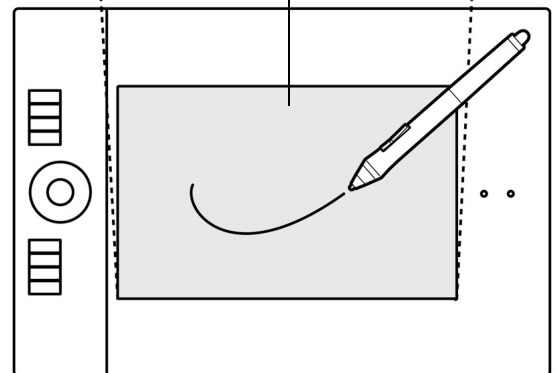

WORKING WITH MULTIPLE MONITORS

If your computer is equipped with more than one monitor, Intuos4 will map to the monitors based upon how they are configured in the display properties control panel.

- If more than one monitor is in use and you are in extended monitor mode, the tablet maps to all monitors as if they were one large display. The below image illustrates a tablet mapping to the entire system desktop, which is displayed on two monitors.

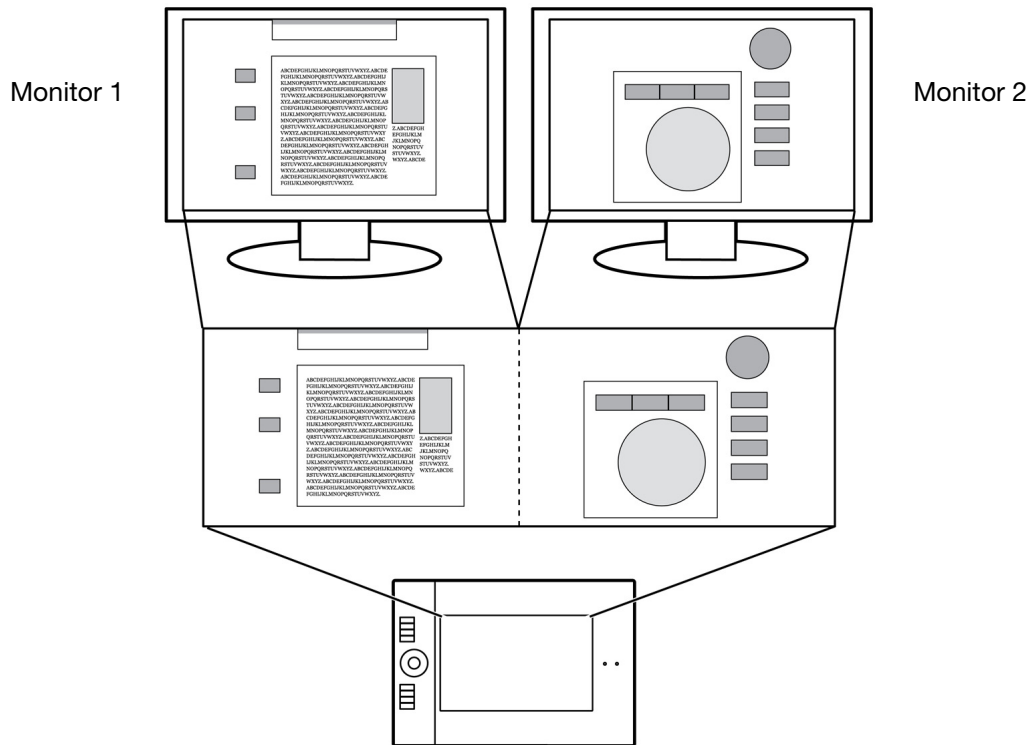

- If your monitors are in mirror mode (both monitors display the same content), the tablet maps to the entire space on each monitor and the screen cursor is displayed on each monitor simultaneously.

See your hardware and operating system documentation for details on configuring your computer and operating system for use with multiple monitors.

After you have correctly configured your computer for use with multiple monitors, you can then adjust the [tablet to screen mapping](#) by opening the Wacom Tablet control panel and changing the appropriate options. For example, you can map to a single monitor, or to a portion of the monitor area.

Tip: When your system is configured with multiple monitors, you can assign the DISPLAY TOGGLE function to an ExpressKey. This enables you to toggle the current tablet mapping and screen cursor between the system desktop or primary display and your other monitors. See [working with Display Toggle](#).



WORKING WITH INTUOS4

This section describes how to use your tablet and input tools and includes exercises for new users. If you are new to using a pen tablet and tablet input tools, read the following sections.

[Using the Grip Pen](#)

[Working with the tablet](#)

USING THE GRIP PEN

The pen is cordless, battery free, and pressure sensitive. There are four basic techniques for using the pen on the [active area](#) of the tablet: pointing, clicking, double-clicking, and dragging. If you are unfamiliar with using the pen, try the exercises on the following pages.

[Holding the pen](#)

[Positioning](#)

[Clicking](#)

[Dragging](#)

[Using the side switch](#)

[Drawing with pressure sensitivity](#)

[Drawing with tilt](#)

[Erasing](#)

[Eye-hand coordination exercise](#)



HOLDING THE PEN

Hold the Grip Pen like you would a normal pen or pencil. Adjust your grip so the side switch is in a convenient location where you can toggle it with your thumb or forefinger, but not accidentally press the switch while drawing or navigating with the pen. Tilt the pen in any way that feels most comfortable.

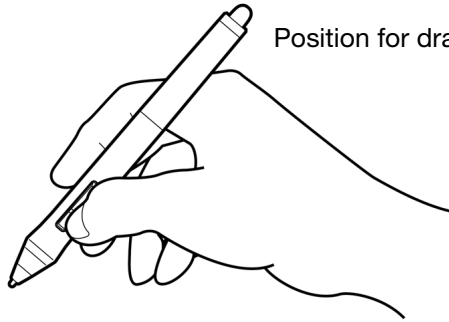

Position for drawing and navigating

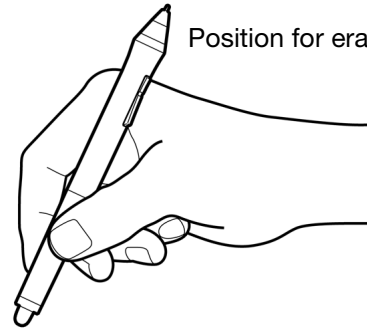

Position for erasing

Place the pen stand within easy reach of your tablet. The stand allows for vertical or horizontal placement of the pen.

Important: When not in use, place the pen in the pen stand or lay it flat on your desk. To maintain the sensitivity of your pen, do not store the pen in a container where it will rest on its tip or eraser.

Leaving an Intuos4 tool on the tablet may interfere with screen cursor positioning when using other pointing devices, or may prevent your computer from going to sleep.

Also, leaving the pen on the tablet when can prevent the tablet from switching off and cause the battery to discharge.

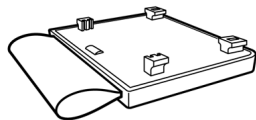
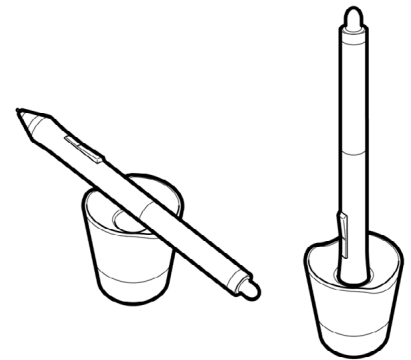

Your tablet also comes with an attachable pen holder. The pen holder is a handy feature for those times when it is inconvenient to use the desktop pen stand. The pen holder is optimized to securely hold the Grip Pen and optional Airbrush.

To attach the optional pen holder:

- Unsnap the pen holder cover and remove it from the tablet.
- Attach the pen holder in place of the cover part by snapping the pen holder into the tablet opening. Once attached, you can place the pen in the holder loop for safe-keeping.

The pen holder can be removed by unsnapping it from the tablet. To protect your tablet, always replace the pen holder cover when the pen holder is not attached.

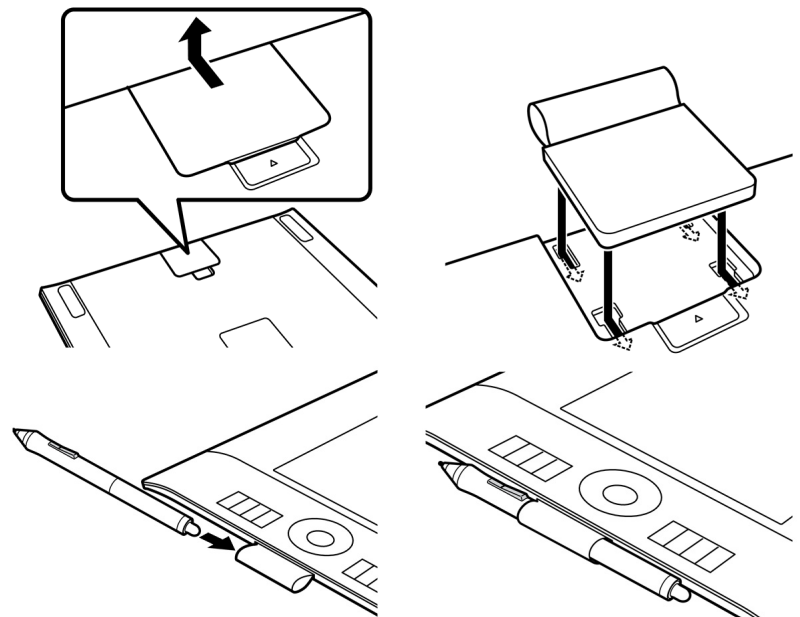

POSITIONING

The pen is used to position the cursor (or pointer) on your screen.

Lift the pen and place the pen tip on the tablet [active area](#). The cursor will appear at the new location.

Move the screen cursor by hovering the pen over the tablet surface. Do this without touching the tablet surface, but while still keeping the pen tip within [proximity](#) of the tablet.

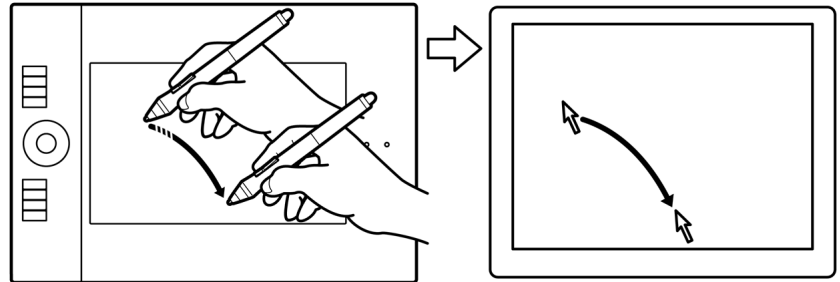

To select an icon or folder, use your pen to position the screen cursor over the object. Press down to select.

Tips:

If you find that using a pen is somewhat difficult, try the [eye-hand coordination exercise](#).

Pointing is easier when you orient the tablet square to the computer monitor so the screen cursor follows the same direction as your hand movements on the tablet.

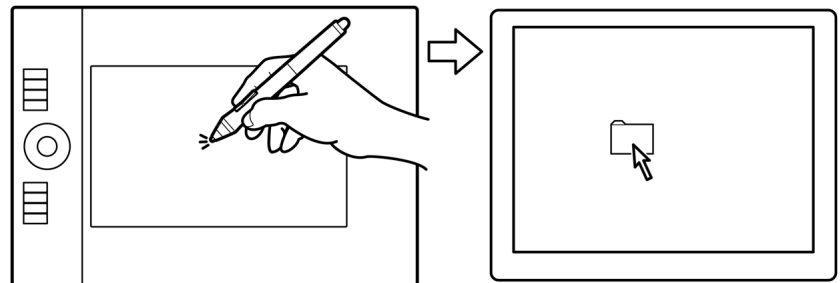

You can set the pen to position the screen cursor two different ways (see [tablet to screen mapping](#)).

- In [PEN MODE](#), wherever you place the pen on the tablet, the screen cursor will appear at a corresponding point on the display screen. The screen cursor indicates pen position, and follows the movement of the pen across the tablet surface. This is the default setting for the pen.

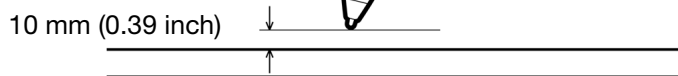
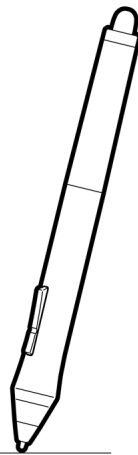

When positioning the screen cursor and operating a pen button, the pen tip needs to be within 10 mm (0.39 inch) of the tablet surface. The pen tip does not need to touch the tablet in order to move the screen cursor or use the side switch.

All Intuos4 tools, including the Intuos4 Mouse, work only over the active area of the tablet.

- In [MOUSE MODE](#), the default setting for the Intuos4 Mouse, you move the cursor with a “pick up and slide” motion similar to using a regular mouse.

CLICKING

Click to highlight or select something on the screen. Double-click to open it.

Clicking. Tap the pen tip once on the tablet, or press the pen tip on the tablet with enough force to register a click. (There is no audible pen tip “click” sound.) Try clicking on a folder icon by moving the screen cursor over the icon and pressing down on the pen tip. The folder should highlight when you press.

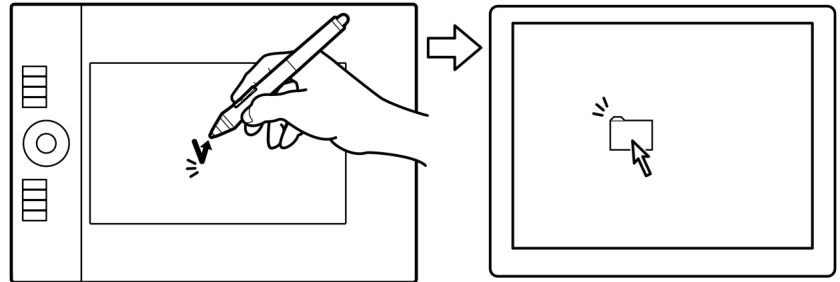

Tip: You can configure Windows to select when the pen is over an icon and to launch the icon with a single click. To turn on this feature, first open a folder.

- **For Windows 7 and Vista,** from the ORGANIZE pull-down menu choose FOLDER AND SEARCH OPTIONS.... From the GENERAL tab select SINGLE-CLICK TO OPEN AN ITEM (POINT TO SELECT).
- **For Windows XP:** From the TOOLS pull-down menu choose FOLDER OPTIONS.... From the GENERAL tab select SINGLE-CLICK TO OPEN AN ITEM (POINT TO SELECT).

Double-clicking. Quickly tap the tablet twice in the same place with the pen tip. This is like clicking twice with a mouse button. Try double-clicking on a folder icon to open it.

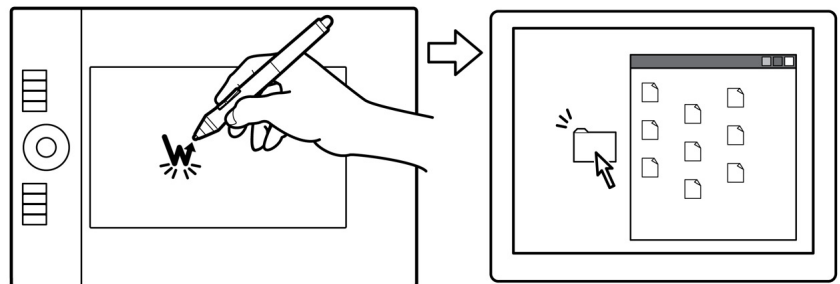

Tip: Press the upper side switch to double-click. This is easier than tapping twice with the pen tip, and is the preferred method of double-clicking with a pen.

DRAGGING

Dragging is used to select and move objects on the monitor screen.

First point to an object. Then press the pen tip to the tablet and slide it across the tablet surface. The selected object will move across the display screen.

To select text within a document, move the screen cursor to the beginning of a text line, then drag the pen across the tablet to highlight the text.

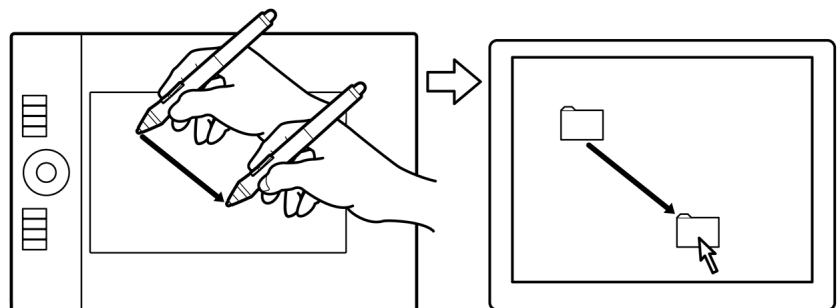

USING THE SIDE SWITCH

The side switch on the Intuos4 Grip Pen has two programmable [functions](#) that can be selected by rocking the switch in either direction. You can use the switch whenever the pen tip is within 10 mm (0.39 inch) of the tablet active area. You do not have to touch the pen tip to the tablet in order to use the switch.

The default switch positions are:

Upper: DOUBLE CLICK

Lower: RIGHT CLICK

Tip: Press the upper side switch to double-click. This is easier than tapping twice with the pen tip.

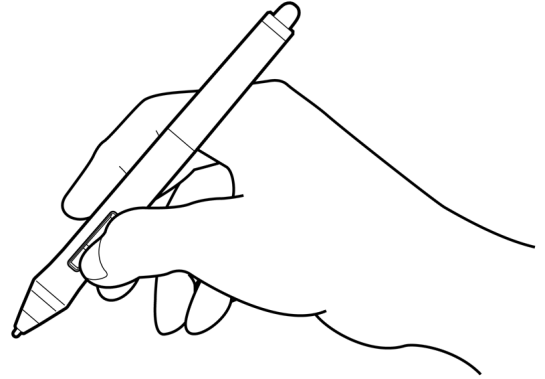

Press the lower pen switch to right-click and bring up application-specific or icon-specific menus.

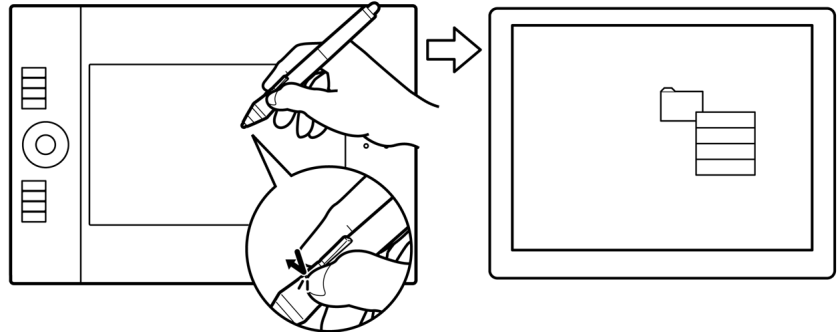

Setting a switch function to PAN/SCROLL lets you position a document or image in any direction within the active window simply by pressing the pen button and moving the pen tip across the tablet's active area. As you move the pen tip, the document or image is repositioned to follow the direction of pen movement on the tablet. Release the pen button or lift the pen tip from the tablet surface when you are done.

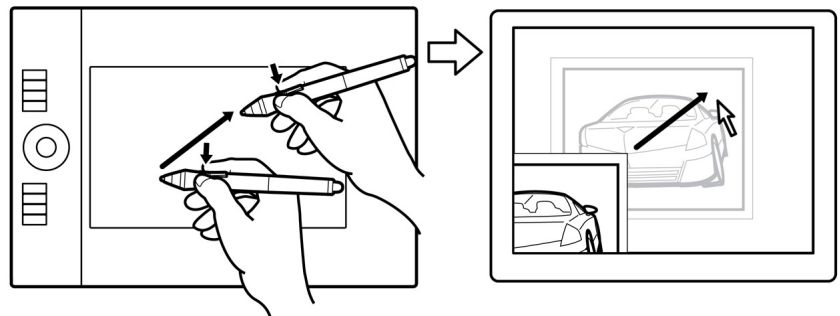

In some application windows the document will precisely follow the screen cursor as you move the pen tip, while in others it will simply move in the same general direction as the screen cursor.

To assign new switch functions, see [customizing tool buttons](#).

DRAWING WITH PRESSURE SENSITIVITY

The pen responds to your hand movements, enabling you to create natural-looking pen and brush strokes. Many graphics applications have drawing tools that respond to the pressure you place on the pen. For example, sliders are used in some applications to vary line characteristics (width, color, and opacity). These characteristics can be controlled much better by the pen's pressure sensitivity. You can vary line width, blend colors, and change opacity with the pressure you exert upon the pen. The [digital ink](#) tools in Microsoft Windows 7, Vista, and Office 2007 or later also respond to the pressure you place on the pen.

To draw, write, or ink with pressure sensitivity, move the pen along the surface of the tablet while applying various amounts of pressure downward on the tip of the pen. Press hard for thick lines or dense color. Press gently for thin lines or softer color. Note that some applications require you first select a pressure-sensitive tool from the application's tool palette.

To adjust the tip feel, see [adjusting tip feel and double-click](#).

Visit our web site for a list of applications that support pressure. See [product information](#).

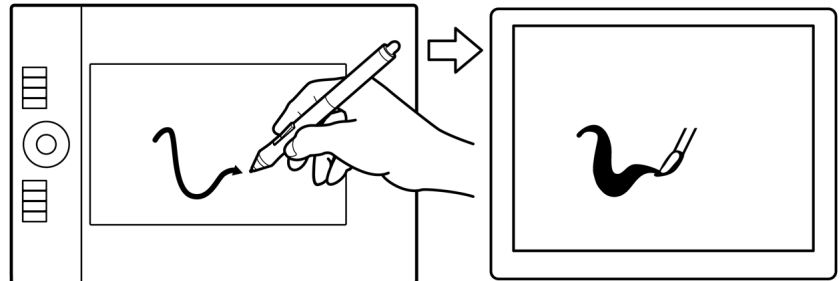

DRAWING WITH TILT

The tablet recognizes when you tilt the pen from vertical to inclined positions. In some drawing applications, tilt can be used to control line shape and thickness. This is like working with an airbrush where tilt can be used to make a line thin when the tool is vertical, or wide when the tool is tilted. In other applications, you can adjust tilt to define brush characteristics such as width, color, and opacity.

To test tilt, draw a curve in a graphics application (such as Corel® Painter™) that supports tilt. Be sure the tilt function in your application is active, then change the tilt of the pen as you draw to vary the shape and thickness of the brush stroke. You can adjust the brush characteristics within your application to create different effects.

To adjust the amount of pen tilt required to produce a desired tilt effect in your application, see [customizing tilt sensitivity](#).

Visit our web site for a list of applications that support tilt. See [product information](#).

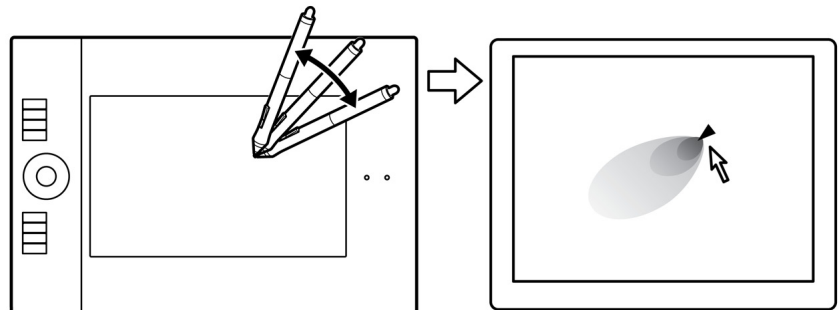

ERASING

The Intuos4 pen eraser works like the eraser on a pencil.

You can erase intuitively and naturally in graphics applications that support the pen eraser. When you use the pen eraser, the application will automatically switch to the eraser tool.

In applications that support pressure sensitivity, you can select pressure-sensitive tools in the application's tool palette to vary the width and depth of your erasures as you change the amount of pressure you exert upon the pen.

See [adjusting eraser feel](#) for more information.

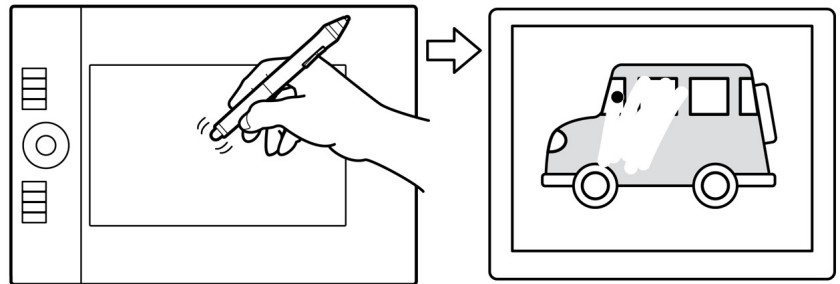

Use the pen eraser in Microsoft Windows 7, Vista, and Office 2007 or later to erase notes or sketches made with [digital ink](#), and to select and delete text or spreadsheet cells within an application.

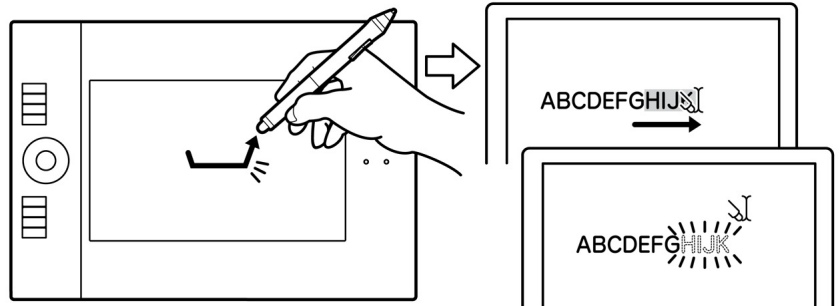

Visit our web site for a list of applications that support the eraser (see [product information](#)). If the eraser is not supported in an application, you can still use the eraser for positioning, drawing, or annotation.

EYE-HAND COORDINATION EXERCISE

This exercise is designed to retrain your eye-hand coordination for using the pen:

1. Open any graphics application. Use the line tool to draw a rectangular grid with line spacings of about 20-25 mm (3/4 to 1 inch). You can use your standard mouse to do this.
2. Choose a free-hand tool in your application and use the pen to draw a dot at each grid intersection.
3. Draw an X at each grid intersection.
4. Clear your screen and make a simple drawing of your own. The more you use your pen, the easier drawing, writing, and navigation will become.

WORKING WITH THE TABLET

The middle section of the tablet is the working, or active, area for the pen or mouse. Wherever you place your pen on the tablet active area, the screen cursor will appear at a corresponding point on the screen. See [using the Grip Pen](#) and [using the Intuos4 Mouse](#) for more information.

[Active area](#)

[ExpressKeys](#)

Press the customizable ExpressKeys to perform frequently used functions or keystrokes, or to emulate button clicks or modifier keys.

[Touch Ring](#)

Slide your finger around the ring to zoom, scroll, or perform other custom actions.

Press the toggle (center) button to toggle between four customizable states. As you toggle between settings, a corresponding status LED illuminates.

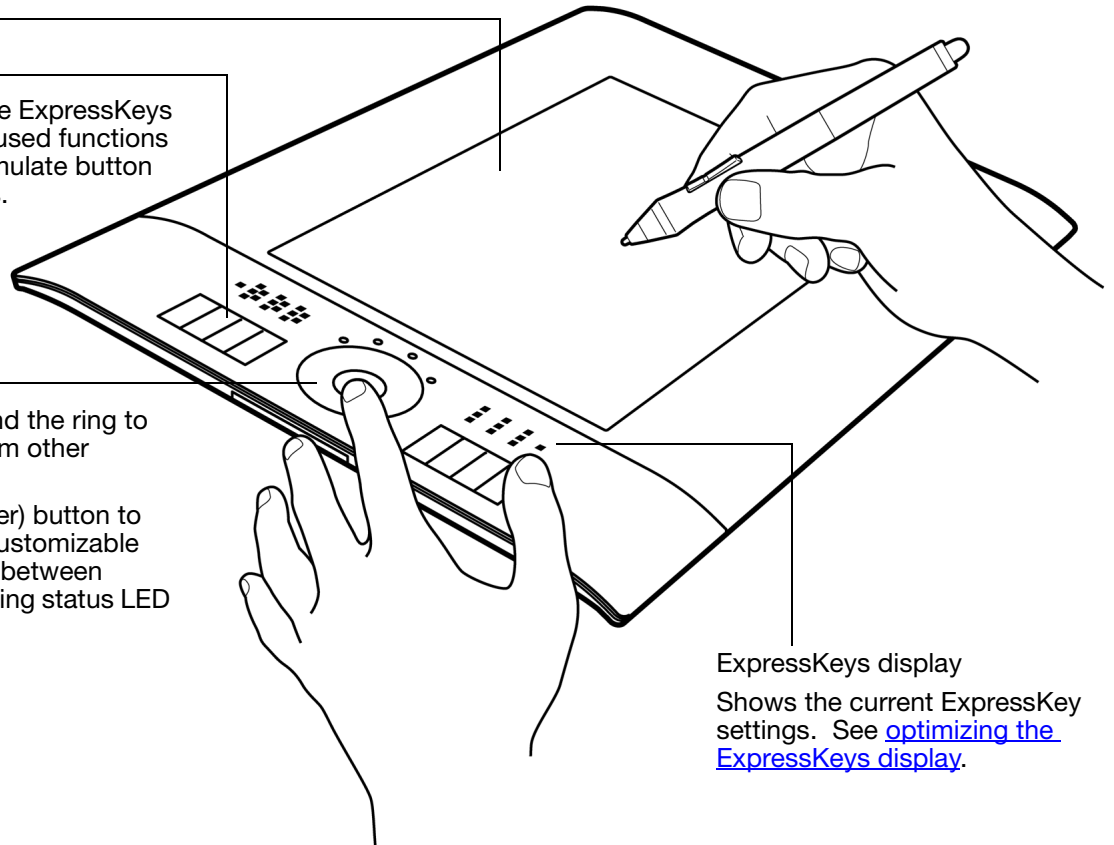

ExpressKeys display
Shows the current ExpressKey settings. See [optimizing the ExpressKeys display](#).

See [battery and power management](#) for detailed information about tablet power management.

USING THE EXPRESSKEYS

Press individual keys to perform frequently used functions or keystrokes. ExpressKeys can also be used to modify your pen or other input tool properties as you work. The ExpressKeys can also be operated in combination with one another. For example, if you program one key to simulate the CTRL key and another to simulate an ALT keystroke, when you press both keys at the same time a CTRL+ALT is simulated.

ExpressKeys configuration when positioned on the left side of the tablet (EXPRESSKEYS LEFT).

ExpressKeys configuration when positioned on the right side of the tablet (EXPRESSKEYS RIGHT).

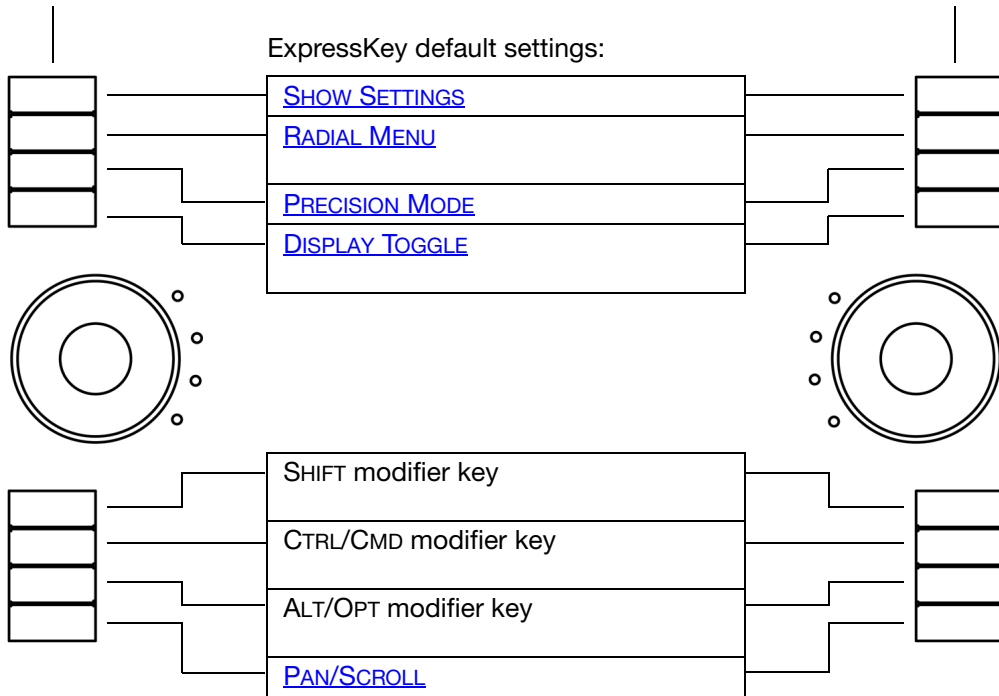

The ExpressKeys display automatically updates to show the current ExpressKey settings for the active application. If an ExpressKey has been disabled, there will be no display for that key.

See [optimizing the ExpressKeys display](#) and [customizing the ExpressKeys](#).

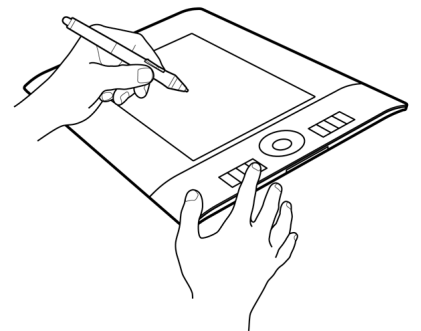
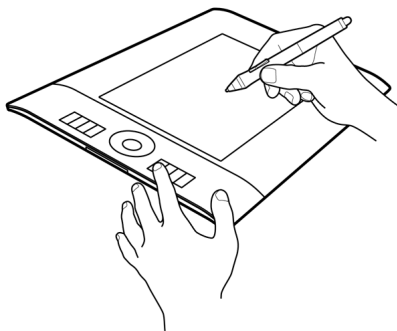

Important: Some applications can override and control the ExpressKey functions. For details, see [using applications integrated for tablet control](#).

Tip: In Adobe Photoshop and many other graphics applications, the ALT, CTRL, and SHIFT keys can be used to modify a tool (or switch to an alternative tool) while the key is pressed.

USING THE TOUCH RING

Slide your finger around the ring to zoom in or out, scroll up or down, or to issue the assigned keystroke functions.

Example of zooming in

Move your finger clockwise along the ring to zoom in or scroll down in most applications.

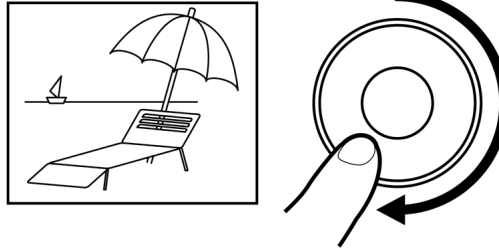

Example of zooming out

Move your finger counter-clockwise along the ring to zoom out or scroll up.

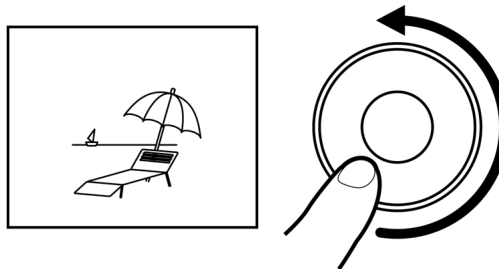

Touch Ring default settings:

Press the toggle button to switch between four customizable states. As you toggle between settings, a corresponding status LED illuminates. Any disabled settings are skipped in the toggle sequence.

To resume operations after the tablet has entered auto sleep mode, press the toggle button.

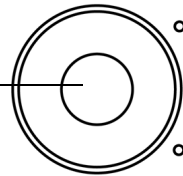

Setting 1: AUTO SCROLL/ZOOM. Sets the ring to zoom in most graphics applications and scroll in most other applications.

Page scrolling is not supported.

Some applications may interpret zoom events as scroll events, or may completely ignore zooming. Likewise, scroll events may be interpreted as zoom events, or ignored completely.

Setting 2: KEYSTROKE... CYCLE LAYERS.

Enables you to cycle up or down through a stack of layers when working in Adobe Photoshop. Move your finger clockwise along the ring to cycle up through layers.

Setting 3: KEYSTROKE... BRUSH SIZE. Sets the ring to increase or decrease the brush size of your drawing tool when working in Adobe Photoshop.

Setting 4: KEYSTROKE... CANVAS ROTATION. Enables you to rotate or flip an entire image when working in Adobe Photoshop. (Requires Adobe Photoshop CS4 or later.)

Important: Some applications can override and control the Touch Ring functions. For details, see [using applications integrated for tablet control](#).

See [customizing the Touch Ring](#) to modify the way your tablet Touch Ring works.



CUSTOMIZING INTUOS4

After you master the basics of using Intuos4, you may want to customize the way the tablet or input tools work. This chapter describes how to adjust your tablet and tool settings. Included is information about each control panel tab and some of the more difficult concepts. Many of the sections also contain useful customizing tips.

Advanced users can learn how to further optimize Intuos4 by creating [application-specific settings](#).

[Opening the control panel](#)

[Control panel overview](#)

[Working with tablet properties](#)

[Customizing the pen](#)

[Customizing the optional mouse](#)

[Customizing the tablet functions](#)

[Tablet to screen mapping](#)

[Button functions](#)

[Using and customizing the Radial Menu](#)

[Working with Display Toggle](#)

[Working with multiple tools](#)

[Application-specific settings](#)

OPENING THE CONTROL PANEL

To open the Wacom Tablet control panel, use the Intuos4 tool you wish to customize on the tablet:

- **Windows.** Click on the Windows START button and choose ALL PROGRAMS. Then select WACOM TABLET and choose the WACOM TABLET PROPERTIES option.
- **Macintosh.** Open SYSTEM PREFERENCES from either the Dock, the Apple menu, or from the APPLICATIONS folder. Then click on the WACOM TABLET icon.

After opening the control panel, you can begin customizing Intuos4.

Note: User-specific preferences are supported. After logging in, each user can customize their personal settings in the Wacom Tablet control panel. Switching to another user will automatically load the settings for that user.



CONTROL PANEL OVERVIEW

Use the Wacom Tablet control panel to customize your Intuos4 tablet or input tools.

The upper portion of the control panel displays icons representing your TABLET, TOOL, and APPLICATION settings.

The screenshot shows the 'Wacom Tablet Properties' window. At the top, there are three sections: 'Tablet' (Intuos4 WL), 'Tool' (Functions, Grip Pen, Mouse), and 'Application' (All). Below these are tabs for 'Pen', 'Eraser', and 'Mapping'. The 'Pen' tab is active, showing sliders for 'Tilt Sensitivity' (Normal to High) and 'Tip Feel' (Soft to Firm), a 'Current Pressure' indicator, and a 'Click' button. To the right of the pen icon are dropdown menus for 'Double Click' and 'Right Click', and a 'Tip Double Click Distance' slider (Off to Large). At the bottom are 'About', 'Options...', and 'Help' buttons. A 'Default' button is also present near the bottom right.

Annotations include:

- Line pointing to the Tablet, Tool, and Application sections: "The upper portion of the control panel displays icons representing your TABLET, TOOL, and APPLICATION settings."
- Line pointing to the Tab headers: "Tabs display customizable settings for the selected TOOL."
- Line pointing to the About button: "Displays tablet and software information, including an option to access the DIAGNOSTICS dialog box."
- Line pointing to the Options... button: "Displays [advanced options](#)."
- Line pointing to the Help button: "Displays help options."
- Line pointing to the Tool selection area: "TOOL settings
Choose FUNCTIONS to customize your ExpressKeys, Touch Ring, and [Radial Menu](#) settings.
Choose GRIP PEN to customize your Intuos4 pen settings.
If you have an optional Intuos4 Mouse, choose MOUSE to customize the mouse settings."
- Line pointing to the Default button: "Returns the selected tab to its default settings."

Experiment with different settings to find what works best for you. Any changes you make will take effect immediately. Click DEFAULT to return a tab to the factory settings.

Tool Tips are available for most control panel items. Position the screen cursor over an item and let it rest there; in a few moments the Tool Tip will pop up.

Your keyboard tab and arrow keys can be used to navigate the control panel.



Control panel lists and tabs: The control panel TABLET, TOOL, and APPLICATION lists allow you to select the tablet, tool, or application for which to change settings.

To change tool settings, open the control panel using the tool you wish to customize. The tool will be automatically selected in the TOOL list, and the appropriate tabs will be displayed. If the tool is not automatically selected, choose it from TOOL list.

To customize settings for a different tool, click on its icon within the TOOL list (the appropriate tabs will be displayed). See [customizing the pen](#), [customizing the optional mouse](#), and [customizing the tablet functions](#) for more information.

The TABLET list displays an icon for any supported tablet that has been installed on your system and is currently connected. All settings shown below this list apply to the selected tablet.

- The control panel will not launch unless a supported tablet is connected to the computer.
- Settings can only be viewed or changed for an attached tablet.
- A tablet cannot be deleted from the control panel list unless it is attached to the computer.

See also [working with tablet properties](#).

The TOOL list displays an icon for the tablet FUNCTIONS, and for the different tools that have been used on the tablet. See also [working with multiple tools](#).

The APPLICATION list lets you define tool settings that apply only to a specific application. See [application-specific settings](#).

See also [installing multiple tablets](#) and [changing the tablet mode options](#).

Note: The APPLICATION list is for advanced users; it is not necessary to select or add applications in order to customize your Intuos4 tool(s).

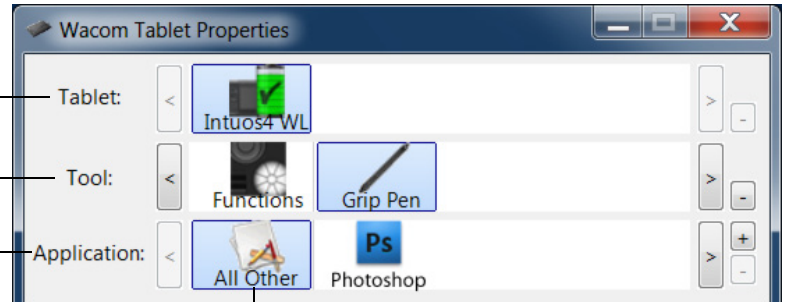

Your current selections are highlighted.

WORKING WITH TABLET PROPERTIES

The Wacom Tablet control panel provides you with direct feedback about the power status of your tablet.

Each icon within the TABLET list shows the percentage of battery charge remaining for the connected tablet.

- A status bar indicates tablet is in use, and shows an approximation of the remaining battery charge.
- A warning symbol within the status bar indicates tablet is in use, and the battery charge is nearly empty.
- A lightning bolt within the status bar (which now resembles a battery) indicates the tablet is running on external power via the USB cable or an external power adapter, and the tablet battery is charging.
- A power plug within the status bar (which resembles a battery) indicates battery is fully charged, and the tablet is running on external power.

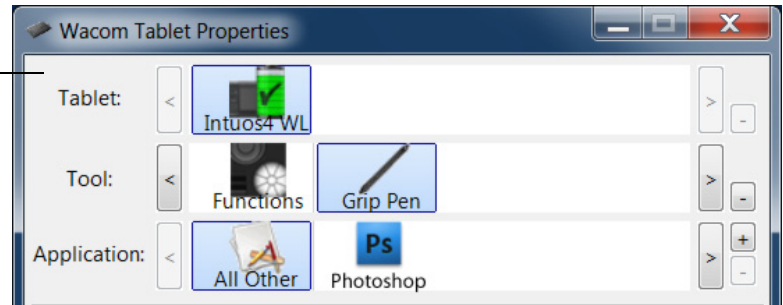

The above points describe only the basic feedback elements of the TABLET icon. You may see variations of these descriptions, depending on the actual status of your tablet and operating system.

A Wacom icon is also displayed in the system task bar (Windows) or menu bar (Macintosh).

- Hover the screen cursor over the icon to learn specific details.
- Click on the icon to access various options for working with your tablet.
- For Windows, the icon is located in the notification area of the task bar.
- For Macintosh, the icon is located on the menu bar.

See also [power saving features](#) and [changing the tablet mode options](#).

CUSTOMIZING THE PEN

Use the pen to open the Wacom Tablet control panel. The pen will be selected in the TOOL list and the appropriate tabs will be displayed. If the pen is not automatically selected, choose it from TOOL list. Select a tab and choose from the available options.

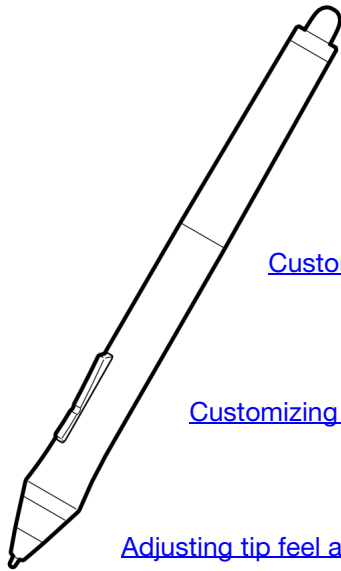

[Adjusting eraser feel](#)

[Customizing tilt sensitivity](#)

[Customizing tool buttons](#)

[Adjusting tip feel and double-click](#)

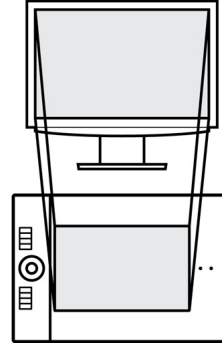

[Tablet to screen mapping](#)



[Application-specific settings](#)

ADJUSTING TIP FEEL AND DOUBLE-CLICK

Select the PEN tab.

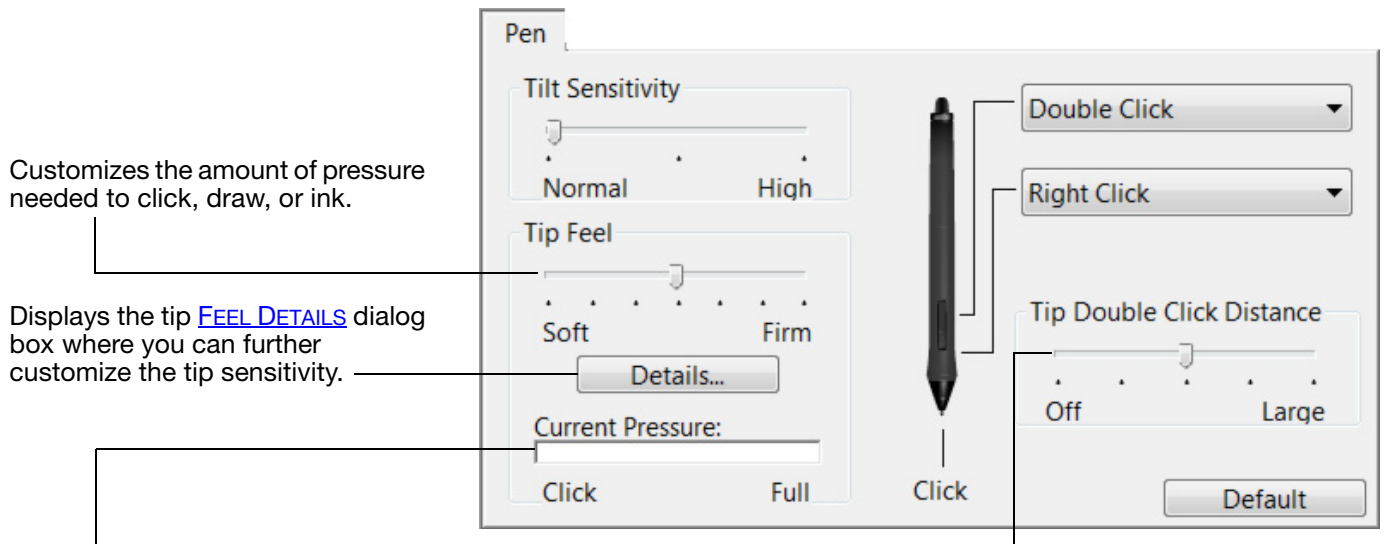

Customizes the amount of pressure needed to click, draw, or ink.

Displays the tip [FEEL DETAILS](#) dialog box where you can further customize the tip sensitivity.

Press the pen tip on the tablet to test the TIP FEEL setting. Adjust the TIP FEEL so that you can comfortably reach full pressure.

Adjusts the size of the double-click area. Drag the slider to OFF to disable [double-click assist](#).

Tips:

Use a soft TIP FEEL to reach the full pressure range with a lighter touch. In some applications a soft pressure setting can make the pen overreact – any small press on the pen is magnified on the screen. If you experience this, try a firmer TIP FEEL setting.

To make double-clicking easier, expand the tap area that accepts a double-click (the double-click distance).

A large double-click distance may cause a delay at the beginning of brush strokes in some drawing applications. This may also cause a delay at the beginning of a drag action or inking stroke. If you notice such effects, try setting a smaller double-click distance or using the side switch to double-click (see [using the side switch](#)). You can also set an ExpressKey to double-click.

ADJUSTING ERASER FEEL

Select the ERASER tab.

Select the [function](#) to perform when using the eraser.

Customizes the amount of pressure needed to erase.

Displays the eraser FEEL DETAILS dialog box where you can further customize the eraser sensitivity.

With your screen cursor positioned over an empty area of your desktop, press the pen's eraser on the tablet to test the ERASER FEEL setting. Adjust the ERASER FEEL so that you can comfortably reach full pressure.

ADVANCED TIP AND ERASER PRESSURE SETTINGS

To further customize tip or eraser pressure settings, from the PEN or ERASER tab click on the DETAILS... button. The options within the FEEL DETAILS dialog box enable you to change the tip or eraser pressure sensitivity and click threshold settings independently.

Important: In the PEN and ERASER tabs, these settings are adjusted simultaneously with the TIP FEEL or ERASER FEEL slider, which override the detailed pressure settings.

Drag the slider to select a pressure sensitivity setting. If you have a soft touch, choose a softer setting.

Drag the slider to adjust the click threshold level. This setting determines the amount of force required to generate a tip click.

Graphically displays the selected pressure SENSITIVITY curve and CLICK THRESHOLD settings.

A curve that increases quickly makes the pen feel more sensitive.

Using your pen tip or eraser, make several strokes within the box to test the results of your changes.

CUSTOMIZING TOOL BUTTONS

Select the PEN tab.

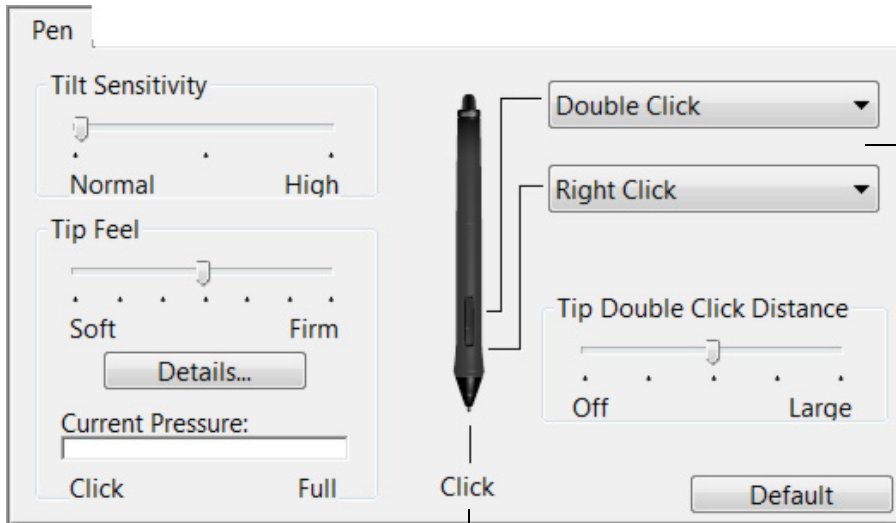

Select the [function](#) to perform when pressing the upper or lower side switch.

When you bring the pen tip within 10 mm (0.39 inch) of the tablet surface without touching the tablet and press the upper or lower side switch, the selected function occurs.

Tip: To make double-clicking easier, set the side switch to double-click automatically by selecting DOUBLE CLICK.

Double-click here to change the function assigned to the pen tip.

- At least one tool button should be set to the CLICK function.
- The tip must be set to CLICK in order to draw in most graphics applications.

Note: You can change how the side switch operates for right clicks or other click functions. See [advanced options](#) for details.

CUSTOMIZING TILT SENSITIVITY

Select the PEN tab.

Tilt sensitivity determines how far you must tilt the tool to produce the maximum tilt effect; you need to tilt the pen less at high sensitivity than at low sensitivity.

Drag the slider to increase or decrease TILT SENSITIVITY. Then test the new setting in an application that supports tilt. The tilt setting applies to both the tip and eraser of your tool.

Note: Tilt is direction-sensitive and can be used in some applications to control brush orientation or other characteristics.

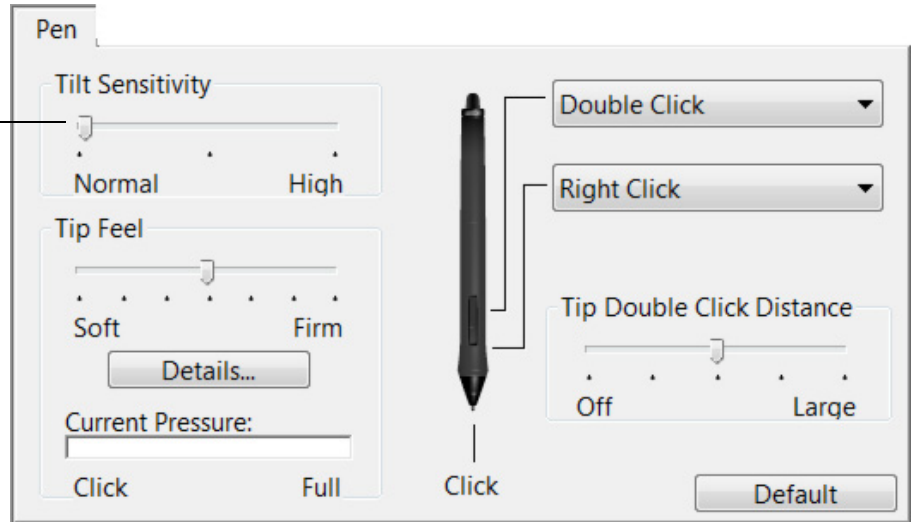

Visit Wacom's web site for a list of applications that currently support tilt. See [product information](#).

CUSTOMIZING THE OPTIONAL MOUSE

Use the Intuos4 Mouse to open the Wacom Tablet control panel. The MOUSE tool will be selected in the TOOL list and the appropriate tabs will be displayed. If the mouse is not automatically selected, choose it from TOOL list. Select a tab and choose from the available options. The mouse is an optional accessory, and product configurations may vary.

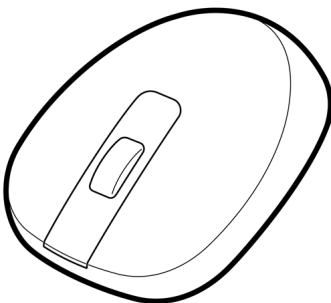

[Customizing the mouse buttons](#)

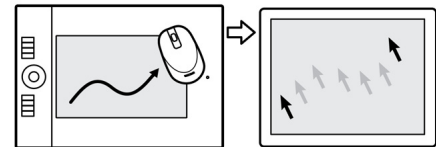

[Mouse mode settings](#)

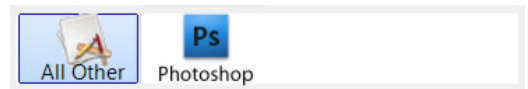

[Application-specific settings](#)

CUSTOMIZING THE MOUSE BUTTONS

Use your Intuos4 Mouse to open the Wacom Tablet control panel. Select the MOUSE tab.

Select the [function](#) to perform when pressing a button.

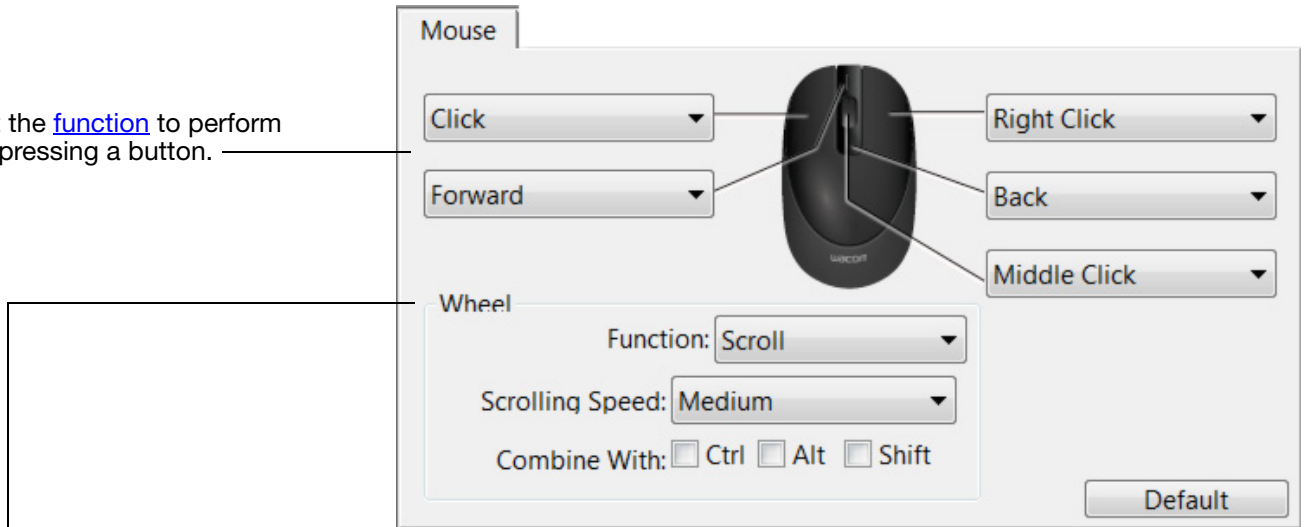

WHEEL options (SCROLL, KEYSTROKE, or DISABLED) control the fingerwheel function. The default setting is SCROLL.

SCROLL When selecting SCROLL, the tab displays custom scroll options. Choose a SCROLLING SPEED to use for each notch of wheel movement.

When you select one or more COMBINE WITH: modifier key options, the selected option(s) will be sent to the application along with each scroll event. For example, you can create custom zooming or other actions within an application.

Macintosh: The available options are OPTION, COMMAND (Apple key), CONTROL, and SHIFT.

KEYSTROKE Select the [KEYSTROKE](#) option to assign custom functions to the fingerwheel. This is useful when working with repetitive functions. Keystroke(s) that you define are sent once for each notch of wheel movement.

Tip: To double the speed of a keystroke action, enter the keystroke sequence twice within the DEFINE KEYSTROKE dialog box.

DISABLED Disables the wheel function.

The mouse buttons are chordable; you can press two or more buttons simultaneously. For example, if you program one button to simulate the CTRL key and another to simulate an ALT keystroke, when you press both buttons a CTRL+ALT is simulated.

Note: To configure the Intuos4 Mouse for left-handed use, simply reassign the button functions as needed. You can also open the Wacom Tablet control panel, click on OPTIONS... and select LEFT in the MOUSE HANDEDNESS group.

CUSTOMIZING THE TABLET FUNCTIONS

To customize the ExpressKeys, Touch Ring, and other tablet features, open the Wacom Tablet control panel and select the FUNCTIONS icon in the TOOL list. Select a tab to customize, and change settings using the available options.



[Customizing the ExpressKeys](#)

[Customizing the Touch Ring](#)

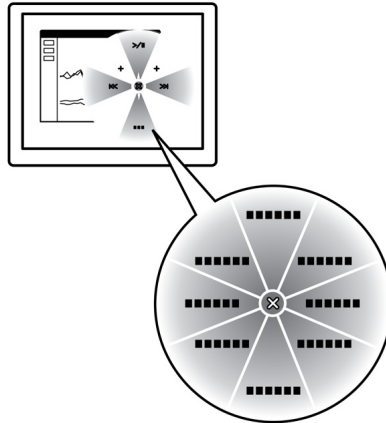
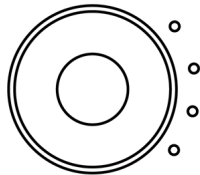

[Using and customizing the Radial Menu](#)



[Application-specific settings](#)

CUSTOMIZING THE EXPRESSKEYS

When you open the EXPRESSKEYS tab, the current functions are shown in the corresponding pull-down menus. As an additional reference, the tablet ExpressKeys display provides a visual indication of the ExpressKey settings.

When using Intuos4, the ExpressKeys display automatically updates to show the key settings for the application that is currently in the foreground. If an ExpressKey has been disabled, there will be no display for that key.

Note: To set the brightness of the Touch Ring status LEDs and ExpressKeys display, select the OPTIONS... button located at the bottom of the control panel. In the OPTIONS dialog box adjust the EXPRESSKEY DISPLAY BRIGHTNESS slider as needed.

Use the pull-down menus to choose a [function](#) that will be performed when the key is pressed. Your choice is displayed either within the pull-down menu or beneath the menu.

The default settings are described in [using the ExpressKeys](#).

ExpressKey functions can be defined for use with [specific applications](#).

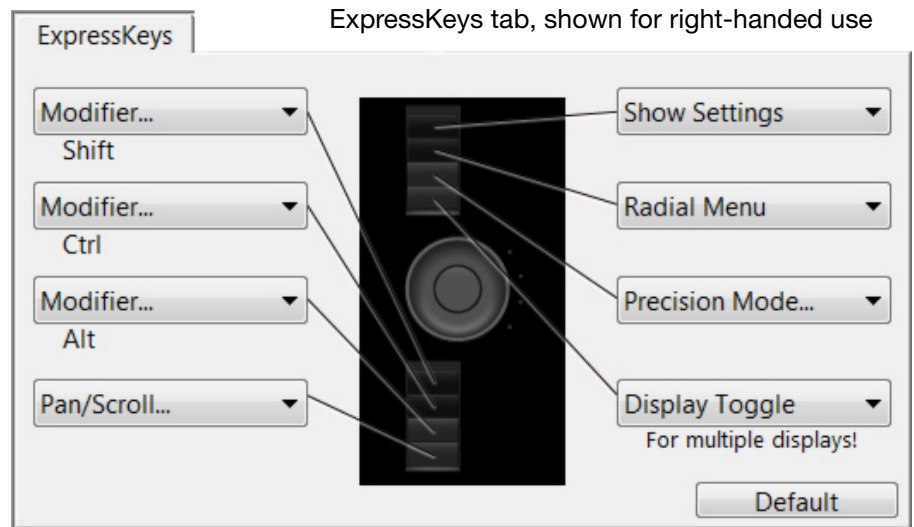

The ExpressKeys will be rotated 180 degrees when the tablet [orientation](#) is set to EXPRESSKEYS RIGHT.

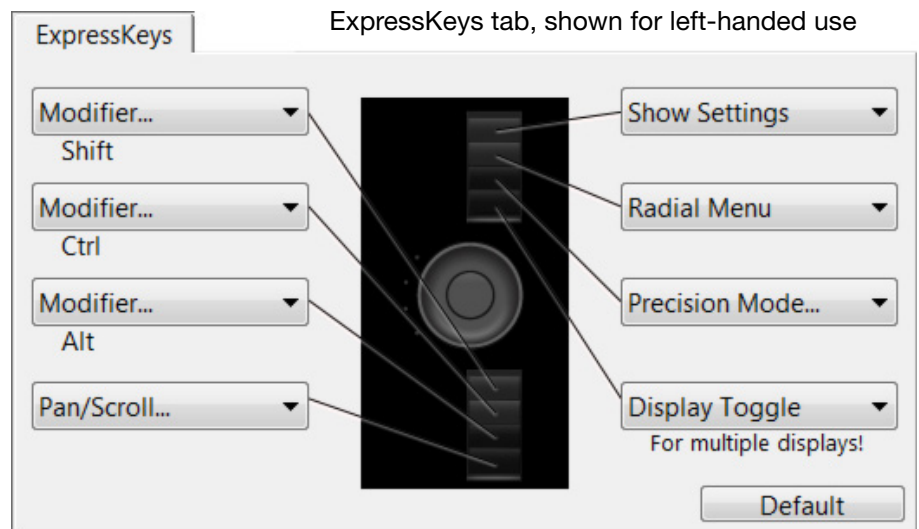

Important: Some applications can override and control the ExpressKey functions. For details, see [using applications integrated for tablet control](#).

CUSTOMIZING THE TOUCH RING

When you select the tablet TOUCH RING tab, the currently set Touch Ring functions are displayed. You can customize the Touch Ring to issue zooming, scrolling, or custom keystroke actions.

Touch Ring functions can be defined for use with specific applications. Any changes you make on this tab apply to the currently selected icon in the control panel's APPLICATION list.

The below control panel tab depicts a tablet configured for right-handed (EXPRESSKEYS LEFT) use.

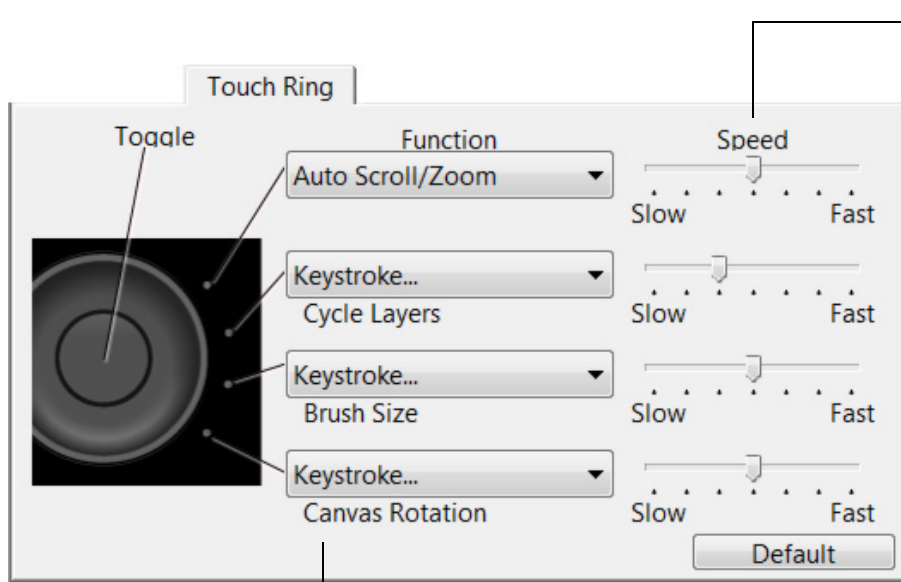

The SPEED setting can be customized for each function. This controls the rate at which zooming and scrolling occurs, or the speed at which keystroke events are sent to an application.

Tip: To zoom images around the current position of the screen cursor when working in Adobe Photoshop CS3 or later, open the Adobe Photoshop general preferences pane, check the ZOOM WITH SCROLL WHEEL option, and click OK.

Choose a function to perform when the ring is in use. Default settings are:

AUTO SCROLL/ZOOM	Sets the Touch Ring to zoom in most graphics applications and scroll in most other applications. Page scrolling is not supported. Move your finger clockwise along the ring to zoom in or scroll down. Move your finger counter-clockwise to zoom out or scroll up. Some applications may interpret zoom events as scroll events, or may completely ignore zooming. Likewise, scroll events may be interpreted as zoom events, or ignored completely.
KEYSTROKE... CYCLE LAYERS	Sets the ring to cycle up or down through a stack of layers.
KEYSTROKE... BRUSH SIZE	Sets the ring to increase or decrease the brush size of your drawing tool.
KEYSTROKE... CANVAS ROTATION	Enables you to rotate or flip an entire image in Adobe Photoshop CS4 or later.

To customize the ring for other actions, select the KEYSTROKE... option. You can then define a custom [keystroke](#) function. To learn which keystroke shortcuts are supported by a particular application, see the documentation that came with the application.

Choose SKIP to set the Touch Ring toggle button to skip a function state in the toggle sequence.

See [using the Touch Ring](#) for more information.

Important: Some applications can override and control the Touch Ring functions. For details, see [using applications integrated for tablet control](#).

TABLET TO SCREEN MAPPING

Select the **MAPPING** tab to define the relationship between tool movement on the tablet surface and cursor movement on the monitor screen.

By default the entire active area of the tablet maps to the entire monitor. If more than one monitor is in use the tablet will map to all monitors. See [working with multiple monitors](#).

MODE options control how the screen cursor moves. Select [PEN MODE](#) to set the cursor so that its movement corresponds with the position of your Intuos4 tool on the tablet. Wherever you place your tool on the tablet, the cursor will appear at a corresponding point on the screen. This is known as absolute positing and is the default setting for the pen.

The screenshot shows the 'Mapping' settings window. On the left, a diagram illustrates the mapping between a tablet and a monitor. On the right, the settings are as follows:

- Orientation:** ExpressKeys Left (dropdown menu)
- Mode:** Pen (selected radio button), Mouse (radio button)
- Screen Area:** Full (dropdown menu)
- Force Proportions:** unchecked checkbox
- Tablet Area:** Full (dropdown menu)
- Default:** button

Callouts provide the following explanations:

- Orientation:** Select the [ORIENTATION](#) of your tablet. This setting is tablet specific, and applies to all tools and applications. Other **MAPPING** tab settings can be customized for a specific tool and application.
- Screen Area:** Select a monitor [SCREEN AREA](#) for tablet to screen mapping.
- Force Proportions:** When [FORCE PROPORTIONS](#) is checked, forces a proportional tablet to screen mapping relationship.
- Tablet Area:** Select a [TABLET AREA](#) for tablet to screen mapping.

The tablet-to-screen image dynamically updates to illustrate the selected mapping relationship.



When MOUSE MODE is selected, you can decide how you would like the mouse to track. (MOUSE TRACKING options apply only to the Intuos4 Mouse.)

- When USE TABLET ORIENTATION is selected, moving the mouse toward the top of the tablet moves the screen cursor up. In this mode the entire active area of the tablet is available for mouse tracking.
- When USE MOUSE ORIENTATION is selected, moving the mouse forward moves the screen cursor up. In this mode a reduced inset portion of the active area is available for mouse tracking. This is the default setting for all Intuos4 tablets.

Select [MOUSE MODE](#) to move the screen cursor with a “pick up and slide” motion similar to using a traditional mouse.

The screenshot shows the 'Mapping' control panel with the following settings:

- Mouse Tracking:**
 - Use Tablet Orientation
 - Use Mouse Orientation
- Orientation:** ExpressKeys Left (dropdown menu)
- Mode:**
 - Pen
 - Mouse
- Mouse Acceleration:** A slider set between 'Off' and 'High'.
- Mouse Speed:** A slider set between 'Slow' and 'Fast'.
- Default:** A button at the bottom right.

Annotations with lines pointing to the interface:

- A line from the top-left text points to the 'Use Mouse Orientation' radio button.
- A line from the text 'Sets the screen cursor acceleration.' points to the 'Mouse Acceleration' slider.
- A line from the text 'Select a slower or faster screen cursor tracking speed.' points to the 'Mouse Speed' slider.
- A line from the top-right text points to the 'Mouse' radio button in the 'Mode' section.

Notes:

You can switch between PEN MODE and MOUSE MODE by using the screen [Radial Menu](#).

If you frequently switch between PEN MODE and MOUSE MODE, you also can assign the MODE TOGGLE... function to one of your tool buttons.



ORIENTATION

From the MAPPING tab, you can choose a different tablet ORIENTATION and then physically rotate your tablet to match the selection you have made. This feature allows you to set up the tablet controls for left- or right-handed use, or to configure your tablet to work with a tall monitor. See [configuring the tablet orientation](#).

EXPRESSKEYS LEFT	Tablet orientation is horizontal, with Touch Ring and ExpressKeys located to the left. This is the orientation for right-handed users.
EXPRESSKEYS TOP	Tablet is rotated 90 degrees clockwise, with Touch Ring and ExpressKeys oriented toward the top.
EXPRESSKEYS RIGHT	Tablet orientation is horizontal, with Touch Ring and ExpressKeys located to the right. When this option is selected, the tablet operation and the Wacom Tablet control panel options are automatically configured for correct left-handed use. If you have an Intuos4 Mouse, click the control panel OPTIONS button to set the device for right- or left-handed use. See advanced options .
EXPRESSKEYS BOTTOM	Tablet is rotated 90 degrees counter-clockwise, with Touch Ring and ExpressKeys oriented toward the bottom.

After making changes, verify you have correctly set the orientation by moving your pen “up” on the tablet – the screen cursor should move up as well. The selected orientation is a global tablet setting and applies to all applications.

Note: At the log-in and user switching screens, the tablet orientation will use the default orientation that was selected when the driver was installed. If you want to change the default orientation, you must reinstall the driver using the Intuos installation CD. See [configuring the tablet orientation](#).



SCREEN AREA

Use the MAPPING tab SCREEN AREA options to define the portion of the display screen to which your tablet will map.

FULL	Maps the entire monitor(s) area. This is the default setting. See also working with multiple monitors .
MONITOR	Maps the entire area of a single monitor that you choose. If more than one monitor is connected to your system, an option will be available for each detected monitor.
PORTION...	Selecting PORTION... brings up the PORTION OF SCREEN dialog box.

Choose a method for defining a portion of the display:

- Drag corners of the foreground graphic to select the screen area.
- Select the CLICK TO DEFINE SCREEN AREA button and move the screen cursor to select the screen area. Be sure to follow any MESSAGE prompts.
- Enter coordinate values.

After defining a portion of the screen, you may need to use a different input device to access other portions of the screen area.

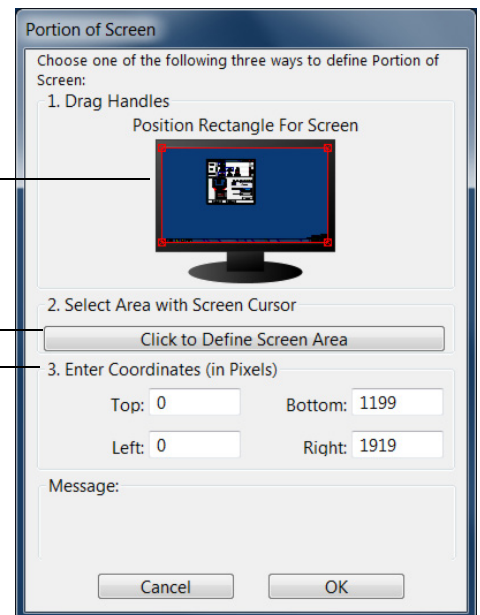

FORCE PROPORTIONS

In the MAPPING tab, check or uncheck the FORCE PROPORTIONS box to determine the tablet to screen mapping relationship.

When FORCE PROPORTIONS is unchecked, the correct scale or proportions are not maintained. The selected tablet area is mapped to the selected display area. Drawing a circle on the tablet may create an ellipse on the display screen. This is the default setting for all tools.

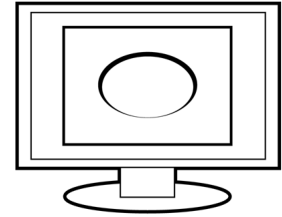

When FORCE PROPORTIONS is checked, the correct vertical and horizontal proportions are maintained. Drawing a circle on the tablet results in a circle on the display screen. Depending on your settings, some portions of the tablet active area may no longer be usable when this option is selected.

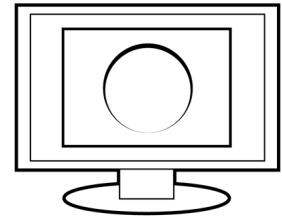

Note: Although Intuos4 is optimized for use with 16 : 10 aspect ratio displays, the default settings automatically adjust for use with other aspect ratio displays.

TABLET AREA

In the MAPPING tab, use the TABLET AREA options to define the tablet area that will be mapped to the screen area:

FULL	The entire active area of the tablet is mapped. This is the default setting.
PORTION...	Selecting PORTION... brings up the PORTION OF TABLET dialog box.

Choose a method for defining a portion of the tablet:

- Drag corners of the foreground graphic to select the tablet area that will be mapped to your selected screen area.
- Select the CLICK TO DEFINE TABLET AREA button and use your tool on the tablet to select the tablet area. Be sure to follow any MESSAGE prompts.
- Enter coordinate values.

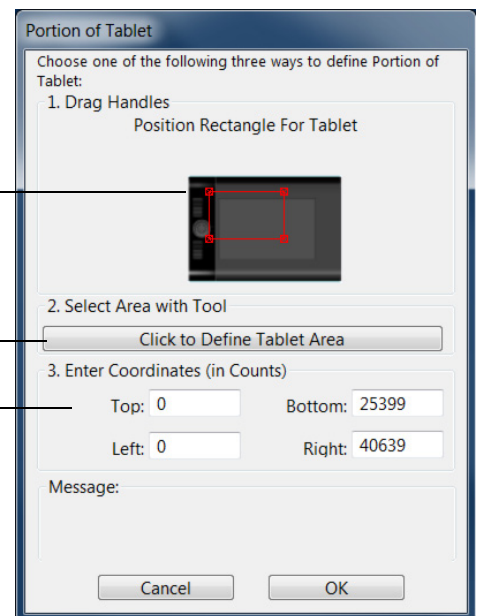

BUTTON FUNCTIONS

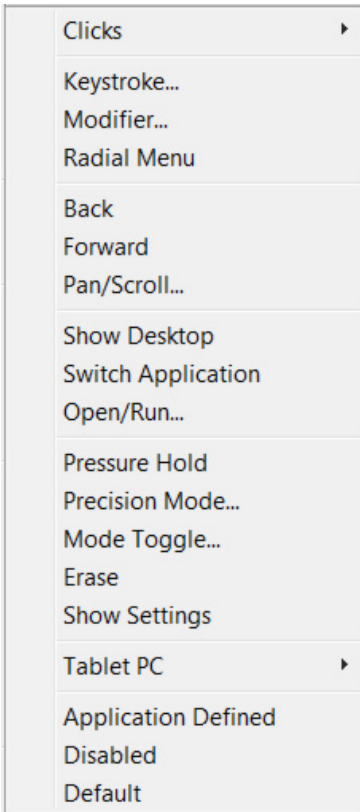

The following options are available for tool and tablet settings. Not all options are available for all controls.

FUNCTION NAME

DESCRIPTION

CLICKS

- CLICK Simulates a primary mouse button click. Be sure at least one button performs this function so you can always navigate and click.
- RIGHT CLICK Simulates a right mouse button click, which displays a context menu.
- MIDDLE CLICK Simulates a middle mouse button click.
- DOUBLE CLICK Simulates a double-click. For easier double-clicking, use this function instead of tapping twice with the pen tip.
- CLICK LOCK Simulates holding down the primary mouse button. Press the tool button once to initiate click lock. Press the button again to release click lock. Click lock is useful for dragging objects or selecting blocks of text.
- 4TH CLICK Simulates a 4th mouse button click.
- 5TH CLICK Simulates a 5th mouse button click.



FUNCTION NAME

DESCRIPTION

KEYSTROKE...

Enables you to simulate keystrokes. Select this option to display the DEFINE KEYSTROKE dialog box.

Enter a keystroke or keystroke combination in the KEYS entry box. Keystroke combinations can include letters, numbers, function keys (such as F3) and modifier keys (such as SHIFT, ALT, or CTRL for Windows, or SHIFT, OPTION, COMMAND, and CONTROL for Macintosh).

You can also select special keystrokes or keystroke combinations from the ADD SPECIAL drop-down menu.

After defining a keystroke sequence, click OK.

Important: Because the ENTER (Windows) and RETURN (Macintosh) keys can be selected as a defined keystroke, they cannot be used to select OK. You must use your Intuos4 tool to click on the OK button.

If prompted, enter a name for the keystroke definition. The name will be displayed with the respective control or in the Radial Menu, as applicable.

You can create different keystroke functions for different applications. See [application-specific settings](#).

Deletes only the last entry in the keystroke entry box.

Clears the keystroke entry box.

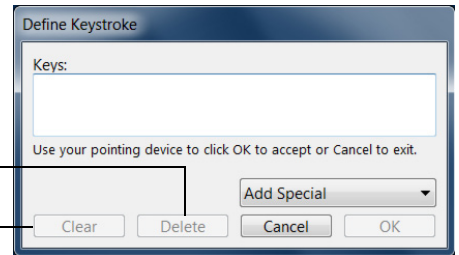

When defining keystrokes for the Touch Ring or mouse fingerwheel, the dialog box provides two KEYS entry boxes.

Assign keystroke functions as described above for clockwise and counter-clockwise movement on the ring, or front and back movement of the mouse fingerwheel.

Enter a NAME for the defined keystrokes pair and click OK.

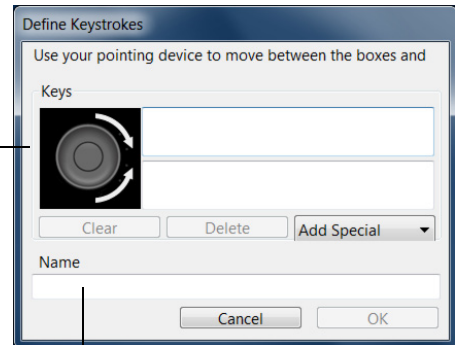

To learn which keystroke shortcuts are supported by a particular application, see the documentation that came with the application.



FUNCTION NAME	DESCRIPTION
---------------	-------------

MODIFIER..

Enables you to simulate modifier key(s) (such as SHIFT, ALT, or CTRL for Windows, or SHIFT, OPTION, COMMAND, and CONTROL for Macintosh). Many applications use modifier keys to constrain the size or placement of objects.

Choose one or more modifier key options. Select the CLICK box if you want a mouse click to occur whenever you press the tool button.

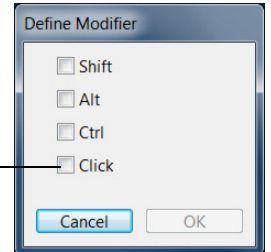

RADIAL MENU

Displays a [Radial Menu](#) on your screen. Each level of the hierarchical menu consists of eight menu slices which may contain various features and options to choose from.

BACK

Simulates the BACK command in browser applications.

FORWARD

Simulates the FORWARD command in browser applications.

PAN/SCROLL

Enables you to position a document or image in any direction within the active pane by pressing a tablet or pen button set for PAN/SCROLL and then dragging with the pen tip across the tablet's active area.

When you select PAN/SCROLL, the PEN SCROLL SPEED dialog box prompts you to set a scrolling speed for use in applications that do not support grabber hand (pixel-level) panning within a document or image.

A slower setting reduces the scroll rate and is useful for close-up and detail work where you need precise control of the image.

As you move the pen tip, the document or image is repositioned to follow the direction of pen movement on the tablet.

Release the button or lift the pen tip from the tablet surface when you are done.

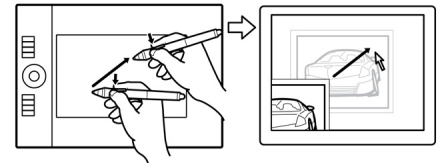
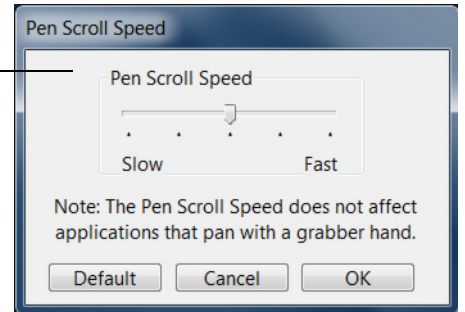

FUNCTION NAME

DESCRIPTION

AUTO SCROLL/ZOOM	Sets the Touch Ring to zoom in most graphics applications and scroll in most other applications.
SCROLL	Sets the Touch Ring for scrolling only action.
ZOOM	Sets the Touch Ring for zooming only action.
SHOW DESKTOP	Minimizes all open windows to display a clean desktop.
SWITCH APPLICATION	Brings up the application switching dialog with focus on the next open application. On Windows 7 and Vista systems running Aero, Flip 3D will be activated with focus on the next open applications.

OPEN/RUN...

Opens a dialog box where you can select a specific application, file, or script to launch.

Click **BROWSE...** to locate an application, file, or script to launch. The selection you make appears in the **APPLICATION TO RUN** box. Click **OK** to accept the selection.

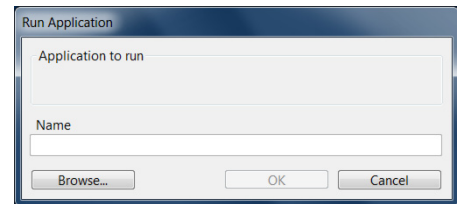

The dialog box will close and the **OPEN/RUN...** option you have selected will be assigned as your tool button option. Simply press the tool button to launch the assigned option.

If your selection is for the Radial Menu, it will be displayed in the Radial Menu.

INK TOGGLE

(Macintosh.) Toggles the “ink in any application” function of Ink on and off. Ink automatically recognizes and converts your handwriting into text and inserts it into a document. Handwriting recognition must be turned on for this function to work. See your Macintosh help for information on working with Ink.

EXPOSÉ

(Macintosh.) Tiles all open windows. To access this option, first choose **KEYSTROKE...** and then click on the **ADD SPECIAL** menu within the dialog box.

PRESSURE HOLD

Locks the pressure at the current pressure level until the button is released. For example, you can paint with pressure sensitivity until you reach the brush size that you like. You can then press the button and continue painting with the same size brush until the button is released.

PRECISION MODE

Changes the mapping around the current pen tip position such that you must move the pen twice as far for the screen cursor to cover the same distance on the display screen. To activate, press and hold the tool button to which this function is assigned. Releasing the button returns to normal mapping.

When your tool is in **MOUSE MODE**, screen cursor movement is adjusted to act as if acceleration were off and speed set to slow.

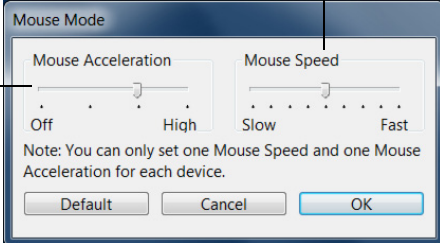

FUNCTION NAME	DESCRIPTION
DISPLAY TOGGLE	For multiple monitor systems. Enables you to toggle the current tablet mapping and screen cursor between different displays when you press an ExpressKey that has been assigned this function. See working with Display Toggle .
MODE TOGGLE...	Toggles between PEN MODE and MOUSE MODE . When first setting a tool button to MODE TOGGLE..., the MOUSE MODE dialog box is displayed where you can adjust the mouse acceleration and speed. Sets the screen cursor tracking speed when in MOUSE MODE. Sets the screen cursor acceleration when in MOUSE MODE.
	
	<p>MOUSE MODE settings can be accessed from a number of different locations within the control panel. However, for each input tool and application that you are customizing, only one MOUSE ACCELERATION and SPEED setting can be made.</p> <p>The MOUSE MODE acceleration and speed settings are independent of system settings. Changes you make to these settings in the Wacom Tablet control panel do not affect similar system settings. However, changes made to similar system settings may affect your Intuos4 tablet settings.</p>
ERASE	Default setting for the eraser. See erasing for information on using the eraser.
SHOW SETTINGS	Displays a diagram (on your display screen) of the tablet ExpressKeys and Touch Ring, showing the current function settings for each control.





FUNCTION NAME	DESCRIPTION
TABLET PC	
<ul style="list-style-type: none"> TABLET PC INPUT PANEL 	(Tablet PCs, and Windows 7 and Vista systems that support the Tablet PC Input Panel.) Opens the Tablet PC Input Panel when you press a tool button set to this function.
<ul style="list-style-type: none"> JOURNAL 	(Windows 7, Vista, and Tablet PC systems that include Microsoft Journal.) Opens Microsoft Journal.
<ul style="list-style-type: none"> TABLET PC DEFINED 	(Tablet PCs, and Windows 7 and Vista systems that support the Tablet PC Input Panel.) Sets the button function according to settings found in the: <ul style="list-style-type: none"> Windows 7 and Vista TABLET PC SETTINGS and PEN AND INPUT DEVICES control panels. Windows XP Tablet Edition TABLET AND PEN SETTINGS control panel.
DISABLED	Disables the control function.
APPLICATION DEFINED	Reports only the button number to the application. This is for applications, such as CAD programs, that have built-in support for the Intuos4 Mouse. This function may also be used by some highly integrated applications for direct control of the pen tablet ExpressKeys and Touch Ring.
SKIP	Sets the Touch Ring toggle button to skip a function state that has been assigned this option in the toggle sequence.
DEFAULT	Returns a control to its default setting.



USING AND CUSTOMIZING THE RADIAL MENU

The Radial Menu is a circular pop-up menu that provides quick access to editing, navigation, media control functions, and more.

- To display the Radial Menu, set a tool button or ExpressKey to the RADIAL MENU function. Whenever you press that button, the Radial Menu is displayed centered at the screen cursor position.
- The hierarchical Radial Menu appears in circular format, extending over the entire desktop. Each level of the menu consists of eight control slices which may contain various features and options to choose from.
- Select an option by clicking on it within the Radial Menu. Some selections may display a submenu where you can then choose from the available options.

Holding down the button that opens the Radial Menu allows you to click on a menu item without closing the Radial Menu.

- The menu closes after you make a selection. To close the Radial Menu without making a selection, click on the 'X' located at the center of the menu or on a control slice that has no function assigned to it. You can also again press the button used to display the menu.

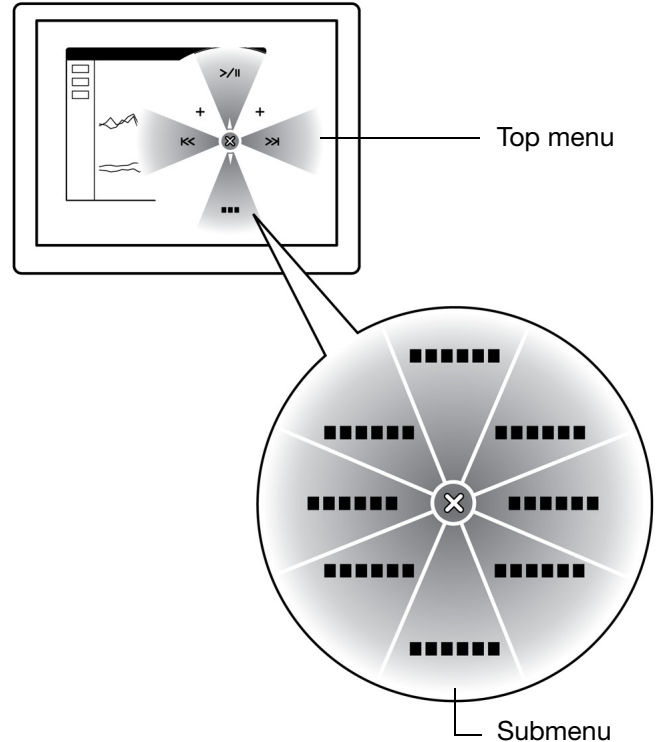

Use the RADIAL MENU tab to customize the available functions on the Radial Menu:

1. Select a menu or submenu to customize.

2. Select a control slice for which to customize settings.

3. Choose the FUNCTION(S) to perform.

Note: Press the ENTER (RETURN) key to add multiple lines of text.

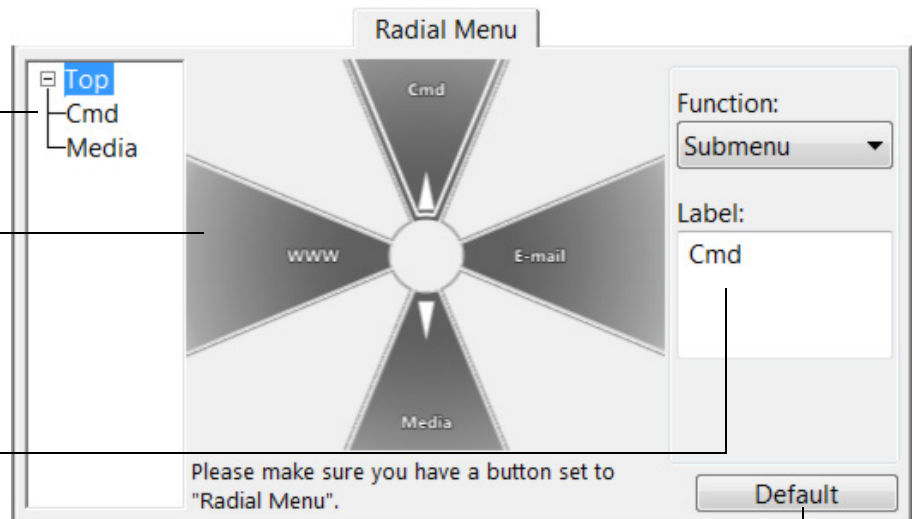

Returns the currently displayed Radial Menu layout to its default values.

WORKING WITH DISPLAY TOGGLE

DISPLAY TOGGLE is available only on multiple monitor systems. This feature allows you to work with your tablet on all displays or on one display at a time. (See [working with multiple monitors](#).)

After setting an ExpressKey to DISPLAY TOGGLE, you can then press that button to sequentially toggle the current tablet mapping between a base mapping (the current setting from the MAPPING tab) and other monitors. For example:

1. The entire display area of a multi-monitor system is set up for extended mode and assigned to the active area of the Intuos4 tablet.

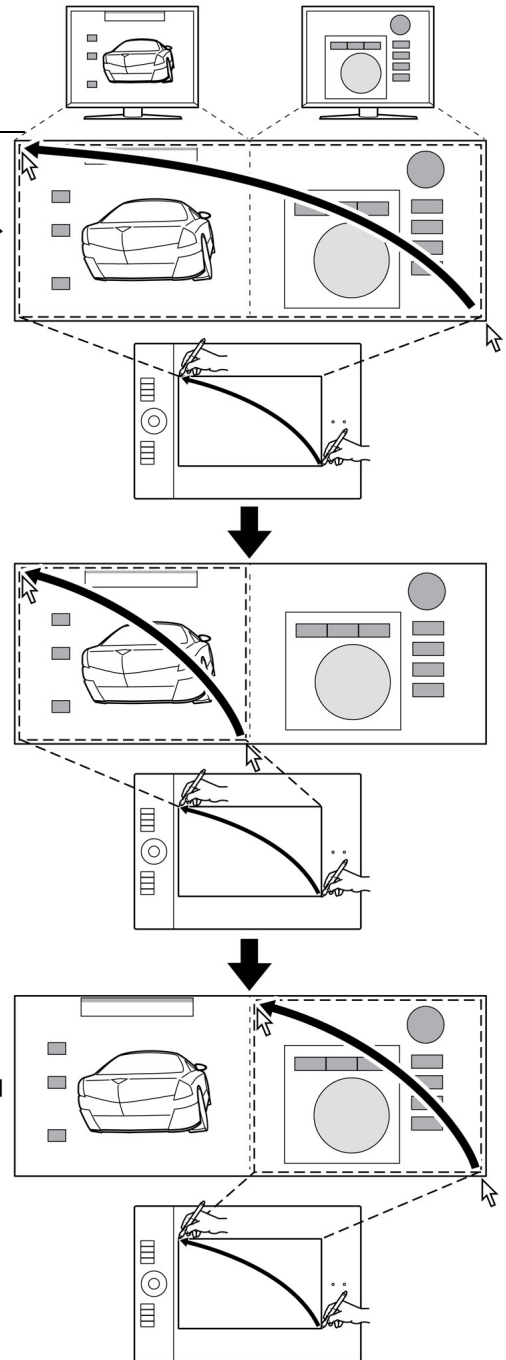

2. Pressing a tool button to which the DISPLAY TOGGLE function has been assigned toggles the tablet mapping to the next display in sequence



In the Wacom Tablet control panel, the DISPLAY TOGGLE tab is automatically available when the Intuos4 tablet is installed on a multi-monitor system. This tab lets you set which monitor(s) will be included in the toggle sequence.

On the DISPLAY TOGGLE tab all monitors are selected in the toggle sequence by default. Uncheck any monitor you want removed from the toggle sequence.

- The base mapping is the tablet and display mapping that is defined in the MAPPING tab. By default, this would include all monitors unless you have defined a specific monitor as your primary monitor in the MAPPING tab.
- As you toggle to the next monitor, each tool's active tablet area is mapped to that monitor (in PEN MODE).
- Toggling one more time after the last checked monitor returns the system to the base mapping.

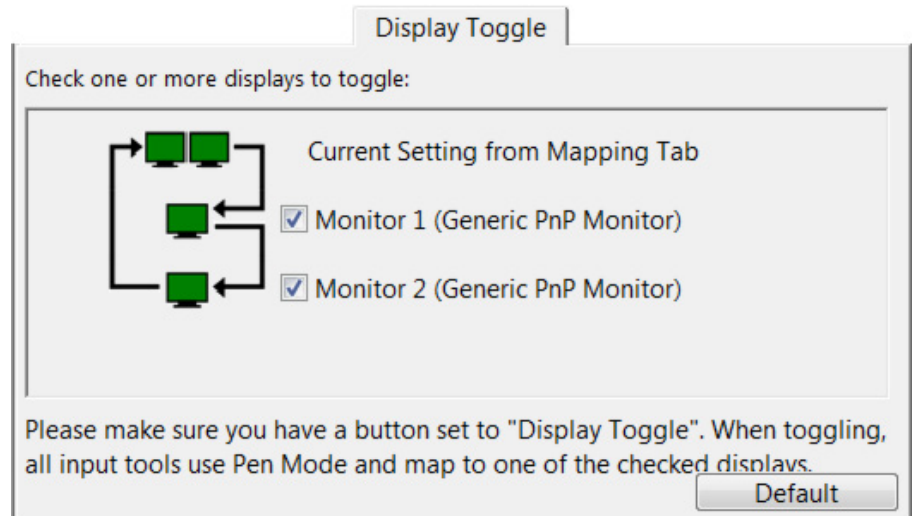

Important: When using application-specific settings with DISPLAY TOGGLE, be sure that each customized application in the APPLICATION list (including ALL OTHER) has a tool button assigned to DISPLAY TOGGLE. The easiest way to do this is to assign DISPLAY TOGGLE to an ExpressKey prior to creating any application-specific settings.

Note that any of the following actions will return the toggle sequence to the base mapping:

- Launching a graphics application that supports pressure sensitivity.
- Logging out of or rebooting the system.
- Switching users (Fast User Switching).
- Placing the system in sleep mode.
- Changing the MAPPING or DISPLAY TOGGLE tab settings.
- Changing the resolution or number of displays on your system.
- Using the MODE TOGGLE... function.
- Selecting PEN MODE or MOUSE MODE from the [Radial Menu](#).

Tip: To toggle between monitors without including the 'full display' option, disable the first display on the DISPLAY TOGGLE tab. Then go to the MAPPING tab and set the current SCREEN AREA to the first display.

WORKING WITH MULTIPLE TOOLS

The Wacom Tablet control panel is designed to help you customize and keep track of the settings for your [Intuos4 tools](#). The tool you use to open the control panel is automatically selected, and the appropriate tabs for that tool are displayed.

The screenshot shows the 'Wacom Tablet Properties' dialog box. It has three main sections: 'Tablet', 'Tool', and 'Application'. The 'Tablet' section shows 'Intuos4 WL' selected. The 'Tool' section shows 'Functions', 'Grip Pen', and 'Mouse'. The 'Application' section shows 'All'. At the bottom, there are tabs for 'Pen', 'Eraser', and 'Mapping'. Annotations with arrows point to various elements: 'Select a tool to change its settings.' points to the 'Grip Pen' icon; 'The TOOL list displays an icon for the tablet FUNCTIONS and the different tools that have been used on the tablet.' points to the 'Functions' icon; 'If application-specific settings have not been added, the ALL icon is displayed and the tool settings apply to all applications.' points to the 'All' icon; 'Removes the selected tool.' points to the minus button; 'The button is inactive when there is only one item in the list.' points to the plus button; 'The FUNCTIONS icon cannot be deleted.' points to the minus button next to 'Functions'; and 'Tab settings apply only to the selected tool and application.' points to the 'Pen' tab.

To add a different tool to the control panel's TOOL list, simply use the tool on your Intuos4 tablet.

- When you select a tool that has been added to the TOOL list, the appropriate tab settings for that tool are displayed. Any changes you make to the tab settings will then apply to that tool. Your changes take effect immediately.
- Identical tools will use the same settings.

To remove a selected tool from the TOOL list, click on the TOOL list's [-] button. In the dialog box that appears, click DELETE to confirm your selection. The selected tool is removed from the list, along with any custom settings you may have created for it. (A removed tool can be added back to the TOOL list by placing it back onto the tablet.)

All Intuos4 pens have a unique Tool ID. In supporting applications, such as Corel Painter, you can assign different tools to different pens and then change between them by switching the pen in your hand.

APPLICATION-SPECIFIC SETTINGS

You can customize your Intuos4 tools for use with a particular application. For example, you may prefer a firm pen tip pressure setting in one application and a soft pressure setting in another. The APPLICATION list enables you to add an individual application to the list and then customize your tool settings for that application.

- When no application-specific settings have been created and a tool is selected from the TOOL list, the APPLICATION list displays the ALL icon which contains tool settings that apply to all of your applications. In the example below, no application-specific settings have been added for the GRIP PEN. The ALL icon is displayed and the GRIP PEN will have the same settings in all applications.

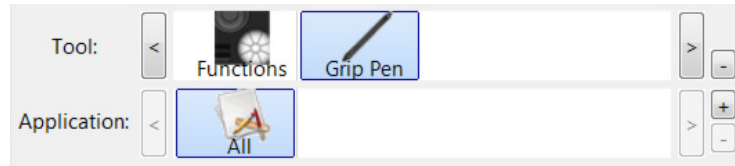

- When application-specific settings are added to the APPLICATION list, the ALL icon changes to ALL OTHER, and an application icon is displayed for the newly added application(s).

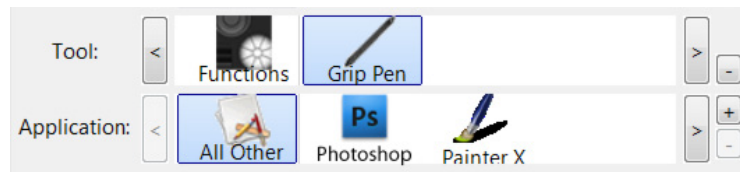

In the above example, application-specific settings have been added for the GRIP PEN. If you select the ALL OTHER icon and make changes to the tab settings, your changes will apply to the GRIP PEN in all applications except those which you have added to the APPLICATION list. If you select an application icon and make changes to the tab settings, your changes will apply to the GRIP PEN only while you are using that application.

When you create application-specific settings, you are creating a separate group of settings for the selected tool and application. See the following sections for more details:

[Creating an application-specific setting](#)

[Changing application-specific settings](#)

[Removing application-specific settings](#)

Tip: To review the ExpressKeys or Touch Ring function settings for the current front-most application, set an ExpressKey to SHOW SETTINGS and press the key at any time.



CREATING AN APPLICATION-SPECIFIC SETTING

First choose the tablet and tool for which you want to create an application-specific setting. Then click on the APPLICATION list's [+] button to display the ADD APPLICATION FOR CUSTOM SETTINGS dialog box.

Choose from one of two methods to select an application:

- Open the application for which you want to create custom settings, and then select that application from the CURRENTLY OPEN APPLICATIONS box.
- BROWSE to select the executable file of any application installed on your computer.

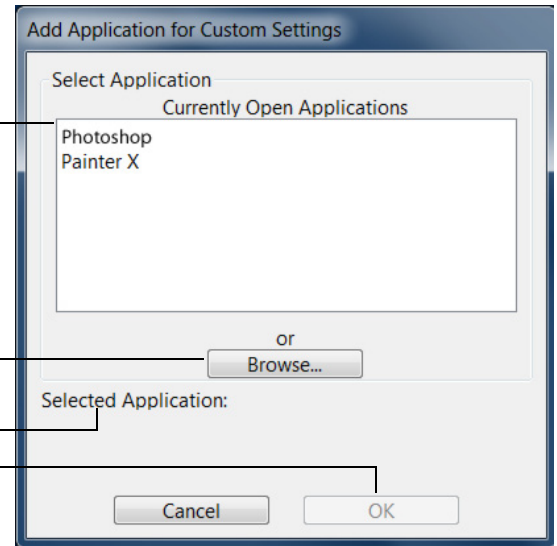

Your selection is added to the SELECTED APPLICATION box where the name of the selected application is displayed.

Click OK to complete the process.

Note: If two programs have the same executable file name, they will share the same customized settings.

After adding an application, its icon appears in the APPLICATION list whenever the respective tool is selected in the TOOL list. Select the application and then customize the control panel tab settings for your tool and the selected application.

Once you have created application-specific settings, applications that have not been customized in this manner will use the tool settings for ALL OTHER.

Tip: First customize settings for one application. When you feel comfortable with the process, you can create more application-specific settings.

CHANGING APPLICATION-SPECIFIC SETTINGS

To change tool settings for a specific application, select the tool and the application and then customize the control panel tab settings.

REMOVING APPLICATION-SPECIFIC SETTINGS

To remove an application-specific setting:

1. In the TOOL list, select the tool from which you want to remove the application-specific setting. Then, in the APPLICATION list select the application you want to remove.
2. Click on the APPLICATION list's [-] button. In the dialog box that appears, click DELETE to confirm your selection. The selected application is removed from the list, along with any custom tool settings that you may have created for it.

Tip: To quickly remove all application-specific settings from a tool, remove the tool from the TOOL list. Then place the tool back on the tablet. The tool will be added back to the TOOL list using the default settings.





TROUBLESHOOTING

Most of the time your tablet will work flawlessly. But if you are having trouble, Wacom recommends you do the following:

1. If the Wacom tablet driver failed to load properly, first perform the recommended action in any error message that may appear on your screen. If that does not solve the problem, review the troubleshooting procedures in this chapter.
2. Look in the [troubleshooting tables](#). Your problem may be described there and you can try the solution offered.
3. Open the Wacom tablet Read Me file for any information updates.
4. Test your tablet and input tools. See [testing your tablet](#) and [testing your tools](#).
5. If you are having a compatibility conflict between Intuos4 and a new hardware or software product, see [obtaining driver downloads](#) for information on downloading an updated software driver. Wacom periodically updates the software driver to maintain compatibility with new products.
6. Check the FAQs (Frequently Asked Questions) on the Wacom web site for your region.
7. If you have tried the suggestions in this manual and still cannot resolve the problem, then contact Wacom for Technical Support. See [technical support options](#) and the Read Me file for information on where to obtain support for your region.

[Testing your tablet](#)

[Testing your tools](#)

[Troubleshooting tables](#)

[Technical support options](#)

[Obtaining driver downloads](#)





TESTING YOUR TABLET

Turn on your computer and wait until the system has fully loaded. Ensure that your computer has a working Bluetooth connection, either through built-in Bluetooth support or a USB-to-Bluetooth adapter (dongle).

1. Check the tablet connection in USB mode. A tablet status LED will light whenever the tablet is properly connected via the USB cable and your computer has registered it as a USB device. If an LED does not glow, then:
 - Verify that the tablet power switch is in the on position.
 - Make sure the USB cable is securely connected to the tablet and to an active USB port on your computer. Intuos4 requires that you connect to a primary USB port (located directly on your computer) or to a powered USB hub.
 - If you are connecting the tablet to a powered USB hub, be sure the USB hub is properly connected to your computer and is active.
 - Connect the tablet to a different powered USB port or try connecting to the powered USB port on another computer.
 - If a status LED does not illuminate after your computer is on and has finished booting up, your USB port may be disabled. Verify that you have connected the tablet to an active USB port.
 - For best results when troubleshooting no power to the tablet (a status LED does not light), plug the tablet directly into the system USB port located on your computer. Temporarily eliminate any external hubs in use until you determine that the system recognizes the tablet and that it is functional. When the tablet is working properly, it is usually okay to then move the tablet to a powered USB hub.
2. Check the tablet connection in wireless mode. A tablet status LED will light whenever the tablet is properly connected and your computer has registered it as a Bluetooth enabled device. If an LED does not glow, then:
 - Verify that the tablet power switch is in the on position.
 - Check the battery power. If the battery status light glows green the battery is charged, if it glows red the battery charge is low. If your battery charge is low, plug in the USB cable. With the USB cable properly connected, the battery status light will glow yellow when charging, and a steady green when fully charged.
 - If the tablet wireless connection light glows a steady blue, your Bluetooth connection is working. Otherwise, it is not. Open the Bluetooth control panel and make sure the tablet was not disconnected. If not disconnected, see step 3, following.
 - Switch the tablet power off, then back on.
 - Reset the tablet by disconnecting both the battery and the USB cable (if in use) for at least 10 seconds. Then reconnect the tablet battery and try again.





3. If necessary, troubleshoot the Bluetooth connection as follows:
 - Move the tablet closer to the antenna. Make sure there are no metal or other high density obstructions in the line of sight between the tablet and Bluetooth antenna.
 - If you are using a computer with a built-in Bluetooth module, ensure it is enabled and working. If using a USB-to-Bluetooth adapter (dongle), be sure it is plugged into an active USB port on your computer and working.
 - Verify your Bluetooth support is working properly. Test the functionality with a different Bluetooth enabled device or check the documentation that came with your Bluetooth support to be sure it is working correctly.
 - Be sure that your Bluetooth configuration supports Bluetooth and the HID profile.
 - Make another attempt to pair the tablet to your system. See [establishing a Bluetooth connection](#).
4. Check the Grip Pen.
 - Move your pen across the tablet active area; the screen cursor should move in the corresponding direction on your monitor or display screen.
 - Press the pen tip against the surface of the tablet. A status LED should brighten.
 - Next, without applying pressure to the pen tip, hold the pen tip within approximately 10 mm (0.39 inch) of the tablet surface and press the side switch. The LED should again brighten.
 - Turn the pen over and press the eraser against the surface of the tablet; the LED should brighten.
 - See [testing your tools](#) for detailed information.
5. Check the Touch Ring. See [testing your tools](#).
6. Check the ExpressKeys. See [testing your tools](#).
7. Check any other tool(s), such as the optional Intuos4 Mouse. See [testing your tools](#).
8. If these tests fail, you may have a defective input tool or tablet. See [technical support options](#).
9. After testing, use the Wacom Tablet control panel to reconfigure your tablet and tools for any custom settings you may originally have been using.



TESTING YOUR TOOLS

If an input tool does not work as you expect, first open the Wacom Tablet control panel and check the assigned functions or reset the tool to its default condition.

To quickly return a tool to the default settings, remove it from the TOOL list by clicking on the control panel list's [-] button. After the tool has been removed, place it back onto the tablet. The tool will be added back to the TOOL list with its default settings.

To test your input tools:

- In the Wacom Tablet control panel, click on the ABOUT button. In the dialog box that appears, click on the DIAGNOSE... button. The DIAGNOSTICS dialog box displays to show dynamic information about the tablet hardware and pointing devices, including the battery status of the currently selected tablet.
- If you have more than one tablet connected to your system, in the TABLET INFO column select the tablet for which you are testing your tool.
- Use the information presented in the DIAGNOSTICS dialog box when testing your tablet and tools.

Note: When testing your tool buttons, if a button is set to RADIAL MENU or OPEN/RUN..., that function will occur when the button is pressed. In this case you may want to change that button function before testing.

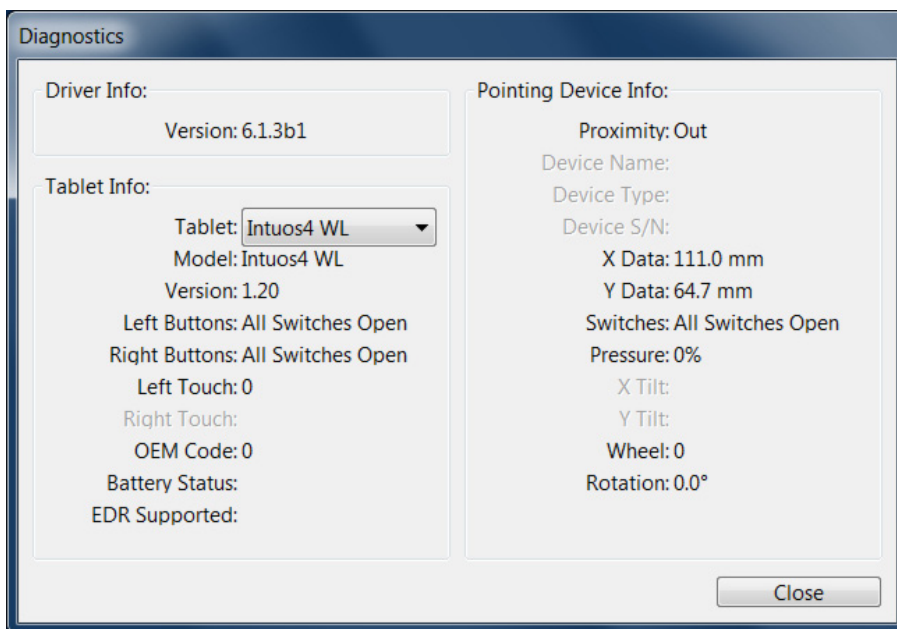

[Testing a pen](#)

[Testing the Touch Ring](#)

[Testing the ExpressKeys](#)

[Testing the optional mouse](#)



TESTING A PEN

1. While observing the POINTING DEVICE INFO column, bring your Intuos4 tool within 10 mm (0.39 inch) of the tablet active area. A value for [PROXIMITY](#), the DEVICE NAME, DEVICE TYPE, and a DEVICE S/N (serial number) should be displayed. If you have more than one tablet connected to your system, be sure you have selected the TABLET for which you are testing your tools from the TABLET INFO column.
2. Move your tool along the tablet surface. The X and Y DATA values should change to reflect the tool position.
3. Test your Intuos4 pen switches. A tablet status LED should brighten each time you click with the tool tip, press the side switch, or press the tool's eraser to the tablet.
 - Click on the tablet surface with the tool tip – the SWITCHES state and PRESSURE value should change. (PRESSURE should change from approximately 0% with no pressure applied to approximately 100% when full pressure is applied.)
 - Press the side switch without pressing the tip to the tablet – the SWITCHES state should change. (For the Intuos4 pen, do this for both positions of the side switch.)

Pen	Tip = 1 Side switch (lower position) = 2 Side switch (upper position) = 3 Eraser = 1
-----	-----------------------------------------------------------------------------------------------

Airbrush	Tip = 1 Side Switch = 2 Eraser = 1
----------	------------------------------------------

- Press the tool's eraser to the tablet – the SWITCHES state and PRESSURE value should change. (Pressure should change from approximately 0% with no pressure applied to approximately 100% when full pressure is applied.)
 - For the Airbrush, move the fingerwheel forward – the WHEEL value should decrease to a value of approximately 0 when the fingerwheel is all the way forward. Move the fingerwheel backward – the WHEEL value should increase to approximately 1000 when the fingerwheel is all the way back.
4. Test tilt for the x-axis by moving the pen from a vertical position toward the right; the X TILT value should change from approximately 0 to +60. Now move the tool to the left of vertical; the X TILT value should change from approximately 0 to -60.
 5. Test tilt for the y-axis by moving the pen from a vertical position toward the bottom of the tablet; the Y TILT value should change from approximately 0 to +60. Now move the tool toward the top of the tablet; the Y TILT value should change from approximately 0 to -60.
 6. If you are testing an Art Pen, test pen rotation by holding the pen vertically and twisting it around its axis. The displayed ROTATION value should change.
 7. When you are done, click on the CLOSE button to exit the dialog box.





TESTING THE TOUCH RING

1. With the DIAGNOSTICS dialog box open, observe the TABLET INFO column as you test the tablet Touch Ring. If you have more than one tablet connected to your system, be sure you have selected the tablet you are testing from the TABLET INFO column.
2. Slide your finger around the entire circumference of the Touch Ring. As you touch and move your finger along the Touch Ring, a LEFT TOUCH number will indicate your current finger position on the Touch Ring.
3. Press the Touch Ring toggle button to toggle between the four customizable states. As you cycle between settings, a corresponding LED should illuminate. Within the DIAGNOSTICS dialog box, the button state is also shown as LEFT BUTTONS.

If any of the functions are set to SKIP, the corresponding LED will be skipped in the toggle sequence.

4. When you are done, click on the CLOSE button to exit the dialog box.

Important: Remember that some applications can override and control the Touch Ring functions. Consider closing any open applications except the Wacom Tablet control panel when testing the Touch Ring. For details, see [using applications integrated for tablet control](#).

TESTING THE EXPRESSKEYS

1. With the DIAGNOSTICS dialog box open, observe the TABLET INFO column as you test each ExpressKey. If more than one tablet is connected to your system, be sure you have selected the tablet you are testing from the TABLET INFO column.
2. Test the keys on your tablet by clicking them one at a time. Each time you press a key, its number will be displayed next to the LEFT KEYS category.
3. On the tablet itself, verify also that a tablet ExpressKeys icon is visible for each corresponding ExpressKey.
4. When you are done, click on the CLOSE button to exit the dialog box.

Important: Remember that some applications can override and control the ExpressKey functions. Consider closing any open applications except the Wacom Tablet control panel when testing the ExpressKeys. For details, see [using applications integrated for tablet control](#).



TESTING THE OPTIONAL MOUSE

1. With the DIAGNOSTICS dialog box open, place the Intuos4 Mouse on the tablet's active area and test by clicking each mouse button. A tablet status LED should brighten, and the SWITCHES state should change for each button you click.

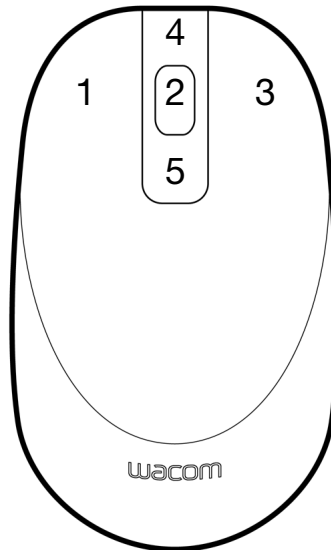

2. When the DIAGNOSTICS dialog box is first opened the WHEEL status should be 0. Move the fingerwheel backward. The WHEEL status should change from 0 to +1.
3. Move the fingerwheel forward. The WHEEL status should change to -1.
4. When you are done, click on the CLOSE button to exit the dialog box.

TROUBLESHOOTING TABLES

If you encounter problems with your Intuos4 tools or tablet, refer to the following tables. Your problem may be described here, and you can try the solution offered. Be sure to check the Read Me file for the latest information updates.

For additional information, visit Wacom's web site at <http://www.wacom.com/productsupport>.

[Connection problems](#)

[General problems](#)

[Windows-specific problems](#)

[Mac-specific problems](#)

CONNECTION PROBLEMS

The computer does not have built-in Bluetooth support.

You will need to install a USB-to-Bluetooth adapter (dongle) in order to add wireless connectivity to your computer. The adapter should support Bluetooth with Human Interface Device (HID) profile.

After moving the power switch to the on position, the wireless connection light glows steadily for 2 to 5 seconds and then turns off.

If the tablet was previously working on your computer but works no longer, check the configuration of your Bluetooth connection:

- If you are using a computer with a built-in Bluetooth module, ensure that it is enabled and working. If you are using a USB-to-Bluetooth adapter (dongle), make sure it is plugged in and working.
- Test your computer's Bluetooth support with another Bluetooth enabled device, such as a mouse or keyboard.
- Open the Bluetooth control panel and make sure the tablet was not disconnected.
- Move the tablet closer to the antenna and make sure there are no metal or other high density obstructions in the line of sight between the tablet and Bluetooth antenna.

Repeat the process of [establishing a Bluetooth connection](#) with your computer.

After moving the power switch to the on position, the wireless connection light flashes blue.

The tablet has not been paired to a computer, or the connection has been broken either by pressing the tablet's pairing button or by deleting the pairing from the Bluetooth control panel.

Pair the tablet to your computer as described in [establishing a Bluetooth connection](#).





The battery status light does not come on after moving the power switch to the on position.

Try again. If the light does not come on after repeated attempts, your battery charge may be too low.

Connect the USB cable directly to a powered USB port on your computer or powered USB hub. If the battery status light does not glow when the power switch is in the on position the battery may be defective.

When pairing the tablet, the tablet does not appear in the list of available devices to pair.

- The tablet should appear in the pairing list with a mouse icon named WACOM TABLET.
- If the wireless connection light is not flashing, press the pairing button on the side of the tablet to make the tablet discoverable. The tablet will be in discoverable mode for 3 minutes and the wireless connection light will flash blue.
- Verify that your Bluetooth configuration supports Bluetooth with Human Interface Device (HID) profile.
- Make sure the tablet is not too far away from the antenna, and that there are no metal obstructions between the Bluetooth antenna and the tablet.

A pairing unsuccessful message is displayed when attempting to link the tablet to the computer.

Check for possible interference from other wireless devices, such as from a cordless telephone or microwave oven. If you suspect interference, turn off the interfering device or move it farther away from your computer.

Try again linking the wireless tablet to the computer.

Pairing was successful, but the wireless tablet does not seem to work correctly.

Be sure that you have correctly installed the Wacom tablet driver software.

See also [optimizing the Bluetooth connection](#).

The tablet works fine when the USB cable is connected to a primary USB port (located directly on your computer) or to a powered USB hub, but switches off as soon as the cable is disconnected.

- Open the battery compartment and verify that the battery is properly installed.
- Check the battery appearance to ensure there is no leakage or other indication of damage.
- Charge the battery overnight and try again. If the problem persists, the battery may be completely discharged or damaged and can no longer hold a charge. You will have to purchase a replacement battery from Wacom. See [ordering parts and accessories](#).
- Confirm the tablet is paired to your system.





After switching on the tablet, the battery status light remains on but the screen cursor cannot be moved with the pen.

- Review [Using the Grip Pen](#) to be sure you are using the tool correctly.
- Switch the tablet power off, then back on.
- If your battery charge is low, plug in the USB cable to a primary USB port (located directly on your computer) or to a powered USB hub.
- Reset the tablet by disconnecting both the battery and the USB cable for at least 10 seconds. Then reconnect the tablet battery and try again.

GENERAL PROBLEMS

The battery status light does not illuminate when the USB cable is plugged in.

Check that the cable is properly plugged into the tablet, and that it is plugged directly into a powered USB port on your computer or a powered USB hub.

Try connecting the tablet to a different powered USB port.

The battery may need [replacement](#).

While using the tablet, the tablet battery status light flashes red.

The battery is nearly empty. Plug in the USB cable to continue working, or power down the tablet.

You want to connect the tablet using the provided USB data cable but the computer does not have an available USB port.

Check if there is an available USB port on a powered USB hub. If not available you will need to add a powered USB hub or USB card.

The tablet status LEDs are off. An LED does not illuminate when using the pen, mouse, or Touch Ring toggle button.

Be sure the tablet is turned on.

If your connection is wireless, verify that the battery status light is on and that the Bluetooth wireless connection is active.

If your tablet is connected using the provided USB data cable, verify that the USB cable is properly connected to the tablet and to an active USB port. Be sure the tablet USB cable is plugged into a primary USB port (directly into your computer) or into a powered USB hub. If connecting to a powered USB hub device, make sure the hub is connected to an active USB port and that the hub is active. Try also connecting to another USB port or using another USB cable.

After plugging in the tablet with a USB connection, a message appears indicating that the USB device needs more power than is available.

Make sure the tablet is plugged into a primary USB port on your computer or into a powered USB hub attached to your computer.





The tablet charging process seems to stop whenever the computer enters sleep mode.

As required, adjust your system power or energy saver settings so that the computer does not enter sleep mode while the tablet is charging.

When using the pen to operate the Touch Ring, the Touch Ring does not work well.

The Touch Ring is designed to be used with your finger, and does not work with the pen tip.

The pen works only in MOUSE MODE, and does not draw or ink with pressure sensitivity.

The tablet driver software was not installed or did not load properly.

- Make sure the tablet driver software is installed and functioning.
- Insert the Intuos installation CD into your computer and install the driver software for the tablet.

The pen does not draw or ink with pressure sensitivity.

Some applications require that you turn on the pressure capabilities within the application or the selected tool before the pen will respond as a pressure-sensitive tool.

Some applications do not support pressure. If you are unsure whether pressure is supported, see the documentation that came with your application(s).

Clicking is difficult.

Try using a lighter TIP FEEL. See [adjusting tip feel and double-click](#).

Double-clicking is difficult.

- Use the side switch to double-click. Review the technique in [clicking](#).
- Be sure you are quickly tapping the tablet twice in the same place on the tablet's active area.
- Try increasing the TIP DOUBLE CLICK DISTANCE. See [adjusting tip feel and double-click](#).
- Try using a lighter TIP FEEL. See [adjusting tip feel and double-click](#).
- Set an ExpressKey to DOUBLE CLICK and use it to issue double-clicks.
- Windows: Try setting your system to launch programs with a single click. See [clicking](#).

The pen selects everything, will not stop selecting.

Open the Wacom Tablet control panel and go to the PEN tab. Move the TIP FEEL slider toward FIRM, or select DETAILS... and increase the CLICK THRESHOLD setting. If this does not help, see [testing your tools](#).

The pen nib may be worn. See [replacing the pen tip](#).

The eraser selects everything or will not stop erasing.

Open the Wacom Tablet control panel and go to the ERASER tab. Move the ERASER FEEL slider toward FIRM, or select DETAILS... and increase the CLICK THRESHOLD setting. If this does not help, see [testing your tools](#).





You notice a screen delay at the beginning of pen or inking strokes.

Open the Wacom Tablet control panel and go to the PEN tab. Try decreasing the TIP DOUBLE CLICK DISTANCE (see [adjusting tip feel and double-click](#)). If that does not work, try dragging the TIP DOUBLE CLICK DISTANCE slider to the OFF position in order to turn off double-click assist.

Try turning off the operating system inking features.

You have to press hard with the pen when clicking, drawing, or writing.

Open the Wacom Tablet control panel and go to the PEN tab. Move the TIP FEEL slider toward SOFT, or select DETAILS... and decrease the SENSITIVITY and CLICK THRESHOLD settings.

The pen tip does not function.

Be sure you are using the pen that originally came with Intuos4. Other pens may not function properly on the tablet.

Check the control panel's PEN tab and verify that a CLICK function is assigned to the tip.

Try the pen eraser to see if that portion of the pen is functional.

A tablet status LED should brighten when the tip or eraser is pressed. If not, you may have defective hardware. See [testing your tools](#).

Changing the function settings of an input tool has no effect.

Make sure you are changing the settings for the tool and application that you are using. See [working with multiple tools](#) and [application-specific settings](#).

The pen side switch does not work.

Be sure you are using the pen that originally came with Intuos4 or an Intuos4 accessory pen. Other pens may not function properly on the tablet.

Be sure to press the side switch when the pen tip is within 10 mm (0.39 inch) of the tablet's active area. Do this without pressing down on the pen tip.

In the Wacom Tablet control panel, verify that the side switch is set to the function you are expecting to occur for the application and tool you are using.

Check also the SIDE SWITCH MODE. If CLICK & TAP is selected, you will need to first press the side switch while touching the pen tip to the tablet surface in order to perform a click function. See [customizing tool buttons](#).

A tablet status LED should brighten when you press the side switch. If not, you may have defective hardware. See [testing your tools](#).



The screen cursor “jumps” back.

Do not place an Intuos4 tool on the tablet when it is not in use, or when you are using another pointing device. Leaving your tool on the tablet may interfere with screen cursor positioning when using other input devices.

Cannot move the cursor (pointer) where you want to on the screen, or the line you are drawing does not line up with the location of the cursor in paint applications.

Open the Wacom Tablet control panel and go to the MAPPING tab. Verify that PEN MODE is selected and that the SCREEN AREA is set to FULL for the selected tool and application. If this does not help, click on the DEFAULT button to reestablish tablet to screen mapping. If you are still having difficulty, remove the tablet preferences.

Confirm whether the pen does (or does not) function. See [testing your tools](#).

The computer does not go to sleep.

When you are not using your Intuos4 input tool(s), remove them from the tablet surface or the tablet will continue to send data, keeping the computer awake.

When using the tablet the screen cursor is very erratic or “jumps” around.

On rare occasions the tablet may receive interfering radio frequencies from a computer monitor or nearby AM radio station. If you notice interference from a monitor, try moving the tablet at least 6 inches away from the monitor, or change the monitor refresh rate or monitor resolution.

If the screen cursor lags or “jumps”, try [optimizing the Bluetooth connection](#).

When using the tablet, the screen cursor or pen strokes seem to lag or skip in some applications.

See [optimizing the Bluetooth connection](#) for tips on improving the Bluetooth connection.

When using Intuos4 on a multiple monitor system, you cannot use the pen tip to control the other monitor(s).

Determine if an ExpressKey has been set to DISPLAY TOGGLE and if it may have been activated accidentally. See [working with Display Toggle](#).

Verify that the SCREEN AREA in the MAPPING tab is set to FULL.

You can also use your pen to control the other monitors in MOUSE MODE. To use MOUSE MODE, first set a pen button to MODE TOGGLE.... Then use the button to toggle between PEN MODE and MOUSE MODE.





When working in some applications, the ExpressKeys or Touch Ring perform a different function than what is set in the Wacom Tablet control panel.

Some applications can override and control the ExpressKey and Touch Ring functions.

- When an ExpressKey is overridden by an application, the ExpressKeys display will automatically update to show either the new function name or “Application Defined”.
- See [using applications integrated for tablet control](#).

If you use application-specific settings, be sure you have updated the settings for the correct application.

The tablet is set to EXPRESSKEYS RIGHT (or EXPRESSKEYS LEFT), but at the log-in screen the tablet seems to work upside down.

Begin by [uninstalling the software](#) for the existing tablet driver. Restart your computer. Then reinstall the tablet driver from the Intuos installation CD and change the default orientation of the tablet. See [configuring the tablet orientation](#) for details.

WINDOWS-SPECIFIC PROBLEMS

You suspect the tablet preferences may be corrupted, or want to make certain that all settings are at their factory defaults.

Use the Wacom Tablet Preference File Utility to work with your preferences. Close any open applications. Click the START icon and select ALL PROGRAMS. Then select WACOM TABLET and WACOM TABLET PREFERENCE FILE UTILITY.

- It is a good idea to first back up your tablet preferences. In the TABLET PREFERENCE FILE UTILITY dialog box, click BACKUP... and follow the prompts.
- Then, delete the tablet preferences as follows:
 - Single user. In the TABLET PREFERENCE FILE UTILITY dialog box, click the REMOVE button under MY PREFERENCES to delete the preferences for the current user.
 - Multiple users. Click the REMOVE button under ALL USER PREFERENCES to delete preferences for multiple users. Note that administrator rights are required to delete preferences for all users. Relaunch any currently open tablet-aware applications that you may be running.

You can quickly restore tablet preferences that have been backed up by clicking RESTORE... under MY PREFERENCES.

After changing right- and left-handed settings in the computer’s mouse control panel, the pen tip no longer functions properly and the Intuos4 Mouse tool button functions are reversed.

Restart Windows for your Wacom tool settings to be correctly recognized.





MAC-SPECIFIC PROBLEMS

At startup, a dialog box appears telling you that either the driver failed to load or the tablet preferences have not yet been created.

The tablet was not detected at startup.

If you are using a wireless connection, make sure the Bluetooth wireless connection to your tablet is active. Check also that the tablet wireless connection light and a tablet status LED are illuminated. From the GO menu, select the UTILITIES folder and launch the SYSTEM PROFILER. Select BLUETOOTH from the HARDWARE section of the CONTENTS list. A Wacom Bluetooth tablet model should be listed. If a tablet model is not listed, check the Bluetooth wireless connection.

If you have connected the tablet with the provided USB data cable, make sure the USB interface cable is securely connected to the tablet and to an active USB port on your computer. Check also that a tablet status LED is illuminated. If your tablet is plugged into a powered USB hub, make sure the hub is connected and active. From the GO menu, select the UTILITIES folder and launch the SYSTEM PROFILER. Select USB from the HARDWARE section of the CONTENTS list. A Wacom USB tablet model should be listed. If a tablet model is not listed, check the USB cable connection or try plugging the tablet into a different USB port.

If you are still having difficulties, uninstall then reinstall the tablet driver software.

If this does not help, contact Wacom for Technical Support.

See [technical support options](#).

Cannot switch off Intuos4 after closing the lid on an Apple laptop computer.

Switch off the tablet before closing the lid on your Apple laptop.

Do not worry. The tablet will automatically switch off 5 minutes after you close the lid on your Apple laptop.

Alternatively, if you prevent Bluetooth enabled devices from waking your computer, the tablet will immediately switch off when your computer goes to sleep or when you close the lid of your Apple laptop.

To prevent Bluetooth enabled devices from waking your computer:

1. From the Apple menu, choose SYSTEM PREFERENCES....
2. Click on the BLUETOOTH icon located in the HARDWARE section of the System Preferences pane.
3. In the BLUETOOTH control panel, click on the ADVANCED... button.
4. Make sure that the ALLOW BLUETOOTH DEVICES TO WAKE THIS COMPUTER option is unchecked.

Exit the Bluetooth control panel and quit System Preferences.





You suspect the tablet preferences may be corrupted, or want to make certain that all settings are at their factory defaults.

Use the Wacom Tablet Utility to work with your preferences. Close any open applications. Open the main APPLICATIONS folder. Then open the WACOM TABLET folder and run the WACOM TABLET UTILITY.

- It is a good idea to first back up your tablet preferences. In the WACOM TABLET UTILITY dialog box, select CURRENT USER or ALL USERS. Then click BACKUP... and follow the prompts.
- Then, delete the tablet preferences as follows:
 - Single user. When the utility starts, select CURRENT USER and click on the REMOVE button. Log out, then log back in. When the tablet driver loads it will create a new preferences file with the factory defaults.
 - Multiple users. When the utility starts, select ALL USERS and click on the REMOVE button. Log out, then log back in. When the tablet driver loads it will create new preferences files with the factory defaults.

You can quickly restore tablet preferences that have been backed up for the CURRENT USER or ALL USERS by clicking on the RESTORE... button within the utility.

Note: Do not manually remove the WACOM TABLET.PREFPANE file from the main LIBRARY PREFERENCEPANES folder. This file is only to be removed when uninstalling the tablet software driver, and then only when using the WACOM TABLET UTILITY.

Ink does not work correctly with Intuos4.

There may be a problem with the Ink preferences. Remove the damaged preference files as follows. They will be re-created when you enable handwriting recognition.

1. Open the SYSTEM PREFERENCES pane, choose SHOW ALL and select INK. Then turn off handwriting recognition.
2. From the GO menu, choose your HOME. Open the LIBRARY and PREFERENCES folders. Remove the following preferences:
 - COM.APPLE.INK.FRAMEWORK.PLIST
 - COM.APPLE.INK.INKPAD.PLIST
 - COM.APPLE.INK.INKPAD.SKETCH
3. Go back to SYSTEM PREFERENCES and INK, and then enable handwriting recognition.
4. Test the Ink function using your Wacom tablet and pen.
5. If this procedure does not resolve your problem with Ink, contact Apple Support for further assistance. Wacom is not the software manufacturer for Ink and we are limited in our abilities to support a third-party software application.





TECHNICAL SUPPORT OPTIONS

If you have a problem with your Wacom tablet, first check the tablet installation guide to be sure the unit is installed correctly. Then review the [troubleshooting](#) procedures.

If you cannot find the answer in this manual, you may find updated information about your problem in the appropriate Read Me file for your platform (located on the Intuos installation CD). You can also check the product FAQs (Frequently Asked Questions) on the Wacom web site for your region.

If you have an Internet connection you can download the latest software drivers from the Wacom web site for your region. See [obtaining driver downloads](#).

If you cannot solve the problem and you think your Wacom tablet is not working properly, contact the Wacom support staff for the area where your product was purchased. See the Wacom tablet Read Me file, located on the Intuos installation CD, for contact information.

When you call, you should be at your computer with the following information available:

- This manual.
- Tablet serial and model number. (Look on the bottom of the tablet.)
- Driver version number. (See the Intuos installation CD or click on the Wacom Tablet control panel ABOUT button.)
- The make and model of your computer, and operating system version number.
- A list of peripheral devices attached to your computer.
- The software application and version you were using when the problem occurred.
- The exact wording of any error message that appeared on your screen.
- What happened and what you were doing when the problem occurred.
- How you tried to solve the problem.

You can also contact the Wacom Customer Care Center using our Email Inquiry form at: <http://www.wacom.com/productsupport/email.cfm>





OBTAINING DRIVER DOWNLOADS

Wacom periodically updates the tablet software driver to maintain compatibility with new products. If you are having a compatibility problem between Intuos4 and a new hardware or software product, it may be helpful to download a new Wacom tablet software driver (when available) from the Internet.

USA, Canada, Central and South America

Worldwide Web: <http://www.wacom.com/productsupport> Software updates.

Europe, Middle East and Africa

Worldwide Web: <http://www.wacom.eu/downloads> Software updates.

Japan

Worldwide Web: <http://tablet.wacom.co.jp/download> Software updates. (Japanese)

Asia Pacific (English)

Worldwide Web: <http://www.wacom-asia.com> Software updates. (English)

China

Worldwide Web: <http://www.wacom.com.cn> Software updates.
(Simplified Chinese)

Korea

Worldwide Web: <http://www.wacomkorea.com> Software updates. (Korean)

Taiwan

Worldwide Web: <http://www.wacom.com.tw> Software updates.
(Traditional Chinese)





APPENDIX

This section contains a variety of information: tips on caring for your tablet and tools, instructions on how to uninstall the tablet software, your license and warranty, and more.

[Tablet installation](#)

[Battery life information](#)

[Replacing the tablet battery](#)

[Caring for your tablet and tools](#)

[Replacing the pen tip](#)

[Uninstalling the software](#)

[Managing your tablet preferences](#)

[Changing the tablet mode options](#)

[Installing multiple tablets](#)

[Advanced options](#)

[Optimizing the ExpressKeys display](#)

[Using applications integrated for tablet control](#)

[Using the optional Intuos4 Mouse](#)

[Using the optional Airbrush and Art Pen](#)

[Pen and digital ink capabilities in Windows](#)

[About the Windows Tablet PC Input Panel](#)

[Product specifications](#)

[Product information](#)

[Ordering parts and accessories](#)

[Available parts and accessories](#)

[Radio and television interference](#)

[Precautions](#)

[License and Warranties \(Worldwide, Except for Europe, Africa and Middle East\)](#)

[Licence warranty conditions \(Europe, Africa and Middle East\)](#)

TABLET INSTALLATION

For detailed instructions, please review the Quick Start Guide that came with your tablet. See also [establishing a Bluetooth connection](#).





BATTERY LIFE INFORMATION

All batteries age over time and gradually lose their ability to hold a charge. The typical life span of a Li-Ion battery is two to three years, whether it is used or not.

You will need to purchase a new tablet battery when it is no longer capable of holding an adequate charge. For information on ordering a replacement battery, see [ordering parts and accessories](#). Batteries can also be purchased at various retail outlets.

- The life and performance of Li-Ion batteries is not improved by cycling (discharging and recharging) the batteries.
- Cool storage and keeping the battery in a partially (not fully) charged state when not in use can slow the aging process.
- Always charge your tablet battery whenever the low battery warning appears on your display screen, or at the latest when the tablet battery status light begins to flash red. To reduce the power consumption of an empty battery, the tablet will enter an auto shut-down state whenever the battery level is very low. In this state the tablet will continue to draw a small amount of power. The power switch must be turned off and the battery must be recharged.
- The tablet will draw current from the battery whenever the power switch is in the on position. A small current is drawn even in auto sleep and tablet auto shut-down modes, and will slowly discharge the battery. It is a good idea to charge the battery and move the tablet power switch to the off position before leaving the tablet unused for a number of days.
- If the battery charge is low and the battery remains in the tablet for a long period of time (a week or longer) with the power switch in the on position, the small trickle of current used by the tablet is likely to discharge the battery so far that an internal protection circuit within the battery is activated. If this occurs you will no longer be able to charge the battery. To preserve your battery, be sure to move the tablet power switch to the off position before leaving the tablet unused for a week or longer.
- For extended storage (a month or longer), Wacom recommends that the battery be at least half full before you move the power switch to the off position. You do not need to remove the battery because the power switch disconnects the battery from the tablet circuit when in the off position.
- An internal protection circuit within the battery prevents any charging once the voltage has fallen below a minimum safety level. Once a Li-Ion battery has been over-discharged it cannot be recharged.

 **Warning:** See the [safety precautions for Lithium-Ion batteries](#).



REPLACING THE TABLET BATTERY

If your tablet battery has exceeded its life span and can no longer be charged or no longer holds a charge, it will need to be replaced. Be sure to use only the rechargeable Lithium-Ion (Li-Ion) battery designed for your tablet. For information on ordering a replacement battery, see [ordering parts and accessories](#). Batteries can also be purchased at various retail outlets.

Important: Only use a Wacom battery specified for your tablet.

To replace the tablet battery:

1. Turn the wireless tablet upside down and open the battery cover. Use your fingernail to press inward on the latch bar and flip the cover outward to open.
2. Carefully remove the old tablet battery.
3. Align the battery terminals of the new battery with the spring-loaded tablet contacts, and press the battery into the compartment as shown. To avoid damaging your tablet, first insert the terminal end of the battery.
4. Close the battery cover.

Important: When replacing the tablet battery, be careful not to drop it on hard surfaces. The battery can be damaged internally when dropped, and should be replaced even if there is no obvious damage. This will help prevent any future damage that could occur to the tablet if the battery has been dropped, is installed in the tablet, and then later develops a short or leak while in the tablet.

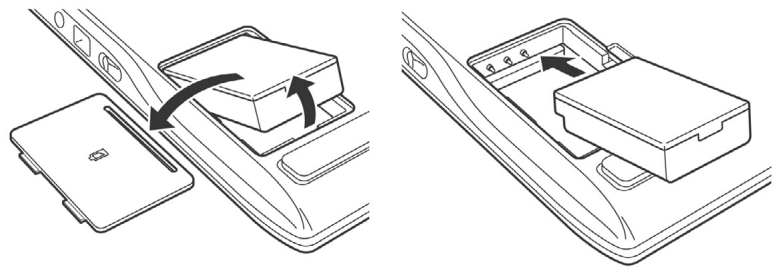

 **Warning:** See the [safety precautions for Lithium-Ion batteries](#).

Many communities offer voluntary or mandatory recycling programs for batteries. Properly recycle the old battery by following all applicable laws, and in accordance with the [safety precautions for Lithium-Ion batteries](#). Keep batteries out of the reach of children, and promptly recycle old batteries.

CARING FOR YOUR TABLET AND TOOLS

Keep your Intuos4 tools and tablet surface clean. Dust and dirt particles can stick to your tools and cause excessive wear to the tablet surface. Regular cleaning with a soft, damp cloth will help to prolong the life of your tablet surface and tools; you can also dampen the cloth using a very mild soap diluted with water. Do not use volatile liquids, such as paint thinner or benzene, because they may damage the plastic case.

Keep your tablet and tools in a clean, dry place and avoid extremes in temperature. Room temperature is best. Also, your tools and tablet are not made to come apart. Twisting the pen case can break the pen. Taking apart the product will void your warranty.

Important: Take care to never spill liquids onto the tablet or input tools. Be especially careful of getting the tablet or tool buttons (including the pen tip and eraser) wet – they contain sensitive electronic parts that will fail if liquids enter them.

REPLACING THE PEN TIP

The pen tip (nib) will wear with normal use. Excessive pressure will cause it to wear sooner. Replace the nib when it gets too short (less than 1 mm (0.04 inch)) or develops a flat point.

1. Unscrew the pen stand base to access the nib extraction tool and replacement nibs.

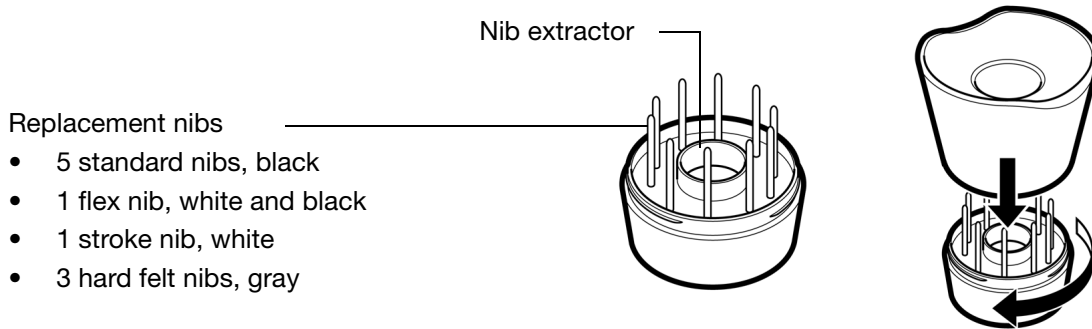

2. Clasp the old nib with the nib extraction tool, pair of tweezers, needle-nosed pliers, or similar instrument and pull it straight out of the pen.
3. Slide the end of the new nib straight into the barrel of the pen. Firmly push the nib until it stops.

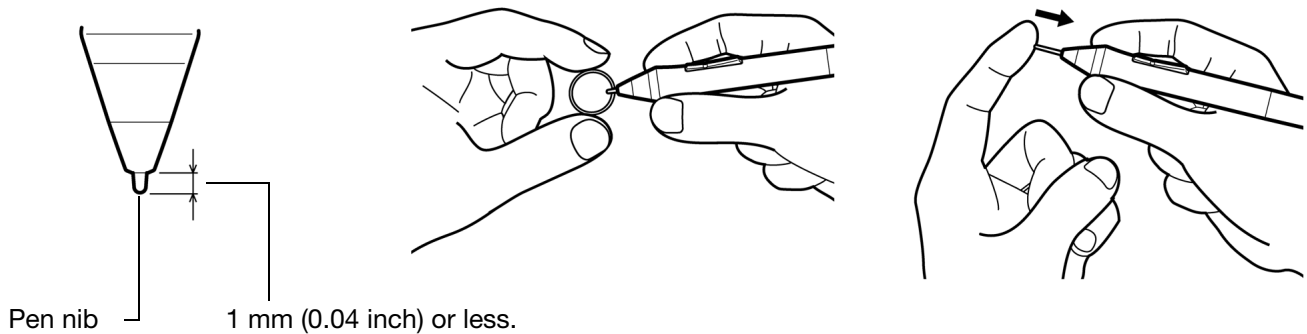

Note: Stroke nibs are spring-loaded, providing additional tactile feedback when you are working with the Intuos4 pen or Airbrush. They are installed in the same manner as a standard pen nib.

Warning: Choking hazard. Prevent children from swallowing the pen nib or side switch. The pen nib or side switch may accidentally be pulled out if children are biting on them.

To order replacement parts, see [available parts and accessories](#).

Important: When the pen is not in use, place it in the pen stand or lay it flat on your desk. When the optional Airbrush is not in use, lay it flat on your desk. Leaving the pen on the tablet can prevent the tablet from switching off and cause the battery to discharge.

To maintain the sensitivity of your input tools, do not store them in a container where they will rest on their tip or eraser.

If you find it inconvenient to use the desktop pen stand, you can also attach the [pen holder](#) to the tablet and place the pen in the holder loop for safe-keeping.



UNINSTALLING THE SOFTWARE

Follow the appropriate procedure below to remove the Wacom tablet driver software from your system.

Important: When you remove the Wacom tablet software from your system, your Wacom tablet will no longer operate with full tablet functionality but will continue to function as a mouse device.

Windows 7 and Vista: Click on the Windows START button and choose CONTROL PANEL. In the CONTROL PANEL window, click on UNINSTALL A PROGRAM. In the dialog box that appears, choose WACOM TABLET. Click UNINSTALL and follow the prompts to remove the tablet driver. (If prompted, enter your administrator login name and password.) Be sure to restart your computer after uninstalling the software.

Windows XP or XP x64: Click START. In the start menu, select CONTROL PANEL. Then select ADD OR REMOVE PROGRAMS. In the ADD OR REMOVE PROGRAMS window, choose WACOM TABLET and click on the REMOVE button. Follow the prompts to remove the tablet driver. Be sure to restart your computer after uninstalling the software.

Macintosh: From the GO menu, choose APPLICATIONS and open the WACOM TABLET folder. Double-click on the WACOM TABLET UTILITY icon and select the TABLET SOFTWARE: REMOVE button. Enter your administrator login name and password. After the removal is completed, click OK. Be sure to restart your computer after uninstalling the software.

Note: To fully remove the Intuos4 Wireless tablet from your computer, you will need to delete the paired connection from the Bluetooth devices control panel for your operating system.

MANAGING YOUR TABLET PREFERENCES

Use the Wacom tablet preferences utility to manage your tablet preferences for a single or multiple users.

For Windows, first close any open applications. Then open the utility by clicking the START icon and selecting ALL PROGRAMS. Select WACOM TABLET and WACOM TABLET PREFERENCE FILE UTILITY.

- To remove preferences for the current user, click on the REMOVE button under MY PREFERENCES.
- To delete preferences for multiple users, click on the REMOVE button under ALL USER PREFERENCES. Administrator rights are required to delete preferences for all users. Relaunch any currently open tablet-aware applications that you may be running.
- To back up your preferences, click on the BACKUP... button under MY PREFERENCES.
- To restore preferences that you had previously backed up, click on the RESTORE... button under MY PREFERENCES.

Be sure to carefully follow any prompts that may appear.

For Macintosh, open the main APPLICATIONS folder. Then open the WACOM TABLET folder and run the WACOM TABLET UTILITY.

- To remove preferences, select CURRENT USER or ALL USERS. Then click on the REMOVE button. Log out, then log back in. When the tablet driver loads it will create a new preferences file with the factory defaults.
- To back up your preferences, select CURRENT USER or ALL USERS. Then click on the BACKUP... button.
- To restore preferences that you had previously backed up, select CURRENT USER or ALL USERS. Then click on the RESTORE... button.

Be sure to carefully follow any prompts that may appear.



CHANGING THE TABLET MODE OPTIONS

Within the control panel's TABLET list, double-click on the tablet icon to display the TABLET dialog box. The TABLET mode settings apply to all tools and applications.

If desired, enter a new name to be used for the tablet icon.

Name Intuos4 WL

STANDARD MODE is recommended for graphics applications, and is the default condition.

Tablet Mode Standard Mode

Choose RECOGNITION MODE for the maximum data rate. Required by some handwriting recognition software. Supported only on Bluetooth Specification v2.0 or later connections that support the EDR (Enhanced Data Rate) protocol.

Default

Cancel

OK

INSTALLING MULTIPLE TABLETS

The TABLET list displays an icon for any supported tablet that has been detected on your system, and allows you to select the tablet for which your changes will apply.

Select a tablet icon for which to customize tool and application settings.

- The control panel will not launch unless a supported tablet is connected to the computer.
- Settings can only be viewed or changed for an attached tablet.

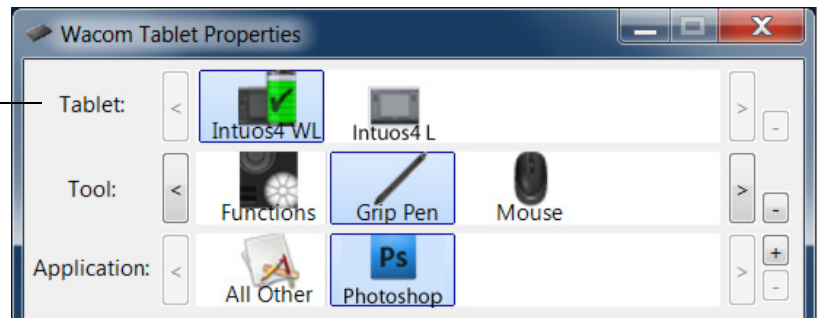

To add a new tablet, connect it to your computer. The system will automatically find the tablet and initialize it. An icon for the tablet will then appear in the control panel.

Important: When installing additional tablets on Windows systems, please note that the eraser function may not work in some applications when using the additional tablet(s). The eraser function will continue to work correctly using the first tablet that was added to the control panel.

To remove one of multiple tablets from the driver, in the Wacom Tablet control panel select the tablet to be removed and click on the [-] button next to the TABLET list.

- A tablet cannot be deleted from the control panel list unless it is attached to the computer.
- Note that you will need to restart your computer before you can again add the tablet to the driver.

ADVANCED OPTIONS

Click on the Wacom Tablet control panel OPTIONS... button to access the advanced OPTIONS dialog box.

SIDE SWITCH MODE changes the way you use the pen when making right clicks or other click functions. Select:

- HOVER CLICK to perform click functions without touching the pen tip to the tablet surface.



Hover click

- CLICK & TAP to enable the precise placement of click functions. When selected, you must first press the side switch then touch the pen tip to the tablet surface in order to perform the click function.



Click tap

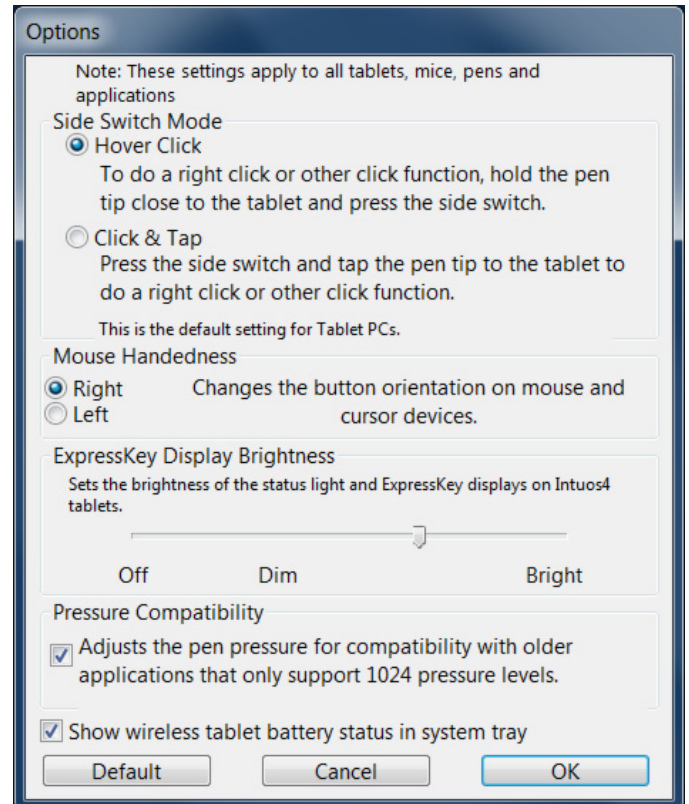

- MOUSE HANDEDNESS options change the button orientation on the Intuos4 Mouse for right- or left-handed use.
- Use the EXPRESSKEY DISPLAY BRIGHTNESS options to set the brightness of the Touch Ring status LEDs and ExpressKeys display on all connected Intuos4 tablets. When the slider is in the left-most position, the Touch Ring status LED brightness is set to low, and the ExpressKeys display is off. See also [optimizing the ExpressKeys display](#).

The pen tablet power saving mode will automatically change the brightness of the Touch Ring status LEDs and ExpressKeys display as follows:

1 minute no user input:	Low brightness
2.5 minutes no user input:	No illumination, ExpressKeys display Low brightness, Touch Ring status LEDs
Active user input:	Returns brightness to set level

- The PRESSURE COMPATIBILITY check box should be checked if you are using graphics applications that only support a maximum of 1024 levels of pressure (such as Adobe CS3, Corel Painter 9, and other older applications). If not checked, the pen will feel overly sensitive when using these older applications.
- By default the SHOW WIRELESS TABLET BATTERY STATUS check box is set to display the Wacom icon in your system task bar (Windows) or menu bar (Macintosh). Uncheck this box to remove the icon.



OPTIMIZING THE EXPRESSKEYS DISPLAY

The pen tablet ExpressKeys display uses Organic Light-Emitting Diodes (OLEDs). Although the display has been designed to provide reliable performance for many years, you may eventually notice a decrease in luminosity for pixels that are lit over extended periods of time. To minimize the appearance of different pixel brightnesses due to this effect, adjust the EXPRESSKEY DISPLAY BRIGHTNESS option to the lowest comfortable light level. See [advanced options](#) for details.

Note: The power saving feature of the pen tablet will automatically dim the ExpressKeys display if there has been no user input for 1 minute, and it will turn off the ExpressKeys display if the pen tablet has been idle for 2.5 minutes.

USING APPLICATIONS INTEGRATED FOR TABLET CONTROL

Some software applications may be designed to directly control the pen tablet ExpressKeys or Touch Ring function(s). When working in an application that has been integrated in this manner, the ExpressKeys or Touch Ring may perform a different function than what is currently set in the Wacom Tablet control panel.

- When an ExpressKey is overridden by an application, the ExpressKeys display will automatically update to show either the new function name or “Application Defined”. Some or all of the ExpressKeys may be overridden, depending on the application.
- When an application overrides the Touch Ring, all Touch Ring functions are affected. If an application overrides only one, two, or three of the available Touch Ring functions, the remaining function(s) are set to SKIP.
- An integrated application will control the ExpressKeys or Touch Ring only when that application is active and in the foreground. When you close that application (or select a new application pane to work in), your Wacom Tablet control panel settings are returned to their previous state.
- To review the ExpressKeys or Touch Ring function settings for the current front-most application, set an ExpressKey to SHOW SETTINGS and press the key at any time.

Applications that have been integrated in this manner will typically provide you with the opportunity to opt-out or disable this functionality when first using your Wacom tablet with the application. See the documentation provided with your application for any specific details on functionality and how to customize or disable this feature.

If an automatic prompt or the application’s documentation does not describe how to disable this behavior, you can use the Wacom Tablet control panel to create [application-specific settings](#) which will override the behavior of the integrated application.

Important: If an application-specific setting has been created for an integrated application, setting an ExpressKey or Touch Ring function to APPLICATION DEFINED will allow the integrated application to control the function.



USING THE OPTIONAL INTUOS4 MOUSE

The Intuos4 Mouse is cordless, battery free, and works on any Intuos4 tablet. The mouse is an optional accessory, and product configurations may vary.

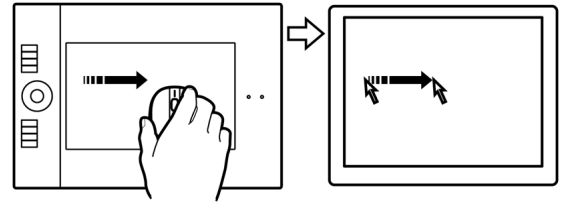

Fingerwheel

Can be rolled, or pressed for an additional button function.

- Roll the fingerwheel to scroll in most windows and applications. Move the wheel forward to scroll up, and back to scroll down.

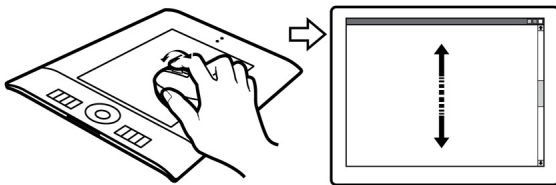

- Press down on the wheel to perform a MIDDLE CLICK.

Tip: For Microsoft Office applications that support a wheel mouse, press the CTRL key and move the fingerwheel to zoom in and out.

Right button

Displays a context menu when pressed.

Left button

This is the primary button used to CLICK and select.

The [programmable mouse buttons](#) can be customized. The default button options are:

Left:	CLICK
Right:	RIGHT CLICK
Middle:	MIDDLE CLICK
Front:	FORWARD
Rear:	BACK

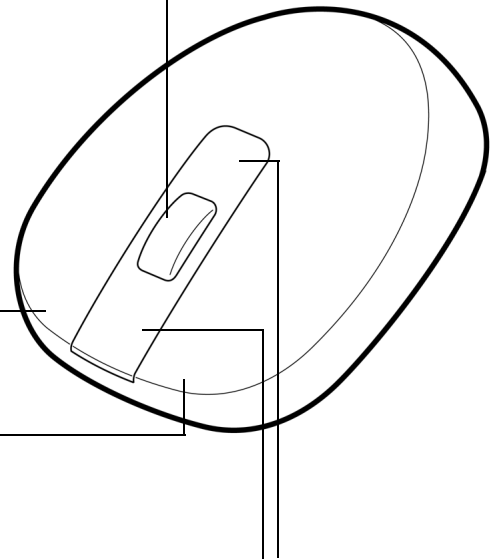

Front and rear buttons

These are set for FORWARD and BACK functionality within your Internet browser.

Important: When the Intuos4 Mouse is not in use, place it on your desk. Leaving an Intuos4 tool on the tablet may interfere with screen cursor positioning when using other pointing devices, or may prevent your computer from going to sleep.

See also [customizing the mouse](#).

USING THE OPTIONAL AIRBRUSH AND ART PEN

The optional Intuos4 Airbrush works like the Grip Pen, but also includes a fingerwheel for an additional degree of control. With proper software support, you can simulate realistic airbrushing. For example, tilting the Airbrush can cause the spray pattern to elongate and feather out. Rolling the fingerwheel adjusts the spray intensity, and pressure on the tip controls the brush size.

Hold the Airbrush with your thumb and middle finger. The fingerwheel should be in a convenient location for you to roll it with your index finger. Tilt the Airbrush to find a comfortable position that allows you to paint and draw with pressure sensitivity.

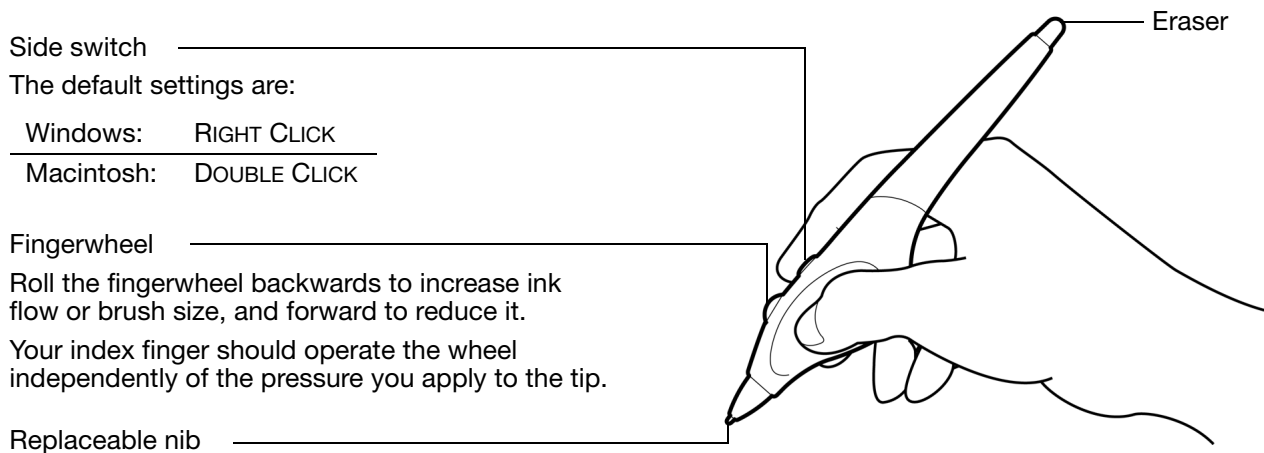

The optional Intuos4 Art Pen responds to the pressure, tilt, and rotation you apply to the pen.

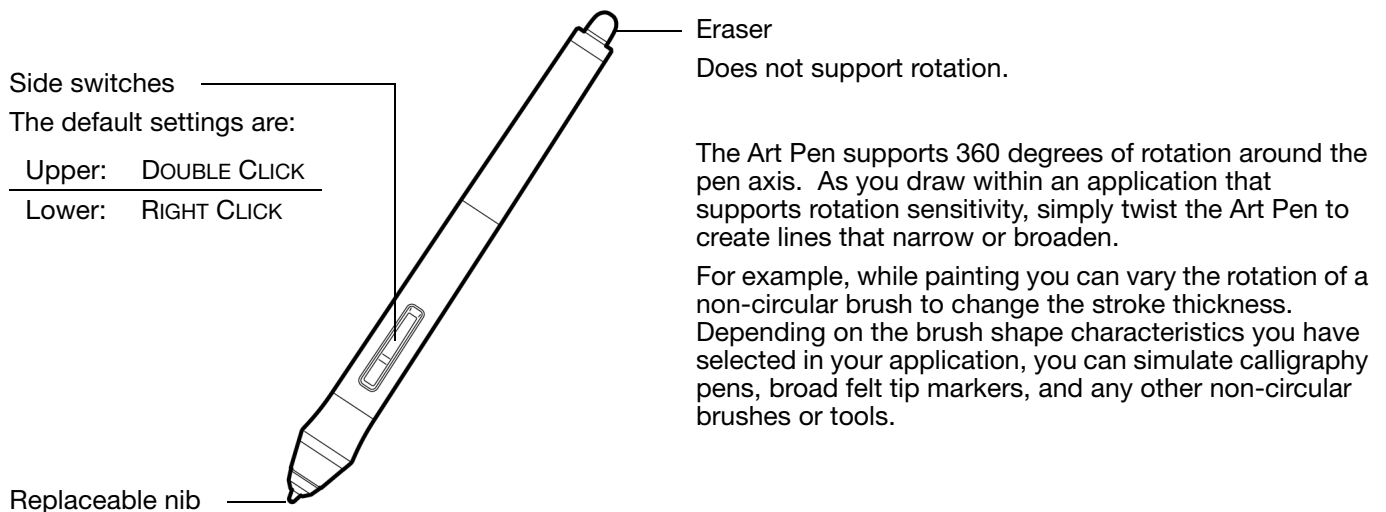

Important: When the Airbrush or Art Pen is not in use, lay it flat on your desk. To maintain the sensitivity of your tool, do not store it in a container where it will rest on its tip or eraser. Leaving an Intuos4 tool on the tablet may interfere with screen cursor positioning when using other pointing devices.

See [product information](#) to learn more about which applications currently support the Airbrush fingerwheel or Art Pen rotation. See [ordering parts and accessories](#) for information on where to purchase an Intuos4 Airbrush or Art Pen.



PEN AND DIGITAL INK CAPABILITIES IN WINDOWS

Microsoft Windows 7 and Vista provide extensive support for pen* and touch input. When using the professional pen tablet with a computer running Windows 7 or Vista, your experience is enhanced by powerful note taking, handwriting recognition, fast navigation, and other digital inking options designed to give you quick, intuitive results with the Intuos4 pen.

- **Note taking.** Use your Intuos4 pen to jot notes and capture quick sketches in Microsoft Journal. Journal simulates a physical notebook, but with the advantages of digital note taking – you can choose from a variety of pen, marker, and highlighter tools, plus an eraser that is easily activated by the eraser of your Intuos4 pen. Journal also includes a powerful search engine that can even locate your handwritten content.
- **Handwriting recognition.** Because Windows 7 and Vista include powerful handwriting recognition capabilities, you can use your Intuos4 pen to quickly enter handwritten information anywhere the computer accepts typed input. You can convert your handwritten content to typed text at any time.
- **Gestures.** Use your Intuos4 pen to make simple gestural movements on the tablet to trigger customizable actions for navigation, editing, and other functions. To customize your gestures, select the FLICKS tab in the PEN AND INPUT DEVICES control panel.
- **Digital Ink in Microsoft Office 2007.** Use your Intuos4 pen to full advantage with the enhanced digital mark-up and inking tools available in Microsoft Office 2007 or later applications running on Windows 7 or Vista. Found on the REVIEW tab within applicable applications, these tools provide a consistent set of inking options. For quick access, you can add specific inking tools to the Quick Access Toolbar located at the top of each application.

To make the most of the pen in Microsoft Windows, be sure to study the documentation that came with your system, including the Windows training tools and Tablet PC tutorial. You can access the Tablet PC Pen Training from the START menu by choosing ALL PROGRAMS, TABLET PC, and TABLET PC PEN TRAINING.

Note: The following workarounds in the Wacom tablet driver improve drawing performance in Windows 7 and Vista:

- The Pen Flicks and ‘press-and-hold-to-right-click’ features are disabled in graphics applications using the Wintab API.
- There is no pressure sensitivity in Journal and other Ink features when both the Flicks and ‘press-and-hold-to-right-click’ features are disabled in the Vista PEN AND INPUT DEVICES control panel.

* Pen features supported in all versions of Windows 7 and Vista except Windows 7 Starter and Home Basic, and Windows Vista Home Basic.





ABOUT THE WINDOWS TABLET PC INPUT PANEL

The Windows 7 or Vista Input Panel enables you to use handwriting or an on-screen keyboard to directly enter text with your Intuos4 pen. There are different ways to launch the Input Panel:

- Click on the Input Panel icon which appears when you move the screen cursor into a text entry area.
- Click on the Input Panel tab, located by default on the left edge of the display screen.
- Click on the Tablet PC Input Panel icon located on the Windows task bar. If the icon is not visible, right-click on the task bar, select TOOLBARS, and TABLET PC INPUT PANEL.

To customize the Input Panel:

1. First open the Input Panel and then click on TOOLS in the menu bar.
2. Select OPTIONS to open the Input Panel Options dialog box.
3. Customize the Input Panel settings for the way you like to work.

To learn more about using your Intuos4 pen in Microsoft Windows and Office 2007 or later, study the documentation that came with your system and Microsoft Office applications. Be sure to take advantage of the Windows training tools, including the Tablet PC tutorial, available from Microsoft.

You can also visit our web site at www.wacom.com/vista for more information on working with your Intuos4 pen in Windows.





PRODUCT SPECIFICATIONS

INTUOS4 WIRELESS TABLET (MODEL PTK-540WL)

Technology	Electro-magnetic resonance
Function display	128 x 64 dot (x2), white
Active area (W x D)	203.2 x 127 mm (8.0 x 5.0 in)
Physical size (W x D x H)	363 x 253 x 15 mm (14.3 x 10.0 x 0.6 in), approximately
Weight	900 g (2 lb), approximately (with battery)
Aspect ratio	16 : 10
Coordinate resolution	200 lpmm (5080 lpi)
Accuracy, pen	+/- 0.25 mm (0.010 in)
Accuracy, mouse	+/- 0.5 mm (0.020 in)
Tilt range (all pens)	+/- 60 degrees
Reading height	10 mm (0.39 in)
Maximum report rate	200 points per second, supported only on Bluetooth Specification v2.0 or later connections that support the EDR (Enhanced Data Rate) protocol.
ExpressKeys stroke	0.25 mm (0.01 in), approximately
Communication interfaces	Bluetooth wireless technology (Bluetooth 2.1 + EDR) USB
Connector	USB Type A to USB mini-B
USB cable length	2.5 m (8.2 ft)
Power requirements	DC 5V, less than 500 mA, from primary USB port or powered USB hub
Battery	Li-Ion battery pack, 3.7V, 1800 mAh
Connectivity	Bluetooth wireless technology using HID protocol
Operating temperature	5 to 40 degrees C (41 to 104 degrees F)
Battery charging temperature	5 to 35 degrees C (41 to 140 degrees F)
Storage temperature	-20 to +60 degrees C (-4 to 140 degrees F)
Operating relative humidity	30% to 80% non-condensing
Storage relative humidity	30% to 85% non-condensing
Certification and compliance	FCC15B Class B, FCC 15C, CE, VCCI Class B, ICES-003, RSS-210, NCC, BSMI, C-Tick, SRRRC, KCC, FAC, GOST-R, Japan Radio Law, RoHS, Chinese RoHS, Korean RoHS





INTUOS4 GRIP PEN (MODEL KP-501E-01)

Pen tip travel	1.0 mm (0.04 in) or less
Pressure levels	2048 levels
Eraser tip travel	2.0 mm (0.08 in), approximately
Physical size (L x D)	156.5 x 14.9 mm (6.17 x 0.59 in)
Weight	17 g (0.60 oz), approximately

INTUOS4 MOUSE (MODEL KC-100)

Physical size (L x D x H)	102.9 x 61.8 x 38.6 mm (4.05 x 2.43 x 1.52 in)
Weight	83 g (2.9 oz), approximately
Button stroke	Less than 1.3 mm (0.05 in), approximately
Fingerwheel type	Rotation, 24 steps per revolution

The mouse is an optional accessory, and product configurations may vary.

INTUOS4 AIRBRUSH (MODEL KP-400E-01)

Pen tip travel	0.2 mm (0.008 in) or less
Fingerwheel travel	10 mm (0.39 in)
Fingerwheel resolution	1024 levels, approximately
Pressure levels	2048 levels
Eraser tip travel	1.5 mm (0.06 in), approximately
Physical size (L x W x D)	162.5 x 17.5 x 32.5 mm (6.40 x 0.69 x 1.28 in)
Weight	23.0 g (0.81 oz), approximately

The Airbrush is an optional accessory.





INTUOS4 INKING PEN (MODEL KP-130-01)

Pen tip travel	0.2 mm (0.008 in) or less
Pressure levels	2048 levels
Physical size (L x D)	151.5 x 12.5 mm (5.97 x 0.49 in)
Weight	12 g (0.42 oz), approximately

The Inking Pen is an optional accessory.

INTUOS4 ART PEN (MODEL KP-701E-01)

Pen tip travel	1.0 mm (0.04 in) or less
Pressure levels	2048 levels
Eraser tip travel	2.0 mm (0.08 in), approximately
Barrel rotation	360 degrees
Physical size (L x D)	156.3 x 15.9 mm (6.16 x 0.63 in)
Weight	20 g (0.7 oz), approximately

The Art Pen is an optional accessory.

INTUOS4 CLASSIC PEN (MODEL KP-300E-01)

Pen tip travel	1.0 mm (0.04 in) or less
Pressure levels	2048 levels
Eraser tip travel	2.0 mm (0.08 in), approximately
Physical size (L x D)	150.7 x 12.2 mm (5.94 x 0.48 in)
Weight	12 g (0.42 oz), approximately

The Classic Pen is an optional accessory.





PRODUCT INFORMATION

To learn more about Intuos4, and about which software applications are currently tablet enhanced to support the pressure sensitivity, tilt sensitivity, eraser, and other special functionality of your professional pen tablet and tools, visit the Wacom web site for your region:

USA, Canada, Central and South America	http://www.wacom.com/productinfo
Europe, Middle East and Africa	http://www.wacom.eu
Japan	http://tablet.wacom.co.jp
Asia Pacific (English)	http://www.wacom-asia.com
China (Simplified Chinese)	http://www.wacom.com.cn
Korea	http://www.wacomkorea.com
Taiwan	http://www.wacom.com.tw
Thailand	http://www.wacom-thai.com

ORDERING PARTS AND ACCESSORIES

Your Intuos4 professional pen tablet is the ultimate master tool for creative professionals. The tablet, combined with your Intuos4 Grip Pen and other available Intuos4 tools, enables you to paint more intuitively, illustrate better, and edit imagery faster than ever before.

To expand the feature set of your Intuos4 product, look over the [available parts and accessories](#) described on the following pages. Please note that not all parts and accessories are available in all regions.

To purchase parts and accessories, refer to the tablet Read Me file and see who to call for your region. You can also do the following:

- To purchase parts and accessories in the USA or Canada, call 1.888.884.1870 (toll-free) or visit Wacom's web site at <http://www.WacomDirect.com> (USA only).
- To purchase parts and accessories in Europe, call +49 (0)180.500.03.75 or send an email to spareparts@wacom.eu. Or, visit <http://shop.wacom.eu>. You can also contact your local dealer, distributor, or technical support using the appropriate number for your region.
- To purchase parts and accessories in Australia, Singapore, Taiwan and Korea, please visit: www.BuyWacom.com.au, www.BuyWacom.com.sg, www.BuyWacom.com.tw and www.BuyWacom.co.kr, respectively.
- To purchase parts and accessories in other countries, please contact your local dealer or distributor.



AVAILABLE PARTS AND ACCESSORIES



Intuos4 Grip Pen (KP-501E-01). Sensitive to pressure and tilt, the Grip Pen is an all-purpose tool for drawing, erasing, and mouse operations. The easy-to-use DuoSwitch gives you two programmable switch functions. The pressure-sensitive pen has an ergonomically waisted grip area, optimum weight and balance, and superior tip sensitivity, making it the most natural freehand tool. Includes the following accessories: Pen stand, standard nib (qty 1), stroke nib (qty 1), hard felt nib (qty 1), and flex nib (qty 1).

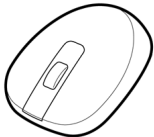

[Intuos4 Mouse](#) (KC-100). Cordless and battery free, the five button mouse is an ideal tool for performing any task you may have done previously with a standard mouse. It includes an integrated middle button and rolling fingerwheel that can be used for up and down scrolling, or the button can be programmed for a variety of other actions.



Intuos4 Airbrush (KP-400E-01). A true digital airbrush, the pressure-sensitive [Intuos4 Airbrush](#) incorporates a pressure-sensitive tip and eraser, tilt sensitivity, and a fingerwheel that provides an additional degree of control over the application of digital paint. Includes the following accessories: Pen stand, standard nib (qty 1), stroke nib (qty 1), hard felt nib (qty 1), and flex nib (qty 1).

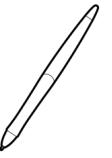

Intuos4 Inking Pen (KP-130-01). This pressure- and tilt-sensitive drawing pen was created to provide immediate feedback at your pen tip on the drawing as well as on your computer screen. The pressure-sensitive Inking Pen comes with inking cartridges and two polyacetal tips for inkless drawing. It has a pressure-sensitive tip, but no eraser and no side switches. Includes the following accessories: Pen stand, standard nibs (qty 2), inking nibs (qty 3).

Note: When you purchase an Inking Pen, it comes with a polyacetal nib in the pen. Use the nib extractor (silver ring) to gently remove the polyacetal nib from the pen. Then insert one of the silver-colored cartridges that come with the Inking Pen. The cartridge tip has a waxy coating that you will need to rub off before you can begin inking.

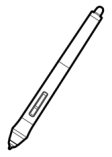

Intuos4 Art Pen (KP-701E-01). This specialty pen provides 360 degrees of barrel rotation and, like the Intuos4 Grip Pen, is pressure and tilt sensitive. Combining these features with a unique chisel-shaped nib makes the Intuos4 Art Pen the most realistic tool for emulating brushes, markers, and calligraphic pens. Includes the following accessories: Pen stand, chisel tipped nibs (qty 2), chisel tipped felt nibs (qty 2), bullet tipped nibs (qty 3), and bullet tipped felt nibs (qty 3).

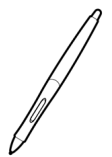

Intuos4 Classic Pen (KP-300E-01). This pen has the same feature set as the Intuos4 Grip Pen, but with a slimmer profile that does not include a rubberized grip. Includes the following accessories: Pen stand, standard nib (qty 1), stroke nib (qty 1), hard felt nib (qty 1), and flex nib (qty 1).





DESCRIPTION	PART NUMBER
Replacement nibs for Grip Pen, Airbrush, or Classic Pen	
Standard nib – firm, plastic nib, black, qty 5	ACK-20001
Stroke nib – spring loaded nib, more of a “brush-like” feel, qty 5	ACK-20002
Felt nib – softer nib for a “pencil or marker on paper” feel, qty 5	ACK-20003
Flex nib – a flexible, elastomeric nib, that provides a “higher friction” feel, qty 5	ACK-20004
Felt nib, chisel tip, qty 5	ACK-20005
Nib set, for Art Pen	ACK-20006
Pen grip, standard for pen use without side switch	ACK-30003
Pen grip, thick bodied grip for pen use without side switch.	ACK-30002
Intuos4 Grip Pen accessory kit.	ACK-40001
Tablet battery (Li-Ion)	ACK-40203
Personalization rings, for Grip Pen	FUZ-A157
Tablet surface sheet replacements	
Medium, standard	ACK-10221
Medium, clear	ACK-10222

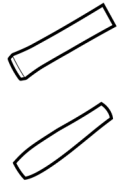

For order information, see [ordering parts and accessories](#).





RADIO AND TELEVISION INTERFERENCE

The equipment described in this manual generates, uses, and can radiate radio-frequency energy. If it is not installed and used properly—that is, in strict accordance with Wacom instructions—it may cause interference with radio and television reception.

FCC NOTICE

This device complies with Part 15 of the FCC Rules. Operation is subject to the following two conditions: (1) this device may not cause harmful interference, and (2) this device must accept any interference received, including interference that may cause undesired operation.

This equipment has been tested and found to comply with the limits for a Class B digital device, pursuant to Part 15 of FCC Rules. These limits are designed to provide reasonable protection against harmful interference in a residential installation.

This equipment generates, uses and can radiate radio frequency energy and, if not installed and used in accordance with the instructions, may cause harmful interference to radio communications. However, there is no guarantee that interference will not occur in a particular installation.

You can determine whether the equipment is causing interference by disconnecting it from your computer. If the interference stops, it was probably caused by the equipment.

If the equipment does cause interference to radio or television reception, you may be able to correct the interference by using one or more of the following measures:

- Rotate the television or radio antenna until the interference stops.
- Move the equipment farther away from the television or radio.
- Plug the equipment and computer into an outlet that is on a different circuit from the television or radio.

If necessary, consult your Wacom dealer or an experienced radio/television technician for help.

Changes or modifications to this product not authorized by Wacom could void the FCC Certification and negate your authority to operate the product.

FCC RF Radiation Exposure Statement:

This equipment complies with FCC radiation exposure limits set forth for an uncontrolled environment. End users must follow the specific operating instructions for satisfying RF exposure compliance. This equipment must not be co-located or operating in conjunction with any other antenna or transmitter.

See also [Industry Canada \(Canada only\)](#) and [CE declaration](#).





INDUSTRY CANADA (CANADA ONLY)

Industry Canada, Class B

“This Class (B) digital apparatus complies with Canadian ICES-003”

“Cet appareil numérique de la classe (B) est conforme à la norme NMB-003 du Canada.”

CE DECLARATION

The Intuos[®] 4 Wireless digitizing tablet, model PTK-540WL, has been tested and found to comply with the following harmonized European Norms:

- EN 55022: 2006/A1:2007
- EN61000-3-2: 2006
- EN61000-3-3: 1995/A1:2001/A2:2005
- EN55024: 1998/A1:2001/A2:2003
 - EN 61000-4-2:1995/A1:1998/A2:2001
 - EN61000-4-3:2006
 - EN61000-4-4:2004
 - EN61000-4-5:2006
 - EN61000-4-6:2007
 - EN61000-4-8:1993/A1:2001
 - EN61000-4-11:2004
- EN 60950-1: :2006
- EN 300 328 :V1.7.1
- EN 301 489-1:V1.8.1,-17:V2.1.1

Based on the results of these tests, Wacom declares that the above mentioned devices conform to Article 10.1 of the European Council EMC Directive 2004/108/EC, LVD Directive 2006/95/EC and to the R&TTE Directive 1999/5/EC and indicates this conformity by the CE-sign on each device.

The device must be installed and operated always in strict accordance with the instructions given in this handbook.

Any changes or modifications to this product that were not specifically authorized by Wacom will invalidate this declaration.





PRECAUTIONS

[Warnings](#)

[Safety precautions for Lithium-Ion batteries](#)

[Cautions](#)

WARNINGS

- Do not place or leave the pen tablet or input tool(s) within reach of children. If your product is used improperly there is a potential for accident or human injury. Prevent children from swallowing the pen nib or side switch. The pen nib, side switch, or other movable parts may accidentally be pulled out if children are biting on them. Small parts, such as the pen nib or nib refills, pen side switch, or tablet pen stand, can be removed and accidentally swallowed by children.
- Do not use the pen tablet in a facility control system that requires extremely high reliability. It may cause other electronic devices to malfunction, or other devices may cause the pen tablet to malfunction.
- Power off your pen tablet in locations where/when electronic devices are not allowed. Because the pen tablet may cause other electronic devices to malfunction in some locations where/when the use of electronic devices is not allowed, such as within an airplane, be sure to turn off the pen tablet by moving the power switch to the off position. For added security, turn off Bluetooth.
- Do not disassemble the pen tablet or input tool(s). Do not disassemble or otherwise modify the pen tablet or input tool(s). Such action may cause heat generation, ignition, electrical shock, or other damage, including human injury. Disassembly of the product will void your warranty.
- Take note of damaged cabling. If you notice that your pen tablet cabling is torn or otherwise damaged, there is a potential for product malfunction, electrical shock, or fire. Stop using the product and contact your local distributor or the Wacom customer support center for your region.
- Do not expose this product to water or other liquids. Take care to never spill liquids onto the pen tablet or input tool(s). Exposing this product to water or other liquids may cause product malfunction or electrical shock. If the product is exposed to water or other liquids, turn tablet off by moving the power switch to the off position. If your product is equipped with a power cord, unplug the cord from the wall outlet. When the tablet is connected using the supplied USB data cable, unplug the USB connector. Power down your computer. Then disconnect any other cables that may remain between the pen tablet and your computer. Remove the tablet battery. Stop using the product and contact your local distributor or the Wacom customer support center for your region.
- Do not insert foreign material into the USB port or any other opening of this product. If a metal object or foreign material is inserted into a port or other opening of this product, it may cause the product to malfunction or burn out, or cause electrical shock.

See also [safety precautions for Lithium-Ion batteries](#) and [cautions](#).





SAFETY PRECAUTIONS FOR LITHIUM-ION BATTERIES

Always follow proper use and handling of the tablet battery:

- Do not abuse the battery in any manner. Puncturing, crushing, heating, exposure to water or fire, disassembly, shorting the terminals, or other types of abuse may cause the battery to explode or ignite, and potentially cause a fire or personal injury.
- Use only the correct battery provided by Wacom and be careful not to drop it on hard surfaces. The battery can be damaged internally when dropped, and should be replaced even if there is no obvious damage. This will help prevent any future damage that could occur to the tablet if the battery has been dropped, is installed in the tablet, and then later develops a short or leak while in the tablet.
- Do not use a battery that is visibly deformed in any manner. A deformed battery has the potential to rupture, or generate heat, smoke, or fire.
- Do not attempt to install the battery backwards or reverse the polarity. If you do so, you may damage the tablet, cause a fire, or personal injury may result.
- Only use a Wacom battery specified for your tablet. NEVER attempt to use or charge other battery types in your tablet. Doing so may damage the tablet, cause a fire, or personal injury may result. Doing so will also void your warranty.
- Do NOT attempt to charge the tablet battery with any power adapter that does not meet the specifications required for your Intuos4 tablet. Doing so may damage the tablet, cause a fire, or personal injury may result. Doing so will also void your warranty. You can charge the tablet by connecting it (using the provided USB cable) to any powered USB port.
- Do not overcharge the tablet battery. Doing so may damage the tablet, cause a fire, or personal injury may result.
- If you will be traveling with your wireless tablet, be sure to check with the appropriate regulatory authority for any air or travel restrictions that may apply to Lithium-Ion batteries.
- If the tablet becomes excessively warm or emits an unusual smell while the battery is charging, immediately disconnect the USB cable (if in use) and shut down the tablet. The same applies if the tablet is connected to an after-market power adapter. Contact Wacom Technical Support for assistance (see [technical support options](#)).
- If a Li-Ion battery is discharged below a certain minimum charge, it cannot be recharged. An internal protection circuit within the battery prevents any charging once the voltage has fallen below a minimum safety level.
- Properly recycle the old battery in accordance with the battery manufacturer recommendations, and follow any applicable warnings.
- Keep batteries out of the reach of children, and promptly recycle old batteries.
- When recycling the Li-Ion battery, do not carry it loosely in your pocket or in any container that may contain metal objects. If transported improperly and metal objects come in contact with the battery terminals, the battery could short, causing personal injury or fire. It is recommended that you cover the terminals with adhesive tape to insulate them from possible contact with metal objects.
- If the battery should leak, do not get the fluid in your eye. If battery fluid does enter the eye, do not rub the eye. Immediately rinse the affected eye with water and seek medical attention.

See also [warnings](#) and [cautions](#).





CAUTIONS

- Do not place or use this product on an unstable surface or workspace. Do not place this product on a shaky, inclined, or vibrating surface. It may drop or fall off, causing damage to the product or human injury.
- When cleaning your pen tablet, power off the unit by moving the power switch to the off position and unplugging the USB connector from between the pen tablet and your computer. Electrical shock may occur if you attempt to clean this product when it is connected to your computer or to an after-market power adapter.
- Do not apply heavy stress to the pen tip, eraser, or side switch. It may shorten pen tip life or may cause the pen to malfunction.
- If a distorted or bent pen nib is used, the pen tool may operate improperly. Therefore, do not apply excessive force when using the pen.
- Using a pen nib other than one specifically designed by Wacom for your pen input tool may cause product malfunction.
- Do not place metal objects on this product when it is in use. Metal objects placed on the pen tablet during use may cause interference, improper operation, or product malfunction.

See also [warnings](#) and [safety precautions for Lithium-Ion batteries](#).





LICENSE AND WARRANTIES

(WORLDWIDE, EXCEPT FOR EUROPE, AFRICA AND MIDDLE EAST)

SOFTWARE LICENSE

This legal document is an agreement between you, the end-user, and Wacom Technology Corporation (Wacom).

1. Grant of License. The enclosed product includes computer programs embedded in firmware and accompanying diskette or CD-ROM (the "Software"). The Software is licensed, not sold, to you for use only with Wacom products upon the terms of this license, and Wacom reserves any rights not expressly granted to you. Wacom grants to you a non-exclusive right to use this copy of the Software in conjunction with a Wacom product at a single location.
2. Ownership of Software. Although you may own the product in which the Software is originally recorded, Wacom retains ownership of the Software itself. You acknowledge that the Software is Wacom's property, and contains valuable confidential, unpublished information developed or acquired by Wacom at great expense, including data processing algorithms, innovations and concepts. The Software is protected by copyright and other federal and state laws. You agree to use your reasonable best efforts to protect the Software from unauthorized reproduction, distribution, disclosure, use, or publication.
3. Copy Restrictions. Unauthorized copying of the Software is expressly forbidden.
4. Use Restrictions. You may not decompile, reverse assemble, disassemble or reverse engineer the Software.
5. Termination. This License is effective until terminated. This License will terminate automatically without notice from Wacom if you fail to comply with any provisions of the License.
6. Miscellaneous. This License is governed by the laws of the United States of America and the state of Washington except in Asia Pacific and by the laws of Japan for Asia Pacific.

LIMITED WARRANTY

Wacom warrants the product, to the original consumer purchaser, except for the Software and consumable items such as the battery and pen nibs, to be free from defects in materials and workmanship under normal use and service for a period of two (2) years, from the date of original retail purchase, as evidenced by a copy of the receipt and registration with Wacom within 30 days of purchase.

The Software is licensed "as is." Wacom makes no warranty with respect to its quality or performance. Wacom cannot guarantee you uninterrupted service or the correction of any errors.

Upon discovery of a defect in the product, except in the Software, within the Warranty Period, you should contact Wacom Technical Support via telephone, email, or fax to obtain an RMA (Return Merchandise Authorization) number and instructions for shipping the product to a service location designated by Wacom. You should send the product, shipping charges prepaid, to the designated service location, accompanied by the return authorization number, your name, address and telephone number, proof of purchase date, and a description of the defect. Wacom will pay for return shipping by United Parcel Service or by an equivalent service as chosen by Wacom.

Wacom's sole obligation and entire liability under this warranty shall be, at Wacom's option, either the repair or replacement of the defective product or parts thereof of which Wacom is notified during the Warranty Period; provided, however, that you are responsible for (i) the cost of transportation of the product to the designated service location and (ii) any loss or damage to the product resulting from such transportation.





Wacom shall have no responsibility to repair or replace the product if the failure of the product has resulted from accident, abuse, misuse, negligence, or unauthorized modification or repair, or if it has been handled or stored other than in accordance with Wacom's storage instructions.

Any descriptions, drawings, specifications, samples, models, bulletins, or similar material, used in connection with the sale of the product, shall not be construed as an express warranty that the product will conform or comply with your requirements.

EXCEPT FOR THE LIMITED WARRANTY DESCRIBED ABOVE, THERE ARE NO OTHER WARRANTIES MADE BY WACOM ON THIS PRODUCT. NO ORAL OR WRITTEN INFORMATION OR ADVICE GIVEN BY WACOM, ITS DEALERS, DISTRIBUTORS, AGENTS, OR EMPLOYEES SHALL CREATE A WARRANTY OR IN ANY WAY INCREASE THE SCOPE OF THIS WARRANTY, AND YOU MAY NOT RELY ON ANY SUCH INFORMATION OR ADVICE. THIS WARRANTY GIVES YOU SPECIFIC LEGAL RIGHTS, AND YOU MAY ALSO HAVE OTHER RIGHTS WHICH VARY FROM STATE TO STATE.

WACOM LIMITS THE DURATION OF ANY LEGALLY IMPLIED WARRANTIES INCLUDING IMPLIED WARRANTIES OF MERCHANTABILITY OR FITNESS FOR A PARTICULAR PURPOSE, TO THE DURATION OF WACOM'S EXPRESS WARRANTY. SOME STATES DO NOT ALLOW LIMITATIONS ON HOW LONG AN IMPLIED WARRANTY LASTS, SO THE ABOVE LIMITATION MAY NOT APPLY TO YOU.

NEITHER WACOM NOR ANYONE ELSE WHO HAS BEEN INVOLVED IN THE CREATION, PRODUCTION, OR DELIVERY OF THIS PRODUCT SHALL BE LIABLE FOR ANY DIRECT, CONSEQUENTIAL, OR INCIDENTAL DAMAGES (INCLUDING DAMAGES FOR LOSS OF BUSINESS PROFITS, BUSINESS INTERRUPTION, LOSS OF BUSINESS INFORMATION AND THE LIKE) ARISING OUT OF THE USE OF OR INABILITY TO USE SUCH PRODUCT, EVEN IF WACOM HAS BEEN ADVISED OF THE POSSIBILITY OF SUCH DAMAGES. SOME STATES DO NOT ALLOW THE EXCLUSION OR LIMITATION OF INCIDENTAL OR CONSEQUENTIAL DAMAGES, SO THE ABOVE LIMITATION OR EXCLUSION MAY NOT APPLY TO YOU.

In the event that any of the above limitations are held unenforceable, Wacom's liability for any damages to you or any party shall not exceed the purchase price you paid, regardless of the form of any claim.

This Limited Warranty is governed by the laws of the United States of America and the state of Washington.

This Limited Warranty is valid for and only applies to products purchased and used inside the United States (and its territories or possessions) and Canada.

WARRANTY SERVICE IN THE U.S.A. AND CANADA

To obtain Warranty service within the U.S. or Canada contact:

Wacom Customer Care Center

Phone: 1.360.896.9833

Email Inquiry form: <http://www.wacom.com/productsupport/email.cfm>





WARRANTY ON SALES OUTSIDE OF THE U.S.A. AND CANADA

For products purchased or used outside of the United States and Canada, the warranty period is one (1) year from the date of original retail purchase. Upon discovery of a defect in the product, except in the Software, within the Warranty Period you should contact your local dealer or distributor. In all other respects the terms of the warranty as set forth above apply to such sales.

Wacom Technical Support in Asia Pacific (except Japan and China)

Detailed Asia Pacific Limited Warranty policy and product registration may be found online at <http://www.wacom-asia.com>

To obtain technical support or Warranty service within Southeast Asia, Oceania and Taiwan, please contact the Wacom Customer Support Service.

Phone numbers can be found here: <http://www.wacom-asia.com/support/contact>

Should you have any questions about this Agreement, or if you desire to contact Wacom for any reason, please contact in writing:

IN NORTH AND SOUTH AMERICA CONTACT:

Wacom Technology Corporation
1311 SE Cardinal Court
Vancouver, Washington 98683
U.S.A.

IN JAPAN CONTACT:

Wacom Co., Ltd.
2-510-1 Toyonodai
Otone-Machi, Kitasaitama-Gun
Saitama, 349-1148
Japan

IN ASIA PACIFIC CONTACT:

Wacom Co., Ltd.
Harmony Tower 18F, 1-32-2 Hon-Cho,
Nakano-Ku, Tokyo 164-0012
Japan

IN MAINLAND CHINA (EXCEPT HONG KONG) CONTACT:

Wacom China Corporation
Unit 2807, 28th Floor, SK Tower,
No 6 Jia, Jianguomenwai Avenue,
Beijing, 100022, China
E-mail: support@wacom.com.cn





LICENCE WARRANTY CONDITIONS

(EUROPE, AFRICA AND MIDDLE EAST)

SOFTWARE LICENCE AGREEMENT

Important customer information

The scope of delivery of this product covers copyright-protected computer programs ("software"), which are the inalienable intellectual property of WACOM Europe GmbH ("WACOM"). This software is an integral component of the product and is also held on the associated data carrier. The software of WACOM and the associated rights of use are not included with the purchase of this product from your retailer. WACOM grants you-the user-the right to use the software exclusively in accordance with the conditions stipulated in this licence agreement. By purchasing this product, you agree to the following licence conditions.

Conditions for using the software

WACOM issues the user with a personal, non-exclusive licence to use the software solely in connection with this product and for the correct operation of the product. This licence may only be assigned to a third party in connection with this product.

Use of this software includes the creation of permanent or temporary copies of the software by means of loading, displaying, exporting, transferring or saving, for the purposes of exporting the commands and the data they contain or for observing, researching or testing the software functions.

The customer may not license the software to a third party, lease, lend or in any other way provide access to the software. The customer may not copy, change, transfer or edit the software without prior written agreement from WACOM. The only exceptions to this are necessary procedures for creating a back-up copy and the scenarios outlined in section 2.

The customer may not carry out any "reverse engineering", decompile or depacketise the software, or try by any other means to discover the source code of the software. This restriction shall continue to apply after the termination of this agreement. If the software contains interfaces to other programs that are not supported by WACOM, WACOM shall provide the customer with the necessary information on request, as long as the customer can prove his right to use the software and agrees to bear the copying and postage costs.

WACOM AND ITS SUPPLIERS CANNOT OFFER ANY GUARANTEE FOR THE PERFORMANCE OF THE SOFTWARE OR FOR THE RESULTS PRODUCED THERE FROM. WACOM AND ITS SUPPLIERS OFFER NO GUARANTEES OR ASSURANCES (EITHER EXPRESSLY OR IMPLICITLY, INCLUDING THOSE THAT MAY BE DERIVED FROM A BUSINESS RELATIONSHIP OR FROM TRADE PRACTICE, OR FROM LEGAL PROVISIONS OR CUSTOMARY LAW) WITH REGARD TO THE MARKETABILITY, FREEDOM FROM DEFECTS OF TITLE OR USEFULNESS OF THE SOFTWARE.

WACOM AND ITS SUPPLIERS ACCEPT NO LIABILITY FOR DAMAGES, CLAIMS OR COSTS OF ANY KIND, NOR FOR CONSEQUENTIAL DAMAGES, SECONDARY, ACCIDENTAL, INDIRECT OR PENAL DAMAGES, PARTICULAR OR MISCELLANEOUS DAMAGES OR FOR DEMANDS OR INDEMNITY CLAIMS FOR REDUCED PROFITS OR LOSSES. THIS SHALL ALSO APPLY IN THE CASE OF A REPRESENTATIVE OF WACOM BEING PREVIOUSLY AWARE OF THE POSSIBILITY OF SUCH LOSSES, DAMAGES, CLAIMS OR COSTS, OR DEMANDS FROM THIRD PARTIES.





The existing limitations on liability shall not apply in the case of the assumption of explicit guarantees, or in case of fraudulent behaviour on the part of WACOM, nor for damages arising from wilful or grossly negligent behaviour on the part of WACOM, from damages leading to loss of life, personal injury or sickness or in the case of binding legal provisions. For slight negligence, WACOM and its suppliers shall only be liable in the event of a breach of essential contractual obligations. Liability when such an essential contractual obligation is breached is, however, limited to damages typical to this type of contract, which WACOM must have determined at the conclusion of the contract based on the known risks and circumstances at that time. Claims for reduced profits or expenses saved, indemnity claims from third parties or claims for any other direct or consequential damages still cannot be asserted in this case.

The laws of the Federal Republic of Germany shall apply to this agreement. However, the applicability of the United Nations Convention on Contracts for the International Sale of Goods is explicitly excluded. Krefeld is the sole place of jurisdiction for all claims arising from this contractual relationship and all disputes between the parties resulting from the formation, handling or termination of the contractual relationship, provided that the customer is a trader, a legal entity under public law or a special fund under public law.

The jurisdiction agreement shall also apply for customers who do not have a general place of jurisdiction in Germany. The jurisdiction agreement shall not apply if, due to legal provisions, a different sole place of jurisdiction must be established for the case. Furthermore, WACOM is authorised to file a lawsuit against the headquarters of the customer.

This licence constitutes the entire contractual agreement between the parties. It overrides all other verbal and written contracts and agreements and may only be altered by means of a written and signed contract. Should one of the provisions of these licence conditions be or become void, the validity of the other provisions shall not be affected, in full or in part. Should a provision be invalid, the legally permissible regulation most closely resembling the invalid regulation shall apply in its place.

LIMITED WARRANTY

WACOM guarantees to you, as the initial purchaser, that the product hardware, when used as intended, will remain free from material defects and processing errors for a warranty period of TWO (2) YEARS and Cintiq products shall be guaranteed for a warranty period of THREE (3) YEARS, commencing from the purchase date and provided that the product was unused at the time of purchase. Defects in wear parts (e.g. pen tips) resulting from normal wear and tear are exempt from the warranty. Furthermore, WACOM guarantees that the data carriers delivered with the product are free from material defects and processing errors for a period of SIX (6) MONTHS from the date of purchase.

If the product-excluding any software-is discovered to be faulty it must be returned immediately to the place of purchase in its original packaging within the warranty period together with your name, address and telephone number, a description of the problem and a copy of the original receipt. The customer shall be liable for any possible damage or loss of the product during transit for this purpose. Under the provisions of this warranty, WACOM only undertakes to repair or replace the faulty product or parts at its own discretion, in cases where defects are proven and the product is sent within the warranty period.

WACOM is not obligated to repair or replace the product if: (a) the damage to the product results from any accident, misuse, improper use, negligence or unauthorised alteration or repair; (b) the product was not handled or stored according to the instructions provided by WACOM; (c) the damage resulted from normal wear and tear; or d) the serial number affixed by WACOM has been removed or rendered unintelligible.

If, when a claim made under this warranty is checked, it emerges that it is outside the permitted time period or is not covered by the warranty or that the product is not faulty, the costs of any checks or repairs must be borne by the customer.





Any descriptions, drawings, specifications, samples, models, notifications or similar material provided in connection with the purchase of the product cannot be taken as an explicit guarantee that the product corresponds to or fulfils the customer's requirements.

If this product is faulty, the purchaser shall be entitled to assert legal claims against the vendor for liability due to defects. These legal rights against the vendor are not limited by the existing warranty. The warranty grants the customer many additional rights under the conditions stipulated in this text.

This limited warranty shall apply if the registered office of the vendor is in the EU or in Iceland, Norway, Jersey, Switzerland, Russia, Ukraine, Croatia, Serbia, Tunisia, Turkey, Syria, Lebanon, Jordan, Israel, Egypt, United Arab Emirates, Iran or South Africa.

The granting of this limited warranty is subject to the laws of the Federal Republic of Germany. However, the applicability of the United Nations Convention on Contracts for the International Sale of Goods is explicitly excluded. Krefeld is the sole place of jurisdiction for all claims arising from this contractual relationship and all disputes between the parties resulting from the formation, handling or termination of the contractual relationship, provided that the customer is a trader, a legal entity under public law or a special fund under public law.

The jurisdiction agreement shall also apply for customers who do not have a general place of jurisdiction in Germany. The jurisdiction agreement shall not apply if, due to legal provisions, a different sole place of jurisdiction must be established for the case. Furthermore, WACOM is authorised to file a lawsuit against the headquarters of the customer.

Should one of the provisions of these limited warranty conditions be or become void, the validity of the other provisions shall not be affected, in full or in part. Should a provision be invalid, the legally permissible regulation most closely resembling the invalid regulation shall apply in its place.

If you have any questions about this agreement, or would like to contact WACOM for another reason, please contact us by post at this address:

WACOM Europe GmbH
Europark Fichtenhain A9
47807 Krefeld
GERMANY





GLOSSARY

Active area. The drawing area of the tablet where your Intuos4 tools are detected.

Application-specific settings. Intuos4 tool and tablet settings that have been customized for individual applications. The Wacom Tablet control panel enables you to customize a tool to behave uniquely in different applications. [Application-specific settings](#) are in effect whenever you use the application.

Aspect. The ratio between the vertical and horizontal dimension of the tablet or display.

Bluetooth. A standardized wireless technology and Specification. Manufacturers build Bluetooth wireless technology into their products in order to create Bluetooth enabled devices, providing seamless voice and data connections between a variety of wireless devices operating at short range to one another.

Click force. The amount of force you must apply to the pen tip for a click to occur.

Digital Ink. A broad category that typically describes handwritten content which has been created using pen-based input on a computer. This handwritten content takes the form of sketches, ink mark-up, or handwriting. The handwriting can optionally be converted to typewritten text or simply left alone for use in its original format. Depending on your system and applications settings, the handwritten text you make with digital ink can be converted on-the-fly or at another time.

Discoverable mode. An operational state in which a Bluetooth enabled device is available for discovery by another Bluetooth enabled device.

Display Toggle. An Intuos4 feature that allows you to work with your tablet on all displays or on one display at a time. Available only on multiple monitor systems. See [working with Display Toggle](#) for more information.

Double-click assist. A function of the Wacom Tablet control panel that makes it easier to double-click by setting the size of the double-click distance.

Double-click distance. The maximum distance (in screen pixels) that the cursor can move between clicks and still be accepted as a double-click. Increasing the double-click distance makes double-clicking easier, but may cause a delay in brush strokes in some graphics applications.

Double-click speed. The maximum time that can pass between clicks and still be accepted as a double-click.

Eraser-aware application. A software application that has built-in support for the Intuos4 eraser. These applications take advantage of the eraser in different ways, depending on what makes sense for the application.

ExpressKeys. The customizable control keys located on your professional pen tablet.

ExpressKeys Left. A tablet ORIENTATION setting where the Touch Ring and ExpressKeys are oriented to the left of the tablet.

ExpressKeys Right. A tablet ORIENTATION setting where the Touch Ring and ExpressKeys are oriented to the right of the tablet.





Fingerwheel. The control wheel on the Intuos4 Mouse and optional Airbrush.

Journal. A Microsoft Windows application that electronically simulates a physical journal pad, but with the advantages of digital note taking. For example, you can create quick sketches and jot handwritten notes that can be converted to text and sent on to colleagues for digital mark-up. Journal includes a variety of pen, marker, and highlighter tools, plus an eraser that is easily activated by the eraser of your Intuos4 pen. Additionally, your handwritten content is searchable within Journal.

Mapping. The relationship between your Intuos4 tool position on the tablet and the cursor position on the monitor screen.

Modifier. Modifier keys include SHIFT, ALT, and CTRL for Windows, or SHIFT, CONTROL, COMMAND, and OPTION for Macintosh. You can customize your Intuos4 tool to simulate a modifier key.

Mouse acceleration. A setting that allows you to adjust the screen cursor acceleration when your Intuos4 tool is in MOUSE MODE.

Mouse mode. A method for positioning the screen cursor. When you place an Intuos4 tool on the tablet, you can move the screen cursor with a “pick up and slide” motion similar to using a traditional mouse. This is known as relative positioning, and is the default setting for the Intuos4 Mouse. See also pen mode.

Mouse speed. A setting that allows you to adjust the speed at which your screen cursor moves when your Intuos4 tool is in MOUSE MODE.

Nib. The replaceable pen tip.

OLED. Organic Light Emitting Diodes (OLEDs) are made up of semi-conductor polymers. OLEDs do not need a background lighting to function, and thus have a lower power consumption and can be much thinner than LCD panels.

Pairing. A method of creating a virtual cable link between two Bluetooth enabled devices. Pairing is the process whereby Intuos4 and the computer discover one another for the “first” time.

Pen mode. A method of positioning the screen cursor. Wherever you place your Intuos4 tool on the tablet, the screen cursor will appear at the corresponding point on the screen. This is known as absolute positioning, and is the default setting for all Intuos4 pen tools. Also, PEN MODE allows you to quickly position the screen cursor without having to first find it and then move it across the desktop. See also mouse mode.

Pixel. The smallest unit of measure on your monitor screen.

Pressure sensitive. A quality of the Intuos4 pen tip and eraser that senses the amount of pressure being applied. This is used to create natural-looking pen, brush, and eraser strokes in applications that are pressure sensitive.

Pressure-sensitive application. Any application that supports pressure-sensitive input.

Proximity. The height above the tablet’s [active area](#) where the Intuos4 tools are detected. See also [positioning](#).





Radial Menu. A hierarchical menu (in radial format). Each level of the menu consists of eight menu slices which may contain various features and options to choose from. You can customize the buttons of your Intuos4 tools or tablet to display this menu.

Screen cursor. The pointer on the display screen. Screen cursors come in different shapes (such as an I-beam, arrow, or box), depending on which application you are running.

Tablet PC Input Panel (TIP). The Microsoft Windows Tablet PC Input Panel enables you to use your Intuos4 pen to create handwritten notes or work with an on-screen keyboard. The Input Panel dynamically converts your handwriting to text. Information you create can then be inserted into other documents, spreadsheets, or illustrations. See [pen and digital ink capabilities in Windows](#).

Tilt sensitive. A quality of the Intuos4 pen tip and eraser that senses the amount of tilt between the tool and tablet. This is used to create natural-looking pen, brush, and eraser strokes in applications that are tilt sensitive.

Tool ID. A unique serial number in each Intuos4 tool. Some graphics applications, such as Corel Painter, recognize Tool IDs and allow you to assign different settings and brushes to every Intuos4 tool (e.g., two Grip Pens). Switching between the settings and brushes then becomes as easy as switching between the two pens.

Touch Ring. The customizable control ring located on your professional pen tablet.

Transceiver. A radio device capable of both transmitting and receiving information.

USB. Universal Serial Bus. A hardware interface standard for connecting computer peripheral devices. USB ports support hot-plugging, which allows you to disconnect a USB device without turning off your computer.

Wintab. An interface standard used by Windows applications for receiving tablet information. Intuos4 supports all Wintab-compatible applications under Windows.





INDEX

About the manual	6	Control panel	
Accessories and parts		features	34
available	97	lists	35
ordering	96	opening	33
Active area, understanding	21	tabs	35
Adding a new tool	60	Customizing	
Airbrush		double-click	38
holding	90	eraser feel	39
replacing the tip	84	advanced	39
using	90	ExpressKeys	44
applications, using integrated	88	mouse	41
Application-specific settings	61	buttons	42
changing	62	fingerwheel	42
creating	62	pen	37
removing	62	Radial Menu	57
Art Pen, using	90	tablet	43
Battery		ExpressKeys	44
activation	11	Touch Ring	45
charging	11	tablet to screen mapping	46
life, information	82	tilt sensitivity	41
management	10	tip feel	38
replacing	83	advanced	39
status light	14	tool buttons	40
warnings	102	Touch Ring	45
Bluetooth connection, optimizing	18	Diagnostics	66
Button functions	51	Display Toggle, working with	58
Care, for tools and tablet	83	Double-click, customizing	38
Cautions	103	Double-clicking, how to	26
CE declaration	100	Dragging, with pen	26
Clicking, how to	26	Drawing	
Connecting wirelessly	15	with pressure sensitivity	28
Connection		with tilt	28
optimizing	18	Driver downloads, obtaining	80
problems, troubleshooting	70	Environmental conditions	83
USB	18	Eraser feel	
Connection light	14	advanced	39
		customizing	39





Erasing	29	Ordering parts and accessories	96
Ergonomics	19	Orientation, tablet	48
ExpressKeys		physical configuration	20
customizing	44	Parts and accessories	
display optimization	88	available	97
testing	68	ordering	96
using	31	Pen	
Eye-hand coordination exercise	29	clicking with	26
FCC notice	99	customizing	37
Features		double-clicking with	26
control panel	34	dragging with	26
pen	10	drawing	
power saving	13	with pressure sensitivity	28
tablet	8	with tilt	28
Fingerwheel, mouse, using	89	erasing with	29
Force proportions	50	features	10
Functions, button	51	holding	24
General problems, troubleshooting	72	pointing with	25
Holding		positioning with	25
Airbrush	90	replacing the tip	84
pen	24	side switch	27
Industry Canada notice	100	testing	67
Information, product	96	tip, replacing	84
Installing		using	23
multiple tablets	86	Pen Mode	46
tablet	81	Pointing, with pen	25
Linking, to computer	16	Positioning, with pen	25
Macintosh-specific problems, troubleshooting	77	power management	10
Mapping to multiple monitors	22	Precautions	101
Mouse		battery warnings	102
buttons, customizing	42	Cautions	103
customizing	41	Warnings	101
fingerwheel		Preferences, managing tablet	85
customizing	42	Pressure sensitivity, drawing with	28
using	89	Product information	96
testing	69	Proximity	25
using	89	Radial Menu	
Mouse Mode	47	customizing	57
Multiple		using	57
monitors, working with	22	Removing application-specific settings	62
tablets, installing	86	Screen area	49
New tool, adding	60	Settings	
Nib, replacing	84	changing application specific	62
Options, advanced	87	creating application specific	62
		removing application specific	62





Side switch, using	27	pen	67
Software		tablets	64
driver downloads	80	tools	66
uninstalling	85	Touch Ring	68
Specifications, product	93	Tilt	
Airbrush	94	drawing with	28
Art Pen	95	sensitivity, customizing	41
Classic Pen	95	Tip feel	
Grip Pen	94	advanced	39
Inking Pen	95	customizing	38
Intuos4 Wireless tablet	93	Tool buttons, customizing	40
mouse	94	Tools	
Tablet		testing	66
area	50	working with multiple	60
battery activation	11	Touch Ring	
battery and power management	10	customizing	45
battery status light	14	testing	68
charging the battery	11	using	32
connecting to your computer	16	Troubleshooting	
customizing	43	connection problems	70
ExpressKeys		general problems	72
customizing	44	Macintosh-specific problems	77
testing	68	tables	70
using	31	Windows-specific problems	76
features	8	Uninstalling software	85
installation	81	USB connection	18
mode options, changing	86	Using	
orientation	48	Airbrush	90
physical configuration	20	applications integrated for tablet control	88
power saving features	13	Art Pen	90
preferences, managing	85	ExpressKeys	31
properties, working with	36	mouse	89
replacing battery	83	pen	23
storing	83	Radial Menu	57
testing	64	Touch Ring	32
Touch Ring		Wacom international offices	116
customizing	45	Warnings	101
testing	68	Warnings, battery	102
using	32	Windows-specific problems, troubleshooting	76
wireless connection light	14	Wireless connection	15
working with	30	establishing	16
Tablet to screen mapping, customizing	46	Wireless connection light	14
Technical Support, contacting	79	Work area, setting up	19
Testing		Working with Intuos4	23
ExpressKeys	68		
mouse	69		





WACOM INTERNATIONAL OFFICES

WACOM TECHNOLOGY CORPORATION

1311 SE Cardinal Court
Vancouver, WA 98683
U.S.A.

Telephone: +1.360.896.9833

Fax: +1.360.896.9724

WACOM CO., LTD.

JAPAN MARKETING AND SALES DIVISION

Harmony Tower 21F, 1-32-2 Hon-Cho,
Nakano-Ku, Tokyo 164-0012
Japan

Internet: <http://tablet.wacom.co.jp>

WACOM CHINA CORPORATION

Unit 2807, 28th Floor, SK Tower
No 6 Jia, Jianguomenwai Avenue,
Beijing, 100022, China

Internet: <http://www.wacom.com.cn>

WACOM AUSTRALIA PTY. LTD.

Unit 8, Stage 1 Cumberland Green
2-8 South Street Rydalmere
NSW 2116 Australia

Telephone: +61.2.9422.6700

Fax: +61.2.9420.2272

WACOM TAIWAN INFORMATION CO., LTD.

Suite 605, 6th floor, No. 205 Tun-Hwa North Road
Taipei, 105 Taiwan

Telephone: +886.2.2712.2675

Fax: +886.2.2712.9789

WACOM EUROPE GMBH

Europark Fichtenhain A9
47807 Krefeld
Germany

Telephone: +49.(0)2151.3614.0

Fax: +49.(0)2151.3614.111

WACOM CO., LTD.

ASIA PACIFIC MARKETING AND SALES DIVISION

Harmony Tower 18F, 1-32-2 Hon Cho,
Nakano-Ku, Tokyo 164-0012
Japan

Telephone: +81.3.5309.1513

Fax: +81.3.5309.1514

WACOM KOREA CO., LTD.

25th Floor DMC iaan Sangam 2nd Complex, 1653
Sangam-dong, Mapo-gu, Seoul, Korea, 121-270
Korea

Telephone: +82.2.557.3894

Fax: +82.2.557.3895

WACOM SINGAPORE PTE. LTD.

3 Bishan Place
CPF Bishan Building #06-08
Singapore 579838

Telephone: +65.6258.8640

Fax: +65.6258.8697

