

VIZIO



QUICK START GUIDE

Model: S4220w-E4

IMPORTANT SAFETY INSTRUCTIONS

Your Unit is designed and manufactured to operate within defined design limits, and misuse may result in electric shock or fire. To prevent your Unit from being damaged, the following rules should be observed for its installation, use, and maintenance. Please read the following safety instructions before operating your Unit. Keep these instructions in a safe place for future reference.

- Read these instructions.
- Keep these instructions.
- Heed all warnings.
- Follow all instructions.
- Do not use this apparatus near water.
- Clean only with a dry cloth.
- Do not block any ventilation openings. Install in accordance with the manufacturer's instructions.
- Do not install near any heat sources such as radiators, heat registers, stoves, or other apparatus (including amplifiers) that produce heat.
- Do not defeat the safety purpose of the polarized or grounding-type plug. A polarized plug has two blades with one wider than the other. A grounding type plug has two blades and a third grounding prong. The wide blade or the third prong are provided for your safety. If the provided plug does not fit into your outlet, consult an electrician for replacement of the obsolete outlet.
- Protect the power cord from being walked on or pinched, particularly at plugs, convenience receptacles, and the point where they exit from the apparatus.
- Only use attachments/accessories specified by the manufacturer.
- Use only with the cart, stand, tripod, bracket, or table specified by the manufacturer, or sold with the apparatus. When a cart is used, use caution when moving the cart/apparatus combination to avoid injury from tip-over.
- Unplug this apparatus during lightning storms or when unused for long periods of time.
- Refer all servicing to qualified service personnel. Servicing is required when the apparatus has been damaged in any way, such as when the power supply cord or plug is damaged, liquid has been spilled or objects have fallen into the apparatus, the apparatus has been exposed to rain or moisture, does not operate normally, or has been dropped.
- To reduce the risk of electric shock or component damage, switch off the power before connecting other components to your Unit.
- Unplug the power cord before cleaning your Unit. A damp cloth is sufficient for cleaning. Do not use a liquid or a spray cleaner on your Unit. Do not use abrasive cleaners.
- Always use the accessories recommended by the manufacturer to insure compatibility.
- When moving your Unit from an area of low temperature to an area of high temperature, condensation may form in the housing. Wait before turning on your Unit to avoid causing fire, electric shock, or component damage.
- Slots and openings in the back and bottom of the cabinet are provided for ventilation. To ensure reliable operation of your Unit and to protect it from overheating, be sure these openings are not blocked or covered. Do not place your Unit in a bookcase or cabinet unless proper ventilation is provided.
- Never push any object into the slots and openings on your Unit enclosure. Do not place any objects on the top of your Unit. Doing so could short circuit parts causing a fire or electric shock. Never spill liquids on your Unit.
- The power cord must be replaced when using different voltage than the voltage specified. For more information, contact your dealer.
- When connected to a power outlet, power is always flowing into your Unit. To totally disconnect power, unplug the power cord.



• The lightning flash with arrowhead symbol within an equilateral triangle is intended to alert the user to the presence of un-isolated, dangerous voltage within your Unit that may be of sufficient magnitude to constitute a risk of electric shock to persons.



• The exclamation point within an equilateral triangle is intended to alert the user to the presence of important operating and servicing instructions in the literature accompanying your Unit.



- Do not overload power strips and extension cords. Overloading can result in fire or electric shock.
- The wall socket should be located near your Unit and be easily accessible
- Keep your Unit away from moisture. Do not expose your Unit to rain or moisture. If water penetrates into your Unit, unplug the power cord and contact your dealer. Continuous use in this case may result in fire or electric shock.
- Do not use your Unit if any abnormality occurs. If any smoke or odor becomes apparent, unplug the power cord and contact your dealer immediately. Do not try to repair your Unit yourself.
- Avoid using dropped or damaged appliances. If your Unit is dropped and the housing is damaged, the internal components may function abnormally. Unplug the power cord immediately and contact your dealer for repair. Continued use of your Unit may cause fire or electric shock.
- Do not install your Unit in an area with heavy dust or high humidity. Operating your Unit in environments with heavy dust or high humidity may cause fire or electric shock.
- Ensure that the power cord and any other cables are unplugged before moving your Unit.
- When unplugging your Unit, hold the power plug, not the cord. Pulling on the power cord may damage the wires inside the cord and cause fire or electric shock. When your Unit will not be used for an extended period of time, unplug the power cord.
- To reduce risk of electric shock, do not touch the connector with wet hands.
- Insert the remote control battery in accordance with instructions. Incorrect polarity may cause the battery to leak which can damage the remote control or injure the operator.
- See the important note and rating located on the bottom of the unit.
- **WARNING** - This equipment is not waterproof. To prevent a fire or shock hazard, do not place any container filled with liquid near the equipment (such as a vase or flower pot) or expose it to dripping, splashing, rain, or moisture.
- **CAUTION** - Danger of explosion or fire if battery is mistreated. Replace only with the same or specified type.
- Do not leave the battery exposed to direct sunlight for a long period of time with doors and windows closed. Do not disassemble the battery or dispose of it in fire.
- Disconnect the mains plug to shut off when you experience trouble or the device is not in use. The mains plug shall remain readily operable.

TABLE OF CONTENTS

Table of Contents.....	3
Package Contents.....	4
Controls & Connections	5
First-Time Setup	7
Bluetooth Pairing.....	12
Using Bluetooth Mode	13
Advanced Setup	14
Wall Mounting the Sound Bar	15
Adjusting Sound Bar Settings.....	17
Help & Troubleshooting	19
One-Year Limited Warranty	22
Legal & Compliance	23

PACKAGE CONTENTS

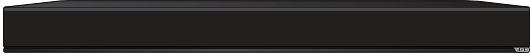

High Definition Sound Bar



Remote Control with Batteries



Quick Start Guide



Power Cable



Stereo RCA to 3.5mm Audio Cable



Coaxial Audio Cable



Digital Optical Cable



2 x Sound Bar Wall Mount Brackets



2 x Wall Mount Screws (Size: M4 x 10)

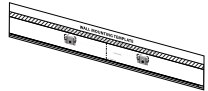

Wall Mount Template

CONTROLS & CONNECTIONS

Back of Sound Bar

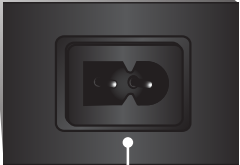
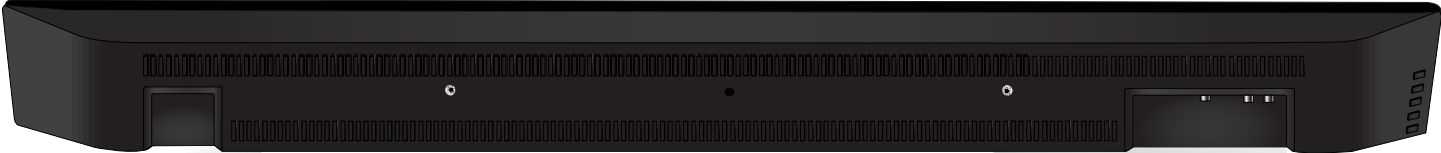

Power Port



(USB 5)
USB Port

(Optical 4)
Digital Optical
Audio In

(Digital 3)
Coaxial In

(Aux 2)
Analog Audio In

(Aux 1)
Analog Audio In

Back of Sound Bar

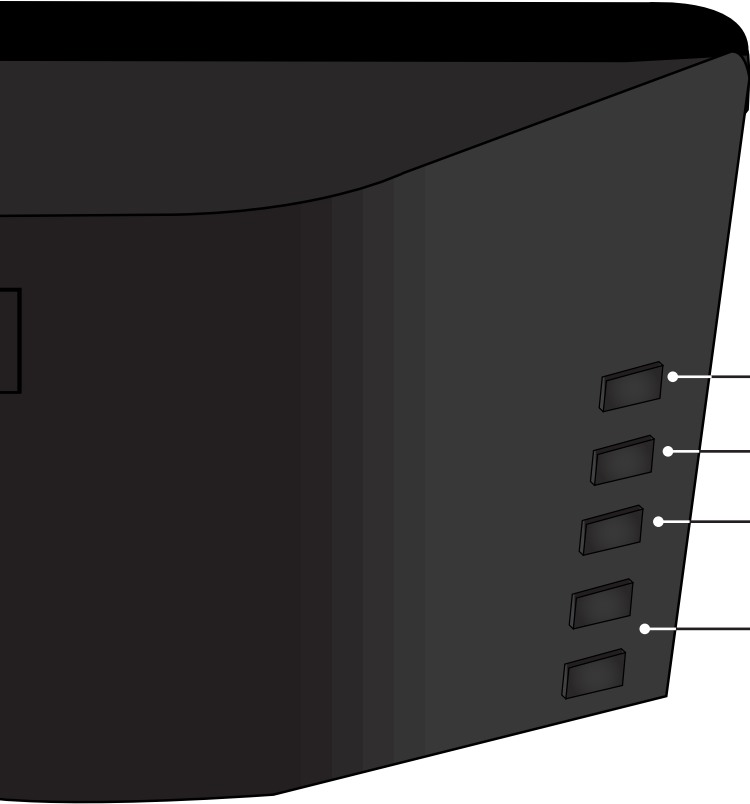

Control Buttons are located here:



Power



Input



Bluetooth Input

(Hold to force pair, See "Bluetooth Pairing" on page 12)



Volume



FIRST-TIME SETUP

1

Connect one of the included cables to ONE TV audio output as shown.*



Connection ports are located here:

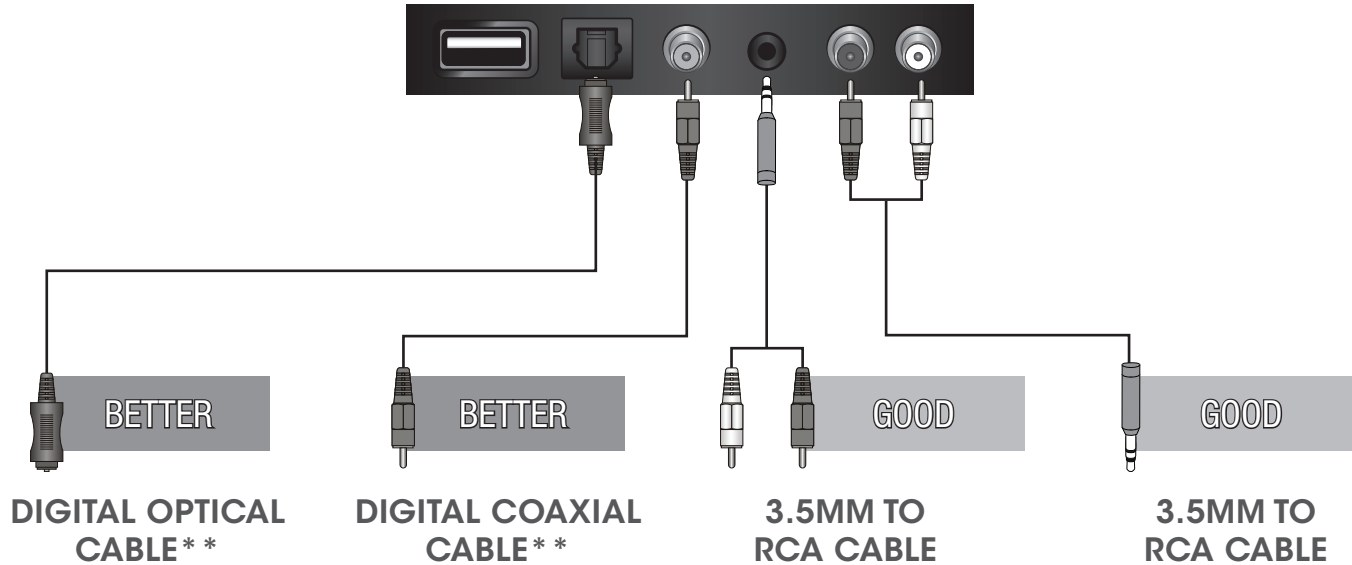

CHOOSE **ONE** CABLE:

BETTER

GOOD

AND CONNECT IT TO YOUR TV

*Not all TVs have the audio outputs shown above. To connect the Sound Bar directly to your other devices (Blu-ray player, game system, etc) see your device's user manual.

**When using either of the Digital Inputs, if there is no audio: (A) try setting the TV output to PCM or (B) Connect directly to your Blu-ray/other source, some TVs do not pass through digital audio.

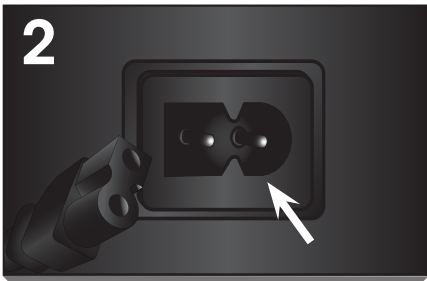

Connect a power cable to the sound bar.



Plug the power cable into a power outlet.

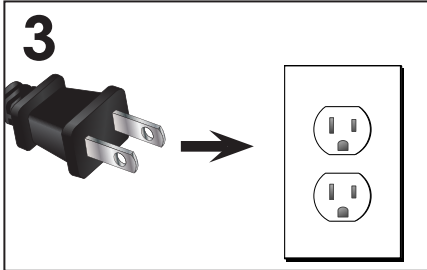

3

Sound bar is centered
below the TV.

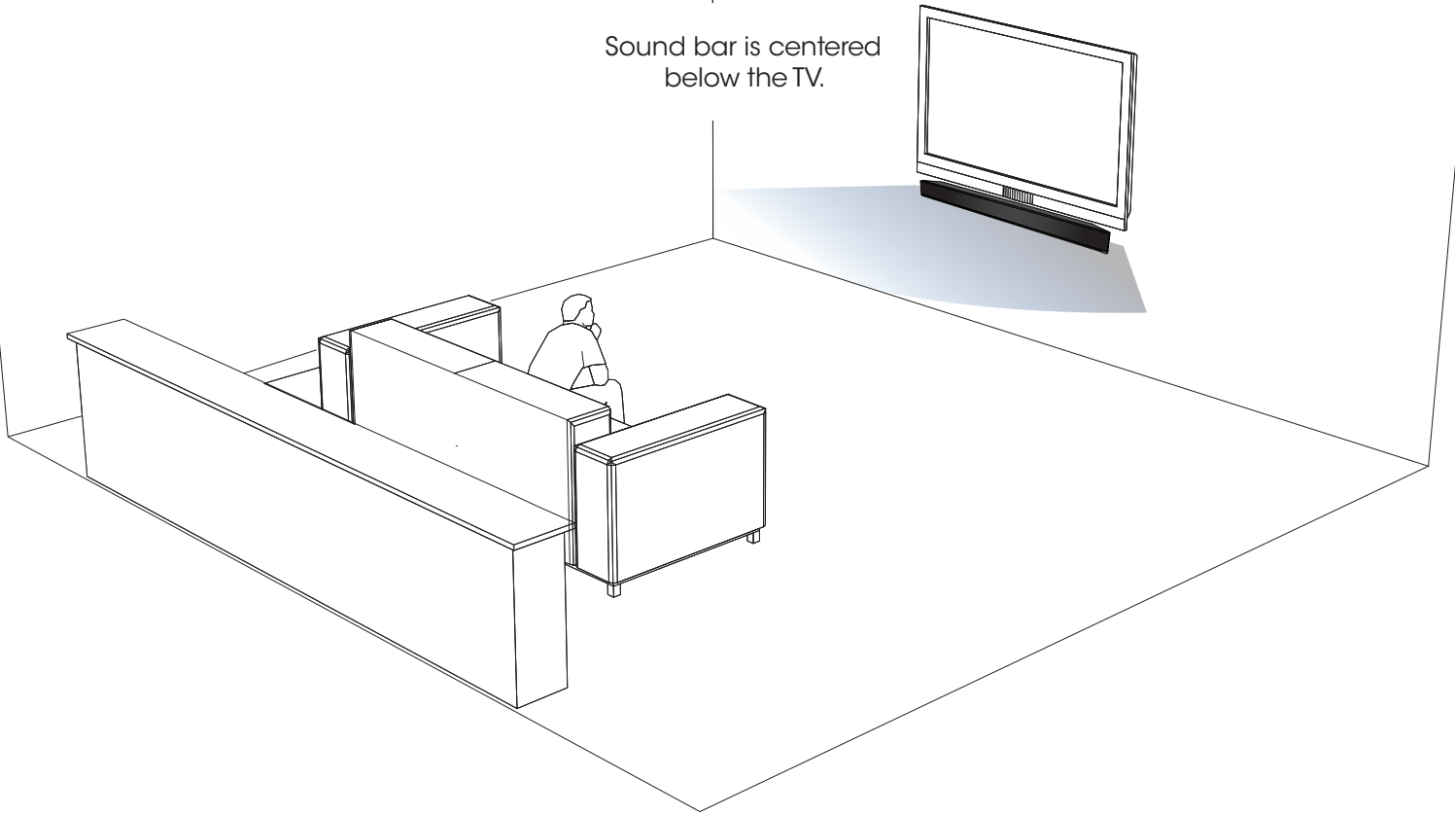

For the best surround sound experience, position the sound bar as shown.
The sound bar should be close to ear level.

4



Remove the battery cover by gently sliding it away from the remote.

5



Insert the included batteries and gently slide the battery cover back into place.

6

Turn your TV on, then press the **Power** button on the remote to turn the Sound Bar on.

Press the **Input** button to switch between audio sources. For example, if you connected your TV to Input 1, set the sound bar to Input 1.

Hardware setup is complete.



USING THE REMOTE

Input
Press to change input source.

Volume +
Press to increase volume.

Previous
Press to return to previous track.
(Changes Treble and Bass levels)

TruVolume
Press to enable/disable TruVolume.

TruSurround HD
Press to enable/disable TruSurround HD.

Mute
Press to mute/unmute.

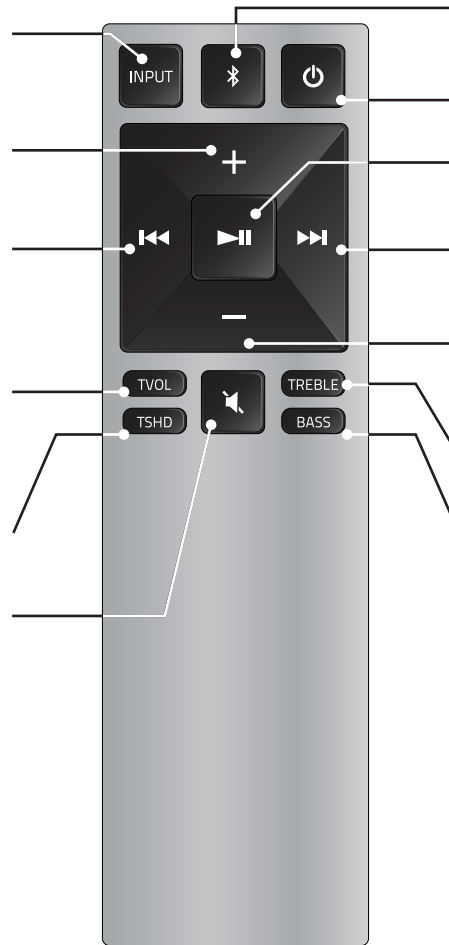

Bluetooth
Press to enter Bluetooth input.
(To enter force pair mode, press and hold for 5 seconds)

Power
Press to turn on or off.

Enter/Play/Pause
Press to select an option.
Press to play or pause.

Next
Press to skip to the next track.
(Changes Treble and Bass levels)

Volume -
Press to decrease volume.

Treble
Press to enter treble adjustment mode.

Bass
Press to enter bass adjustment mode.

BLUETOOTH PAIRING

To pair the Sound Bar with a Bluetooth device:

1. Press and hold the **Bluetooth** button on the Sound Bar for five (5) seconds or use the BT Pair menu option from the remote (see "*Adjusting Sound Bar Settings*" on page 17). When the Sound Bar is in Bluetooth Pairing Mode, the LED Indicators on the Display Panel on the front of the Sound Bar will light sequentially from left to right and back again.

Once the device is paired, the LED Indicators will stop flashing.

2. You can now search for the Sound Bar (VIZIO S4220w) using your Bluetooth device. For more information, see the documentation that came with your device.
3. Play audio from your Bluetooth device. Volume can be controlled on your source device and the Sound Bar.

Back of Sound Bar

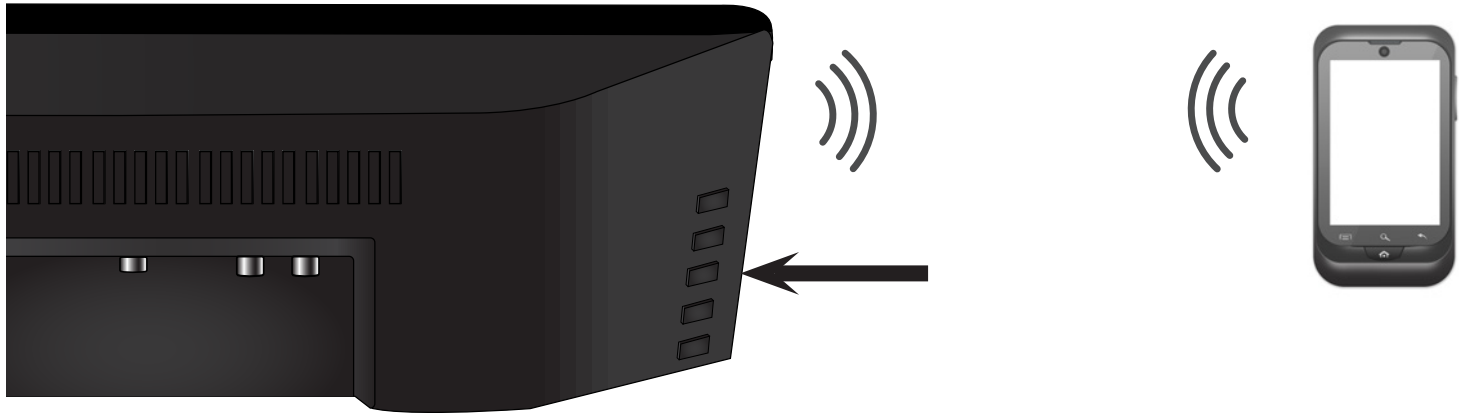

USING BLUETOOTH MODE

Your Sound Bar supports music streaming from smartphones, tablets, and computers with Bluetooth capability. Device compatibility will vary, see your device's documentation for more information. Once you have paired your source device to the Sound Bar, as long as you stay within range of the Sound Bar, your device should remain paired, even if you change the input on the Sound Bar.



Your Sound Bar is not equipped with a microphone, so it cannot operate as a hands-free device for a smartphone.

Maximizing Signal

A Bluetooth signal has a range of up to 30 feet. Keep in mind that Bluetooth is a compressed audio format, so streamed music may lose some integrity when compared to a wired connection.

Try the following if your sound quality is less than optimal:

- If you hear any break-up or disconnect while streaming music from your device, move the source device closer to the Sound Bar.
- Be sure that there are no solid obstructions in the line-of-sight between the Sound Bar and the source device.
- Other wireless devices can affect Bluetooth range, including wireless security cameras, wireless video baby monitors, cordless phones, and microwave ovens. Turning off or moving these devices may improve Bluetooth range.



Reduce the volume levels on your device and on the Sound Bar before pressing **Play**. High volume levels can damage your hearing.

ADVANCED SETUP

Connect up to five (5) different devices to the Sound Bar (devices shown are examples-you can use any device).

To listen to a device, change the input source on the Sound Bar.

Optical, Coaxial, and 3.5mm cables transmit audio only. If connecting a video device, you will need a separate video connection from the device to your TV.



Connection ports are located here:



USB THUMB DRIVE*



Game Console



DIGITAL OPTICAL CABLE



Network Media Player



DIGITAL COAXIAL CABLE



Tablet/MP3 Player/Laptop



3.5mm AUDIO CABLE

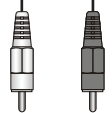

RCA AUDIO CABLE

*Supports .WAV file format playback only

WALL MOUNTING THE SOUND BAR

1

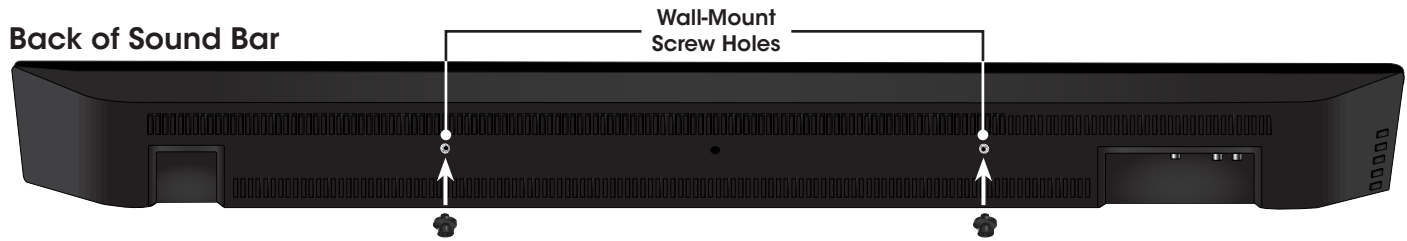

Insert and tighten two Wall-Mount Screws with a Phillips-head screwdriver into the Wall-Mount Screw Holes.

2

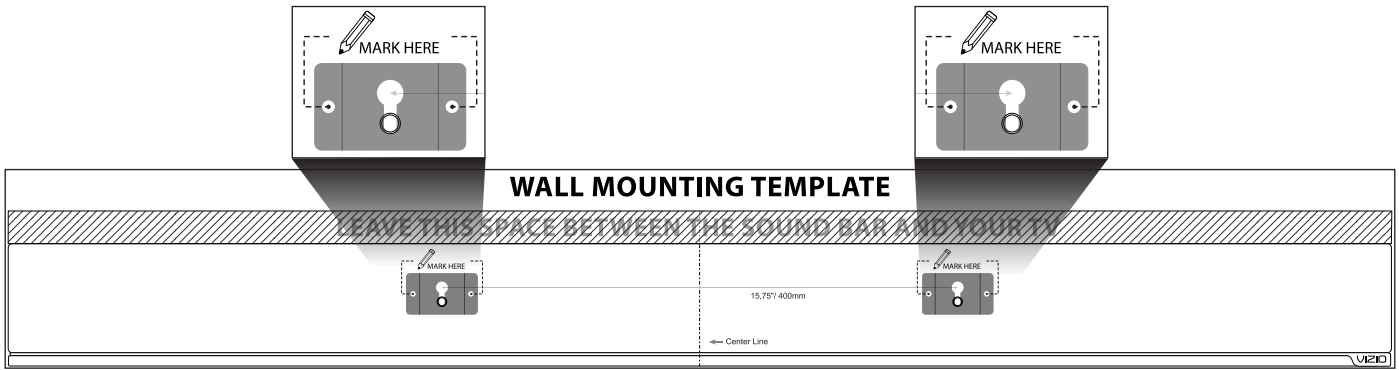

Place the included wall mounting template against the wall under your TV. Mark the four bracket holes using a pencil.

3

Be sure your screws are attached to wood studs or drywall anchors (for drywall) or concrete anchors (for brick/concrete walls). Wall mounting hardware is not included.

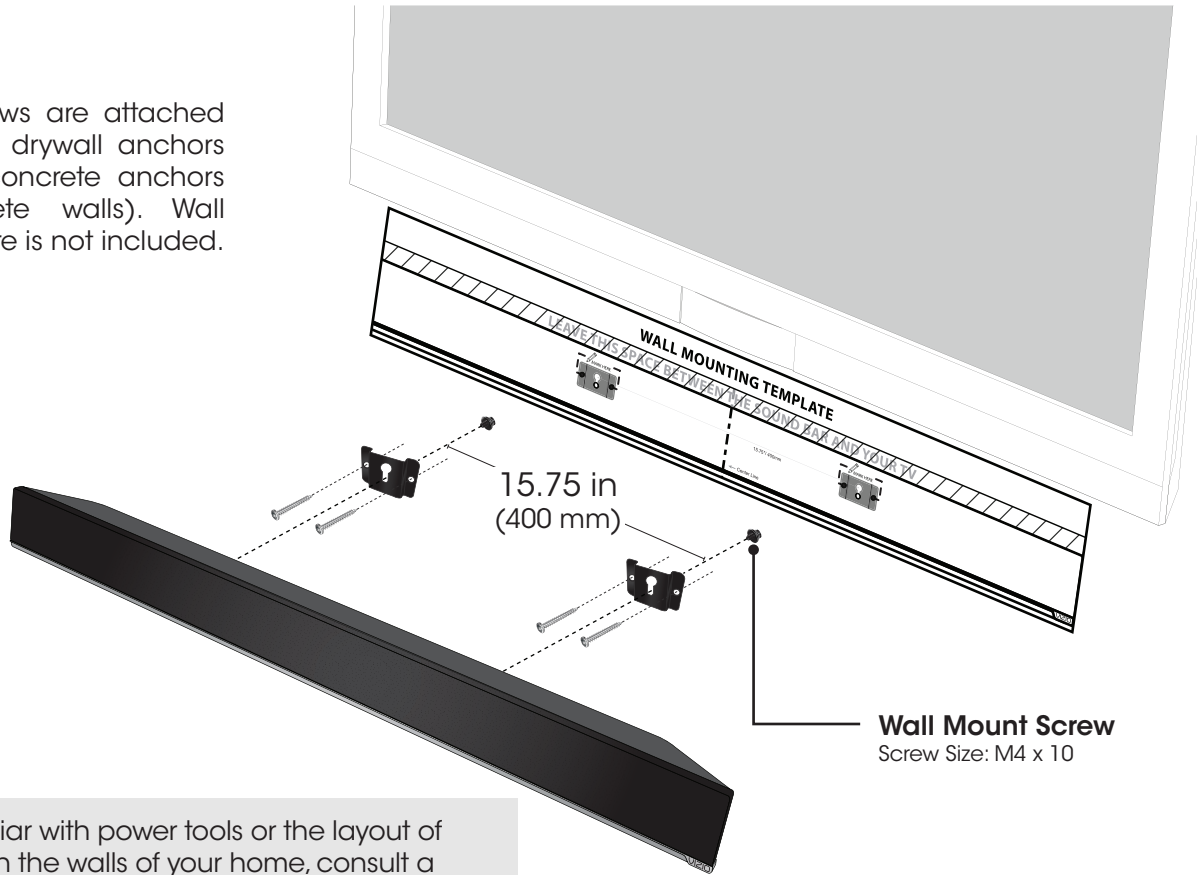





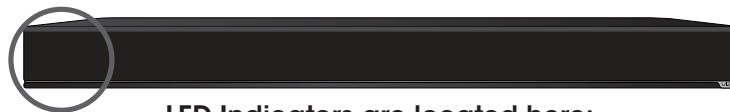



If you are unfamiliar with power tools or the layout of electrical wiring in the walls of your home, consult a professional installer.



ADJUSTING SOUND BAR SETTINGS



LED Indicators are located here:

Press the button on the remote (indicated in the table below) to access the different functions and acoustic settings of the Sound Bar. The LED Indicators will behave differently with each function.

Function	LED Behavior	Description
Bluetooth Pairing 	(When searching for device) Flash from Left to Right and back continuously. 	Hold the Bluetooth button on the remote for 5 seconds. The Sound Bar switches to Bluetooth input and enters discoverable mode, where the LED array enters "knight rider" sequence. Note: The "knight rider" sequence steps the LED array from 1 to 12 and from 12 back to 1, a single LED at a time every 80 milliseconds. You can now search for the Sound Bar (VIZIO S4220w) using your Bluetooth Device. The sound bar will power down if no device is found. Note: Set your Bluetooth device into pairing mode prior to the Sound Bar. Further functionality definition can be found in the "Bluetooth" section of this document. Note: On all models, this is a redundant feature – it can be accessed by a remote control IR command and by holding the Bluetooth button on the Sound Bar.
Bass Levels 	Two center LEDs indicate Bass level 0. 	Press the Bass and Next/Previous button to increase/decrease the bass level. The LED indicators will move to the right with increasing levels and to the left with decreasing levels.
Treble Levels 	Two center LEDs indicate Treble level 0. 	Press the Treble button to increase/decrease the treble level. The LED indicators will move to the right with increasing levels and to the left with decreasing levels.
DTS TruVolume On/Off 	TruVolume On:  TruVolume Off: 	Press the TVOL button to enable/disable TruVolume. When enabled (On), TruVolume provides a consistent and comfortable volume level for a more enjoyable listening experience.

Function	LED Behavior	Description
DTS TruSurround On/Off TSHD	Surround On:  Surround Off: 	Press the TSHD button to enable/disable DTS TruSurround. When enabled (On), TruSurround will produce a wider sound for a more enjoyable listening experience.

HELP & TROUBLESHOOTING

There is no power.

- Press the **POWER** button on the remote control or on the top of your Sound Bar.
 - Ensure the power cord is securely connected.
 - Plug a different device into the electrical outlet to verify that the outlet is working correctly.
-

There is no sound.

- Increase the volume. Press **Volume Up** on the remote control or on the top of your Sound Bar.
 - Press **MUTE** on the remote to ensure the Sound Bar is not muted.
 - Press **INPUT** on the remote or on the top of your Sound Bar to select a different input source.
 - When using either of the Digital Inputs, if there is no audio: (A) try setting the TV output to PCM or (B) Connect directly to your Blu-ray/other source, some TVs do not pass through digital audio.
 - Your TV may be set to variable audio output. Confirm that the audio output setting is set to FIXED or STANDARD, not VARIABLE. Consult your TV's user manual for more detailed information.
 - If using Bluetooth, ensure that the volume on your source device is turned up and that the device is not muted.
-

I hear buzzing or humming.

- Ensure all cables and wires are securely connected.
 - Connect a different source device (TV, Blu-ray player, etc) to see if the buzzing persists. If it does not, the problem may be with the original device.
 - Connect your device to a different input on the Sound Bar.
-

The remote isn't working.

- Replace the remote batteries with new ones.
- Point the remote directly at the Sound Bar when pressing a button.
- If using a Bluetooth connection, some of the buttons on the remote may not be supported by the streaming application. (e.g., Pandora doesn't support the Back button.)

DO YOU HAVE QUESTIONS?

LET US HELP!

YOUR PRODUCT INCLUDES FREE LIFETIME TECH SUPPORT



The VIZIO support team is highly trained and is based in the United States.

We can help with:

- New Product Setup
- Connecting Your Devices
- Technical Problems
- And More

Phone: (877) 878-4946 (TOLL-FREE)

Email: techsupport@VIZIO.com

Web: <http://store.VIZIO.com/support>

Hours of operation:

Monday - Friday: 5 AM TO 9 PM (PST)

Saturday - Sunday: 8 AM TO 4 PM (PST)

We speak English • Se habla Español • Nous parlons Français

VIZIO RECOMMENDS



Introducing the new E-series slim frame design. The VIZIO E-series LED TV is shattering the mold in a way only VIZIO can, with high-quality design and picture at the best value. With a stunningly slim outer frame design – and LED with 1080p Full HD for rich colors and vivid details, this HDTV gives you the best picture at the best value.

Available at www.VIZIO.com

This Product Sold Separately

ONE-YEAR LIMITED WARRANTY

ON PARTS AND LABOR

Covers units purchased as new in United States and Puerto Rico Only

VIZIO provides a warranty to the original purchaser of a new Product against defects in materials and workmanship for a period of one year of non-commercial usage and ninety (90) days of commercial use. If a Product covered by this warranty is determined to be defective within the warranty period, VIZIO will either repair or replace the Product at its sole option and discretion.

To obtain warranty service, contact VIZIO Technical Support via email: TechSupport@VIZIO.com or via phone at 877 MY VIZIO (877.698.4946) from 5:00AM to 9:00PM Monday through Friday and 8:00AM to 4:00PM Saturday and Sunday, Pacific Time, or visit www.VIZIO.com. PRE-AUTHORIZATION MUST BE OBTAINED BEFORE SENDING ANY PRODUCT TO A VIZIO SERVICE CENTER. Proof of purchase in the form of a purchase receipt or copy thereof is required to show that a Product is within the warranty period.

Parts and Labor

There will be no charge for parts or labor during the warranty period. Replacement parts and Products may be new or recertified at VIZIO's option and sole discretion. Replacement parts and Products are warranted for the remaining portion of the original warranty or for ninety (90) days from warranty service or replacement, whichever is greater.

Type of Service

Defective Products must be sent to a VIZIO service center to obtain warranty service. VIZIO is not responsible for transportation costs to the service center, but VIZIO will cover return shipping to the customer. PRE-AUTHORIZATION IS REQUIRED BEFORE SENDING ANY PRODUCT TO A VIZIO SERVICE CENTER FOR WARRANTY SERVICE.

Product returns to VIZIO's service centers must utilize either the original carton box and shipping material or packaging that affords an equal degree of protection. VIZIO Technical Support will provide instructions for packing and shipping the covered Product to the VIZIO service center.

Limitations and Exclusions

VIZIO's one-year limited warranty only covers defects in materials and workmanship. This warranty does not cover, for example: cosmetic damage, normal wear and tear, improper operation, improper voltage supply or power surges, signal issues, damages from shipping, acts of God, any type of customer misuse, modifications or adjustments, as well as installation and set-up issues or any repairs attempted by anyone other than by a VIZIO authorized service center. Products with unreadable or removed serial numbers, or requiring routine maintenance are not covered. This one year limited warranty does not cover Products sold "AS IS", "FACTORY RECERTIFIED", or by a non-authorized reseller.

THERE ARE NO EXPRESS WARRANTIES OTHER THAN THOSE LISTED OR DESCRIBED ABOVE. ANY IMPLIED WARRANTIES, INCLUDING ANY IMPLIED WARRANTY OF MERCHANTABILITY AND FITNESS FOR A PARTICULAR PURPOSE, SHALL BE LIMITED IN DURATION TO THE PERIOD OF TIME SET FORTH ABOVE. VIZIO'S TOTAL LIABILITY FOR ANY AND ALL LOSSES AND DAMAGES RESULTING FROM ANY CAUSE WHATSOEVER INCLUDING VIZIO'S NEGLIGENCE, ALLEGED DAMAGE, OR DEFECTIVE GOODS, WHETHER SUCH DEFECTS ARE DISCOVERABLE OR LATENT, SHALL IN NO EVENT EXCEED THE PURCHASE PRICE OF THE PRODUCT. VIZIO SHALL NOT BE RESPONSIBLE FOR LOSS OF USE, LOSS OF INFORMATION OR DATA, COMMERCIAL LOSS, LOST REVENUE OR LOST PROFITS, OR OTHER INCIDENTAL OR CONSEQUENTIAL DAMAGES. SOME STATES DO NOT ALLOW LIMITATIONS ON HOW LONG AN IMPLIED WARRANTY LASTS OR THE EXCLUSION OF INCIDENTAL OR CONSEQUENTIAL DAMAGES, SO THE ABOVE LIMITATIONS OR EXCLUSIONS MAY NOT APPLY TO YOU. THIS WARRANTY GIVES YOU SPECIFIC LEGAL RIGHTS, AND YOU MAY ALSO HAVE OTHER RIGHTS, WHICH VARY FROM STATE TO STATE. THIS WARRANTY IS SUBJECT TO CHANGE WITHOUT NOTICE. CHECK www.VIZIO.com FOR THE MOST CURRENT VERSION.

SPECIFICATIONS

Sound Bar: Two 3" Full-Range Drivers + Two 3" Deep Base Modules + Two ¾" Tweeters

Inputs: 1 x 3.5mm Stereo Audio
1 x RCA Stereo Audio
1 x Optical (Toslink)
1 x USB
1 x Digital Coaxial Audio

Frequency Response (System): 70 Hz - 19 KHz

Voltage: 120 VAC, 60 Hz

Compliances: UL, C-UL, FCC

Sound Pressure Level (System): 98 dB

LEGAL & COMPLIANCE

FCC Class B Radio Interference Statement

NOTE: This equipment has been tested and found to comply with the limits for a Class B digital device, pursuant to Part 15 of the FCC Rules. These limits are designed to provide reasonable protection against harmful interference in a residential installation. This equipment generates, uses and can radiate radio frequency energy, and if not installed and used in accordance with the instructions, may cause harmful interference to radio communications. However, there is no guarantee that interference will not occur in a particular installation. If this equipment does cause harmful interference to radio or television reception, which can be determined by turning the equipment off and on, the user is encouraged to try to correct the interference by one or more of the following measures:

1. Reorient or relocate the receiving antenna.
2. Increase the separation between the equipment and receiver.
3. Connect the equipment into an outlet on a circuit different from that to which the receiver is connected.
4. Consult the dealer or an experienced radio/TV technician for help.

This device complies with Part 15 of the FCC Rules. Operation is subject to the following two conditions: (1) this device may not cause harmful interference, and (2) this device must accept any interference received, including interference that may cause undesired operation.

Notice:

1. The changes or modifications not expressly approved by the party responsible for compliance could void the user's authority to operate the equipment.
2. Shielded interface cables and AC power cord, if any, must be used in order to comply with the emission limits.
3. The manufacturer is not responsible for any radio or TV interference caused by unauthorized modification to this equipment. It is the responsibilities of the user to correct such interference.

RF Exposure Information

This device meets the government's requirements for exposure to radio waves. This device is designed and manufactured not to exceed the emission limits for exposure to radio frequency (RF) energy set by the Federal Communications Commission of the U.S. Government. This device complies with FCC radiation exposure limits set forth for an uncontrolled environment.

IC Statement

Operation is subject to the following two conditions:

1. This device may not cause interference, and
2. This device must accept any interference, including interference that may cause undesired operation of the device.

IC Radiation Exposure Statement

This equipment complies with IC RSS-102 radiation exposure limits set forth for an uncontrolled environment. This equipment should be installed and operated with minimum distance 20cm between the radiator & your body.

Disposal and Recycling

You must dispose of this product properly, according to local laws and regulations. Because this product contains electronic components and a battery, it must be disposed of separately from household waste. Contact local authorities to learn about disposal and recycling options.

Other:

Image(s) used under license from Shutterstock.com



Manufactured under license from Dolby Laboratories. Dolby and the double-D symbol are trademarks of Dolby Laboratories.



For DTS patents, see <http://patents.dts.com>. Manufactured under license from DTS Licensing Limited. DTS, the Symbol, & DTS and the Symbol together are registered trademarks, and DTS TruVolume is a trademark of DTS, Inc. © DTS, Inc. All Rights Reserved.



For DTS patents, see <http://patents.dts.com>. Manufactured under license from DTS Licensing Limited. DTS, the Symbol, & DTS and the Symbol together are registered trademarks, and DTS TruSurround is a trademark of DTS, Inc. DTS, Inc. All Rights Reserved.



This product qualifies for ENERGY STAR in the "factory default" setting and this is the setting in which power savings will be achieved. Changing the factory default settings or enabling other features will increase power consumption that could exceed the limits necessary to qualify for ENERGY STAR rating.

We want to help you save energy.

