



VISION **10/12**
MODEL

DLP™ PROJECTORS

TWO YEAR LIMITED WARRANTY

For Projectors, Video Processors and Controllers

Congratulations on your purchase of a Vidikron video product and welcome to the Vidikron family! With proper installation, setup and care, you should enjoy many years of unparalleled video performance.

This is a LIMITED WARRANTY as defined in the Magnuson-Moss Warranty Act. Please read it carefully and retain it with your other important documents.

WHAT IS COVERED UNDER THE TERMS OF THIS LIMITED WARRANTY:

SERVICE LABOR: Vidikron will pay for service labor by Vidikron Authorized Service Center when needed as a result of manufacturing defect for a period of two (2) years from the effective date of delivery to the end user (excluding the lamp).

PARTS (not including the lamp): Vidikron will provide new or rebuilt replacement parts for the parts that fail due to defects in materials or workmanship for a period of two (2) years from the effective date of delivery to the end user. Such replacement parts are then subsequently warranted for the remaining portion (if any) of the original warranty period.

PROJECTOR LAMP: Vidikron will pay for service labor by a Vidikron Authorized Service Center when needed as a result of a manufacturing defect for a period of six (6) months or 1000 hours, whichever comes first, from the effective date of delivery to the end user. In addition, Vidikron will provide a new or rebuilt replacement lamp for the lamp that fails due to defects in materials or workmanship for a period of six (6) months or 1000 hours, whichever comes first, from the effective date of delivery to the end user. Such replacement lamps are then subsequently warranted for the remaining portion (if any) of the original warranty period.

WHAT IS NOT COVERED UNDER THE TERMS OF THIS LIMITED WARRANTY:

This Limited Warranty only covers failure due to defects in materials and workmanship that occur during normal use and does not cover normal maintenance. This Limited Warranty does not cover cabinets or any appearance items; failure resulting from accident, misuse, abuse, neglect, mishandling, misapplication, faulty or improper installation or setup adjustments; improper maintenance, alteration, improper use of any input signal; damage due to lightning or power line surges, spikes and brownouts; damage that occurs during shipping or transit; or damage that is attributed to acts of God. In the case of remote control units, damage resulting from leaking, old, damaged or improper batteries is also excluded from coverage under this Limited Warranty.

CAUTION: THIS LIMITED WARRANTY ONLY COVERS VIDIKRON PRODUCTS PURCHASED FROM VIDIKRON AUTHORIZED DEALERS. ALL OTHER PRODUCTS ARE SPECIFICALLY EXCLUDED FROM COVERAGE UNDER THIS WARRANTY. MOREOVER, DAMAGE RESULTING DIRECTLY OR INDIRECTLY FROM IMPROPER INSTALLATION OR SETUP IS SPECIFICALLY EXCLUDED FROM COVERAGE UNDER THIS LIMITED WARRANTY. IT IS IMPERATIVE THAT INSTALLATION AND SETUP WORK BE PERFORMED ONLY BY AN AUTHORIZED VIDIKRON DEALER TO PROTECT YOUR RIGHTS UNDER THIS WARRANTY. THIS WILL ALSO ENSURE THAT YOU ENJOY THE FINE PERFORMANCE OF WHICH YOUR VIDIKRON PRODUCT IS CAPABLE WHEN INSTALLED AND CALIBRATED BY VIDIKRON AUTHORIZED PERSONNEL.

RIGHTS, LIMITS AND EXCLUSIONS:

Vidikron limits its obligations under any implied warranties under state laws to a period not to exceed the warranty period. There are no express warranties. Vidikron also excludes any obligation on its part for incidental or consequential damages related to the failure of this product to function properly. Some states do not allow limitations on how long an implied warranty lasts, and some states do not allow the exclusion or limitation of incidental or consequential damages. So the above limitations or exclusions may not apply to you. This warranty gives you specific legal rights, and you may also have other rights that vary from state to state.

EFFECTIVE WARRANTY DATE:

This warranty begins on the effective date of delivery to the end user. For your convenience, keep the original bill of sale as evidence of the purchase date.

IMPORTANT -- WARRANTY REGISTRATION:

Please fill out and mail your warranty registration card. It is imperative that Vidikron knows how to reach you promptly if we should discover a safety problem or product update for which you must be notified.

CONTACT A VIDIKRON AUTHORIZED SERVICE CENTER TO OBTAIN SERVICE:

Repairs made under the terms of this Limited Warranty covering your Vidikron video product will be performed at the location of the product, during usual working hours, providing location of product is within normal operating distance from a Vidikron Authorized Service Center. In some instances it may be necessary for the product to be returned to the Vidikron factory for repairs. If, solely in Vidikron's judgment, location of product to be repaired is beyond normal operating distance of the closest Vidikron Authorized Service Center, or the repair requires the unit be returned to the Vidikron factory, it is the owner's responsibility to arrange for shipment of the product for repair. These arrangements must be made through the selling Vidikron Dealer. If this is not possible, contact Vidikron directly for a Return Authorization number and shipping instructions. Vidikron will return product transportation prepaid in the United States, unless no product defect is discovered. In that instance, shipping costs will be the responsibility of the owner.

COPYRIGHT AND TRADEMARKS:

© Copyright 2006 Vidikron, a Runco International Company. This document contains proprietary information protected by copyright, trademark and other intellectual property laws. All rights are reserved. No part of this manual may be reproduced by any mechanical, electronic or other means, in any form, without prior written permission of the manufacturer.

Vidikron, Vision, IntelliWide, Imagix, DView and CSMS are trademarks of Vidikron. All other trademarks and registered trademarks used in this document are the property of their respective owners.

Vidikron products are manufactured under one or more of the following patents: US. Patent 6755540 and Other Patents Pending.

ADDITIONAL INFORMATION:

To locate the name and address of the nearest Vidikron Authorized Service Center, or for additional information about this Limited Warranty, please call or write:

VIDIKRON
Attn: Customer Service Department
2900 Faber Street
Union City, CA 94587
Ph: (510) 324-5900
Fax: (510) 324-5905
Toll Free: (888) 4VIDIKRON

VIDIKRON PRODUCT INFORMATION
RETAIN THIS INFORMATION FOR YOUR RECORDS

Model Purchased

Date

Serial Number

Vidikron Authorized Dealer Name

Address

City

State/Province

Postal Code

Phone

Fax

Safety Precautions

Thank you for your purchase of this quality Vidikron video projector! It has been designed to provide you with the quality of video that is expected in a home theater. For the best performance, please read this manual carefully as it is your guide through the menus and operation.

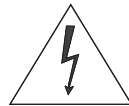
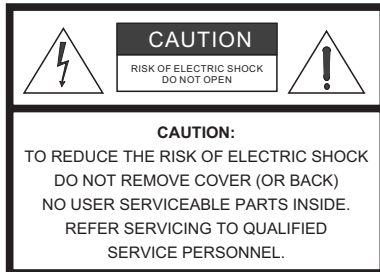

WARNING

This symbol is intended to alert the user to the presence of uninsulated "dangerous voltage" within the product's enclosure that may be of sufficient magnitude to constitute a risk of electric shock.



This symbol is intended to alert the user to the presence of important operating and maintenance (servicing) instructions in the literature accompanying the appliance.

This equipment has been tested and found to comply with the limits for a Class B digital device, pursuant to Part 15 of the FCC Rules. These limits are designed to provide reasonable protection against harmful interference in a residential installation.

1. Read these instructions.
2. Keep these instructions.
3. Heed all warnings.
4. Do not use this equipment near water, outdoors or otherwise exposed to the elements.
5. Clean only with a dry cloth.
6. Do not block any ventilation openings.
7. Do not install near any heat sources such as radiators, heat registers, stoves, or other apparatus (including amplifiers) that produce heat.
8. Do not defeat the safety feature of the polarized or grounding type plug. A polarized type plug has two blades with one wider than the other. A grounding type plug has two blades and a third grounding prong. The third prong is provided for your safety. If the provided plug does not fit into your outlet, consult an electrician for the replacement of the obsolete outlet.
9. The 12V trigger only outputs DC 12V signal for triggering. Do not connect to any other power input or output. This could cause damage to this unit.
10. Only use accessories specified by Vidikron.
11. Keep the packing material in case the equipment should ever need to be shipped.
12. Unplug this projector during lightning storms or when it will not be used for an extended period of time.
13. The lamp becomes extremely hot during operation. Allow the projector to cool down for approximately 45 minutes prior to removing the lamp assembly for replacement. Do not operate lamps beyond the rated lamp life. Excessive operation of lamps beyond rated life could cause them to explode in rare occasions.
14. Refer all servicing to qualified service personnel. Servicing is required when the projector has been damaged in any way, objects have fallen or spilled into the projector, the projector has been exposed to rain or moisture, does not operate normally, or has been dropped.

Table of Contents

TWO YEAR LIMITED WARRANTY	iii
Safety Precautions	vi
1. Introduction	1
About This Manual	1
Target Audience.....	1
If You Have Comments About This Manual... ..	1
Textual and Graphic Conventions	1
Using This Manual	2
Description, Features and Benefits	3
Key Features and Benefits.....	3
Parts List	4
2. Controls and Functions	5
Vision 10/12 at a Glance	5
Front/Top/Side View.....	5
Rear/Top/Side View.....	7
Vision 10/12 Remote Control	9
3. Installation	13
Remote Control	13
Notes on Batteries	13
Notes on Remote Control Operation.....	14
Quick Setup	15
Installation Considerations	16
Installation Type	16
Ambient Light	16
Other Considerations	16
Throw Distance.....	17
Vertical and Horizontal Position.....	18
Vertical and Horizontal Lens Shift.....	18
Adjusting the Projection Angle	20
Mounting	21
Folded Optics	21

Connections to the Vision 10/12	22
Connector Panel Access	22
Connecting the Vision 10/12 to Source Components.....	22
RS-232 Controller Connection	27
Connecting to the 12-Volt Trigger Output.....	28
4. Operation	29
Turning on the Power	29
Adjusting the Projector Height or Projection Angle	29
Changing the OSD Language	30
Adjusting the Picture Orientation	30
Lens Adjustments	31
Focus/Zoom.....	31
Shift	32
Using the On-Screen Menus	32
Main Menu	34
Source Select	34
Aspect Ratio	34
Picture Adjust.....	36
Image Option	42
Installation	44
ISF Settings	46
5. Maintenance and Troubleshooting	49
Cleaning the Projector	49
Cleaning the Lens	49
Cleaning the Intake and Exhaust Vents	50
Lamp Maintenance	51
Lamp Cautions	51
Lamp Replacement	52
Troubleshooting Tips	53
6. Serial Communications	55
RS-232 Connection and Port Configuration	55
Serial Command Syntax	55
7. Specifications	57
Vision 10/12 Specifications	57
Vision 10/12 Dimensions	59
Computer Signal Compatibility	60
Video Signal Compatibility	62

List of Figures

2-1. Vision 10/12 Top/Front/Side View	5
2-2. Vision 10/12 Rear/Top/Side View	7
2-3. Vision 10/12 Remote Control	9
3-1. Available Range of the Remote Control	14
3-2. Estimating Throw Distance	17
3-3. Projector Placement	18
3-4. Vertical Lens Shift (Example only)	18
3-5. Horizontal Lens Shift (Example only)	19
3-6. Folded Optics	21
3-7. HDMI (or DVI) Source Connections	23
3-8. Analog RGB Connections	24
3-9. Component Video Connections	25
3-10. Composite and S-Video Connections	26
3-11. RS-232 Control System Connection	27
3-12. Connecting the 12-Volt Trigger Output	28
4-1. Adjusting the Feet	29
4-2. Focus and Zoom Controls	31
4-3. Vertical and Horizontal Lens Shift Controls	32
4-4. Vision 10/12 OSD Menu Structure	33
4-5. Typical PLUGE Pattern for Adjusting Brightness	37
4-6. Typical Gray Bar Pattern for Adjusting Contrast	38
4-7. Typical Color Bar Pattern for Adjusting Color Saturation and Tint	38
4-8. Typical Test Pattern for Adjusting Sharpness	40
4-9. CIE 1931 Chromaticity Diagram	41
4-10. Horizontal and Vertical Keystone Correction	45
4-11. ISF-Enabled Vision 10/12 Splash Screen	47
7-1. Vision 10/12 Dimensions	59

Notes:

Introduction

This Owner's Manual describes how to install, set up and operate the Vidikron Vision Model 10 and Model 12 DLP Projectors. Throughout this manual, the Vidikron Vision 10/Vision 12 DLP Projector is referred to simply as the "Vision 10/12."

Vidikron has prepared this manual to help home theater installers and end users get the most out of the Vision 10/12.

Vidikron has made every effort to ensure that this manual is accurate as of the date it was printed. However, because of ongoing product improvements and customer feedback, it may require updating from time to time. You can always find the latest version of this and other Vidikron product manuals on-line, at www.vidikron.com.

Vidikron welcomes your comments about this manual. Send them to info@vidikron.com.

Text Conventions: The following conventions are used in this manual, in order to clarify the information and instructions provided:

- Remote and built-in keypad button identifiers are set in upper-case bold type; for example, "Press **EXIT** to return to the previous menu."
- Computer input (commands you type) and output (responses that appear on-screen) is shown in monospace (fixed-width) type; for example: "To change the aspect ratio to Letterbox, type `RRD02`."
- All keys with functional names are initial-capped, set in bold type and enclosed in angle brackets. These keys are the following: **<Enter>**, **<Spacebar>**, **<Control>**, **<Esc>** and **<Tab>**.
- **<Enter>** indicates that you may press either the RETURN or ENTER key on your keyboard if it has both keys.

In addition to these conventions, underlining, boldface and/or italics are occasionally used to highlight important information, as in this example:



*A carriage return **must** be used after each command or string.*

1.1 About This Manual

◀ *Target Audience*

◀ *If You Have Comments About This Manual...*

◀ *Textual and Graphic Conventions*

Graphic Conventions: These symbols appear in numerous places throughout the manual, to emphasize points that you must keep in mind to avoid problems with your equipment or injury:



Tip

TIPS highlight time-saving short cuts and helpful guidelines for using certain features.



Note

NOTES emphasize text with unusual importance or special significance. They also provide supplemental information.



Caution

CAUTIONS alert users that a given action or omitted action can degrade performance or cause a malfunction.



WARNING

WARNINGS appear when a given action or omitted action can result in damage to the equipment, or possible non-fatal injury to the user.



DANGER!

DANGER appears when a given action can cause severe injury or death.

1.2 Using This Manual

Use the following table to locate the specific information you need in this manual.

If you need...	... Turn to page:
Information about obtaining service	iv
General information about the Vision 10/Vision 12 DLP Projector	3
Installation instructions	13
First-time configuration instructions	30
Advanced configuration instructions	46
Troubleshooting tips	53
Vision 10/Vision 12 DLP Projector specifications	57



Vidikron proudly introduces its most affordable home theater projectors to date -- the Vision Model 10 and Model 12. The Vision 10/12 offers a performance feature set based on the latest generation of DLP™ light engines with Vidikron's exclusive Imagix™ video processing technology to produce outstanding blacks, superior contrast performance, maximum screen brightness and an accurate color palette.

The Vision 10/12 is equipped with a precision optics package (with manual zoom lens) plus generous horizontal/vertical mechanical lens shift capabilities and electronic keystone correction for flexible placement within virtually any home theater environment. Among the finest attributes of the Vision 10/12 is its ability to meet the rigid Imaging Science Foundation™ (ISF) industry standards for video fidelity and accurate gray scale tracking -- vital to achieving true-to-life color reproduction and superior black and white performance.

The Vision 10/12 accepts high-definition, HDCP-compliant signals from today's latest digital sources, and provides a generous array of component, composite, S-video and VGA inputs, as well as Discrete IR and RS-232 control allowing integration with other audio/video components and automated control systems.

The Vision 10/12 offers these key features and benefits:

- Native Resolution: 1024 x 576 (Model 10) or 1280 x 720 (Model 12)
- 16:9 Native Aspect Ratio
- High-performance Digital Light Processing (DLP™) engine
- HDMI Input with High-bandwidth Digital Content Protection (HDCP)
- HDTV Compatible

1.3 Description, Features and Benefits

◀ Key Features and Benefits

Parts List ➤ Your Vision 10/12 is shipped with the following items. If any items are missing or damaged, please contact your Vidikron dealer or Vidikron Customer Service at (888) 4VIDIKRON.

- Vision 10/Vision 12 DLP Projector
- AC Power Cord (North America)
- AC Power Cord (Europe)
- Remote Control Unit and two (2), AAA-size batteries
- HD 15-pin VGA to HD 15-pin VGA cable
- DVI-D to DVI-D cable
- DVI-to-HDMI adapter
- Composite video cable (RCA)
- +12-Volt Trigger adapter (3.5-mm, mini phono plug)
- Warranty information and registration card
- Vidikron Vision Model 10/Model 12 Owner's Operating Manual (this document)

Optional Accessories:

- Ceiling mount kit

Controls and Functions

2.1 Vision 10/12 at a Glance

Figure 2-1 and Figure 2-2 show the locations of key Vision 10/12 projector components.

◀ *Front/Top/Side View*

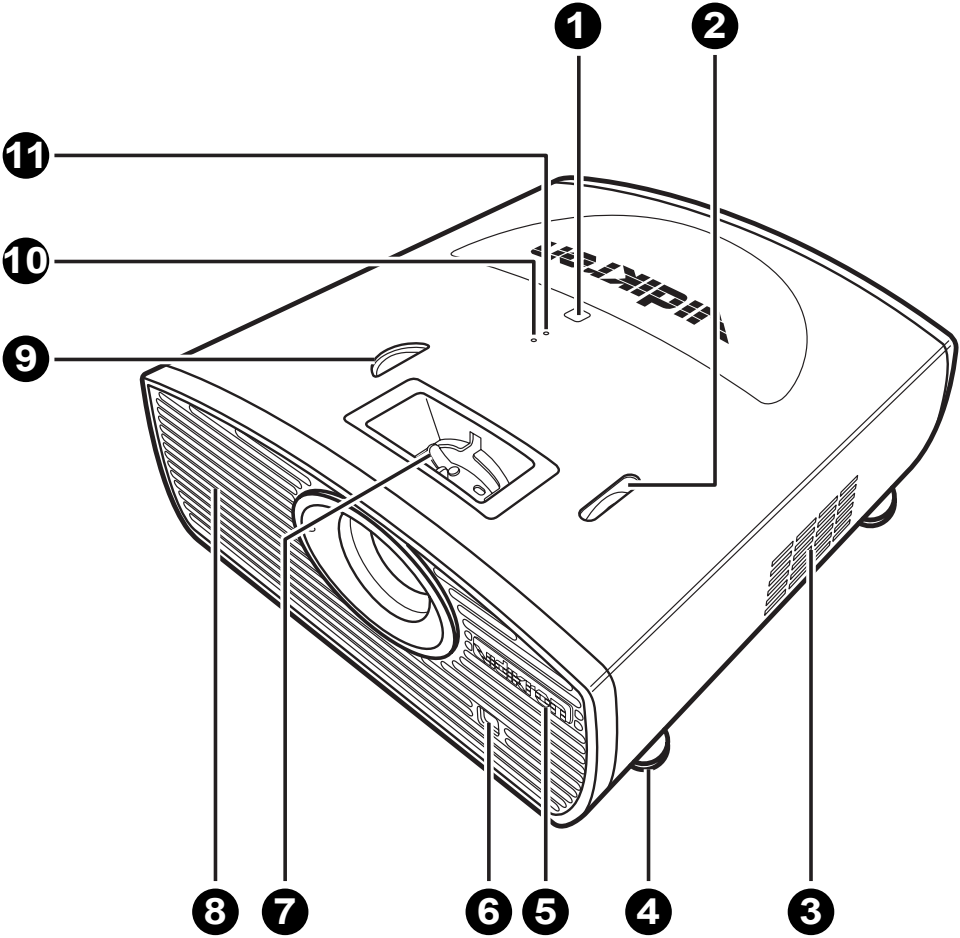

Figure 2-1. Vision 10/12 Top/Front/Side View

1. **TOP IR SENSOR**
2. **VERTICAL LENS SHIFT DIAL**
Shifts the image up or down.
3. **INTAKE VENT**
4. **ADJUSTABLE FEET**
Use to adjust the height or projection angle.
5. **VIDIKRON LOGO**
The logo can be rotated to match the projector orientation: inverted (ceiling-mounted) or upright. To rotate the logo, grip it at the sides, pull it away from the projector and rotate it 180 degrees.
6. **FRONT IR SENSOR**
7. **FOCUS/ZOOM RING**
8. **EXHAUST VENT**
9. **HORIZONTAL LENS SHIFT DIAL**
10. **TEMPERATURE INDICATOR**
Flashes blue when the projector is overheated.
11. **POWER INDICATOR**
Lights solid blue when the projector is in standby mode; flashes blue during cool-down. During normal operation, this LED is off.

◀ Rear/Top/Side View

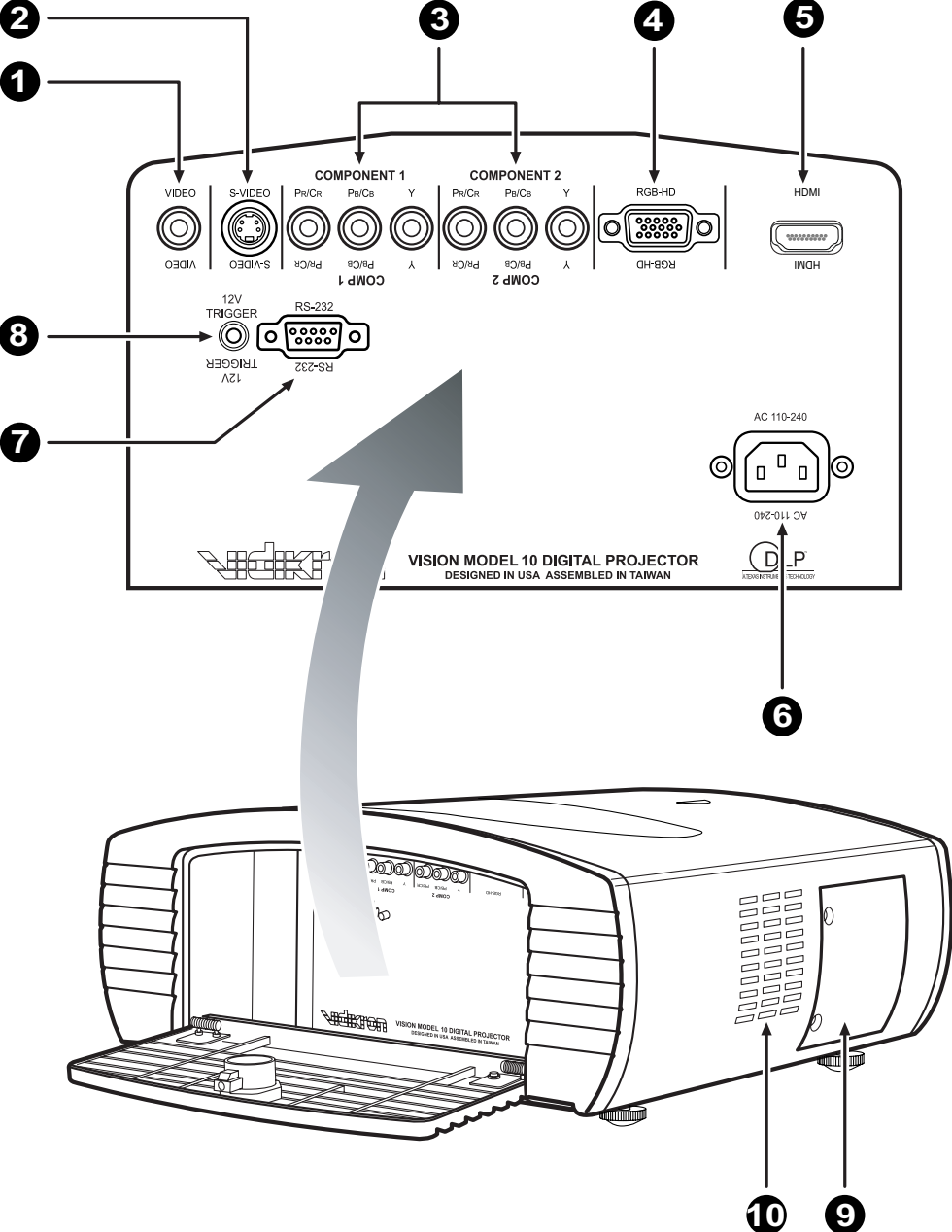

Figure 2-2. Vision 10/12 Rear/Top/Side View

1. **COMPOSITE VIDEO INPUT**
Standard composite video input for connecting a VCR, camcorder, laser disc player or other composite video source.
2. **S-VIDEO**
Standard S-Video input for connecting a DVD player, satellite receiver or Super VHS (S-VHS) VCR.
3. **COMPONENT VIDEO (RCA connectors)**
Standard-definition (480i/576i) or high-definition (720p/1080i), YPrPb component input. This is the input for component video from sources such as DVD players.



Tip

For best results, do not run your DVD player in progressive mode.

4. **RGB HD**
A 15-pin VGA connection to a personal computer or HD tuner with an RGB output. The Vision 10/12 automatically detects the signal resolution: 480p, 576i, 720p or 1080i.
5. **HDMI / Computer Input (Digital)**
HDCP-compliant digital video input for connecting a DVD player, personal computer or HD tuner with a DVI or HDMI output.
6. **POWER INPUT (100 to 240 VAC)**
Connect the Vision 10/12 to power here.
7. **RS-232 CONTROL PORT**
A female, 9-pin D-sub connector for interfacing with a PC or home theater automation/control system.
8. **12-VOLT TRIGGER (3.5-mm mini phono jack; Tip = +12V; Sleeve = Ground)**
For connecting to retractable screens or other devices that respond to 12-volt triggers. Outputs +12 volts / 250 milliamps when the projector is turned on.
9. **LAMP COVER**
10. **EXHAUST VENT**

Figure 2-3 shows the Vision 10/12 remote control, and the paragraphs that follow describe its functionality.

2.2 Vision 10/12 Remote Control

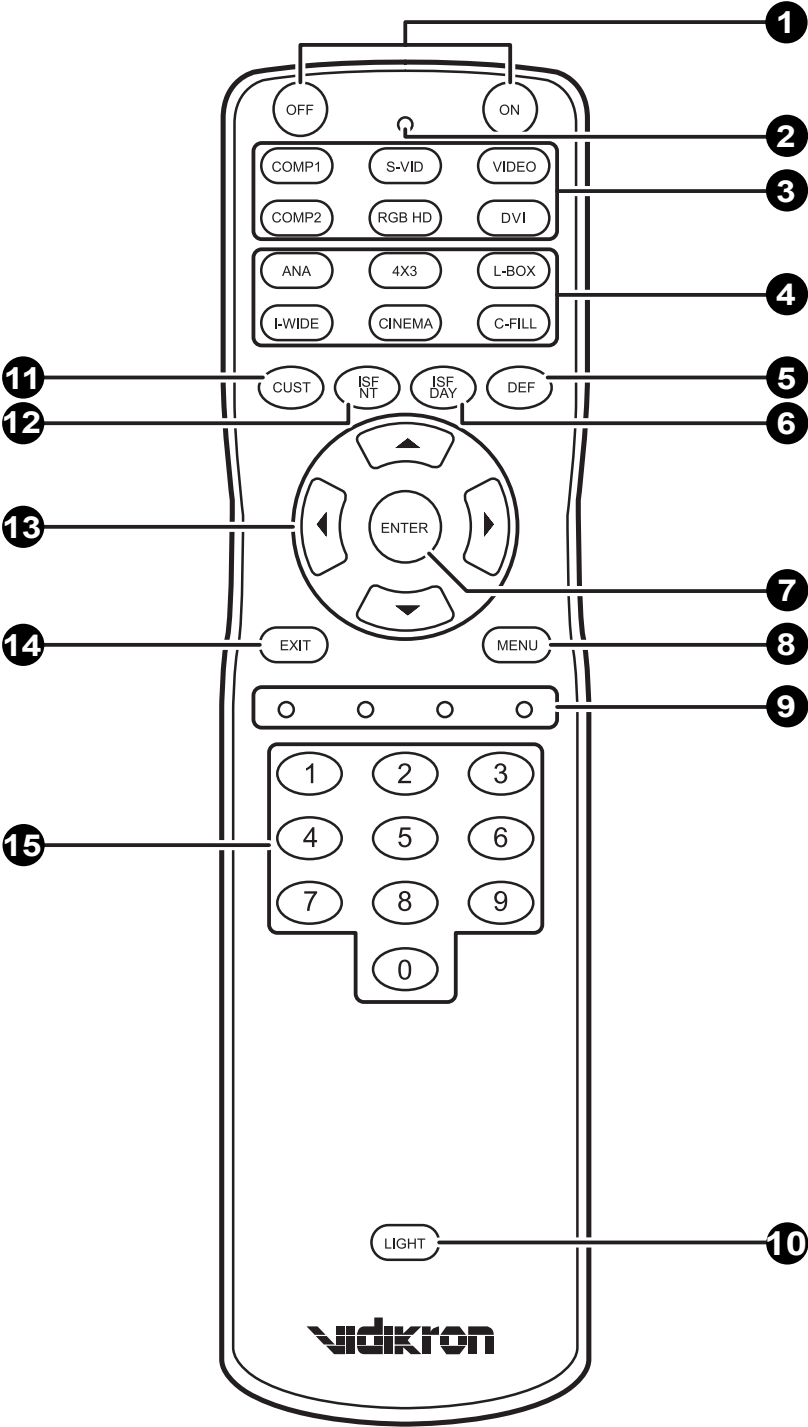

Figure 2-3. Vision 10/12 Remote Control

1. **ON / OFF**

Press to turn the projector on or off.

2. **IR OUTPUT INDICATOR**

Lights when a button is pressed to indicate that an IR signal is being transmitted.

3. **Source Selection Buttons:**

VIDEO

Press to switch to the Composite video input.

COMP 1 (Component 1)

Press to switch to the Component 1 (480i/576i/720p/1080i) video input.

RGB HD

Press to switch to the RGB HD input.

S-VID 1 (S-Video)

Press to switch to the S-Video input.

COMP 2 (Component 2)

Press to switch to the Component 2 (480i/576i/720p/1080i) video input.

DVI

Press to switch to the Digital Video (HDMI) input.

4. **Aspect Ratio Selection Buttons:**

ANA (Anamorphic)

For viewing 16:9 DVDs or HDTV programs in their native aspect ratio.

4X3 (Standard 4:3)

Scales the input signal to fit 4:3 display mode in the center of the screen.

L-BOX (Letterbox)

For viewing LaserDisc movies or non-anamorphic DVDs on a 4:3 screen.

I-WIDE (IntelliWide)

Enlarges a 4:3 image horizontally in a NON-linear fashion to fit 16:9 full screen display.

CINEMA

For viewing 2.35:1 source material on a 1.78:1 (16:9) screen. The upper and lower portions are masked.

C-FILL (CinemaFill)

Stretches a 2.35 image vertically in both directions to fill a 16:9 screen.

5. **DEF**

Press to restore factory-default settings for the current source.

6. **ISF DAY**

Press to recall settings for the current input from the "ISF Day" memory preset.

7. **ENTER**

Press to select a highlighted menu item or confirm a changed setting.

8. **MENU**

Press this button to access the on-screen display (OSD) controls.

-
9. Not used.
 10. **LIGHT**
Press this button to illuminate the buttons.
 11. **CUST**
Press to recall settings for the current input from the "Custom" memory preset.
 12. **ISF NIGHT**
Press to recall settings for the current input from the "ISF Night" memory preset.
 13. **Cursor Keys (▲, ◀, ▼, ▶)**
Use these buttons to select items or settings, adjust settings or switch display patterns.
 14. **EXIT**
Press this button to exit the current menu and return to the previous one.
 15. **NUMBER KEYS**
Use these buttons to enter menu passcodes.

Notes:

To install batteries in the remote control:

1. Press down the tab on the cover and pull the cover in the direction of the arrow.

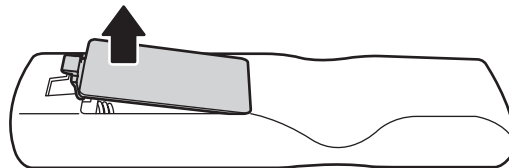

2. Insert the included batteries. Ensure that the polarities correctly match the \oplus and \ominus markings inside the battery compartment.

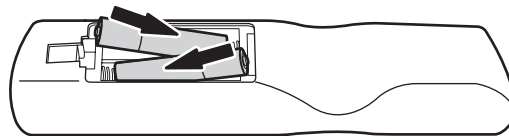

3. Insert the lower tab of the cover into the opening, and press down the cover until it clicks in place.

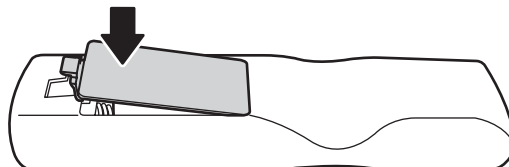

- When installing batteries, make sure that the battery polarities are correct.
- Do not mix an old battery with a new one or different types of batteries.
- If you will not use the remote control for a long time, remove the batteries to avoid damage from battery leakage.

3.1 Remote Control

◀ Notes on Batteries

Notes on Remote Control Operation

The remote control can be used to control the projector within the ranges shown in Figure 3-1.

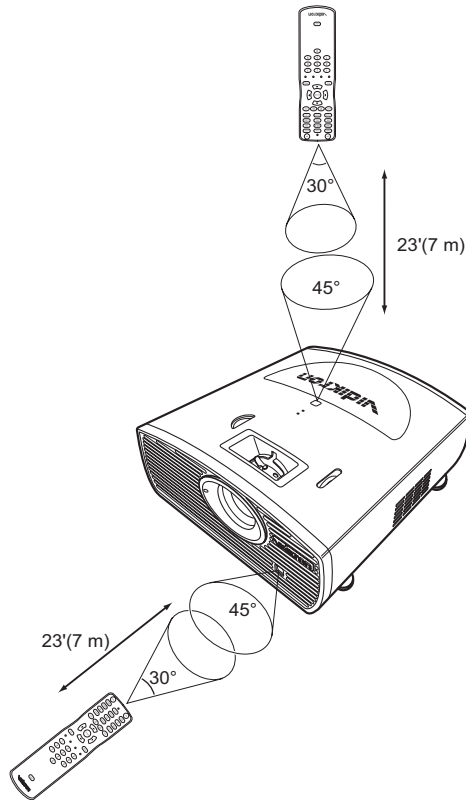

Figure 3-1. Available Range of the Remote Control



Note

The signal from the remote control can be reflected by the screen.

- For best results, hold the remote control within 23 feet (7m) of the back or top sensor and aligned within 30°.
- Do not drop the remote control or expose it to moisture or high temperature.
- The remote control may malfunction under a fluorescent lamp. If that occurs, move the projector away from the fluorescent lamp.
- Make sure that there is nothing obstructing the infrared beam between the remote control and the IR receiver on the projector.
- If the effective range of the remote control decreases, or it stops working, replace the batteries with new ones.
- Ambient conditions may possibly impede the operation of the remote control. If this happens, point the remote control at the projector, and repeat the operation.

Table 3-1 gives a quick overview of the Vision 10/12 installation process. The sections following this one provide detailed instructions.

3.2 Quick Setup



Note

Installation should be performed by a qualified custom video installation specialist.

Table 3-1. Installation Overview

Step	Procedure	For Details, refer to page...
1	Choose a location for the projector	16
2	Connect signal sources to the projector	22
3	Connect external controller to RS-232 port (optional)	27
4	Apply power to the projector	29
5	For rear-screen and/or ceiling-mount installations, select the proper picture orientation	30
6	Lens adjustments: projected image size (zoom), position (shift) and focus	18, 31
7	Projector calibration: adjust the following for each input , starting with Component SD; save settings when finished: <ul style="list-style-type: none"> • Aspect ratio • Brightness • Contrast • Color level • Tint • Input position 	34 through 43

3.3 Installation Considerations

Proper installation of your projector will ensure the quality of your display. Whether you are installing a projector temporarily or permanently, you should take the following into account to ensure your projector performs optimally.

Installation Type ➤ Choose the installation type that best suits your needs: front or rear screen, floor mount or inverted mount. Table 3-2 compares these various installation methods.

Table 3-2. Projector Installation Options

Advantages	Considerations
Front Screen, Floor Mount Installation	
<ul style="list-style-type: none"> • Easy to set up • Can be moved or changed quickly • Easy to access 	<ul style="list-style-type: none"> • Shares floor space with audience
Front Screen, Inverted Mount (ceiling) Installation	
<ul style="list-style-type: none"> • Does not take up audience space • Projector is unobtrusive • Projector cannot be accidentally moved 	<ul style="list-style-type: none"> • Installation is more permanent • Projector access is more difficult
Rear Screen, Floor Mount Installation	
<ul style="list-style-type: none"> • Projector is completely hidden • Projector is easily accessed • Usually good ambient light rejection 	<ul style="list-style-type: none"> • Requires separate room • Installation cost is usually higher
Rear Screen, Inverted Mount (ceiling) Installation	
<ul style="list-style-type: none"> • Projector is completely hidden • Usually good ambient light rejection 	<ul style="list-style-type: none"> • Requires separate room • Installation cost is usually higher
Rear Screen, Floor Mount with Mirror	
<ul style="list-style-type: none"> • Projector is completely hidden • Usually good ambient light rejection • Requires less space behind screen than other rear screen installations 	<ul style="list-style-type: none"> • Requires separate room • Installation cost is usually higher

Ambient Light ➤ In general, minimize or eliminate light sources directed at the screen. Contrast ratio in your images will be noticeably reduced if light directly strikes the screen, such as when a shaft of light from a window or floodlight falls on the image. Images may then appear washed out and less vibrant.

Other Considerations ➤ Other considerations and tips that can help improve your installation:

- Keep the ambient temperature constant and below 35°C (95°F). Keep the projector away from heating and/or air conditioning vents. Changes in temperature may cause drifts in the projector circuitry, which may affect performance.
- Keep the projector away from devices that radiate electromagnetic energy such as motors and transformers. Common sources of these include slide projectors, speakers, power amplifiers and elevators.

Throw distance is the distance measured from the front of the projector to the screen. This is an important calculation in any projector installation as it determines whether or not you have enough room to install your projector with a desired screen size and if your image will be the right size for your screen.

◀ **Throw Distance**

You can quickly estimate the throw distance by taking the width of the screen and multiplying it by the lens throw ratio; see Figure 3-2.

- **The Vision 10 has a lens throw ratio of between 1.40 and 1.60.**
- **The Vision 12 has a lens throw ratio of between 1.42 and 1.65.**

The result of this calculation tells you roughly how far back the projector should be positioned from the screen in order to project a focused image large enough to fill the screen.

For example, with an 8-foot (96-inch) wide screen:

- The Vision 10 has a throw distance range of between 134.4 inches (3.41 meters) and 153.6 inches (3.90 meters).
- The Vision 12 has a throw distance range of between 136.3 inches (3.46 meters) and 158.4 inches (4.02 meters).

Estimating Throw Distance (TD)

Vision Model 10

Minimum TD = Screen Width x 1.40
Maximum TD = Screen Width x 1.60

Vision Model 12

Minimum TD = Screen Width x 1.42
Maximum TD = Screen Width x 1.65

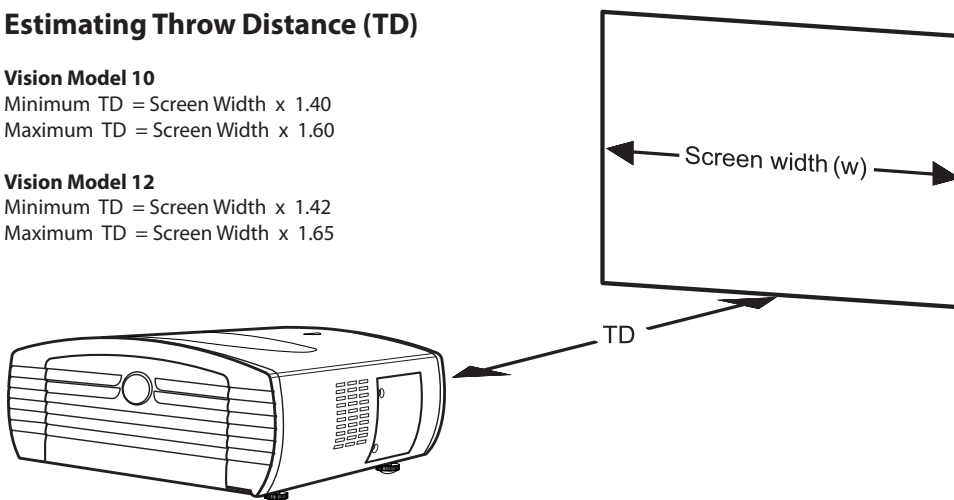

Figure 3-2. Estimating Throw Distance

Vertical and Horizontal Position

Proper placement of the projector relative to the screen will yield a rectangular, perfectly-centered image that completely fills the screen.

Ideally, the projector should be positioned perpendicular to the screen and in such a way that the lens center and screen center are aligned with each other, as shown in Figure 3-3.

Ceiling Installation

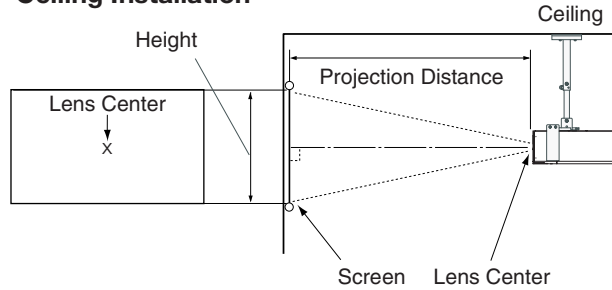

Floor Installation

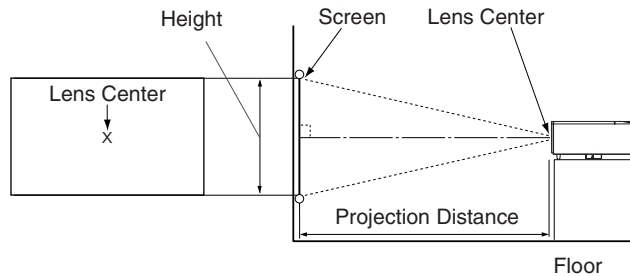
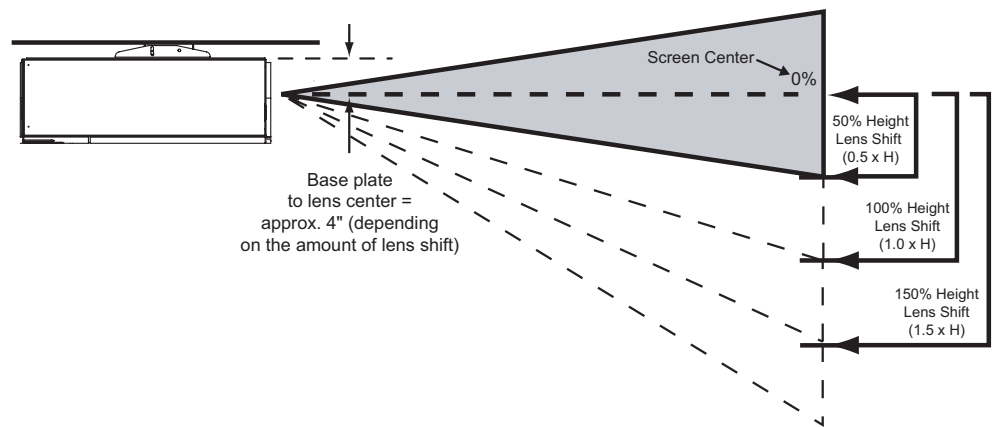

Figure 3-3. Projector Placement

Vertical and Horizontal Lens Shift

If it is not possible to align the projector and screen as shown in Figure 3-3, you can use the lens shift controls to center the image on the screen. Lens shift is generally expressed as a percentage of the screen height or width, as shown in Figure 3-4 and Figure 3-5.



Note: This is a general example of lens shift. Lenses vary in their shift capabilities. **No particular lens or projector is used in this example.**

Figure 3-4. Vertical Lens Shift (Example only)

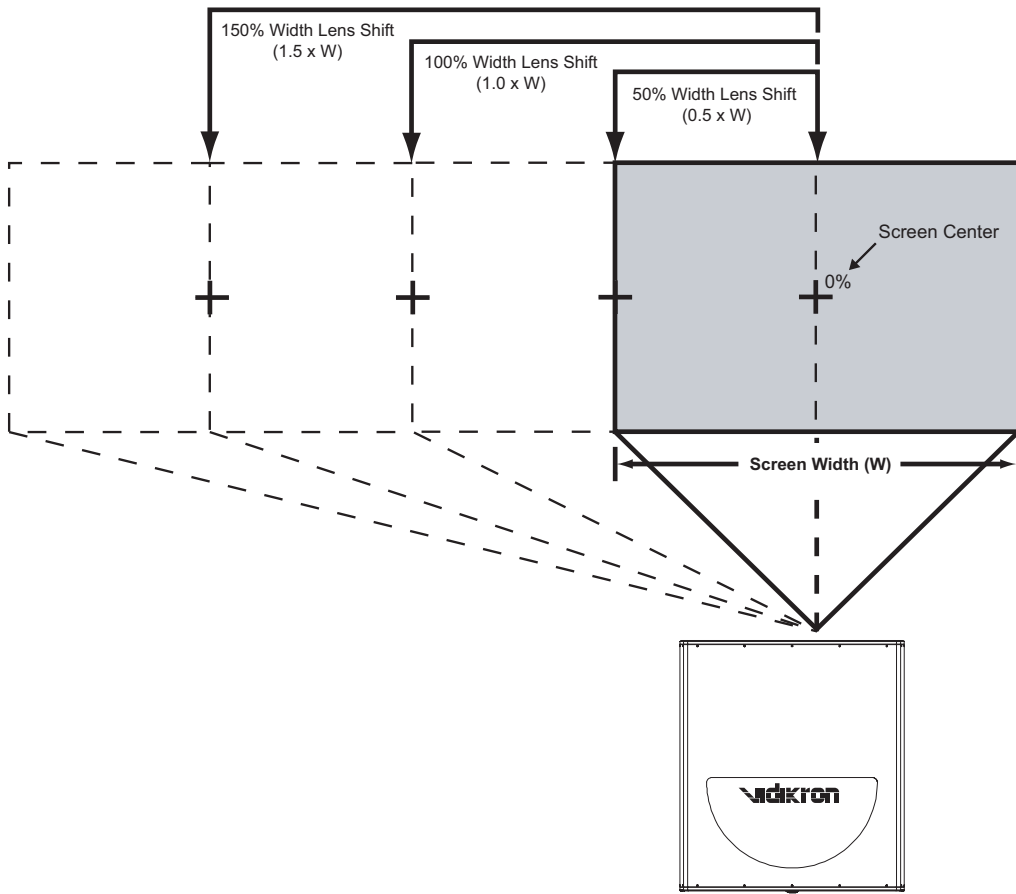

Note: This is a general example of lens shift. Lenses vary in their shift capabilities. **No particular lens or projector is used in this example.**

Figure 3-5. Horizontal Lens Shift (Example only)

Table 3-3 gives the lens shift limits for the Vision 10 and Vision 12, as percentages and absolute measurements with a 96 x 54 inch (1.78:1) screen.

Table 3-3. Vertical and Horizontal Lens Shift Limits

		Vision 10	Vision 12
Lens Shift Limits, as Percentages of Screen Height or Width (Notes 1 and 2)			
Vertical (Notes 2 and 3)	Up	40%	46%
	Down	60%	63%
Horizontal (Note 2)	Left	8%	
	Right	8%	
Lens Shift Limits in Inches, with a 96-by-54 inch (1.78:1) Screen			
Vertical	Up	21.60	24.84
	Down	32.40	34.02
Horizontal	Left	7.68	
	Right	7.68	
<p><i>Notes:</i></p> <p>1. With no vertical or horizontal lens shift, the lens center and screen center are aligned with each other.</p> <p>2. Vertical shift limits are percentages of the screen height. Horizontal shift limits are percentages of the screen width.</p> <p>3. Vertical lens shift figures apply to ceiling mount configurations. For floor installations (where the projector is upright), reverse the up/down vertical offset percentages.</p>			

Adjusting the Projection Angle ➤

If the screen is significantly higher or lower than the projector, you can also tilt the projector at a slight angle. In a ceiling installation, you do this by adjusting the ceiling mount. For a floor installation, turn the four adjustable feet on the bottom of the projector to adjust the projector height and/or projection angle.

If you do this, you may need to shift the image or apply keystone correction using the on-screen display (OSD) controls, to compensate. For detailed instructions, refer to **Using the On-Screen Menus** on page 32.

There are several methods for mounting the projector. Depending on your chosen installation, one method may be more suitable than another.

◀ **Mounting**

Floor Mounting: In typical front and rear screen installations the projector can be mounted to a secure and level surface, such as a table or cart. Carts are useful when moving a projector during a presentation or from site to site. If possible, lock the wheels when it's in position to prevent it from being moved during a presentation.

Ceiling Mounting: The projector can also be inverted and suspended from the ceiling using a specially designed ceiling mount fixture. This type of mounting is recommended for fixed installations and for those that want the projector out of sight or have a limited space for projector and audience.



Note

Use only the Vidikron-approved ceiling mount kit designed for your projector.

In rear-screen applications where space behind the projector is limited, a mirror may be used to fold the optical path, as shown in Figure 3-6. The position of the projector and mirror must be accurately set. If you are considering this type of installation, contact your dealer for assistance.

◀ **Folded Optics**

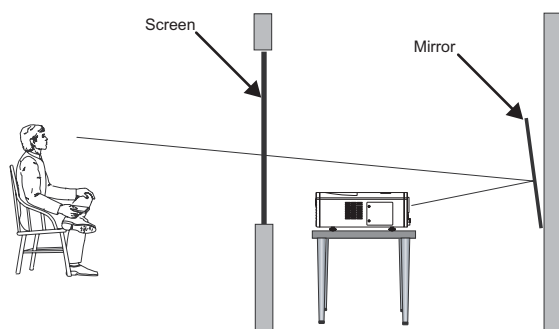

Figure 3-6. Folded Optics

3.4 Connections to the Vision 10/12

Proceed as follows to connect the Vision 10/12 to your video sources, external controller(s) – if present – and AC power.

When connecting your equipment:

- Turn off all equipment before making any connections.
- Use the correct signal cables for each source.
- Ensure that the cables are securely connected. Tighten the thumbscrews on connectors that have them.



Tip

Route all cables through the opening on the rear underside of the projector. This allows you to keep the connector panel access door closed, making for a more tidy installation.

Connector Panel Access

- To access the connector panel, press and hold the black door release button. Then, pull gently on it to open the door.

Connecting the Vision 10/12 to Source Components

- Connect your video sources to the Vision 10/12 as shown and described in the sections that follow.

HDMI Connections: The Vision 10/12 has an HDMI input for connecting a DVD player, DTV decoder, personal computer or any other device with a DVI or HDMI output. Connect such devices as shown in Figure 3-7.



Tip

Use the HDMI inputs whenever possible. This ensures the highest video quality because the signal is carried in the digital domain throughout the entire signal path, from source component output into the projector.



Note

The Vision 10/12 supports the VESA Display Data Channel (DDC) standard. This standard provides “Plug and Play” capability; the projector and a VESA DDC-compatible computer communicate their setting requirements, allowing for quick and easy setup.

In order for Plug and Play to work correctly, you must turn on the projector before you turn on the connected computer.

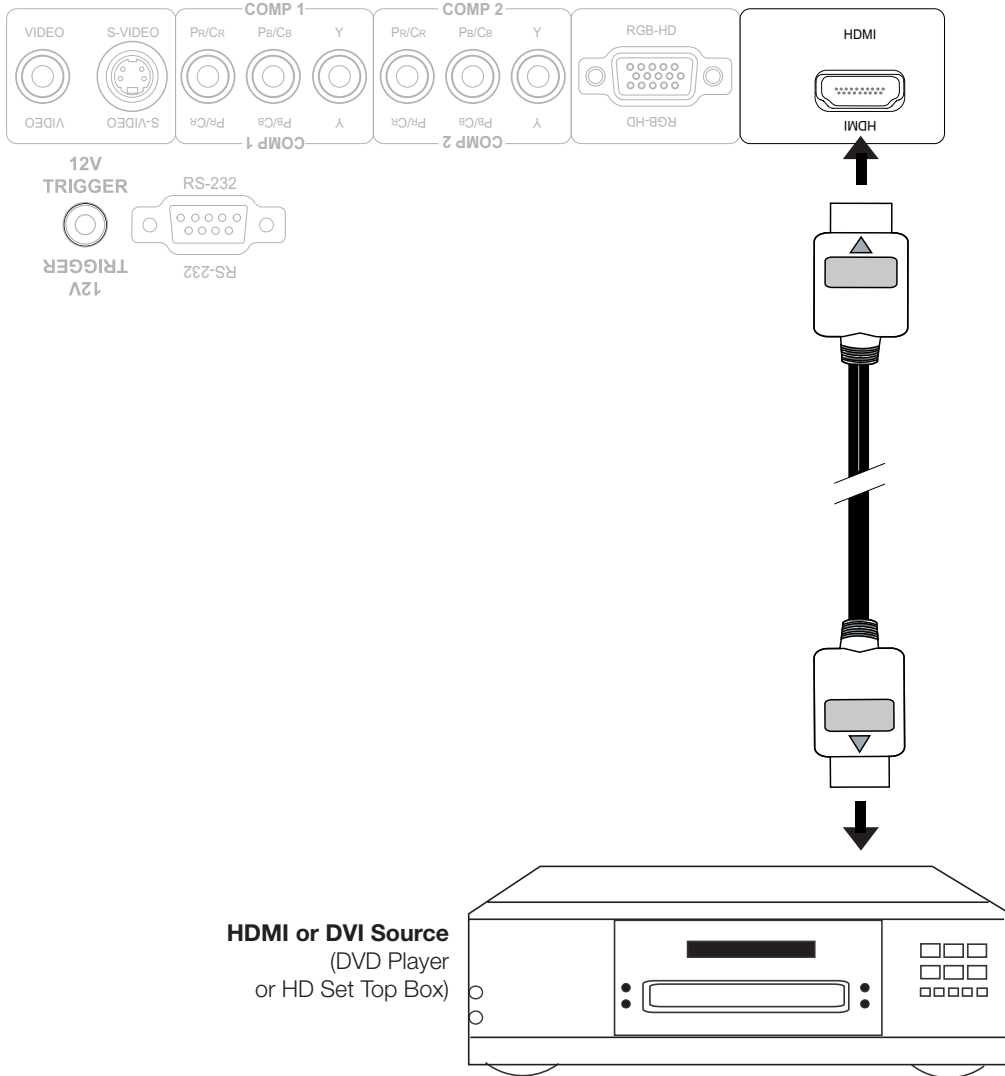

Note: To connect a DVI source, use the HDMI-to-DVI adapter and DVI cable provided with the projector.

Figure 3-7. HDMI (or DVI) Source Connections

RGB-HD Connections: The Vision 10/12 has an RGB input for connecting a personal computer or DTV decoder with an RGB output. See Figure 3-8.

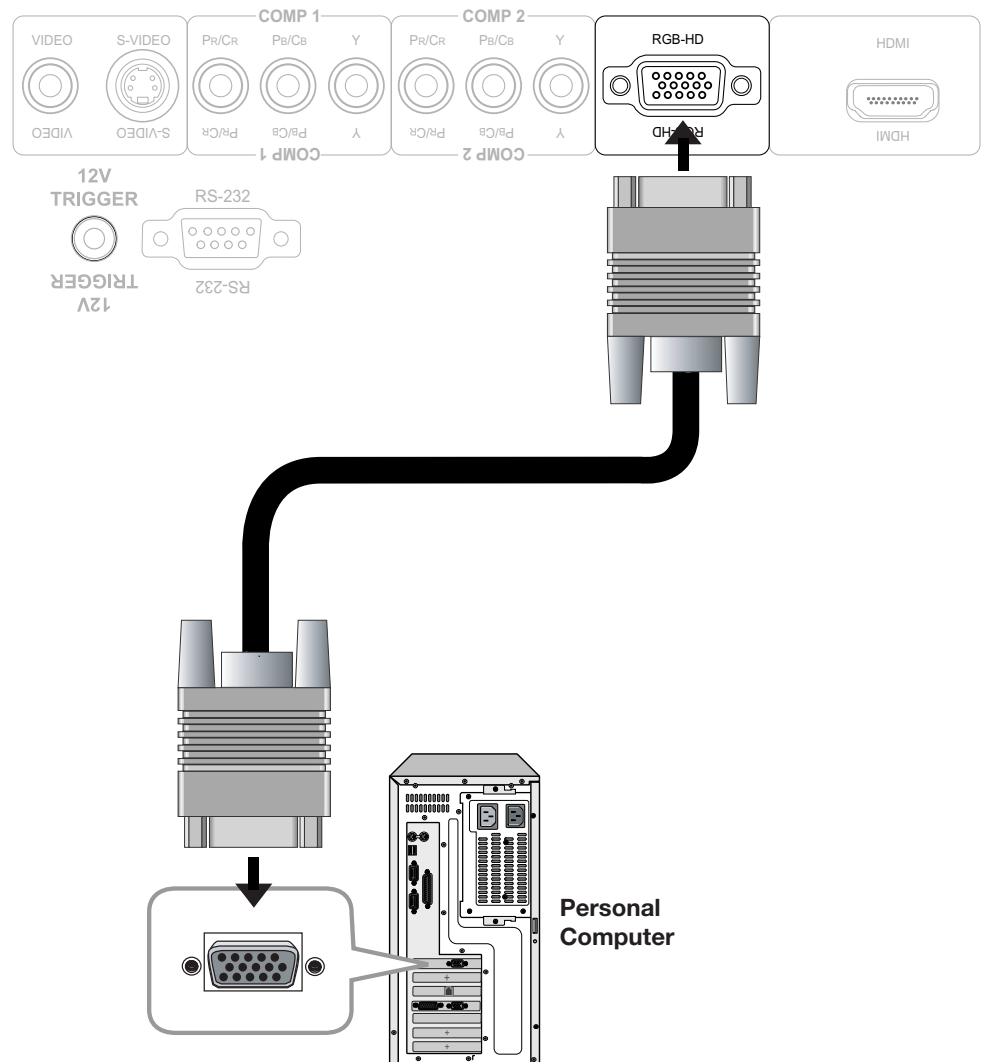

Figure 3-8. Analog RGB Connections



Note

1. Refer to **Computer Signal Compatibility** on page 60 for a list of computer signals compatible with the Vision 10/12. Use with signals other than those listed may cause some functions not to work.
2. Some Macintosh computers may require a Macintosh video adapter. Contact your nearest authorized service center or dealer.
3. This Vision 10/12 may not be able to display images from notebook computers in simultaneous (CRT/LCD) mode. Should this occur, switch the notebook computer to "CRT only" mode. If you are unsure how to do this, refer to your notebook computer's user manual.

Component Video Connections: If you have a DVD player or DTV decoder with a component (YPbPr) output, connect it to the COMP 1 or COMP 2 input as shown in Figure 3-9.

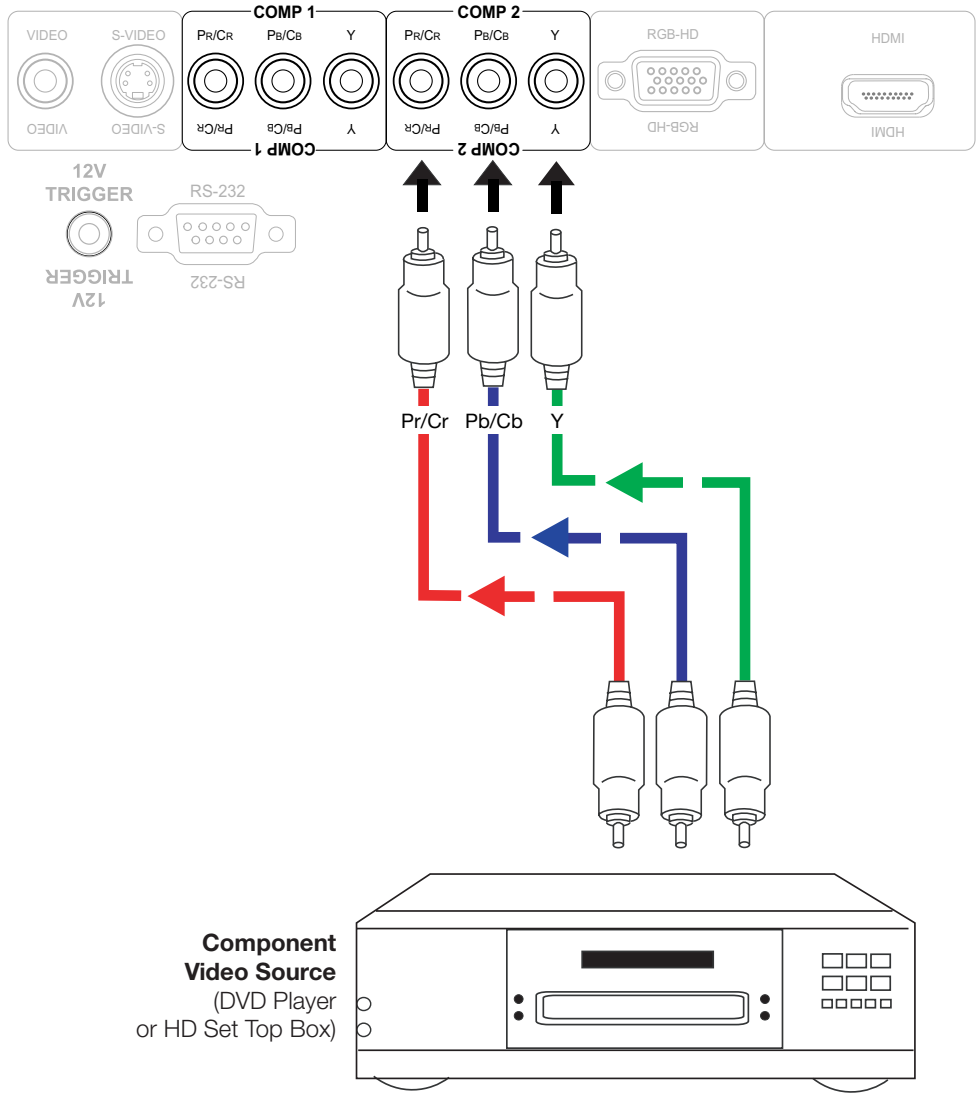

Figure 3-9. Component Video Connections

Composite/S-Video Connections: The Vision 10/12 has S-Video and composite video inputs for connecting a DVD player, VCR, satellite receiver, camcorder, laser disc player et cetera; see Figure 3-10.

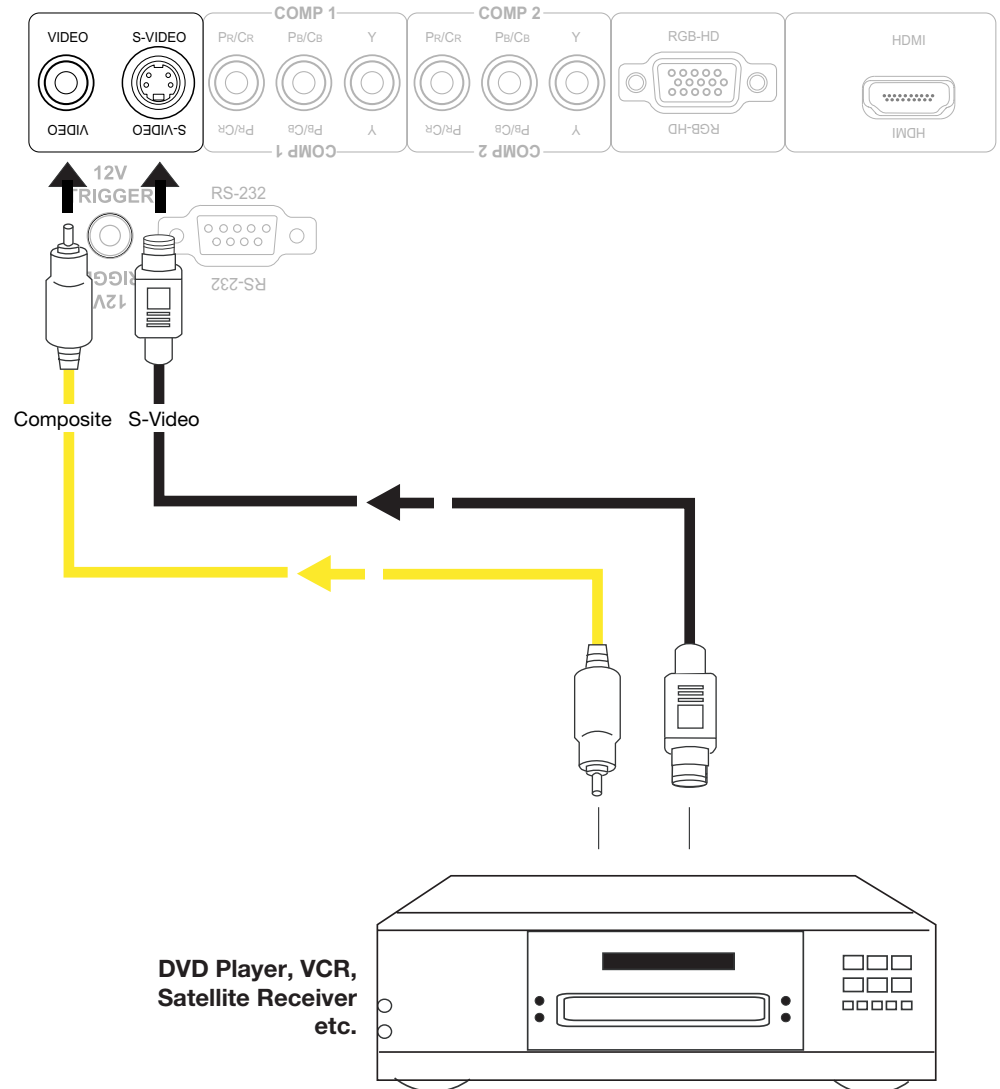

Figure 3-10. Composite and S-Video Connections

Use a standard, 9-pin RS-232 cable to connect a PC or home theater control/automation system (if present) to the RS-232 port on the Vision 10/12; see Figure 3-11.

◀ **RS-232 Controller Connection**

For more information about using this connection, refer to **Serial Communications** on page 55.

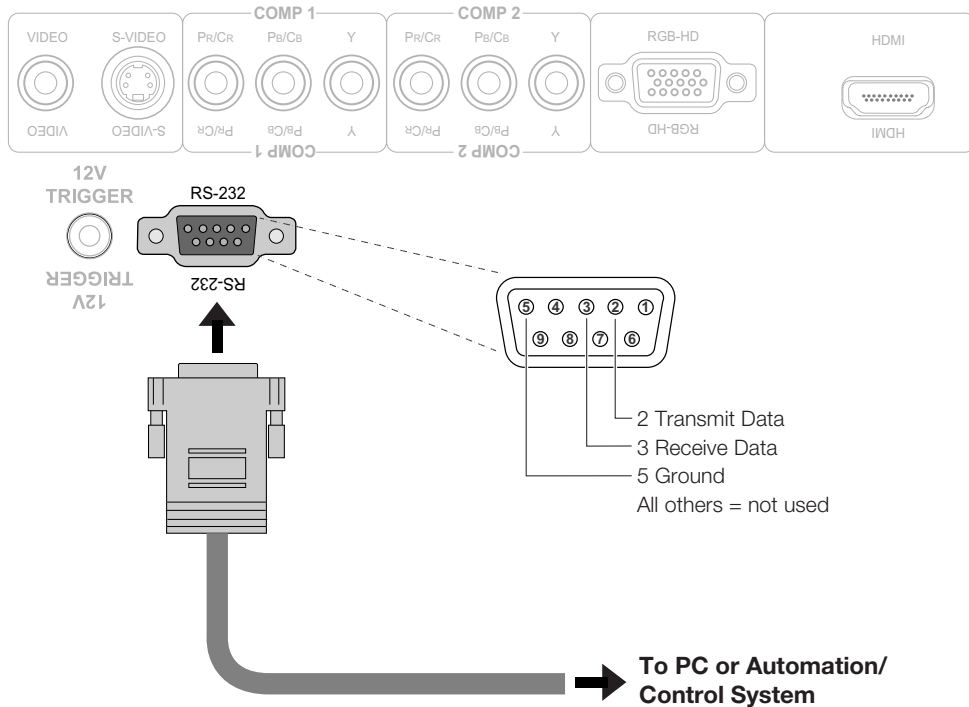

Figure 3-11. RS-232 Control System Connection

Connecting to the 12-Volt Trigger Output

If your home theater contains a retractable screen or other, 12-Volt trigger-activated equipment, connect it to the 12-volt trigger output on the Vision 10/12 as shown in Figure 3-12.

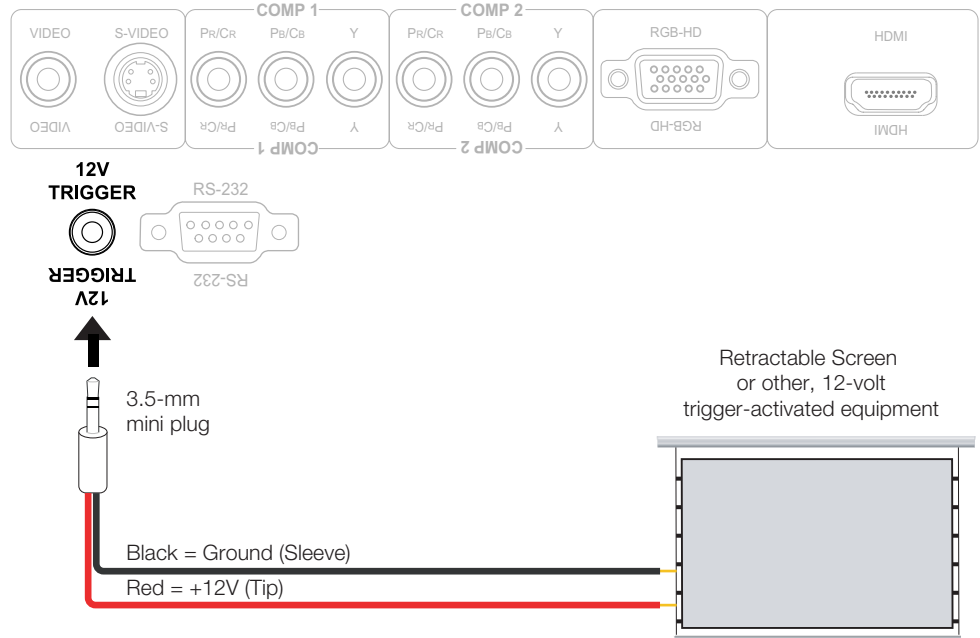
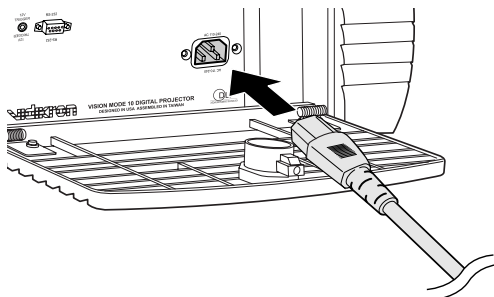

Figure 3-12. Connecting the 12-Volt Trigger Output

1. Turn on your source components.
2. Plug the female end of the power cord into the AC receptacle on the rear of the Vision 10/12 (AC 100V ~ 240V).
3. Connect the other end to your AC power source. The power indicator lights blue to indicate that the Vision 10/12 is in "standby" mode.
4. Press the **ON** button on the remote control to turn on the projector. The power indicator turns off.
5. After a brief warm-up period (approximately 10 seconds), the Vision 10/12 will start projecting.



4.1 Turning on the Power

When the Vision 10/12 is installed upright, you can adjust the projector height or projection angle by turning the four adjustable feet on the bottom of the projector; see Figure 4-1. This is useful for correcting the angle of projection when the projector is placed on an uneven surface or when the screen is at an angle. You can tilt the projector up to five (5) degrees up or down by adjusting the feet.

The feet are connected to threaded bolts; turn them clockwise to raise the projector or counterclockwise to lower it.

4.2 Adjusting the Projector Height or Projection Angle



Note

*Tilting the projector may cause keystone distortion. To correct this, refer to **Keystone Correction** on page 45.*

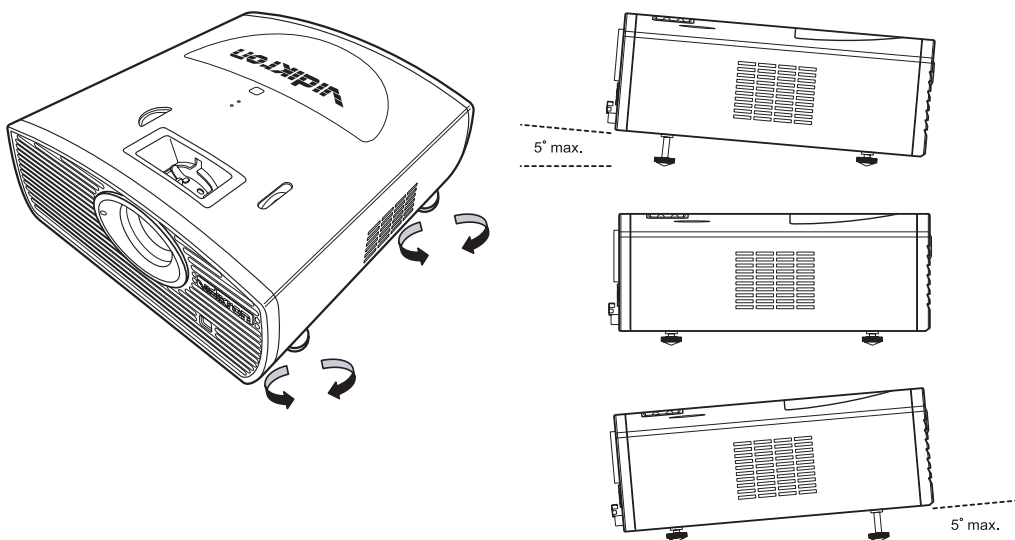

Figure 4-1. Adjusting the Feet

4.3 Changing the OSD Language

The Vision 10/12 OSD language is initially set to English, but can also display the menus in French, Italian, German or Spanish. To change the OSD language:

1. Press **MENU**.
2. Select **Installation** from the Main Menu.
3. Select **Language** from the Installation Menu.
4. Press ◀ or ▶ to select the desired language. The change takes effect immediately.

4.4 Adjusting the Picture Orientation

By default, the Vision 10/12 is configured for a “floor/front” installation, in which the projector is installed upright and in front of the screen. If it is installed behind the screen and/or mounted on a ceiling, you must change the picture orientation. To do this:

1. Press **MENU**.
2. Select **Installation** from the Main Menu.
3. Select **Picture Configuration** from the Installation Menu.
4. Choose Floor Rear, Ceiling Front or Ceiling Rear, to match the installation method.

The Vision 10/12 gives you a great deal of control over the picture size, position and focus. Figure 4-2 shows the location of the focus and zoom controls; Figure 4-3 shows the location of the lens shift controls.

To focus the projected image, rotate the focus ring left or right.

To make the picture larger (zoom in), rotate the zoom ring to the left, toward the Vidikron logo. To make the picture smaller (zoom out), rotate the zoom ring to the right.

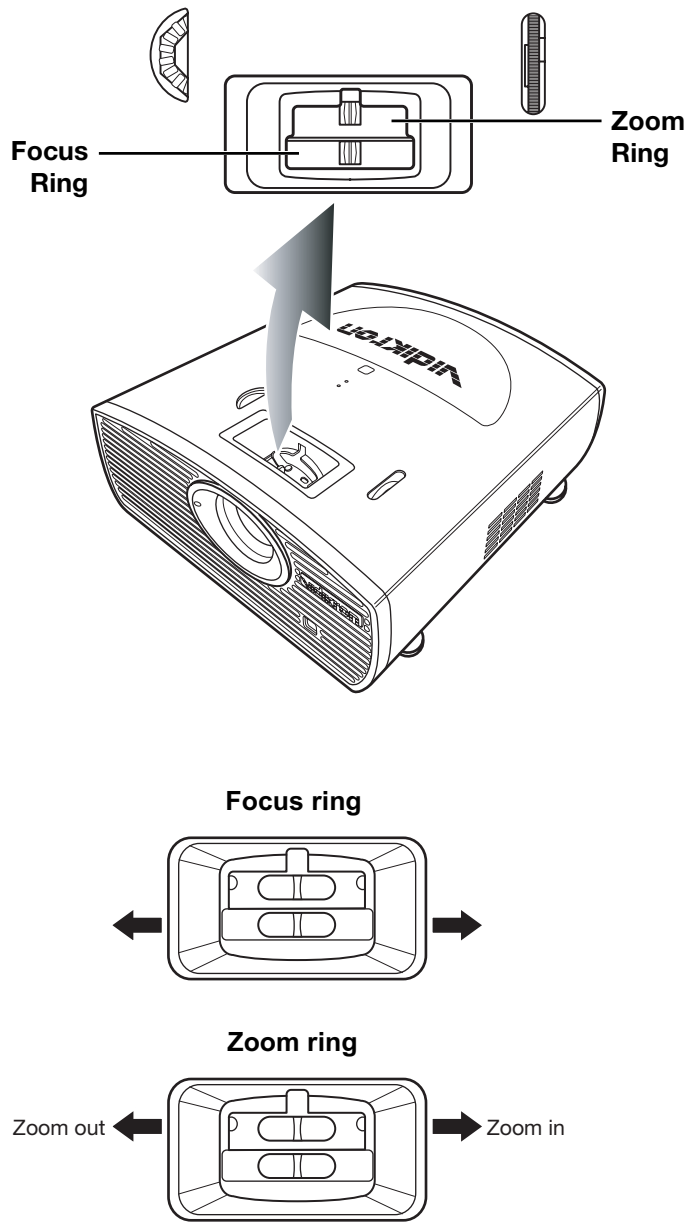

Figure 4-2. Focus and Zoom Controls

4.5 Lens Adjustments

◀ Focus/Zoom

Shift ➤ To change the projected image position, rotate the vertical and/or horizontal lens shift dials.



Note

Do not force the lens shift dials beyond their respective ranges. This may cause the projector to malfunction.

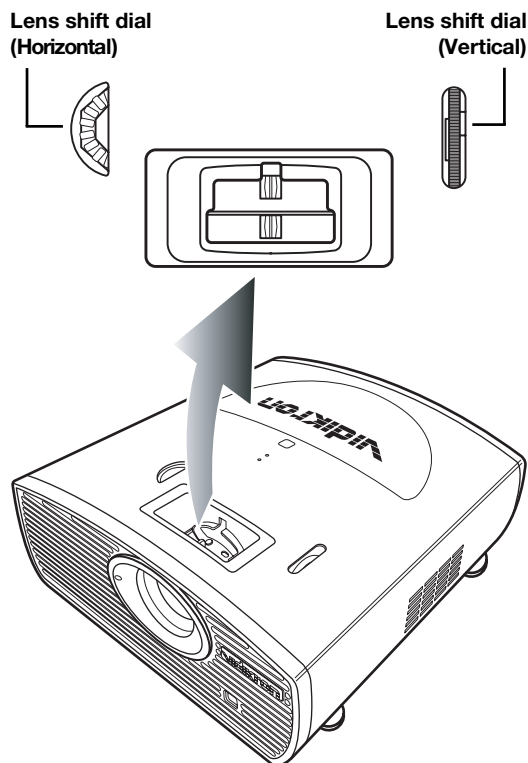

Figure 4-3. Vertical and Horizontal Lens Shift Controls

4.6 Using the On-Screen Menus

To use the on-screen menus:

1. Press **MENU** to display the Main Menu.
2. To select a menu item, use the up- or down-arrow buttons (▲, ▼) on the remote control to highlight it.
3. Press the right- or left-arrow button (◀ or ▶, depending on the OSD position) to access that menu.
4. Use the up- or down-arrow buttons (▲, ▼) to select the setting you want to change.
5. Press the right- or left-arrow button (◀, ▶) to change that setting;

-- OR --

With some settings, you can press **ENTER** to hide the OSD menus and display a sliderbar for that setting only. Then, press the right- or left-arrow button (◀, ▶) to change it.

6. To return to the previous menu, press **EXIT**.

The Vision 10/12 OSD menus are arranged hierarchically, as shown in Figure 4-4. Depending on the selected input source, some menu options may not be available.

Picture Adjust	Brightness	
	Contrast	
	Color	(not available on HDMI or RGB-HD inputs)
	Tint	
	Sharpness	1, 2, 3, 4, 5
	Gamma	1.0, 1.5, 1.8, 2.0, 2.2, 2.35, 2.5, 2.8
	Color Temp	Native, 5,000K, 5,500K, ... 10,000K
	ICC Select	Standard, NTSC, HDTV, PAL
	White Balance	R/G/B Gain R/G/B Offset
	Save Settings	
Load Saved Settings	Custom 1, ISF Day, ISF Night	
Source Select	Video	
	S-Video	
	Component 1	
	Component 2	
	RGB-HD	
	HDMI/DVI	
Aspect Ratio	Anamorphic (16/9)	
	Standard (4/3) (not available with HD signals)	
	LetterBox	
	IntelliWide	
	Cinema	
	Cinema Fill	
Image Option	HD/RGB Adjust (available only when RGB-HD input is selected)	Clock
		Phase
		Reset
		Execute Auto Tune
		Auto Tune
	Image Position (not available on HDMI input)	H Position
		V Position
		Reset
	Over Scan Adjust	0% to 10%
	SDTV Adjust (not available on HDMI or RGB-HD inputs)	Chroma Enhance
		Video On Film (on/off)
		Film Mode
Brightness Enhance	(on/off)	
Lamp Power	200W or 250W	
Information (read-only)	Source, Resolution, V Frequency, H Frequency, Lamp Timer, firmware version	
Restore Factory Settings		
Installation	Language	English, French, Italian, German or Spanish
	Picture Configuration	Floor Front, Ceiling Rear, Floor Rear or Ceiling Front
	OSD Timeout	5 secs., 15 secs. or 60 secs.
	OSD Transparent	(on/off)
	Source Detect	Auto or Manual
	Auto Power Off	(on/off)
	Blue Enable	(on/off)
	OSD Position	Top Left, Bottom Left, Top Right or Bottom Right
	Keystone	V Keystone
		H Keystone
		Reset
Fan High Speed Mode	(on/off)	

ISF Settings	Brightness	
	Contrast	
	Color	(not available on HDMI or RGB-HD inputs)
	Tint	
	Sharpness	1, 2, 3, 4, 5
	Gamma	1.0, 1.5, 1.8, 2.0, 2.2, 2.35, 2.5, 2.8
	Color Temp	Native, 5,000K, 5,500K, ... 10,000K
	Load Saved Settings	Custom 1, ISF Day, ISF Night
	White Balance	R/G/B Gain R/G/B Offset
	Save Settings	
	Lamp Timer Reset	
	ICC Adjust	Standard, NTSC, HDTV, PAL Intensity, Saturation, Hue
	ISF Enable	(on/off)
	Blue Enable	(on/off)
	Splash Screen Timer	15, 20, 25, 30, ... 60 secs.
Noise Reduction	0, 1, 2, ... 8	

Figure 4-4. Vision 10/12 OSD Menu Structure

Main Menu ➤ The Main Menu is the starting point for accessing all projector functions.
(The ISF Settings menu is grayed out and not accessible until you enter a passcode.)

Vision Model 10	
<input checked="" type="checkbox"/>	Picture Adjust
<input type="checkbox"/>	Source select
<input type="checkbox"/>	Aspect Ratio
<input type="checkbox"/>	Image Option
<input type="checkbox"/>	Installation
<input type="checkbox"/>	ISF Settings

Source Select ➤ From the Main Menu, select Source select to choose a video signal source.

The active source is indicated by a green square (■) to its left; in the example at left, Video is the active source.

Source select	
<input checked="" type="checkbox"/>	Video
<input type="checkbox"/>	S-Video
<input type="checkbox"/>	Component 1
<input type="checkbox"/>	Component 2
<input type="checkbox"/>	RGB-HD
<input type="checkbox"/>	HDMI/DVI

Aspect Ratio ➤ To change the aspect ratio (size and shape) of the projected image, select Aspect Ratio from the Main Menu and press **ENTER**. Select the appropriate aspect ratio for the type of program material being viewed; refer to Table 4-1.

The currently-selected aspect ratio is indicated by a green square (■) to its left; in the example at left, Anamorphic is selected.

Aspect Ratio	
<input checked="" type="checkbox"/>	Anamorphic (16/9)
<input type="checkbox"/>	Standard (4/3)
<input type="checkbox"/>	LetterBox
<input type="checkbox"/>	IntelliWide
<input type="checkbox"/>	Cinema
<input type="checkbox"/>	Cinema Fill



Note

*When you change the aspect ratio, save the change to a preset afterwards. Otherwise, the change will be lost when a different input is selected. (The aspect ratio is saved for each input and resolution separately.) For information about saving settings, refer to **Save Settings** on page 42.*

Table 4-1. Aspect Ratio Settings



Aspect Ratio	Remote Control Key	Description	
Anamorphic (16/9)	ANA	 <p>16:9 Image on 16:9 Screen</p> <p>4:3 Image on 16:9 Screen</p>	<p>Select Anamorphic to view 16:9 DVDs and HDTV programs in their native aspect ratio. 4:3 images are stretched horizontally to fit a 16:9 screen.</p>
Standard (4/3)	4X3	 <p>Active Image Area (4:3)</p>	<p>Standard 4:3 scales the input signal to fit in the center of the 16:9 screen. 4:3 is the aspect ratio used by computer monitors, standard television programming and most VHS video cassettes.</p> <p>This aspect ratio is not available with HD signals.</p>
LetterBox	LET BOX	 <p>Letterbox Image on 16:9 Screen</p>	<p>In Letterbox mode, the image is stretched vertically; the top and bottom portions are "blacked off." Letterbox is best suited for viewing LaserDisc movies or non-anamorphic DVDs on a 4:3 screen.</p>
IntelliWide	I-WIDE		<p>A 4:3 image is horizontally scaled in a NON-linear fashion (more on the sides than in the center) to fit a 16x9 screen.</p>
Cinema	CINEMA	 <p>2.35:1 Image on 16:9 Screen</p>	<p>Select Cinema to view 2.35 source material on a 16:9 screen. The upper and lower portions of the screen are masked, but the geometry of the active image area is not changed.</p>

Table 4-1. Aspect Ratio Settings (continued)

Aspect Ratio	Remote Control Key	Description	
Cinema Fill	C-FILL	 	A 2.35 image is stretched anamorphically in both directions to fill a 16:9 image.

Picture Adjust ➤

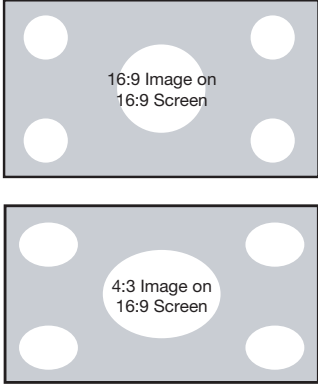
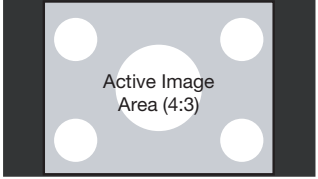
Picture Adjust		
Brightness		0
Contrast		0
Color		0
Tint		0
Sharpness		3
Gamma		2.2
Color Temp		6500K
ICC Select		Standard
White Balance		
Save Settings		
Load Saved Settings		

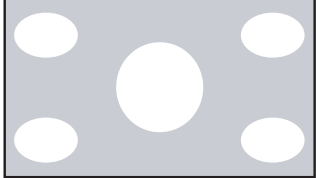
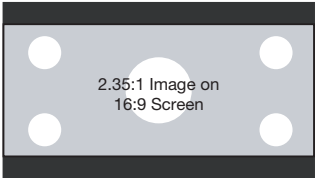
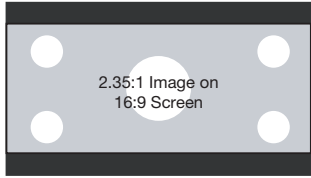
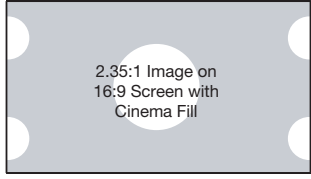
Use the controls in the Picture Adjust menu to calibrate your Vision 10/12 for optimum picture quality.

The Vision 10/12 has been designed to incorporate setup and calibration standards established by the Imaging Science Foundation (ISF). The ISF has developed carefully crafted, industry-recognized standards for optimal video performance and has implemented a training program for technicians and installers to use these standards to obtain optimal picture quality from Vidikron video display devices. Accordingly, Vidikron recommends that setup and calibration be performed by an ISF certified installation technician.

All signal types require separate processing. Therefore, you need to calibrate each input separately. Vidikron recommends calibrating the Vision 10/12 inputs in the following order:

1. Component 1 / Component 2
2. S-Video
3. Video
4. RGB-HD
5. HDMI



Note

*When you change a picture quality setting, save the change to a preset afterwards. Otherwise, the change will be lost when a different input is selected. (Picture quality settings are saved for each input and resolution separately.) For information about saving settings, refer to **Installation** on page 44.*

Although it may be possible to obtain satisfactory picture quality using the naked eye and regular program material, Vidikron recommends using the following calibration tools for best results:

- External test pattern source -- Sencore VP401 Multimedia Video Generator, Ovation Multimedia test DVD or equivalent.
- A blue filter (provided with many test DVDs), for color level and tint adjustments.

Connect your test pattern source to the input that you are calibrating and proceed as follows.

Perform the adjustments in the order listed here.

Brightness: On your external test pattern source, select a PLUGE pattern. (PLUGE is an acronym for "Picture Line-Up Generation Equipment.") Figure 4-5 shows a typical PLUGE pattern.

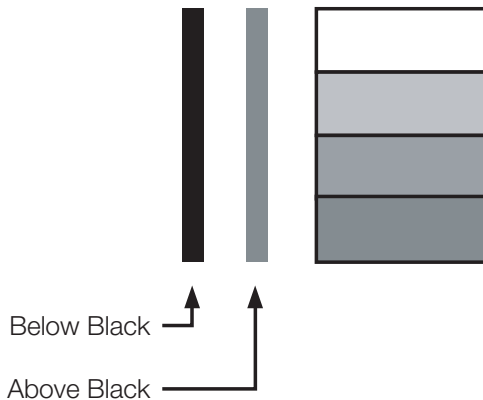

Figure 4-5. Typical PLUGE Pattern for Adjusting Brightness

PLUGE patterns vary but generally consist of some combination of black, white and gray areas against a black background. The example above includes two vertical bars and four shaded boxes.

Select Brightness from the Picture Adjust menu. Using the left- and right-arrow (◀ ▶) buttons, adjust the brightness so that:

- The darkest black bars disappear into the background.
- The dark gray areas are barely visible.
- The lighter gray areas are clearly visible.
- The white areas are a comfortable level of true white.
- The image contains only black, gray and white (no color).

Contrast: On your external test pattern source, select a stepped, gray-bar pattern like the one shown in Figure 4-6.

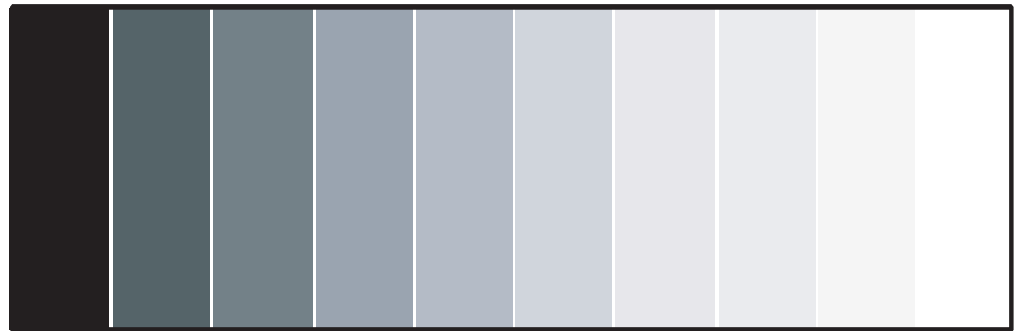

Figure 4-6. Typical Gray Bar Pattern for Adjusting Contrast

Select Contrast from the Picture Adjust menu. Using the left- and right-arrow (◀ ▶) buttons, adjust the contrast to a point just below which the white rectangle starts to increase in size.



Note

Brightness and contrast controls are interactive. A change to one may require a subtle change to the other in order to achieve the optimum setting.

Color Saturation: On your external test pattern source, select a color bar pattern like the one shown in Figure 4-7.

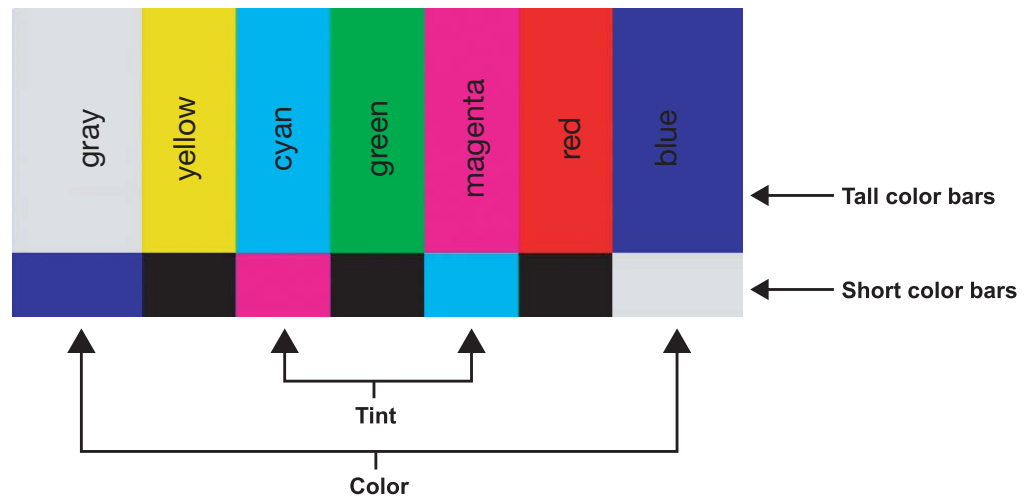
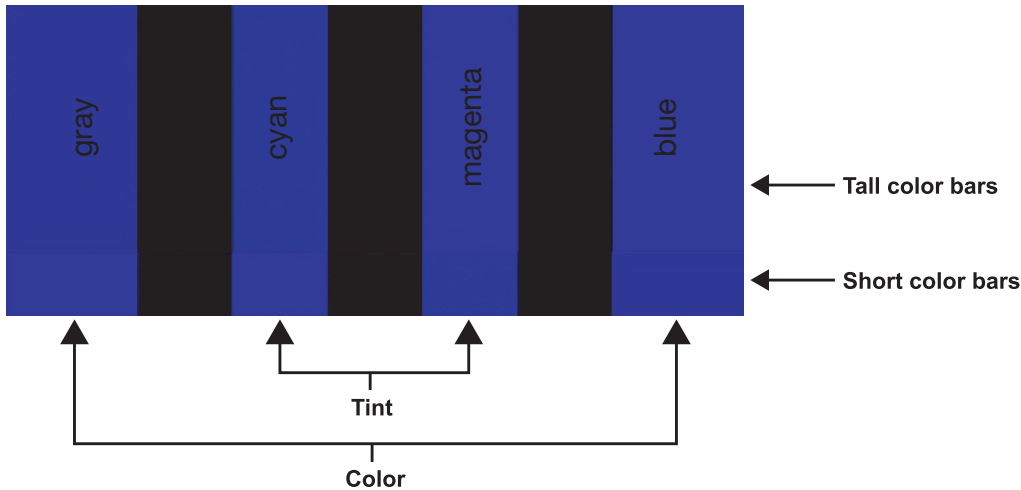

Figure 4-7. Typical Color Bar Pattern for Adjusting Color Saturation and Tint

Select Color from the Picture Adjust menu. While looking at the color bar pattern through a blue filter, adjust the color saturation level until the outermost (gray and blue) color bars appear to be a single shade of blue:



Tint: Tint or “hue” is essentially the ratio of red to green in the color portion of the image. When tint is decreased, the image appears redder; when it is increased the image appears greener. To set the tint, select Tint from the Picture Adjust menu. While looking at the color bar pattern through a blue filter, adjust the tint level until the cyan and magenta color bars (on either side of the green bar) appear to be a single shade of blue.



Note

1. Like the brightness and contrast controls, the color and tint controls are interactive. A change to one may require a subtle change to the other in order to achieve the optimum setting.
2. Color and tint controls are not available on the HDMI or RGB-HD inputs.

Sharpness: “Sharpness” is the amount of high-frequency detail in the image. To adjust sharpness, select Sharpness from the Picture Adjust menu and press **ENTER**. On your external test pattern source, select a pattern like the one shown in Figure 4-8. Adjust as needed, looking for white edges around the transitions from black to gray and different sized lines in the “sweep” patterns at the top and bottom. Lower the sharpness setting to eliminate them.

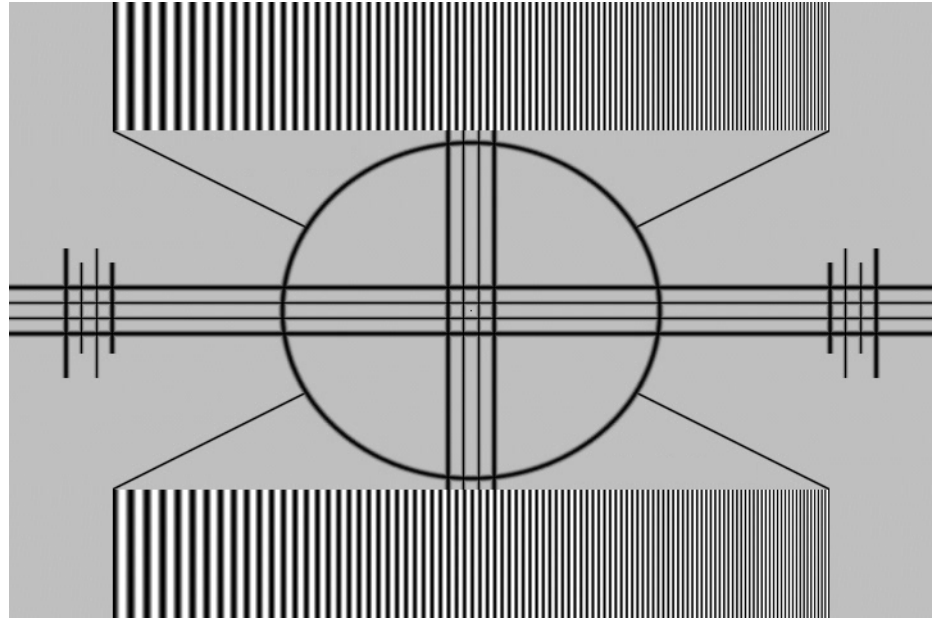

Figure 4-8. Typical Test Pattern for Adjusting Sharpness

Gamma: The Gamma control determines how gray shades are displayed between minimum input (black) and maximum input (white) for all signals. A good gamma setting helps to optimize blacks and whites while ensuring smooth transitions for the “in-between” values utilized in other grays.

Unlike brightness and contrast controls, Gamma allows you to lighten or darken the overall tone of your images without changing the extremes. All images will be more vibrant while still showing good detail in dark areas.

The default Gamma setting is appropriate for most typical home cinema environments.

Color Temperature: To adjust the color temperature, select Color Temp from the Picture Adjust menu and press **ENTER**. (Color temperature defines the “color of gray.”) The range is from 5,000K to 10,000K, in increments of 500K. The default setting, 6,500K, is appropriate for most situations. Higher settings produce a “bluer” picture; lower ones impart a reddish hue to the image.

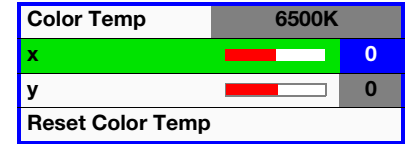

For more precise control over the color temperature, you can adjust the x and y coordinates for gray. These define its location on the standard CIE chromaticity graph, shown in Figure 4-9. (CIE stands for “Commission Internationale de l’Éclairage” (International Commission on Illumination), the organization responsible for color measurement and management standards.) Changing either or both of these numbers changes the hue of gray, within a narrow range above or below the selected color temperature; refer to Table 4-2.

Table 4-2. Effect of X and Y Coordinates for Color Temperature

X-adjustment	Y-adjustment	Result
▶	◀	red hues
◀	◀	blue hues
◀	▶	green hues
▶	▶	yellow hues

To restore the default color temperature, select Reset Color Temp and press **ENTER**. Press **ENTER** again to confirm.

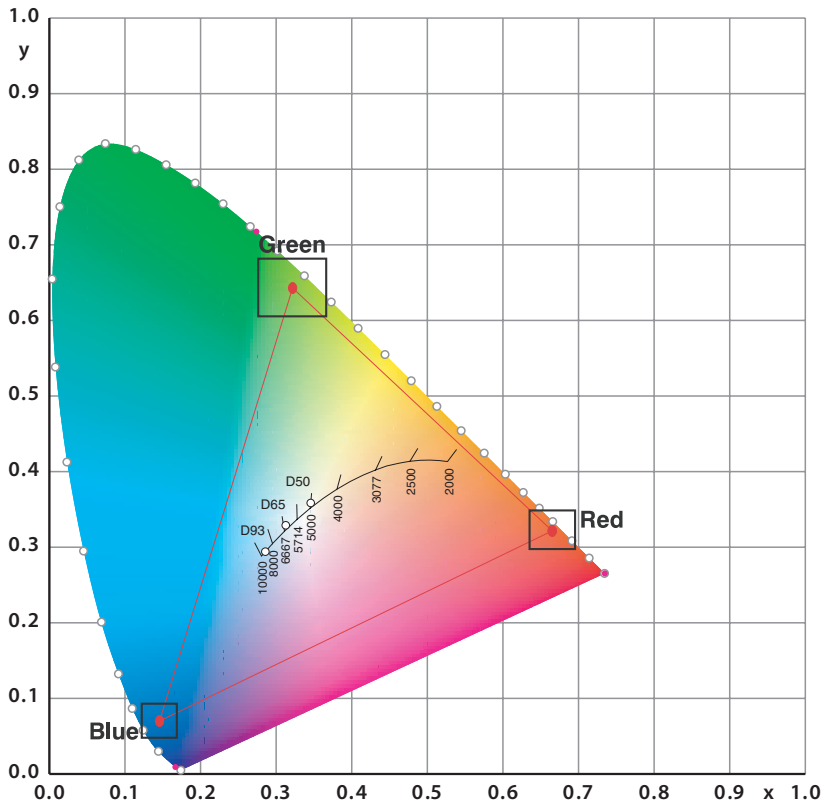

Figure 4-9. CIE 1931 Chromaticity Diagram

ICC Select: Choose ICC Select from the Picture Adjust menu to specify the color space (Standard, NTSC, HDTV or PAL) that is appropriate for the source signal, to achieve optimal color balance.

If you select NTSC, HDTV or PAL, you can make further adjustments to individual color space characteristics in the ICC Adjust sub-menu under the ISF Settings menu, described later in this section. (The Standard color space is factory-set and not adjustable.)

White Balance: To remove any trace of color from the white areas of the projected image, choose White Balance from the Picture Adjust menu and press **ENTER**.

White Balance		
R Gain		0
G Gain		0
B Gain		0
R Offset		0
G Offset		0
B Offset		0

- **Gain:** Use the Gain controls to correct color imbalances in the bright areas of the image. A good way to do this is to use a test pattern consisting mostly of solid white areas, such as an 80 IRE “window” pattern. If the white areas contain traces of red, green or blue, decrease the Gain for that color.
- **Offset:** Use the Offset controls in the White Balance sub-menu to correct color imbalances in the dark areas of the image. A good way to do this is to use a test pattern consisting mostly of dark gray areas, such as a 30 IRE “window” pattern. If the gray areas contain traces of red, green or blue, decrease the Offset for that color.

Save Settings: The Vision 10/12 lets you save image quality settings for each input and supported resolution to a preset. You can recall this preset at a later time by simply pressing a button on the remote control or using the Load Saved Settings menu command (see below).

You should save changes to any of the following settings to a preset; otherwise they will be lost when a new input source or resolution is selected:

- Aspect ratio
- Picture adjustments (brightness, contrast, color saturation, tint, sharpness, gamma, color temperature, ICC selection and white balance settings)
- Image options (SDTV adjust settings, brightness enhance, lamp power)

Load Saved Settings: To recall a preset, choose Load Saved Settings from the Picture Adjust menu and select “Custom1,” “ISF Day” or “ISF Night.” Or, use the corresponding buttons on the remote control.

Image Option ➤

Image Option	
HD/RGB Adjust	
Image Position	
Over Scan Adjust	1%
SDTV Adjust	
Brightness Enhance	OFF
Lamp Power	250W
Information	
Restore Factory Settings	

Use the controls in the Image Option menu to perform advanced image quality adjustments, obtain information about the projector or perform a factory reset.

HD/RGB Adjust: To improve the quality of projected images from a computer or other analog RGB source, select HD/RGB Adjust and press **ENTER**.

- **Clock:** If you notice flickering or vertical noise when displaying computer images, adjust the Clock setting to correct the issue.
- **Phase:** Adjust the phase if the image shows shimmer or “horizontal” noise. Pixel phase adjusts the phase of the pixel sampling clock relative to the incoming signal. The effect of this control is similar to that of a tracking control on a VCR.

For best results, use a good test pattern such as a smooth gray consisting of a clear pattern of black and white pixels, or a similar “half on, half off” graphic image. (You may notice that you can stabilize the image at more than one point. Use either setting in this case.)

To restore the original Clock and Phase settings, select Reset and press **ENTER**, then press **ENTER** again to confirm the reset.

- **Auto Tune:** Auto Tune automatically adjusts settings to optimize computer images. Auto Tune can be executed either on command or automatically whenever an incoming RGB signal is present. To execute Auto Tune on command, select Execute Auto Tune and press **ENTER**. To enable automatic Auto Tune, select Auto Tune and set it to ON.

**Note**

Auto Tune may take some time to complete, depending on the characteristics of the incoming signal.

Image Position: To adjust the horizontal and vertical position of the projected image, select Image Position from the Image Option menu and press **ENTER**.

- **H Position:** Use the up- or down-arrow buttons (▲, ▼) to select H Position. Then, use the right-arrow button (▶) to shift the image to the right; use the left-arrow button (◀) to shift the image to the left.
- **V Position:** Use the up- or down-arrow buttons (▲, ▼) to select V Position. Then, use the right-arrow button (▶) to shift the image up; use the left-arrow button (◀) to shift the image down.

To restore the default image position, select Reset and press **ENTER**. Then, press **ENTER** to confirm or **EXIT** to cancel.

Over Scan Adjust: Overscan pushes the outside edge of the active picture area of the video signal out beyond the edge of the display area.

Some television programs are produced based on the assumption that older television sets may not display the outer edges of the broadcast picture area. Over scan effectively trims away these inactive, outer edges and enlarges the remaining portion of the image to fill the display area.

Select from 0% to 10% of Overscan, as desired.

For HDTV, DVDs and other video sources, Overscan is generally not necessary or desirable.

SDTV Adjust: To maximize the quality of 480i (composite, S-Video or component) video signals, select SDTV Adjust from the Image Option menu and press **ENTER**.

- **Chroma Enhance:** Use Chroma Enhance to add chroma (color information) to the input signal, making colors appear more vibrant and saturated.
- **Video On Film:** Set Video On Film to ON to repair distortions or abnormalities in a video image.
- **Film Mode:** Use the Film Mode control to smooth out moving images from interlaced sources. In most cases, the Vision 10/12 detects the proper “pull-down” rate and vertical frequency. However, if your source is jittery and/or tearing you may wish to force a setting to ensure stable processing for that source.

Brightness Enhance: to amplify the bright areas of the image, select Brightness Enhance and use the right- or left-arrow button (◀ or ▶) to set it to ON. Brightness Enhance can be useful for high ambient light environments or when you use the lower Lamp Power setting (see below).

Lamp Power: Select Lamp Power from the Display Color Menu to adjust the lamp output level. You can choose to run the lamp as bright as possible (250W; this is the default setting) or you can choose the lower setting (200W). Generally, lower lamp output can prolong the life of the lamp, but decreases brightness.

Source :	Component 1
Resolution:	720 x 480
Vert Freq :	60 Hz
Horz Freq :	31 kHz
Lamp Timer :	720 HR
F/W Version :	226.4.150

Information: Select Information from the Main Menu to see information about the current source, input resolution, horizontal and vertical frequencies, lamp hours and the installed firmware version.

Should you ever need to contact Vidikron Technical Support, this information will help them answer your questions or resolve product performance issues.

Restore Factory Settings: To reset all items in the Image Options menu to their factory default values, select Restore Factory Settings and press **ENTER**. A warning message appears; press **ENTER** again to confirm the reset or press **EXIT** to cancel. After the reset, the projector powers off and restarts.

Installation ➤

Installation	
Language	English
Picture Configuration	Floor Front
OSD Timeout	5 secs
OSD Transparent	OFF
Source Detect	Auto
Auto Power Off	OFF
Blue Enable	OFF
OSD Position	
Keystone	
Fan High Speed Mode	ON

The Installation menu to change the picture orientation, appearance and behavior of the OSD menus, fan speed and other projector settings.

Language: Select Language from the Installation menu and press the right- or left-arrow buttons to select the OSD language (English, French, Italian, German or Spanish).

Picture Configuration: Select Picture Configuration from the Installation menu to change the picture orientation to suit the method of installation (Floor Front, Floor Rear, Ceiling Front or Ceiling Rear).

OSD Timeout: The OSD Timeout setting controls how long the OSD menus stay on screen when no buttons are pressed. Select a time-out period of 5, 15 or 60 seconds.

OSD Transparent: To allow the projected image to show through the OSD menus, select OSD Transparent from the Installation menu and set it to ON.

Source Detect: The Vision 10/12 can automatically detect an incoming signal and switch to that input. To enable automatic source detection, select Source Detect from the Installation menu and set it to Auto.

Auto Power Off: The Vision 10/12 can be set to power off automatically after 15 minutes of no input signal or user input via the remote control. To enable this feature, set it to ON. When you do, a warning message appears on-screen five minutes before the shutdown is to occur. To prevent the projector from powering off, press any key on the remote control.

Blue Enable: Blue Enable removes all red and green color information from the image, simulating a blue filter. You can use it instead of a blue filter when performing color and tint adjustments.

OSD Position: To change the position of the OSD controls, select OSD Position from the Installation menu. Use the up- and down-arrow buttons to select Top Left, Bottom Left, Top Right or Bottom Right, then press **ENTER**.

Keystone Correction: If the projector and screen are not installed perpendicular to each other, the image may become distorted in a trapezoidal shape, as shown in Figure 4-10. Select Keystone from the Installation menu to compensate for this.

Horizontal Keystone Correction

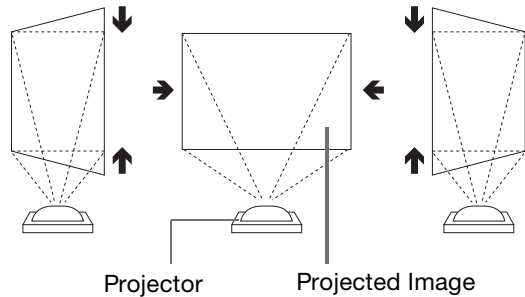

Positive values compress right side;
Negative values compress left side.

Vertical Keystone Correction

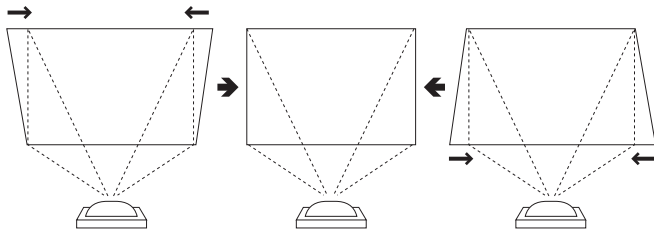

Positive values compress top;
negative values compress bottom.

Figure 4-10. Horizontal and Vertical Keystone Correction



Note

1. The Vision 10/12 keystone correction can compensate for up to approximately 15 degrees of screen and/or projector tilt.
2. Straight lines or the edges of images may appear jagged while adjusting the image.
3. Keystone correction is not possible with a 1080i input signal.

Fan High Speed Mode: If the projector is being used in a high-altitude environment, use Fan High Speed Mode to prevent it from overheating. Set Fan High Speed Mode to ON to run the fan at high speed; set it to OFF to run the fan at normal speed.

ISF Settings ➤ Use the ISF Settings menu to perform advanced picture quality adjustments. **This menu should be used by ISF-certified technicians only.**

ISF Calibration	
Brightness	0
Contrast	0
Color	0
Tint	0
Sharpness	3
Gamma	2.2
Color Temp	6500K
Load Saved Settings	
White Balance	
Save Settings	
Lamp Timer Reset	
ICC Adjust	Standard
ISF Enable	OFF
Blue Enable	OFF
Splash Screen Timer	60 secs
Noise Reduction	4



Note

You must enter a passcode to access the ISF Settings menu.

Several controls in this menu are identical to those in the Picture Adjust menu, but are accessible only by entering the ISF Calibration menu passcode. This makes it possible to restore the picture quality settings to what they were when the projector was installed, simply by recalling the "ISF Night" or "ISF Day" preset.

Brightness: Refer to **Brightness** on page 37.

Contrast: Refer to **Contrast** on page 38.

Color: Refer to **Color Saturation** on page 38.

Tint: Refer to **Tint** on page 39.

Sharpness: Refer to **Sharpness** on page 40.

Gamma: Refer to **Gamma** on page 40.

Color Temp: Refer to **Color Temperature** on page 41.

Load Saved Settings: To recall the Custom1, ISF Night or ISF Day settings, choose Load Saved Settings from the ISF Calibration menu. Then, select "Custom1," "ISF Night" or "ISF Day" and press **ENTER**, or use the corresponding buttons on the remote control.

White Balance: Refer to **White Balance** on page 42.

Save Settings: For each input and supported resolution, the Vision 10/12 lets you save image quality settings as presets that you can recall at a later time. You can create up to three presets -- designated "Custom1," "ISF Day" and "ISF Night" -- per input and resolution.

You should save changes to any of the following settings to a preset; otherwise they will be lost when a new input source or resolution is selected:

- Aspect ratio
- Picture adjustments (brightness, contrast, color saturation, tint, sharpness, gamma, color temperature, ICC selection and white balance settings)
- Image options (SDTV adjust settings, brightness enhance, lamp power)

To save image settings in the "ISF Day" or "ISF Night" preset, select Save Settings from the ISF Calibration menu and select "ISF Day" or "ISF Night." (To save settings to the "Custom1" memory preset, refer to **Save Settings** on page 42.)

Lamp Timer Reset: When you replace the projector lamp, you should also reset the lamp hour counter. To do this, select Lamp Timer Reset from the ISF Calibration menu and press **ENTER**. The Vision 10/12 shows the number of hours the projector lamp has been in service and asks you to confirm or cancel the reset. Press **ENTER** to confirm or **EXIT** to cancel.

For detailed lamp replacement instructions, refer to **Lamp Replacement** on page 52.

ICC Adjust: Use the ICC Adjust controls to customize the stored NTSC, HDTV and/or PAL color space characteristics. To do this:

1. Select ICC Adjust from the ISF Calibration menu and press **ENTER**.
2. Select the color space to modify using the left- or right-arrow buttons.
3. Select a component color (Red, Green, Blue, Cyan, Yellow or Magenta).

For each component color, you can adjust the following:

- **Intensity:** This sidebar adjusts the intensity -- also known as *luminance* -- of a given color.
- **Saturation:** This sidebar adjusts the color saturation level -- the *amount* of that color in a video image. Lower settings produce less saturated colors; a setting of “-64” removes that color from the image entirely. If the saturation is too high, that color will be overpowering and unrealistic.
- **Hue:** This sidebar adjusts the red/green color hue for true color reproduction of video signals. For best results, adjust the hue while displaying an external color bar test pattern (Figure 4-7).

ICC Adjust		
Color Type	NTSC	
	R	G B C Y M
Intensity	<input type="range"/>	0
Saturation	<input type="range"/>	0
Hue	<input type="range"/>	0
Store Setting		

When you have finished customizing the color space, select Store Setting and press **ENTER**.

ISF Enable: Use ISF Enable to control the display of the ISF logo on the Vision 10/12 splash screen upon power-up; see Figure 4-11.



Figure 4-11. ISF-Enabled Vision 10/12 Splash Screen

Blue Enable: Refer to **Blue Enable** on page 44.

Splash Screen Timer: Press the right- or left-arrow buttons to set the Splash Screen Timer. This timer controls how long the startup (ISF and Vidikron logo) image stays on-screen after you turn on the projector. Select from 15 to 60 seconds, in 5-second increments.

Noise Reduction: To apply Digital Noise Reduction (DNR) to the input signal, select Noise Reduction from the ISF Calibration menu. Noise reduction is useful for clearing up noisy RGB images such as those from a PC. Adjust as desired using the left- or right-arrow buttons, keeping in mind that reducing noise (which reduces high frequencies) may also “soften” the image.

Maintenance and Troubleshooting

- Unplug the power cord before cleaning the projector.
- Avoid using benzene or thinner, as these can damage the finish on the projector exterior.
- Do not use volatile agents, such as insecticides, on the projector.
- Do not leave rubber or plastic objects in contact with the projector for long periods as they may damage the finish of the projector.
- Wipe off dirt gently with a soft flannel cloth.
- For hard-to-remove dirt, soak a cloth in a neutral detergent diluted with water, wring the cloth well and then wipe the projector.
- Strong cleaning detergents may discolor, warp or damage the coating on the projector. Make sure to test on a small, inconspicuous area on the projector before using.

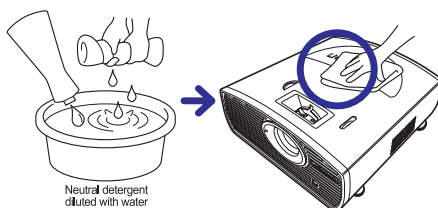
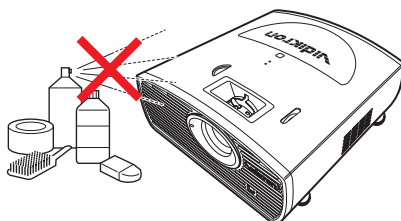

- Use a commercially available blower or lens cleaning paper (for glasses and camera lenses) for cleaning the lens. Do not use any liquid cleaning agents, as they may wear the coating film on the surface of the lens.
- The surface of the lens is easily damaged. Do not scrape or hit the lens.

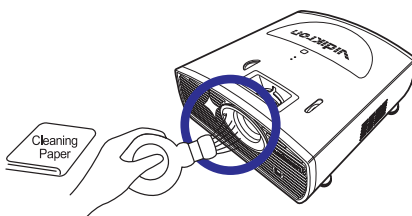

5.1 Cleaning the Projector

5.2 Cleaning the Lens

5.3 Cleaning the Intake and Exhaust Vents

This Vision 10/12 is equipped with intake and exhaust vents to allow the flow of cool air through the projector and maintain the proper operating temperature.

You should periodically clean the vents by vacuuming them with a vacuum cleaner. Vidikron recommends doing this after every 100 hours of use, or more often if the projector is used in a dirty or smoky location.

To clean the intake and exhaust vents:

1. Press **OFF** on the remote control to turn off the power. Wait until the cooling fan stops.
2. Unplug the power cord.
3. Remove dust by placing the cleaner hose on the intake and exhaust vents.

Side and front view

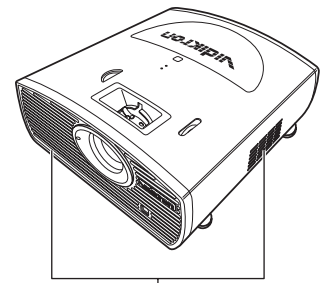

Ventilation holes

Power OFF button

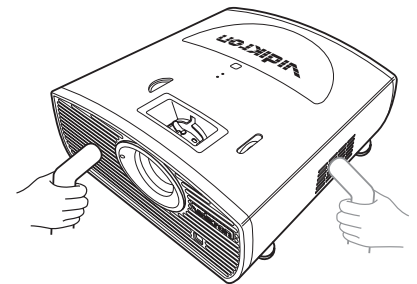
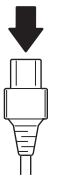
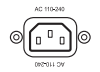
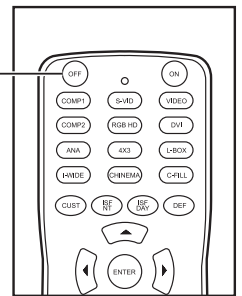

The projector lamp has a life of 2,000 hours. Maintain proper ventilation to keep the lamp operating throughout its lifetime. Do not subject the projector to unnecessary vibration.

- Lamp replacement is recommended after approximately 2,000 cumulative hours of use or when you notice a significant deterioration in the picture and color quality. To find out how long the currently-installed lamp has been in service, select Information from the Image Options menu.
- The actual lamp service life may be less than 2,000 hours depending on the environment in which the projector is used.
- **For lamp replacement, please contact your nearest Vidikron authorized service center or Vidikron dealer. Do not attempt to replace the lamp yourself!**



Caution

This projector uses a pressurized mercury lamp. A loud sound may indicate lamp failure. Lamp failure is caused by excessive shock, improper cooling, surface scratches or deterioration of the lamp due to usage. The period of time up to failure largely varies depending on the individual lamp and the condition and the frequency of use. It is important to note that failure can often result in the bulb cracking.

When the lamp replacement indicator and on-screen display icon are illuminated or are flashing, replace the lamp with a new one immediately, even if the lamp appears to be operating normally.

If the lamp breaks, glass particles may spread inside the lamp cage or gas contained in the lamp may be vented into the room from the exhaust vent. As the gas in this lamp contains mercury, ventilate the room well if the lamp breaks and avoid all exposure to the released gas. In case of exposure to the gas, consult a doctor as soon as possible.

If the lamp breaks, there is also a possibility that glass particles may spread inside the projector. If this happens, contact your nearest Authorized Dealer to remove the damaged lamp and ensure safe operation.

Do not remove the lamp unit immediately after turning off the projector. Touching a hot lamp can cause burns or injury. Wait at least one hour after the disconnecting the power cord to allow the surface of the lamp unit to fully cool before removing.

5.4 Lamp Maintenance

5.5 Lamp Cautions

5.6 Lamp Replacement

1. Turn off the projector and wait for the cooling fan to stop.
2. Unplug the power cord. Allow the projector to cool down for approximately one hour prior to removing the lamp assembly for replacement.
3. Loosen the two captive lamp cover screws and remove the cover.

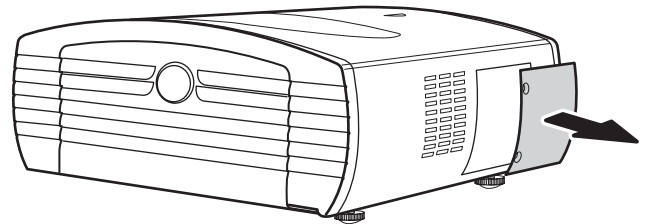
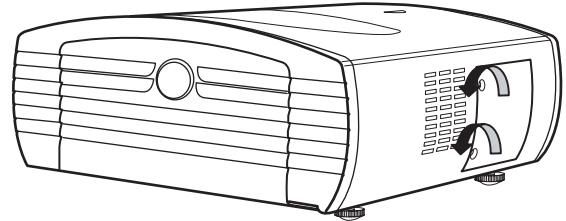

4. Loosen the four lamp assembly mounting screws.
5. Grasp the lamp assembly handle and pull gently, removing the lamp module from the projector housing. As you do so, the lamp cooling interlock switch on the inside of the lamp cavity (near the top) moves to the OFF position.

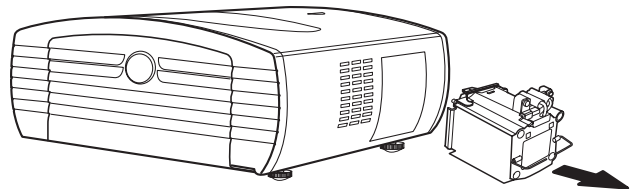

6. Gently slide the new lamp assembly into the lamp cavity. Align the two power connectors at the top of the lamp assembly with the two sockets at the top of the lamp cavity. Press gently on both sides of the lamp assembly to snap it into place. As you do so, the lamp cooling interlock switch returns to the ON position.
7. Tighten the lamp assembly mounting screws.
8. Replace the lamp cover and secure the captive lamp cover screws.
9. Plug in the projector and turn it on.
10. Reset the Lamp Timer to zero. To do this, select Lamp Timer Reset from the ISF Calibration menu and press **ENTER**. The Vision 10/12 shows the number of hours the projector lamp has been in service and asks you to confirm or cancel the reset. Press **ENTER** again to confirm.

Table 5-1 provides some general guidelines for troubleshooting problems you may encounter with the Vision 10/12. If you encounter an issue not described here, please contact your Vidikron dealer or Vidikron Technical Support.

5.7 Troubleshooting Tips

Table 5-1. Troubleshooting Chart

Symptom	Possible Cause(s)	Solution
The projector does not turn on after initial installation.	<ul style="list-style-type: none"> The Vision 10/12 is not plugged in or the AC outlet is not active. The remote control batteries have run out. 	<ul style="list-style-type: none"> Ensure that the Vision 10/12 is plugged in and that the AC outlet is active. Replace the batteries.
The projector is on, but there is no video image on-screen.	<ul style="list-style-type: none"> Incorrect source selection. Source component is not turned on. 	<ul style="list-style-type: none"> Select the correct source. Turn on the source component.
A projected image from a DVD is split or otherwise scrambled.	<ul style="list-style-type: none"> DVD player is set to progressive scan mode. 	<ul style="list-style-type: none"> Turn off progressive scan on the DVD player. Connect the DVD player to the HD/RGB 1 or HD/RGB 2 input.
Image is too bright and/or lacks definition in the bright areas of the image.	<ul style="list-style-type: none"> Contrast is set too high. 	<ul style="list-style-type: none"> Lower the contrast setting.
Image appears "washed out" and/or dark areas appear too bright.	<ul style="list-style-type: none"> Brightness is set too high. 	<ul style="list-style-type: none"> Lower the brightness setting.
Colors in the image are swapped; for example, reds appear blue or vice versa.	<ul style="list-style-type: none"> The Red/Pr, Green/Y or Blue/Pb outputs from the source are connected to the wrong inputs on the Vision 10/12. 	<ul style="list-style-type: none"> Ensure that the source outputs are connected to the correct Vision 10/12 input.
RGB-HD images appear "noisy."	<ul style="list-style-type: none"> Clock and Phase settings need adjustment. 	<ul style="list-style-type: none"> Manually adjust Clock and Phase settings, or perform an Auto-Tune (refer to HD/RGB Adjust on page 42).
The projector will not turn back on after it was powered down, or the image disappears during operation.	<ul style="list-style-type: none"> The projector will not turn on for two minutes after power-down, to protect the lamp. The lamp has failed or was improperly installed. 	<ul style="list-style-type: none"> Wait until the cooling fan stops. Replace or re-install the lamp.

Notes:

Serial Communications

To interface the Vision 10/12 with a home theater automation/control system or a PC running terminal emulation software, connect it to your control system or PC as shown in Figure 3-11.

Configure the RS-232 controller or PC serial port as follows: no parity, 8 data bits, 1 stop bit and no flow control. Set the baud rate to 9600, to match that of the Vision 10/12 RS-232 port.

Table 6-1 lists the RS-232 command set. All commands are in ASCII format and must be in UPPERCASE.

When you send a valid command, the Vision 10/12 executes it and acknowledges it with the first three characters of the command followed by "OK," for example, RRAOK. When you send an invalid command, the Vision 10/12 ignores it and returns the first three characters of the command followed by "NG;" for example, RRXNG.

Table 6-1. Serial Commands

Command	Description	Reply
RRA00	Saves current settings to the CUSTOM 1 memory (Note 1)	RRAOK
RRA01	Saves current settings to the ISF Day memory (Note 1)	RRAOK
RRA02	Saves current settings to the ISF Night memory (Note 1)	RRAOK
RRB00	Recalls the Custom 1 memory settings	RRBOK
RRB01	Recalls the ISF Day memory settings	RRBOK
RRB02	Recalls the ISF Night settings	RRBOK
RRC00	Selects the S-VIDEO input	RRCOK
RRC01	Selects the COMPOSITE VIDEO input	RRCOK
RRC02	Selects the COMPONENT 1 input	RRCOK
RRC03	Selects the COMPONENT 2 input	RRCOK
RRC04	Selects the HDMI input	RRCOK
RRC05	Selects the RGB input	RRCOK
RRD00	Selects the ANAMORPHIC (16:9) aspect ratio	RRDOK
RRD01	Selects the STANDARD (4:3) aspect ratio	RRDOK

Notes:

1. All image quality settings must be made with the remote control. After the image adjustments are complete, you can use these commands to store the settings in the selected memory.
2. The power on command (PON) will not provide an OK reply; it will instead reply with a random character. For your automation system, simply ensure that you receive a character after the PON command. If you do not get any reply after PON, send PON again.

6.1 RS-232 Connection and Port Configuration

6.2 Serial Command Syntax

Table 6-1. Serial Commands (continued)

Command	Description	Reply
RRD02	Selects the LETTERBOX aspect ratio	RRDOK
RRD03	Selects the INTELLIWIDE aspect ratio	RRDOK
RRD04	Selects the CINEMA (2.35:1) aspect ratio	RRDOK
RRD05	Selects the CINEMA FILL aspect ratio	RRDOK
RRE00	Turns the projector OFF	RREOK
PON	Turns the projector ON	Random (Note 2)

Notes:

- 1. All image quality settings must be made with the remote control. After the image adjustments are complete, you can use these commands to store the settings in the selected memory.*
- 2. The power on command (PON) will not provide an OK reply; it will instead reply with a random character. For your automation system, simply ensure that you receive a character after the PON command. If you do not get any reply after PON, send PON again.*

Specifications

Table 7-1 lists the Vision 10/12 specifications.

7.1 Vision 10/12 Specifications

Table 7-1. Vision 10/12 Specifications

Projector Type:	Digital Light Processing (DLP), single-chip DMD
Native Resolution:	Vision Model 10: 1024 x 576 (16:9) Vision Model 12: 1280 x 720 (16:9)
Aspect Ratios:	4:3, Letterbox, 16:9 Anamorphic, IntelliWide, Cinema, Cinema Fill
Video Standards:	NTSC, PAL, SECAM
Scan Frequency:	Horizontal: 15 to 80 kHz Vertical: 43 to 100 Hz
Picture Size (16:9 Screen):	Recommended Width: 72 to 96 in. Maximum Width: 150 in.
Throw Distance (Factor x Screen Width):	Vision Model 10: Minimum: Screen Width x 1.40 Maximum: Screen Width x 1.60 Vision Model 12: Minimum: Screen Width x 1.42 Maximum: Screen Width x 1.65
Horizontal Offset:	8% of screen width left or right
Vertical Offset – Vision Model 10:	Ceiling-mounted -- 60% of screen height below; 40% of screen height above Floor-mounted -- 40% of screen height below; 60% of screen height above
Vertical Offset – Vision Model 12:	Ceiling-mounted -- 63% of screen height below; 46% of screen height above Floor-mounted -- 46% of screen height below; 63% of screen height above
Lamp:	250 Watts
Estimated Lamp Life:	2000 hours
Source Inputs:	(1) Composite; (1) S-Video; (2) RCA Component (YPbPr); (1) VGA; (1) HDMI 1.2 with HDCP
Control Options:	- Discrete infrared remote - Serial commands via RS-232
RS-232 Communication Parameters:	9600 bps, no parity, 8 data bits, 1 stop bit, no flow control

Table 7-1. Vision 10/12 Specifications (continued)

+12V Output:	0.25 Amps, active when the projector is turned on
Power Requirements:	100 to 240 VAC (auto-sensing), 50/60 Hz, 370 Watts
Operating Environment:	41°F to 95°F (5°C to 35°C), 0% to 90% humidity (non-condensing)
Dimensions:	See Figure 7-1
Weight (including lens):	27.5 lbs. (12.47 kg)
Brightness and Contrast:	<p>Cinema Standards Measurement System (CSMS) Specifications</p> <ul style="list-style-type: none"> - Brightness: 15.9 foot-Lamberts (fL) (Vision Model 10); 16.1 foot-Lamberts (fL) (Vision Model 12) - Contrast Ratio: 219:1 (Vision Model 10); 224:1 (Vision Model 12) <p>These measurements are taken from the projector in a controlled, home theater environment. All measurements are made to ANSI/NAPM IT7.228-1997 specifications using the Photo Research PR-650 SpectraColorimeter and Minolta LS-100 Luminance Meter, Video Essentials test DVD and a 1.3 gain, 72-inch wide screen. The projector is calibrated to a color temperature of 6,500K and has a minimum of 150 hours of usage.</p> <p>The foot-Lambert (fL) is the unit of measurement used in commercial movie theaters to express image brightness at the screen surface. The Society of Motion Picture and Television Engineers (SMPTE) specifies 16 fL as the target image brightness for film-based projectors using an open gate (without film in the projector). More importantly, today SMPTE specifies 12 fL as the target image brightness in Digital Cinema theaters. The foot-Lambert measurement is dependent on screen size, screen gain and projector light output.</p> <p>Home Theater Calibration Specifications</p> <ul style="list-style-type: none"> - Light Output: 410 ANSI Lumens (Vision Model 10); 417 ANSI Lumens (Vision Model 12) - Contrast Ratio: 219:1 (Vision Model 10); 224:1 (Vision Model 12) <p>These specifications are obtained by calibrating the projector as described above for CSMS measurements.</p> <p>Industry-Standard Specifications</p> <ul style="list-style-type: none"> - Light Output: 780 ANSI Lumens (Vision Model 10); 820 ANSI Lumens (Vision Model 12) - Contrast Ratio: 2400:1 (Vision Model 10); 2550:1 (Vision Model 12) <p>These are typical projector brightness and contrast specifications found in most companies' sales literature. Vidikron includes these measurements in its literature to allow for direct comparison with other manufacturers' projectors. These measurements are typically taken at 9,000K to 13,000K to get expected performance data when the projector is used in professional, commercial and industrial displays.</p>
Regulatory Approvals:	Complies with FCC, CE C-Tick
Limited Warranty:	Projector: Two (2) years parts and labor from the date of delivery to the end user. Lamp: 1000 hours or six (6) months, whichever comes first.

Specifications are subject to change without notice.

Figure 7-1 shows the Vision 10/12 dimensions.

7.2 Vision 10/12 Dimensions

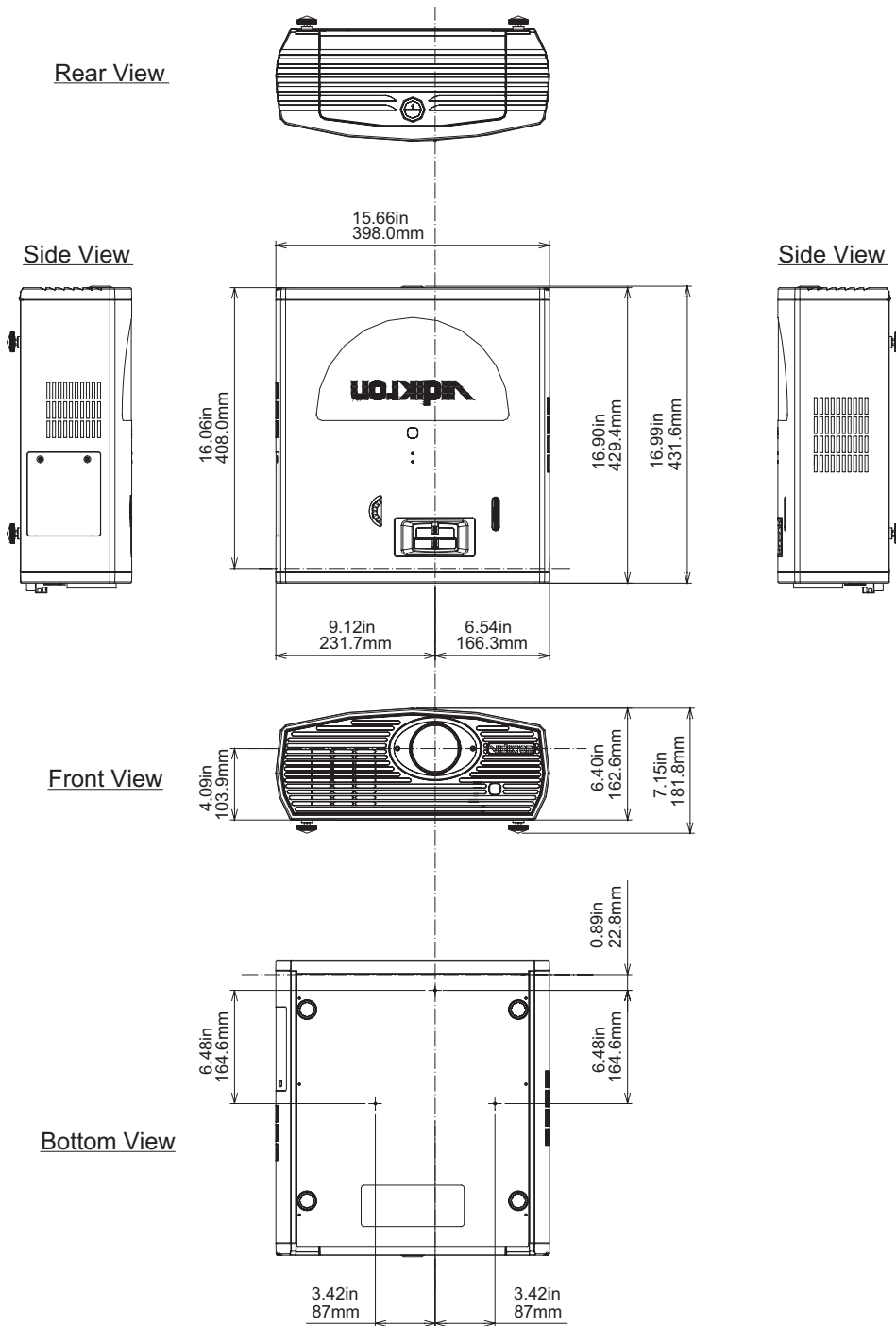

Figure 7-1. Vision 10/12 Dimensions

7.3 Computer Signal Compatibility

The Vision 10/12 can display video signals from a variety of computer sources via its RGB-HD and HDMI inputs. It is compatible with the three most common sync modes -- sync-on-green, composite sync and RGB with separate sync -- as well as XGA display adapters that use advanced intelligent compression.

Table 7-2 lists the signal types that are compatible with the Vision 10/12, and indicates which of those are VESA standards.

Table 7-2. Computer Signal Compatibility Chart

PC/MAC/WS	Resolution		Horizontal Frequency (kHz)	Vertical Frequency (Hz)	VESA Standard	HDMI Support	Display
PC	VGA	640 x 350	27.0	60			Upscale
			31.5	70			
			37.9	85	√		
		720 x 350	27.0	60			
			31.5	70			
		640 x 400	27.0	60		√	
			31.5	70		√	
			37.9	85	√	√	
		720 x 400	27.0	60		√	
			31.5	70		√	
			37.9	85	√	√	
		640 x 480	26.2	50		√	
			31.5	60		√	
			36.8	70		√	
			37.9	72	√	√	
			37.5	75	√	√	
			43.3	85	√	√	
			47.9	90		√	
			53.0	100		√	

Notes:

1. This projector may not be able to display images from notebook computers in simultaneous (CRT/LCD) mode. Should this occur, switch the notebook computer to "CRT only" mode. If you are unsure how to do this, refer to your notebook computer's user manual.
2. When this projector receives 640 x 350 VESA format VGA signals, "640 x 400" appears on the screen.
3. Interlaced video signals received through the RGB input may not display correctly. If this occurs, use the Component 1, Component 2, S-video or Composite video input instead.

Table 7-2. Computer Signal Compatibility Chart (continued)

PC/MAC/ WS	Resolution		Horizontal Frequency (kHz)	Vertical Frequency (Hz)	VESA Standard	HDMI Support	Display
PC	SVGA	800 x 600	31.4	50		√	Upscale
			35.1	56	√	√	
			37.9	60	√	√	
			44.5	70		√	
			48.1	72	√	√	
			46.9	75	√	√	
PC	SVGA	800 x 600	53.7	85	√	√	Upscale
			56.8	90		√	
			64.0	100		√	
PC	XGA	1024 x 768	35.5	43		√	True
			40.3	50		√	
			48.4	60	√	√	
			56.5	70	√	√	
			60.0	75	√	√	
			68.7	85	√	√	
			73.5	90		√	
			77.2	96			
			80.6	100			
MAC 13"	VGA	640 x 480	34.9	67			Upscale
MAC 16"	SVGA	832 x 624	49.6	75			
MAC 19"	XGA	1024 x 768	48.4	60	√		True

Notes:

1. This projector may not be able to display images from notebook computers in simultaneous (CRT/LCD) mode. Should this occur, switch the notebook computer to "CRT only" mode. If you are unsure how to do this, refer to your notebook computer's user manual.
2. When this projector receives 640 x 350 VESA format VGA signals, "640 x 400" appears on the screen.
3. Interlaced video signals received through the RGB input may not display correctly. If this occurs, use the Component 1, Component 2, S-video or Composite video input instead.

7.4 Video Signal Compatibility

Table 7-3 lists numerous common video signal formats and indicates which input(s) on the Vision 10/12 can accept a given format.

Table 7-3. Video Signal Compatibility Chart

Resolution			H-Freq (kHz)	V-Freq (Hz)	Compatible Inputs (Note 1)					
					Comp. 1	Comp. 2	S-Video	Com-posite	VGA	HDMI
SD Video	NTSC	640 x 480i	15.73	59.94/60	√	√	√	√		
	PAL	768 x 576i	15.63	50	√	√	√	√		
	SECAM				√	√	√	√		
	NTSC-4.43				(adjustment required)					
	PAL-M									
	PAL-N									
	NTSC-J									
	PAL-60									
NTSC-50	(not supported)									
EDTV	480p	720 x 480p	31.5	59.94/60	√	√			√	√
	576p	720 x 576p	31.3	50	√	√			√	√
HDTV	1080i/50	1920 x 1080i	28.1	50	√	√			√	√
	1080i/60		33.8	59.94/60	√	√			√	√
	720p/50	1280 x 720p	37.5	50	√	√			√	√
	720p/60		45.0	59.94/60	√	√			√	√
HTPC (Note 2)	720p/48	1280 x 720p		48					√	
	720p/75			75					√	
	576p/48	1024 x 576p		48					√	
Notes:										
1. The Component 1 and Component 2 inputs accept both analog (YPbPr) and digital (YCbCr) signals.										
2. HTPC = Home Theater PC										

RUMA-011175
rev. 08-14-06 v2.0



Vidikron
2900 Faber Street
Union City, CA 94587
510-324-5900
Fax 510-324-5905
1-888-4-VIDIKRON
www.vidikron.com



SERIAL NUMBER