



DView™

VL-37HD

HIGH DEFINITION FLAT PANEL LCD MONITOR

ONE YEAR LIMITED WARRANTY

For LCD Displays

Congratulations on your purchase of a Vidikron video product and welcome to the Vidikron family! With proper installation, setup and care, you should enjoy many years of unparalleled video performance.

This is a LIMITED WARRANTY as defined in the Magnuson-Moss Warranty Act. Please read it carefully and retain it with your other important documents.

WHAT IS COVERED UNDER THE TERMS OF THIS LIMITED WARRANTY:

SERVICE LABOR: Vidikron will pay for service labor by Vidikron Authorized Service Center when needed as a result of a manufacturing defect for a period of one (1) year from the effective date of delivery to the end user.

PARTS: Vidikron will provide new or rebuilt replacement parts for the parts that fail due to defects in materials or workmanship for a period of one (1) year from the effective date of delivery to the end user. Such replacement parts are then subsequently warranted for the remaining portion (if any) of the original warranty period.

WHAT IS NOT COVERED UNDER THE TERMS OF THIS LIMITED WARRANTY:

Image retention on LCD display panels is specifically excluded from coverage under this Limited Warranty. Image retention or staining of an image is the result of misuse of the product and therefore cannot be repaired under the terms of this Limited Warranty.

Normal viewing material such as television/satellite broadcasts, videotape or DVDs (not put into pause for extended periods of time) will not cause damage to your display under normal conditions. Many DVD players are also equipped with screen savers for this reason.

TO AVOID IMAGE RETENTION (Burn-in): Please ensure that still images are not left on your LCD display panel. Also ensure that images displayed in the 4:3 aspect ratio mode (black or gray stripes, but no picture information is present on the left and right edges of the screen) are used as infrequently as possible. This will prevent permanent retention on your LCD display panel, which can be seen permanently under certain conditions once burn-in has occurred.

The types of images to avoid include video games, still images and computer screens with stationary tool bars and icons. (This is why computers are equipped with screen savers – to prevent still images from burning into the monitor's phosphors after being displayed continuously for an extended period of time).

This Limited Warranty only covers failure due to defects in materials and workmanship that occur during normal use and does not cover normal maintenance. This Limited Warranty does not cover cabinets or any appearance items; failure resulting from accident, misuse, abuse, neglect, mishandling, misapplication, faulty or improper installation or setup adjustments; improper maintenance, alteration, improper use of any input signal; damage due to lightning or power line surges, spikes and brownouts; damage that occurs during shipping or transit; or damage that is attributed to acts of God. In the case of remote control units, damage resulting from leaking, old, damaged or improper batteries is also excluded from coverage under this Limited Warranty.

CAUTION: THIS LIMITED WARRANTY ONLY COVERS VIDIKRON PRODUCTS PURCHASED FROM VIDIKRON AUTHORIZED DEALERS. ALL OTHER PRODUCTS ARE SPECIFICALLY EXCLUDED FROM COVERAGE UNDER THIS LIMITED WARRANTY. MOREOVER, DAMAGE RESULTING DIRECTLY OR INDIRECTLY FROM IMPROPER INSTALLATION OR SETUP IS SPECIFICALLY EXCLUDED FROM COVERAGE UNDER THIS LIMITED WARRANTY.

RIGHTS, LIMITS AND EXCLUSIONS:

Vidikron limits its obligations under any implied warranties under state laws to a period not to exceed the warranty period. There are no express warranties. Vidikron also excludes any obligation on its part for incidental or consequential damages related to the failure of this product to function properly. Some states do not allow limitations on how long an implied warranty lasts, and some states do not allow the exclusion or limitation of incidental or consequential damages. So the above limitations or exclusions may not apply to you. This warranty gives you specific legal rights, and you may also have other rights that vary from state to state.

EFFECTIVE WARRANTY DATE:

This warranty begins on the effective date of delivery to the end user. For your convenience, keep the original bill of sale as evidence of the purchase date.

IMPORTANT -- WARRANTY REGISTRATION:

Please fill out and mail your warranty registration card. It is imperative that Vidikron knows how to reach you promptly if we should discover a safety problem or product update for which you must be notified.

CONTACT A VIDIKRON AUTHORIZED SERVICE CENTER TO OBTAIN SERVICE:

Repairs made under the terms of this Limited Warranty covering your Vidikron video product will be performed at the location of the product, during usual working hours, providing location of product is within normal operating distance from a Vidikron Authorized Service Center. In some instances it may be necessary for the product to be returned to the Vidikron factory for repairs. If, solely in Vidikron's judgment, location of product to be repaired is beyond normal operating distance of the closest Vidikron Authorized Service Center, or the repair requires the unit be returned to the Vidikron factory, it is the owner's responsibility to arrange for shipment of the product for repair. These arrangements must be made through the selling Vidikron Dealer. If this is not possible, contact Vidikron directly for a Return Authorization number and shipping instructions. Vidikron will return product transportation prepaid in the United States, unless no product defect is discovered. In that instance, shipping costs will be the responsibility of the owner.

COPYRIGHT AND TRADEMARKS:

© Copyright 2005 Vidikron. This document contains proprietary information protected by copyright. All rights are reserved. No part of this manual may be reproduced by any mechanical, electronic or other means, in any form, without prior written permission of the manufacturer.

All trademarks and registered trademarks are the property of their respective owners.

ADDITIONAL INFORMATION:

To locate the name and address of the nearest Vidikron Authorized Service Center, or for additional information about this Limited Warranty, please call or write:

VIDIKRON
Attn: Customer Service Department
2900 Faber Street
Union City, CA 94587
Ph: (510) 324-5900
Fax: (510) 324-5905
Toll Free: (888) 4VIDIKRON

VIDIKRON PRODUCT INFORMATION
RETAIN THIS INFORMATION FOR YOUR RECORDS

Model Purchased

Date

Serial Number

Vidikron Authorized Dealer Name

Address

City

State/Province

Postal Code

Phone

Fax

Safety Precautions

Thank you for your purchase of this quality Vidikron product! It has been designed to provide you with the quality of video that is expected in a home theater. For the best performance, please read this manual carefully as it is your guide through the menus and operation.

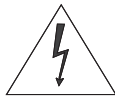
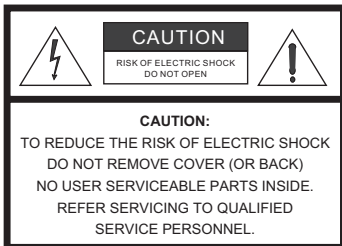

WARNING

This symbol is intended to alert the user to the presence of uninsulated "dangerous voltage" within the product's enclosure that may be of sufficient magnitude to constitute a risk of electric shock.



This symbol is intended to alert the user to the presence of important operating and maintenance (servicing) instructions in the literature accompanying the appliance.

CAUTION

To turn off main power, be sure to remove the plugs from power outlets. The power outlet socket should be installed as near to the equipment as possible, and should be easily accessible.

WARNING

TO PREVENT FIRE OR SHOCK HAZARDS, DO NOT EXPOSE THIS UNIT TO RAIN OR MOISTURE. ALSO DO NOT USE THIS UNIT'S POLARIZED PLUG WITH AN EXTENSION CORD RECEPTACLE OR OTHER OUTLETS, UNLESS THE PRONGS CAN BE FULLY INSERTED. REFRAIN FROM OPENING THE CABINET AS THERE ARE HIGH-VOLTAGE COMPONENTS INSIDE. REFER SERVICING TO QUALIFIED SERVICE PERSONNEL.

WARNING

This equipment has been tested and found to comply with the limits for a Class 'B' digital device, pursuant to Part 15 of FCC Rules. These limits are designed to provide reasonable protection against harmful interference when the equipment is operated in a commercial environment. This equipment generates, uses, and can radiate radio frequency energy and, if not installed and used in accordance with the Installation Manual, may cause harmful interference to radio communications. Operation of this equipment in a residential area may cause harmful interference, in which case the user will be required to correct the interference at his own expense.

DOC Compliance Notice

This Class B digital apparatus meets all requirements of the Canadian Interference-Causing Equipment Regulations.

Please read and follow the safety precautions listed below to ensure the equipment is free from damage, and to ensure that no injury will occur as a result of improper use.

- Do not insert any object, especially metal or liquids, into the LCD display.
- Do not place any objects containing water or any other liquid on top of the LCD display.
- Do not place the units in direct sunlight, near heaters or in extremely dusty or humid locations.
- Do not install this system outdoors or otherwise exposed to the elements.
- Do not place heavy objects on top of the LCD display.
- If the power cord is damaged or frayed in any way, electrical shock and/or fire may result. Do not place objects on the power cord, and keep the cord away from heat-emitting devices. Should the power cord become damaged in any way, please contact your Vidikron Dealer for a replacement cord.
- Do not remove the cover of the LCD display for any reason. If any problems arise with the unit, please contact a Vidikron Dealer or Vidikron International for service. Removing the covers will void the warranty.

Table of Contents

ONE YEAR LIMITED WARRANTY	iii
Safety Precautions	vi
1. Introduction	1
About This Manual	1
Target Audience.....	1
If You Have Comments About This Manual... ..	1
Textual and Graphic Conventions	1
Using This Manual	2
Description, Features and Benefits	3
Key Features and Benefits.....	3
Parts List	4
2. Controls and Functions	5
DView at a Glance	5
Controls and Indicators	5
Connectors	6
DView Remote Control	8
3. Installation	13
Remote Control	13
Notes on Batteries	13
Notes on Remote Control Operation.....	13
Quick Setup	14
Installation Considerations	15
Wall-Mounting the DView	15
Ambient Light	15
Other Considerations	15
Connections to the DView	16
Rear Connector Access	16
Connecting the DView to Source Components	16
MONITOR OUT Connection.....	20
Connecting Headphones.....	20
RS-232 Controller Connection	21

4. Operation	23
Turning on the Power	23
Changing the OSD Language	23
Setting the PC Display Properties	23
Using the On-Screen Menus	24
Main Menu	26
Source	26
Aspect Ratio	26
Picture Adjust.....	28
Audio	33
Timer	34
Setup	34
ISF Calibration	37
Using Picture-In-Picture (PIP)	40
Changing the PIP Position	41
Changing the PIP Size	42
Changing the PIP Aspect Ratio	42
Changing the PIP Image Mode	42
Swapping the Main and PIP Images	43
Swapping the Main and PIP Audio Programs	43
Stereo Sound/SAP	44
5. Maintenance and Troubleshooting	45
Troubleshooting Tips	45
6. Serial Communications	47
RS-232 Connection and Port Configuration	47
Serial Command Syntax	47
7. Specifications	51
DView Specifications	51
DView Dimensions	52
Computer/Video Signal Compatibility	53

List of Figures

- 2-1. DView Controls and Indicators 5
- 2-2. DView Connectors 6
- 2-3. DView Remote Control..... 8
- 3-1. DVI or HDMI Source Connections..... 17
- 3-2. Analog RGB Connections..... 18
- 3-3. Component Video Connections 19
- 3-4. Composite and S-Video Connections 19
- 3-5. Monitor Output Connections..... 20
- 3-6. Connecting Headphones..... 20
- 3-7. RS-232 Control System Connection..... 21
- 4-1. DView OSD Menu Structure 25
- 4-2. Typical PLUGE Pattern for Adjusting Brightness..... 29
- 4-3. Typical Gray Bar Pattern for Adjusting Contrast 30
- 4-4. Typical Color Bar Pattern for Adjusting Color Saturation and Tint 30
- 4-5. Typical Test Pattern for Adjusting Sharpness..... 32
- 4-6. DView Splash Screen..... 39
- 7-1. DView Dimensions..... 52

Notes:

Introduction

This Owner's Manual describes how to install, set up and operate the Vidikron VL-37 LCD Display. Throughout this manual, the Vidikron VL-37 LCD Display is referred to simply as the "DView."

Vidikron has prepared this manual to help home theater installers and end users get the most out of the DView.

Vidikron has made every effort to ensure that this manual is accurate as of the date it was printed. However, because of ongoing product improvements and customer feedback, it may require updating from time to time. You can always find the latest version of this and other Vidikron product manuals on-line, at www.vidikron.com.

Vidikron welcomes your comments about this manual. Send them to info@vidikron.com.

Text Conventions: The following conventions are used in this manual, in order to clarify the information and instructions provided:

- Remote control button identifiers are set in upper-case bold type; for example, "Press **EXIT** to return to the previous menu."
- All keys with functional names are initial-capped, set in bold type and enclosed in angle brackets. These keys are the following: **<Return>**, **<Spacebar>**, **<Control>**, **<Esc>** and **<Tab>**.
- **<Return>** indicates that you may press either the RETURN or ENTER key on your computer keyboard if it has both keys.
- Computer input (commands you type) and output (responses that appear on-screen) is shown in monospace (fixed-width) type; for example: "To change the aspect ratio to Letterbox, type [S4E0002."

In addition to these conventions, underlining, boldface and/or italics are occasionally used to highlight important information, as in this example:



*A carriage return **must** be used after each command or string.*

1.1 About This Manual

◀ *Target Audience*

◀ *If You Have Comments About This Manual...*

◀ *Textual and Graphic Conventions*

Graphic Conventions: These symbols appear in numerous places throughout the manual, to emphasize points that you must keep in mind to avoid problems with your equipment or injury:



Tip

TIPS highlight time-saving short cuts and helpful guidelines for using certain features.



Note

NOTES emphasize text with unusual importance or special significance. They also provide supplemental information.



Caution

CAUTIONS alert users that a given action or omitted action can degrade performance or cause a malfunction.



WARNING

WARNINGS appear when a given action or omitted action can result in damage to the equipment, or possible non-fatal injury to the user.



DANGER!

DANGER appears when a given action can cause severe injury or death.

1.2 Using This Manual

Use the following table to locate the specific information you need in this manual.

If you need...	... Turn to page:
Information about obtaining service	iv
General information about the VL-37 LCD Display	3
Installation instructions	13
First-time configuration instructions	23
Advanced configuration instructions	37
Troubleshooting tips	45
Specifications for the VL-37 LCD Display	51

Vidikron presents the high performance DView™ Series VL-37 LCD Display, perfect for those who demand our award-winning flat panel performance in a more intimate size than we offer with our larger plasma monitors.

The new DView™ high definition capable LCD displays offer common features and performance in popular 26, 32 and 37-inch sizes, suitable for close-in viewing where picture quality remains a high priority, but larger displays cannot be accommodated.

The DView™ Series VL-37 LCD Display incorporates the superb Imagix™ digital video processing that produces outstanding picture quality with a wide range of both standard and high definition source material.

In addition, the handsome, pewter-finish television is engineered with ISF™ calibration standards for the purest video performance. The VL-37 LCD Display also features PIP, PBP, closed captioning and Parental Control (V-Chip) functionality, as well as multi-language support. The display includes an integrated stereo audio system incorporating surround sound technology with 2-way speakers and generous power amplification.

The advanced TFT active matrix LCD display panel offers 1366 x 768 resolution and includes Vidikron's discrete aspect ratio control with IntelliWide™ mode to fill the 16:9 screen with standard 4:3 images without loss of picture quality. Also included are discrete source, aspect ratio and power selection and an RS-232 interface for whole house or automated control system integration.

The DView is multimedia ready, with simple computer connections making gaming, Internet browsing and other computer activities quick and easy.

The DView offers these key features and benefits:

- Native Resolution: 1366 x 768 (16:9 Native Aspect Ratio)
- Multiple Aspect Ratios with IntelliWide™ Mode
- Less than 4 inches thin
- DVI Input with High-bandwidth Digital Content Protection (HDCP)
- HDTV Ready
- Exceptional detail and artifact-free video enhancement
- Vidikron video processing with 3:2 film detection circuitry

1.3 Description, Features and Benefits

◀ **Key Features and Benefits**

Parts List ➤ Your DView is shipped with the following items. If any items are missing or damaged, please contact your Vidikron dealer or Vidikron Customer Service at (888) 4VIDIKRON.

- VL-37 LCD Display
- Remote Control Unit and two (2), AAA-size batteries
- AC Power Cord
- Warranty information and registration card
- Vidikron VL-37 Owner's Operating Manual (this document)

Optional Accessories:

- Wall Mount kit
- Table Stand

Controls and Functions

2.1 DView at a Glance

Figure 2-1 and Figure 2-2 show the locations of the DView controls, indicators and connectors.

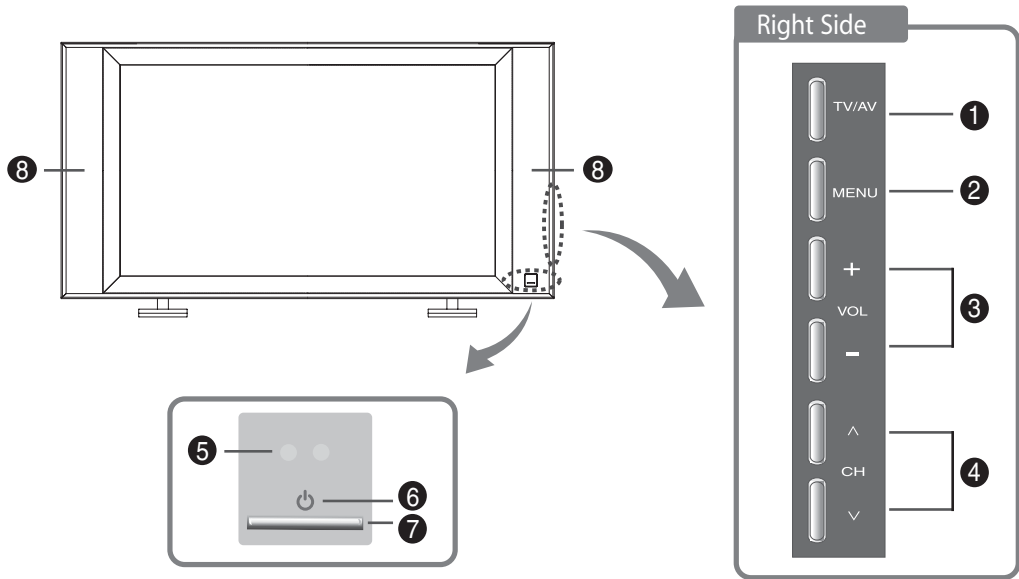

← Controls and Indicators

Figure 2-1. DView Controls and Indicators

- 1. **TV/AV Button (Input Source Selection)**
- 2. **MENU Selection Button**
- 3. **Volume Adjustment Buttons**
- 4. **Channel Selection Buttons**
- 5. **Remote Control Sensor**
- 6. **Power Indicator**
Lights red to indicate that the DView is in standby mode; lights green to indicate normal operation; flashes green when the DView receives a signal from the remote control.
- 7. **Power Button**
- 8. **Speakers**

Connectors ➤

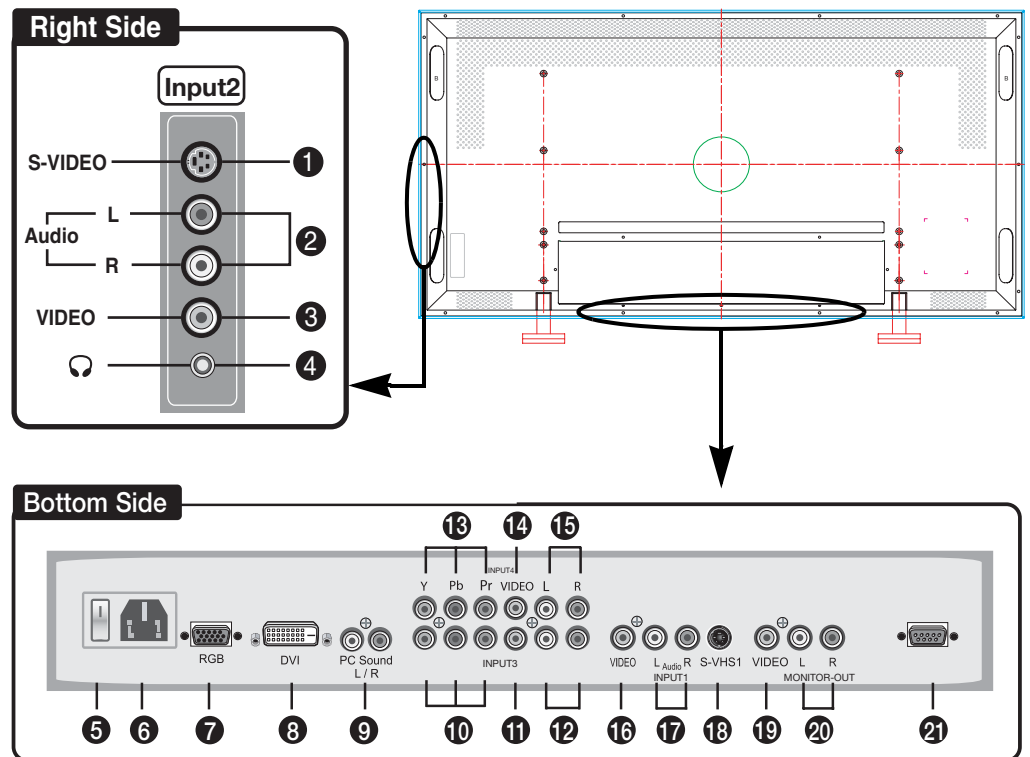

Figure 2-2. DView Connectors

1. **INPUT 2 S-Video Input**
Standard S-Video input for connecting a DVD player, satellite receiver or Super VHS (S-VHS) VCR.
2. **INPUT 2 Audio Input**
3. **INPUT 2 Composite Video Input**
Standard composite video input for connecting a VCR, camcorder, laser disc player or other composite video source.
4. **Headphone Jack**
5. **Main Power Switch**
6. **Power Input (100 to 240 VAC)**
Connect the DView to power here.
7. **RGB HD**
A 15-pin VGA connection to a personal computer. The DView automatically detects the signal resolution: 480i, 480p, 576i, 576p, 720p or 1080i.
8. **DVI/Computer Input (Digital)**
HDCP-compliant digital video input for connecting a DVD player, personal computer or HD tuner with a DVI or HDMI output.
9. **Audio Input (RGB/DVI)**
Connect the audio output from your RGB or DVI source here.

10. INPUT 3 Component Video (RCA connectors)

Standard-definition (480i/576i) or high-definition (720p/1080i), YPrPb component input. This is the input for component video from sources such as DVD players.



For best results, do not run your DVD player in progressive mode.

11. INPUT 3 Composite Video Input**12. INPUT 3 Audio Input**

Connect the audio output from your Input 3 source here.

13. INPUT 4 Component Video (RCA connectors)**14. INPUT 4 Composite Video Input****15. INPUT 4 Audio Input**

Connect the audio output from your Input 4 source here.

16. INPUT 1 COMPOSITE VIDEO INPUT**17. INPUT 1 Audio Input**

Connect the audio output from your Input 1 source here.

18. INPUT 1 S-Video Input**19. MONITOR-OUT (Composite Video)****20. MONITOR-OUT (Audio)****21. RS-232 CONTROL PORT**

A male, 9-pin D-sub connector for interfacing with a PC or home theater automation/control system.

2.2 DView Remote Control

Figure 2-3 shows the DView remote control, and the paragraphs that follow describe its functionality.

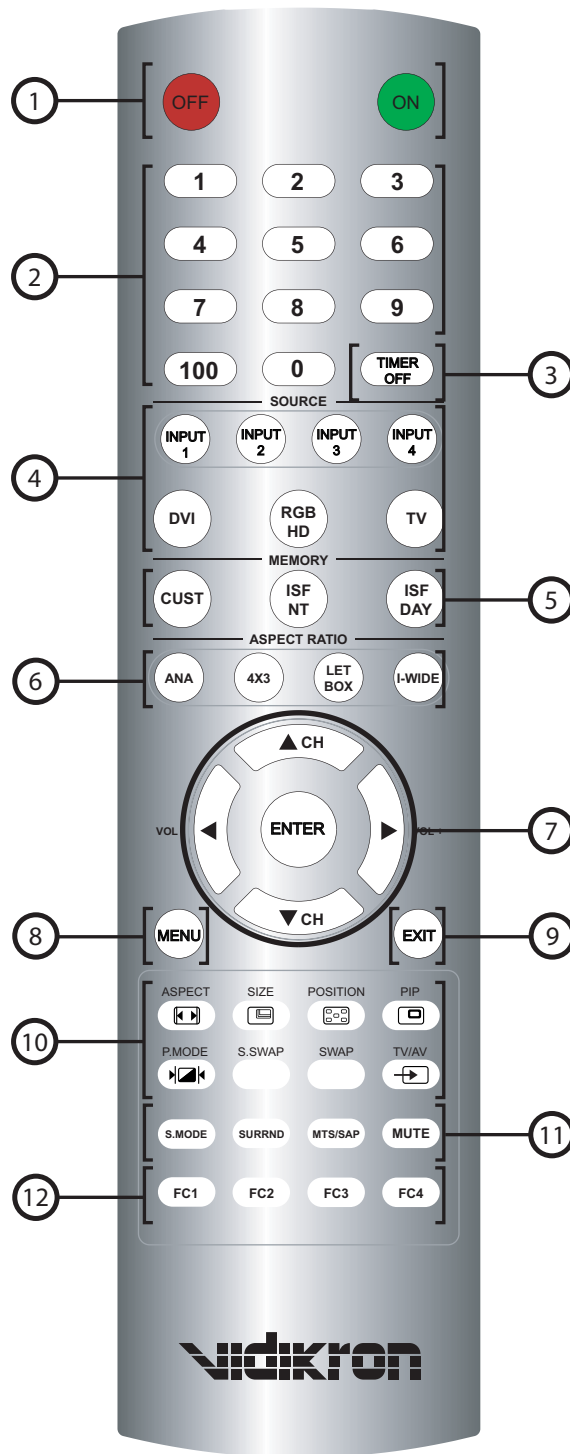

Figure 2-3. DView Remote Control

1. **OFF / ON**
Use these buttons to turn the DView on or off.
2. **Numeric Buttons**
Use these buttons to enter menu pass codes.
3. **TIMER OFF Button**
Press this button to set the sleep timer. Press it repeatedly to scroll through the available options (Off, 10, 30, 60, 120 or 180 minutes).
4. **Source Selection Buttons:**

INPUT 1

Press this button to switch to Input 1.

INPUT 2

Press this button to switch to Input 2.

INPUT 3

Press this button to switch to Input 3.

INPUT 4

Press this button to switch to Input 4.

DVI

Press this button to switch to the Digital Video input.

RGB HD

Press this button to switch to the RGB HD input.

TV

Not used with this model.

**Note**

Input 1 and Input 2 have both S-Video and composite video connectors. Input 3 and Input 4 have both component and composite video connectors.

*To specify which connection type you are using -- or to switch from one to the other if equipment is connected to both -- use the Input Selection menu under Setup (refer to **Input Selection** on page 37).*

5. **Memory Preset Buttons:**

CUST

Press to recall settings for the current input from the "Custom" memory preset.

ISF NT (Night)

Press to recall settings for the current input from the "ISF Night" memory preset.

ISF DAY

Press to recall settings for the current input from the "ISF Day" memory preset.

6. **Aspect Ratio Selection Buttons:**

ANA (Anamorphic)

For 16:9 DVDs or HDTV program material.

4X3 (Standard 4:3)

The input signal is scaled to fit 4:3 display mode in the center of the screen.

LETBOX (Letterbox)

Image in letterbox format is enlarged to fit 16:9 full screen display and the upper/ lower portions are "blanked off."

I-WIDE (IntelliWide)

4:3 image is enlarged NON-linearly in horizontal direction to fit 16:9 full screen display.

7. **Arrow Buttons (▲, ◀, ▼, ▶)**

Use these buttons to select items or settings, adjust settings or adjust sound volume.

ENTER

Press to select a highlighted menu item or confirm a changed setting.

8. **MENU**

Press this button to access the on-screen display (OSD) controls, or to exit the current menu and return to the previous one.

9. **EXIT**

Press this button to hide the OSD controls.

10. **Picture-In-Picture (PIP) Function Buttons**

ASPECT 

Press to change the aspect ratio of the PIP window from 4:3 to 16:9 or vice versa.

SIZE 

Press to choose from three PIP window sizes.

POSITION 

Press to choose the PIP window position (top left, top right, bottom left or bottom right corner).

PIP 

Press to change the PIP mode (picture-in-picture, picture-by-picture or off).

P.MODE 

Press to recall settings for the PIP input from either the "ISF Night" or "ISF Day" memory preset.

S.SWAP

Press to switch between the main and PIP audio programs.

SWAP

Press to swap the main and PIP windows.

TV/AV 

Press to switch to a different PIP video source.

11. **Sound Control Buttons:**

S.MODE

Press this button repeatedly to scroll through the available Equalizer presets (CUSTOM, STANDARD, MUSIC, FILM or SPEECH).

SURRND (Surround)

Press this button to turn Surround Mode on or off.

MTS/SAP (Multichannel Television Sound/Second Audio Program)

Press this button repeatedly to scroll through the available MTS settings (MONO, STEREO, SAP or Mono+SAP).

MUTE

Press this button to mute the audio output.

12. **FC1/FC2/FC3/FC4**

Not used with this model.

Notes:

Installation

To install batteries in the remote control:

1. Slide the battery cover in the direction of the arrow and remove it.
2. Insert the included batteries. Ensure that the polarities correctly match the \oplus and \ominus markings inside the battery compartment.
3. Slide the battery cover back on until it snaps into place.

- When installing batteries, make sure that the battery polarities are correct.
- Do not mix an old battery with a new one or different types of batteries.
- If you will not use the remote control for a long time, remove the batteries to avoid damage from battery leakage.
- Do not drop the remote control or expose it to moisture or high temperature.
- The remote control may malfunction under a fluorescent lamp. If that occurs, move the LCD display away from the fluorescent lamp.
- Make sure that there is nothing obstructing the infrared beam between the remote control and the IR receiver on the LCD display.



Note

The signal from the remote control can be reflected by walls or other surfaces.

- If the effective range of the remote control decreases, or it stops working, replace the batteries with new ones.
- Ambient conditions may possibly impede the operation of the remote control. If this happens, point the remote control at the LCD display and repeat the operation.

3.1 Remote Control

◀ Notes on Batteries

◀ Notes on Remote Control Operation

3.2 Quick Setup

Table 3-1 gives a quick overview of the DView installation process. The sections following this one provide detailed instructions.



Note

Installation should be performed by a qualified custom video installation specialist.

Table 3-1. Installation Overview

Step	Procedure	For Details, refer to page...
1	Mount the DView on a wall (optional)	15
2	Connect signal sources to the DView	16
3	Connect external controller to RS-232 port (optional)	21
4	Apply power to the DView	23
5	Change the OSD language	23
6	If using the DView with a PC, adjust PC display properties	23
7	Display calibration: adjust the following for each input , starting with Component (Input 3 and/or Input 4); save settings when finished: <ul style="list-style-type: none"> • Aspect ratio • Brightness • Contrast • Color level • Tint • Input position 	26 through 37

Proper installation of your DView will ensure the highest possible picture quality. Whether you are installing the DView temporarily or permanently, you should take the following into account to ensure that it performs optimally.

You can either place the DView on a table or in an entertainment center, or mount it on a wall.

If you do decide to wall-mount the DView, ensure that the wall-mount bracket is installed according to the instructions included with it. The wall must be capable of supporting a redundant weight factor three (3) times the weight of the display, or be reinforced.

Vidikron recommends that this be done by a custom installation specialist.

**Note**

Use only the Vidikron-approved wall-mount kit designed for your display.

In general, minimize or eliminate light sources directed at the display. Contrast ratio in your images will be noticeably reduced if light directly strikes the display, such as when a shaft of light from a window or floodlight falls on the image. Images may then appear washed out and less vibrant.

Other considerations and tips that can help improve your installation:

- Keep the ambient temperature constant and below 35°C (95°F). Keep the display away from heating and/or air conditioning vents. Changes in temperature may cause drifts in the display circuitry, which may affect performance.
- Keep the DView away from devices that radiate electromagnetic energy such as motors and transformers. Common sources of these include slide projectors, speakers, power amplifiers and elevators.

3.3 Installation Considerations

◀ **Wall-Mounting the DView**

◀ **Ambient Light**

◀ **Other Considerations**

3.4 Connections to the DView

Proceed as follows to connect the DView to your video sources, external controller(s) -- if present -- and AC power.

When connecting your equipment:

- Turn off all equipment before making any connections.
- Use the correct signal cables for each source.
- Ensure that the cables are securely connected. Tighten the thumbscrews on connectors that have them.
- Use the left audio input when connecting mono audio sources.

Rear Connector Access ➤ To access the left rear connector panel, push down on the plastic clip holding the cover in place. Then, pull firmly on the cable access cover to open it.

Connecting the DView to Source Components ➤ Connect your video sources to the DView as shown and described in the sections that follow.

DVI Connections: The DView has a DVI input for connecting a DVD player, DTV decoder, personal computer or any other device with a DVI or HDMI output. Connect such devices as shown in Figure 3-1.



Tip

Use the DVI inputs whenever possible. This ensures the highest video quality because the signal is carried in the digital domain throughout the entire signal path, from source component output into the display.



Note

This DView supports the VESA Display Data Channel (DDC) standard. This standard provides "Plug and Play" capability; the display and a VESA DDC-compatible computer communicate their setting requirements, allowing for quick and easy setup.

In order for Plug and Play to work correctly, you must turn on the display before you turn on the connected computer.

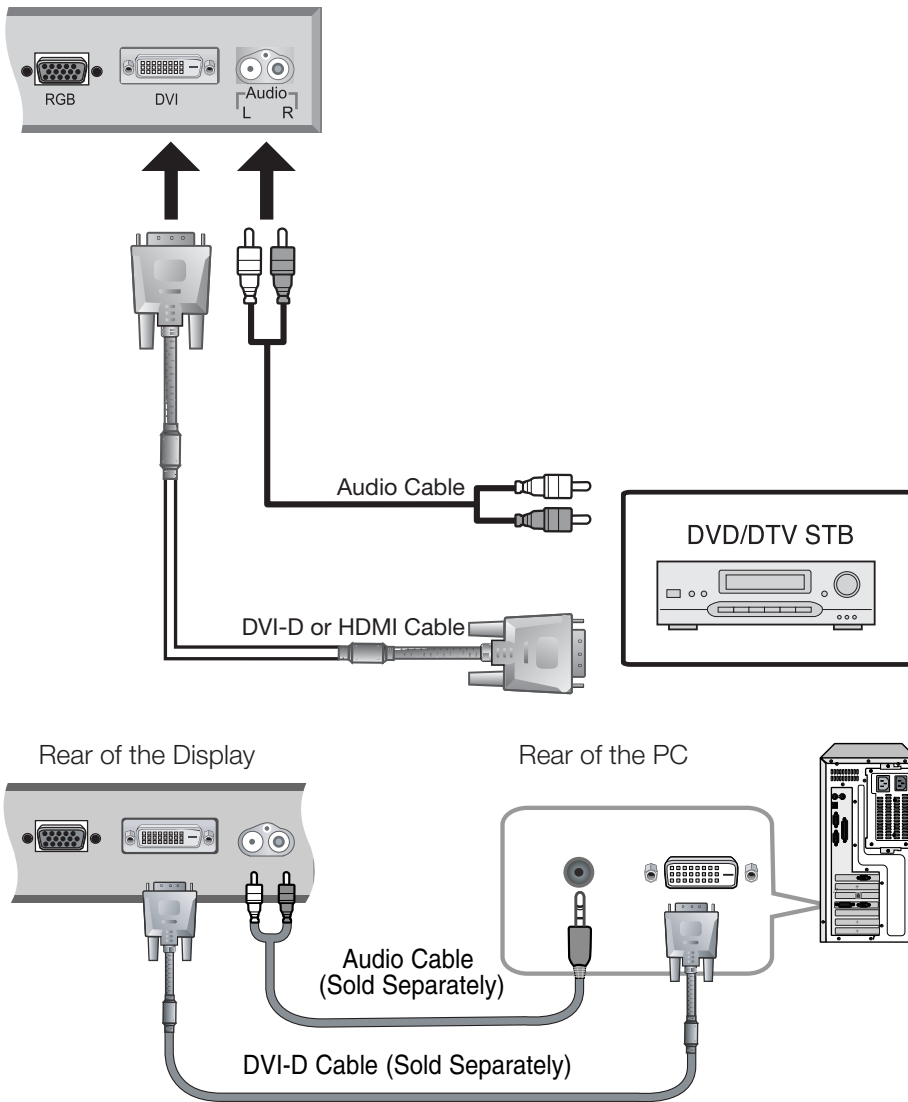

Figure 3-1. DVI or HDMI Source Connections

RGB-HD Connections: The DView has an RGB input for connecting a personal computer (see Figure 3-2) or DTV decoder with an RGB output. (This application requires a DB15-to-RGBHV breakout cable.)

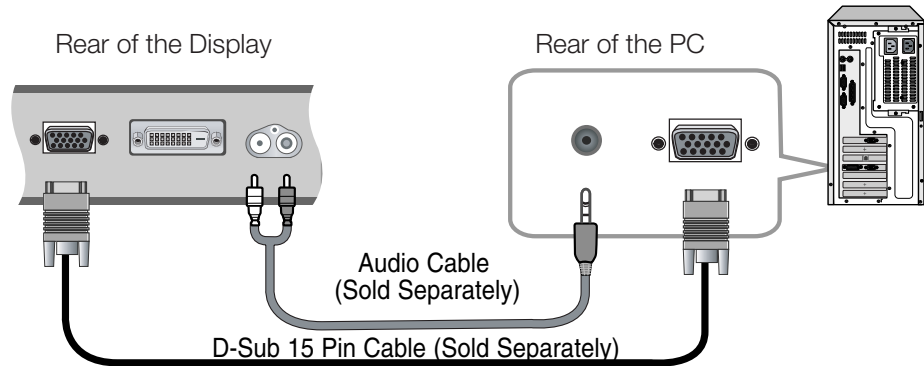

Figure 3-2. Analog RGB Connections



Note

1. Refer to **Computer/Video Signal Compatibility** on page 53 for a list of computer signals compatible with the DView. Use with signals other than those listed may cause some functions not to work.
2. Some Macintosh computers may require a Macintosh video adapter. Contact your nearest authorized service center or dealer.
3. This DView may not be able to display images from notebook computers in simultaneous (CRT/LCD) mode. Should this occur, switch the notebook computer to "CRT only" mode. If you are unsure how to do this, refer to your notebook computer's user manual.

Component Video Connections: If you have a DVD player or DTV decoder with a component (YPbPr) output, connect it to INPUT 3 or INPUT 4 of the DView as shown in Figure 3-3.

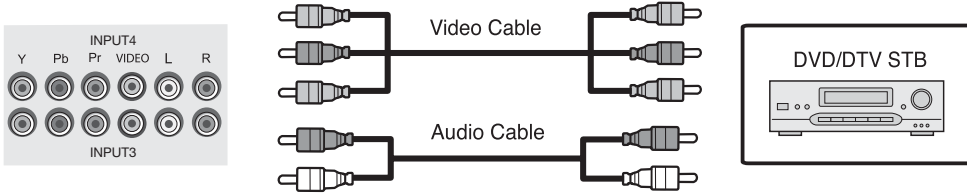

Figure 3-3. Component Video Connections

Composite/S-Video Connections: The DView has two (2) S-Video and four (4) composite video inputs for connecting a VCR, camcorder, laser disc player or DVD player; see Figure 3-4.

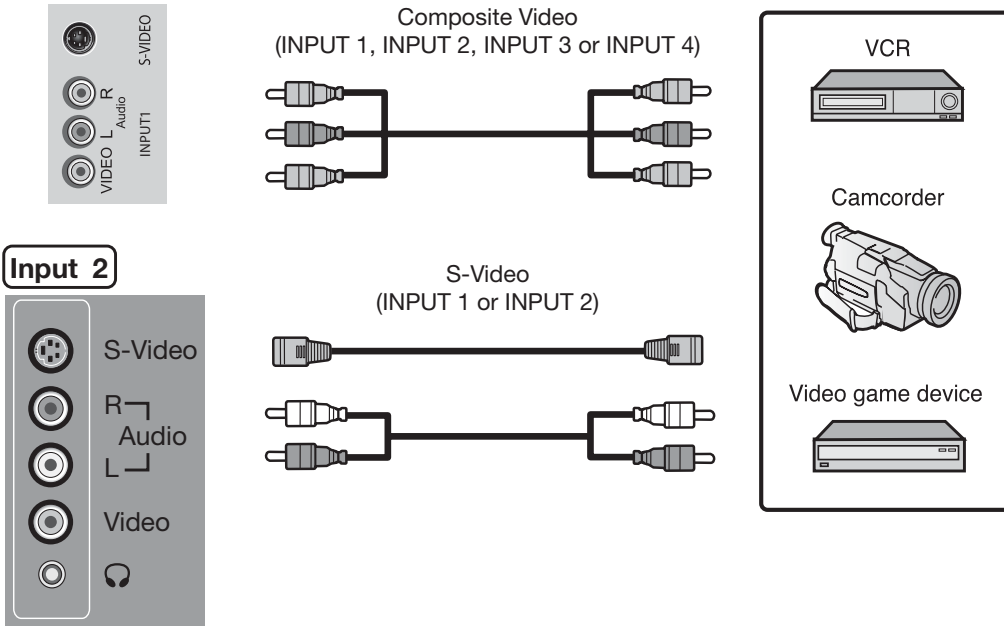

Figure 3-4. Composite and S-Video Connections

MONITOR OUT Connection ➤ The DView has a monitor out feature for connecting a second VCR or other auxiliary equipment. Connect the MONITOR OUT audio and video jacks to the audio and video inputs of the VCR or other equipment as shown in Figure 3-5.

You can route either the main or picture-in-picture (PIP) source to the monitor outputs. For more information, refer to **Monitor Out** on page 37.

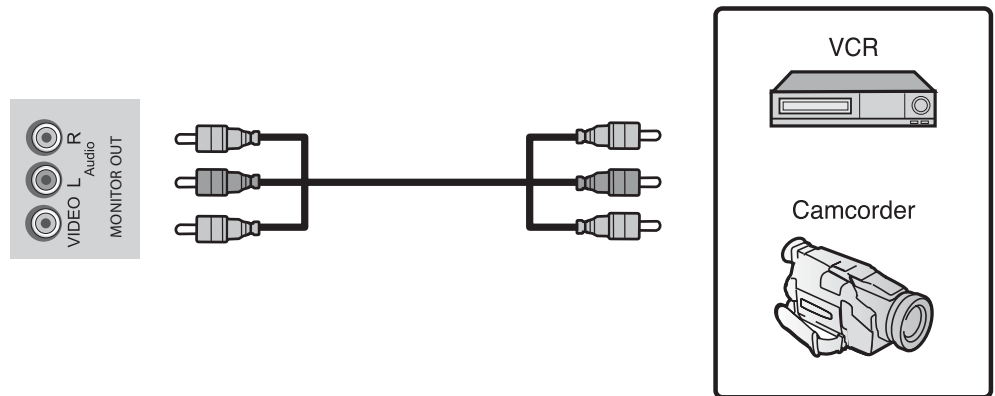

Figure 3-5. Monitor Output Connections

Connecting Headphones ➤ You can connect a set of headphones to the DView to watch a program without disturbing others. Connect them to the headphone output located at INPUT 2; see Figure 3-6.

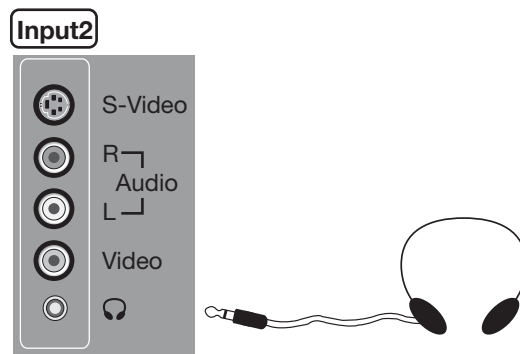
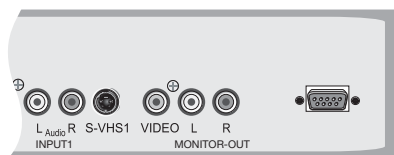

Figure 3-6. Connecting Headphones

Use a standard, 9-pin RS-232 cable to connect a PC or home theater control/automation system (if present) to the RS-232 port on the DView; see Figure 3-7.

◀ **RS-232 Controller Connection**

For more information about using this connection, refer to **Serial Communications** on page 47.



Connector Pin Assignments:

2	Receive Data
3	Transmit Data
5	Ground
1, 4, 6, 7, 8, 9	Not Connected

Figure 3-7. RS-232 Control System Connection

Notes:

1. Turn on your source components.
2. Plug the female end of the power cord into the AC receptacle on the rear of the DView (AC 100V ~ 240V).
3. Connect the other end to your AC power source. The power indicator lights red to indicate that the DView is in "standby" mode.
4. Press the **ON** button on the remote control to turn on the display (or press the power button on the front of the display). The power indicator flashes for a few seconds, then lights solid green.
5. After a brief warm-up period (approximately 10 seconds), the DView will display an image.

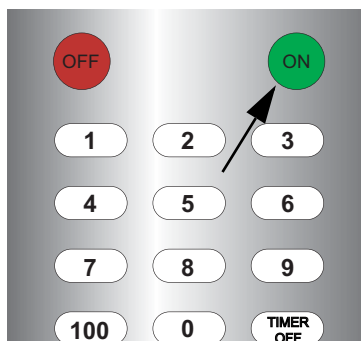

4.1 Turning on the Power

The DView OSD language is initially set to English, but can also display the menus in French, Spanish, Portuguese or German. To change the OSD language:

1. Press **MENU**.
2. Select **Setup** from the Main Menu.
3. Select **OSD Language** from the Setup Menu.
4. Press **▲** or **▼** to highlight the desired language and press **ENTER**. The change takes effect immediately.

4.2 Changing the OSD Language

To maximize image quality when using the DView with a personal computer, you may need to adjust the display properties of your PC video card. To do this:

1. Choose Settings from the Windows Start menu and click on "Control Panel."



4.3 Setting the PC Display Properties

2. Double click on the **Display** icon.
3. Click the **Settings** tab on the display dialog box.
4. Adjust the resolution to 1024x768 pixels.

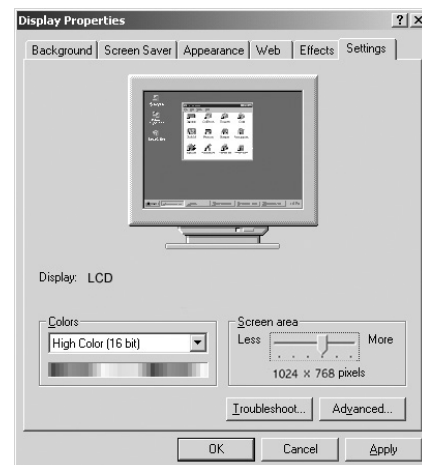

5. Click the **Advanced** button and click the **Monitor** tab on the dialog box. Set the vertical frequency to 60Hz and click **OK**.

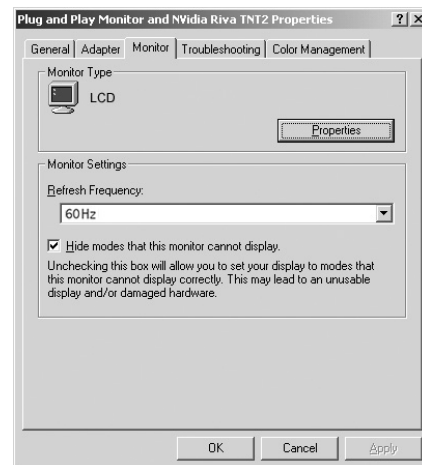

Note

1. The maximum available resolution and vertical frequency is 1024 x768 at 75Hz or the maximum supported by your video card, whichever is lower. You can get the best picture at 1024 x768 @ 60Hz.
2. The DView supports 24-bit color (16,777,216 possible colors).

4.4 Using the On-Screen Menus

To use the on-screen menus:

1. Press **MENU** to display the Main Menu.
2. To select a menu item, use the up- or down-arrow buttons (▲, ▼) on the remote control to highlight it.
3. Press **ENTER** or the right-arrow button (▶) to access that menu.
4. Use the up- or down-arrow buttons (▲, ▼) to select the setting you want to change. Then, press **ENTER** or the right-arrow button (▶).
5. Press the right- or left-arrow button (◀, ▶) to change that setting.
6. To return to the previous menu, press **MENU**.

The DView OSD menus are arranged hierarchically, as shown in Figure 4-1. Depending on the selected input source, some menu options may not be available.

Source	Input 1		
	Input 2		
	Input 3		
	Input 4		
	DVI		
	RGB		
Aspect Ratio	Anamorphic		
	Standard		
	Letterbox		
	IntelliWide		
Picture Adjust	Brightness		
	Contrast		
	Color		
	Tint		
	Sharpness	0, 10, 20, ... 100	
	Color Temp.	5400, 6500, 8500 or Custom	
	Backlight	0, 5, 10, 15, 20, ... 100	
	Save Settings (not available on RGB input)	Custom	
	Restore Settings (not available on RGB input)	Custom, ISF Day, ISF Night	
	Audio	Balance	L10, L9, L8 ... 0 ... R8, R9, R10
Equalizer		Standard, Music, Film, Speech or Custom	
Surround		(On/Off)	
Timer	Time	12:00 AM - 11:59 PM	
	On Timer	Enable/Disable, Time, Volume	
	Off Timer	Enable/Disable, Time	
	Sleep Timer	Off, 10, 30, 60, 120 or 180 minutes	
Setup	OSD Language	English, French, Spanish, Portuguese or German	
	PC Mode Adjust	Auto Adjust	
		H. Position	
		V. Position	
		H. Size	
		Phase	
	Factory Preset		
	Caption	Display (On/Off), Mode, CC On Mute (Yes/No)	
	Parental Control	Parental Lock (On/Off), TV Rating, Movie Rating, Unrated (Allow/Block), Change PIN (default is 0000)	
	Letterbox Mode	Standard or Cinema Fill	
Input Selection	Input 1/Input 2: Video or S-Video Input 3/Input 4: Video or Component		
Monitor Out	Main or PIP: Video		
Overscan (not available on RGB input)	H. Overscan, H. Shift, V. Overscan, V. Shift		

ISF Calibration	Picture Adjust	Brightness	
		Contrast	
		Color	
		Tint	
		Sharpness	0, 10, 20, ... 100
		Color Temp.	5400, 6500, 8500 or Custom
	Backlight	0, 5, 10, 15, 20, ... 100	
	Save Settings (not available on RGB input)	ISF Night, ISF Day, Custom	
	White Balance	R/G/B Gain	
		R/G/B Offset	
	Blue Enable	(Enable/Disable)	
	DNR	0, 10, 20, ... 100	
	Gamma	2.0, 2.2 or 2.4	
	Baud Rate	115200, 19200, 9600 or 2400	
	Command Ack	(On/Off)	
Factory Reset			
Splash Duration	0, 1, 2, 3, ... 60 secs.		

Figure 4-1. DView OSD Menu Structure

Main Menu ➤ The Main Menu is the starting point for accessing all DView functions.
(The ISF Calibration menu is not accessible until you enter a passcode.)

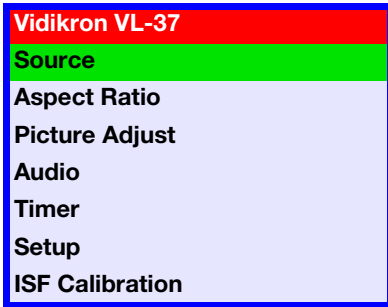

Source ➤ From the Main Menu, select Source to choose a video signal source.

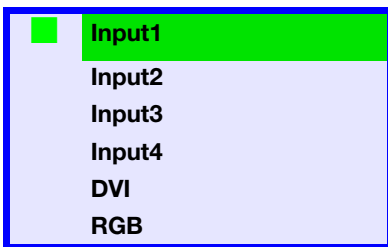

The active source is indicated by a green square (■) to its left; in the example at left, TV is the active source.

Aspect Ratio ➤ To change the aspect ratio (size and shape) of the projected image, select Aspect Ratio from the Main Menu and press **ENTER**. Select the appropriate aspect ratio for the type of program material being viewed; refer to Table 4-1.

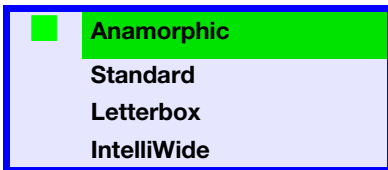



The currently-selected aspect ratio is indicated by a green square (■) to its left; in the example at left, Anamorphic is selected.



Note

*When you change the aspect ratio, save the change to a preset afterwards. Otherwise, the change will be lost when a different input is selected. (The aspect ratio is saved for each input and resolution separately.) For information about saving settings, refer to **Save Settings (not available for RGB input)** on page 33.*

Table 4-1. Aspect Ratio Settings

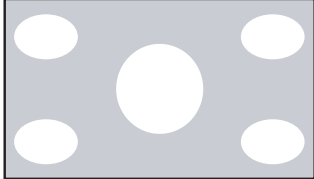
Aspect Ratio	Remote Control Key	Description	
Anamorphic	ANA		<p>Select Anamorphic to view 16:9 DVDs and HDTV programs in their native aspect ratio. 4:3 images are stretched horizontally to fit a 16:9 screen.</p>
Standard	4X3		<p>Standard 4:3 scales the input signal to fit in the center of the 16:9 screen.</p> <p>4:3 is the aspect ratio used by computer monitors, standard television programming and most VHS video cassettes.</p>
Letterbox	LET BOX		<p>In Letterbox mode, the image is stretched vertically; the top and bottom portions are "blanked off."</p>
IntelliWide	I-WIDE		<p>A 4:3 image is horizontally scaled in a NON-linear fashion (more on the sides than in the center) to fit a 16x9 screen.</p>

Picture Adjust ➤

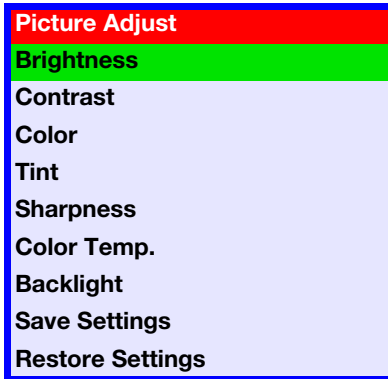

Use the controls in the Picture Adjust menu to calibrate your DView for optimum picture quality.

The DView has been designed to incorporate setup and calibration standards established by the Imaging Science Foundation (ISF). The ISF has developed carefully crafted, industry-recognized standards for optimal video performance and has implemented a training program for technicians and installers to use these standards to obtain optimal picture quality from Vidikron video display devices. Accordingly, Vidikron recommends that setup and calibration be performed by an ISF-certified installation technician.

All signal types require separate processing. Therefore, you need to calibrate each input separately. Vidikron recommends calibrating the DView inputs in the following order:

1. Component (Input3/Input4)
2. S-Video (Input1/Input2)
3. Video (Input1/Input2/Input3/Input4)
4. RGB
5. DVI



Note

*When you change a picture quality setting, save the change to a preset afterwards. Otherwise, the change will be lost when a different input is selected. (Picture quality settings are saved for each input and resolution separately.) For information about saving settings, refer to **Save Settings (not available for RGB input)** on page 33.*

Although it may be possible to obtain satisfactory picture quality using the naked eye and regular program material, Vidikron recommends using the following calibration tools for best results:

- External test pattern source -- Sencore VP401 Multimedia Video Generator, Ovation Multimedia test DVD or equivalent.
- A blue filter (provided with many test DVDs), for color level and tint adjustments.

Connect your test pattern source to the input that you are calibrating and proceed as follows. **Perform the adjustments in the order listed here.**

Brightness: On your external test pattern source, select a PLUGE pattern. (PLUGE is an acronym for "Picture Line-Up Generation Equipment.") Figure 4-2 shows a typical PLUGE pattern.

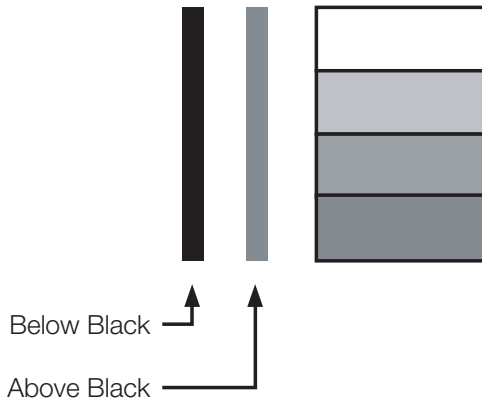

Figure 4-2. Typical PLUGE Pattern for Adjusting Brightness

PLUGE patterns vary but generally consist of some combination of black, white and gray areas against a black background. The example above includes two vertical bars and four shaded boxes.

Select Brightness from the Picture Adjust menu. Using the left- and right-arrow (◀ ▶) buttons, adjust the brightness so that:

- The darkest black bars disappear into the background.
- The dark gray areas are barely visible.
- The lighter gray areas are clearly visible.
- The white areas are a comfortable level of true white.
- The image contains only black, gray and white (no color).

Contrast: On your external test pattern source, select a stepped, gray-bar pattern like the one shown in Figure 4-3.

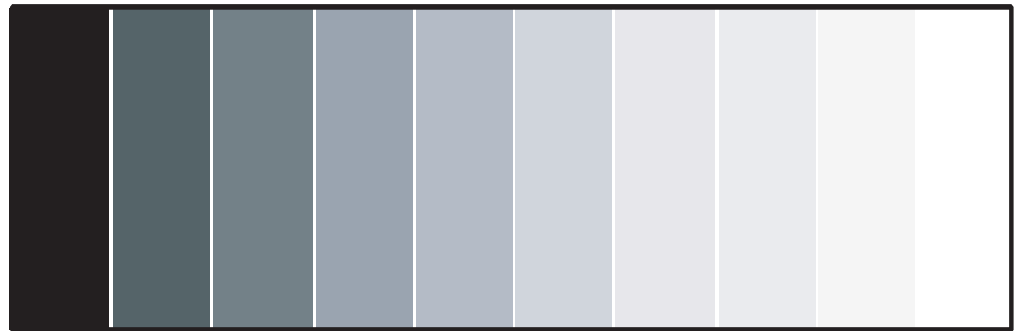

Figure 4-3. Typical Gray Bar Pattern for Adjusting Contrast

Select Contrast from the Picture Adjust menu. Using the left- and right-arrow (◀ ▶) buttons, adjust the contrast to a point just below which the white rectangle starts to increase in size.



Note

Brightness and contrast controls are interactive. A change to one may require a subtle change to the other in order to achieve the optimum setting.

Color Saturation: On your external test pattern source, select a color bar pattern like the one shown in Figure 4-4.

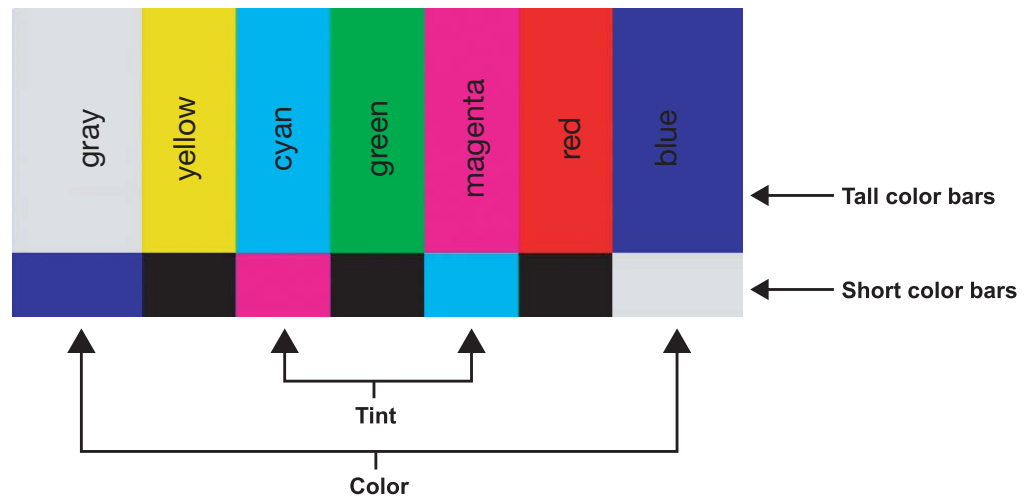
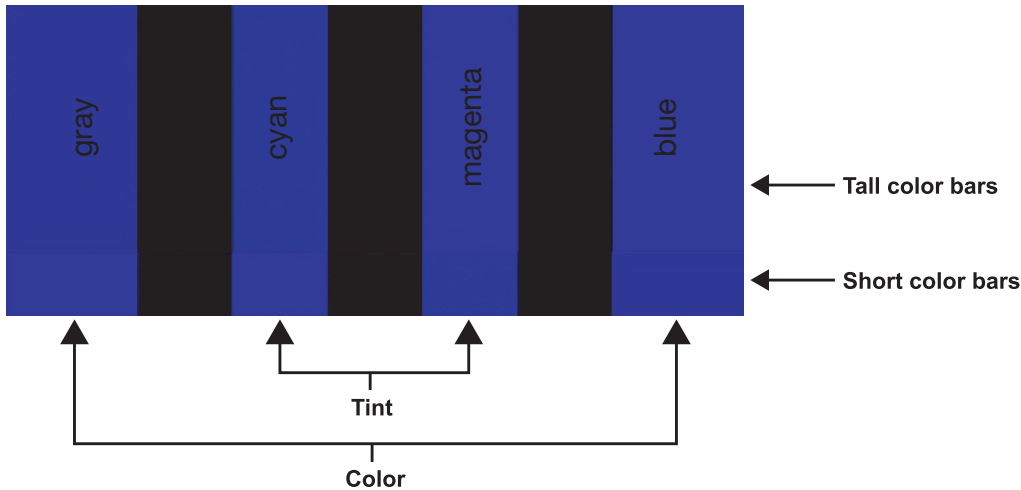

Figure 4-4. Typical Color Bar Pattern for Adjusting Color Saturation and Tint

Select Color from the Picture Adjust menu. While looking at the color bar pattern through a blue filter, adjust the color saturation level until the outermost (gray and blue) color bars appear to be a single shade of blue:



Tint: Tint or “hue” is essentially the ratio of red to green in the color portion of the image. When tint is decreased, the image appears redder; when it is increased the image appears greener. To set the tint, select Tint from the Picture Adjust menu. While looking at the color bar pattern through a blue filter, adjust the tint level until the cyan and magenta color bars (on either side of the green bar) appear to be a single shade of blue.



Note

Like the brightness and contrast controls, the color and tint controls are interactive. A change to one may require a subtle change to the other in order to achieve the optimum setting.

Sharpness: “Sharpness” is the amount of high-frequency detail in the image. To adjust sharpness, select Sharpness from the Picture Adjust menu and press **ENTER**. On your external test pattern source, select a pattern like the one shown in Figure 4-5. Adjust as needed, looking for white edges around the transitions from black to gray and different sized lines in the “sweep” patterns at the top and bottom. Lower the sharpness setting to eliminate them.

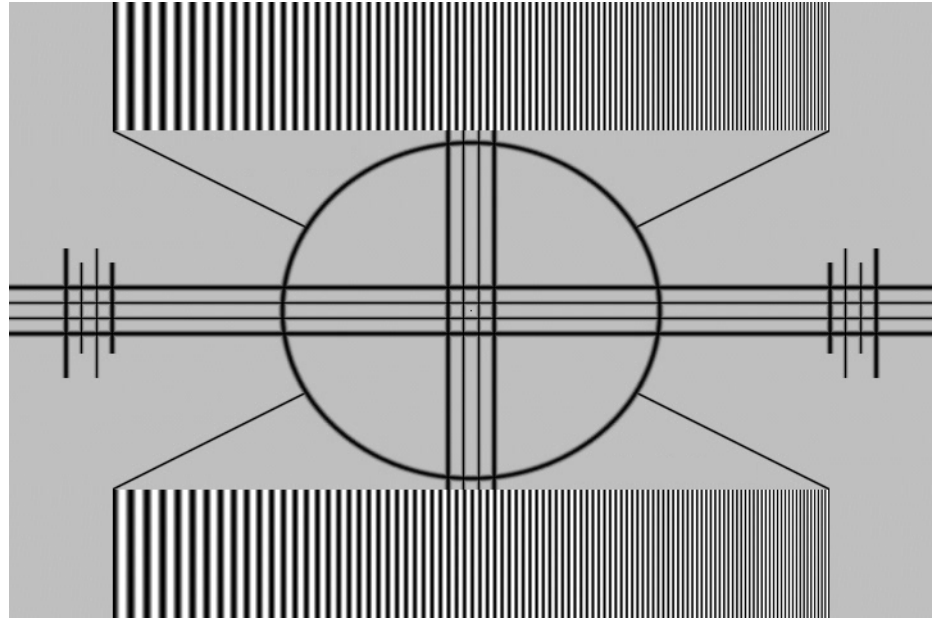

Figure 4-5. Typical Test Pattern for Adjusting Sharpness

Color Temperature: To adjust the color temperature, select Color Temp. from the Picture Adjust menu and press **ENTER**. (Color temperature defines the “color of gray.”) The choices are 5400K, 6500K, 8500K and Custom. The default setting, 6500K, is appropriate for most situations. Higher settings produce a “bluer” picture; lower ones impart a reddish hue to the image.

Backlight: The Backlight control changes the apparent brightness of the displayed image. Its effect is similar to that of a lamp intensity control on a projector.

Save Settings (not available for RGB input): The DView lets you save image quality settings for each input and supported resolution to a preset. You can recall this preset at a later time by simply pressing a button on the remote control or using the Restore Settings menu command (see below).

You should save changes to any of the following settings to a preset; otherwise they will be lost when a new input source or resolution is selected:

- Aspect ratio
- Brightness
- Contrast
- Color saturation
- Tint
- Sharpness
- Gamma
- Color temperature and white balance

Restore Settings (not available for RGB input): To recall a preset, choose Restore Settings from the Picture Adjust menu and select "Custom," "ISF Day" or "ISF Night." Or, use the corresponding buttons on the remote control.

To adjust the DView audio settings, select Audio from the Main Menu and press **ENTER**.

◀ **Audio**

Balance: To adjust the left/right speaker balance, select Balance from the Audio Menu and press **ENTER**. Use the left- and/or right-arrow buttons to make one channel louder than the other.

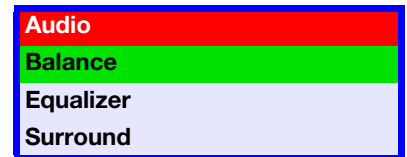

Equalizer: The DView has a five-band graphic equalizer that you can use to boost or cut certain audio frequencies. To use it, select Equalizer from the Audio menu and press **ENTER**. Select one of four equalizer presets -- Standard (flat), Music, Film or Speech -- or select Custom to create your own according to taste. The five frequency bands are 100, 300, 1000, 3000 and 10,000 Hertz (Hz).

Surround: The DView has a "surround sound" mode that simulates a multi-channel sound system. To use the surround mode, select Surround from the Audio menu and set it to On.



Note

When Surround is set to On, the graphic equalizer is disabled.

Timer ➤ To set the DView internal clock or configure the on/off timers, select Timer from the Main Menu and press **ENTER**.



Time: To set the DView internal clock, select Time from the Timer menu and press **ENTER**. Use the up- or down-arrow button to select either the hour of the day or the minute of the hour to set. Then, use the left- or right-arrow buttons to set that component of the time. When finished, press **MENU**.

On Timer: Use the On Timer to turn the DView on at a specific time of day. You can also specify a volume level.

Off Timer: Use the Off Timer to turn the DView off at a specific time of day.

Sleep Timer: Use the Sleep Timer to turn off the DView after a specified interval.

To set the Sleep Timer:

- Select Sleep Timer from the Timer menu and press **ENTER**. Use the right- or left-arrow button to select 10, 30, 60, 120 or 180 minutes. Then, press **MENU**.
-- OR --
- Press the **TIMER OFF** button on the remote control repeatedly to select the desired timer interval.

Setup ➤ Use the controls in the Setup menu to perform advanced image quality adjustments and access various other DView features.

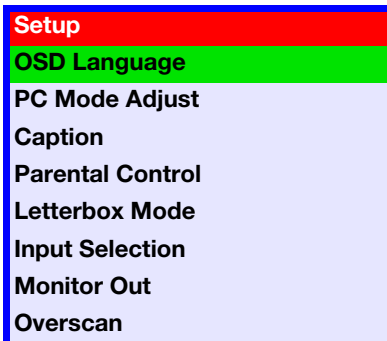

OSD Language: Select OSD Language from the Setup menu and press **ENTER**. Then, use the up- or down-arrow buttons to select the OSD language (English, French, Spanish, Portuguese or German). Press **ENTER** again to confirm your selection.

PC Mode Adjust: To improve the quality of projected images from a computer or other VESA-compliant, RGB (480p or higher) source, select PC Mode Adjust and press **ENTER**.

- **Auto Adjust:** Auto Adjust automatically adjusts settings to optimize computer images. To execute Auto Adjust on command, select Auto Adjust and press **ENTER**.



Note

Auto Adjust may take some time to complete, depending on the characteristics of the incoming signal.

- **H Position:** Use the up- or down-arrow buttons (▲, ▼) to highlight H Position. Then, use the right-arrow button (▶) to shift the image to the right; use the left-arrow button (◀) to shift the image to the left.
- **V Position:** Use the up- or down-arrow buttons (▲, ▼) to highlight V Position. Then, use the right-arrow button (▶) to shift the image up; use the left-arrow button (◀) to shift the image down.
- **H Size:** Use the up- or down-arrow buttons (▲, ▼) to highlight H Size. Then, use the right-arrow button (▶) to increase the width; use the left-arrow button (◀) to decrease it.
- **Phase:** Adjust the phase if the image shows shimmer or “horizontal” noise. Pixel phase adjusts the phase of the pixel sampling clock relative to the incoming signal. The effect of this control is similar to that of a tracking control on a VCR.

For best results, use a good test pattern such as a smooth gray consisting of a clear pattern of black and white pixels, or a similar “half on, half off” graphic image. (You may notice that you can stabilize the image at more than one point. Use either setting in this case.)

To restore the factory-default Position, Size and Phase settings, select Factory Preset and press **ENTER**.

Caption: Select Caption from the Setup menu to control the display of closed captions when watching programs that contain them.

- **Display:** Select On or Off to control the display of closed captions.
- **Mode:** Select one of four captioning modes: CC1, CC2, CC3 or CC4. CC1 usually contains the native-language captions; if a program is captioned in more than one language, those captions are carried on CC2, CC3 or CC4.

The DView also supports “text mode” captioning; to use this feature, select Text1, Text2, Text3 or Text4. The text modes, instead of displaying a few lines of captions somewhere on the picture, take over all or half of the screen to display scrolling text information. (The text modes are seldom used today, so most of the time there is no information there to see.) The text field is sometimes used for embedding Internet data (called Interactive TV Links, or ITV Links) in the captions.

- **CC On Mute:** To have the DView display captions when the audio output is muted, set this option to Yes.

Parental Control: To block the display of television programs or movies based on their ratings, select Parental Control from the Setup menu and press **ENTER**. Enter the default Personal Identification Number (PIN) -- **0000** -- and press **ENTER** again.

- **Parental Lock:** This is the “master switch” for the parental controls. Set it to On or Off.
- **TV Rating:** Select TV Rating from the Parental Control menu to block television programs carrying a given rating, to prevent children from watching programs that are deemed inappropriate. These ratings and content labels have been established by the United States Federal Communications Commission (FCC) to help parents and other caregivers determine if a program is suitable for young viewers.

To block programs carrying a given rating, use the up- or down-arrow to select a rating. Then, press the right-arrow button to require the PIN code to be entered to view a program with that rating. A lock icon (🔒) appears to indicate that the restriction is active.

Table 4-2 describes the TV ratings and content categories. For more information, visit http://www.fcc.gov/parents/parent_guide.html.

Table 4-2. FCC Ratings and Content Categories

Rating/Category	Description
TV-MA	Mature Audience Only - graphic violence, explicit sexual content and/or offensive language.
TV-14	Parents strongly cautioned - intense violence, sexual situations, coarse language and/or suggestive dialogue.
TV-PG	Parental guidance suggested - violence, sexual situations, coarse language and/or suggestive dialogue.
TV-G	General audience - suitable for children and adults.
TV-Y7	Children 7 and up.
TV-Y	Suitable for all children.
FV	Fantasy violence or cartoon violence
D	Sexual dialogue
L	Offensive language
S	Sexual content
V	Violence

- **Movie Rating:** Select Movie Rating from the Parental Control menu to block movies carrying a given rating, to prevent children from watching movies that are deemed inappropriate. These ratings have been established by the Motion Picture Association of America (MPAA) to help parents and other caregivers determine if a movie is suitable for young viewers.

To block movies carrying a given rating, press the right-arrow button to require the PIN code to be entered to view a movie with that rating. A lock icon (🔒) appears to indicate that the restriction is active.

For more information on movie ratings, please visit <http://www.mpa.org/movieratings/>.

- **Unrated:** To allow or block access to unrated content, select Unrated from the Parental Control menu and select Allow or Block. Press **ENTER** to confirm your choice.
- **Change PIN:** The default PIN for accessing the parental controls or bypassing content restrictions is **0000**. Vidikron recommends changing this to something less obvious.

Letterbox Mode: Select Letterbox Mode from the Setup menu to change the appearance of movies in Letterbox format.

When you select Standard, the original Letterbox format of the source is maintained. Black bars appear above and below the active image area.

When you select Cinema Fill, a 2.35 image is stretched vertically in both directions to fill a 16:9 display.

Input Selection: Input 1 and Input 2 have both S-Video and composite video connectors. Input 3 and Input 4 have both component and composite video connectors.

To specify which connection type you are using -- or to switch from one to the other if equipment is connected to both -- select Input Selection from the Setup menu and press **ENTER**.

Monitor Out: If you have equipment connected to the MONITOR OUT, select Monitor Out from the Setup menu to route either the main or PIP audio/video signals to that output.

Overscan (not available for RGB input): Overscan pushes the outside edge of the active picture area of the video signal out beyond the edge of the display area.

Some television programs are produced based on the assumption that older television sets may not display the outer edges of the broadcast picture area. Over scan effectively trims away these inactive, outer edges and enlarges the remaining portion of the image to fill the display area.

Use the on-screen slidebars to set the desired amount of horizontal and vertical overscan, as well as horizontal and vertical image shift.

These settings only affect 480i source material. For HDTV, DVDs and other video sources, Overscan is generally not necessary or desirable.

Use the ISF Calibration menu to perform advanced picture quality adjustments. **This menu should be used by ISF-certified technicians only.**



Note

You must enter a passcode to access the ISF Calibration menu.

Picture Adjust: The controls in this menu are identical to those in the main Picture Adjust menu, but are accessible only by entering the ISF Calibration menu passcode. This makes it possible to restore the picture quality settings to what they were when the DView was installed, simply by recalling the "ISF Night" or "ISF Day" preset.

- **Brightness:** Refer to **Brightness** on page 29.
- **Contrast:** Refer to **Contrast** on page 30.
- **Color:** Refer to **Color Saturation** on page 30.
- **Tint:** Refer to **Tint** on page 31.
- **Sharpness:** Refer to **Sharpness** on page 32.
- **Color Temp.** Refer to **Color Temperature** on page 32.
- **Backlight:** Refer to **Backlight** on page 32.

◀ ISF Calibration

ISF Calibration
Picture Adjust
White Balance
Blue Enable
DNR
Gamma
Baud Rate
Command Ack
Factory Reset
Splash Duration

- **Save Settings:** For each input and supported resolution, the DView lets you save image quality settings as presets that you can recall at a later time. You can create up to three presets -- designated "Custom," "ISF Day" and "ISF Night" -- per input and resolution.

You should save changes to any of the following settings to a preset; otherwise they will be lost when a new input source or resolution is selected:

- Aspect ratio
- Brightness
- Contrast
- Color saturation
- Tint
- Sharpness
- Gamma
- Color temperature and white balance

To save image settings to a preset, select Save Settings from the ISF Calibration menu and select "Custom," "ISF Day" or "ISF Night."

White Balance		
R Gain		100
G Gain		100
B Gain		100
R Offset		50
G Offset		50
B Offset		50

White Balance: To remove any trace of color from the white areas of the projected image, choose White Balance from the Picture Adjust menu and press **ENTER**.

- **Gain:** Use the Gain controls to correct color imbalances in the bright areas of the image. A good way to do this is to use a test pattern consisting mostly of solid white areas, such as an 80 IRE "window" pattern. If the white areas contain traces of red, green or blue, decrease the Gain for that color.
- **Offset:** Use the Offset controls in the White Balance sub-menu to correct color imbalances in the dark areas of the image. A good way to do this is to use a test pattern consisting mostly of dark gray areas, such as a 30 IRE "window" pattern. If the gray areas contain traces of red, green or blue, decrease the Offset for that color.



Note

Any white balance adjustments you make here are automatically stored as a "Custom" color temperature.

Blue Enable: Blue Enable removes all red and green color information from the image, simulating a blue filter. You can use it instead of a blue filter when performing color and tint adjustments.

DNR: To apply Digital Noise Reduction (DNR) to the input signal, select DNR from the ISF Calibration menu. Noise reduction is useful for clearing up noisy RGB images such as those from a PC. Adjust as desired using the left- or right-arrow buttons, keeping in mind that reducing noise (which reduces high frequencies) may also "soften" the image.

Gamma: The Gamma control determines how gray shades are displayed between minimum input (black) and maximum input (white) for all signals. A good gamma setting helps to optimize blacks and whites while ensuring smooth transitions for the "in-between" values utilized in other grays.

Unlike brightness and contrast controls, Gamma allows you to lighten or darken the overall tone of your images without changing the extremes. All images will be more vibrant while still showing good detail in dark areas.

The default Gamma setting of 2.2 is appropriate for most typical home theater environments.

Baud Rate: Select Baud Rate from the ISF Calibration menu to set the data transfer rate of the DView's RS-232 SERVICE port. (This setting must match the data rate of the device connected to the RS-232 input.)

Command Ack: The Command Ack setting enables or disables the echo of serial commands at the source. When set to on, commands sent from the serial controller (PC or control/automation system) are logged and/or displayed on-screen. If this is not desired, set Command Ack to Off.

Factory Reset: To reset all DView settings to their factory defaults, select Factory Reset from the ISF Calibration menu and press **ENTER**. **This command is not undoable. Use it with caution!**

Splash Duration: Use Splash Duration to control how long the DView splash screen remains on-screen after power-up; see Figure 4-6. To prevent this screen from appearing, set the Splash Duration to 0.



Figure 4-6. DView Splash Screen

4.5 Using Picture-In-Picture (PIP)

To use PIP, press the **PIP** () button.

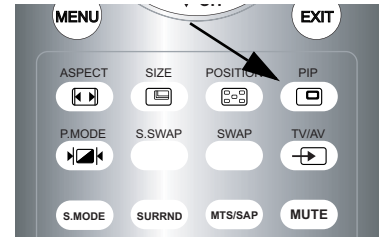

The PIP window appears inside the main image window.

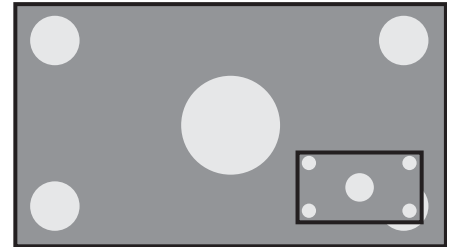

Press **PIP** again to switch to side-by-side PIP mode.

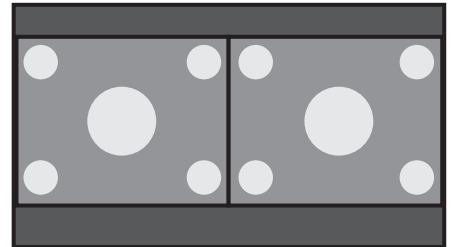

Press **PIP** again to turn PIP off.



Press the **TV/AV** button () to select a PIP signal source. For each source, Table 4-3 shows which of the other sources are available as a PIP source.

Table 4-3. Available Main and PIP Source Combinations

Main	PIP	INPUT 1	INPUT 2	INPUT3		INPUT4		PC	
				VIDEO	COMPONENT	VIDEO	COMPONENT	RGB	DVI
	INPUT1	X	O	O	O	O	O	O	O
	INPUT2	O	X	O	O	O	O	O	O
INPUT3	VIDEO	O	O	X	X	O	O	O	O
	COMPONENT	O	O	X	X	O	X	X	O
INPUT4	VIDEO	O	O	O	O	X	X	O	O
	COMPONENT	O	O	O	X	X	X	X	O
PC	RGB	O	O	O	X	O	X	X	O
	DVI	O	O	O	O	O	O	O	X

Notes:

1. "O" means that that source is available as a PIP source when that input is selected; "X" means that it is not.
2. The DView cannot display the same source in both the main and PIP windows, nor can it display RGB and component video simultaneously.

To change the PIP window position, press the **POSITION** () button on the remote control repeatedly until the window is in the desired position.

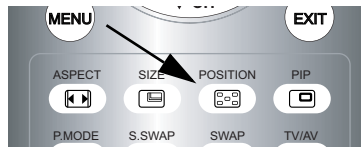

◀ **Changing the PIP Position**

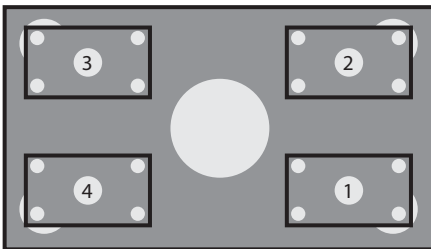

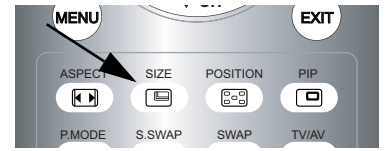
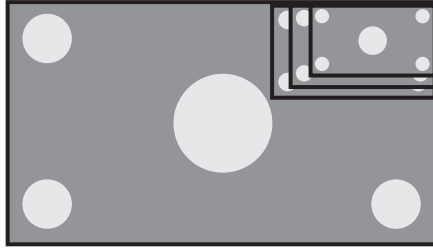

- Changing the PIP Size** ➤ To change the PIP window size, press the **SIZE** () button on the remote control repeatedly to achieve the desired window size.

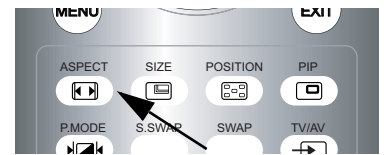

- Changing the PIP Aspect Ratio** ➤ To change the aspect ratio of the PIP window from 4:3 to 16:9 or vice versa, press the **ASPECT** () button on the remote control.

Refer to Table 4-1 for more information about aspect ratios.



- Changing the PIP Image Mode** ➤ To recall settings for the PIP input from either the "ISF Night" or "ISF Day" memory preset, press the **P.MODE** () button on the remote control.

Choose ISF Day when there is a lot of ambient light. Select ISF Night when there is low ambient light or at night.

To customize the ISF memory presets, refer to **ISF Calibration** on page 37.

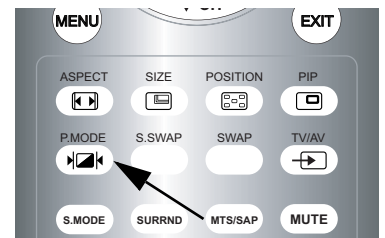

To swap the main and PIP images, press the **SWAP** button on the remote control.

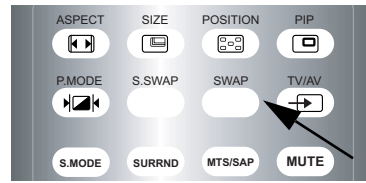

◀ **Swapping the Main and PIP Images**

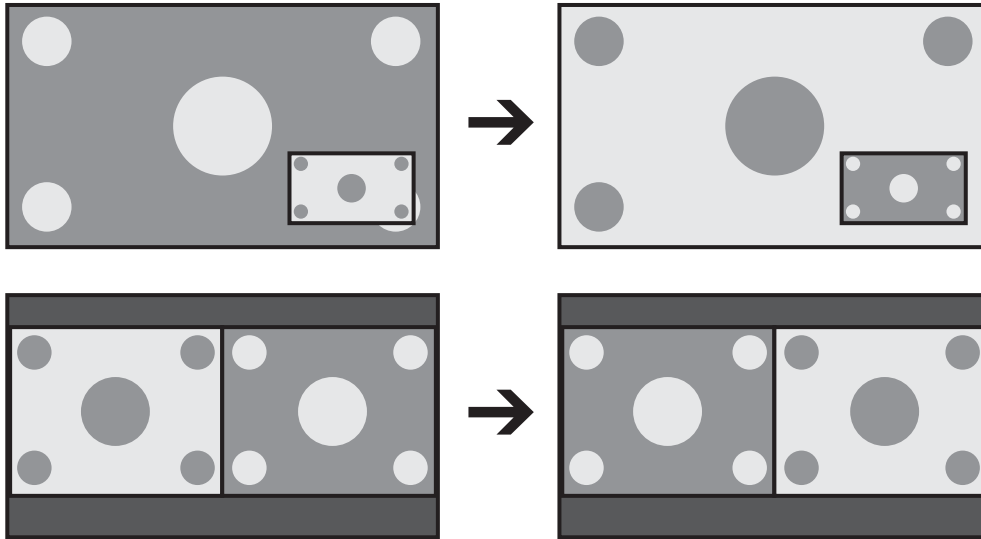

To swap the main and PIP audio programs, press the **S.SWAP** button on the remote control.

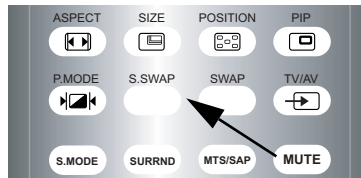

◀ **Swapping the Main and PIP Audio Programs**

4.6 Stereo Sound/SAP

The DView supports Multichannel Television Sound (MTS), the broadcast audio standard that allows transmission of both stereo and Secondary Audio Program (SAP) content.

The SAP is usually a foreign-language translation. However, it can also be used for other purposes such as Described Video Services (DVS), which provide descriptive narration of key visual elements in programs for the benefit of the visually impaired.

You can select sound options (**Mono**, **Stereo**, **SAP** or **Mono+SAP**) depending on the broadcast signal by pressing the **MTS/SAP** button on the remote control.

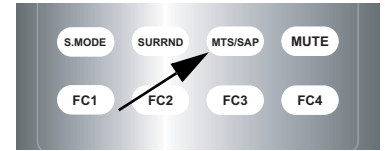

- Choose **Stereo** for channels that are broadcasting in stereo.
- Choose **Mono** for channels that are broadcasting in mono, or if you are having difficulty receiving a stereo signal.
- Choose **SAP** to listen to the Secondary Audio Program.
- Choose **Mono+SAP** to listen to both the primary and secondary audio programs (for example, when a program has a DVS audio track).

Table 4-4 summarizes the audio broadcast modes supported by the DView.

Table 4-4. Compatibility with Stereo and SAP Audio Broadcasts

Broadcast Mode	Receive Mode			
	Mono	Stereo	SAP	Mono+SAP
Mono	Mono	Mono	Mono	Mono
Stereo	Mono	Stereo	Mono	Stereo
Mono+SAP	Mono	Mono	SAP	Mono+SAP
Stereo+SAP	Mono	Stereo	SAP	Mono+SAP

Maintenance and Troubleshooting

Table 5-1 provides some general guidelines for troubleshooting problems you may encounter with the DView. If you encounter an issue not described here, please contact your Vidikron dealer or Vidikron Technical Support.

5.1 Troubleshooting Tips

Table 5-1. Troubleshooting Chart

Symptom	Possible Cause(s)	Solution
The display does not turn on after initial installation.	<ul style="list-style-type: none"> The DView is not plugged in or the AC outlet is not active. The remote control batteries have run out. 	<ul style="list-style-type: none"> Ensure that the DView is plugged in and that the AC outlet is active. Replace the batteries.
The display is on, but there is no picture or sound.	<ul style="list-style-type: none"> Incorrect source selection. Source component is not turned on. Source component is connected incorrectly or not at all. 	<ul style="list-style-type: none"> Select the correct source. Turn on the source component. Check video and/or audio connections to source component.
Picture is okay, but there is no sound.	<ul style="list-style-type: none"> Audio output is muted. Volume setting is too low. 	<ul style="list-style-type: none"> Press the MUTE button on the remote control. Turn up the volume.
Image is too bright and/or lacks definition in the bright areas of the image.	<ul style="list-style-type: none"> Contrast is set too high. 	<ul style="list-style-type: none"> Lower the contrast setting.
Image appears "washed out" and/or dark areas appear too bright.	<ul style="list-style-type: none"> Brightness is set too high. 	<ul style="list-style-type: none"> Lower the brightness setting.
Colors in the image are swapped; for example, reds appear blue or vice versa.	<ul style="list-style-type: none"> The Red/Pr, Green/Y or Blue/Pb outputs from the source are connected to the wrong inputs on the DView. 	<ul style="list-style-type: none"> Ensure that the source outputs are connected to the correct DView input.
RGB-HD images appear "noisy."	<ul style="list-style-type: none"> Clock and Phase settings need adjustment. 	<ul style="list-style-type: none"> Manually adjust Clock and Phase settings, or perform an Auto-Adjust (refer to PC Mode Adjust on page 34).
"Out of range" appears on-screen.	<ul style="list-style-type: none"> The resolution and frequency of the video card in the computer are not compatible with the DView. 	<ul style="list-style-type: none"> Select a compatible resolution and vertical frequency (refer to Computer/Video Signal Compatibility on page 53).
The image is too large or too small.	<ul style="list-style-type: none"> Image size needs adjusting. 	<ul style="list-style-type: none"> Adjust the image size (refer to PC Mode Adjust on page 34).

Notes:

Serial Communications

To interface the DView with a home theater automation/control system or a PC running terminal emulation software, connect it to your control system or PC as shown in Figure 3-7.

Configure the RS-232 controller or PC serial port as follows: no parity, 8 data bits, 1 stop bit and no flow control. Set the baud rate to match that of the DView RS-232 port; the default baud rate is 115200.

Table 6-1 lists the RS-232 command set. All commands are in ASCII format. A carriage return is not required after a command.

When you send a valid command, the DView executes it and acknowledges it with a right-bracket character (]) followed by the four-digit numeric code you sent; for example,]0002. When you send an invalid command, the DView ignores it and returns -N/A instead of the four-digit code.

Table 6-1. Serial Commands

Command					Description
[+	S3A	+	000#	Set audio volume to ### (=000-100)
<i>Example:</i> [S3A000075 sets volume to 75					
[+	+3A			Audio volume up
[+	-3A			Audio volume down
[+	S4A	+	000#	Main input selection 1=Input1 2=Input2 3=Input3 4=Input4 5=DVI 6=RGB
<i>Example:</i> [S4A0006 selects RGB					
[+	S4E	+	000#	Aspect ratio selection 0=Standard (4x3) 1=IntelliWide 2=Letterbox 3=Anamorphic
<i>Example:</i> [S4E0002 selects Letterbox					
[+	S4F	+	0101	Select Composite Video for Input1
			+	0102	Select S-Video for Input1
			+	0201	Select Composite Video for Input2
			+	0202	Select S-Video for Input2
			+	0301	Select Composite Video for Input3
			+	0303	Select Component Video for Input3

6.1 RS-232 Connection and Port Configuration

6.2 Serial Command Syntax

Table 6-1. Serial Commands (continued)

Command					Description
			+	0401	Select Composite Video for Input4
			+	0403	Select Component Video for Input4
<i>Example:</i> [S4F0101 selects Composite video for Input1					
[+	S4G	+	000#	PIP Input selection 1=Input1 2=Input2 3=Input3 4=Input4 5=DVI 6=RGB
<i>Example:</i> [S4G0004 selects Input4					
[+	SAB	+	000#	Power on/off control 0=standby, 1=on
<i>Example:</i> [SAB0001 turns unit on					
[+	SBA	+	000#	Picture mode selection 0=Custom 1=ISF Night 2=ISF Day
<i>Example:</i> [SBA0001 selects ISF Night					
[+	SCA	+	000#	Caption on/off 0=off 1=on
<i>Example:</i> [SCA0000 turns caption off					
[+	SDA	+	000#	Set PIP mode 0=OFF 1=PIP 2=PBP
<i>Example:</i> [SDA0002 selects PBP					
[+	SDB	+	000#	Set PIP size 0=small 1=medium 2=large
<i>Example:</i> [SDB0001 selects medium PIP size					

Table 6-1. Serial Commands (continued)

Command					Description
<p>The following serial commands are meant to emulate buttons on the remote control. Each button has its own serial command. Effectively, it is as if you were using the IR remote, except that you'll be doing so via serial commands. These commands provide active OSD responses just like the IR remote.</p> <p>Each command begins with [key followed by the four-digit number of the button. No carriage return is necessary. The response you receive from the unit if the command is valid will be a right-bracket (]) followed by the four-digit numeric code you sent. (For example, the 'ON' command is [key0015; the response will be])0015). All commands are in ASCII.</p>					
[+	key	+	0002	OFF
				0015	ON
[+	key	+	0004	Number 1
				0005	Number 2
				0006	Number 3
				0008	Number 4
				0009	Number 5
				0010	Number 6
				0012	Number 7
				0013	Number 8
				0014	Number 9
				0017	Number 0
				0035	Number 100
[+	key	+	0023	TIMER OFF
[+	key	+	0105	INPUT1
				0027	INPUT2
				0028	INPUT3
				0001	INPUT4
				0102	DVI
				0101	RGB HD
[+	key	+	0003	CUSTOM
				0062	ISF NIGHT
				0031	ISF DAY
[+	key	+	0040	ANAMORPHIC
				0043	4X3
				0039	LETTERBOX
				0126	INTELLIWIDE

Table 6-1. Serial Commands (continued)

Command					Description
[+	key	+	0007	Right-Arrow key
				0016	Down-Arrow key
				0018	Up-Arrow key
				0011	Left-Arrow key
				0046	ENTER
[+	key	+	0026	MENU
[+	key	+	0100	EXIT
[+	key	+	0063	ASPECT RATIO
				0047	SIZE
				0034	POSITION
				0032	PIP
				0037	P.MODE
				0052	S.SWAP
				0033	SWAP
				0036	TV/AV
[+	key	+	0053	S.MODE
				0054	SURROUND
				0024	MTS/SAP
				0091	MUTE

Specifications

Table 7-1 lists the DView specifications.

7.1 DView Specifications

Table 7-1. DView Specifications

Native Resolution:	1366 x 768 WXGA
Screen Size:	37 in. (diagonal)
Screen Aspect Ratio:	16:9
Available Aspect Ratios:	4:3, Letterbox, 16:9 Anamorphic, IntelliWide™
DTV Compatibility:	480i/p, 576i/p, 720p, 1080i
ISF Settings:	Yes
Contrast Ratio:	1000:1
Data/Graphics Compatibility:	Up to 1024 x 768
Imagix Processing:	3:2 pull down
Inputs:	Multiple input combinations with up to (4) Composite, (2) S-Video, (2) Component, (1) DVI w/HDCP, (1) RGB (15-pin D-sub), (1) RS-232, (5) Audio (stereo RCA pairs)
Outputs:	(1) Composite, (1) Audio (stereo RCA pair; output level is fixed)
Audio System:	10W RMS x 2, L/R two-way Integrated Speaker System
Discrete IR Control:	Source, power and aspect ratios
Power Requirements:	100 to 240 VAC, 50/60Hz
Power Consumption:	230W
Operating Environment:	40°F to 95°F (5°C to 35°C); 20% to 80% humidity (non-condensing)
Dimensions:	See Figure 7-1
Weight (with Stand):	68.34 lbs. (31 kg)
Regulatory Approvals:	Complies with FCC
Limited Warranty:	One (1) year parts and labor from the date of delivery to the end user.
Specifications are subject to change without notice.	

7.2 DView Dimensions

Figure 7-1 shows the DView dimensions.

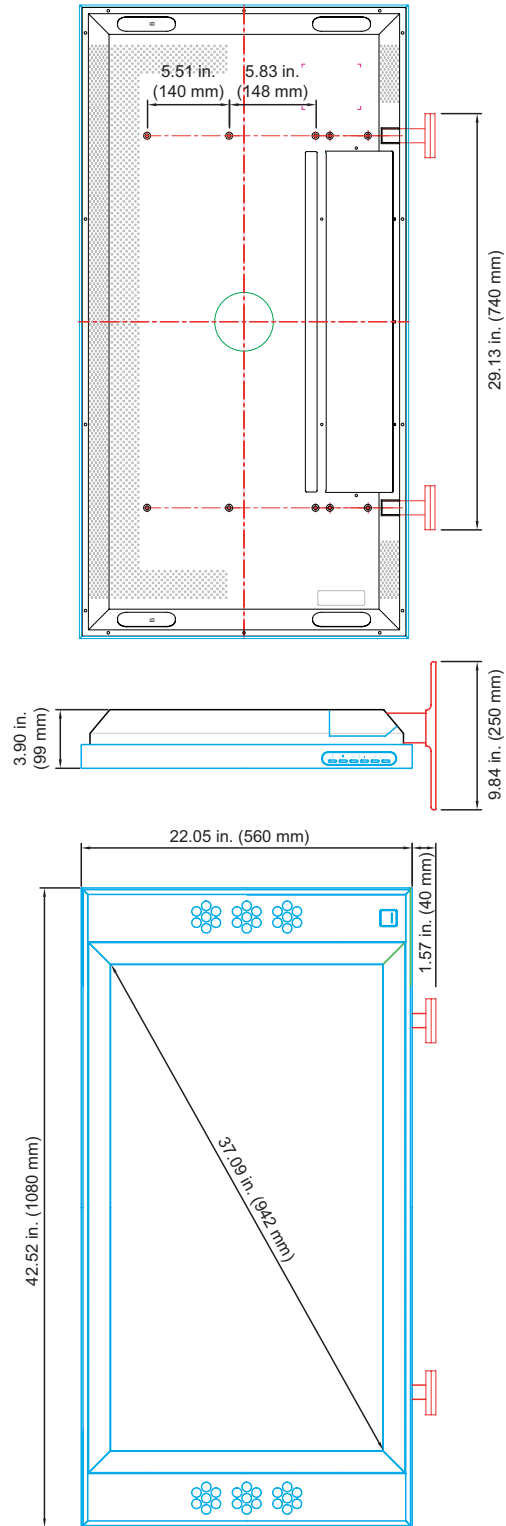

Figure 7-1. DView Dimensions

The DView can display video signals from a variety of computer sources via its RGB-HD and DVI inputs.

Table 7-2 lists the signal types that are compatible with the DView, and indicates which of those are VESA standards.

Table 7-2. Computer/Video Signal Compatibility Chart

Signal Type	Mode		Vertical Frequency (Hz)	Horizontal Frequency (kHz)
SD	720x240	60i	59.94	15.75
SD	720x480	60p	59.94	31.50
HD	1280x720	60p	60.00	44.90
HD	1920x1080	60i	60.00	33.70
VESA	720x400	85	85.00	37.90
VESA	720x350	85	85.00	37.90
IBM	720x400	70	70.10	31.50
IBM	720x350	70	70.10	31.50
VESA	720x480	60	59.94	31.50
MAC	720x480	67	66.70	35.00
VESA	720x480	72	72.80	37.80
VESA	720x480	75	75.00	37.50
VESA	720x480	85	85.00	43.60
VESA	800x600	56	56.25	35.20
VESA	800x600	60	60.30	37.90
VESA	800x600	72	72.20	48.70
VESA	800x600	75	75.00	46.90
VESA	800x600	85	85.10	53.70
MAC	832x624	75	74.50	49.70
VESA	1024x768	60	60.00	48.40
MAC	1024x768	60	60.00	48.70
VESA	1024x768	70	70.10	56.50
IBM	1024x768	72	72.10	57.50
VESA	1024x768	75	75.00	60.00
MAC	1024x768	75	75.00	60.00
VESA	1024x768	85	85.00	68.70

Note: The DView may not be able to display images from notebook computers in simultaneous (CRT/LCD) mode. Should this occur, switch the notebook computer to "CRT only" mode. If you are unsure how to do this, refer to your notebook computer's user manual.

7.3 Computer/Video Signal Compatibility

Notes:

RUMA-011165
rev.01-25-06 v1.2



Vidikron
2900 Faber Street
Union City, CA 94587
510-324-5900
Fax 510-324-5905
1-888-4-VIDIKRON
www.vidikron.com



SERIAL NUMBER

