

Introduction

Main features of the AV receiver [1]

Parts and Controls

Receiver

- Front panel (upper section) [2]
- Front panel (lower section) [3]
- Power indicator [4]
- Indicators on the display panel [5]
- Rear panel [6]

Remote control

- Remote control (upper section) [7]
- Remote control (lower section) [8]

Preparation

1. Installing speakers

- Names and functions of speakers [9]
- Installing 5.1-channel speaker system [10]
- Installing 7.1-channel speaker system using surround back speakers [11]
- Installing 5.1.2-channel speaker system using top middle speakers [12]
- Installing 5.1.2-channel speaker system using front Dolby Atmos enabled speakers [13]
- Installing 5.1-channel speaker system with Zone 2 connection [14]
- Installing 5.1-channel speaker system with bi-amplifier connection [15]
- Installing 5.1-channel speaker system with front B speaker connection [16]
- Installing 2.1-channel speaker system to enjoy the Front Surround mode [17]
- Speaker configuration and speaker pattern settings [18]

2. Connecting speakers

- Connecting 5.1-channel speaker system [19]
- Connecting 7.1-channel speaker system using surround back speakers [20]
- Connecting 5.1.2-channel speaker system using top middle speakers [21]
- Connecting 5.1.2-channel speaker system using front Dolby Atmos enabled

[speakers \[22\]](#)

- [Connecting 5.1-channel speaker system with Zone 2 connection \[23\]](#)
- [Connecting 5.1-channel speaker system with bi-amplifier connection \[24\]](#)
- [Connecting 5.1-channel speaker system with front B speaker connection \[25\]](#)
- [Connecting 2.1-channel speaker system to enjoy the Front Surround mode \[26\]](#)

3. Connecting a TV

- [Connecting a TV \[27\]](#)
- [Connecting a 4K TV \[28\]](#)
- [About input/output of video signals \[29\]](#)
- [Notes on connecting cables \[30\]](#)
- [About HDMI connections \[31\]](#)

4. Connecting audio-visual devices and the antennas (aerials)

- [Connecting devices with HDMI jacks \[32\]](#)
- [Connecting devices with jacks other than HDMI jacks \[33\]](#)
- [About input/output of video signals \[34\]](#)
- [Connecting a USB device \[35\]](#)
- [Connecting the antenna \(aerial\) \[36\]](#)
- [Connecting another amplifier in Zone 2 \[37\]](#)
- [Connecting another amplifier or TV in the HDMI zone \[38\]](#)
- [Digital audio formats supported by the receiver \[39\]](#)
- [Notes on connecting cables \[40\]](#)
- [About HDMI connections \[41\]](#)

5. Connecting to the network

- [Connecting the receiver to the network using a LAN cable \(for wired LAN connections only\) \[42\]](#)
- [Connecting the receiver to the network using the wireless LAN antenna \(for wireless LAN connections only\) \[43\]](#)

6. Turning on the receiver/preparing the remote control

- [Inserting batteries into the remote control \[44\]](#)
- [Turning on the receiver \[45\]](#)

7. Setting up the receiver using Easy Setup

- [Setting up the receiver using Easy Setup \[46\]](#)

Performing Auto Calibration

- [1. About Auto Calibration \[47\]](#)

- [2. Before you perform Auto Calibration \[48\]](#)
- [3. Connecting the calibration microphone \[49\]](#)
- [4. Selecting the front speakers \[50\]](#)
- [5. Performing Auto Calibration \[51\]](#)
- [6. Checking Auto Calibration results \[52\]](#)

Enjoying Video and Sound

Playing AV devices

- [Enjoying video and sound \[53\]](#)
- [Using the menu on the TV screen \[54\]](#)
- [Enjoying video/sound from the connected device \[55\]](#)
- [Enjoying sound of a TV compatible with the Audio Return Channel \(ARC\) function \[56\]](#)
- [Watching HDCP 2.2 copyright-protected content \[57\]](#)

Playing content from an iPhone/iPad/iPod

- [Enjoying audio content from iTunes or an iPhone/iPad/iPod via the network \(AirPlay\) \[58\]](#)
- [Enjoying audio content using the BLUETOOTH function \(Pairing operation\) \[59\]](#)
- [Compatible iPhone/iPad/iPod models \[60\]](#)

Playing content from a USB device

- [Enjoying music stored on a USB device \[61\]](#)
- [USB specifications and compatible USB devices \[62\]](#)
- [Notes on USB devices \[63\]](#)

Listening to the radio

- [Listening to FM radio \[64\]](#)
- [Presetting FM radio stations \(Preset Memory\) \[65\]](#)
- [Naming preset stations \(Preset Name Input\) \[66\]](#)
- [Tuning to a station directly \(Direct Tuning\) \[67\]](#)
- [Receiving RDS broadcasts \(for European and Asia-Pacific models only\) \[68\]](#)

Enjoying content stored on a server on the home network (DLNA) [69]

Enjoying internet music services

- [Enjoying music services offered on the Internet \[70\]](#)

Using Chromecast built-in™ to enjoy audio content from a smartphone or tablet device [71]

Using Spotify Connect to enjoy music [72]

Enjoying audio content stored on a BLUETOOTH device with a one-touch connection (NFC) [73]

Enjoying sound effects

- [Selecting a sound field \(Sound Field\) \[74\]](#)
- [Selectable sound fields and their effects \[75\]](#)
- [Relations between sound fields and speaker outputs \[76\]](#)
- [Resetting sound fields to the default settings \[77\]](#)
- [Adjusting the equalizer \(Equalizer\) \[78\]](#)
- [Enjoying clear and dynamic sound at a low volume \(Sound Optimizer\) \[79\]](#)
- [Enjoying more natural sound with speakers installed in the ceiling \(In-Ceiling Speaker Mode\) \[80\]](#)
- [Enjoying high-fidelity sound \(Pure Direct\) \[81\]](#)
- [Using the DTS:X Dialog Control function \[82\]](#)

Using Network Features

What you can do with network features [83]

Setting up a wired LAN connection (for wired LAN connections only)

- [Connecting the receiver to the network using a LAN cable \(for wired LAN connections only\) \[84\]](#)
- [Setting up a wired LAN connection \[85\]](#)

Setting up a wireless LAN connection (for wireless LAN connections only)

- [Connecting the receiver to the network using the wireless LAN antenna \(for wireless LAN connections only\) \[86\]](#)
- [Setting up a wireless LAN connection \[87\]](#)

Enjoying content stored on a server on the home network (DLNA)

- [Enjoying content stored on a server on the home network \(DLNA\) \[88\]](#)
- [Deleting a server from the server list \[89\]](#)
- [Setting whether to control this receiver from a controller device on the home network \(Home Network Access Control\) \[90\]](#)
- [About DLNA \[91\]](#)

Enjoying audio content from iTunes or an iPhone/iPad/iPod via the network (AirPlay)

- [Compatible iPhone/iPad/iPod models \[92\]](#)
- [Enjoying audio content from iTunes or an iPhone/iPad/iPod via the network \(AirPlay\) \[93\]](#)

Enjoying internet music services

- [Enjoying music services offered on the Internet \[94\]](#)

Using SongPal to control the receiver from a smartphone or tablet device

- [Controlling the receiver using a smartphone or tablet device \(SongPal\) \[95\]](#)
- [Listening to the same music on multiple devices/Listening to different music in a different location \(SongPal Link\) \[96\]](#)

Listening to music by connecting the SongPal Link-compatible device

- [Listening to the same music in different rooms \(Wireless Multi-Room\) \[97\]](#)

Using Video & TV SideView to control the receiver from a smartphone or tablet device

- [Registering Video & TV SideView device to the receiver \[98\]](#)
- [Checking the registered Video & TV SideView device \(Registered Remote Devices\) \[99\]](#)
- [Deleting Video & TV SideView device from device list \[100\]](#)

Using Chromecast built-in™ to enjoy audio content from a smartphone or tablet device [101]

Using Spotify Connect to enjoy music [102]

Setting whether to control this receiver from a device on the home network

- [Setting whether to control this receiver from a controller device on the home network \(Home Network Access Control\) \[103\]](#)
- [Enabling automatic access from a newly detected controller device \(Auto Home Network Access Permission\) \[104\]](#)
- [Deleting devices from the device list in Home Network Access Control \[105\]](#)

Using BLUETOOTH Features

What you can do with BLUETOOTH features [106]

Enjoying audio content stored on a BLUETOOTH device

- [Enjoying audio content stored on a BLUETOOTH device with a one-touch connection \(NFC\) \[107\]](#)
- [Enjoying audio content using the BLUETOOTH function \(Pairing operation\) \[108\]](#)
- [Controlling a BLUETOOTH device using the remote control \[109\]](#)
- [Compatible BLUETOOTH version and profiles \[110\]](#)

Listening with BLUETOOTH receiver (headphones/speakers)

- [Listening with BLUETOOTH headphones/speakers \(Pairing operation\) \[111\]](#)
- [Compatible BLUETOOTH version and profiles \[112\]](#)

Using SongPal to control the receiver from a smartphone or tablet device

- [Controlling the receiver using a smartphone or tablet device \(SongPal\) \[113\]](#)
- [Listening to the same music on multiple devices/Listening to different music in a different location \(SongPal Link\) \[114\]](#)

Using the Multi-Zone Features

Overview of multi-zone features

- [What you can do with multi-zone features \[115\]](#)
- [Available inputs for each zone \[116\]](#)

Enjoying sound from speakers located in another room (Zone 2)

- [Connecting 5.1-channel speaker system with Zone 2 connection \[117\]](#)
- [Setting the priority on the surround back speakers or Zone 2 speakers \(SURROUND BACK/ZONE2 Priority\) \(for USA and Canadian models only\) \[118\]](#)
- [Configuring speakers installed in Zone 2 \(for European and Asia-Pacific models only\) \[119\]](#)
- [Enjoying sound in Zone 2 \[120\]](#)

Enjoying sound in two rooms using another amplifier

- [Connecting another amplifier in Zone 2 \[121\]](#)
- [Setting the volume control for Zone 2 \(Zone2 Line Out\) \[122\]](#)
- [Enjoying sound using another amplifier in Zone 2 \[123\]](#)

Enjoying video and sound in another room using a TV or another receiver

- [Connecting another amplifier or TV in the HDMI zone \[124\]](#)
- [Selecting the method to use the HDMI OUT B jack \(HDMI Out B Mode\) \[125\]](#)
- [Setting the priority for the main zone \(Priority\) \[126\]](#)
- [Enjoying video and sound in another location by connecting another amplifier or TV using HDMI connections \(HDMI zone\) \[127\]](#)

Using Other Features

Interlocking with BRAVIA TV and other devices (“BRAVIA” Sync)

- [What is “BRAVIA” Sync? \[128\]](#)
- [Preparing to use “BRAVIA” Sync function \[129\]](#)
- [Turning off the receiver and connected devices simultaneously with the TV \(System Power Off function\) \(Standby Linked to TV\) \[130\]](#)
- [Enjoying TV sound from the speakers connected to the receiver \(System Audio Control function\) \[131\]](#)
- [Enjoying an input source from a connected device immediately \(One-Touch Play](#)

[function](#) [132]

- [Selecting the optimum picture quality and sound field automatically \(Scene Select function\)](#) [133]
- [About Home Theatre Control function](#) [134]
- [Operating the receiver menu using the TV remote control \(Remote Easy Control function\)](#) [135]
- [Echo Canceling function](#) [136]
- [About Language Follow function](#) [137]

Enjoying video and sound with your desired way of use

- [Switching the TVs that output the HDMI video signals](#) [138]
- [Switching between digital and analog audio \(Input Mode\)](#) [139]
- [Using other audio input jacks \(Input Assign\)](#) [140]

Saving and recalling various settings for the receiver (Custom Preset)

- [About Custom Preset](#) [141]
- [Saving the settings to a preset](#) [142]
- [Recalling the preset settings](#) [143]
- [Items for which you can save settings and the default values for each item](#) [144]

Using the sleep timer (Sleep) [145]

Saving power during standby mode [146]

Viewing information on the display panel [147]

Adjusting Settings

Easy Setup

- [Setting up the receiver using Easy Setup](#) [148]

Performing Auto Calibration

- [1. About Auto Calibration](#) [149]
- [2. Before you perform Auto Calibration](#) [150]
- [3. Connecting the calibration microphone](#) [151]
- [4. Selecting the front speakers](#) [152]
- [5. Performing Auto Calibration](#) [153]
- [6. Checking Auto Calibration results](#) [154]

Speaker Settings

- [Calibrating the phase characteristics of the speakers \(A.P.M. \(Automatic Phase Matching\)\)](#) [155]
- [Selecting the Auto Calibration type \(Calibration Type\)](#) [156]

- [Outputting a test tone from each speaker \(Test Tone\) \[157\]](#)
- [Adjusting the speaker level \(Level\) \[158\]](#)
- [Adjusting the equalizer \(Equalizer\) \[159\]](#)
- [Adjusting the speaker distance \(Distance\) \[160\]](#)
- [Adjusting the speaker size \(Size\) \[161\]](#)
- [Setting the crossover frequency of the speakers \(Crossover Frequency\) \[162\]](#)
- [Assigning the surround back speaker terminals \(Surround Back Speaker Assign\) \[163\]](#)
- [Selecting the speaker pattern \(Speaker Pattern\) \[164\]](#)
- [Checking the speaker position and the corresponding speaker terminals \(Speaker Connection Guide\) \[165\]](#)
- [Setting the priority on the surround back speakers or Zone 2 speakers \(SURROUND BACK/ZONE2 Priority\) \(for USA and Canadian models only\) \[166\]](#)
- [Lifting up the sound of the center speaker \(Center Speaker Lift Up\) \[167\]](#)
- [Setting the correct angles of the surround speakers \(Surround Speaker Position\) \[168\]](#)
- [Calibrating speaker positioning \(Speaker Relocation/Phantom Surround Back\) \[169\]](#)
- [Setting the height from the floor to the ceiling \(Ceiling Height\) \[170\]](#)
- [Selecting the unit of measurement \(Distance Unit\) \[171\]](#)

Audio Settings

- [Playing audio signals with high-quality sound \(Digital Legato Linear \(D.L.L.\)\) \[172\]](#)
- [Enjoying clear and dynamic sound at a low volume \(Sound Optimizer\) \[173\]](#)
- [Selecting a sound field \(Sound Field\) \[174\]](#)
- [Enjoying more natural sound with speakers installed in the ceiling \(In-Ceiling Speaker Mode\) \[175\]](#)
- [Enabling the direct playback of DSD signals \(DSD Native\) \[176\]](#)
- [Enjoying high-fidelity sound \(Pure Direct\) \[177\]](#)
- [Setting the low-pass filter for the subwoofer output \(Subwoofer Low Pass Filter\) \[178\]](#)
- [Synchronizing audio with video output \(A/V Sync\) \[179\]](#)
- [Selecting the language of digital broadcasts \(Dual Mono\) \[180\]](#)
- [Compressing the dynamic range \(Dynamic Range Compressor\) \[181\]](#)
- [Switching the mode of the DTS decoder \(Neural:X\) \[182\]](#)

HDMI Settings

- [Upscaling video signals to 4K \(HDMI In 4K Scaling\) \[183\]](#)
- [Controlling HDMI devices \(Control for HDMI\) \[184\]](#)
- [Turning off the receiver and connected devices simultaneously with the TV \(System Power Off function\) \(Standby Linked to TV\) \[185\]](#)
- [Enjoying content of a connected device without turning on the receiver \(Standby Through\) \[186\]](#)

- [Setting the HDMI audio signal output of connected devices \(Audio Out\) \[187\]](#)
- [Setting the level of the subwoofer \(Subwoofer Level\) \[188\]](#)
- [Selecting the method to use the HDMI OUT B jack \(HDMI Out B Mode\) \[189\]](#)
- [Setting the priority for the main zone \(Priority\) \[190\]](#)
- [Setting HDMI signal formats \(HDMI Signal Format\) \[191\]](#)
- [Setting the color space conversion for the video signal from HDMI jacks \(YCbCr/RGB \(HDMI\)\) \[192\]](#)

Input Settings

- [Changing the assignment and display for the input jacks \[193\]](#)
- [Changing the name for each input \(Name\) \[194\]](#)

Network Settings

- [Setting up a wired LAN connection \[195\]](#)
- [Setting up a wireless LAN connection \[196\]](#)
- [Checking the network connection status \(Network Connection Status\) \[197\]](#)
- [Checking whether the network connection has been made properly \(Network Connection Diagnostics\) \[198\]](#)
- [Displaying the connected home network server \(Connection Server Settings\) \[199\]](#)
- [Enabling automatic access from a newly detected controller device \(Auto Home Network Access Permission\) \[200\]](#)
- [Setting whether to control this receiver from a controller device on the home network \(Home Network Access Control\) \[201\]](#)
- [Checking the registered Video & TV SideView device \(Registered Remote Devices\) \[202\]](#)
- [Reducing the startup time \(Network Standby\) \(for USA, Canadian and Asia-Pacific models only\) \[203\]](#)
- [Enabling the network function even when this receiver is in standby mode \(Remote Start\) \(for USA, Canadian and Asia-Pacific models only\) \[204\]](#)
- [Turning on the control mode for maintenance \(External Control\) \[205\]](#)

Bluetooth Settings

- [Selecting the BLUETOOTH mode \(Bluetooth Mode\) \[206\]](#)
- [Checking the BLUETOOTH device list \(Device List\) \[207\]](#)
- [Setting the BLUETOOTH Standby mode \(Bluetooth Standby\) \[208\]](#)
- [Setting BLUETOOTH audio codecs \(Bluetooth Codec - AAC/Bluetooth Codec - LDAC\) \[209\]](#)
- [Setting the BLUETOOTH sound quality \(Wireless Playback Quality\) \[210\]](#)

Zone Settings

- [Setting whether or not to display \[Zone Controls\] on the home menu \(Zone Controls\) \[211\]](#)

[Setting the volume control for Zone 2 \(Zone2 Line Out\) \[212\]](#)

System Settings

- [Selecting the language \(Language\) \(for USA, Canadian, European and Australian models only\) \[213\]](#)
- [Tuning on/off the display for the volume level or sound field \(Auto Display\) \[214\]](#)
- [Setting standby mode \(Auto Standby\) \[215\]](#)
- [Switching the brightness of the display panel \(Dimmer\) \[216\]](#)
- [Using the sleep timer \(Sleep\) \[217\]](#)
- [Receiving information on newer software \(Software Update Notification\) \[218\]](#)
- [Deleting personal data \(Initialize Personal Information\) \[219\]](#)
- [Assigning a name to the receiver \(Device Name\) \[220\]](#)
- [Checking the software version and MAC address of the receiver \(System Information\) \[221\]](#)
- [Checking software license information \(Software License Information\) \[222\]](#)
- [Updating the software automatically \(Auto Update Settings\) \[223\]](#)
- [Updating the software \(Software Update\) \[224\]](#)

Using the menu on the display panel

- [Operating the receiver with the menu on the display panel \[225\]](#)
- [Viewing information on the display panel \[226\]](#)

Reverting to the factory default settings [227]

Troubleshooting

Error messages

- [PROTECTOR \[228\]](#)
- [\[Overload occurred.\] appears on the TV screen. \[229\]](#)
- [List of messages after Auto Calibration measurements \[230\]](#)

General

- [The receiver is turned off automatically. \[231\]](#)
- [Cannot find an available input when connecting several digital devices. \[232\]](#)
- [The receiver does not turn on even when the TV is turned on. \[233\]](#)
- [The receiver turns off when the TV is turned off. \[234\]](#)
- [The receiver does not turn off even when the TV is turned off. \[235\]](#)

Image

- [No image appears on the TV screen. \[236\]](#)
- [No 3D content appears on the TV screen. \[237\]](#)

- [No 4K content appears on the TV screen. \[238\]](#)
- [No image is output from the TV screen when the receiver is in standby mode. \[239\]](#)
- [The home menu does not appear on the TV screen. \[240\]](#)
- [HDR \(High Dynamic Range\) images cannot be displayed in HDR mode. \[241\]](#)
- [Display does not appear on the display panel. \[242\]](#)
- [Image does not appear on the TV screen when the receiver is not turned on. \[243\]](#)
- [When the language for the on-screen display of the TV is changed, the on-screen display language of the receiver is changed simultaneously. \[244\]](#)

Sound

- [No sound or only a very low level of sound is heard, no matter which device is selected. \[245\]](#)
- [There is severe humming or noise. \[246\]](#)
- [No sound or only a very low level of sound is heard from specific speakers. \[247\]](#)
- [There is no sound from a specific device. \[248\]](#)
- [The left and right sound is unbalanced or reversed. \[249\]](#)
- [Dolby Digital or DTS multi-channel sound is not reproduced. \[250\]](#)
- [The surround effect cannot be obtained. \[251\]](#)
- [A test tone is not output from the speakers. \[252\]](#)
- [A test tone is output from a different speaker than the speaker displayed on the TV screen. \[253\]](#)
- [No sound is output from the TV when the receiver is in standby mode. \[254\]](#)
- [No TV sound is output from the receiver. \[255\]](#)
- [Image and sound are not output from the TV when the receiver is not turned on. \[256\]](#)
- [The sound is output from both the receiver and the TV. \[257\]](#)
- [When the Wireless Multi-Room function is active, the sound lags behind the picture. \[258\]](#)

Tuner

- [The FM reception is poor. \[259\]](#)
- [The FM stereo reception is poor. \[260\]](#)
- [You cannot tune to radio stations. \[261\]](#)
- [RDS does not work \(for European and Asia-Pacific models only\). \[262\]](#)
- [The RDS information that you want does not appear \(for European and Asia-Pacific models only\). \[263\]](#)

USB devices

- [Are you using a compatible USB device? \[264\]](#)
- [When the music on the USB device is played back, there is noise, skipping, or distorted sound. \[265\]](#)

A USB device is not recognized. [266]

- Playback does not start. [267]
- A USB device cannot be connected to the USB port. [268]
- Erroneous display. [269]
- An audio file cannot be played. [270]

Network connection

- Cannot connect to the network using WPS via a wireless LAN connection. [271]
- Cannot connect to the network. [272]
- Cannot control the receiver using a SongPal device. [273]
- Cannot control the receiver using a Video & TV SideView device. [274]
- Cannot select the [Network Settings] menu. [275]

Home network

- Cannot connect to the network. [276]
- A server does not appear in the server list. (A message that indicates that the receiver cannot find the server appears on the TV screen.) [277]
- Cannot access to the server, etc., connected to the router via a wireless LAN connection. [278]
- Playback does not start, or the player does not automatically proceed to the next track or file. [279]
- The sound skips during playback. [280]
- [No playable file in this category.] appears. [281]
- Cannot play copyrighted files. [282]
- Cannot select a previously selected track. [283]
- Controller devices or applications on the home network cannot connect to the receiver. [284]
- The receiver cannot be turned on by devices on a network. [285]

AirPlay

- The receiver cannot be found from an iPhone/iPad/iPod or iTunes. [286]
- The sound skips. [287]
- The receiver cannot be operated. [288]

Music services

- Cannot connect the receiver to a service. [289]
- The sound skips. [290]

BLUETOOTH device

- Pairing cannot be done. [291]
- Cannot make a BLUETOOTH connection. [292]

- [The sound skips or fluctuates, or the connection is lost. \[293\]](#)
- [The sound of your BLUETOOTH device cannot be heard on the receiver. \[294\]](#)
- [Severe humming or noise. \[295\]](#)
- [Cannot control the receiver using a SongPal device. \[296\]](#)

“BRAVIA” Sync (Control for HDMI)

- [The Control for HDMI function does not work properly. \[297\]](#)
- [TV sound cannot be heard from the speakers connected to the receiver. \[298\]](#)

Remote control

- [The remote control does not function. \[299\]](#)

If the problem is not solved

- [Reverting to the factory default settings \[300\]](#)
- [Resetting sound fields to the default settings \[301\]](#)
- [Customer support websites \[302\]](#)

Other Information

[Trademarks \[303\]](#)

[1] Introduction

Main features of the AV receiver

Compatible with a variety of connections and high-quality audio/video formats

Compatible with wired/wireless network, BLUETOOTH®, and USB connections

- Connect a Walkman, iPod/iPhone (AirPlay), computer, NAS or USB device to the receiver to play content on those devices or transmit music to BLUETOOTH headphones/speakers.
- Music services such as Spotify and Chromecast built-in are supported.

Compatible with the latest object-based audio formats

- Dolby Atmos and DTS:X are supported.

Compatible with high-definition playback of High-Resolution Audio

- During network audio playback or content playback on a USB device, the receiver supports High-Resolution Audio content at up to 5.6 MHz in the DSD format and at up to 192 kHz/24 bits in the WAV, FLAC, and AIFF formats.
- Native playback of DSD files is also supported.

Compatible with high-definition 4K video formats (*)

- The receiver supports 4K HDR and HDCP 2.2, letting you enjoy high-definition video images.

* You need to change the setting of [HDMI Signal Format] depending on the input video signal.

Functions for an optimum surround environment

Calibrating your viewing and listening environment to bring it closer to an ideal surround space using Auto Calibration (D.C.A.C. EX (*))

- D.C.A.C. EX measures and calibrates the distance, angle, level, and frequency characteristics of the speakers using the supplied stereo calibration microphone.
- The sound is then remapped to an ideal position by simulating ideal speaker positions and angles (Speaker Relocation).

* Digital Cinema Auto Calibration EX

Calibration functions for sound fields corresponding to various speaker installation conditions

- **Phantom Surround Back:** Allows you to enjoy a surround-sound effect acoustically equivalent to that of a 7-channel speaker system, using only a 5-channel speaker system, and when using a 5.1.2-channel speaker system, it allows you to enjoy a surround-sound effect acoustically equivalent to that of a 7.1.2-channel speaker system.
- **Front Surround:** Allows you to enjoy virtual surround-sound with only two front speakers.
- **In-Ceiling Speaker Mode :** Reproduces more natural sound by lowering the position of audio output from speakers installed in the ceiling.
- **Center Speaker Lift Up :** Reproduces natural sound that feels more authentic by lifting the sound from the center speaker up to the height of the screen.

Audio technologies for high-definition music playback

Sound fields selectable by preference

You can select from a variety of sound fields according to speaker connections or input sources (2ch Stereo, Direct, A.F.D. (Auto Format Decoding), etc.).

Upscaling of existing sound sources into higher resolutions with the same quantity of information as High-Resolution Audio using DSEE HX (*)

The receiver restores signals from compressed sound sources to the region originally included in High-Resolution Audio content by up-sampling the sampling frequency and expanding the bit depth to the equivalent of a maximum of 192 kHz/24 bits, letting you enjoy CDs and lossy compressed sound sources such as MP3 files in expressive sound quality closer to the original.

* Digital Sound Enhancement Engine HX

High-definition BLUETOOTH music playback (LDAC)

LDAC allows approximately three times more data to be transmitted than with the previous BLUETOOTH A2DP-SBC (328 kbps, 44.1 kHz). The receiver supports wireless playback (transmission/reception) of high-quality sound when speakers, headphones, a Walkman, or a smartphone that supports LDAC are connected to the receiver via a BLUETOOTH connection.

Reproduction of authentic impact and realistic sense of immersion in movies (Sound Optimizer)

Sound Optimizer calibrates disparities in acoustic frequency characteristics caused by the difference in volume levels between movie production and playback, and reproduces the impact and immersive surround effect that the movie's sound engineers intended even when the movie is played back at low volume levels in a home.

Other useful functions

Compatible with “SongPal” and “SongPal Link”

SongPal is a dedicated app for operating SongPal-compatible audio devices manufactured by Sony from a smartphone or tablet device.

It lets you operate the receiver from the smartphone or tablet device and use the SongPal Link function such as the Wireless Multi-Room function, etc.

Equipped with an HDMI jack compatible with the Audio Return Channel (ARC) function

TV sound can be output from the receiver using only one HDMI cable.

Supports bi-amping of front speakers

You can enhance the sound quality of the front speakers by connecting different amplifiers to the tweeter and woofer using a bi-amplifier connection.

Support for music and video playback in different rooms

- The Wireless Multi-Room function (*) lets you listen to the same music in different rooms.
- The multi-zone features let you output audio and video signals to another room.

* You can enjoy the sound of the device that is connected to the receiver. The sound is delayed behind the picture.

[2] Parts and Controls | Receiver

Front panel (upper section)

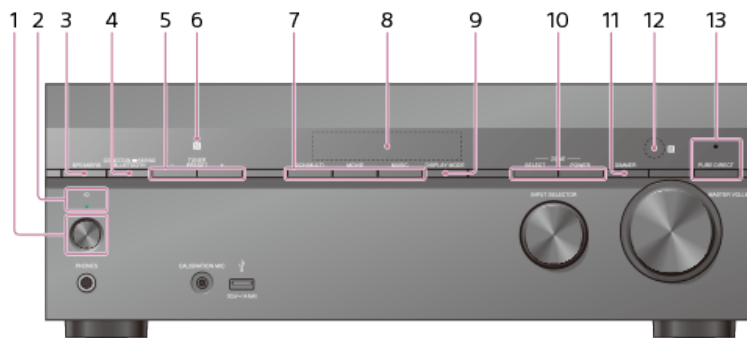

1. **⏻ (power)**
 2. **Power indicator**
 3. **SPEAKERS**
 4. **CONNECTION — PAIRING BLUETOOTH**
Operates the BLUETOOTH function.
 5. **TUNER PRESET +/-**
Select preset FM stations or channels.
 6. **NFC sensor**
 7. **2CH/MULTI, MOVIE (*), MUSIC (*)**
 8. **Display panel**
 9. **DISPLAY MODE**
Switches information on the display panel.
 10. **ZONE SELECT, ZONE POWER**
 11. **DIMMER**
Adjusts the brightness of the display panel.
 12. **Remote control sensor**
Receives signals from remote control.
 13. **PURE DIRECT**
The indicator above the button lights up when the Pure Direct function is activated.
- * The sound fields for movies and music may not work depending on the input or speaker pattern you have selected or with certain audio formats.
-

Front panel (lower section)

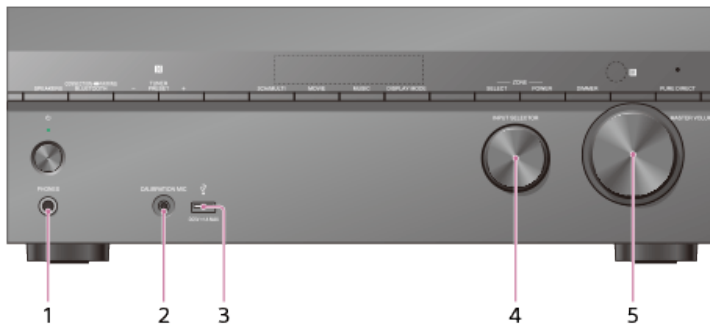

1. PHONES jack

Connect headphones here.

2. CALIBRATION MIC jack

3. USB port

4. INPUT SELECTOR

5. MASTER VOLUME

Power indicator

- Green: The receiver is turned on.
- Amber: The receiver is in standby mode, and you have set one of the following:
 - [Control for HDMI], [Bluetooth Standby] (*1), [Network Standby] (*2) or [Remote Start] (*2) is set to [On].
 - [Standby Through] is set to [On] or [Auto].
 - [Zone2 Power] or [HDMI Zone Power] is set to [On].

The indicator turns off when the receiver is in standby mode, and the following settings are set to [Off]:

- [Control for HDMI]
- [Standby Through]
- [Bluetooth Standby] (*1)
- [Network Standby] (*2)
- [Remote Start] (*2)
- [Zone2 Power] and [HDMI Zone Power]

*1 When [Bluetooth Standby] is activated, the indicator lights up in amber only if a device has been paired with the receiver. If no devices are paired with the receiver, the indicator turns off (for European model only).

*2 For USA, Canadian and Asia-Pacific models only.

Indicators on the display panel

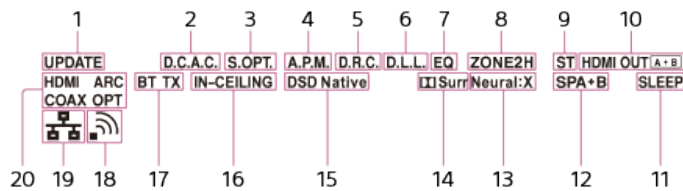

1. **UPDATE**
Lights up when new software is available.
2. **D.C.A.C.**
Lights up when the measurement results of the Auto Calibration (D.C.A.C. EX) function are applied.
3. **S.OPT**
Lights up when the Sound Optimizer function is activated.
4. **A.P.M.**
Lights up when the A.P.M. (Automatic Phase Matching) function is activated. You can only set the A.P.M. function in the D.C.A.C. (Digital Cinema Auto Calibration) function.
5. **D.R.C.**
Lights up when dynamic range compression is activated.
6. **D.L.L.**
Lights up when the D.L.L. (Digital Legato Linear) function is activated.
7. **EQ**
Lights up when the equalizer is activated.
8. **ZONE2, ZONE H**
[ZONE2] lights up when the power for Zone 2 is on. [ZONE H] lights up when the power for HDMI zone is on.
9. **ST**
Lights up when the receiver tunes to a FM stereo broadcast.
10. **HDMI OUT A + B**
Indicates the HDMI OUT jacks that currently output the audio/video signals.
11. **SLEEP**
Lights up when the sleep timer is activated.
12. **Speaker system indicator**
13. **Neural:X**
Lights up when DTS Neural:X processing is activated.
14. **□ Surr**
Lights up when Dolby Surround processing is activated.
15. **DSD Native**
Lights up when DSD native playback is performed.
16. **IN-CEILING**
Lights up when the In-Ceiling Speaker Mode is activated.
17. **BLUETOOTH indicator**
[BT] lights up when a BLUETOOTH device is connected. Flashes while connecting. [BT TX] lights up when [Bluetooth Mode] is set to [Transmitter].
18. **Wireless LAN signal strength indicator**
Lights up to show the strength of the wireless LAN signal. If the network settings for the receiver have not been configured, this indicator flashes for 30 minutes after you turn on the receiver.
 - No signal
 - ▬ Weak
 - ▬ Moderate
 - ▬ Strong
19. **Wired LAN indicator**
Lights up when the receiver is connected to a network using a wired LAN connection.
20. **Input indicator**
Lights up to indicate the current input.
 - HDMI**
Digital signals are input through the selected HDMI IN jack.
 - ARC**
TV input is selected and Audio Return Channel (ARC) signals are detected.

COAX

Digital signals are input through the COAXIAL jack.

OPT

Digital signals are input through the OPTICAL jack.

[6] Parts and Controls | Receiver

Rear panel

USA and Canadian models

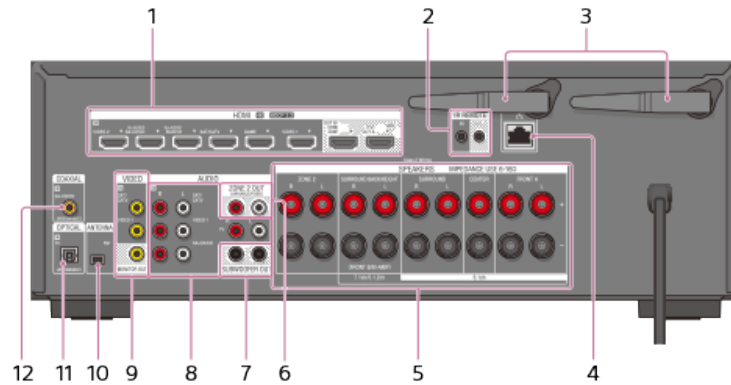

Other models

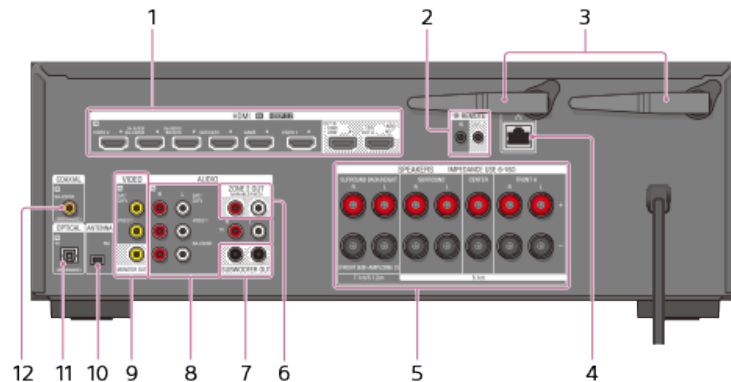

1. HDMI IN/OUT jacks (*1)(*2)

2. IR REMOTE IN/OUT jacks

- You can control the receiver from a distance by connecting an IR repeater (not supplied) to the IR REMOTE IN jack.
- You can start or stop playback of devices such as a CD player connected to the receiver by connecting an IR Blaster (not supplied) to the IR REMOTE OUT jack.

3. Wireless LAN antenna

4. LAN port

5. SPEAKERS terminals

6. ZONE 2 OUT jacks

7. SUBWOOFER OUT jacks

8. AUDIO IN jacks

9. VIDEO IN/MONITOR OUT jacks (*2)

10. FM ANTENNA terminal

11. OPTICAL IN jacks

12. COAXIAL IN jack

*1 All of the HDMI IN/OUT jacks on the receiver support HDCP 2.2. HDCP 2.2 is newly enhanced copyright protection technology that is used to protect content such as 4K movies.

*2 Connect a TV to the corresponding output jacks to watch video input from these jacks. For details, see

Remote control (upper section)

Use the supplied remote control to operate this receiver.

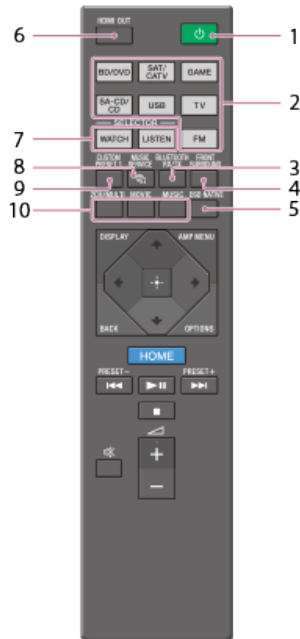

- 1.  (power)**
Turns the receiver on or sets it to the standby mode.
- 2. Input buttons**
Select the input channel connected to the device you want to use.
When you press any of the input buttons, the receiver turns on.
- 3. BLUETOOTH RX/TX**
Switches [Bluetooth Mode] to [Receiver] or [Transmitter].
In [Receiver] mode, the receiver receives and outputs audio from the player.
In [Transmitter] mode, the receiver sends audio to BLUETOOTH headphones/speakers.
- 4. FRONT SURROUND**
Activates the Front Surround mode and lets you enjoy virtual surround effects using only the two front speakers.
- 5. DSD NATIVE**
Activates the DSD Native function.
You can turn on or off this function only when playback on the source device is stopped.
- 6. HDMI OUT**
Switches the output for two TVs connected to the HDMI OUT A (TV) and HDMI OUT B/HDMI ZONE jacks. When [HDMI Out B Mode] is set to [Main] in the [HDMI Settings] menu, output is toggled between [HDMI A], [HDMI B], [HDMI A+B] and [HDMI OFF] each time the button is pressed. When [HDMI Out B Mode] is set to [Zone], output is toggled between [HDMI A] and [HDMI OFF] each time the button is pressed.
- 7. WATCH, LISTEN**
Selects [Watch] or [Listen] on the home menu directly. When pressing these buttons on the Watch or Listen screen, you can move the focus to select the desired input.
- 8. MUSIC SERVICE**
If you have been playing the music on the receiver using Spotify Connect (*1)(*2), you can resume Spotify playback by pressing MUSIC SERVICE.
- 9. CUSTOM PRESET 1**
Saves and recalls various settings for the receiver. Press to select the custom preset

setting(s). Press and hold to save the current settings to a preset.

10. 2CH/MULTI, MOVIE (*3), MUSIC (*3)

Select a sound field.

*1 Available services may vary depending on your location.

*2 Spotify playback using the receiver is limited to Spotify Premium account holders.

*3 The sound fields for movies and music may not work depending on the input or speaker pattern you have selected or with certain audio formats.

Note

- The above explanations are intended to serve as examples.
- Depending on the model of your connected device, some functions explained in this section may not work with the supplied remote control.

[8] Parts and Controls | Remote control

Remote control (lower section)

Use the supplied remote control to operate this receiver.

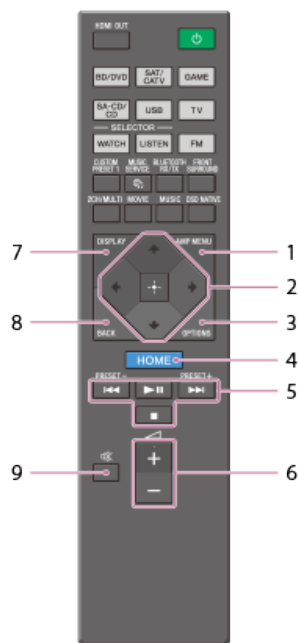

1. AMP MENU

Displays the menu on the display panel to operate the receiver.

2. ///,

Press /// to select the menu items. Then press to enter the selection.

3. OPTIONS

Display the options menus.

4. HOME

Displays the home menu on the TV screen.

5. // (*),

Skip, play, pause, stop operation.

PRESET+/-

Select preset stations or channels. Press and hold to scan stations automatically.

6. +(*)/-

Adjust the volume level of all speakers at the same time.

7. DISPLAY

Press to view information on the TV screen.

8. BACK

Returns to the previous menu or exits a menu or on-screen guide that is displayed on the TV screen.

9. 

Turns off the sound temporarily. Press the button again to restore the sound.

* The  and  buttons have tactile dots. Use the tactile dots as a reference when operating the receiver.

Note

- The above explanations are intended to serve as examples.
- Depending on the model of your connected device, some functions explained in this section may not work with the supplied remote control.

[9] Preparation | 1. Installing speakers

Names and functions of speakers

Speaker installation example

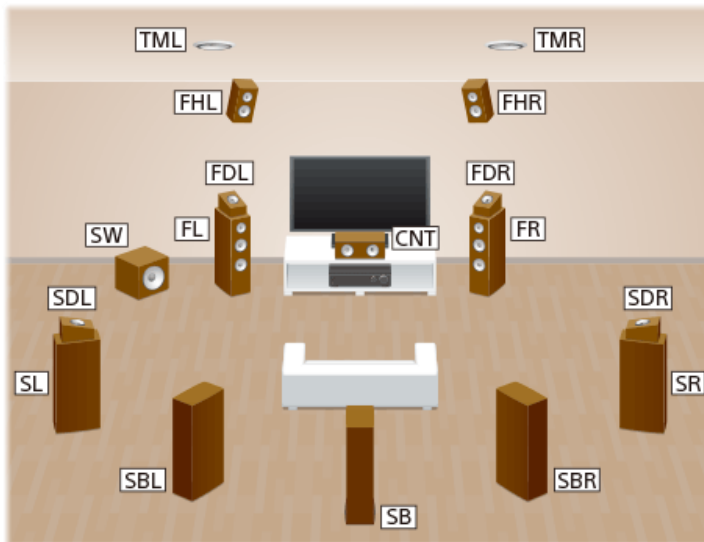

Abbreviations used in illustrations	Speaker name	Functions
FL	Front left speaker	Produces sounds from front left/right channels.
FR	Front right speaker	
CNT	Center speaker	Produces vocal sounds from center channel.
SL	Surround left speaker	Produces sounds from surround left/right channels.
SR	Surround right speaker	
SBL	Surround back left	

	speaker	Produces sounds from surround back left/right channels.
SBR	Surround back right speaker	
SB	Surround back speaker	Produces sounds from surround back channel.
SW	Subwoofer	Produces LFE (low frequency effect) channel sounds and reinforces bass parts of other channels.
FHL	Front high left speaker	Produces vertical sound effects from front high left/right channels.
FHR	Front high right speaker	
TML	Top middle left speaker	Produces sounds from top middle left/right channel.
TMR	Top middle right speaker	
FDL	Front Dolby Atmos enabled left speaker	Produces sounds from the top middle left/right channel and reflects these sounds off the ceiling. Enables playing back sounds of Dolby Atmos 3D movies without the need to install ceiling speakers.
FDR	Front Dolby Atmos enabled right speaker	
SDL	Surround Dolby Atmos enabled left speaker	Produces sounds from the top middle left/right channel and reflects these sounds off the ceiling. Enables playing back sounds of Dolby Atmos 3D movies without the need to install ceiling speakers.
SDR	Surround Dolby Atmos enabled right speaker	
Z2L	Zone 2 left speaker	Outputs sounds to another location ("Zone 2"). For details on Zone 2, see "Installing 5.1-channel speaker system with Zone 2 connection."
Z2R	Zone 2 right speaker	

To fully enjoy theater-like multi-channel surround sound, you need five speakers (two front speakers, a center speaker, and two surround speakers) and a subwoofer.

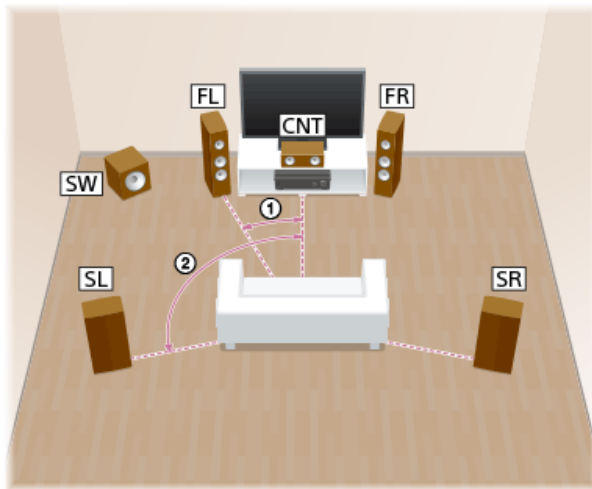

- ① 30°
- ② 100° - 120°

Hint

- As the subwoofer does not emit highly directional signals, you can place it wherever you want.

[11] Preparation | 1. Installing speakers

Installing 7.1-channel speaker system using surround back speakers

You can enjoy high-fidelity reproduction of recorded sound from DVD or Blu-ray Disc software in 6.1-channel or 7.1-channel format.

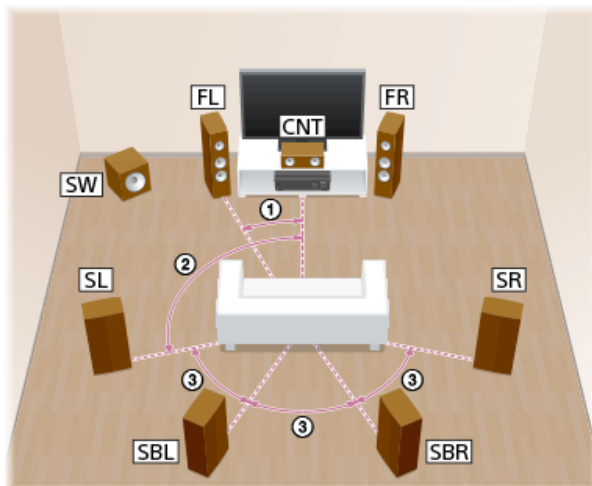

- ① 30°
- ② 100° - 120°
- ③ Same angle

Note

- When you use a 6.1-channel connection, place a surround back speaker directly behind the listening position.

Hint

- As the subwoofer does not emit highly directional signals, you can place it wherever you want.

[12] Preparation | 1. Installing speakers

Installing 5.1.2-channel speaker system using top middle speakers

You can enjoy vertical sound effects by connecting additional two top middle speakers.

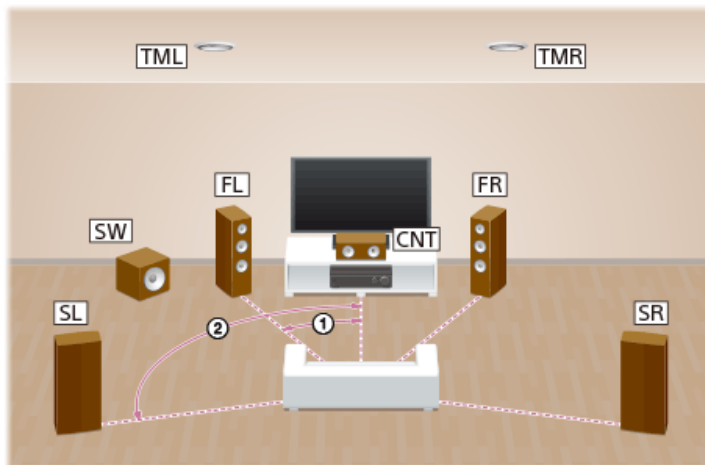

① 30°

② 100° - 120°

Hint

- As the subwoofer does not emit highly directional signals, you can place it wherever you want.

[13] Preparation | 1. Installing speakers

Installing 5.1.2-channel speaker system using front Dolby Atmos enabled speakers

You can enjoy vertical sound effects by connecting additional two front Dolby Atmos enabled speakers.

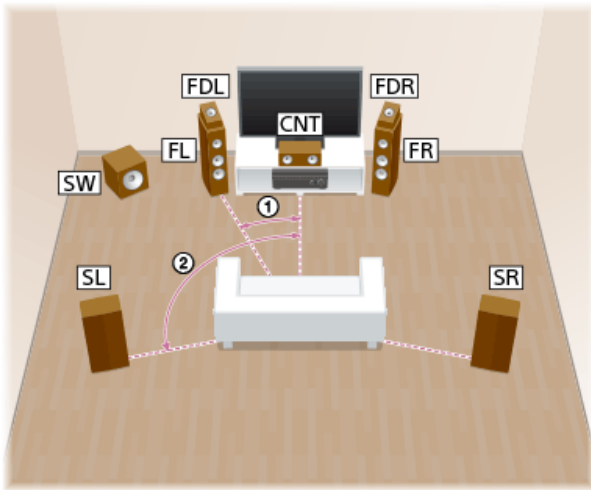

- ① 30°
- ② 100° - 120°

Hint

- As the subwoofer does not emit highly directional signals, you can place it wherever you want.

[14] Preparation | 1. Installing speakers

Installing 5.1-channel speaker system with Zone 2 connection

To fully enjoy theater-like multi-channel surround sound, you need five speakers (two front speakers, a center speaker, and two surround speakers) and a subwoofer. You can also enjoy the audio in another location (“Zone 2”) by connecting additional Zone 2 speakers. For example, it is possible to listen to music received from music services in Zone 2 while enjoying a DVD in the main zone.

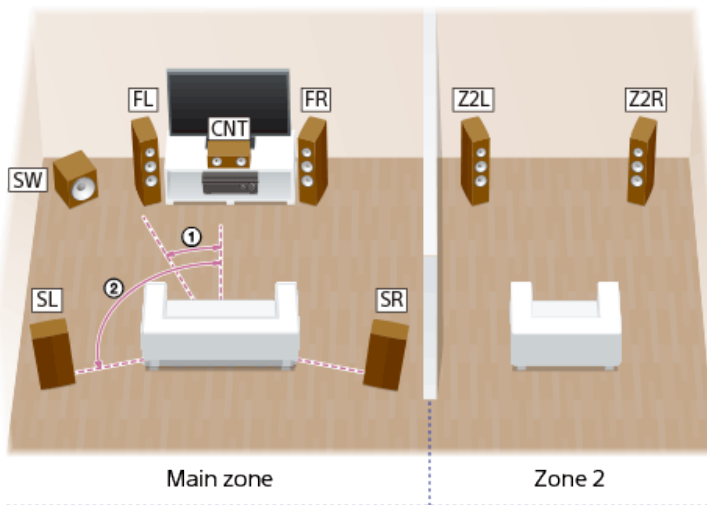

- ① 30°
- ② 100-120°

Hint

- As the subwoofer does not emit highly directional signals, you can place it wherever you want.

[15] Preparation | 1. Installing speakers

Installing 5.1-channel speaker system with bi-amplifier connection

You can enhance the sound quality of the front speakers by separately connecting the built-in amplifiers to tweeters and woofers in a bi-amplifier configuration.

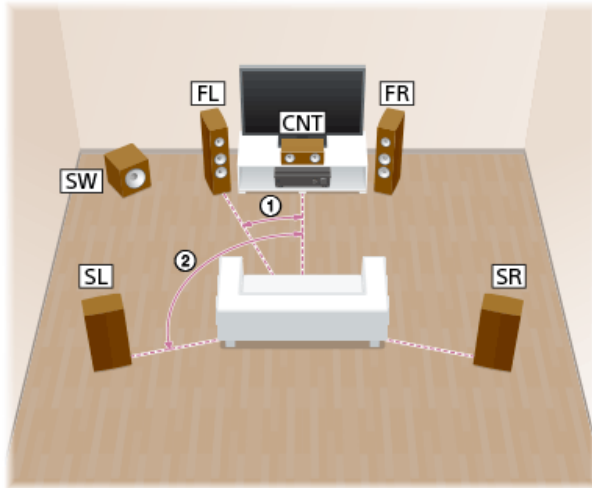

① 30°

② 100° - 120°

Hint

- As the subwoofer does not emit highly directional signals, you can place it wherever you want.

[16] Preparation | 1. Installing speakers

Installing 5.1-channel speaker system with front B speaker connection

If you have an additional front speaker system, connect it to SPEAKERS SURROUND BACK/HEIGHT terminals.

You can output sound from either front A speakers or front B speakers, or both front A speakers and front B speakers.

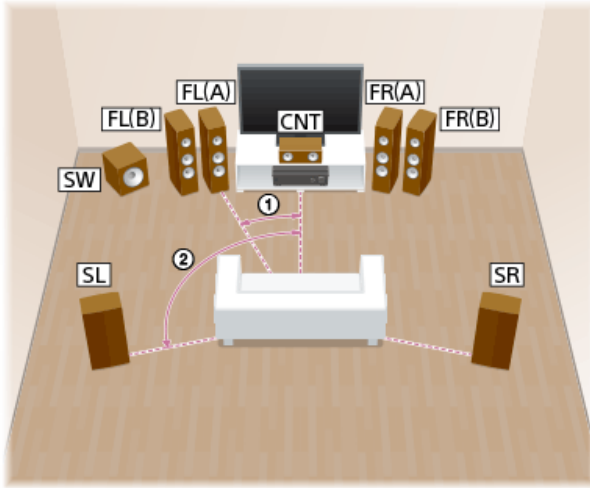

- ① 30°
- ② 100° - 120°

Hint

- As the subwoofer does not emit highly directional signals, you can place it wherever you want.

[17] Preparation | 1. Installing speakers

Installing 2.1-channel speaker system to enjoy the Front Surround mode

If you select [Front Surround] for the sound field setting, you can enjoy virtual surround effects using only two front speakers.

Place speakers as shown below to enjoy Front Surround mode.

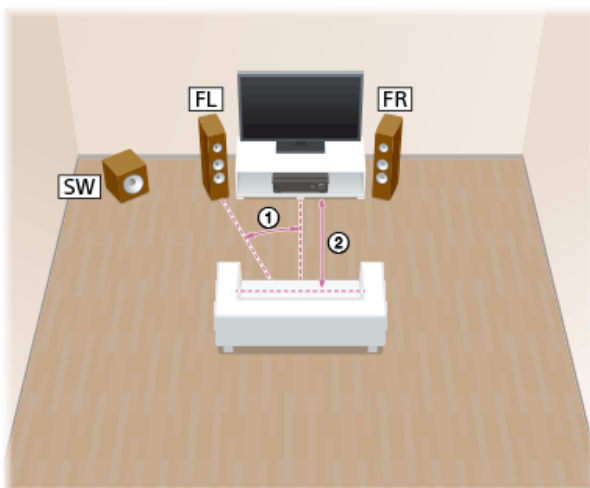

- ① 30°
- ② 1.5 m - 3 m

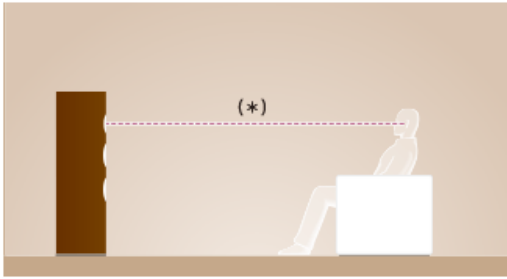

* Set the height of a tweeter of the front speaker at the same height as your ears.

Hint

- As the subwoofer does not emit highly directional signals, you can place it wherever you want.

[18] Preparation | 1. Installing speakers

Speaker configuration and speaker pattern settings

Select the speaker pattern according to the speaker configuration which you are using. The table below shows examples of speaker configurations and speaker pattern settings.

Speaker configuration in each zone		[Surround Back Speaker Assign] (*1)	[Speaker Pattern] setting
Main zone	Zone 2		
5.1-channel	Not used	-	[5.1]
7.1-channel using surround back speakers	Not used	-	[7.1]
5.1.2-channel using top middle speakers	Not used	-	[5.1.2 (TM)]
5.1.2-channel using Dolby Atmos enabled speakers	Not used	-	[5.1.2 (FD)]
5.1-channel with Zone 2 connection	2-channel	[Off] (*2)/[Zone2] (*3)	[5.1]
5.1-channel with bi-amplifier connection	Not used	[BI-AMP]	[5.1]
5.1-channel with front B speaker connection	Not used	[Front B]	[5.1]
2.1-channel (for enjoying Front Surround)	Not used	-	[2.1]

*1 You can only set [Surround Back Speaker Assign] if the speaker pattern is set to a setting that does not have surround back and height/overhead speakers.

*2 For USA and Canadian models only

*3 For other models only

Hint

- The receiver allows you to enjoy a surround-sound effect acoustically equivalent to that of up to a 7.1.2-channel speaker system when you select [Type A] or [Type B] for

[SpeakerRelocation/PhantomSurroundBack] in the [Speaker Settings] menu. When setting [SpeakerRelocation/PhantomSurroundBack], perform Auto Calibration beforehand.

[19] Preparation | 2. Connecting speakers

Connecting 5.1-channel speaker system

Connect each speaker as illustrated below.

Before connecting cables, be sure to disconnect the AC power cord (mains lead).

For details on how to connect speaker cables to the receiver, see "[How to connect speaker cables.](#)"

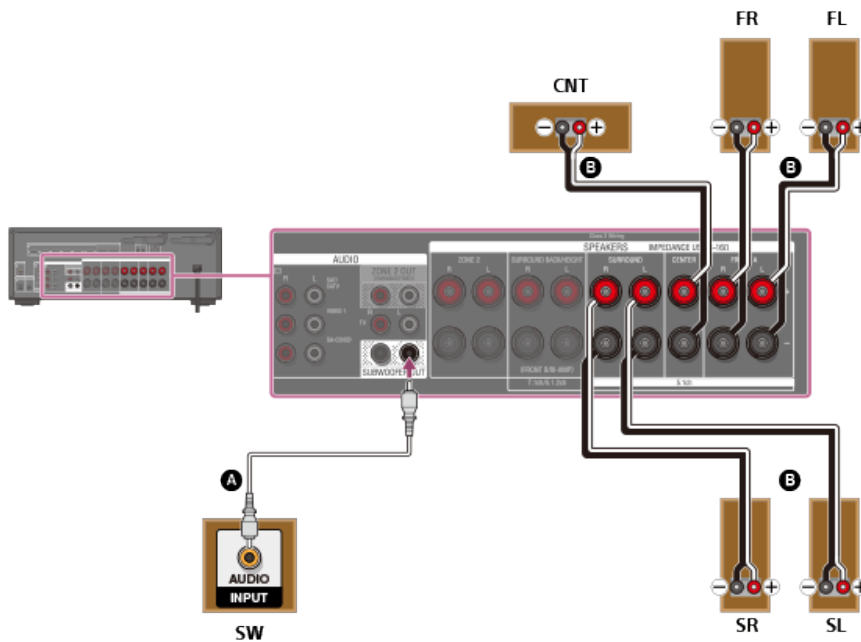

- A** Monaural audio cable (not supplied)
- B** Speaker cable (not supplied)

Note

- After you have installed and connected your speakers, be sure to select the speaker pattern you want using [Speaker Pattern] in the [Speaker Settings] menu.

[20] Preparation | 2. Connecting speakers

Connecting 7.1-channel speaker system using surround back speakers

Connect each speaker as illustrated below.

Before connecting cables, be sure to disconnect the AC power cord (mains lead).

For details on how to connect speaker cables to the receiver, see "[How to connect speaker cables.](#)"

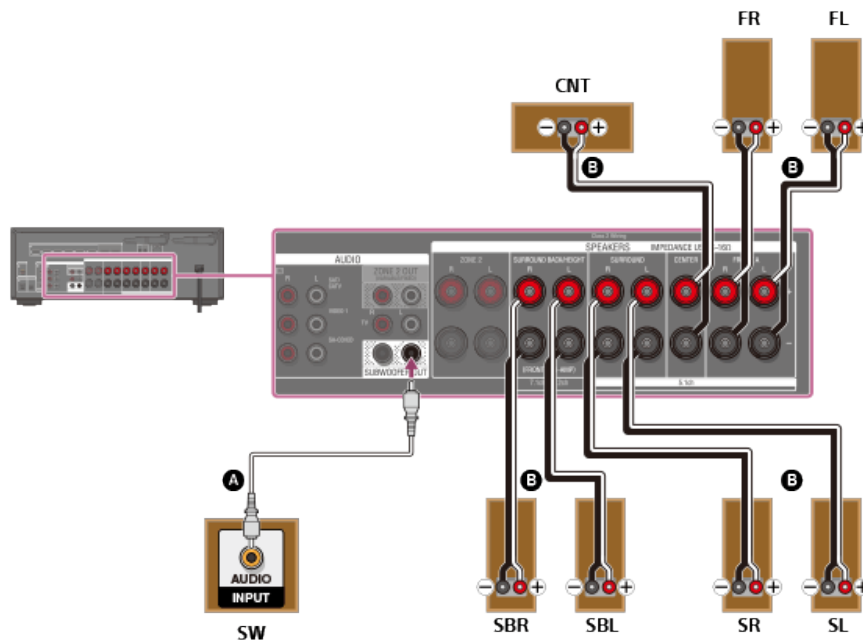

A Monaural audio cable (not supplied)

B Speaker cable (not supplied)

When using only one surround back speaker, please connect it to the SPEAKERS SURROUND BACK/HEIGHT L terminals. After you have installed and connected your speakers, set the speaker pattern to a setting that has only one surround back speaker using [Speaker Pattern] in the [Speaker Settings] menu.

Note

- After you have installed and connected your speakers, be sure to select the speaker pattern you want using [Speaker Pattern] in the [Speaker Settings] menu.

[21] Preparation | 2. Connecting speakers

Connecting 5.1.2-channel speaker system using top middle speakers

Connect each speaker as illustrated below.

Before connecting cables, be sure to disconnect the AC power cord (mains lead).

For details on how to connect speaker cables to the receiver, see "[How to connect speaker cables.](#)"

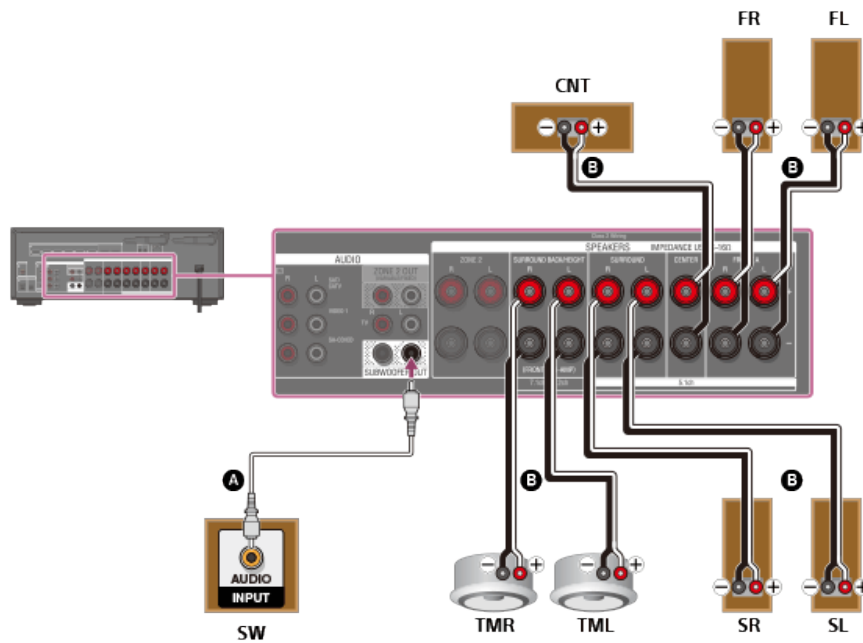

- A** Monaural audio cable (not supplied)
- B** Speaker cable (not supplied)

Note

- After you have installed and connected your speakers, be sure to select the speaker pattern you want using [Speaker Pattern] in the [Speaker Settings] menu.

[22] Preparation | 2. Connecting speakers

Connecting 5.1.2-channel speaker system using front Dolby Atmos enabled speakers

Connect each speaker as illustrated below.

Before connecting cables, be sure to disconnect the AC power cord (mains lead).

For details on how to connect speaker cables to the receiver, see "[How to connect speaker cables.](#)"

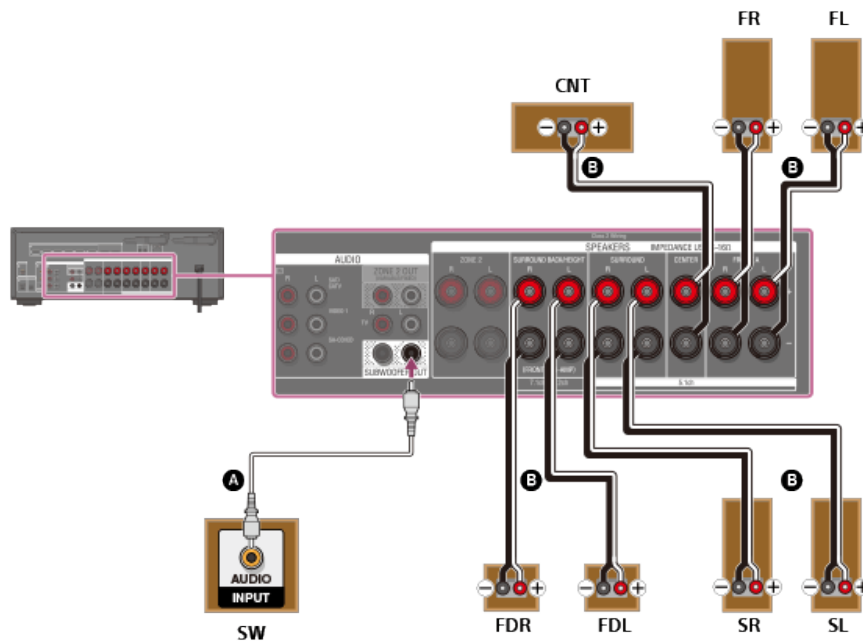

A Monaural audio cable (not supplied)

B Speaker cable (not supplied)

Note

- After you have installed and connected your speakers, be sure to select the speaker pattern you want using [Speaker Pattern] in the [Speaker Settings] menu.

[23] Preparation | 2. Connecting speakers

Connecting 5.1-channel speaker system with Zone 2 connection

Connect each speaker as illustrated below.

Before connecting cables, be sure to disconnect the AC power cord (mains lead).

For details on how to connect speaker cables to the receiver, see "[How to connect speaker cables.](#)"

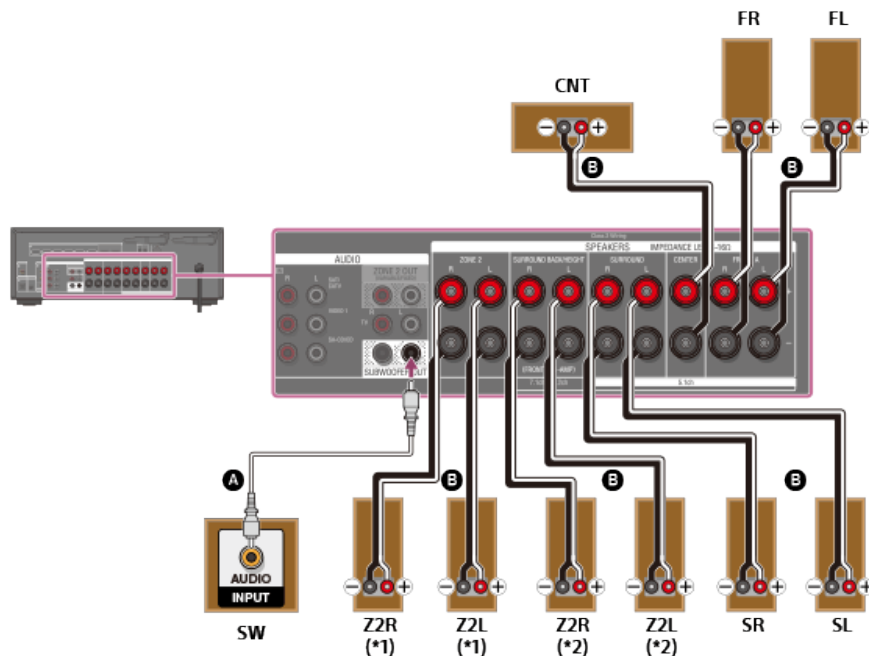

A Monaural audio cable (not supplied)

B Speaker cable (not supplied)

*1 For USA and Canadian models only

*2 For other models

After you have made the Zone 2 connection, set [SURROUND BACK/ZONE2 Priority] to [ZONE2 Terminals] in the [Speaker Settings] menu (for USA and Canadian models only).

After you have made the Zone 2 connection, set [Surround Back Speaker Assign] to [Zone2] in the [Speaker Settings] menu (for other models only).

Note

- After you have installed and connected your speakers, be sure to select the speaker pattern you want using [Speaker Pattern] in the [Speaker Settings] menu.
- You can only set [Surround Back Speaker Assign] if the speaker pattern is set to a setting that does not have surround back and height/overhead speakers.
- Only audio signals from [USB], [Bluetooth] (while in BLUETOOTH RX mode only), [Home Network], [Music Service List], [FM TUNER] and audio signals input from AUDIO IN jacks are output to the Zone 2 speakers.
- External digital input from OPTICAL IN, COAXIAL IN and HDMI IN jacks cannot be output to Zone 2.

[24] Preparation | 2. Connecting speakers

Connecting 5.1-channel speaker system with bi-amplifier connection

You can enhance the sound quality of the front speakers by separately connecting the built-in amplifiers to tweeters and woofers in a bi-amplifier configuration.

If you are not using surround back speakers or height/overhead speakers, you can connect the front speakers to the SPEAKERS SURROUND BACK/HEIGHT terminals using a bi-amplifier connection. Connect each speaker as illustrated below.

Before connecting cables, be sure to disconnect the AC power cord (mains lead).

For details on how to connect speaker cables to the receiver, see "[How to connect speaker cables.](#)"

Connecting front speakers with bi-amplifier connection

Connect the jacks on the Lo (or Hi) side of the front speakers to the SPEAKERS FRONT A terminals, and connect the jacks on the Hi (or Lo) side of the front speakers to the SPEAKERS SURROUND BACK/HEIGHT terminals.

Make sure that metal fittings of Hi/Lo attached to the speakers have been removed from the speakers to avoid receiver malfunction.

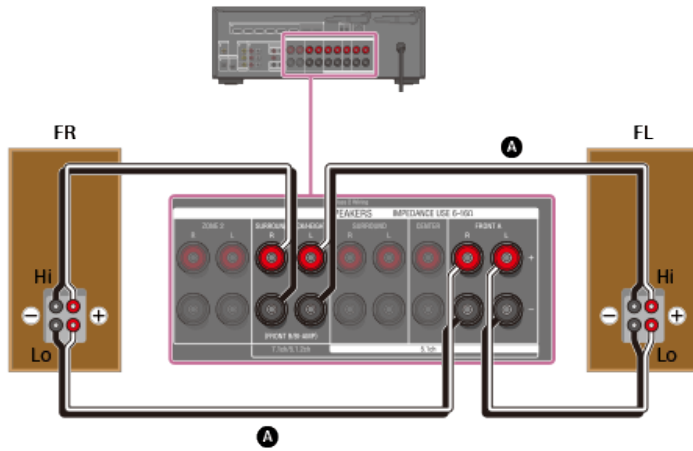

A Speaker cable (not supplied)

Connecting speakers other than front speakers

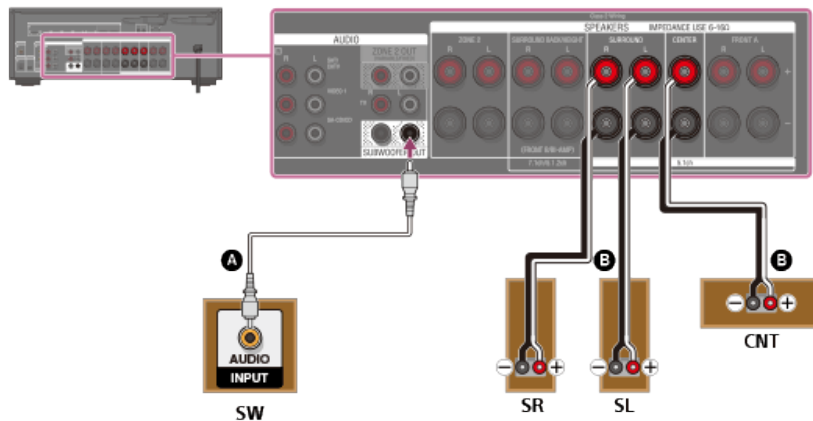

A Monaural audio cable (not supplied)

B Speaker cable (not supplied)

After you have made the bi-amplifier connection, set [Surround Back Speaker Assign] to [BI-AMP] in the [Speaker Settings] menu.

Note

- After you have installed and connected your speakers, be sure to select the speaker pattern you want using [Speaker Pattern] in the [Speaker Settings] menu.
- You can only set [Surround Back Speaker Assign] if the speaker pattern is set to a setting that does not have surround back and height/overhead speakers.

Connecting 5.1-channel speaker system with front B speaker connection

If you are not using surround back speakers or height/overhead speakers, you can connect additional front B speakers to the SPEAKERS SURROUND BACK/HEIGHT terminals. Connect each speaker as illustrated below. Before connecting cables, be sure to disconnect the AC power cord (mains lead). For details on how to connect speaker cables to the receiver, see “[How to connect speaker cables.](#)”

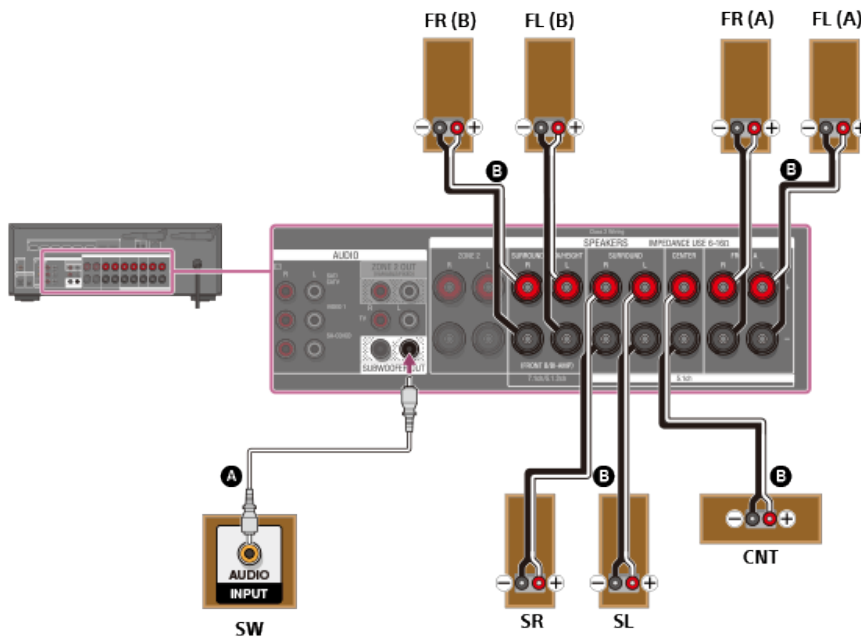

- A Monaural audio cable (not supplied)**
- B Speaker cable (not supplied)**

After you have made the front B speaker connection, set [Surround Back Speaker Assign] to [Front B] in the [Speaker Settings] menu. You can select the front speaker system you want to use by pressing SPEAKERS on the receiver.

Note

- After you have installed and connected your speakers, be sure to select the speaker pattern you want using [Speaker Pattern] in the [Speaker Settings] menu.
- You can only set [Surround Back Speaker Assign] if the speaker pattern is set to a setting that does not have surround back and height/overhead speakers.

[26] Preparation | 2. Connecting speakers

Connecting 2.1-channel speaker system to enjoy the Front Surround mode

Connect each speaker as illustrated below.

Before connecting cables, be sure to disconnect the AC power cord (mains lead). For details on how to connect speaker cables to the receiver, see “[How to connect speaker cables.](#)”

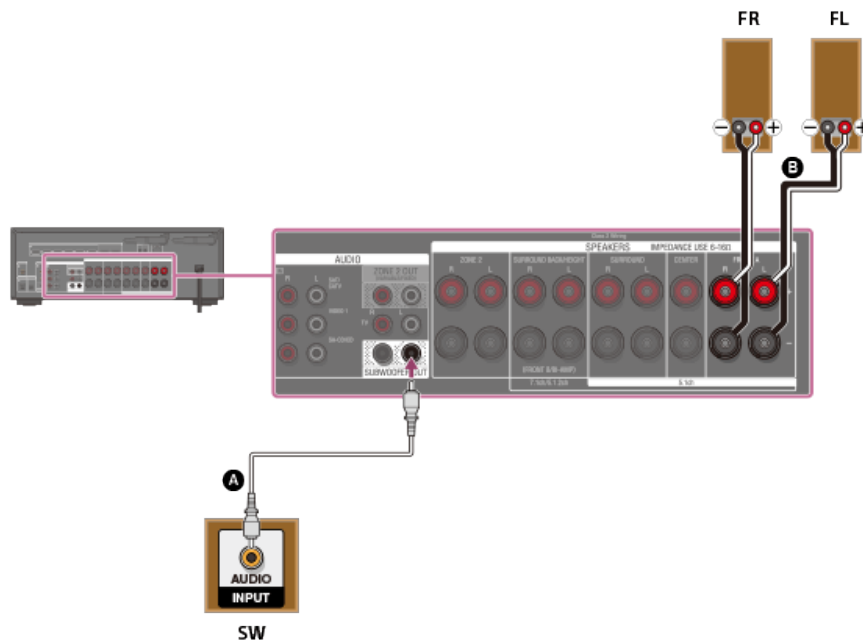

A Monaural audio cable (not supplied)

B Speaker cable (not supplied)

Select [Front Surround] for the sound field setting to enjoy virtual surround effects.

Note

- After you have installed and connected your speakers, be sure to select the speaker pattern you want using [Speaker Pattern] in the [Speaker Settings] menu.

[27] Preparation | 3. Connecting a TV

Connecting a TV

Connect a TV to the HDMI OUT or MONITOR OUT jack. You can operate this receiver using the menu on the TV screen when you connect the TV to an HDMI OUT jack.

Be sure to disconnect the AC power cord (mains lead) before connecting cables.

Connecting a TV incompatible with the Audio Return Channel (ARC) function via an HDMI connection

Solid lines show recommended connections and the dashed lines show alternative connections for audio signals.

When you connect the receiver to a TV using the HDMI cable (C), the receiver can output audio and video signals to the TV. Note, however, that you also need to connect the optical digital cable (A) or audio cable (B) to the TV in order to output TV audio from the speakers connected to the receiver.

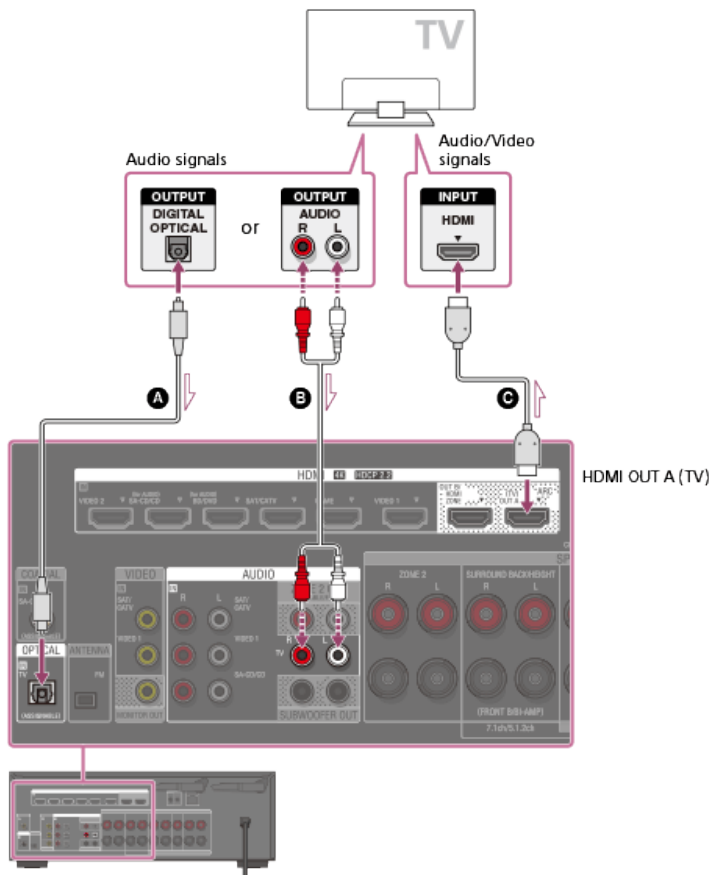

- A** Optical digital cable (not supplied)
- B** Audio cable (not supplied)
- C** HDMI cable (not supplied)

Note

- Sony recommends that you use an HDMI cable made by Sony or another HDMI-authorized cable. Be sure to use a High Speed HDMI Cable with Ethernet. Premium High Speed HDMI Cable with Ethernet that supports 18 Gbps is required for 4K/60p 4:4:4, 4:2:2, and 4K/60p 4:2:0 10 bit, etc.

Connecting a TV compatible with the Audio Return Channel (ARC) function via an HDMI connection

With just one HDMI cable connection, you can listen to the TV audio from the speakers connected to the receiver while the receiver sends audio and video to the TV.

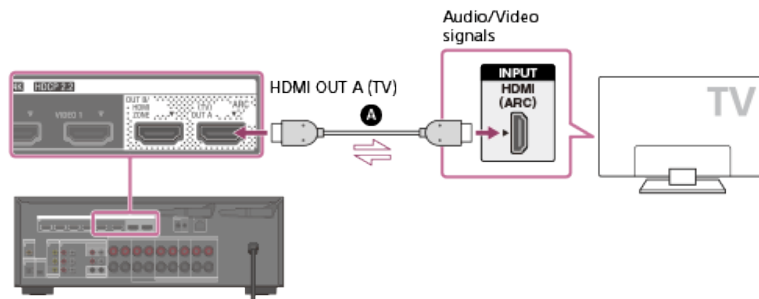

- A** HDMI cable (not supplied)

Note

- Sony recommends that you use an HDMI cable made by Sony or another HDMI-authorized cable. Be sure to use a High Speed HDMI Cable with Ethernet. Premium High Speed HDMI Cable with Ethernet that supports 18 Gbps is required for 4K/60p 4:4:4, 4:2:2, and 4K/60p 4:2:0 10 bit, etc.
- For this connection, you need to turn the Control for HDMI function on. Press HOME to display the home menu, select [Setup] - [HDMI Settings], and set [Control for HDMI] to [On]. Also turn on the Audio Return Channel (ARC) function on the TV.

Hint

- If the HDMI jack of the TV (labeled "ARC") is already connected to another device, disconnect the device and connect the receiver.

Connecting a TV and a projector

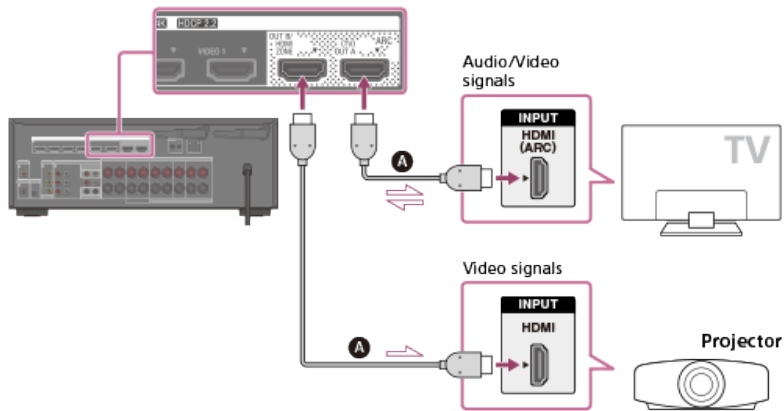

A HDMI cable (not supplied)

Note

- Sony recommends that you use an HDMI cable made by Sony or another HDMI-authorized cable. Be sure to use a High Speed HDMI Cable with Ethernet. Premium High Speed HDMI Cable with Ethernet that supports 18 Gbps is required for 4K/60p 4:4:4, 4:2:2, and 4K/60p 4:2:0 10 bit, etc.
- When outputting the same image to the projector as to the TV, select [Setup] - [HDMI Settings] and set [HDMI Out B Mode] to [Main], then select [HDMI B] or [HDMI A+B] by pressing HDMI OUT. When outputting different images to the TV and the projector, use the multi-zone feature by setting [HDMI Out B Mode] to [Zone].

Connecting a TV without HDMI jacks

Solid lines show recommended connections and the dashed lines show alternative connections for audio signals. It is not necessary to connect all the cables.

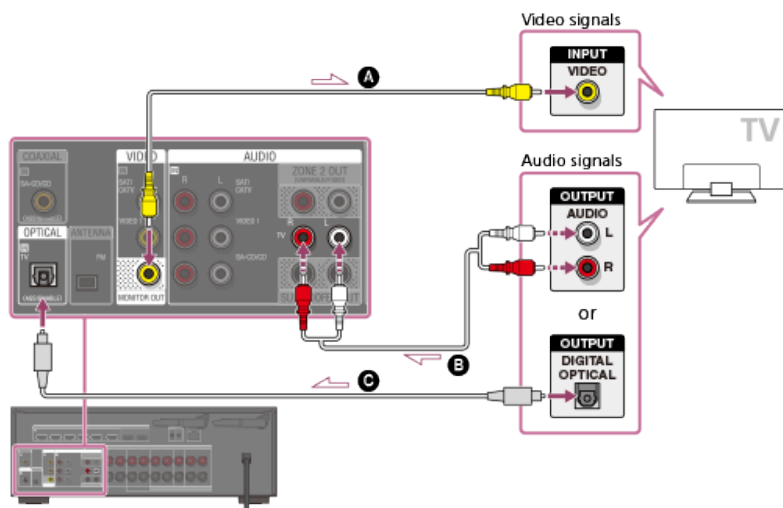

A Video cable (not supplied)

B Audio cable (not supplied)

C Optical digital cable (not supplied)

Note

- Connect a TV monitor or a projector to the HDMI OUT A (TV), HDMI OUT B/HDMI ZONE or MONITOR OUT jack on the receiver.

- Depending on the status of the connection between the TV and the antenna (aerial), the image on the TV screen may be distorted. If this is the case, place the antenna (aerial) farther away from the receiver.

Hint

- When connecting a TV to the receiver via the TV IN jacks of the receiver, set the sound output jack of the TV to “Fixed” if it can be switched between “Fixed” or “Variable.”

[28] Preparation | 3. Connecting a TV

Connecting a 4K TV

All HDMI jacks on the receiver support 4K resolution and HDCP 2.2 (High-bandwidth Digital Content Protection System Revision 2.2).

HDCP 2.2 is newly enhanced copyright protection technology that is used to protect content such as 4K movies.

To watch HDCP 2.2 protected content such as 4K content, connect the HDMI jacks to jacks that support HDCP 2.2 on the TV and AV device. For details on whether the TV and AV device are equipped with HDCP 2.2-compatible HDMI jack, refer to the operating instructions of the connected device.

When you use high bandwidth video formats such as 4K/60p 4:4:4, 4:2:2, and 4K/60p 4:2:0 10 bit, etc., be sure to set the HDMI signal format. For details, see “[Setting HDMI signal formats \(HDMI Signal Format\)](#).”

When an HDCP 2.2-compatible HDMI jack on the TV is labeled “ARC” (*)

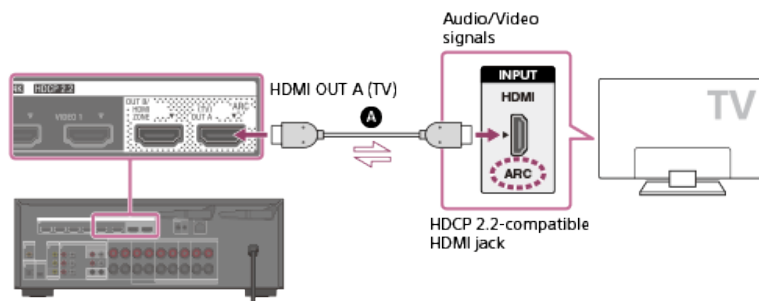

A HDMI cable (not supplied)

- * The Audio Return Channel (ARC) function sends digital sound from a TV to the receiver using only an HDMI cable.

Note

- Sony recommends that you use an HDMI cable made by Sony or another HDMI-authorized cable. Be sure to use a High Speed HDMI Cable with Ethernet. Premium High Speed HDMI Cable with Ethernet that supports 18 Gbps is required for 4K/60p 4:4:4, 4:2:2, and 4K/60p 4:2:0 10 bit, etc.

When you want to watch HDCP 2.2 protected content and the non-HDCP 2.2-compatible HDMI jack on the TV is labeled “ARC”

If the HDMI jack on the TV is labeled ARC and is not HDCP 2.2-compatible, connect the receiver to the HDCP 2.2-compatible HDMI jack on the TV using a High Speed HDMI Cable with Ethernet. Then, connect an optical digital cable to the optical output jack of the TV to listen to digital sound.

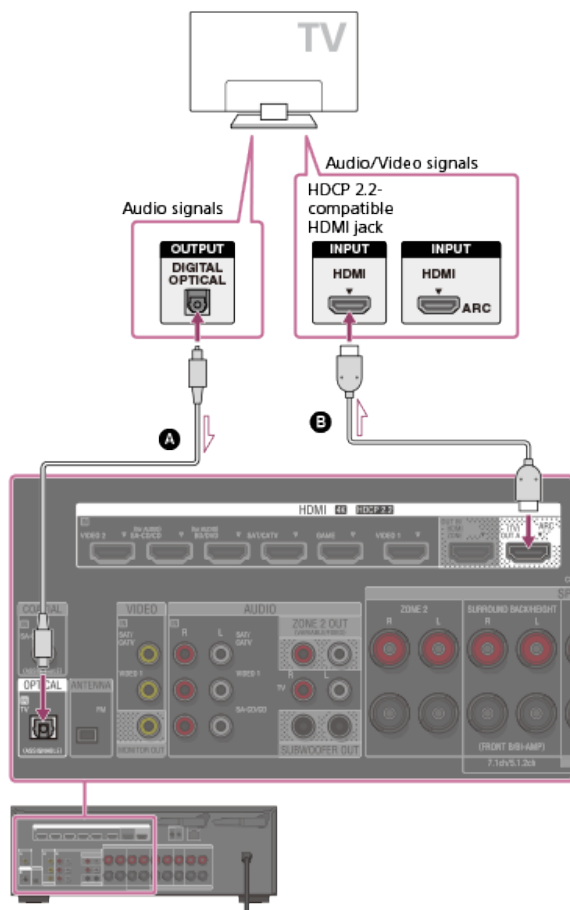

A Optical digital cable (not supplied)

B HDMI cable (not supplied)

Note

- Sony recommends that you use an HDMI cable made by Sony or another HDMI-authorized cable. Be sure to use a High Speed HDMI Cable with Ethernet. Premium High Speed HDMI Cable with Ethernet that supports 18 Gbps is required for 4K/60p 4:4:4, 4:2:2, and 4K/60p 4:2:0 10 bit, etc.

[29] Preparation | 3. Connecting a TV

About input/output of video signals

The digital video signals input to the HDMI IN jacks of this receiver are output from HDMI OUT A (TV) or HDMI OUT B/HDMI ZONE jacks only. The analog video signals input from VIDEO IN jacks are output from the MONITOR OUT jack only.

Use the following illustration as reference when you connect the receiver, AV device, and TV.

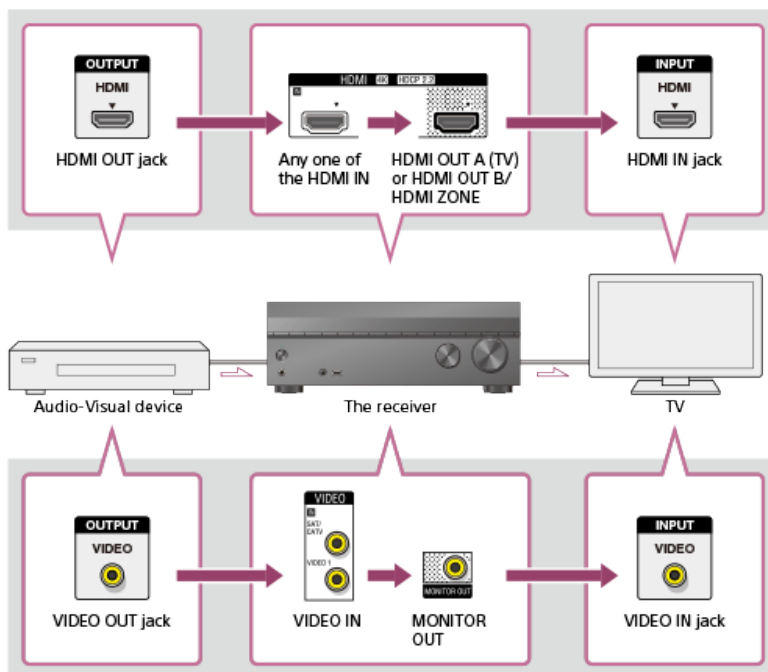

Note

- When you connect the TV to the MONITOR OUT jack, the home menu of this receiver is not displayed on the TV screen. To operate this receiver using the menu on the TV screen, connect the TV to the HDMI OUT A (TV) or HDMI OUT B/HDMI ZONE jacks.

[30] Preparation | 3. Connecting a TV

Notes on connecting cables

- Before connecting cables, be sure to disconnect the AC power cord (mains lead).
- It is not necessary to connect all of the cables. Connect cables according to the availability of jacks on the connected device.
- Sony recommends that you use an HDMI cable made by Sony or another HDMI-authorized cable. Be sure to use a High Speed HDMI Cable with Ethernet. Premium High Speed HDMI Cable with Ethernet that supports 18 Gbps is required for 4K/60p 4:4:4, 4:2:2, and 4K/60p 4:2:0 10 bit, etc. For details about the high bandwidth video format, refer to “Supported video formats” in “[About HDMI connections.](#)”
- We do not recommend using an HDMI-DVI conversion cable. If you connect an HDMI-DVI conversion cable to a DVI-D device, the sound and/or image may be lost. Connect separate audio cables or digital connecting cables, then reassign the input jacks if the sound is not output correctly.
- When connecting optical digital cables, insert the plugs straight until they click into place.
- Do not bend or tie optical digital cables.

Hint

- All of the digital audio jacks are compatible with 32 kHz, 44.1 kHz, 48 kHz and 96 kHz sampling frequencies.

If you want to connect several digital devices, but cannot find an unused input

In this case, reassign the input jacks.

About HDMI connections

High-Definition Multimedia Interface (HDMI) is an interface that transmits video and audio signals in digital format. Connecting Sony "BRAVIA" Sync-compatible devices using HDMI cables simplifies operations.

HDMI features

- Digital audio signals transmitted by HDMI can be output from the speakers connected to the receiver. This signal supports Dolby Digital, DTS, DSD, and Linear PCM.
- The receiver can receive Multi Channel Linear PCM (up to 8 channels) with a sampling frequency of 192 kHz or less via an HDMI connection.
- The receiver also supports High Bitrate Audio (DTS-HD Master Audio and Dolby TrueHD) and object-based audio formats (DTS:X and Dolby Atmos).
- To enjoy 3D content, connect a 3D-compatible TV and video device (Blu-ray Disc player, Blu-ray Disc recorder, PlayStation 4, etc.) to the receiver using High Speed HDMI Cables with Ethernet, put on 3D glasses, and then play 3D-compatible content.
- To enjoy 4K content, connect a 4K-compatible TV or video device (Blu-ray Disc player, etc.) to the receiver using High Speed HDMI Cables with Ethernet, and then play 4K-compatible content.
- Premium High Speed HDMI Cable with Ethernet that supports 18 Gbps is required for 4K/60p 4:4:4, 4:2:2, and 4K/60p 4:2:0 10 bit, etc.
- All HDMI jacks on the receiver support High-bandwidth Digital Content Protection System Revision 2.2 (HDCP 2.2). Connect these HDMI jacks to jacks that support HDCP 2.2 on the TV and AV device. Refer to the operating instructions of the connected device for details.
- The HDMI OUT and HDMI IN jacks (except the HDMI IN VIDEO 1 jack) support bandwidth up to 18 Gbps. The HDMI IN VIDEO 1 jack supports bandwidth up to 9 Gbps.
- All HDMI jacks on the receiver support 4K, HDCP 2.2, ITU-R BT.2020 wide color spaces, 3D, Deep Color (Deep Colour), and HDR (High Dynamic Range) contents pass-through.
- The HDMI OUT A (TV) jack supports Audio Return Channel (ARC).
- HDCP 2.2 is newly enhanced copyright protection technology that is used to protect content such as 4K movies.
- BT.2020 color space is new wider color standard that is defined for ultra-high definition television systems.
- HDR is an emerging video format that can display a wider range of brightness levels. The receiver supports HDR10, HLG (Hybrid Log-Gamma), and Dolby Vision.

Supported video formats

Format	2D	3D		
		Frame packing	Side-by-Side (Half)	Over-Under (Top-and-Bottom)
4096 x 2160p @ 59.94/60 Hz	○ (*1)	-	-	-
4096 x 2160p @ 50 Hz	○ (*1)	-	-	-
4096 x 2160p @ 29.97/30 Hz	○ (*2)	-	-	-
4096 x 2160p @ 25 Hz	○ (*2)	-	-	-
4096 x 2160p @ 23.98/24 Hz	○ (*2)	-	-	-

3840 x 2160p @ 59.94/60 Hz	○ (*1)	-	-	-
3840 x 2160p @ 50 Hz	○ (*1)	-	-	-
3840 x 2160p @ 29.97/30 Hz	○ (*2)	-	-	-
3840 x 2160p @ 25 Hz	○ (*2)	-	-	-
3840 x 2160p @ 23.98/24 Hz	○ (*2)	-	-	-
1920 x 1080p @ 59.94/60 Hz	○	-	○	○
1920 x 1080p @ 50 Hz	○	-	○	○
1920 x 1080p @ 29.97/30 Hz	○	○	○	○
1920 x 1080p @ 25 Hz	○	○	○	○
1920 x 1080p @ 23.98/24 Hz	○	○	○	○
1920 x 1080i @ 59.94/60 Hz	○	○	○	○
1920 x 1080i @ 50 Hz	○	○	○	○
1280 x 720p @ 59.94/60 Hz	○	○	○	○
1280 x 720p @ 50 Hz	○	○	○	○
1280 x 720p @ 29.97/30 Hz	○	○	○	○
1280 x 720p @ 23.98/24 Hz	○	○	○	○
720 x 480p @ 59.94/60 Hz	○	-	-	-
720 x 576p @ 50 Hz	○	-	-	-
640 x 480p @ 59.94/60 Hz	○	-	-	-

*1 If you use YCbCr 4:4:4/YCbCr 4:2:2/RGB 4:4:4 or YCbCr 4:2:0 Deep Color (Deep Colour) (10 bit or 12 bit) of these video formats, we recommend you to use Premium High Speed HDMI Cables with Ethernet that support 18 Gbps and be sure to set [HDMI Signal Format] to [Enhanced format] in the [HDMI Settings] menu. For details, see "[Setting HDMI signal formats \(HDMI Signal Format\).](#)"

*2 If you use Deep Color (Deep Colour) (10 bit or 12 bit) of these video formats, we recommend you to use Premium High Speed HDMI Cables with Ethernet that support 18 Gbps and be sure to set the [HDMI Signal Format] to [Enhanced format] in the [HDMI Settings] menu. For details, see "[Setting HDMI signal formats \(HDMI Signal Format\).](#)"

Note

- Depending on the TV or video device, 4K or 3D content may not be displayed. Check the HDMI video formats supported by the receiver.
- When you connect two TVs to the receiver, Dolby Vision content may not be displayed. For details,

see “Switching the TVs that output the HDMI video signals.”

- Refer to the operating instructions of each connected device for details.

[32] Preparation | 4. Connecting audio-visual devices and the antennas (aerials)

Connecting devices with HDMI jacks

Connect devices to the receiver as illustrated below. Before connecting cables, be sure to disconnect the AC power cord (mains lead).

All HDMI jacks on the receiver support High-bandwidth Digital Content Protection System Revision 2.2 (HDCP 2.2). To watch content protected by HDCP 2.2, such as 4K content, connect these HDMI jacks to jacks that support HDCP 2.2 on the AV device. Refer to the operating instructions of the connected device for details.

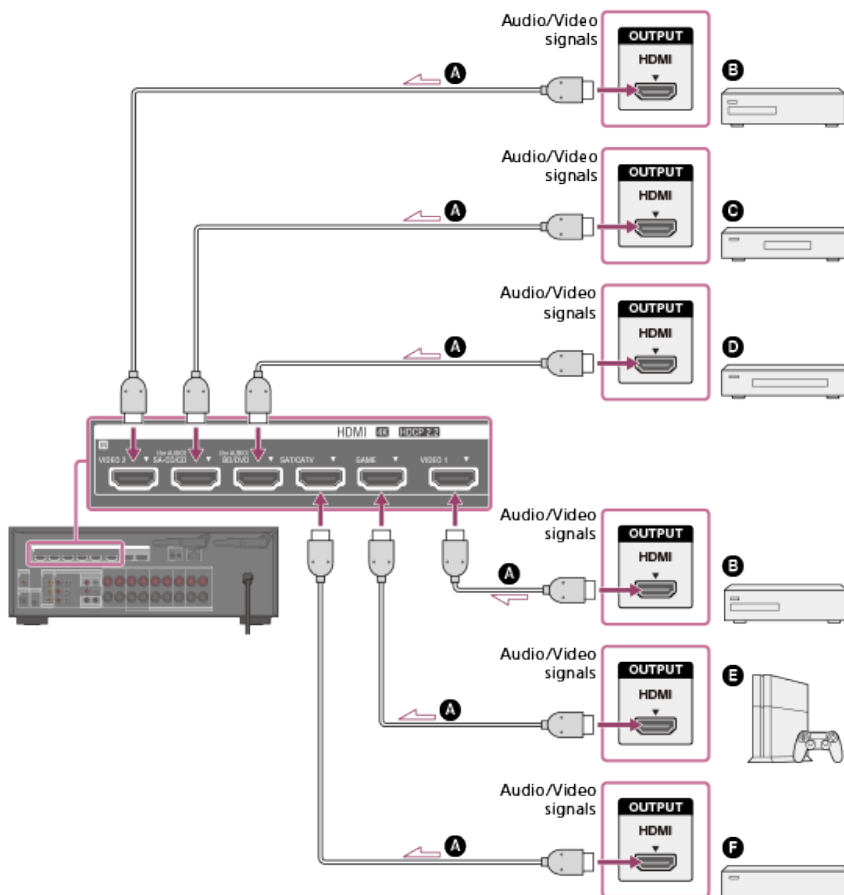

- A** HDMI cable (not supplied)
- B** DVD recorder/player
- C** Super Audio CD player, CD player
- D** Blu-ray Disc™ recorder/player
- E** Game console such as PlayStation 4
- F** Cable box or satellite box

Note

- Sony recommends that you use an HDMI cable made by Sony or another HDMI-authorized cable. Be sure to use a High Speed HDMI Cable with Ethernet. Premium High Speed HDMI Cable with Ethernet that supports 18 Gbps is required for 4K/60p 4:4:4, 4:2:2, and 4K/60p 4:2:0 10 bit, etc.

Hint

- This HDMI connection is an example. You can connect each HDMI device to any HDMI input.
- The BD/DVD and SA-CD/CD inputs have better sound quality. When you need a higher sound quality, connect your device to these jacks and select them as the input.
- The image quality depends on the connecting jack. We recommend that you connect your devices via an HDMI connection if they have HDMI jacks.

[33] Preparation | 4. Connecting audio-visual devices and the antennas (aerials)

Connecting devices with jacks other than HDMI jacks

Connect devices to the receiver as illustrated below.

Solid lines show recommended connections and the dashed lines show alternative connections.

It is not necessary to connect all the cables.

Before connecting cables, be sure to disconnect the AC power cord (mains lead).

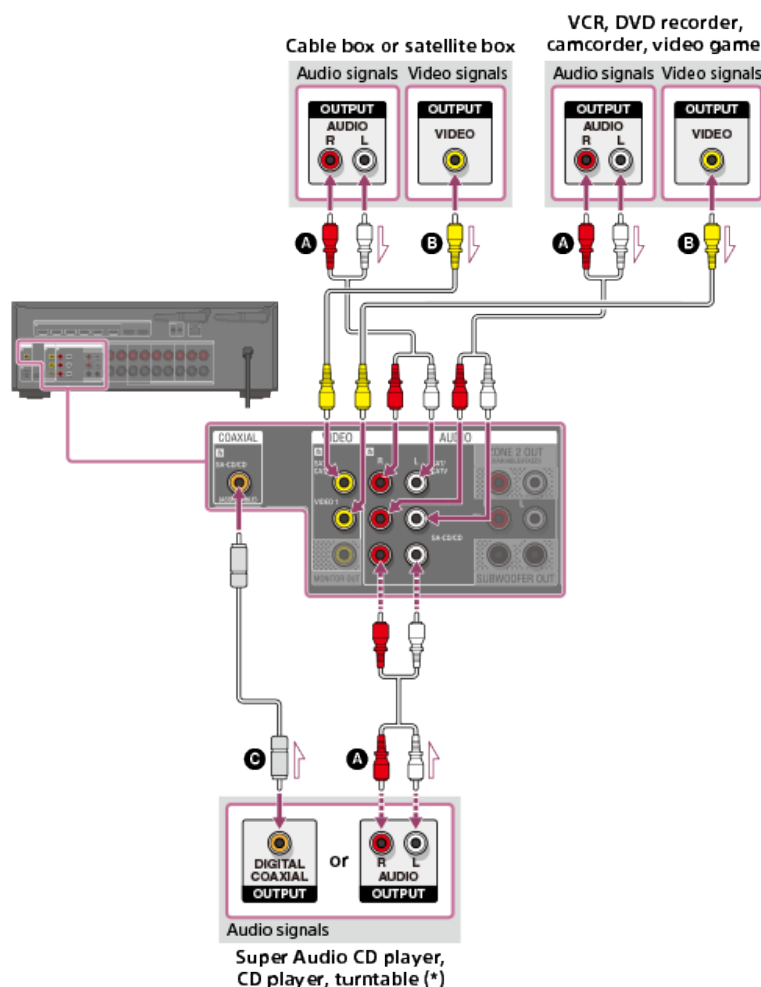

- A Audio cable (not supplied)**
- B Video cable (not supplied)**
- C Coaxial digital cable (not supplied)**

* To connect a turntable that only has a PHONO output jack, you need to connect a phono equalizer (not supplied) between the turntable and this receiver.

To listen to the sounds from a device connected to the AUDIO IN jacks, do not connect any device to the HDMI IN, COAXIAL IN, and OPTICAL IN jacks, which are labeled with the same device name (such as SAT/CATV, VIDEO 1, TV and SA-CD/CD).

Hint

- You can connect devices other than those indicated above to the AUDIO IN jacks (SAT/CATV, VIDEO 1, and SA-CD/CD).
- You can rename each input so that the name can be displayed on the display panel of the receiver. For details, see “[Changing the name for each input \(Name\)](#).”
- The image quality depends on the connecting jack. We recommend that you connect your devices via an HDMI connection if they have HDMI jacks.

[34] Preparation | 4. Connecting audio-visual devices and the antennas (aerials)

About input/output of video signals

The digital video signals input to the HDMI IN jacks of this receiver are output from HDMI OUT A (TV) or HDMI OUT B/HDMI ZONE jacks only. The analog video signals input from VIDEO IN jacks are output from the MONITOR OUT jack only.

Use the following illustration as reference when you connect the receiver, AV device, and TV.

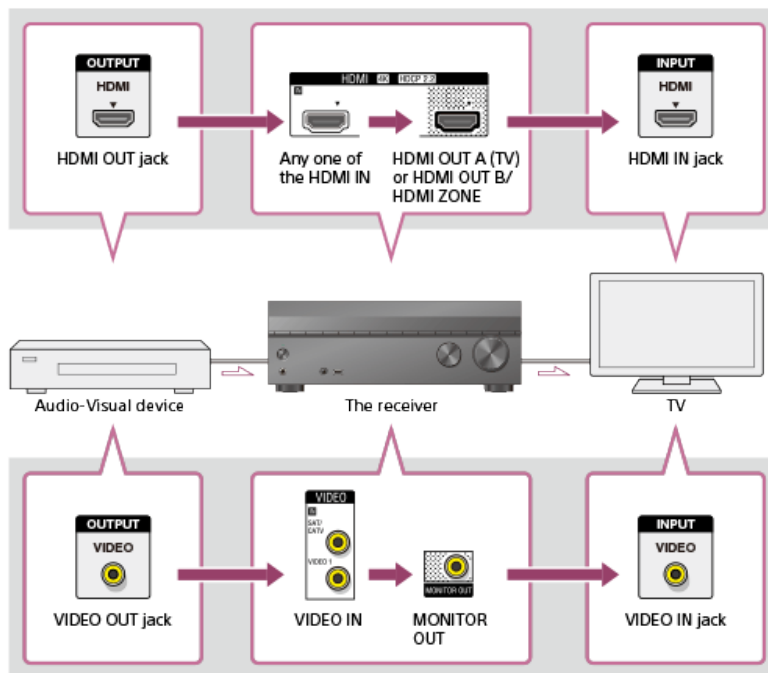

Note

- When you connect the TV to the MONITOR OUT jack, the home menu of this receiver is not displayed on the TV screen. To operate this receiver using the menu on the TV screen, connect the TV to the HDMI OUT A (TV) or HDMI OUT B/HDMI ZONE jacks.

[35] Preparation | 4. Connecting audio-visual devices and the antennas (aerials)

Connecting a USB device

Connect a USB device as illustrated below.

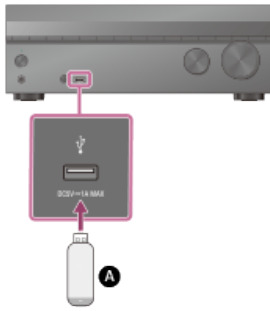

A USB device

Note

- iPhone/iPad/iPod playback via ψ (USB) port is not possible.

[36] Preparation | 4. Connecting audio-visual devices and the antennas (aerials)

Connecting the antenna (aerial)

Connect the supplied FM wire antenna (aerial) to the receiver as illustrated below.
Before connecting antenna (aerial), be sure to disconnect the AC power cord (mains lead).

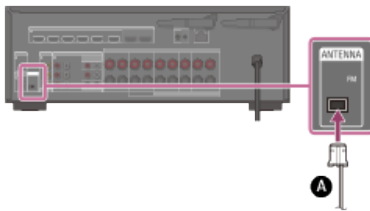

A FM wire antenna (aerial) (supplied)

Note

- Be sure to fully extend the FM wire antenna (aerial).
- After connecting the FM wire antenna (aerial), keep it as horizontal as possible.

[37] Preparation | 4. Connecting audio-visual devices and the antennas (aerials)

Connecting another amplifier in Zone 2

You can enjoy sound from a device connected to the receiver in a zone other than the main zone. For example, you can watch a DVD in the main zone and listen to music received from music services in Zone 2.

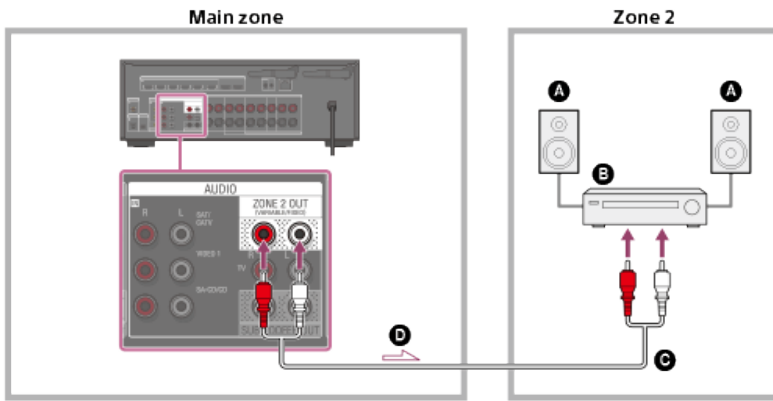

- A** Speakers
- B** Amplifier/receiver
- C** Audio cable (not supplied)
- D** Audio signals

Note

- Only audio signals from [USB], [Bluetooth] (only when in BLUETOOTH RX mode), [Home Network], [Music Service List], [FM TUNER] and audio signals input from AUDIO IN jacks are output to the Zone 2 speakers.
- External digital input from OPTICAL IN, COAXIAL IN and HDMI IN jacks cannot be output to Zone 2.

[38] Preparation | 4. Connecting audio-visual devices and the antennas (aerials)

Connecting another amplifier or TV in the HDMI zone

HDMI input video/audio signals are output in HDMI zone using the HDMI OUT B/HDMI ZONE jack of the receiver.

When connecting only to a TV

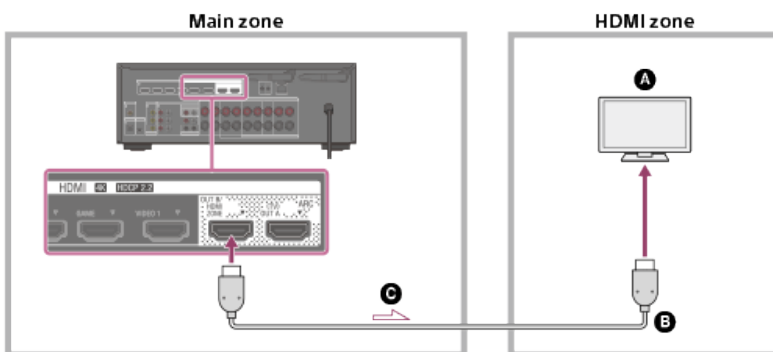

When connecting to another amplifier

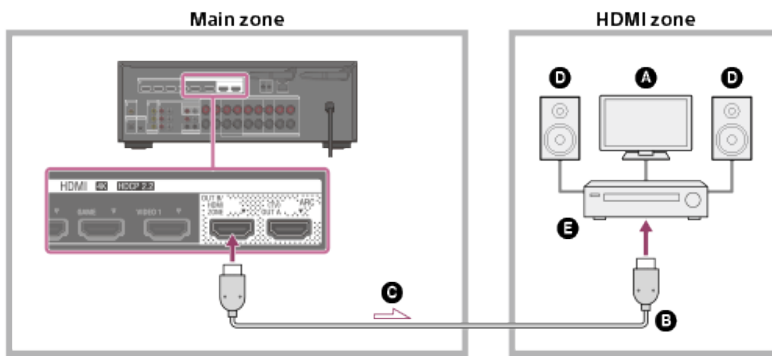

- A** TV
- B** HDMI cable (not supplied)
- C** Audio/video signals
- D** Speakers
- E** Amplifier/receiver

Note

- To use this connection, select [Setup] - [HDMI Settings], and set [HDMI Out B Mode] to [Zone].

[39] Preparation | 4. Connecting audio-visual devices and the antennas (aerials)

Digital audio formats supported by the receiver

The digital audio formats that this receiver can decode depend on the digital audio output jacks of the connected device. This receiver supports the following audio formats. The words in brackets are those indicated on the display panel.

Digital audio format	Maximum number of decoded channels	Connection with the receiver
Dolby Digital [DOLBY D]	5.1	COAXIAL/OPTICAL, HDMI
Dolby Digital Plus [DOLBY D +] (*1)	7.1	HDMI
Dolby TrueHD [DOLBY HD] (*1)	7.1	HDMI
Dolby Atmos - Dolby Digital Plus [DAtmos] (*1)(*2)	5.1.2, 7.1 or 7.1.2 (*3)	HDMI
Dolby Atmos - Dolby TrueHD [DAtmos] (*1)(*2)	5.1.2, 7.1 or 7.1.2 (*3)	HDMI
DTS [DTS]	5.1	COAXIAL/OPTICAL, HDMI
DTS-ES Discrete [DTS-ES Dsc]	6.1	COAXIAL/OPTICAL, HDMI
DTS-ES Matrix [DTS-ES Mtx]	6.1	COAXIAL/OPTICAL, HDMI
DTS 96/24 [DTS 96/24]	5.1	COAXIAL/OPTICAL, HDMI

DTS-HD High Resolution Audio [DTS-HD HR] (*1)	7.1	HDMI
DTS-HD Master Audio [DTS-HD MA] (*1)	7.1	HDMI
DTS:X [DTS:X] (*1)	5.1.2, 7.1 or 7.1.2 (*3)	HDMI
DTS:X Master Audio [DTS:X MA] (*1)	5.1.2, 7.1 or 7.1.2 (*3)	HDMI
DSD [DSD] (*1)(*4)	5.1	HDMI
Multi Channel Linear PCM [PCM] (*1)	7.1	HDMI

*1 Audio signals are output in another format if the playback device does not correspond to the actual format. For details, refer to the operating instructions of the playback device.

*2 Dolby Atmos is decoded as Dolby Digital Plus or Dolby TrueHD if the speaker pattern is set to 2.0, 2.1, 3.0, 3.1, 4.0, 4.1, 5.0 or 5.1.

*3 Available only when [SpeakerRelocation/PhantomSurroundBack] is set to [Type A] or [Type B].

*4 This format is not output to wireless headphones/speakers.

[40] Preparation | 4. Connecting audio-visual devices and the antennas (aerials)

Notes on connecting cables

- Before connecting cables, be sure to disconnect the AC power cord (mains lead).
- It is not necessary to connect all of the cables. Connect cables according to the availability of jacks on the connected device.
- Sony recommends that you use an HDMI cable made by Sony or another HDMI-authorized cable. Be sure to use a High Speed HDMI Cable with Ethernet. Premium High Speed HDMI Cable with Ethernet that supports 18 Gbps is required for 4K/60p 4:4:4, 4:2:2, and 4K/60p 4:2:0 10 bit, etc. For details about the high bandwidth video format, refer to “Supported video formats” in “[About HDMI connections](#).”
- We do not recommend using an HDMI-DVI conversion cable. If you connect an HDMI-DVI conversion cable to a DVI-D device, the sound and/or image may be lost. Connect separate audio cables or digital connecting cables, then reassign the input jacks if the sound is not output correctly.
- When connecting optical digital cables, insert the plugs straight until they click into place.
- Do not bend or tie optical digital cables.

Hint

- All of the digital audio jacks are compatible with 32 kHz, 44.1 kHz, 48 kHz and 96 kHz sampling frequencies.

If you want to connect several digital devices, but cannot find an unused input

In this case, reassign the input jacks.

[41] Preparation | 4. Connecting audio-visual devices and the antennas (aerials)

About HDMI connections

High-Definition Multimedia Interface (HDMI) is an interface that transmits video and audio signals in digital format. Connecting Sony “BRAVIA” Sync-compatible devices using HDMI cables simplifies operations.

HDMI features

- Digital audio signals transmitted by HDMI can be output from the speakers connected to the receiver. This signal supports Dolby Digital, DTS, DSD, and Linear PCM.
- The receiver can receive Multi Channel Linear PCM (up to 8 channels) with a sampling frequency of 192 kHz or less via an HDMI connection.
- The receiver also supports High Bitrate Audio (DTS-HD Master Audio and Dolby TrueHD) and object-based audio formats (DTS:X and Dolby Atmos).
- To enjoy 3D content, connect a 3D-compatible TV and video device (Blu-ray Disc player, Blu-ray Disc recorder, PlayStation 4, etc.) to the receiver using High Speed HDMI Cables with Ethernet, put on 3D glasses, and then play 3D-compatible content.
- To enjoy 4K content, connect a 4K-compatible TV or video device (Blu-ray Disc player, etc.) to the receiver using High Speed HDMI Cables with Ethernet, and then play 4K-compatible content.
- Premium High Speed HDMI Cable with Ethernet that supports 18 Gbps is required for 4K/60p 4:4:4, 4:2:2, and 4K/60p 4:2:0 10 bit, etc.
- All HDMI jacks on the receiver support High-bandwidth Digital Content Protection System Revision 2.2 (HDCP 2.2). Connect these HDMI jacks to jacks that support HDCP 2.2 on the TV and AV device. Refer to the operating instructions of the connected device for details.
- The HDMI OUT and HDMI IN jacks (except the HDMI IN VIDEO 1 jack) support bandwidth up to 18 Gbps. The HDMI IN VIDEO 1 jack supports bandwidth up to 9 Gbps.
- All HDMI jacks on the receiver support 4K, HDCP 2.2, ITU-R BT.2020 wide color spaces, 3D, Deep Color (Deep Colour), and HDR (High Dynamic Range) contents pass-through.
- The HDMI OUT A (TV) jack supports Audio Return Channel (ARC).
- HDCP 2.2 is newly enhanced copyright protection technology that is used to protect content such as 4K movies.
- BT.2020 color space is new wider color standard that is defined for ultra-high definition television systems.
- HDR is an emerging video format that can display a wider range of brightness levels. The receiver supports HDR10, HLG (Hybrid Log-Gamma), and Dolby Vision.

Supported video formats

Format	2D	3D		
		Frame packing	Side-by-Side (Half)	Over-Under (Top-and-Bottom)
4096 x 2160p @ 59.94/60 Hz	○ (*1)	-	-	-
4096 x 2160p @ 50 Hz	○ (*1)	-	-	-
4096 x 2160p @ 29.97/30 Hz	○ (*2)	-	-	-
4096 x 2160p @ 25 Hz	○ (*2)	-	-	-
4096 x 2160p @ 23.98/24 Hz	○ (*2)	-	-	-
3840 x 2160p @ 59.94/60 Hz	○ (*1)	-	-	-
3840 x 2160p @ 50 Hz	○ (*1)	-	-	-

3840 × 2160p @ 29.97/30 Hz	○ (*2)	-	-	-
3840 × 2160p @ 25 Hz	○ (*2)	-	-	-
3840 × 2160p @ 23.98/24 Hz	○ (*2)	-	-	-
1920 × 1080p @ 59.94/60 Hz	○	-	○	○
1920 × 1080p @ 50 Hz	○	-	○	○
1920 × 1080p @ 29.97/30 Hz	○	○	○	○
1920 × 1080p @ 25 Hz	○	○	○	○
1920 × 1080p @ 23.98/24 Hz	○	○	○	○
1920 × 1080i @ 59.94/60 Hz	○	○	○	○
1920 × 1080i @ 50 Hz	○	○	○	○
1280 × 720p @ 59.94/60 Hz	○	○	○	○
1280 × 720p @ 50 Hz	○	○	○	○
1280 × 720p @ 29.97/30 Hz	○	○	○	○
1280 × 720p @ 23.98/24 Hz	○	○	○	○
720 × 480p @ 59.94/60 Hz	○	-	-	-
720 × 576p @ 50 Hz	○	-	-	-
640 × 480p @ 59.94/60 Hz	○	-	-	-

*1 If you use YCbCr 4:4:4/YCbCr 4:2:2/RGB 4:4:4 or YCbCr 4:2:0 Deep Color (Deep Colour) (10 bit or 12 bit) of these video formats, we recommend you to use Premium High Speed HDMI Cables with Ethernet that support 18 Gbps and be sure to set [HDMI Signal Format] to [Enhanced format] in the [HDMI Settings] menu. For details, see "[Setting HDMI signal formats \(HDMI Signal Format\).](#)"

*2 If you use Deep Color (Deep Colour) (10 bit or 12 bit) of these video formats, we recommend you to use Premium High Speed HDMI Cables with Ethernet that support 18 Gbps and be sure to set the [HDMI Signal Format] to [Enhanced format] in the [HDMI Settings] menu. For details, see "[Setting HDMI signal formats \(HDMI Signal Format\).](#)"

Note

- Depending on the TV or video device, 4K or 3D content may not be displayed. Check the HDMI video formats supported by the receiver.
- When you connect two TVs to the receiver, Dolby Vision content may not be displayed. For details, see "[Switching the TVs that output the HDMI video signals.](#)"
- Refer to the operating instructions of each connected device for details.

Connecting the receiver to the network using a LAN cable (for wired LAN connections only)

The following illustration is an example configuration of a home network with the receiver and a server.

We recommend that you connect the server to the router with a wired connection.

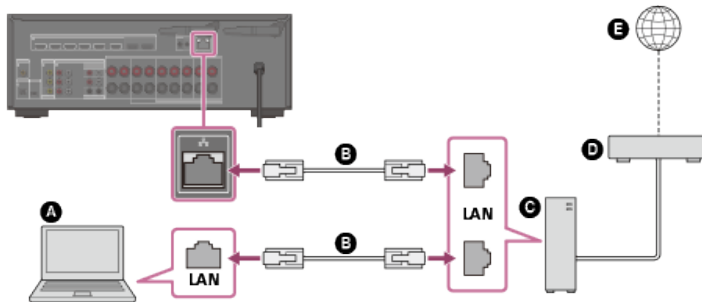

- A** Server (computer, etc.)
- B** LAN cable (*) (not supplied)
- C** Router
- D** Modem
- E** Internet

* We recommend using category 7 cables.

Connecting the receiver to the network using the wireless LAN antenna (for wireless LAN connections only)

The following illustration is an example configuration of a home network with the receiver and a server.

We recommend that you connect the server to the router with a wired connection.

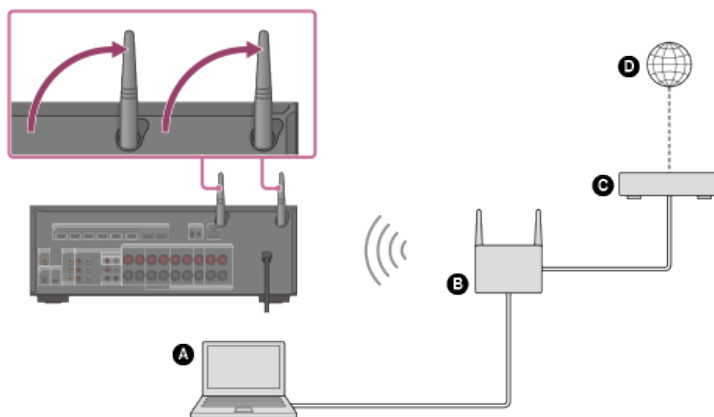

- A** Server (computer, etc.)

- ⓑ Router
- ⓒ Modem
- ⓓ Internet

Note

- Audio playback on a server may occasionally be interrupted if you use a wireless connection.

[44] Preparation | 6. Turning on the receiver/preparing the remote control

Inserting batteries into the remote control

Insert two R03 (size AAA) batteries (supplied) into the remote control. Make sure that the + and – ends are in the correct position when installing batteries.

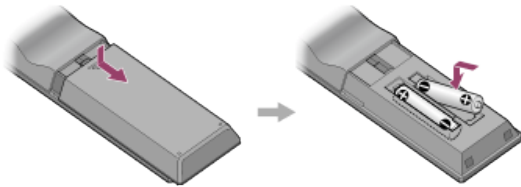

Note

- Do not leave the remote control in an extremely hot or humid place.
- Do not use a new battery with an old one.
- Do not mix manganese batteries with other kinds of batteries.
- Do not expose the remote control sensor to direct sunlight or lights. Doing so may cause a malfunction.
- If you do not intend to use the remote control for an extended period of time, remove the batteries to avoid possible damage from battery leakage and corrosion.
- When the receiver no longer responds to the remote control, replace both of the batteries with new ones.

[45] Preparation | 6. Turning on the receiver/preparing the remote control

Turning on the receiver

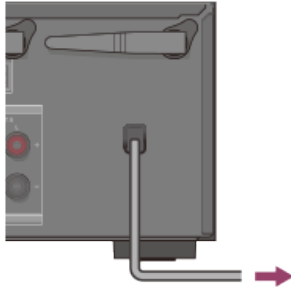

Before connecting the AC power cord (mains lead), be sure to make connections with speakers and the other devices.

- 1 Connect the AC power cord (mains lead) to a wall outlet.



2 Press  (power) to turn on the receiver.



You can also turn on the receiver using  (power) on the remote control. To turn off the receiver, press  (power) again.

[46] Preparation | 7. Setting up the receiver using Easy Setup

Setting up the receiver using Easy Setup

When you turn on the receiver for the first time or after the receiver is initialized, the Easy Setup screen appears on the TV screen. You can set up the following settings for the receiver by following the instructions on the Easy Setup screen.

- **Select your language (for USA, Canadian, European and Australian models only)**
Select the language of messages on the screen.
- **Speaker Settings**
Check your speaker system and perform automatic calibration according to the configuration and arrangement of your speaker system.
- **Internet Settings**
Select the network connection method and configure settings to connect the receiver to the network.

Note

- Switch the input of the TV to the input to which the receiver is connected to use this function.
- Auto Calibration is not available when [Bluetooth Mode] is set to [Transmitter].

If the Easy Setup screen does not appear or you want to display the Easy Setup screen manually, you can display it by selecting [Setup] - [Easy Setup] from the home menu.

1. About Auto Calibration

Auto Calibration allows you to perform automatic calibration as follows.

- Check the connection between each speaker and the receiver.
- Adjust the speaker level.
- Measure the distance of each speaker from your seating position. (*1)
- Measure the speaker size. (*1)
- Measure the frequency characteristics (EQ). (*1)
- Measure the frequency characteristics (Phase). (*1)(*2)

*1 The measurement result is not utilized when [Direct] is selected for the sound field setting and an analog input is selected.

*2 The measurement result may be not utilized, depending on the audio formats.

Note

- The D.C.A.C. is designed to achieve proper sound balance for your room. However, you can adjust the speaker levels manually according to your preference using [Test Tone] in the [Speaker Settings] menu.

2. Before you perform Auto Calibration

Before you perform Auto Calibration, check the following items:

- Set up and connect the speakers.
- Do not connect any microphones other than the supplied calibration microphone to the CALIBRATION MIC jack.
- If using a bi-amplifier connection or a front B speaker connection, set the assignment for the SPEAKERS SURROUND BACK/HEIGHT terminals properly.
- Set the speaker output to a setting other than [SPK OFF].
- Disconnect the headphones.
- Remove any obstructions between the calibration microphone and the speakers.
- For accurate measurement, make sure the environment is quiet and free from noise.

Note

- Auto Calibration is not available when [Bluetooth Mode] is set to [Transmitter].
 - The speakers emit very loud sound during the calibration and the volume cannot be adjusted. Be considerate of your neighbors and any children who are present.
 - If the muting function has been activated before you perform Auto Calibration, the muting function will shut off automatically.
 - It may not be possible to take the correct measurements or to perform Auto Calibration at all if special speakers such as dipole speakers are used.
-

3. Connecting the calibration microphone

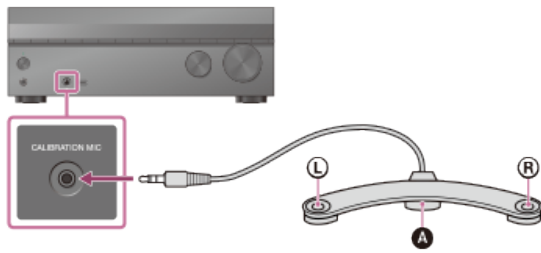

A Calibration microphone (supplied)

1 Connect the supplied calibration microphone to the CALIBRATION MIC jack.

2 Set up the calibration microphone.

Place the calibration microphone at your listening position and set it at the same height as your ears.

Note

- Insert the plug of the calibration microphone all the way into the CALIBRATION MIC jack. If the calibration microphone is not connected securely, measurements may not be made properly.
- Position the calibration microphone horizontally with the L (left) and R (right) ends at the same height.

4. Selecting the front speakers

You can select the front speakers you want to operate.

Be sure to use the buttons on the receiver to perform this operation.

1 Press **SPEAKERS** on the receiver repeatedly to select the front speaker system you want to operate.



The indicators on the display panel shows which set of terminals are selected.

- **SPA:**
Speakers connected to the SPEAKERS FRONT A terminals.
- **SPB (*):**
Speakers connected to the SPEAKERS SURROUND BACK/HEIGHT terminals.
- **SPA+B (*):**
Speakers connected to both the SPEAKERS FRONT A and SPEAKERS SURROUND BACK/HEIGHT terminals (parallel connection).
- **(None):**
[SPK OFF] appears on the display panel. No audio signals are output from any speaker terminals.

* To select [SPB] or [SPA+B], set the assignment for the SPEAKERS SURROUND BACK/HEIGHT terminals to [Front B] by using [Surround Back Speaker Assign] in the [Speaker Settings] menu.

Note

- This setting is not available when headphones are connected.
- When you press SPEAKERS on the receiver, the [Bluetooth Mode] changes to [Receiver] automatically.

[51] Preparation | Performing Auto Calibration

5. Performing Auto Calibration

You can perform automatic calibration from your listening position.

- 1 **Select [Setup] - [Speaker Settings] from the home menu.**
- 2 **Select [Auto Calibration].**
- 3 **When you use height/overhead speakers, select [Change Surround Back Speaker Assign], and then select [Height Speakers] on the next screen.**
- 4 **Select [Proceed to configure the speaker pattern], and then set the speaker pattern on the next screen.**

If you have set [Height/Overhead Speakers] to a value other than [FH] or [---], set [Ceiling Height] on the next screen.
- 5 **Make sure that the calibration microphone is connected to the receiver, and then select [Proceed to the next step].**
- 6 **Confirm the instructions on the screen, then press  to select [Start].**

The measurement starts in 5 seconds.
The measurement process takes approximately 30 seconds. A test tone is output from each speaker in sequence.

When the measurement ends, a beep sounds and the screen switches.

7 Select the item you want.

- **Save:** Saves the measurement results and exits the setting process.
- **Retry:** Performs the Auto Calibration again.
- **Discard:** Exits the setting process without saving the measurement results.

For details on the measurement results, see "[6. Checking Auto Calibration results.](#)"



8 Save the measurement results.

Select [Save] in step 7.

Note

- If the measurement fails, follow the message, then select [Retry]. For details on the error code and warning message, see "[List of messages after Auto Calibration measurements.](#)"
- This setting is not available when headphones are connected.

Hint

- The Auto Calibration measurement will be canceled if you perform the following during the measurement process:
 - Press .
 - Press the input buttons on the remote control or turn INPUT SELECTOR on the receiver.
 - Press HOME, AMP MENU, HDMI OUT or  on the remote control.
 - Press SPEAKERS on the receiver.
 - Change the volume level.
 - Connect headphones.
 - Press MUSIC on the remote control or the receiver.

[52] Preparation | Performing Auto Calibration

6. Checking Auto Calibration results

To check error codes or warning messages received in [Auto Calibration], proceed with the following steps:

If an error code appears

Check the error and perform Auto Calibration again.

1 Select [Retry].

2 Follow the instructions on the TV screen and then press to select [Start].

The measurement starts in a few seconds.

The measurement process takes approximately 30 seconds. A test tone is output from each speaker in sequence.

When the measurement ends, a beep sounds and the screen switches.

3 Select the item you want.

- **Save:** Saves the measurement results and exits the setting process.
- **Retry:** Performs the Auto Calibration again.
- **Discard:** Exits the setting process without saving the measurement results.

4 Save the measurement results.

Select [Save] in step 3.

5 If the Speaker Relocation/Phantom Surround Back screen appears, select the setting you want by referring to “Calibrating speaker positioning (Speaker Relocation/Phantom Surround Back).”

Skip to step 6 if the screen does not appear in the following cases:

- The set speaker pattern does not include surround back speakers but does include surround speakers, and [Surround Speaker Position] is set to [Front].
- [In-Ceiling Speaker Mode] is set to [Front & Center] or [Front].

6 Select the type of calibration you want by referring to “Selecting the Auto Calibration type (Calibration Type).”

7 When [Do you want to activate Calibration Matching?] appears on the screen, select [Yes] or [No].

- Yes: Expands the sweet spot for the viewing position and allows you to enjoy more natural sound by trimming the wavefront for each pair of left/right speakers.
- No: The measurement results of the Auto Calibration function are applied directly.

8 Select [Finish].

If a warning message appears

Check the warning message and select [OK]. For details on the warning messages, see “[List of messages after Auto Calibration measurements.](#)”

Hint

- The measurement results may vary depending on the position of the subwoofer. However, continuing to use the receiver with that value does not cause problems.

Enjoying video and sound

This topic explains the operations you can use to enjoy movies and music with this receiver. For example, you can use multiple devices with this receiver as shown below.

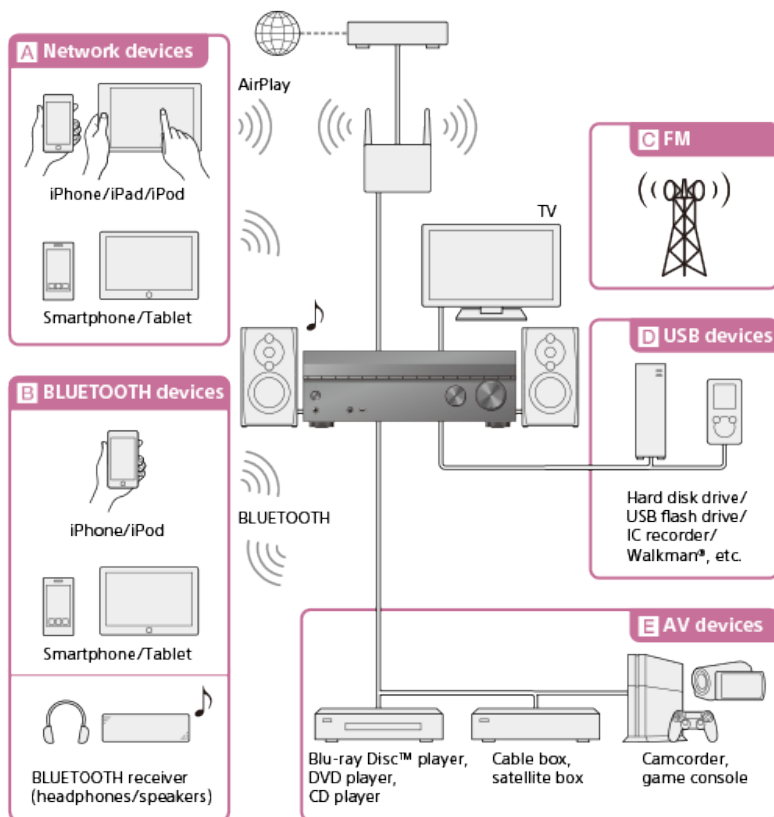

A Network devices

Enjoying audio content from an iPhone/iPad/iPod or other smartphone/tablet

You can send content such as audio from an iPhone/iPad/iPod or other smartphone/tablet to the receiver via the network.

Enjoying audio content from iTunes or an iPhone/iPad/iPod via the network (AirPlay)

B BLUETOOTH devices

Enjoying audio content from an iPhone/iPod or other smartphone/tablet

You can transmit audio from an iPhone/iPod or other smartphone/tablet to the receiver via BLUETOOTH.

Enjoying audio content using the BLUETOOTH function (Pairing operation)

Listening with BLUETOOTH receiver (headphones/speakers)

The BLUETOOTH TX function lets you enjoy listening to audio using BLUETOOTH headphones/speakers. This function does not need cables, so you can choose where you want to listen to music without worrying about cables.

Listening with BLUETOOTH headphones/speakers (Pairing operation)

C FM

Listening to FM radio

You can listen to FM broadcasts in high-quality sound through the built-in tuner.

Preset function enables you to store up to 30 of your favorite FM stations as presets.

Listening to FM radio

D USB devices

Enjoying content from a USB device

You can enjoy music from a USB device such as an external hard disk, USB flash drive or Walkman® by connecting it to the ψ (USB) port on the front panel of the receiver and listening

through speakers or headphones connected to the receiver.

The receiver is compatible with High Resolution Audio, which means you can enjoy high resolution audio from compatible devices without the loss of sound quality.

[Enjoying music stored on a USB device](#)

E AV devices

Enjoying movies or audio from an AV device such as a Blu-ray Disc player, CD player, satellite box or game console

You can connect AV devices to the receiver to enjoy a wide range of content such as movies and audio.

As the receiver is equipped with an HDCP 2.2-compatible HDMI jack, you can also enjoy 4K content via streaming services, satellite broadcasts, etc.

[Enjoying video/sound from the connected device](#)

[54] Enjoying Video and Sound | Playing AV devices

Using the menu on the TV screen

You can display the menu of the receiver on the TV screen (*).

* When you want to display the menu on the TV screen connected to the HDMI OUT B/HDMI ZONE jack, set [HDMI Out B Mode] to [Main].

1 Switch the input of the TV to the input to which the receiver is connected.

2 Press HOME to display the home menu on the TV screen.

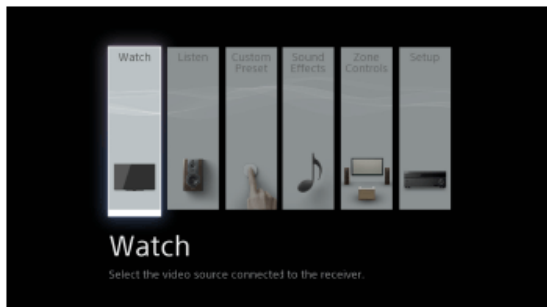

3 Press **←/→** repeatedly to select the menu you want, then press **+** to enter the menu.

Home menu items

Watch : Select to display video from the connected device.

Listen : Select to listen to sound from the built-in FM tuner or the connected device.

Custom Preset : Select to save various settings for the receiver and recall those settings.

Sound Effects : Select to enjoy sound effects.

Zone Controls (*): Select to use the multi-zone features.

Setup : Select to adjust the various settings for the receiver.

* This item is not displayed if [Zone Controls] is set to [Hide] in the [Zone Settings].

Hint

- When [OPTIONS] appears in the lower left portion of the TV screen, you can display the function list by pressing OPTIONS and selecting a related function.

- To return to the previous screen, press BACK.
- To exit the menu, press HOME to display the home menu, then press HOME again.

[55] Enjoying Video and Sound | Playing AV devices

Enjoying video/sound from the connected device

1 Switch the input of the TV to the input to which the receiver is connected.

2 Press HOME.

The home menu is displayed on the TV screen.

Depending on the TV, the home menu may take some time to appear on the TV screen.

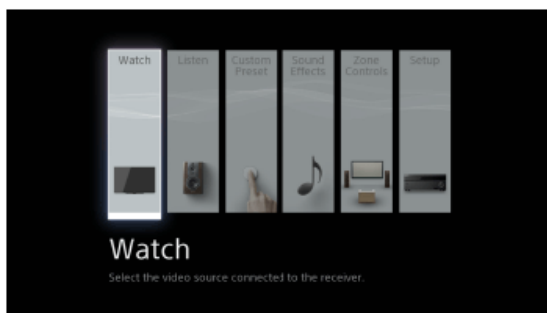

3 Select [Watch] or [Listen] from the home menu.

The menu item list appears on the TV screen.

4 Select the device you want.

5 Turn on the device and start playback.

6 Press \triangle +/- to adjust the volume.

You can also use MASTER VOLUME on the receiver.

7 Press 2CH/MULTI, MOVIE, MUSIC or FRONT SURROUND to enjoy the surround sound.

You can also use 2CH/MULTI, MOVIE or MUSIC on the receiver.

Note

- Before you turn off the receiver, be sure to turn down the volume level to avoid damaging your speakers the next time you turn on the receiver.

Hint

- You can turn INPUT SELECTOR on the receiver or press the input buttons on the remote control to select the device you want.
- You can adjust the volume differently using the MASTER VOLUME knob on the receiver or the \triangleleft +/- buttons on the remote control.
To turn the volume up or down quickly, perform the following:
 - Turn the knob quickly.
 - Press and hold one of the buttons.To make fine adjustments, perform the following:
 - Turn the knob slowly.
 - Press one of the buttons and release it immediately.

[56] Enjoying Video and Sound | Playing AV devices

Enjoying sound of a TV compatible with the Audio Return Channel (ARC) function

If the receiver is connected to a TV's HDMI input jack compatible with the Audio Return Channel (ARC) function, you can listen to TV sound from the speakers connected to the receiver without connecting an optical digital cable or an audio cable.

Set the receiver by the following procedure to output the sound of the TV from the speakers connected to the receiver.

- 1 Select [Setup] - [HDMI Settings] from the home menu.
- 2 Select [Control for HDMI].
- 3 Select [On].

If you connect to a TV that is not compatible with the Audio Return Channel (ARC) function or you want to select an audio signal using a cable other than an HDMI cable (e.g. via an optical digital cable or an audio cable)

1. Select [Setup] - [Input Settings] from the home menu.
2. Adjust [Input Mode] for the input to which the TV is connected based on the connection method you are using.

Note

- Be sure to turn off the volume of the TV or activate the muting function of the TV.
- If your TV does not support the System Audio Control function, set [Audio Out] to [TV + AMP] in the [HDMI Settings] menu to output the sound of the TV from the TV speaker and the speakers connected to the receiver.
- The Audio Return Channel (ARC) function may work on other devices than those manufactured by Sony. However, operation is not guaranteed.

Watching HDCP 2.2 copyright-protected content

To watch HDCP 2.2 copyright-protected content such as 4K content, connect the receiver and TV via an HDCP 2.2-compatible HDMI jack. You can only view copyright-protected 4K content through the HDCP 2.2-compatible HDMI jack connection. For details on whether the TV and 4K devices are equipped with an HDCP 2.2-compatible HDMI jack, refer to the operating instructions of the TV and 4K devices.

Enjoying audio content from iTunes or an iPhone/iPad/iPod via the network (AirPlay)

You can play audio content on an iPhone, iPad, iPod or in an iTunes Library on your computer with this receiver via a wireless network.

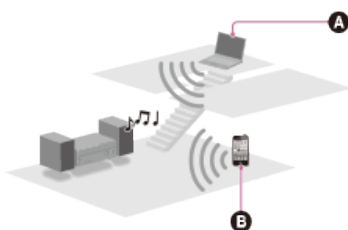





- A** Computer
- B** iPhone/iPad/iPod

- 1** Tap/click the AirPlay icon (📶, etc.) on the iPhone/iPad/iPod screen or iTunes window.
- 2** Select [STR-DN1080 XXXXXX] (*) on the AirPlay menu of iTunes or your iPhone/iPad/iPod.
- 3** Start playing back audio content on an iPhone/iPad/iPod or in iTunes.

* XXXXXX is the identification number for each unit.

Controlling AirPlay playback

You can use the , , , ,  buttons on the remote control when the receiver is selected as the device for output.

Note

•

Update the iPhone/iPad/iPod or iTunes to the latest version before using with the receiver.

- Refer to the operating instructions of your device for details on operating the iPhone/iPad/iPod, iTunes or AirPlay.

Hint

- If the playback does not start, perform the process again from step 1.
- Very loud sound may output from the receiver if you set the volume loud on an iPhone/iPad/iPod or iTunes.
- It may not be possible to link the volume level of an iPhone/iPad/iPod or iTunes with the volume level of this receiver.

[59] Enjoying Video and Sound | Playing content from an iPhone/iPad/iPod

Enjoying audio content using the BLUETOOTH function (Pairing operation)

Pairing is an operation where BLUETOOTH devices are registered to each other before connection. Once a pairing operation is performed, it does not need to be performed again. Be sure to set the [Bluetooth Mode] to [Receiver] before pairing a device with this receiver.

- 1 Place the BLUETOOTH device within 1 meter (3.3 feet) of the receiver.**
- 2 Press and hold CONNECTION  PAIRING BLUETOOTH on the receiver to select the BLUETOOTH function.**

[PAIRING] flashes on the display panel. Perform step 3 within five minutes, otherwise pairing will be canceled. If pairing is canceled, repeat this step.
- 3 Perform pairing on the BLUETOOTH device to detect this receiver.**

For details, refer to the operating instructions of your BLUETOOTH device.
A list of detected devices may appear on the BLUETOOTH device display depending on the type of BLUETOOTH device. This receiver is displayed as [STR-DN1080 XXXXXX] (*).
- 4 Select [STR-DN1080 XXXXXX] (*) on the BLUETOOTH device display.**

If [STR-DN1080 XXXXXX] (*) is not displayed, repeat this process from step 1.
When the BLUETOOTH connection is established, the paired device name appears and [BT] lights up on the display panel.
- 5 Start playback on the BLUETOOTH device.**
- 6 Adjust the volume.**

Adjust the volume of the BLUETOOTH device first. If the volume level is still too low, adjust the volume level of the receiver.

* XXXXXX is the identification number for each unit.

Canceling pairing operation

Pairing operation will be canceled when you switch the input.

Note

- Some applications of BLUETOOTH device cannot be controlled from the receiver.
- If a passkey is required on the display of the BLUETOOTH device in step 4, enter [0000]. The passkey may be called "Passcode," "PIN code," "PIN number" or "Password."
- You can pair up to 9 BLUETOOTH devices. If a 10th BLUETOOTH device is paired, the least recently connected device will be replaced by the new one.
- CONNECTION **■** PAIRING BLUETOOTH on the receiver does not work when the [Bluetooth Mode] is set to [Off].

Hint

- You can change the name of the receiver that appears on your device in [Device Name] in the [System Settings] menu.

[60] Enjoying Video and Sound | Playing content from an iPhone/iPad/iPod

Compatible iPhone/iPad/iPod models

You can use the following iPhone/iPad/iPod models on this receiver. Update your iPhone/iPad/iPod with the latest software before using it.

BLUETOOTH technology works with

- **iPhone:**
iPhone 7 Plus/iPhone 7/iPhone SE/iPhone 6s Plus/iPhone 6s/iPhone 6 Plus/iPhone 6/iPhone 5s/iPhone 5c/iPhone 5/iPhone 4s
- **iPod touch:**
iPod touch (5th and 6th generation)

AirPlay works with

- **iPhone:**
iPhone 7 Plus/iPhone 7/iPhone SE/iPhone 6s Plus/iPhone 6s/iPhone 6 Plus/iPhone 6/iPhone 5s/iPhone 5c/iPhone 5/iPhone 4s
- **iPad:**
iPad Pro (12.9-inch)/iPad Pro (9.7-inch)/iPad Air 2/iPad Air/iPad mini 4/iPad mini 3/iPad mini 2/iPad mini/iPad (4th and 3rd generation)/iPad 2
- **iPod touch:**
iPod touch (5th and 6th generation)

AirPlay works with iPhone, iPad, and iPod touch with iOS 4.3.3 or later, Mac with OS X Mountain Lion or later, and PC with iTunes 10.2.2 or later.

Enjoying music stored on a USB device

You can enjoy music from a USB device by connecting it to the ψ (USB) port on the receiver.

1 Select [Listen] - [USB (Connected)] from the home menu.

The same operation can also be performed by pressing USB on the remote control.

2 Select the track you want from the file list.

The selected track starts playing and the information of track appears on the TV screen.

Operating the USB device using the remote control

You can operate the USB device using the remote control of the receiver.

Press USB before you use the following buttons:

- **▶||**: Starts or pauses playback.
- **■**: Stops playback.
- **◀◀/▶▶**: Moves to the start of the previous/current or next track. Press and hold to perform fast forward or fast reverse the current track.

Setting playback modes using the options menu

You can set the following playback modes by pressing OPTIONS after step 2.

- **Auto Playback:** If this is set to [On], music files stored on the connected USB device will start playing automatically when you press USB.
- **Repeat Setting:** You can set the following repeat playback modes for music files stored on the USB device:
 - **All:** Plays back all files on the USB device repeatedly.
 - **Folder:** Plays back all files in the selected folder (including subfolders) repeatedly.
 - **Track:** Plays back only the selected file repeatedly.
 - **Off:** Plays back all files in the selected folder and stops playback with the last file.
- **Shuffle Setting:** If this is set to [On], music files stored on the connected USB device will be played back in the shuffle playback mode. The files targeted for shuffle playback are based on the setting for [Repeat Setting].

Note

- The receiver can recognize the following files or folders in USB devices:
 - up to folders in the 9th layer (including the root folder)
 - up to 500 files/folders in a single layer
- To listen to music files stored on your Walkman, you need to drag and drop the files in formats supported by the receiver (such as MP3) from your computer to the Walkman. However, music files transferred to the Walkman using Media Go can be played back on the receiver because the files are stored in the [Music] folder.
- Audio content with DRM (Digital Rights Management) copyright protection cannot be played on this receiver.

USB specifications and compatible USB devices

Playable types of audio files (*1)

MP3 (MPEG 1 Audio Layer-3) (*2):

.mp3

AAC/HE-AAC (*2):

.m4a, .aac, .mp4, .3gp

WMA9 Standard:

.wma

WMA 10 Pro (*3):

.wma

LPCM (*2):

.wav

FLAC:

.flac, .fla

Dolby Digital (*2):

.ac3

DSF:

.dsf

DSDIFF (*4):

.dff

AIFF:

.aiff, .aif

ALAC:

.m4a

Vorbis:

.ogg

Monkey's Audio:

.ape

*1 Compatibility with all encoding/writing software, recording devices and recording media cannot be guaranteed.

*2 The receiver can play “.mka” files.

*3 The receiver does not play coded files such as Lossless.

*4 The receiver does not play DST encoded files.

Note

- Some files may not play depending on the file format or the file encoding.
- Some files that have been edited on a computer may not play.
- Fast forward or fast reverse functions may not be available for some files.
- The receiver does not play coded files such as DRM.
- The receiver can recognize the following files or folders in USB devices:
 - up to folders in the 9th layer (including the root folder)
 - up to 500 files/folders in a single layer
- Some USB devices may not work with this receiver.
- The receiver can recognize Mass Storage Class (MSC) devices (such as flash drive or an HDD) and 101-key keyboards.

Compatible USB device

Mass Storage Class, High-speed type

Maximum current

1 A

Verified Sony USB devices

USB devices manufactured by Sony that have been confirmed as usable are as follows:

Walkman:

NW-A16

NW-A25/A25HN/A26HN/A27HN/ZX100

NW-A35/A35HN/A36HN/A37HN/WM1A/WM1Z

NW-E062/E063

NW-E083

NW-E393/E394/E395

NW-F887/F800 series

NW-M504/M505

NW-S14/S15

NW-S774/S775/S776

NW-S784/S785/S786

NW-W274S

NW-WH303

NW-WH505

NW-WS413/WS414

NW-WS615

NW-WS623/WS625

NW-ZX1

NW-ZX2

NWZ-A15

NWZ-B162/B162F/B163F

NWZ-B172/B172F/B173/B173F

NWZ-B183F

NWZ-E053

NWZ-E363/E364/E365

NWZ-E373/E374/E375

NWZ-E383/E384/E385

NWZ-E454

NWZ-E463/E464/E465

NWZ-E473/E475

NWZ-E583/E584/E585

NWZ-F805N

NWZ-F885/F800 series

NWZ-S774BT

NWZ-W252

NWZ-W274S

NWZ-WH303

NWZ-WH505

NWZ-WS613

NWZ-Z1050

MICROVAULT (USB flash drive manufactured by Sony):

USM16GQX/USM128GQX

USM4GP/USM32GP

USM8GT/USM64GT

USM64GU

USM8GV

Digital Voice Recorder:

ICD-FX88

ICD-PX232

ICD-PX240

ICD-PX333/PX333D/PX333M

ICD-PX370/PX470/PX470F

ICD-PX440

ICD-SX733/SX734/SX1000

ICD-SX2000

ICD-TX650

ICD-UX533/UX534F

ICD-UX543/UX543F/UX544F

ICD-UX560F

ICZ-R51

ICZ-R100

ICZ-R250TV

PCM-D100

External Hard Drive:

HD-D2B

HD-E2

HD-S1A

Note

- Some of these USB devices may not be available for purchase in certain areas.
- The receiver is unable to read data other than that saved in the first partition of a hard disk drive.
- Operation of models not listed here is not guaranteed.
- Operation may not always be guaranteed even when using these USB devices.
- When formatting the above models, be sure to format using the model itself or the dedicated formatting software for that model.
- When connecting a USB device to the receiver, be sure to connect after the display “Creating Library” or “Creating Database” on the USB device has disappeared.

[63] Enjoying Video and Sound | Playing content from a USB device

Notes on USB devices

- Do not remove a USB device during operation. To avoid data corruption and damage to the USB device, turn the receiver off when removing a USB device.
- Do not connect a USB device to the receiver through a USB hub.
- The receiver can recognize the following files or folders in USB devices:
 - up to folders in the 9th layer (including the root folder)
 - up to 500 files/folders in a single layer

The maximum number of files and folders may vary depending on the file and folder structure. Do not save other types of files or unnecessary folders on a USB device.

- Compatibility with all encoding/writing software, recording devices, and recording media cannot be guaranteed. Incompatible USB devices may produce noise or interrupted audio or may not play at all.
- Some time may be needed to start playback when:
 - the folder structure is complex.
 - the memory capacity is excessive.
- This receiver does not necessarily support all of the functions provided in a connected USB device.
- The playback order for the receiver may differ from the playback order of the connected USB device.
- If a folder that has no files is selected, [No playable file in this category.] appears.
- When playing a very long track or a track with a large file size, some operations may cause delays in playback.

[64] Enjoying Video and Sound | Listening to the radio





Listening to FM radio

You can listen to FM broadcasts through the built-in tuner. Be sure that the TV and FM antenna (aerial) is connected to the receiver before performing this operation.

1 Select [Listen] - [FM TUNER] from the home menu.

The FM screen appears.

FM screen

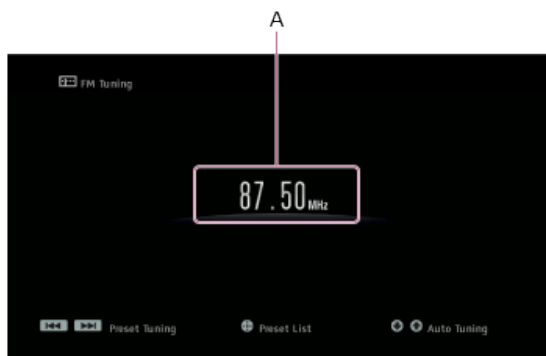

You can select and operate each item on the screen by pressing /// and .



A: Frequency indication

Shows the frequency of the station which the tuner is receiving.

Hint

- You can also press FM on the remote control to display the FM screen.
- If you have already preset stations, you can select the station you want through either of the following operations:
 - Press  in step 1 to display the Preset List screen, and then select a station from the list.
 - Press PRESET +/- repeatedly to select the station.
- You can also perform auto-tuning through either of the following operations:
 - Press and hold PRESET +/-.
 - Press / repeatedly.

You can perform the following operations from the menu that is displayed when you press OPTIONS:

- Direct Tuning
- Preset Memory
- Preset Name Input
- Switching FM Mode

[65] Enjoying Video and Sound | Listening to the radio

Presetting FM radio stations (Preset Memory)

You can store up to 30 FM stations as your favorite stations.

1 Select [Listen] - [FM TUNER] from the home menu.

The FM screen appears.

2 Tune to the station that you want to preset.

3 Press OPTIONS.

4 Select [Preset Memory] from the options menu.

The Preset Memory screen appears.

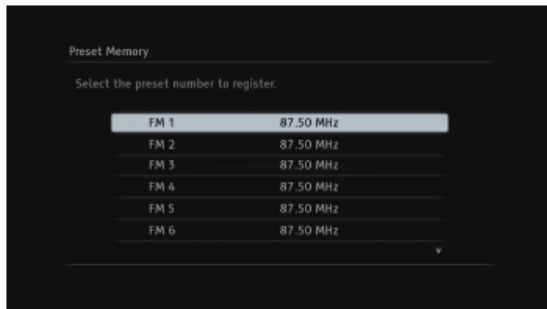

5 Select a preset number.

The station is stored as the selected preset number.

6 Repeat steps 2 to 5 to store another station.

You can store stations as follows:

- FM band: FM 1 to FM 30

Listening to the preset station

Press  to display the Preset List screen, and then select a station you want.





[66] Enjoying Video and Sound | Listening to the radio

Naming preset stations (Preset Name Input)

- 1 Select [Listen] - [FM TUNER] from the home menu.**
- 2 Press OPTIONS.**

The options menu appears.
- 3 Select [Preset Name Input].**

A preset list appears on the TV screen.
- 4 Select the preset number to which you want to assign a name.**

An on-screen keyboard appears on the TV screen.
- 5 Press /// and  to select characters one by one to enter the name.**
- 6 Select [Enter].**

The name you entered is registered.

Canceling naming input

Press BACK.

Note

- Some letters that can be displayed on the TV screen cannot be displayed on the display panel.

[67] Enjoying Video and Sound | Listening to the radio

Tuning to a station directly (Direct Tuning)

You can enter the frequency of a station directly.

1 Select [Listen] - [FM TUNER] from the home menu.

2 Press **OPTIONS**.

The options menu appears.

3 Select [Direct Tuning].

4 Enter the frequency using **▲/▼/◀/▶**.

1. Press **◀/▶** to select a digit.
2. Press **▲/▼** to change the digit.

5 Press **⏏**.

Note

- If the tuned frequency is invalid or out of range, [---.--- MHz] appears and then the screen returns to the current frequency.
Make sure you have entered the right frequency. If not, repeat steps 4 and 5. If you still cannot tune to a station, the frequency may not be in use in your area.

Hint

- The tuning scale for direct tuning is shown below:
 - **USA and Canadian models:**
100 kHz
 - **Other models:**
50 kHz

[68] Enjoying Video and Sound | Listening to the radio

Receiving RDS broadcasts (for European and Asia-Pacific models only)

This receiver allows you to use Radio Data System (RDS), which enables FM radio stations (*) to send additional information along with the regular programming signal. This receiver offers convenient RDS features, such as Program Service name display.

* Not all FM stations provide RDS service, nor do they provide the same type of services. If you are not familiar with the RDS services in your area, check with your local radio stations for details.

1 Select [Listen] - [FM TUNER] from the home menu.



2 Select a station.

When you tune to a station that provides RDS services, the Program Service name appears on the display panel.

Note

- RDS may not work properly if the station you tuned to does not transmit the RDS signal or if the signal strength is weak.
- Some letters that can be displayed on the TV screen cannot be displayed on the display panel.

Hint

- You can check the frequency while a Program Service name is displayed by pressing DISPLAY MODE on the receiver repeatedly.

[69] Enjoying Video and Sound

Enjoying content stored on a server on the home network (DLNA)

You can enjoy music files stored on a server on the home network using the receiver. The server may require some settings to be configured to allow the receiver to play music files from the server. For details, refer to the operating instructions or help of the respective devices or applications.

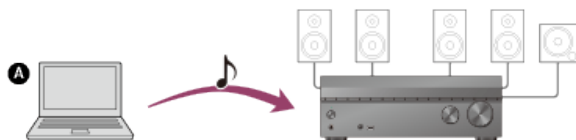

A Server (computer, etc.)

1 Select [Listen] - [Home Network] from the home menu.

A list of available servers appears on the TV screen.

If the last selected item (playlist, album, folder, etc.) appears on the TV screen, press BACK to return to the server list.

If there are no available servers, press OPTIONS in the [Connection Server Settings] screen in the [Network Settings] menu and then select [Update Server List].

2 Select the server.

The content list appears on the TV screen.

3 Select the item you want.

Repeat this step to narrow down the choices until the item you want appears. The items that are displayed depend on the server you are connected to.

4 Select the file you want to play.

Playback starts.

Setting playback modes using the options menu

You can set the following playback modes by pressing **OPTIONS** after step 4.

- **Repeat Setting:** You can set the following repeat playback modes for music files stored on the server:
 - **Folder:** Plays back all files in the selected folder repeatedly.
 - **Track:** Plays back only the selected file repeatedly.
 - **Off:** Plays back all files in the selected folder and stops playback with the last file.
- **Shuffle Setting:** If this is set to [On], music files stored on the server on the home network will be played back in the shuffle playback mode. The files targeted for shuffle playback are based on the setting for [Repeat Setting].

Note

- The receiver can recognize the following files or folders stored in the home network server:
 - up to folders in the 19th layer
 - up to 999 files/folders in a single layer
- Audio content with DRM (Digital Rights Management) copyright protection cannot be played on this receiver.
- There may be some tracks that cannot be played on this receiver.

Hint

- If the server device supports the Wake-on-LAN, the receiver turns the server on automatically in step 2. If the server does not support the Wake-on-LAN, turn on the server in advance. For details on the Wake-on-LAN settings or operations of your server, refer to the operating instructions or help of your server.

[70] Enjoying Video and Sound | Enjoying internet music services

Enjoying music services offered on the Internet

You can listen to music services offered on the Internet with this receiver.

To use this function, you need to connect the receiver to the Internet and then follow the guide that is displayed after the following steps.

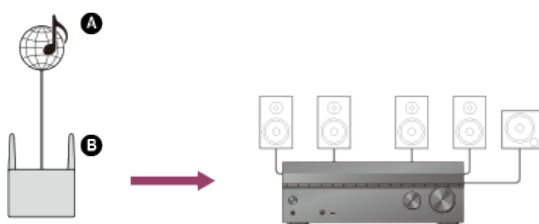

A Internet

B Router

1 Select [Listen] - [Music Service List] from the home menu, or press MUSIC SERVICE.

The service provider list appears on the TV screen.

You can update the service provider list by pressing OPTIONS, followed by select [Update Services].

2 Select the music service you want.

A guide to enjoying that music service will appear on the TV screen. Follow the instructions in the guide.

Note

- Available services may vary depending on your location.

Hint

- If you have been playing the music on the receiver using Spotify Connect, you can resume Spotify playback by pressing MUSIC SERVICE.

[71] Enjoying Video and Sound

Using Chromecast built-in™ to enjoy audio content from a smartphone or tablet device

You can play back audio/music content selected in a Chromecast-enabled app on a mobile device by activating the Chromecast built-in function. You can also listen to the same music in multiple rooms if you register devices that support the Chromecast built-in function such as the receiver and wireless speakers located in another room, to a group in advance.

For details, refer to the following Chromecast website:

g.co/cast/audiolearn

1 Select [Listen] - [Music Service List] from the home menu.

The music service list appears on the TV screen.

2 Select [Chromecast built-in] to activate the function.

Perform the settings to use Chromecast built-in on the receiver by following the on-screen instructions.

Once the settings are configured, [Network Standby] is set to [On] automatically, and you can quickly start up the receiver from standby mode to play music (for USA, Canadian and Asia-Pacific models only).

3 Connect the mobile device to the same network as that of the receiver.

4 Install the Chromecast-enabled app to the mobile device.

5 Start the Chromecast-enabled app, tap the cast button, and select [STR-DN1080 XXXXXX] (*) or group in which [STR-DN1080 XXXXXX] (*) is included.



6 Select and play music on the Chromecast-enabled app.

The music is played back on the receiver or on each device in the selected group.

* XXXXXX is the identification number for each unit.

Note

- While playing music using the Chromecast built-in function, you can only select [Multi Ch Stereo] or [2ch Stereo] by pressing 2CH/MULTI on the remote control or the receiver. You cannot select other sound fields.
- Chromecast built-in and the Chromecast-enabled app may not be available in some countries/regions.

[72] Enjoying Video and Sound

Using Spotify Connect to enjoy music

You can select the music on the Spotify app and play it on the receiver. To play on the receiver, you need the Spotify Premium account.

1 Connect the mobile device by Wi-Fi to the same network as that of the receiver.

2 Install the Spotify app to the mobile device.

3 Start the Spotify app and log in to the Spotify Premium account.

4 Select and start playing the music on the Spotify app.

5 Select the connect icon on the Spotify app and select this receiver as the audio output device.

The music is played.

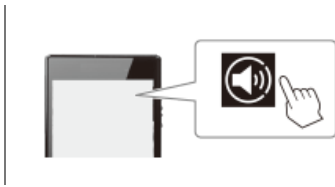

Resuming the music that has played on the mobile device

Press MUSIC SERVICE on the remote control.

If you have been playing the music on the receiver using Spotify Connect, you can resume Spotify playback.

Note

- Set [Network Standby] to [On] in the [Network Settings] menu before using Spotify Connect. When [On] is selected, you can quickly start up the receiver from standby mode to play music (for USA, Canadian and Asia-Pacific models only).
- The Spotify app may not be available in some countries/regions.

[73] Enjoying Video and Sound

Enjoying audio content stored on a BLUETOOTH device with a one-touch connection (NFC)

You can enjoy audio content on a BLUETOOTH device with a one-touch connection using the NFC function.

- 1 If you are using an NFC-compatible BLUETOOTH device with Android OS 4.0 or earlier, download the “NFC Easy Connect” application to your device.



You do not need to install the “NFC Easy Connect” application if you are using an NFC-compatible BLUETOOTH device with Android OS 4.1 or later installed.

- 2 Touch the **N** mark on the receiver with your BLUETOOTH device.

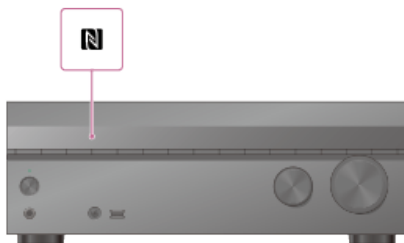

- 3 Follow the on-screen instructions displayed on the BLUETOOTH device, and complete the procedure for BLUETOOTH connection.

4 Check that the connection is completed and [BT] lights up on the display panel.

5 Start playback on the BLUETOOTH device.

6 Adjust the volume.

Adjust the volume of the BLUETOOTH device first. If the volume level is still too low, adjust the volume level of the receiver.

Compatible smartphones

Smartphones with the NFC function (compatible OS: Android 2.3.3 or later, excluding Android 3.x)

Note

- [Bluetooth Mode] will be set to [Receiver] automatically after step 2.
- This function does not work while the Software Update screen is displayed.
- The receiver does not support BLUETOOTH receiver (headphones/speakers) with NFC function.

Hint

- If you want to connect a BLUETOOTH device when the receiver is in standby mode, set [Network Standby] to [On] in the [Network Settings] menu (for USA, Canadian and Asia-Pacific models only).

[74] Enjoying Video and Sound | Enjoying sound effects

Selecting a sound field (Sound Field)

You can select from a variety of sound field modes according to speaker connections or input sources.

1 Select [Sound Effects] - [Sound Field] from the home menu.

2 Select the sound field you want.

For movies, a sound field labeled with [Movie] is recommended.
For music, a sound field labeled with [Music] is recommended.

Note

- You cannot select sound fields in the following cases:
 - [Bluetooth Mode] is set to [Transmitter].
 - The Wireless Multi-Room function is activated.

- When connecting headphones to the receiver, [Headphone(2ch)] is selected as a sound field automatically.
- The sound fields for movie and music may not work, depending on the input or the speaker pattern you select, or with audio formats.
- While playing music using Chromecast built-in, you can only select [Multi Ch Stereo] or [2ch Stereo] by pressing 2CH/MULTI on the remote control or the receiver. You cannot select other sound fields.
- The receiver may play signals at a lower sampling frequency than the actual sampling frequency of the input signals, depending on the audio format.
- Some speakers or the subwoofer may not output sound, depending on the sound field setting.

Hint

- You can also use 2CH/MULTI, MOVIE, MUSIC or FRONT SURROUND on the remote control to select a sound field. However, if the input other than [USB], [Bluetooth], [Home Network] and [Music Service List] (when music is played back using Spotify Connect) is selected, [Audio Enhancer] cannot be selected when you press MUSIC.
- You can also select [Sound Field] in the [Audio Settings] menu.

[75] Enjoying Video and Sound | Enjoying sound effects

Selectable sound fields and their effects

Sound field		Display panel	Effects of the sound field
2CH/MULTI	2ch Stereo	2CH STEREO	Plays back 2-channel audio signals without adding any surround effect. Monaural and multi-channel audio signals are output after being converted into a 2-channel signal. This sound field is best suited for playing back audio signals as they are from two front speakers only, without adding any virtual surround effect. The sound is output from the front left/right speakers only. There is no sound from the subwoofer.
	Multi Ch Stereo	MULTI ST.	Outputs sound from all connected speakers. When 2-channel or monaural audio signals are input, the receiver outputs sound from all speakers without adding any surround effect. When multi-channel audio signals are input, sound may not be output from certain speakers depending on the speaker settings or playback content.
	Direct	DIRECT	Plays back all audio signals without adding any surround effect.
	A.F.D. (Auto)		Decodes and plays back audio signals

	Format Decoding)	A.F.D.	using the optimal processing method according to the audio signal input.
MOVIE	Dolby Surround	DOLBY SURR	Dolby Surround upmixer expands traditional audio content for playback through multi-channel speaker configuration, including height speakers. This makes it possible to reproduce height information for sound images even when playing back conventional movie or audio content, providing a more realistic sense of immersion than ever before. This upmixer is a new and enhanced replacement for the Dolby Pro Logic II technology.
	Neural:X	NEURAL:X	Neural:X is a new upmixer technology developed by DTS and remaps stereo, 5.1, and 7.1 movies and music to match your speaker layout. This makes it possible to reproduce height information for sound images even when playing back conventional movie or audio content, providing a more realistic sense of immersion than ever before.
	Front Surround	FRONT SUR.	Reproduces full surround effects with only two front speakers using Sony's virtual signal processing technology.
MUSIC	Audio Enhancer	A. ENHANCER	DSEE HX (Digital Sound Enhancement Engine HX) that is Sony's original technology upscales existing sound sources to near high-resolution sound quality and makes you feel as if you are really at the recording studio or concert. Audio Enhancer only works on 2-channel sound sources with a sampling frequency of 44.1 kHz or 48 kHz input from the following way: <ul style="list-style-type: none"> • USB • Home Network • Music Service List (when music is being played back using Spotify Connect) • Bluetooth <p>However, it does not work during Wireless Multi-Room playback.</p>
Headphones	Headphone(2ch)	HP 2CH	This mode is selected automatically if you use headphones (Other sound fields cannot be selected). Plays back 2-channel audio signals without adding any surround effect. Sound from monaural and multi-channel audio signals are output after being converted into a 2-channel signal.

Note

- Depending on the audio format, if you select [Direct] and play a 5.1ch source when surround speakers and two surround back speakers are connected, the same audio as that from surround speakers will be output from surround back speakers, similar to that of a 7.1ch surround system. The sound level of surround and surround back speakers are adjusted automatically for optimum balance.
- Dolby Atmos is decoded as Dolby TrueHD or Dolby Digital Plus when a sound field other than [Multi Ch Stereo], [A.F.D.] or [Dolby Surround] is selected.
- If an input other than [USB], [Bluetooth], [Home Network], or [Music Service List] (when music is being played back using Spotify Connect) has been selected, [Audio Enhancer] cannot be selected when you press MUSIC.

[76] Enjoying Video and Sound | Enjoying sound effects

Relations between sound fields and speaker outputs

The list below shows which speaker outputs sound when a certain sound field is selected.

Note

- When no sound is heard, check that all the speakers are securely connected to the correct speaker terminals, and the correct speaker pattern is selected.

2-channel content

Sound field		Display panel	Front speakers	Center speaker	Surround speakers	Surround back speakers	Subwoofer	Height speakers
2CH/MULTI	2ch Stereo	2CH STEREO	⊙	-	-	-	-	-
	Multi Ch Stereo	MULTI ST.	⊙	○	○	○	○ (*1)	○
	Direct (Analog input)	DIRECT	⊙	-	-	-	-	-
	Direct (Others)	DIRECT	⊙	-	-	-	○ (*3)	-
	A.F.D. (Auto Format Decoding)	A.F.D.	⊙	●	●	●	○ (*2)	● (*4)
MOVIE	Dolby Surround	DOLBY SURR	⊙	○	○	○	○ (*1)	○
	Neural:X	NEURAL:X	⊙	○	○	○	○ (*1)	○ (*5)
	Front Surround	FRONT SUR.	⊙	-	-	-	○ (*1)	-
MUSIC	Audio Enhancer	A. ENHANCER	⊙	-	-	-	○ (*3)	-

-: No sound is output.

⊙: Outputs sound.

○: Outputs sound depending on the speaker pattern setting and content to be played back.

●: For Dolby and DTS audio streams, outputs sound depending on the speaker pattern setting.

No sound is output for Linear PCM, DSD, or AAC.

*1 Outputs sound if the following conditions are met:

- A subwoofer is connected.
- The speaker pattern is set to a setting ([x.1]) that has a subwoofer.

*2 USA and Canadian models: outputs sound if the following conditions are met:

- A subwoofer is connected.
- The speaker pattern is set to a setting ([x.1]) that has a subwoofer.

Other models: outputs sound if the following conditions are met:

- A subwoofer is connected.
- The speaker pattern is set to a setting ([x.1]) that has a subwoofer.
- [Small] is selected for [Size] in the [Speaker Settings] menu.

*3 Outputs sound if the following conditions are met:

- A subwoofer is connected.
- The speaker pattern is set to a setting ([x.1]) that has a subwoofer.
- [Small] is selected for [Size] in the [Speaker Settings] menu.

*4 For DTS audio streams, no sound is output when the speaker pattern is set to [5.1.2 (TM)], [5.1.2 (FD)], or [5.1.2 (SRD)].

*5 No sound is output when the speaker pattern is set to [5.1.2 (TM)], [5.1.2 (FD)], or [5.1.2 (SRD)].

Multi-channel content

Sound field		Display panel	Front speakers	Center speaker	Surround speakers	Surround back speakers	Subwoofer	Height speakers
2CH/MULTI	2ch Stereo	2CH STEREO	⊙	-	-	-	-	-
	Multi Ch Stereo	MULTI ST.	⊙	○	○	○	○	○ (*1)
	Direct	DIRECT	⊙	○	○	○	○	○ (*1)
	A.F.D. (Auto Format Decoding)	A.F.D.	⊙	○	○	○	○	○ (*1)
MOVIE	Dolby Surround	DOLBY SURR	⊙	○	○	○	○	○
	Neural:X	NEURAL:X	⊙	○	○	○	○	○ (*2)
	Front Surround	FRONT SUR.	⊙	-	-	-	○	-
MUSIC	Audio Enhancer	A. ENHANCER	⊙	○	○	○	○	○ (*1)

-: No sound is output.

⊙: Outputs sound.

○: Outputs sound depending on the speaker pattern setting and the channels included in the input source.

- *1 For DTS audio streams, no sound is output when the speaker pattern is set to [5.1.2 (TM)], [5.1.2 (FD)], or [5.1.2 (SRD)].
- *2 No sound is output when the speaker pattern is set to [5.1.2 (TM)], [5.1.2 (FD)], or [5.1.2 (SRD)].

Note

- When no sound is heard, check that all the speakers are securely connected to the correct speaker terminals and the correct speaker pattern is selected.

[77] Enjoying Video and Sound | Enjoying sound effects

Resetting sound fields to the default settings

Be sure to use the buttons on the receiver to perform this operation.

1 Turn off the receiver.

2 Hold down **MUSIC** and press **⏻** (power) on the receiver.

[S.F. CLEAR] appears on the display panel and all sound fields are reset to their default setting.

[78] Enjoying Video and Sound | Enjoying sound effects

Adjusting the equalizer (Equalizer)

You can use the following parameters to adjust the tonal quality (bass/treble level) of the front, center, surround/surround back and height speakers.

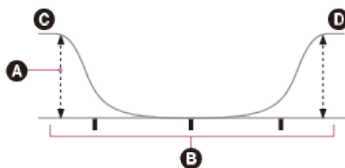

- A** Level (dB)
- B** Frequency (Hz)
- C** Bass
- D** Treble

1 Select [Setup] - [Speaker Settings] from the home menu.

2 Select [Equalizer].

3 Select [Front], [Center], [Surround] or [Height].

4 Select [Bass] or [Treble].

5 Adjust the gain.

Note

- This function does not work in the following cases:
 - [Pure Direct] is set to [On].
 - [Bluetooth Mode] is set to [Transmitter].
 - [DSD Native] is set to [On] and DSD signals are being played back.
- Frequencies for [Bass] and [Treble] are fixed.
- Depending on the audio format, the receiver may play signals at a lower sampling frequency than the original sampling frequency of the input signals.
- Only [Bass] gain and [Treble] gain are available for [Front] when headphones are connected.

Hint

- You can also select [Equalizer] in [Sound Effects] from the home menu. Additionally, you can adjust the equalizer from the [<EQ>] menu on the display panel by pressing AMP MENU.

[79] Enjoying Video and Sound | Enjoying sound effects

Enjoying clear and dynamic sound at a low volume (Sound Optimizer)

You can enjoy clear and dynamic sound at low volume levels using the Sound Optimizer. After the Auto Calibration is performed, the sound level is optimized to suit your environment.

1 Select [Setup] - [Audio Settings] from the home menu.

2 Select [Sound Optimizer].

3 Select the setting you want.

- **Normal:** Adjusts for the reference level of a movie.
- **Low:** Adjusts for a CD or other software whose average sound pressure level is processed highly.
- **Off**

Note

- This function does not work in the following cases:
 - [Pure Direct] is set to [On].
 - Headphones are connected.
 - [Bluetooth Mode] is set to [Transmitter].
 - [DSD Native] is set to [On] and DSD signals are being played back.

[Direct] is being used when [BD/DVD], [GAME], [VIDEO 2], [USB], [Bluetooth], [Home Network] or [Music Service List] is selected, or during AirPlay playback.

- The receiver may play signals at a lower sampling frequency than the actual sampling frequency of the input signals, depending on the audio format.

Hint

- You can also select [Sound Optimizer] in [Sound Effects] from the home menu.

[80] Enjoying Video and Sound | Enjoying sound effects

Enjoying more natural sound with speakers installed in the ceiling (In-Ceiling Speaker Mode)

Set whether or not to use in-ceiling speaker mode with the current input.

In a setup where the front and center speakers are installed in the ceiling, lowering the audio output position to the screen height allows you to enjoy a more natural experience.

- 1 Select [Setup] - [Audio Settings] from the home menu.
- 2 Select [In-Ceiling Speaker Mode].
- 3 Select the setting you want.
 - **Front & Center:** Lowers the audio output position from the front and center speakers installed in the ceiling to the screen height.
 - **Front:** Lowers the audio output position from the front speakers installed in the ceiling to the screen height.
 - **Off:** Does not activate this function.

Note

- This function does not work in the following cases:
 - Headphones are connected.
 - [Bluetooth Mode] is set to [Transmitter].
 - [Pure Direct] is set to [On].
 - The Wireless Multi-Room function is activated.
 - [DSD Native] is set to [On] and DSD signals are being played back.
- This function does not work if you select a sound field other than the following:
 - 2ch Stereo
 - Multi Ch Stereo
- This function does not work when [Direct] is being used and analog input is selected.
- This function may not work depending on the audio format.
- The receiver may play signals at a lower sampling frequency than the actual sampling frequency of the input signals depending on the audio format.

Hint

- You can also select [In-Ceiling Speaker Mode] in [Sound Effects] from the home menu.
- To obtain the optimal sound for your listening environment, configure the [Ceiling Height] setting in the [Speaker Settings] menu, then perform Auto Calibration.

[81] Enjoying Video and Sound | Enjoying sound effects

Enjoying high-fidelity sound (Pure Direct)

You can enjoy higher-fidelity sound from all inputs using the Pure Direct function. When the Pure Direct function is on, the display panel lights off to suppress noise that affects sound quality.

- 1 Select [Sound Effects] - [Pure Direct] from the home menu.
- 2 Select [On].

Canceling Pure Direct

The Pure Direct function will be canceled when you perform the following:

- Select [Off] in step 2.
- Press PURE DIRECT on the receiver.
- Change the sound field.
- Change the scene setting on the TV (Scene Select).
- Change the setting of [Automatic Phase Matching], [Calibration Type] or [Equalizer] in the [Speaker Settings] menu.
- Change the setting of [Sound Optimizer], [In-Ceiling Speaker Mode] or [Dynamic Range Compressor] in the [Audio Settings] menu.

Note

- [Automatic Phase Matching], [Calibration Type], [Equalizer], [Sound Optimizer], [In-Ceiling Speaker Mode] and [Dynamic Range Compressor] do not work when the Pure Direct function is selected.

Hint

- You can also use PURE DIRECT on the receiver to turn the Pure Direct function on or off.
- You can also select [Pure Direct] in [Setup] - [Audio Settings] from the home menu.

[82] Enjoying Video and Sound | Enjoying sound effects

Using the DTS:X Dialog Control function

The DTS:X Dialog Control function is a function which adjusts the dialog levels during playback of the DTS:X stream. This function enables you to increase the dialog levels in contrast with the background sound and hear dialog easily even under noisy circumstances.

- 1 Press **OPTIONS**.

The options menu appears.

2 Select [Dialog Control].

3 Press **▲/▼** to adjust the dialog level.

Note

- This function may not work depending on the audio signals.
- You cannot display the options menu while watching the TV. Set this function by selecting [**<AUDIO>**] (Audio Settings) - [**DIALOG CTL**] on the display panel.

[83] Using Network Features

What you can do with network features

You can enjoy playing back audio content in high-quality audio from a computer or network HDD, or iPhone/iPad/iPod or other smartphone or tablet connected to your home network either wired or wirelessly.

You can also enjoy audio services such as internet radio by connecting to the Internet.

You can also control this receiver from a smartphone by using the compatible apps.

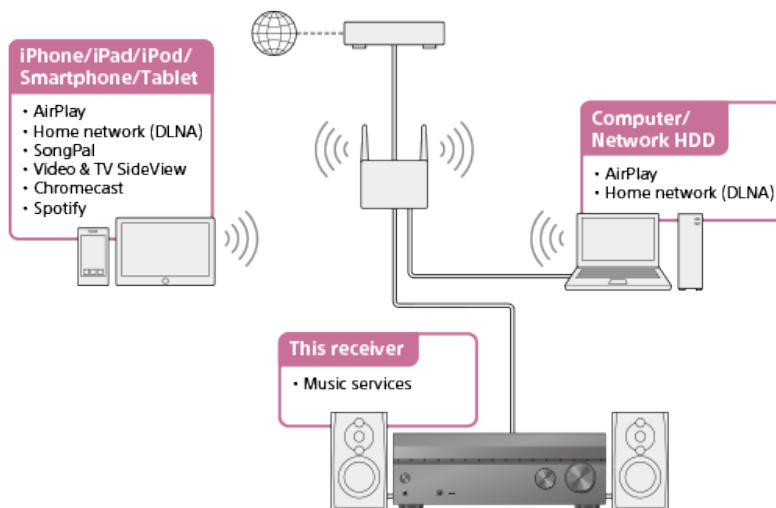

• AirPlay

This receiver supports AirPlay. You can enjoy audio content from an iPhone/iPad/iPod or your iTunes Library.

Enjoying audio content from iTunes or an iPhone/iPad/iPod via the network (AirPlay)

• Home network (DLNA)

You can play back audio content stored in various formats on a network location (computer, network HDD, etc.) via your home network.

Enjoying content stored on a server on the home network (DLNA)

•

SongPal

You can control your receiver wirelessly using SongPal app installed on your smartphone or tablet device.

This app is recommended if you will use the receiver's content playback, multi-zone, or SongPal Link feature.

[Controlling the receiver using a smartphone or tablet device \(SongPal\)](#)

[Listening to the same music on multiple devices/Listening to different music in a different location \(SongPal Link\)](#)

[Listening to the same music in different rooms \(Wireless Multi-Room\)](#)

- **Video & TV SideView**

You can control your receiver wirelessly by installing the Video & TV SideView app on your smartphone or tablet device. This app is recommended for customers who use a TV manufactured by Sony with the receiver.

[Registering Video & TV SideView device to the receiver](#)

- **Internet music services**

With the receiver connected to the Internet, you can listen to music from a variety of music services.

[Enjoying music services offered on the Internet](#)

- **Chromecast built-in**

You can select audio/music content from the Chromecast-enabled app and play back via this receiver.

[Using Chromecast built-in™ to enjoy audio content from a smartphone or tablet device](#)

- **Spotify**

You can select audio/music content from the Spotify app and play back via this receiver.

[Using Spotify Connect to enjoy music](#)

[84] Using Network Features | Setting up a wired LAN connection (for wired LAN connections only)

Connecting the receiver to the network using a LAN cable (for wired LAN connections only)

The following illustration is an example configuration of a home network with the receiver and a server.

We recommend that you connect the server to the router with a wired connection.

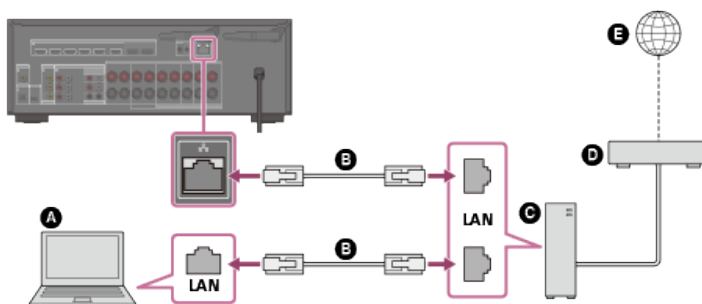

A Server (computer, etc.)

- B** LAN cable (*) (not supplied)
- C** Router
- D** Modem
- E** Internet

* We recommend using category 7 cables.

[85] Using Network Features | Setting up a wired LAN connection (for wired LAN connections only)

Setting up a wired LAN connection

You can set up a wired LAN connection by the following procedure.

- 1** Select **[Setup]** - **[Network Settings]** from the home menu.
- 2** Select **[Internet Settings]**.
- 3** Select **[Wired Setup]**.
The screen for selecting the IP address acquisition method appears on the TV screen.
- 4** Select **[Auto]**.
The confirmation screen appears.
- 5** Press **▲/▼** to browse information, and then press **▶**.
- 6** Select **[Save & Connect]**.
The receiver starts connecting to the network. For details, refer to the messages that appear on the TV screen.

If using a fixed IP address

Select **[Manual]** in step 4 and follow the on-screen instructions.

Hint

- See **[Network Connection Status]** when checking the network settings.

connections only)

Connecting the receiver to the network using the wireless LAN antenna (for wireless LAN connections only)

The following illustration is an example configuration of a home network with the receiver and a server.

We recommend that you connect the server to the router with a wired connection.

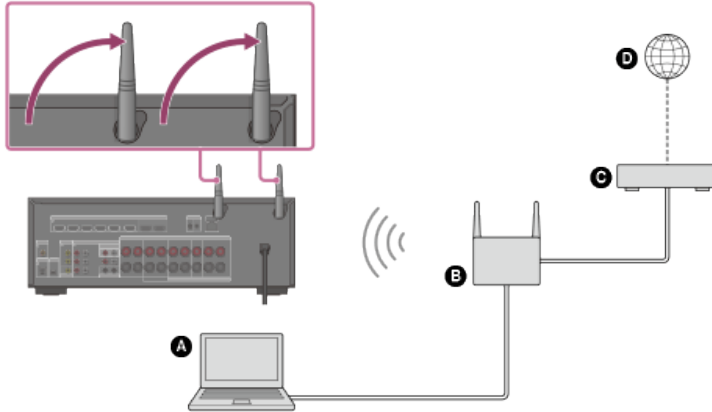

- A** Server (computer, etc.)
- B** Router
- C** Modem
- D** Internet

Note

- Audio playback on a server may occasionally be interrupted if you use a wireless connection.

[87] Using Network Features | Setting up a wireless LAN connection (for wireless LAN connections only)

Setting up a wireless LAN connection

Before performing network settings

When your wireless LAN router (access point) is Wi-Fi Protected Setup (WPS)-compatible, you can easily set the network settings with the WPS button.

If not, you will be required to select or enter the following information. Check the following information in advance.

- The network name (SSID) (*1) of the wireless LAN router/access point
- The security key (passkey) (*2) for the network

*1 SSID (Service Set Identifier) is a name that identifies a particular access point.

*2 This information should be available from a label on your wireless LAN router/access point, from the operating instructions, from the person who set up your wireless network, or from the information provided by your Internet service provider.

- 1** Select [Setup] - [Network Settings] from the home menu.

2 Select [Internet Settings].

3 Select [Wireless Setup].

4 Select [Wi-Fi Protected Setup (WPS)].

5 Select [Start].

6 Press the WPS button on the access point.

The receiver starts connecting to the network.

After the network settings are complete, [Wi-Fi] lights up on the display panel.

If selecting the network name (SSID) you want

Select the network name (SSID) you want in step 4, enter the security key (or passkey) using the on-screen keyboard, and then select [Enter] to confirm the security key. The receiver starts connecting to the network. For details, refer to the messages that appear on the TV screen.

When manually inputting a fixed IP address

Select [New connection registration] - [Manual registration] in step 4, then follow the on-screen instructions.

If using a (WPS) PIN code

Select [New connection registration] - [(WPS) PIN Method] in step 4, then follow the on-screen instructions.

Hint

- See [Network Connection Status] when checking the network connection status.

[88] Using Network Features | Enjoying content stored on a server on the home network (DLNA)

Enjoying content stored on a server on the home network (DLNA)

You can enjoy music files stored on a server on the home network using the receiver.

The server may require some settings to be configured to allow the receiver to play music files from the server. For details, refer to the operating instructions or help of the respective devices or applications.

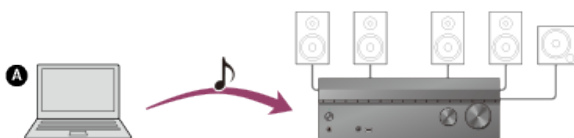

A Server (computer, etc.)

1 Select [Listen] - [Home Network] from the home menu.

A list of available servers appears on the TV screen.

If the last selected item (playlist, album, folder, etc.) appears on the TV screen, press **BACK** to return to the server list.

If there are no available servers, press **OPTIONS** in the [Connection Server Settings] screen in the [Network Settings] menu and then select [Update Server List].

2 Select the server.

The content list appears on the TV screen.

3 Select the item you want.

Repeat this step to narrow down the choices until the item you want appears. The items that are displayed depend on the server you are connected to.

4 Select the file you want to play.

Playback starts.

Setting playback modes using the options menu

You can set the following playback modes by pressing **OPTIONS** after step 4.

- **Repeat Setting:** You can set the following repeat playback modes for music files stored on the server:
 - **Folder:** Plays back all files in the selected folder repeatedly.
 - **Track:** Plays back only the selected file repeatedly.
 - **Off:** Plays back all files in the selected folder and stops playback with the last file.
- **Shuffle Setting:** If this is set to [On], music files stored on the server on the home network will be played back in the shuffle playback mode. The files targeted for shuffle playback are based on the setting for [Repeat Setting].

Note

- The receiver can recognize the following files or folders stored in the home network server:
 - up to folders in the 19th layer
 - up to 999 files/folders in a single layer
- Audio content with DRM (Digital Rights Management) copyright protection cannot be played on this receiver.
- There may be some tracks that cannot be played on this receiver.

Hint

- If the server device supports the Wake-on-LAN, the receiver turns the server on automatically in step 2. If the server does not support the Wake-on-LAN, turn on the server in advance. For details on the Wake-on-LAN settings or operations of your server, refer to the operating instructions or help of your server.

Deleting a server from the server list

If a server you do not usually use appears in the server list, you can delete it using this function.

- 1 Select **[Setup]** - **[Network Settings]** from the home menu.
- 2 Select **[Connection Server Settings]**.
- 3 Select the server which you want to delete and press **OPTIONS**.
- 4 Select **[Remove]** from the options menu.
- 5 Select **[OK]** on the confirmation display.

[The device has been removed from the list.] appears on the TV screen, and the selected server is deleted.

Note

- A server will appear in the server list even after being deleted from the list if the receiver finds it on the network (such as when you refresh the server list).

Setting whether to control this receiver from a controller device on the home network (Home Network Access Control)

You can check a list of products compatible with a controller on the home network and set whether or not each product is accessible via this receiver.

- 1 Select **[Setup]** - **[Network Settings]** from the home menu.
- 2 Select **[Home Network Access Control]**.

A list of registered controllers appears (up to 20 devices).

3 Select the controller you want to set and press .

4 Select the setting you want.

- **Allow:** Permits access from the controller.
- **Block:** Blocks access from the controller.

[91] Using Network Features | Enjoying content stored on a server on the home network (DLNA)

About DLNA

This receiver is a DLNA certified™ product. When you use this product by connecting it to devices on a home network, it works as a player or renderer.

What is DLNA?

DLNA stands for “Digital Living Network Alliance.” This organization defines specifications for the interoperability of interconnected audio-visual devices, computers, and information appliances on a home network.

Player function

By connecting this product to the home network you can play on this product music files stored on a server product (*) in the same home network.

- * Server products include Xperia smartphone, Xperia tablet and Sony VAIO PC with home network function, and other DLNA certified server products. It is recommended that you check the specification of each product on Sony website in your country/region.
<http://www.sony.jp/support/dlna/>

Renderer function

By connecting this product to the home network and operating a controller product (*1),

- You can play on this product music files stored on the controller
- You can play on this product music files stored on a server product (*2) in the same home network.

- *1 Controller products include home network products of Sony such as Xperia Smartphone, Xperia Tablet, Walkman and Sony VAIO PC with home network function and other DLNA certified controller products. It is recommended that you check the specification of each product on Sony website in your country/region.
<http://www.sony.jp/support/dlna/>

- *2 Server products include home network products of Sony such as Xperia smartphone, Xperia tablet and Sony VAIO PC with home network function and other DLNA certified server products. It is recommended that you check the specification of each product on Sony website in your country/region.
<http://www.sony.jp/support/dlna/>

[92] Using Network Features | Enjoying audio content from iTunes or an iPhone/iPad/iPod via the network (AirPlay)

Compatible iPhone/iPad/iPod models

You can use the following iPhone/iPad/iPod models on this receiver. Update your iPhone/iPad/iPod with the latest software before using it.

BLUETOOTH technology works with

- **iPhone:**
iPhone 7 Plus/iPhone 7/iPhone SE/iPhone 6s Plus/iPhone 6s/iPhone 6 Plus/iPhone 6/iPhone 5s/iPhone 5c/iPhone 5/iPhone 4s
- **iPod touch:**
iPod touch (5th and 6th generation)

AirPlay works with

- **iPhone:**
iPhone 7 Plus/iPhone 7/iPhone SE/iPhone 6s Plus/iPhone 6s/iPhone 6 Plus/iPhone 6/iPhone 5s/iPhone 5c/iPhone 5/iPhone 4s
- **iPad:**
iPad Pro (12.9-inch)/iPad Pro (9.7-inch)/iPad Air 2/iPad Air/iPad mini 4/iPad mini 3/iPad mini 2/iPad mini/iPad (4th and 3rd generation)/iPad 2
- **iPod touch:**
iPod touch (5th and 6th generation)

AirPlay works with iPhone, iPad, and iPod touch with iOS 4.3.3 or later, Mac with OS X Mountain Lion or later, and PC with iTunes 10.2.2 or later.

[93] Using Network Features | Enjoying audio content from iTunes or an iPhone/iPad/iPod via the network (AirPlay)

Enjoying audio content from iTunes or an iPhone/iPad/iPod via the network (AirPlay)

You can play audio content on an iPhone, iPad, iPod or in an iTunes Library on your computer with this receiver via a wireless network.

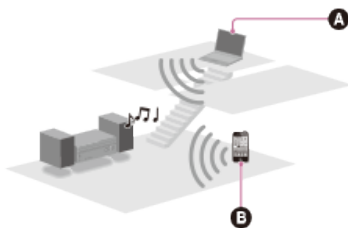





- **A** Computer
- **B** iPhone/iPad/iPod

- 1 Tap/click the AirPlay icon (📶, etc.) on the iPhone/iPad/iPod screen or iTunes window.
- 2 Select [STR-DN1080 XXXXXX] (*) on the AirPlay menu of iTunes or your iPhone/iPad/iPod.

3 Start playing back audio content on an iPhone/iPad/iPod or in iTunes.

* XXXXXX is the identification number for each unit.

Controlling AirPlay playback

You can use the  +/-, , , ,  buttons on the remote control when the receiver is selected as the device for output.

Note

- Update the iPhone/iPad/iPod or iTunes to the latest version before using with the receiver.
- Refer to the operating instructions of your device for details on operating the iPhone/iPad/iPod, iTunes or AirPlay.

Hint

- If the playback does not start, perform the process again from step 1.
- Very loud sound may output from the receiver if you set the volume loud on an iPhone/iPad/iPod or iTunes.
- It may not be possible to link the volume level of an iPhone/iPad/iPod or iTunes with the volume level of this receiver.

[94] Using Network Features | Enjoying internet music services

Enjoying music services offered on the Internet

You can listen to music services offered on the Internet with this receiver.

To use this function, you need to connect the receiver to the Internet and then follow the guide that is displayed after the following steps.

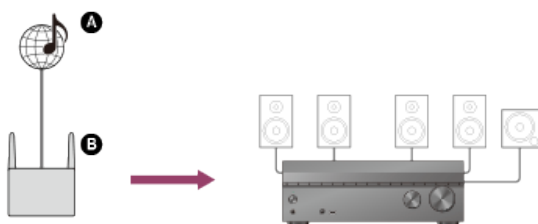

A Internet

B Router

1 Select [Listen] - [Music Service List] from the home menu, or press **MUSIC SERVICE**.

The service provider list appears on the TV screen.

You can update the service provider list by pressing **OPTIONS**, followed by select [Update Services].

2 Select the music service you want.

A guide to enjoying that music service will appear on the TV screen. Follow the instructions

in the guide.

Note

- Available services may vary depending on your location.

Hint

- If you have been playing the music on the receiver using Spotify Connect, you can resume Spotify playback by pressing MUSIC SERVICE.

[95] Using Network Features | Using SongPal to control the receiver from a smartphone or tablet device

Controlling the receiver using a smartphone or tablet device (SongPal)

SongPal is a dedicated app for operating SongPal-compatible audio devices manufactured by Sony using a smartphone or tablet device.

Search for SongPal on Google Play or the App Store and download to your smartphone or tablet device.

SongPal allows you to:

- change commonly used settings, selecting the input of the receiver and adjusting the volume.
- enjoy music content stored on a home network server or smartphone on the receiver.
- enjoy music visually with your smartphone display.
- configure Wi-Fi connection settings easily using SongPal if your Wi-Fi router does not have a WPS function.
- use the SongPal Link function.

For details on how to use SongPal and SongPal Link, refer to the SongPal help.

- 1 Download the SongPal application to your mobile device.**
- 2 Connect the receiver and mobile device by BLUETOOTH connection or network connection.**
- 3 Launch SongPal and follow the on-screen instructions.**

After the connection is completed, you can control the receiver using SongPal.

Note

- SongPal uses the network and BLUETOOTH functions of the receiver. Set the [Bluetooth Mode] to [Receiver].
- Connect the receiver and the mobile device on which you use SongPal to the same network.
- Use the latest SongPal version.
-

SongPal does not support iPad.

- Specifications and design of SongPal may change without prior notice.

[96] Using Network Features | Using SongPal to control the receiver from a smartphone or tablet device

Listening to the same music on multiple devices/Listening to different music in a different location (SongPal Link)

You can enjoy music stored on your computer or smartphone or from music services in multiple rooms at the same time.

The receiver supports the Wireless Multi-Room function out of the three SongPal Link functions. Refer to the following for details of SongPal Link:

<http://www.sony.net/nasite>

[97] Using Network Features | Listening to music by connecting the SongPal Link-compatible device

Listening to the same music in different rooms (Wireless Multi-Room)



You can listen to music stored on a USB flash drive, computer, or smartphone and music from network services in different rooms with optimal sound quality.

The Wireless Multi-Room function lets you listen to audio from the following sound sources in different rooms simultaneously via a home network.

- Music stored on a USB flash drive, computer, or smartphone
- Music services available on the Internet
- Devices connected to the HDMI IN, OPTICAL IN, COAXIAL IN, or AUDIO IN jacks
- TVs compatible with the Audio Return Channel (ARC) function and connected to the HDMI OUT A (TV) jack (*)

Use the SongPal app installed on a smartphone/iPhone to operate this function. To use multiple SongPal-compatible devices, you need to connect them to the same network.

To perform settings, refer to the help on SongPal app.

* To use the Audio Return Channel (ARC) function, set [Control for HDMI] to [On] in the [HDMI Settings] menu.

Note

- When you listen to sound from one of the following sources and watch video using the Wireless Multi-Room function, the sound is delayed in order to synchronize it with the sound output from the speakers in another location.

- **A** Devices connected to the HDMI IN, OPTICAL IN, COAXIAL IN, or AUDIO IN jacks
- **B** TVs compatible with the Audio Return Channel (ARC) function and connected to the HDMI OUT A (TV) jack

If the sound lag bothers you, deactivate the synchronization with speakers in another location (*) by the following procedure.

* If you deactivate the synchronization with other speakers, the sound and video output from the receiver will be synchronized, but the sound output from speakers in another location will be delayed.

If sound is input from **A:**

1. Press **OPTIONS**.
The options menu appears.
2. Select **[Multi-room Sync] - [Off]**.

If sound is input from **B:**

1. Press **AMP MENU**.
The menu is displayed on the display panel of the receiver.
 2. Press **▲/▼** and **□** to select **[<AUDIO>] (Audio Settings) - [M/R SYNC] - [OFF]**.
- You cannot listen to audio in different rooms using the Wireless Multi-Room function in the following cases:
 - Audio is being received via a **BLUETOOTH** connection or **AirPlay**.
 - Audio recorded in the **SA-CD** or **DVD-Audio** format is being input via an **HDMI** connection.
 - You cannot select sound fields when the **Wireless Multi-Room** function is active.

Hint

- Operate with a Chromecast-enabled app to select audio/music content from the Chromecast-enabled app and enjoy it in multiple rooms. For details, see [“Using Chromecast built-in™ to enjoy audio content from a smartphone or tablet device”](#)

[98] Using Network Features | Using Video & TV SideView to control the receiver from a smartphone or tablet device

Registering Video & TV SideView device to the receiver

You can control the receiver using Video & TV SideView from a mobile device or tablet device. When you use Video & TV SideView for the first time, you need to register the mobile device on which Video & TV SideView is installed to the receiver.

Search for Video & TV SideView on Google Play or the App Store and download to your mobile device.

- 1** Download **Video & TV SideView** app to your mobile device.
- 2** Turn on the receiver and then connect it to the same network as your mobile device.
- 3** Press **HOME** to return to the home menu.
- 4** Turn on **Video & TV SideView**, and then select **[Add device]** and follow the screen instructions both on **Video & TV SideView** and the receiver.

After registration is completed you can control the receiver using Video & TV SideView.

Note

- The registration can only be performed on the home menu.

[99] Using Network Features | Using Video & TV SideView to control the receiver from a smartphone or tablet device

Checking the registered Video & TV SideView device (Registered Remote Devices)

You can check the Video & TV SideView devices which are able to control the receiver.

- 1 Select [Setup] - [Network Settings] from the home menu.
- 2 Select [Registered Remote Devices].

Note

- You can register up to 5 Video & TV SideView devices. If you want to add a new device when a maximum of 5 devices are set, remove unnecessary devices before adding the new device.

[100] Using Network Features | Using Video & TV SideView to control the receiver from a smartphone or tablet device

Deleting Video & TV SideView device from device list

You can check and delete the Video & TV SideView devices which are able to control the receiver.

- 1 Select [Setup] - [Network Settings] from the home menu.
- 2 Select [Registered Remote Devices].
- 3 Select the device you want to delete and press **OPTIONS**.
- 4 Select [Remove] from the options menu.

5 Select [OK].

The selected device is deleted from the device list.

[101] Using Network Features

Using Chromecast built-in™ to enjoy audio content from a smartphone or tablet device

You can play back audio/music content selected in a Chromecast-enabled app on a mobile device by activating the Chromecast built-in function. You can also listen to the same music in multiple rooms if you register devices that support the Chromecast built-in function such as the receiver and wireless speakers located in another room, to a group in advance.

For details, refer to the following Chromecast website:

g.co/cast/audiolearn

1 Select [Listen] - [Music Service List] from the home menu.

The music service list appears on the TV screen.

2 Select [Chromecast built-in] to activate the function.

Perform the settings to use Chromecast built-in on the receiver by following the on-screen instructions.

Once the settings are configured, [Network Standby] is set to [On] automatically, and you can quickly start up the receiver from standby mode to play music (for USA, Canadian and Asia-Pacific models only).

3 Connect the mobile device to the same network as that of the receiver.

4 Install the Chromecast-enabled app to the mobile device.

5 Start the Chromecast-enabled app, tap the cast button, and select [STR-DN1080 XXXXXX] (*) or group in which [STR-DN1080 XXXXXX] (*) is included.



6 Select and play music on the Chromecast-enabled app.

The music is played back on the receiver or on each device in the selected group.

* XXXXXX is the identification number for each unit.

Note

- While playing music using the Chromecast built-in function, you can only select [Multi Ch Stereo] or [2ch Stereo] by pressing 2CH/MULTI on the remote control or the receiver. You cannot select other sound fields.
- Chromecast built-in and the Chromecast-enabled app may not be available in some countries/regions.

[102] Using Network Features

Using Spotify Connect to enjoy music

You can select the music on the Spotify app and play it on the receiver. To play on the receiver, you need the Spotify Premium account.

- 1 **Connect the mobile device by Wi-Fi to the same network as that of the receiver.**
- 2 **Install the Spotify app to the mobile device.**
- 3 **Start the Spotify app and log in to the Spotify Premium account.**
- 4 **Select and start playing the music on the Spotify app.**
- 5 **Select the connect icon on the Spotify app and select this receiver as the audio output device.**

The music is played.



Resuming the music that has played on the mobile device

Press MUSIC SERVICE on the remote control.

If you have been playing the music on the receiver using Spotify Connect, you can resume Spotify playback.

Note

- Set [Network Standby] to [On] in the [Network Settings] menu before using Spotify Connect. When [On] is selected, you can quickly start up the receiver from standby mode to play music (for USA, Canadian and Asia-Pacific models only).
- The Spotify app may not be available in some countries/regions.

[103] Using Network Features | Setting whether to control this receiver from a device on the home network

Setting whether to control this receiver from a controller device on the home network (Home Network Access Control)

You can check a list of products compatible with a controller on the home network and set whether or not each product is accessible via this receiver.

1 Select [Setup] - [Network Settings] from the home menu.

2 Select [Home Network Access Control].

A list of registered controllers appears (up to 20 devices).

3 Select the controller you want to set and press .

4 Select the setting you want.

- **Allow:** Permits access from the controller.
- **Block:** Blocks access from the controller.

[104] Using Network Features | Setting whether to control this receiver from a device on the home network

Enabling automatic access from a newly detected controller device (Auto Home Network Access Permission)

You can set whether or not the receiver allows automatic access from a newly detected controller device on the home network.

1 Select [Setup] - [Network Settings] from the home menu.

2 Select [Auto Home Network Access Permission].

3 Select [On] or [Off].

[105] Using Network Features | Setting whether to control this receiver from a device on the home network

Deleting devices from the device list in Home Network Access Control

- 1 Select [Setup] - [Network Settings] from the home menu.
- 2 Select [Home Network Access Control].
- 3 Select the device you want to delete and press **OPTIONS**.
- 4 Select [Remove] from the options menu.
- 5 Select [OK].

The selected device is deleted from the device list.

[106] Using BLUETOOTH Features

What you can do with BLUETOOTH features

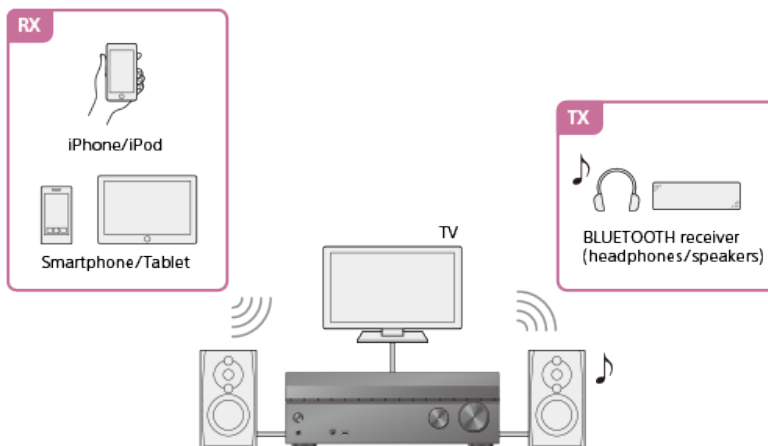

- **RX (Receiver mode)**

Listening to audio content from a BLUETOOTH device via this receiver

You can receive audio from an iPhone/iPod, smartphone or tablet that has a BLUETOOTH function and listen to it via this receiver.

Devices that have the NFC function can be connected by a one-touch connection simply by bringing the device close to the receiver.

Enjoying audio content stored on a BLUETOOTH device with a one-touch connection (NFC)

Enjoying audio content using the BLUETOOTH function (Pairing operation)

- **TX (Transmitter mode)**

Transmitting sound to a BLUETOOTH receiver and listening via the BLUETOOTH receiver (headphones/speakers)

You can enjoy listening to audio from AV devices connected to the receiver via BLUETOOTH headphones/speakers. (The NFC function cannot be used.) Move the BLUETOOTH receiver closer to receiver if sound is intermittent.

[Listening with BLUETOOTH headphones/speakers \(Pairing operation\)](#)

See "[Compatible BLUETOOTH version and profiles](#)" for details on BLUETOOTH device versions and profiles that can be paired.

[107] Using BLUETOOTH Features | Enjoying audio content stored on a BLUETOOTH device

Enjoying audio content stored on a BLUETOOTH device with a one-touch connection (NFC)

You can enjoy audio content on a BLUETOOTH device with a one-touch connection using the NFC function.

- 1 If you are using an NFC-compatible BLUETOOTH device with Android OS 4.0 or earlier, download the "NFC Easy Connect" application to your device.



You do not need to install the "NFC Easy Connect" application if you are using an NFC-compatible BLUETOOTH device with Android OS 4.1 or later installed.

- 2 Touch the **N** mark on the receiver with your BLUETOOTH device.

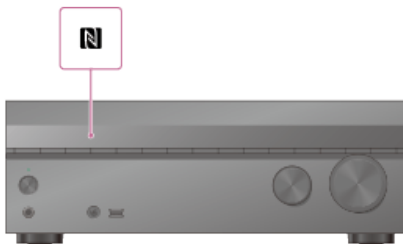

- 3 Follow the on-screen instructions displayed on the BLUETOOTH device, and complete the procedure for BLUETOOTH connection.

- 4 Check that the connection is completed and [BT] lights up on the display panel.

- 5 Start playback on the BLUETOOTH device.

6 Adjust the volume.

Adjust the volume of the BLUETOOTH device first. If the volume level is still too low, adjust the volume level of the receiver.

Compatible smartphones

Smartphones with the NFC function (compatible OS: Android 2.3.3 or later, excluding Android 3.x)

Note

- [Bluetooth Mode] will be set to [Receiver] automatically after step 2.
- This function does not work while the Software Update screen is displayed.
- The receiver does not support BLUETOOTH receiver (headphones/speakers) with NFC function.

Hint

- If you want to connect a BLUETOOTH device when the receiver is in standby mode, set [Network Standby] to [On] in the [Network Settings] menu (for USA, Canadian and Asia-Pacific models only).

[108] Using BLUETOOTH Features | Enjoying audio content stored on a BLUETOOTH device

Enjoying audio content using the BLUETOOTH function (Pairing operation)

Pairing is an operation where BLUETOOTH devices are registered to each other before connection. Once a pairing operation is performed, it does not need to be performed again. Be sure to set the [Bluetooth Mode] to [Receiver] before pairing a device with this receiver.

1 Place the BLUETOOTH device within 1 meter (3.3 feet) of the receiver.

2 Press and hold CONNECTION PAIRING BLUETOOTH on the receiver to select the BLUETOOTH function.

[PAIRING] flashes on the display panel. Perform step 3 within five minutes, otherwise pairing will be canceled. If pairing is canceled, repeat this step.

3 Perform pairing on the BLUETOOTH device to detect this receiver.

For details, refer to the operating instructions of your BLUETOOTH device.
A list of detected devices may appear on the BLUETOOTH device display depending on the type of BLUETOOTH device. This receiver is displayed as [STR-DN1080 XXXXXX] (*).

4 Select [STR-DN1080 XXXXXX] (*) on the BLUETOOTH device display.

If [STR-DN1080 XXXXXX] (*) is not displayed, repeat this process from step 1.
When the BLUETOOTH connection is established, the paired device name appears and [BT] lights up on the display panel.

5 Start playback on the BLUETOOTH device.

6 Adjust the volume.

Adjust the volume of the BLUETOOTH device first. If the volume level is still too low, adjust the volume level of the receiver.

* XXXXXX is the identification number for each unit.

Canceling pairing operation

Pairing operation will be canceled when you switch the input.

Note

- Some applications of BLUETOOTH device cannot be controlled from the receiver.
- If a passkey is required on the display of the BLUETOOTH device in step 4, enter [0000]. The passkey may be called "Passcode," "PIN code," "PIN number" or "Password."
- You can pair up to 9 BLUETOOTH devices. If a 10th BLUETOOTH device is paired, the least recently connected device will be replaced by the new one.
- CONNECTION  PAIRING BLUETOOTH on the receiver does not work when the [Bluetooth Mode] is set to [Off].



Hint

- You can change the name of the receiver that appears on your device in [Device Name] in the [System Settings] menu.

[109] Using BLUETOOTH Features | Enjoying audio content stored on a BLUETOOTH device

Controlling a BLUETOOTH device using the remote control

You can operate a BLUETOOTH device using the following buttons on the remote control:

-  (*): Starts or pauses playback.
- : Stops playback.
- : Moves to the start of the previous/current or next track.

* If you press  when no BLUETOOTH device is connected, the receiver automatically connects to the last connected BLUETOOTH device.

Note

- These operations may not be available for certain BLUETOOTH devices. The actual operations may also differ depending on the connected BLUETOOTH device.

- The BLUETOOTH RX/TX button does not function while the BLUETOOTH function is in use or when [Bluetooth Mode] is set to [Off].

[110] Using BLUETOOTH Features | Enjoying audio content stored on a BLUETOOTH device

Compatible BLUETOOTH version and profiles

“Profile” refers to a standard set of capabilities for various BLUETOOTH product capabilities. This receiver supports the following BLUETOOTH version and profiles:

- **Compatible BLUETOOTH version:** BLUETOOTH Specification Version 4.1
- **Compatible BLUETOOTH profiles:**
 - A2DP 1.2 (Advanced Audio Distribution Profile): Receives high-quality audio content.
 - AVRCP 1.5 (Audio Video Remote Control Profile): Controls audio/video devices (pausing, stopping, starting playback, volume control, etc.) (*)

* Absolute volume is supported only when [Bluetooth Mode] is set to [Receiver]. When [Bluetooth Mode] is set to [Transmitter], volume command for AVRCP 1.3 is supported.

For the latest information about compatible BLUETOOTH devices, check the websites listed under “[Customer support websites](#).”

Note

- The functions may differ depending on the specifications of the BLUETOOTH device.
- The audio playback on this receiver may be delayed from that on the BLUETOOTH device because of the characteristics of the BLUETOOTH wireless technology.

[111] Using BLUETOOTH Features | Listening with BLUETOOTH receiver (headphones/speakers)

Listening with BLUETOOTH headphones/speakers (Pairing operation)

You can listen to audio sources playing via this receiver by using BLUETOOTH receiver (headphones/speakers).

- 1 Select [Setup] - [Bluetooth Settings] from the home menu.
 - 2 Set [Bluetooth Mode] to [Transmitter].
[BT TX] appears on the display panel.
 - 3 Turn on the BLUETOOTH function on the BLUETOOTH receiver.
- 

4 Select the name of the BLUETOOTH receiver from the [Device List] in the [Bluetooth Settings] menu.

If you cannot find the name of your BLUETOOTH receiver in the list, select [Scan].

5 Return to the home menu and select the desired input.

The sound is output from the BLUETOOTH receiver.

6 Adjust the volume.

Adjust the volume level of the BLUETOOTH receiver first. If the volume level is still too low, adjust the volume level on this receiver. The volume level of this receiver cannot be controlled when BLUETOOTH receiver is connected.  +/- on the remote control and MASTER VOLUME on this receiver only work for the BLUETOOTH receiver.

Note

- You may not be able to adjust the volume level depending on the BLUETOOTH receiver.
- When [Bluetooth] is selected as an input, you cannot set [Bluetooth Mode] to [Transmitter].
- You can register up to 9 sets of BLUETOOTH receiver. If a 10th set of BLUETOOTH receiver is registered, the least recently connected BLUETOOTH receiver will be replaced by the new ones.
- This receiver can display up to 15 detected BLUETOOTH receiver in the [Device List].
- You cannot change the sound effects or settings in the options menu while transmitting sound.
- Some content cannot be output due to copyright protection.
- The audio output from the BLUETOOTH receiver may be delayed compared to that from this receiver because of the characteristics of BLUETOOTH wireless technology.
- No sound is output from the speakers or HDMI OUT jacks when BLUETOOTH receiver is successfully connected to this receiver.
- The [Bluetooth] and Home Theatre Control functions are disabled when [Bluetooth Mode] is set to [Transmitter].
- This receiver does not support the NFC connection with BLUETOOTH receiver.

Hint

- You can enable or disable the reception of AAC or LDAC audio from the BLUETOOTH device.
- You can also switch the [Bluetooth Mode] using BLUETOOTH RX/TX on the remote control.
- If the BLUETOOTH device in step 3 is the most recently connected device, you can connect it to this receiver automatically by simply pressing BLUETOOTH RX/TX on the remote control. In this case, you do not need to perform step 4.

“Profile” refers to a standard set of capabilities for various BLUETOOTH product capabilities. This receiver supports the following BLUETOOTH version and profiles:

- **Compatible BLUETOOTH version:** BLUETOOTH Specification Version 4.1
- **Compatible BLUETOOTH profiles:**
 - A2DP 1.2 (Advanced Audio Distribution Profile): Receives high-quality audio content.
 - AVRCP 1.5 (Audio Video Remote Control Profile): Controls audio/video devices (pausing, stopping, starting playback, volume control, etc.) (*)

* Absolute volume is supported only when [Bluetooth Mode] is set to [Receiver]. When [Bluetooth Mode] is set to [Transmitter], volume command for AVRCP 1.3 is supported.

For the latest information about compatible BLUETOOTH devices, check the websites listed under “[Customer support websites](#).”

Note

- The functions may differ depending on the specifications of the BLUETOOTH device.
- The audio playback on this receiver may be delayed from that on the BLUETOOTH device because of the characteristics of the BLUETOOTH wireless technology.

[113] Using BLUETOOTH Features | Using SongPal to control the receiver from a smartphone or tablet device

Controlling the receiver using a smartphone or tablet device (SongPal)

SongPal is a dedicated app for operating SongPal-compatible audio devices manufactured by Sony using a smartphone or tablet device.

Search for SongPal on Google Play or the App Store and download to your smartphone or tablet device.

SongPal allows you to:

- change commonly used settings, selecting the input of the receiver and adjusting the volume.
- enjoy music content stored on a home network server or smartphone on the receiver.
- enjoy music visually with your smartphone display.
- configure Wi-Fi connection settings easily using SongPal if your Wi-Fi router does not have a WPS function.
- use the SongPal Link function.

For details on how to use SongPal and SongPal Link, refer to the SongPal help.

- 1 Download the SongPal application to your mobile device.**
- 2 Connect the receiver and mobile device by BLUETOOTH connection or network connection.**
- 3 Launch SongPal and follow the on-screen instructions.**

After the connection is completed, you can control the receiver using SongPal.

Note

- SongPal uses the network and BLUETOOTH functions of the receiver. Set the [Bluetooth Mode] to [Receiver].
- Connect the receiver and the mobile device on which you use SongPal to the same network.
- Use the latest SongPal version.
- SongPal does not support iPad.
- Specifications and design of SongPal may change without prior notice.

[114] Using BLUETOOTH Features | Using SongPal to control the receiver from a smartphone or tablet device

Listening to the same music on multiple devices/Listening to different music in a different location (SongPal Link)

You can enjoy music stored on your computer or smartphone or from music services in multiple rooms at the same time.

The receiver supports the Wireless Multi-Room function out of the three SongPal Link functions. Refer to the following for details of SongPal Link:

<http://www.sony.net/nasite>

[115] Using the Multi-Zone Features | Overview of multi-zone features

What you can do with multi-zone features

- **Listening in two locations — Zone 2**

You can simultaneously enjoy music in another room by connecting speakers located in the other room to the SPEAKERS ZONE 2 (*1) or SPEAKERS SURROUND BACK/HEIGHT (*2) terminals. For example, you can simultaneously listen to the same music from AV devices located in the living room and kitchen, or enjoy different music in the kitchen while you watch a movie in the living room.

The volume can be adjusted separately for each room.

*1 For USA and Canadian models only

*2 For other models only

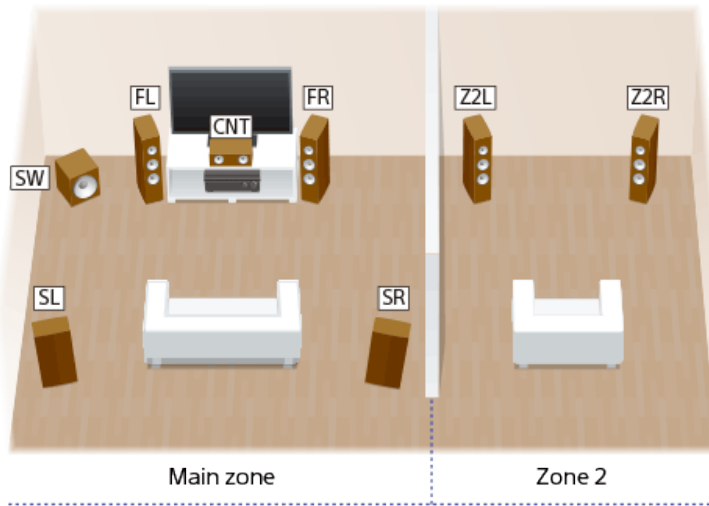

Hint

- You can also install and use one more receiver or amplifier in Zone 2. In this case, connect the amplifier installed in Zone 2 to the AUDIO ZONE 2 OUT jacks of the receiver installed in main zone.

- HDMI zone**

You can enjoy video and audio in another room by connecting a TV or different AV receiver equipped with an HDMI input jack and located in another room to the HDMI OUT B/HDMI ZONE jack. For example, movies or music from an AV device located in the living room can be played at high quality in a bedroom.

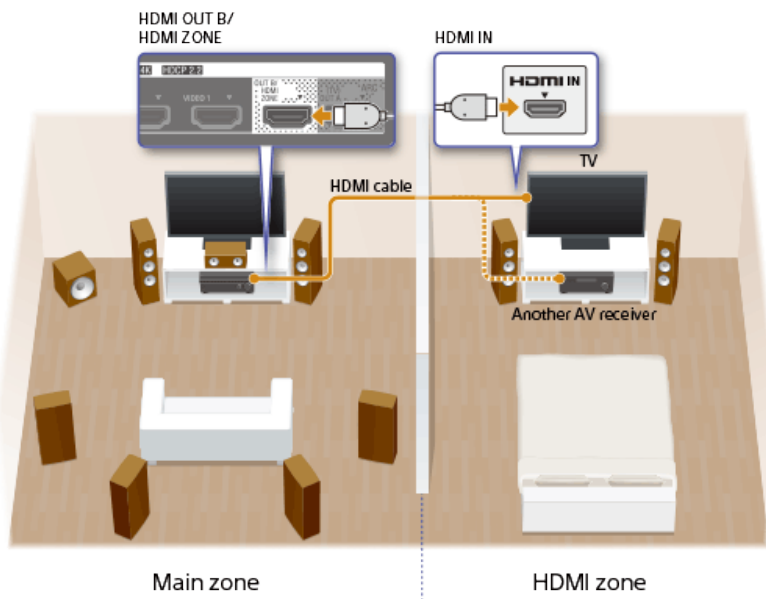

Note

- There are restrictions on the audio sources that can be used in Zone 2 or the HDMI zone. For details, see "[Available inputs for each zone.](#)"

Available inputs for each zone

Available inputs for main zone

You can select all input source from every device connected to the receiver in the main zone. Additionally, you can select a sound source received via BLUETOOTH connection.

Input name	Input source
BD/DVD	<ul style="list-style-type: none">• Signals from the HDMI IN BD/DVD jack
GAME	<ul style="list-style-type: none">• Signals from the HDMI IN GAME jack
SAT/CATV	<ul style="list-style-type: none">• Signals from the HDMI IN SAT/CATV jack• Signals from the VIDEO/AUDIO IN SAT/CATV jacks
VIDEO 1	<ul style="list-style-type: none">• Signals from the HDMI IN VIDEO 1 jack• Signals from the VIDEO/AUDIO IN VIDEO 1 jacks
VIDEO 2	<ul style="list-style-type: none">• Signals from the HDMI IN VIDEO 2 jack
TV	<ul style="list-style-type: none">• TV sound from the OPTICAL IN TV jack• Signals from the AUDIO IN TV jacks
SA-CD/CD	<ul style="list-style-type: none">• Signals from the HDMI IN SA-CD/CD jack• Signals from the COAXIAL IN SA-CD/CD jack• Signals from the AUDIO IN SA-CD/CD jacks
FM TUNER	<ul style="list-style-type: none">• FM broadcasts received through the built-in tuner
USB	<ul style="list-style-type: none">• Signals from the ψ (USB) port on the front panel
Bluetooth	<ul style="list-style-type: none">• Signals received via BLUETOOTH
Home Network	<ul style="list-style-type: none">• Signals received via home network
Music Service List	<ul style="list-style-type: none">• Signals received via music services on the Internet

Available inputs for Zone 2

The following inputs are available for Zone 2.

You cannot watch video in Zone 2. Sound is not available from devices connected to the HDMI IN jacks.

Input name	Input source
SOURCE	<ul style="list-style-type: none">• Signals from the current input in main zone (sound only)
	<ul style="list-style-type: none">•

SAT/CATV	Signals from the AUDIO IN SAT/CATV jacks
VIDEO 1	<ul style="list-style-type: none"> • Signals from the AUDIO IN VIDEO 1 jacks
SA-CD/CD	<ul style="list-style-type: none"> • Signals from the AUDIO IN SA-CD/CD jacks
FM TUNER (*)	<ul style="list-style-type: none"> • FM broadcasts received through the built-in tuner
USB (*)	<ul style="list-style-type: none"> • Signals from the ψ (USB) port on the front panel
Bluetooth (*)	<ul style="list-style-type: none"> • Signals received via BLUETOOTH
Home Network (*)	<ul style="list-style-type: none"> • Signals received via home network
Music Service List (*)	<ul style="list-style-type: none"> • Signals received via music services on the Internet

* You can select either [FM TUNER], [USB], [Home Network], [Music Service List] or [Bluetooth] from the main zone and Zone 2. Priority is given to the choice which has most recently been selected, even if a different choice has already been selected in one of the zones.

Note

- Signals from the HDMI IN, OPTICAL IN and COAXIAL IN jacks cannot be output to the speakers in Zone 2.
- If you connect BLUETOOTH receiver (headphones/speakers) to the main zone while an AV device is playing and the current input in Zone 2 is [USB], [Home Network] or [Music Service List], the input for Zone 2 will change to [SOURCE]. In this case, only FM tuner and analog audio signals are output to Zone 2.
- If you connect BLUETOOTH receiver (headphones/speakers) to the main zone while an AV device is playing, the BLUETOOTH receiver (headphones/speakers) will be disconnected if you select [USB], [Home Network] or [Music Service List] in Zone 2.

Available inputs for HDMI zone

The following inputs are available for HDMI zone. You can only watch video or listen to audio input from the HDMI IN jacks (except the HDMI IN VIDEO 1 jack).

Input name	Input source
SOURCE	<ul style="list-style-type: none"> • Signals from the current input in main zone (sources input from the HDMI IN jacks (except the HDMI IN VIDEO 1 jack) only)
BD/DVD	<ul style="list-style-type: none"> • Signals from the HDMI IN BD/DVD jack
GAME	<ul style="list-style-type: none"> • Signals from the HDMI IN GAME jack
SAT/CATV	<ul style="list-style-type: none"> • Signals from the HDMI IN SAT/CATV jack

VIDEO 2	<ul style="list-style-type: none"> • Signals from the HDMI IN VIDEO 2 jack
SA-CD/CD	<ul style="list-style-type: none"> • Signals from the HDMI IN SA-CD/CD jack

Note

- The HDMI OUT B/HDMI ZONE jack supports bandwidths up to 9 Gbps if [HDMI Out B Mode] is set to [Zone] in the [HDMI Settings] menu.

[117] Using the Multi-Zone Features | Enjoying sound from speakers located in another room (Zone 2)

Connecting 5.1-channel speaker system with Zone 2 connection

Connect each speaker as illustrated below.

Before connecting cables, be sure to disconnect the AC power cord (mains lead).

For details on how to connect speaker cables to the receiver, see “[How to connect speaker cables.](#)”

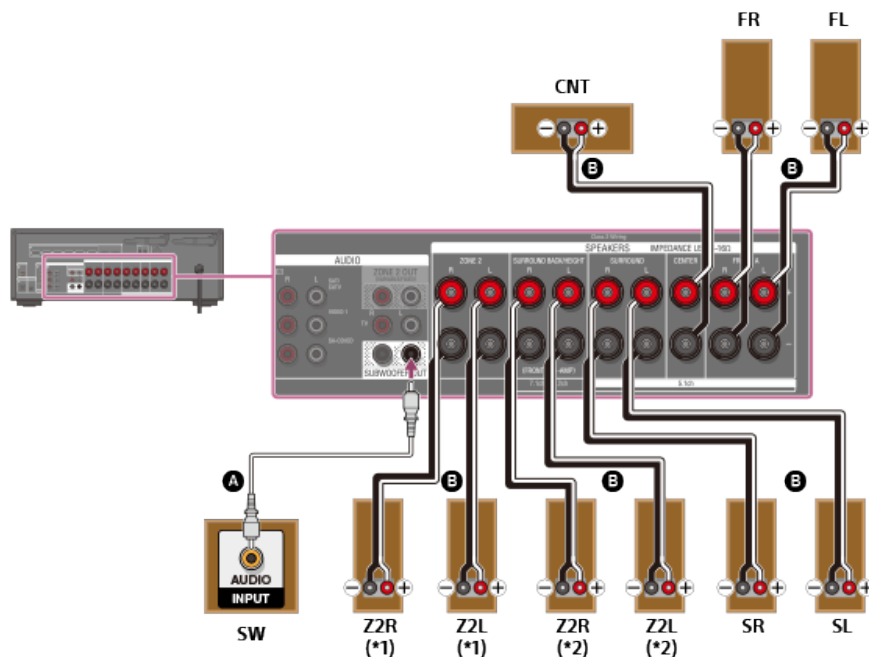

A Monaural audio cable (not supplied)

B Speaker cable (not supplied)

*1 For USA and Canadian models only

*2 For other models

After you have made the Zone 2 connection, set [SURROUND BACK/ZONE2 Priority] to [ZONE2 Terminals] in the [Speaker Settings] menu (for USA and Canadian models only).

After you have made the Zone 2 connection, set [Surround Back Speaker Assign] to [Zone2] in the [Speaker Settings] menu (for other models only).

Note

- After you have installed and connected your speakers, be sure to select the speaker pattern you

want using [Speaker Pattern] in the [Speaker Settings] menu.

- You can only set [Surround Back Speaker Assign] if the speaker pattern is set to a setting that does not have surround back and height/overhead speakers.
- Only audio signals from [USB], [Bluetooth] (while in BLUETOOTH RX mode only), [Home Network], [Music Service List], [FM TUNER] and audio signals input from AUDIO IN jacks are output to the Zone 2 speakers.
- External digital input from OPTICAL IN, COAXIAL IN and HDMI IN jacks cannot be output to Zone 2.

[118] Using the Multi-Zone Features | Enjoying sound from speakers located in another room (Zone 2)

Setting the priority on the surround back speakers or Zone 2 speakers (SURROUND BACK/ZONE2 Priority) (for USA and Canadian models only)

When speakers are connected to both the SPEAKERS SURROUND BACK/HEIGHT terminals and SPEAKERS ZONE 2 terminals, you can set which speakers are given priority.

- 1 Select [Setup] - [Speaker Settings] from the home menu.
- 2 Select [SURROUND BACK/ZONE2 Priority].
- 3 Select the setting you want.
 - **ZONE2 Terminals:** Priority is placed on the SPEAKERS ZONE 2 terminals.
 - **SURROUND BACK Terminals:** Priority is placed on the SPEAKERS SURROUND BACK/HEIGHT terminals and the SPEAKERS ZONE 2 terminals are disabled.

Note

- When [Zone2 Power] is set to [Off], the SPEAKERS SURROUND BACK/HEIGHT terminals are enabled even if [ZONE2 Terminals] is selected.
- When [ZONE2 Terminals] is selected and [Zone2 Power] is set to [On], [Zone2 Power] will be set to [Off] automatically if the [Speaker Pattern] is set to [5.0] or higher.

[119] Using the Multi-Zone Features | Enjoying sound from speakers located in another room (Zone 2)

Configuring speakers installed in Zone 2 (for European and Asia-Pacific models only)

Before enjoying sound using speakers installed in Zone 2, configure the speakers by following the procedure below.

- 1 Select [Setup] - [Speaker Settings] from the home menu.
- 2 Select [Speaker Pattern].
- 3 Set the speaker pattern as shown below by referring to the speaker installation example displayed on the TV screen, and then select [Save].
 - Listener-level Speakers: 5.1, 5.0, 4.1, 4.0, 3.1, 3.0, 2.1 or 2.0
 - Height/Overhead Speakers: --
- 4 Set [Surround Back Speaker Assign] to [Zone2] in the [Speaker Settings] menu.

[120] Using the Multi-Zone Features | Enjoying sound from speakers located in another room (Zone 2)

Enjoying sound in Zone 2

You can enjoy sound from the receiver in Zone 2 by the following procedure.

Note

- Users of USA and Canadian models need to set the priority on the Zone 2 speakers beforehand by following the procedure in "[Setting the priority on the surround back speakers or Zone 2 speakers \(SURROUND BACK/ZONE2 Priority\) \(for USA and Canadian models only\)](#)."
- Users of European or Asia-Pacific models need to configure the speakers installed in Zone 2 beforehand by following the procedure in "[Configuring speakers installed in Zone 2 \(for European and Asia-Pacific models only\)](#)."

- 1 Select [Zone Controls] - [Zone2 Power] - [On] from the home menu.

Zone 2 is activated.
- 2 Select the source signals you want to output in [Zone2 Input].

Select [SOURCE] if you want to listen to the same sound as main zone in Zone 2.
- 3 Start playback on the input that you selected in step 2.
- 4 Adjust to a suitable volume in [Zone2 Volume].

Hint

- You can also activate the zone you want using ZONE SELECT and ZONE POWER on the receiver.

- You can also select source signals you want to output using INPUT SELECTOR on the receiver while [2. xxxx(input name)] is shown on the display panel.
- You can also adjust volume using MASTER VOLUME on the receiver while [2. xxxx (input name)] is shown on the display panel.

To exit zone operation

Select [Zone Controls] - [Zone2 Power] from the home menu, then select [Off].

Available input for zone operations

See “[Available inputs for each zone.](#)”

Hint

- A dedicated App for this model SongPal enables easier zone operation such as changing the settings or switching the zone inputs from your smartphone or tablet.

[121] Using the Multi-Zone Features | Enjoying sound in two rooms using another amplifier

Connecting another amplifier in Zone 2

You can enjoy sound from a device connected to the receiver in a zone other than the main zone. For example, you can watch a DVD in the main zone and listen to music received from music services in Zone 2.

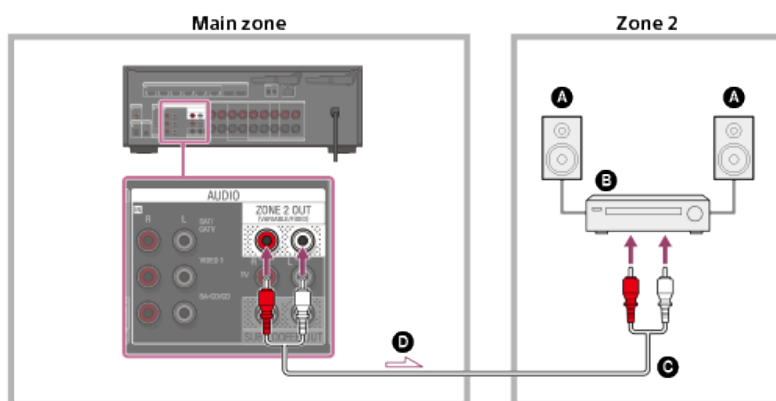

- A Speakers**
- B Amplifier/receiver**
- C Audio cable (not supplied)**
- D Audio signals**

Note

- Only audio signals from [USB], [Bluetooth] (only when in BLUETOOTH RX mode), [Home Network], [Music Service List], [FM TUNER] and audio signals input from AUDIO IN jacks are output to the Zone 2 speakers.
- External digital input from OPTICAL IN, COAXIAL IN and HDMI IN jacks cannot be output to Zone 2.

Setting the volume control for Zone 2 (Zone2 Line Out)

You can set variable or fixed volume control for the AUDIO ZONE 2 OUT jacks.

- 1 **Select [Setup] - [Zone Settings] from the home menu.**
- 2 **Select [Zone2 Line Out].**
- 3 **Select the setting you want.**
 - **Variable:**
Recommended when using another amplifier that does not have volume control for Zone 2.
The volume for the AUDIO ZONE 2 OUT jacks can be changed.
 - **Fixed:**
Recommended when using another amplifier with variable volume control for Zone 2.
The volume for the AUDIO ZONE 2 OUT jacks is fixed.

Note

- When [Variable] is set, the volume is turned down by default. Turn up the volume while listening to the sound after completing setup. The volume for the SPEAKERS ZONE 2 (*1) or SPEAKERS SURROUND BACK/HEIGHT (*2) terminals is changed together with the volume for the AUDIO ZONE 2 OUT jacks.

*1 For USA and Canadian models only

*2 For other models only

Enjoying sound using another amplifier in Zone 2

You can enjoy sound from another amplifier in Zone 2 by the following procedure.

- 1 **Select [Zone Controls] - [Zone2 Power] - [On] from the home menu.**
Zone 2 is activated.
- 2 **Turn on the amplifier in Zone 2.**
- 3 **Select the source signals you want to output in the [Zone2 Input].**
Select [SOURCE] if you want to listen to the same sound as main zone in Zone 2.

4 Start playback on the input that you selected in step 3.

5 Adjust to a suitable volume.

Adjust the volume using the amplifier in Zone 2. If you set [Zone2 Line Out] to [Variable], you can also adjust the volume in Zone 2 using [Zone Controls] - [Zone2 Volume] from the home menu.

Hint

- You can also activate Zone 2 using ZONE SELECT and ZONE POWER on the receiver.
- You can also select source signals you want to output using INPUT SELECTOR on the receiver while [2. xxxx (input name)] is shown on the display panel.
- You can also adjust volume using MASTER VOLUME on the receiver while [2. xxxx (input name)] is shown on the display panel.

To exit Zone 2 operation

Select [Zone Controls] - [Zone2 Power] from the home menu, then select [Off].

Available input for Zone 2 operations

See "[Available inputs for each zone.](#)"

Hint

- A dedicated App for this model SongPal enables easier zone operation such as changing the settings or switching the zone inputs from your smartphone or tablet.

[124] Using the Multi-Zone Features | Enjoying video and sound in another room using a TV or another receiver

Connecting another amplifier or TV in the HDMI zone

HDMI input video/audio signals are output in HDMI zone using the HDMI OUT B/HDMI ZONE jack of the receiver.

When connecting only to a TV

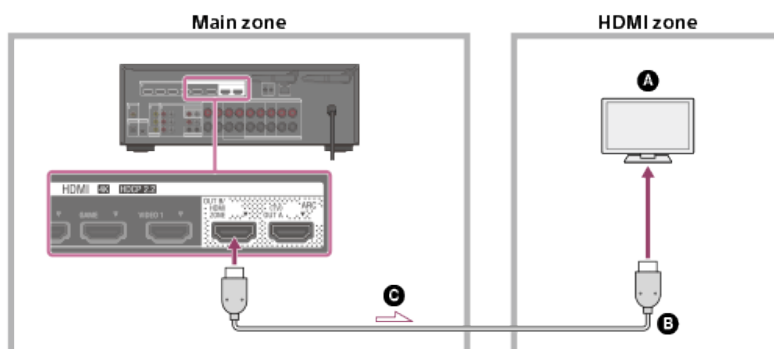

When connecting to another amplifier

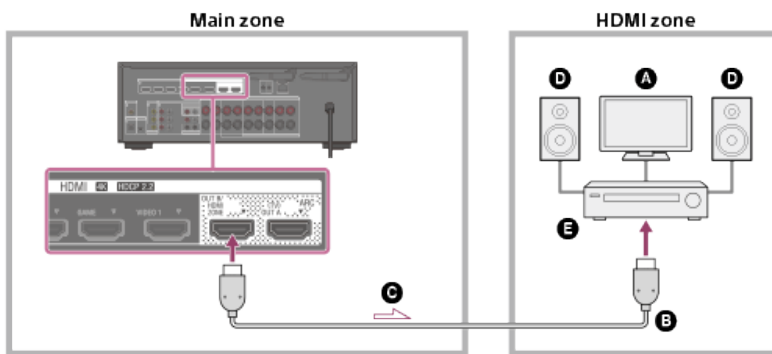

- A** TV
- B** HDMI cable (not supplied)
- C** Audio/video signals
- D** Speakers
- E** Amplifier/receiver

Note

- To use this connection, select [Setup] - [HDMI Settings], and set [HDMI Out B Mode] to [Zone].

[125] Using the Multi-Zone Features | Enjoying video and sound in another room using a TV or another receiver

Selecting the method to use the HDMI OUT B jack (HDMI Out B Mode)

The HDMI OUT B/HDMI ZONE jack can be used for HDMI zone.

- 1** Select [Setup] - [HDMI Settings] from the home menu.
- 2** Select [HDMI Out B Mode].
- 3** Select the setting you want.
 - **Main:** Uses the jack for HDMI OUT B. Recommended when you enjoy TV or projector content in only one room (main zone).
 - **Zone:** Uses the jack for HDMI zone. Recommended when enjoying video and sound from a device connected to the receiver in another room (HDMI zone).

Note

- When [Zone] is selected, the Control for HDMI function does not work. For details on selecting the HDMI zone input, see [“Enjoying video and sound in another location by connecting another amplifier or TV using HDMI connections \(HDMI zone\).”](#)
- The HDMI OUT B/HDMI ZONE jack supports bandwidths up to 9 Gbps if [HDMI Out B Mode] is set to [Zone] in the [HDMI Settings] menu.

[126] Using the Multi-Zone Features | Enjoying video and sound in another room using a TV or another receiver

Setting the priority for the main zone (Priority)

If you select the same HDMI input for the main zone and HDMI zone when the HDMI zone function is enabled, there may be some interference to the audio and video signals in the main zone. To avoid possible interference, you can place priority on the main zone for HDMI input selection.

1 Select [Setup] - [HDMI Settings] from the home menu.

2 Select [Priority].

3 Select the setting you want.

- **Main & Zone:**
You can enjoy the same input in the main zone and HDMI zone. However, there may be some interference between the audio and video signals in the main zone and those in the HDMI zone.
- **Main Only:**
You can enjoy audio and video without interference in the main zone. However, if the same input is selected in HDMI zone, there will be no video or audio output from HDMI zone.

Note

- This function works only when [HDMI Out B Mode] is set to [Zone].

Hint

- If you connect TVs that have different resolutions to the main zone and HDMI zone but select the same HDMI input for both zones, the lower of the two resolutions is used for the video signals output to both TVs.

[127] Using the Multi-Zone Features | Enjoying video and sound in another room using a TV or another receiver

Enjoying video and sound in another location by connecting another amplifier or TV using HDMI connections (HDMI zone)

You can enjoy sound from the another amplifier in the HDMI zone by the following procedure.

1 Select [Zone Controls] - [HDMI Zone Power] - [On] from the home menu.

The HDMI zone is activated.

2 Turn on the amplifier or TV in the HDMI zone.

3 Select the source signals you want to output in the [HDMI Zone Input].

Select [SOURCE] if you want to listen to the same sound as main zone in the HDMI zone.

4 Start playback on the input that you selected in step 3.

5 Adjust to a suitable volume.

Adjust the volume using the volume control of the amplifier or TV in the HDMI zone. The receiver cannot adjust the volume in the HDMI zone.

Hint

- You can also activate the HDMI zone using ZONE SELECT and ZONE POWER on the receiver.
- You can also select source signals you want to output using INPUT SELECTOR on the receiver while [H. xxxx (input name)] is shown on the display panel.

To exit HDMI zone operation

Select [Zone Controls] - [HDMI Zone Power] from the home menu, then select [Off].

Available input for HDMI zone operations

See "[Available inputs for each zone.](#)"

Hint

- A dedicated App for this model SongPal enables easier zone operation such as changing the settings or switching the zone inputs from your smartphone or tablet.

[128] Using Other Features | Interlocking with BRAVIA TV and other devices ("BRAVIA" Sync)

What is "BRAVIA" Sync?

"BRAVIA" Sync is an extended function developed by Sony based on the Control for HDMI (*1) function. By connecting "BRAVIA" Sync-compatible devices, such as a TV or a Blu-ray Disc player, using an HDMI cable (*2) (not supplied) you can control the devices with the TV remote control. The following functions can be used with "BRAVIA" Sync.

- Turning off the receiver and connected devices simultaneously with the TV (System Power Off function) (Standby Linked to TV)

- [Enjoying TV sound from the speakers connected to the receiver \(System Audio Control function\)](#)
- [Enjoying sound of a TV compatible with the Audio Return Channel \(ARC\) function](#)
- [Enjoying an input source from a connected device immediately \(One-Touch Play function\)](#)
- [Operating the receiver menu using the TV remote control \(Remote Easy Control function\)](#)
- [Enjoying content of a connected device without turning on the receiver \(Standby Through\)](#)
- [Selecting the optimum picture quality and sound field automatically \(Scene Select function\)](#)
- [About Home Theatre Control function](#)
- [Echo Canceling function](#)
- [About Language Follow function](#)

*1 Control for HDMI is a standard used by CEC (Consumer Electronics Control) specification that enables interoperability of connected devices for HDMI (High-Definition Multimedia Interface) connections.

*2 Sony recommends a Premium High Speed HDMI Cable with Ethernet that supports 18 Gbps.

Note

- Functions such as System Power Off, System Audio Control, One-Touch Play, and Remote Easy Control may be used with other devices than those manufactured by Sony that support the Control for HDMI function. However, compatibility with other devices than those manufactured by Sony is not guaranteed.

[129] Using Other Features | Interlocking with BRAVIA TV and other devices ("BRAVIA" Sync)

Preparing to use "BRAVIA" Sync function

Turn the Control for HDMI function on to use the "BRAVIA" Sync function. The Control for HDMI function needs to be turned on separately for the receiver and the connected device.

- 1 Select [Setup] - [HDMI Settings] from the home menu.**
- 2 Select [Control for HDMI].**
- 3 Select [On].**
The Control for HDMI function of the receiver is turned on.
- 4 Press HOME to return to the home menu.**
- 5 Press HOME again to exit the home menu.**
- 6 Select the HDMI input of the receiver to match the HDMI input of the connected device, so that the image from the connected device is displayed.**
- 7 Turn on the Control for HDMI function of the connected device.**
For details on setting the connected device, refer to the operating instructions of the

respective devices.

- 8 Repeat steps 6 and 7 for other devices for which you want to use the Control for HDMI function.

Note

- Perform the steps above again if you unplug the HDMI cable or change the connection.
- This function works only when [HDMI Out B Mode] is set to [Main].

[130] Using Other Features | Interlocking with BRAVIA TV and other devices (“BRAVIA” Sync)

Turning off the receiver and connected devices simultaneously with the TV (System Power Off function) (Standby Linked to TV)

You can turn off the receiver and the connected device automatically when you turn off the TV.

- 1 Select [Setup] - [HDMI Settings] from the home menu.

- 2 Select [Standby Linked to TV].

- 3 Select the setting you want.

- **Auto:** When the input of the receiver is set to [BD/DVD], [GAME], [SAT/CATV], [VIDEO 1], [VIDEO 2], [TV] or [SA-CD/CD], the receiver will turn off when the TV is turned off.
- **On:** The receiver will turn off when the TV is turned off, regardless of the input of the receiver.
- **Off:** The receiver does not turn off when the TV is turned off, regardless of the input of the receiver.

Note

- The connected device may not turn off depending on the status of the device.
- System Power Off function may work with devices other than those manufactured by Sony, but operation is not guaranteed.

[131] Using Other Features | Interlocking with BRAVIA TV and other devices (“BRAVIA” Sync)

Enjoying TV sound from the speakers connected to the receiver (System Audio Control function)

If you turn on the receiver while you are watching a connected TV, the TV sound will be output from the speakers connected to the receiver. The volume of the receiver can be adjusted using the TV remote control.

If the TV sound was output from the speakers connected to the receiver last time you watched the TV, the receiver will be turned on automatically when you turn on the TV again.

Operations can also be made using the TV menu. For details, refer to the operating instructions of the TV.

Note

- Depending on the TV, the number of the receiver volume level is displayed on the TV screen. The volume number displayed on the TV may differ from the number on the display panel of the receiver.
- System Audio Control function may work with other devices than those manufactured by Sony, but operation is not guaranteed.
- Depending on the settings of the TV, the System Audio Control function may not be available. For details, refer to the operating instructions of the TV.
- When [Control for HDMI] is set to [On], the [Audio Out] settings in the [HDMI Settings] menu will be set automatically according to the setting of the System Audio Control function.

[132] Using Other Features | Interlocking with BRAVIA TV and other devices (“BRAVIA” Sync)

Enjoying an input source from a connected device immediately (One-Touch Play function)

When you play content on a device (Blu-ray Disc player, PlayStation®4, etc.) connected to the receiver, the receiver and the TV are turned on automatically, the input of the receiver is switched to the input of the device being played, and sound is output from the speakers connected to the receiver.

Note

- If [Standby Through] is set to [Auto] or [On], and the TV sound was output from the speakers of the TV last time you watched the TV, the receiver does not turn on and the sound and picture are output from the TV even if you play content on the device.
- Depending on the TV, the beginning part of content being played may not play correctly.
- One-Touch Play function may work with other devices than those manufactured by Sony, but operation is not guaranteed.

[133] Using Other Features | Interlocking with BRAVIA TV and other devices (“BRAVIA” Sync)

Selecting the optimum picture quality and sound field automatically (Scene Select function)

The sound field are selected automatically according to the Scene Select or Sound Mode setting on your TV.

For details on this operation, refer to the operating instructions of the TV.

The Scene Select/Sound Mode setting and the sound field setting of the receiver will change as follows.

- **News:** Multi Ch Stereo (MULTI ST.)
- **Cinema:** Dolby Surround (DOLBY SURR)
- **Sports:** Dolby Surround (DOLBY SURR)
- **Music:** Dolby Surround (DOLBY SURR)
- **Animation:** Dolby Surround (DOLBY SURR)
- **Photo:** Multi Ch Stereo (MULTI ST.)
- **Game:** Dolby Surround (DOLBY SURR)
- **Graphics:** Multi Ch Stereo (MULTI ST.)

Note

- The Scene Select function is a function developed by Sony, and cannot be used on other devices than those manufactured by Sony.

[134] Using Other Features | Interlocking with BRAVIA TV and other devices (“BRAVIA” Sync)

About Home Theatre Control function

Setting the receiver, the sound field settings, input switching, etc., can be done by selecting the Home Theatre Control application on the TV.

This function can be used when the TV is compatible with the Home Theatre Control application and connected to the Internet. For details, refer to the operating instructions of the TV.

Note

- The Home Theatre Control application is a function developed by Sony, and cannot be used on other devices than those manufactured by Sony.

[135] Using Other Features | Interlocking with BRAVIA TV and other devices (“BRAVIA” Sync)

Operating the receiver menu using the TV remote control (Remote Easy Control function)

You can select the receiver by the SYNC MENU of the TV and operate the receiver. This function can be used if the TV supports the SYNC MENU. For details, refer to the operating instructions of the TV.

Note

- The receiver is recognized as [Tuner] by the TV.
- Some of the operations may not be available depending on the type of TV.
- Remote Easy Control function may work with other devices than those manufactured by Sony, but operation is not guaranteed.

Echo Canceling function

The Echo Canceling function reduces reverberation that may occur when using the Social Viewing functions such as Skype while watching TV programs. This function can be used if the TV supports the Social Viewing functions. For details, refer to the operating instructions of the TV.

Note

- The Echo Canceling function works when you select [TV] or an HDMI input jack to which the device is connected as the input on the receiver.
- When you use the Social Viewing function, the input of the receiver is switched automatically to the input to which the TV is connected, even if another HDMI input jack has been selected. The sound from the Social Viewing function and the TV will be output from the speakers connected to the receiver.
- This function cannot be used when the sound is output from the TV.
- The Echo Canceling function is a function developed by Sony, and cannot be used on other devices than those manufactured by Sony.

About Language Follow function

The on-screen display language of the receiver may be changed simultaneously when you change the language for the on-screen display of the TV.

Switching the TVs that output the HDMI video signals

If [HDMI Out B Mode] is set to [Main], and you have connected two TVs to the HDMI OUT A (TV) and HDMI OUT B/HDMI ZONE jacks, you can switch the output for these two TVs using the HDMI OUT button on the remote control.

1 Connect two TVs to the receiver, and turn on the receiver and the two TVs.

2 Press HDMI OUT.

Each time you press the button, the output will be switched as follows:
HDMI A - HDMI B - HDMI A+B - HDMI OFF

Note

- [HDMI A+B] may not work if the compatible video formats of the TVs connected to the HDMI OUT A (TV) jack and the HDMI OUT B/HDMI ZONE jack of the receiver are different.
- [HDMI A+B] may not work depending on the playback device you connect.
- When you connect two Dolby Vision-compatible TVs to the receiver and select [HDMI A+B], Dolby Vision content is output in the HDR10 or SDR (Standard Dynamic Range) format. To enjoy Dolby Vision content as it is, connect only one Dolby Vision-compatible TV to the receiver, or select either [HDMI A] or [HDMI B].
- If [HDMI Out B Mode] is set to [Zone], you cannot select [HDMI B] and [HDMI A+B].
- Even if you select [HDMI OFF], HDMI signals are output to the HDMI zone.

[139] Using Other Features | Enjoying video and sound with your desired way of use

Switching between digital and analog audio (Input Mode)

When you connect devices to both digital and analog audio input jacks on the receiver, you can fix the audio input mode to either device, or switch from one to the other, depending on the type of material you intend to watch.

1 Select [Setup] - [Input Settings] from the home menu.

2 Select the [Input Mode] setting for the input you want.

- **Auto:** Gives priority to digital audio signals. If there is more than one digital connection, HDMI audio signals have priority. If there are no digital audio signals, analog audio signals are selected.
When TV input is selected, priority is given to Audio Return Channel (ARC) signals. If your TV does not support the Audio Return Channel (ARC) function, digital optical audio signals are selected.
- **Optical:** Specifies input of digital audio signals to the OPTICAL jack.
- **Coaxial:** Specifies input of digital audio signals to the COAXIAL jack.
- **Analog:** Specifies input of analog audio signals to the AUDIO IN (L/R) jacks.

Note

- Depending on the input, [Input Mode] may be dimmed on the TV screen and other modes cannot be selected.

[140] Using Other Features | Enjoying video and sound with your desired way of use

Using other audio input jacks (Input Assign)

You can reassign the OPTICAL/COAXIAL digital audio input jacks to other input if the default settings of the jacks do not correspond to your connected device.

E.g. When connecting a DVD player to the OPTICAL IN TV jack of the receiver, assign the OPTICAL IN TV jack to [BD/DVD].

- 1 Select [Setup] - [Input Settings] from the home menu.
- 2 Select the input name you want to assign.
- 3 Press ◀/▶ repeatedly to select [OPTICAL / COAXIAL].
- 4 Press ▲/▼ repeatedly to select the jack you want to assign.

Assignable audio input jacks

OPT:

BD/DVD, GAME, SAT/CATV, VIDEO 1, VIDEO 2, SA-CD/CD

COAX:

BD/DVD, GAME, SAT/CATV, VIDEO 1, VIDEO 2, SA-CD/CD (*)

None:

BD/DVD (*), GAME (*), SAT/CATV (*), VIDEO 1 (*), VIDEO 2 (*), SA-CD/CD

* Default setting

Note

- When you assign the digital audio input, the Input Mode setting may change automatically.
- One reassignment is allowed for each input.
- If no sound is output from the assigned jacks, also check the Input Mode settings.

[141] Using Other Features | Saving and recalling various settings for the receiver (Custom Preset)

About Custom Preset

You can save various settings with the player, TV, etc., according to your listening and viewing style. You can register those settings for “one-touch” operation, and then recall the environment created with the settings easily.

For example, by saving the settings in the [1: Movie] preset as follows, you can switch the settings of the receiver all at one time without switching each setting for [Input], [Sound Field] and [Calibration Type] individually.

- Input: BD/DVD
- Sound Field: Multi Ch Stereo (MULTI ST.)
- Calibration Type: Engineer

[142] Using Other Features | Saving and recalling various settings for the receiver (Custom Preset)

Saving the settings to a preset

-
- 1 Select [Custom Preset] from the home menu.
 - 2 Press **OPTIONS** with a preset for which you want to edit settings from among [1: Movie], [2: Music], [3: Party] or [4: Night] selected.
 - 3 Select the menu you want from the options menu.
 - **Edit:**
Allows you to customize and save the settings to suit your preferences.
 - **Import:**
Loads the present settings of the receiver and saves those settings as a preset. [Input] and [Volume] are not saved. When [Import] is selected, steps 4 and 5 are not necessary.
 - 4 When [Edit] is selected in step 3 and the edit screen appears, select the items to be set by pressing **▲/▼** and **⏏**, and then change the settings.
 - 5 If the check boxes on the left side of the changed settings remain unchecked, press **⏏/▲/▼** to select them, and then press **⏏** to check the boxes.
Settings go into effect.

Note

- Settings items with unchecked boxes will not be changed from the current settings when you recall the preset. Select [Edit] and then check the boxes for the setting items on the edit screen to apply those settings.

Hint

- You can overwrite [1: Movie] with the present settings by holding down CUSTOM PRESET 1 for 3 seconds in the same way as you do when you select [Import] from the menu.
- When you select [3: Party], Zone 2 and the HDMI zone are turned on automatically allowing you to enjoy the same music that is playing in the main zone.

[143] Using Other Features | Saving and recalling various settings for the receiver (Custom Preset)

Recalling the preset settings

- 1 Select [Custom Preset] from the home menu.
- 2 Select a preset you want.

Hint

- You can recall the setting(s) saved for [1: Movie] directly by pressing CUSTOM PRESET 1 on the remote control.

[144] Using Other Features | Saving and recalling various settings for the receiver (Custom Preset)

Items for which you can save settings and the default values for each item

“—” for the following items indicates that the check box on the left side of each item is unchecked on the edit screen.

Setting items with unchecked boxes are invalid even if values for the items are displayed.

1: Movie

- Input: BD/DVD
- Tuner Preset: —
- Volume: —
- HDMI Output: —
- Party Mode: —
- Sleep: —
- Sound Field: Multi Ch Stereo
- Sound Optimizer: —
- In-Ceiling Speaker Mode: —
- Pure Direct: —
- Calibration Type: —
- Front Bass: —
- Front Treble: —
- Center Bass: —
- Center Treble: —
- Surround Bass: —
- Surround Treble: —
- Height Bass: —
- Height Treble: —

2: Music

- Input: SA-CD/CD
- Tuner Preset: —
- Volume: —
- HDMI Output: —
- Party Mode: —
- Sleep: —
- Sound Field: Multi Ch Stereo
- Sound Optimizer: —
- In-Ceiling Speaker Mode: —
- Pure Direct: —
- Calibration Type: —
- Front Bass: —
- Front Treble: —
- Center Bass: —
- Center Treble: —
- Surround Bass: —
-

- Surround Treble: –
- Height Bass: –
- Height Treble: –

3: Party

- Input: –
- Tuner Preset: –
- Volume: 27
- HDMI Output: –
- Party Mode: On
- Sleep: Off
- Sound Field: Multi Ch Stereo
- Sound Optimizer: Off
- In-Ceiling Speaker Mode: –
- Pure Direct: –
- Calibration Type: –
- Front Bass: –
- Front Treble: –
- Center Bass: –
- Center Treble: –
- Surround Bass: –
- Surround Treble: –
- Height Bass: –
- Height Treble: –

4: Night

- Input:–
- Tuner Preset: –
- Volume: 11
- HDMI Output: –
- Party Mode: –
- Sleep: 0:30:00
- Sound Field: –
- Sound Optimizer: Normal
- In-Ceiling Speaker Mode: –
- Pure Direct: –
- Calibration Type: –
- Front Bass: –
- Front Treble: –
- Center Bass: –
- Center Treble: –
- Surround Bass: –
- Surround Treble: –
- Height Bass: –
- Height Treble: –

[145] Using Other Features

Using the sleep timer (Sleep)

You can set the receiver to turn off automatically after a specified period of time.

- 1 Select [Setup] - [System Settings] from the home menu.

2 Select [Sleep].

3 Set specified time.

- 2:00:00
- 1:30:00
- 1:00:00
- 0:30:00
- Off

[SLEEP] lights up on the display panel of the receiver when sleep timer is being used.

Hint

- You can check the remaining time before the receiver turns off on the System Settings screen. Also, the remaining time appears on the bottom right of the TV screen when it becomes 1 minute or less.
- The sleep timer will be canceled if you perform the following:
 - Select [Off] in step 3.
 - Turn the receiver on or off.
 - Update the software of the receiver.

[146] Using Other Features

Saving power during standby mode

You can save power by setting up the receiver as follows:

- Set [Control for HDMI] and [Standby Through] in the [HDMI Settings] menu to [Off].
- Set [Remote Start] and [Network Standby] in the [Network Settings] menu to [Off] (for USA, Canadian and Asia-Pacific models only).
- Set [Bluetooth Standby] in the [Bluetooth Settings] menu to [Off].
- Set [Zone2 Power] or [HDMI Zone Power] in the [Zone Controls] menu to [Off].

[147] Using Other Features

Viewing information on the display panel

The display panel provides various information on the status of the receiver, such as the sound field.

1 Select the input for which you want to check information.

2 Press DISPLAY MODE on the receiver repeatedly.

Each time you press DISPLAY MODE, the display will change cyclically as follows:
Index name of the input (*1) - Input you selected - Sound field currently applied (*2) -
Volume level - Stream information (*3)

When listening to FM radio

Preset station name (*1) - Frequency - Sound field currently applied (*2) - Volume level

When receiving RDS broadcasts (for European and Asia-Pacific models only)

Program service name or preset station name (*1) - Frequency, band and preset number - Sound field currently applied (*2) - Volume level

*1 Index name appears only when you have assigned one to the input or preset station. Index name does not appear if only blank spaces have been entered or it is same as the input name.

*2 [PURE.DIRECT] appears on the display panel when the Pure Direct function is activated.

*3 Stream information may not be displayed.

Note

- Characters or marks in some languages may not be displayed.

[148] Adjusting Settings | Easy Setup

Setting up the receiver using Easy Setup

When you turn on the receiver for the first time or after the receiver is initialized, the Easy Setup screen appears on the TV screen. You can set up the following settings for the receiver by following the instructions on the Easy Setup screen.

- **Select your language (for USA, Canadian, European and Australian models only)**
Select the language of messages on the screen.
- **Speaker Settings**
Check your speaker system and perform automatic calibration according to the configuration and arrangement of your speaker system.
- **Internet Settings**
Select the network connection method and configure settings to connect the receiver to the network.

Note

- Switch the input of the TV to the input to which the receiver is connected to use this function.
- Auto Calibration is not available when [Bluetooth Mode] is set to [Transmitter].

If the Easy Setup screen does not appear or you want to display the Easy Setup screen manually, you can display it by selecting [Setup] - [Easy Setup] from the home menu.

[149] Adjusting Settings | Performing Auto Calibration

1. About Auto Calibration

Auto Calibration allows you to perform automatic calibration as follows.

- Check the connection between each speaker and the receiver.
- Adjust the speaker level.
- Measure the distance of each speaker from your seating position. (*1)
- Measure the speaker size. (*1)
- Measure the frequency characteristics (EQ). (*1)
- Measure the frequency characteristics (Phase). (*1)(*2)

*1 The measurement result is not utilized when [Direct] is selected for the sound field setting and an analog input is selected.

*2 The measurement result may be not utilized, depending on the audio formats.

Note

- The D.C.A.C. is designed to achieve proper sound balance for your room. However, you can adjust the speaker levels manually according to your preference using [Test Tone] in the [Speaker Settings] menu.

[150] Adjusting Settings | Performing Auto Calibration

2. Before you perform Auto Calibration

Before you perform Auto Calibration, check the following items:

- Set up and connect the speakers.
- Do not connect any microphones other than the supplied calibration microphone to the CALIBRATION MIC jack.
- If using a bi-amplifier connection or a front B speaker connection, set the assignment for the SPEAKERS SURROUND BACK/HEIGHT terminals properly.
- Set the speaker output to a setting other than [SPK OFF].
- Disconnect the headphones.
- Remove any obstructions between the calibration microphone and the speakers.
- For accurate measurement, make sure the environment is quiet and free from noise.

Note

- Auto Calibration is not available when [Bluetooth Mode] is set to [Transmitter].
- The speakers emit very loud sound during the calibration and the volume cannot be adjusted. Be considerate of your neighbors and any children who are present.
- If the muting function has been activated before you perform Auto Calibration, the muting function will shut off automatically.
- It may not be possible to take the correct measurements or to perform Auto Calibration at all if special speakers such as dipole speakers are used.

[151] Adjusting Settings | Performing Auto Calibration

3. Connecting the calibration microphone

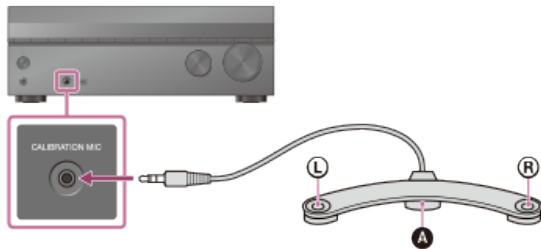

A Calibration microphone (supplied)

1 Connect the supplied calibration microphone to the CALIBRATION MIC jack.

2 Set up the calibration microphone.

Place the calibration microphone at your listening position and set it at the same height as your ears.

Note

- Insert the plug of the calibration microphone all the way into the CALIBRATION MIC jack. If the calibration microphone is not connected securely, measurements may not be made properly.
- Position the calibration microphone horizontally with the L (left) and R (right) ends at the same height.

4. Selecting the front speakers

You can select the front speakers you want to operate.
Be sure to use the buttons on the receiver to perform this operation.

1 Press **SPEAKERS** on the receiver repeatedly to select the front speaker system you want to operate.



The indicators on the display panel shows which set of terminals are selected.

- **SPA:**
Speakers connected to the SPEAKERS FRONT A terminals.
- **SPB (*):**
Speakers connected to the SPEAKERS SURROUND BACK/HEIGHT terminals.
-

SPA+B (*):

Speakers connected to both the SPEAKERS FRONT A and SPEAKERS SURROUND BACK/HEIGHT terminals (parallel connection).

(None):

[SPK OFF] appears on the display panel. No audio signals are output from any speaker terminals.

* To select [SPB] or [SPA+B], set the assignment for the SPEAKERS SURROUND BACK/HEIGHT terminals to [Front B] by using [Surround Back Speaker Assign] in the [Speaker Settings] menu.

Note

- This setting is not available when headphones are connected.
- When you press SPEAKERS on the receiver, the [Bluetooth Mode] changes to [Receiver] automatically.

[153] Adjusting Settings | Performing Auto Calibration

5. Performing Auto Calibration

You can perform automatic calibration from your listening position.

1 Select [Setup] - [Speaker Settings] from the home menu.

2 Select [Auto Calibration].

3 When you use height/overhead speakers, select [Change Surround Back Speaker Assign], and then select [Height Speakers] on the next screen.

4 Select [Proceed to configure the speaker pattern], and then set the speaker pattern on the next screen.

If you have set [Height/Overhead Speakers] to a value other than [FH] or [---], set [Ceiling Height] on the next screen.

5 Make sure that the calibration microphone is connected to the receiver, and then select [Proceed to the next step].

6 Confirm the instructions on the screen, then press  to select [Start].

The measurement starts in 5 seconds.

The measurement process takes approximately 30 seconds. A test tone is output from each speaker in sequence.

When the measurement ends, a beep sounds and the screen switches.

7 Select the item you want.

- **Save:** Saves the measurement results and exits the setting process.
- **Retry:** Performs the Auto Calibration again.
- **Discard:** Exits the setting process without saving the measurement results.

For details on the measurement results, see “[6. Checking Auto Calibration results.](#)”



8 Save the measurement results.

Select [Save] in step 7.

Note

- If the measurement fails, follow the message, then select [Retry]. For details on the error code and warning message, see “[List of messages after Auto Calibration measurements.](#)”
- This setting is not available when headphones are connected.

Hint

- The Auto Calibration measurement will be canceled if you perform the following during the measurement process:
 - Press .
 - Press the input buttons on the remote control or turn INPUT SELECTOR on the receiver.
 - Press HOME, AMP MENU, HDMI OUT or  on the remote control.
 - Press SPEAKERS on the receiver.
 - Change the volume level.
 - Connect headphones.
 - Press MUSIC on the remote control or the receiver.

[154] Adjusting Settings | Performing Auto Calibration

6. Checking Auto Calibration results

To check error codes or warning messages received in [Auto Calibration], proceed with the following steps:

If an error code appears

Check the error and perform Auto Calibration again.

1 Select [Retry].

2 Follow the instructions on the TV screen and then press to select [Start].

The measurement starts in a few seconds.

The measurement process takes approximately 30 seconds. A test tone is output from each speaker in sequence.

When the measurement ends, a beep sounds and the screen switches.

3 Select the item you want.

- **Save:** Saves the measurement results and exits the setting process.
- **Retry:** Performs the Auto Calibration again.
- **Discard:** Exits the setting process without saving the measurement results.

4 Save the measurement results.

Select [Save] in step 3.

5 If the Speaker Relocation/Phantom Surround Back screen appears, select the setting you want by referring to “Calibrating speaker positioning (Speaker Relocation/Phantom Surround Back).”

Skip to step 6 if the screen does not appear in the following cases:

- The set speaker pattern does not include surround back speakers but does include surround speakers, and [Surround Speaker Position] is set to [Front].
- [In-Ceiling Speaker Mode] is set to [Front & Center] or [Front].

6 Select the type of calibration you want by referring to “Selecting the Auto Calibration type (Calibration Type).”

7 When [Do you want to activate Calibration Matching?] appears on the screen, select [Yes] or [No].

- Yes: Expands the sweet spot for the viewing position and allows you to enjoy more natural sound by trimming the wavefront for each pair of left/right speakers.
- No: The measurement results of the Auto Calibration function are applied directly.

8 Select [Finish].

If a warning message appears

Check the warning message and select [OK]. For details on the warning messages, see “[List of messages after Auto Calibration measurements.](#)”

Hint

- The measurement results may vary depending on the position of the subwoofer. However, continuing to use the receiver with that value does not cause problems.

You can set the A.P.M. (Automatic Phase Matching) function in the D.C.A.C. EX (Digital Cinema Auto Calibration EX). This calibrates the phase characteristics of the speakers for well-coordinated surround sound.

- 1 Select [Setup] - [Speaker Settings] from the home menu.
- 2 Select [Automatic Phase Matching].
- 3 Select the setting you want.
 - **Auto:** Switches the A.P.M. function on or off automatically.
 - **Off**

Note

- This function does not work in the following cases:
 - Headphones are connected.
 - [Auto Calibration] has not been performed.
 - [Bluetooth Mode] is set to [Transmitter].
 - [DSD Native] is set to [On] and DSD signals are being played back.
 - [Pure Direct] is set to [On].
- The receiver may play signals at a lower sampling frequency than the actual sampling frequency of the input signals, depending on the audio format.

[156] Adjusting Settings | Speaker Settings

Selecting the Auto Calibration type (Calibration Type)

You can select a calibration type after you have performed the Auto Calibration and saved the settings.

- 1 Select [Setup] - [Speaker Settings] from the home menu.
- 2 Select [Calibration Type].
- 3 Select the setting you want.
 - **Full Flat:** Makes the measurement of frequency from each speaker flat.
 - **Engineer:** Sets to “the Sony listening room standard” frequency characteristics.
 - **Front Reference:** Adjusts the characteristics of all of the speakers to match the characteristics of the front speaker.
 - **Off**

Note

- This function does not work in the following cases:
 - Headphones are connected.
 - [Auto Calibration] has not been performed.
 - [Bluetooth Mode] is set to [Transmitter].
 - [DSD Native] is set to [On] and DSD signals are being played back.
 - [Pure Direct] is set to [On].
- The receiver may play signals at a lower sampling frequency than the actual sampling frequency of the input signals, depending on the audio format.

[157] Adjusting Settings | Speaker Settings

Outputting a test tone from each speaker (Test Tone)

You can output a test tone from each speaker in sequence.

- 1 **Select [Setup] - [Speaker Settings] from the home menu.**
- 2 **Select [Test Tone].**
- 3 **Select the setting you want.**
 - **Off**
 - **Auto:** The test tone is output from each speaker in sequence.
 - **Front L, Center, Front R, Surround R, Surround L, Sur Back L, Sur Back (*), Sur Back R, Height L, Height R, Subwoofer:** You can select which speakers will output the test tone.
 - * [Sur Back] appears when only one surround back speaker is connected.
- 4 **Adjust the speaker level.**

Note

- This function is not available when [Bluetooth Mode] is set to [Transmitter].

Hint

- To adjust the level of all speakers at the same time, press \triangleleft +/- . You can also use MASTER VOLUME on the receiver.
- The adjusted value is shown on the TV screen during adjustment.

To output a test tone from adjacent speakers

See "[Adjusting the balance between adjacent speakers by outputting a test tone \(Phase Noise\).](#)"

To output the source sound from adjacent speakers

See “[Adjusting the balance between adjacent speakers by outputting a source sound \(Phase Audio\)](#).”

[158] Adjusting Settings | Speaker Settings

Adjusting the speaker level (Level)

You can adjust the level of each speaker (front left/right, height left/right, center, surround left/right, surround back left/right and subwoofer).

- 1 Select [Setup] - [Speaker Settings] from the home menu.
- 2 Select [Level].
- 3 Select the speaker whose level you want to adjust from the following.
Front L, Center, Front R, Surround R, Surround L, Sur Back L, Sur Back (*), Sur Back R, Height L, Height R, Subwoofer
* [Sur Back] appears when only one surround back speaker is connected.
- 4 Adjust the level.

Note

- This function is not available when [Bluetooth Mode] is set to [Transmitter].
- If headphones are connected, you can only adjust the level of front left and front right.

[159] Adjusting Settings | Speaker Settings

Adjusting the equalizer (Equalizer)

You can use the following parameters to adjust the tonal quality (bass/treble level) of the front, center, surround/surround back and height speakers.

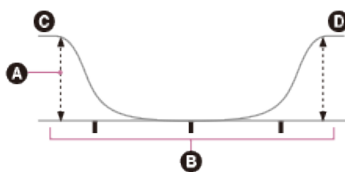

- A Level (dB)
- B Frequency (Hz)
- C Bass
- D Treble

- 1 Select [Setup] - [Speaker Settings] from the home menu.
- 2 Select [Equalizer].
- 3 Select [Front], [Center], [Surround] or [Height].
- 4 Select [Bass] or [Treble].
- 5 Adjust the gain.

Note

- This function does not work in the following cases:
 - [Pure Direct] is set to [On].
 - [Bluetooth Mode] is set to [Transmitter].
 - [DSD Native] is set to [On] and DSD signals are being played back.
- Frequencies for [Bass] and [Treble] are fixed.
- Depending on the audio format, the receiver may play signals at a lower sampling frequency than the original sampling frequency of the input signals.
- Only [Bass] gain and [Treble] gain are available for [Front] when headphones are connected.

Hint

- You can also select [Equalizer] in [Sound Effects] from the home menu. Additionally, you can adjust the equalizer from the [<EQ>] menu on the display panel by pressing AMP MENU.

[160] Adjusting Settings | Speaker Settings

Adjusting the speaker distance (Distance)

You can adjust the distance from where you are sitting to each speaker (front left/right, height left/right, center, surround left/right, surround back left/right, subwoofer).

- 1 Select [Setup] - [Speaker Settings] from the home menu.
- 2 Select [Distance].
- 3 Select the speaker whose distance you want to adjust from the following.

Front L, Center, Front R, Surround R, Surround L, Sur Back L, Sur Back (*), Sur Back R, Height L, Height R, Subwoofer

* [Sur Back] appears when only one surround back speaker is connected.

4 Adjust the distance.

Note

- Some parameters may not be available depending on the speaker pattern setting.
- [Distance] cannot be set in the following cases:
 - Headphones are connected.
 - [Bluetooth Mode] is set to [Transmitter].

[161] Adjusting Settings | Speaker Settings

Adjusting the speaker size (Size)

You can adjust the size of each speaker (front left/right, height left/right, center, surround left/right, surround back left/right).

1 Select [Setup] - [Speaker Settings] from the home menu.

2 Select [Size].

3 Select the speaker whose size you want to adjust from the following.

Front, Center, Surround, Height

4 Select the size you want.

- **Large:** If you connect large speakers that will effectively reproduce bass frequencies, select [Large]. Select [Large] usually.
- **Small:** If the sound is distorted, or you hear a lack of surround effects when using multi channel surround sound, select [Small]. You can activate the bass redirection circuitry and output the bass frequencies of each channel from the subwoofer or other [Large] speakers.

Note

- [Size] cannot be set in the following cases:
 - Headphones are connected.
 - [Bluetooth Mode] is set to [Transmitter].
 - [Speaker Pattern] is set to [2.0].

Hint

- The surround back speakers will be set to the same setting as that of the surround speakers.
- When the front speakers are set to [Small], the center, surround, and surround back/height speakers are also automatically set to [Small].

- If you do not use the subwoofer, the front speakers are automatically set to [Large].

[162] Adjusting Settings | Speaker Settings

Setting the crossover frequency of the speakers (Crossover Frequency)

You can set the bass crossover frequency of speakers for which [Size] in the [Speaker Settings] menu has been set to [Small]. A measured speaker crossover frequency is set for each speaker after the Auto Calibration is performed.

- 1 Select [Setup] - [Speaker Settings] from the home menu.
- 2 Select [Crossover Frequency].
- 3 Select the speaker for which you want to adjust the crossover frequency on the screen.
- 4 Press **▲/▼** to set the crossover frequency.

Note

- This function does not work in the following cases:
 - Headphones are connected.
 - [Bluetooth Mode] is set to [Transmitter].
 - [Size] for none of the speakers is set to [Small].
- The surround back speakers will be set to the same setting as that of the surround speakers.

[163] Adjusting Settings | Speaker Settings

Assigning the surround back speaker terminals (Surround Back Speaker Assign)

You can set the assignment for the SPEAKERS SURROUND BACK/HEIGHT terminals.

- 1 Select [Setup] - [Speaker Settings] from the home menu.
 - 2 Select [Surround Back Speaker Assign].
- 

3 Select the desired speaker pattern according to the speaker installation example displayed on the TV screen, then select [Save].

4 Select the setting you want (*).

- **Off:** When none of the following connections is used.
- **Front B:** When using the front B speaker connection.
- **BI-AMP:** When using the bi-amplifier speaker connection.
- **Zone2 (for European and Asia-Pacific models only):** When using the Zone 2 connection.

* The displayed settings vary depending on the speaker pattern you selected.

Note

- You can only set [Surround Back Speaker Assign] under the following conditions:
 - The speaker pattern is set to a setting without surround back and height/overhead speakers.
 - Headphones are not connected.
 - [Bluetooth Mode] is set to other than [Transmitter].

[164] Adjusting Settings | Speaker Settings

Selecting the speaker pattern (Speaker Pattern)

You can select the speaker pattern you want according to your speaker installation.

1 Select [Setup] - [Speaker Settings] from the home menu.

2 Select [Speaker Pattern].

3 Select the speaker pattern appropriate to your speaker configuration under [Listener-level Speakers] by referring to the speaker installation example displayed on the TV screen.

4 Select the speaker pattern appropriate to your speaker configuration under [Height/Overhead Speakers] by referring to the speaker installation example displayed on the TV screen.

5 Select [Save].

Note

- This function does not work in the following cases:
 - Headphones are connected.
 - [Bluetooth Mode] is set to [Transmitter].

- If a speaker pattern with surround back speakers is selected, you cannot set [Height/Overhead Speakers].
- If you select a speaker pattern with the speakers connected to the SPEAKERS SURROUND BACK/HEIGHT terminals and select [Save], [Zone2 Power] will be set to [Off] automatically (for USA and Canadian models only).

[165] Adjusting Settings | Speaker Settings

Checking the speaker position and the corresponding speaker terminals (Speaker Connection Guide)

This function lets you know the position of the speaker you select and the corresponding speaker terminals on the receiver to which the speaker should be connected.

- 1 Select [Setup] - [Speaker Settings] from the home menu.**
- 2 Select [Speaker Connection Guide].**
A message appears.
- 3 Select [Continue].**
- 4 Select the speaker you want from the list.**
The position of the speaker and the corresponding terminals on the receiver to which the speaker should be connected are shown on the screen.

Note

- When connecting speaker cables, etc., be sure to disconnect the AC power cord (mains lead).

[166] Adjusting Settings | Speaker Settings

Setting the priority on the surround back speakers or Zone 2 speakers (SURROUND BACK/ZONE2 Priority) (for USA and Canadian models only)

When speakers are connected to both the SPEAKERS SURROUND BACK/HEIGHT terminals and SPEAKERS ZONE 2 terminals, you can set which speakers are given priority.

- 1 Select [Setup] - [Speaker Settings] from the home menu.**

2 Select [SURROUND BACK/ZONE2 Priority].

3 Select the setting you want.

- **ZONE2 Terminals:** Priority is placed on the SPEAKERS ZONE 2 terminals.
- **SURROUND BACK Terminals:** Priority is placed on the SPEAKERS SURROUND BACK/HEIGHT terminals and the SPEAKERS ZONE 2 terminals are disabled.

Note

- When [Zone2 Power] is set to [Off], the SPEAKERS SURROUND BACK/HEIGHT terminals are enabled even if [ZONE2 Terminals] is selected.
- When [ZONE2 Terminals] is selected and [Zone2 Power] is set to [On], [Zone2 Power] will be set to [Off] automatically if the [Speaker Pattern] is set to [5.0] or higher.

[167] Adjusting Settings | Speaker Settings

Lifting up the sound of the center speaker (Center Speaker Lift Up)

By using the front high speakers, you can lift up the sounds of the center speaker to an appropriate height on the screen, allowing you to enjoy natural sound without discomfort.

1 Select [Setup] - [Speaker Settings] from the home menu.

2 Select [Center Speaker Lift Up].

3 Select the setting you want.

- 1 - 10
- Off

Note

- This function does not work in the following cases:
 - Headphones are connected.
 - There is no center speaker.
 - [Height/Overhead Speakers] is set to other than [FH] (front high speakers) in the [Speaker Pattern] setting.
 - [2ch Stereo] or [Multi Ch Stereo] is being used.
 - A sound field for music is being used.
 - [Bluetooth Mode] is set to [Transmitter].
 - [In-Ceiling Speaker Mode] is set to [Front & Center] or [Front].
 - [DSD Native] is set to [On] and DSD signals are being played back.

Setting the correct angles of the surround speakers (Surround Speaker Position)

You can select the appropriate position of the surround speakers to operate the Speaker Relocation/Phantom Surround Back function properly.

- 1 Select [Setup] - [Speaker Settings] from the home menu.
- 2 Select [Surround Speaker Position].
- 3 Select the setting according to the angle of the surround speaker positions.
 - **Front:** When the surround speakers are placed at less than 90° (forward from your listening position).
 - **Back:** When the surround speakers are placed at more than 90° (backward from your listening position).

Note

- This function does not work when there are no surround speakers.

Calibrating speaker positioning (Speaker Relocation/Phantom Surround Back)

This function calibrates the speaker positioning (angle of each speaker's configuration from the measurement position) based on the measurement results of the Auto Calibration (D.C.A.C. EX) function to bring the sound closer to the surround-sound effect obtained with ideal speaker positioning. Thus, for example, this function can allow you to enjoy a surround-sound effect acoustically equivalent to that of a 7.1.2-channel speaker system, using only a 5.1.2-channel speaker system.

- 1 Select [Setup] - [Speaker Settings] from the home menu.
- 2 Select [SpeakerRelocation/PhantomSurroundBack].
- 3 Select the setting you want.
 - **Type A:** This function adjusts each speaker's distance and angle to simulate the sound of an ideally placed surround system. When surround speakers are available, the

surround back speakers sound as if they have been placed on the back wall.
 When height speakers such as front high speakers or top middle speakers are available, the height speakers sound as if they have been placed on each side directly aligned with the front speakers.

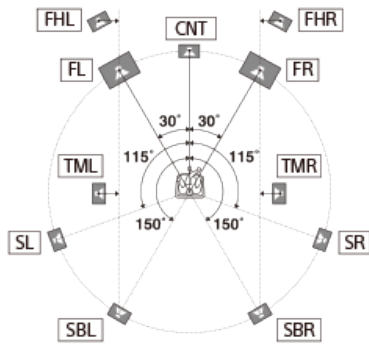

- **Type B:** This function adjusts each speaker's distance and angle to simulate the sound of an ideally placed surround system. When surround speakers are available, the 4 surround speakers sound as if they have been placed at the identical angle. When height speakers such as front high speakers or top middle speakers are available, the height speakers sound as if they have been placed on each side directly aligned with the front speakers.

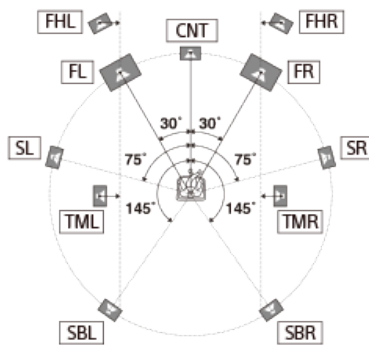

- **Off:** Speaker positioning is not relocated.

Note

- This function does not work in the following cases.
 - [Direct] is being used and an analog input is selected.
 - There are no surround back speakers and [Surround Speaker Position] is set to [Front].
 - When [In-Ceiling Speaker Mode] is set to [Front & Center] or [Front].
 - [DSD Native] is set to [On] and DSD signals are being played back.
- Perform Auto Calibration before using the Speaker Relocation/Phantom Surround Back function.

Set the height from the floor to the ceiling. You can make the [In-Ceiling Speaker Mode] function and Dolby Atmos enabled speakers work better by configuring this setting and performing Auto Calibration.

- 1 Select [Setup] - [Speaker Settings] from the home menu.
- 2 Select [Ceiling Height].
- 3 Adjust the height.

Note

- This function does not work in the following cases:
 - Headphones are connected.
 - [Bluetooth Mode] is set to [Transmitter].

[171] Adjusting Settings | Speaker Settings

Selecting the unit of measurement (Distance Unit)

You can select the unit of measurement for setting distances.

- 1 Select [Setup] - [Speaker Settings] from the home menu.
- 2 Select [Distance Unit].
- 3 Select the setting you want.
 - **feet:** The distance is displayed in feet.
 - **meter:** The distance is displayed in meters.

[172] Adjusting Settings | Audio Settings

Playing audio signals with high-quality sound (Digital Legato Linear (D.L.L.))

The D.L.L. function is Sony proprietary technology that allows low-quality digital and analog audio signals to be played with high-quality sound.

- 1 Select [Setup] - [Audio Settings] from the home menu.

2 Select [Digital Legato Linear].

3 Select the setting you want.

- **Off**
- **Auto 1:** This function is available for lossy compression audio formats and analog audio signals.
- **Auto 2:** This function is available for Linear PCM signals, as well as lossy compression audio formats and analog audio signals.

Note

- This function may not work on some content via a USB device, home network or music services.
- This function works when [2ch Stereo], [Multi Ch Stereo] or [Direct] is selected. However, this function does not work in the following cases:
 - [In-Ceiling Speaker Mode] is set to [Front & Center] or [Front].
 - [FM TUNER] is selected as the input.
 - Linear PCM signals with a sampling frequency other than 44.1 kHz are being received.
 - Following signals are being received:
 - Dolby Digital Plus
 - Dolby TrueHD
 - Dolby Atmos
 - DTS 96/24
 - DTS-ES Matrix 6.1
 - DTS-HD Master Audio
 - DTS-HD High Resolution Audio
 - DTS:X
 - [Bluetooth Mode] is set to [Transmitter].
 - [DSD Native] is set to [On] and DSD signals are being played back.
 - [Direct] is being used and an analog input is selected.

[173] Adjusting Settings | Audio Settings

Enjoying clear and dynamic sound at a low volume (Sound Optimizer)

You can enjoy clear and dynamic sound at low volume levels using the Sound Optimizer. After the Auto Calibration is performed, the sound level is optimized to suit your environment.

1 Select [Setup] - [Audio Settings] from the home menu.

2 Select [Sound Optimizer].

3 Select the setting you want.

- **Normal:** Adjusts for the reference level of a movie.
- **Low:** Adjusts for a CD or other software whose average sound pressure level is processed highly.
- **Off**

Note

- This function does not work in the following cases:
 - [Pure Direct] is set to [On].
 - Headphones are connected.
 - [Bluetooth Mode] is set to [Transmitter].
 - [DSD Native] is set to [On] and DSD signals are being played back.
 - [Direct] is being used when [BD/DVD], [GAME], [VIDEO 2], [USB], [Bluetooth], [Home Network] or [Music Service List] is selected, or during AirPlay playback.
- The receiver may play signals at a lower sampling frequency than the actual sampling frequency of the input signals, depending on the audio format.

Hint

- You can also select [Sound Optimizer] in [Sound Effects] from the home menu.

[174] Adjusting Settings | Audio Settings

Selecting a sound field (Sound Field)

You can select from a variety of sound field modes according to speaker connections or input sources.

1 Select [Sound Effects] - [Sound Field] from the home menu.

2 Select the sound field you want.

For movies, a sound field labeled with [Movie] is recommended.
For music, a sound field labeled with [Music] is recommended.

Note

- You cannot select sound fields in the following cases:
 - [Bluetooth Mode] is set to [Transmitter].
 - The Wireless Multi-Room function is activated.
- When connecting headphones to the receiver, [Headphone(2ch)] is selected as a sound field automatically.
- The sound fields for movie and music may not work, depending on the input or the speaker pattern you select, or with audio formats.
- While playing music using Chromecast built-in, you can only select [Multi Ch Stereo] or [2ch Stereo] by pressing 2CH/MULTI on the remote control or the receiver. You cannot select other sound fields.
- The receiver may play signals at a lower sampling frequency than the actual sampling frequency of the input signals, depending on the audio format.
- Some speakers or the subwoofer may not output sound, depending on the sound field setting.

Hint

- You can also use 2CH/MULTI, MOVIE, MUSIC or FRONT SURROUND on the remote control to

select a sound field. However, if the input other than [USB], [Bluetooth], [Home Network] and [Music Service List] (when music is played back using Spotify Connect) is selected, [Audio Enhancer] cannot be selected when you press MUSIC.

- You can also select [Sound Field] in the [Audio Settings] menu.

[175] Adjusting Settings | Audio Settings

Enjoying more natural sound with speakers installed in the ceiling (In-Ceiling Speaker Mode)

Set whether or not to use in-ceiling speaker mode with the current input.

In a setup where the front and center speakers are installed in the ceiling, lowering the audio output position to the screen height allows you to enjoy a more natural experience.

1 Select [Setup] - [Audio Settings] from the home menu.

2 Select [In-Ceiling Speaker Mode].

3 Select the setting you want.

- **Front & Center:** Lowers the audio output position from the front and center speakers installed in the ceiling to the screen height.
- **Front:** Lowers the audio output position from the front speakers installed in the ceiling to the screen height.
- **Off:** Does not activate this function.

Note

- This function does not work in the following cases:
 - Headphones are connected.
 - [Bluetooth Mode] is set to [Transmitter].
 - [Pure Direct] is set to [On].
 - The Wireless Multi-Room function is activated.
 - [DSD Native] is set to [On] and DSD signals are being played back.
- This function does not work if you select a sound field other than the following:
 - 2ch Stereo
 - Multi Ch Stereo
- This function does not work when [Direct] is being used and analog input is selected.
- This function may not work depending on the audio format.
- The receiver may play signals at a lower sampling frequency than the actual sampling frequency of the input signals depending on the audio format.

Hint

- You can also select [In-Ceiling Speaker Mode] in [Sound Effects] from the home menu.
- To obtain the optimal sound for your listening environment, configure the [Ceiling Height] setting in the [Speaker Settings] menu, then perform Auto Calibration.

Enabling the direct playback of DSD signals (DSD Native)

You can set the receiver to process DSD (Direct Streaming Digital) signals directly without any signal conversion and derive intrinsic sound quality of DSD signals.

- 1 Select **[Setup] - [Audio Settings]** from the home menu.
- 2 Select **[DSD Native]**.
- 3 Select the setting you want.
 - **On**: This function is available for DSD signals.
 - **Off**: Does not activate the direct playback of DSD signals (DSD Native).

Note

- This function does not work in the following cases:
 - [Bluetooth Mode] is set to [Transmitter].
 - The Wireless Multi-Room function is activated.
- When [DSD Native] is set to [On] and DSD signals are being played back, the settings of [Equalizer], [Sound Optimizer] and [Subwoofer Low Pass Filter], etc., are invalid, and the sound field does not work.

Hint

- You can also use DSD NATIVE on the remote control to turn on this function.

Enjoying high-fidelity sound (Pure Direct)

You can enjoy higher-fidelity sound from all inputs using the Pure Direct function. When the Pure Direct function is on, the display panel lights off to suppress noise that affects sound quality.

- 1 Select **[Sound Effects] - [Pure Direct]** from the home menu.
- 2 Select **[On]**.

Canceling Pure Direct

The Pure Direct function will be canceled when you perform the following:

- Select [Off] in step 2.
- Press PURE DIRECT on the receiver.
- Change the sound field.
- Change the scene setting on the TV (Scene Select).
- Change the setting of [Automatic Phase Matching], [Calibration Type] or [Equalizer] in the [Speaker Settings] menu.
- Change the setting of [Sound Optimizer], [In-Ceiling Speaker Mode] or [Dynamic Range Compressor] in the [Audio Settings] menu.

Note

- [Automatic Phase Matching], [Calibration Type], [Equalizer], [Sound Optimizer], [In-Ceiling Speaker Mode] and [Dynamic Range Compressor] do not work when the Pure Direct function is selected.

Hint

- You can also use PURE DIRECT on the receiver to turn the Pure Direct function on or off.
- You can also select [Pure Direct] in [Setup] - [Audio Settings] from the home menu.

[178] Adjusting Settings | Audio Settings

Setting the low-pass filter for the subwoofer output (Subwoofer Low Pass Filter)

You can turn the low-pass filter for the subwoofer output on or off. You can set the function for each input to which an audio input jack is assigned independently. Turn the function on if you connect a subwoofer without the crossover frequency function.

- 1 Select [Setup] - [Audio Settings] from the home menu.
- 2 Select [Subwoofer Low Pass Filter].
- 3 Select the setting you want.
 - **On:** Always activates the low-pass filter with a cutoff frequency of 120 Hz.
 - **Off:** Does not activate the low-pass filter.

Note

- This function does not work in the following cases:
 - [Bluetooth Mode] is set to [Transmitter].
 - [DSD Native] is set to [On] and DSD signals are being played back.
-

Synchronizing audio with video output (A/V Sync)

You can delay the output of audio to minimize the time gap between audio output and a visual display.

This function is useful when using a large LCD or plasma monitor or a projector. You can set the function for each input independently.

- 1 Select [Setup] - [Audio Settings] from the home menu.
- 2 Select [A/V Sync].
- 3 Select the setting you want.
 - **0 ms – 300 ms:** You can adjust the delay from 0 ms to 300 ms in 10 ms intervals.
 - **HDMI Auto:** The time gap between the audio output and visual display of a TV connected via an HDMI connection will be adjusted automatically. This feature is available only when the TV supports the A/V Sync function.

Note

- The receiver may play signals at a lower sampling frequency than the actual sampling frequency of the input signals, depending on the audio format.
- This function is not available in the following cases:
 - [Bluetooth Mode] is set to [Transmitter].
 - [DSD Native] is set to [On] and DSD signals are being played back.

Selecting the language of digital broadcasts (Dual Mono)

You can select the language you want when listening to a digital broadcast with dual audio. This function only works for Dolby Digital sources.

- 1 Select [Setup] - [Audio Settings] from the home menu.
- 2 Select [Dual Mono].
- 3 Select the setting you want.
 - **Main:** Sound in the main language will be output.
 - **Sub:** Sound in the sub language will be output.
 - **Main/Sub:** Sound in the main language will be output through the front left speaker and sound in the sub language will be output through the front right speaker

simultaneously.

[181] Adjusting Settings | Audio Settings

Compressing the dynamic range (Dynamic Range Compressor)

You can compress the dynamic range of the soundtrack. This may be useful when you want to watch movies at a low volume late at night, etc.

1 Select [Setup] - [Audio Settings] from the home menu.

2 Select [Dynamic Range Compressor].

3 Select the setting you want.

- **Auto:** The dynamic range is compressed automatically when there is the additional information in the sound source that recommends using the Dynamic Range Compressor function.
- **On:** The dynamic range is compressed as intended by the recording engineer.
- **Off**

Note

- Only Dolby TrueHD sources currently have the additional information that recommends using this function.

[182] Adjusting Settings | Audio Settings

Switching the mode of the DTS decoder (Neural:X)

You can switch the DTS decoder to “Direct Mode” (Neural:X Off) or “Non-Direct Mode” (Neural:X On).

When in “Direct Mode” (Neural:X Off), the audio is extracted and reproduced as closely as possible to what the content creator intended. When in “Non-Direct Mode” (Neural:X On), the audio is extracted and adapted to fit as closely as possible to the speaker layout of the playback system (regardless of the source configuration). This function only works when the DTS stream is input.

1 Select [Setup] - [Audio Settings] from the home menu.

2 Select [Neural:X].

3 Select the setting you want.

- **On:** The DTS decoder is switched to “Non-Direct Mode.”
- **Off:** The DTS decoder is switched to “Direct Mode.”

Note

- You cannot set this function to [Off] when [Neural:X] is selected as a sound field.
- You cannot set this function to [On] in the following cases:
 - [2ch Stereo], [Direct], [Dolby Surround] or [Front Surround] is selected.
 - [Pure Direct] is set to [On].
 - Headphones are connected.
 - [Bluetooth Mode] is set to [Transmitter].

[183] Adjusting Settings | HDMI Settings

Upscaling video signals to 4K (HDMI In 4K Scaling)

You can upscale video signals to 4K and output them through the HDMI OUT jacks of the receiver.

1 Select [Setup] - [HDMI Settings] from the home menu.

2 Select [HDMI In 4K Scaling].

3 Select the setting you want.

- **Auto:** Enables video scaling control of 4K HDMI output automatically if you connect a 4K-compatible TV.
- **Off**

Note

- This function works only when video signals are received via the HDMI IN jacks. HDMI input signal must be 1080p/24 Hz 2D signal.
- The HDMI OUT B/HDMI ZONE jack does not support [HDMI In 4K Scaling]. Video signals are output in the same resolution as the input resolution.

[184] Adjusting Settings | HDMI Settings

Controlling HDMI devices (Control for HDMI)

You can turn the Control for HDMI function on or off. For details, see “Preparing to use “BRAVIA” Sync function.”

- 1 Select [Setup] - [HDMI Settings] from the home menu.
- 2 Select [Control for HDMI].
- 3 Select [On] or [Off].

Note

- When you set [Control for HDMI] to [On], [Audio Out] may be changed automatically.
- When the receiver is in standby mode, the power indicator on the front panel lights up in amber if [Control for HDMI] is set to [On].
- This function works only when [HDMI Out B Mode] is set to [Main].

[185] Adjusting Settings | HDMI Settings

Turning off the receiver and connected devices simultaneously with the TV (System Power Off function) (Standby Linked to TV)

You can turn off the receiver and the connected device automatically when you turn off the TV.

- 1 Select [Setup] - [HDMI Settings] from the home menu.
- 2 Select [Standby Linked to TV].
- 3 Select the setting you want.
 - **Auto:** When the input of the receiver is set to [BD/DVD], [GAME], [SAT/CATV], [VIDEO 1], [VIDEO 2], [TV] or [SA-CD/CD], the receiver will turn off when the TV is turned off.
 - **On:** The receiver will turn off when the TV is turned off, regardless of the input of the receiver.
 - **Off:** The receiver does not turn off when the TV is turned off, regardless of the input of the receiver.

Note

- The connected device may not turn off depending on the status of the device.
- System Power Off function may work with devices other than those manufactured by Sony, but operation is not guaranteed.

Enjoying content of a connected device without turning on the receiver (Standby Through)

This function allows you to enjoy the sound and image of a connected device without turning on the receiver.

1 Select [Setup] - [HDMI Settings] from the home menu.

2 Select [Standby Through].

3 Select the setting you want.

- **Auto:** The receiver outputs HDMI signals to the TV from the HDMI OUT jack when the TV is turned on while the receiver is in the standby mode. Sony recommends this setting if you are using a "BRAVIA" Sync-compatible TV manufactured by Sony. This setting saves power in the standby mode compared to the [On] setting.
- **On:** The receiver continuously outputs HDMI signals from the HDMI OUT jack when in standby mode. Sony recommends this setting if you are using a TV that is not manufactured by Sony.
- **Off:** The receiver does not output HDMI signals when in standby mode. This setting saves power in the standby mode compared to the [On] setting.

Note

- When the receiver is in standby mode, the power indicator on the front panel lights up in amber if [Standby Through] is set to [On] or [Auto].
- When [Auto] is selected, it may take a little more time for the image and sound to be output to the TV than when [On] is selected.
- This function does not work for the HDMI OUT B/HDMI ZONE jack.
- [Auto] may work on other devices than those manufactured by Sony. However, operation is not guaranteed.

Setting the HDMI audio signal output of connected devices (Audio Out)

You can set the HDMI audio signal output of playback devices connected to the receiver via an HDMI connection.

1 Select [Setup] - [HDMI Settings] from the home menu.

2 Select [Audio Out].

3 Select the setting you want.

- **AMP:** HDMI audio signals from playback devices are only output to the speakers connected to the receiver. Multi-channel sound can be played back as it is.
- **TV + AMP:** The sound is output from the speaker of the TV and the speakers connected to the receiver.

Note

- When you select [AMP], audio signals are not output from the speaker of the TV.
- When you select [TV + AMP], the sound quality of the playback device depends on the sound quality of the TV (number of channels, sampling frequency, etc.). If the TV has stereo speakers, the sound output from the receiver is in the same stereo as the TV, even when playing back multi-channel source.
- When you connect the receiver to a video device (projector, etc.), sound may not be output from the receiver. In this case, select [AMP].
- When you select [TV + AMP], only sound from the HDMI IN jacks is output from the speaker of the TV.

Setting the level of the subwoofer (Subwoofer Level)

You can set the level of the subwoofer to 0 dB or +10 dB when PCM signals are input via an HDMI connection. The level for each input to which an HDMI input jack is assigned can be set independently.

1 Select [Setup] - [HDMI Settings] from the home menu.

2 Select [Subwoofer Level].

3 Select the setting you want.

- **Auto:** Automatically sets the level to 0 dB or +10 dB, depending on the audio stream.
- **+10 dB**
- **0 dB**

Note

- This setting is invalid when [FM TUNER], [USB], [Bluetooth], [Home Network] or [Music Service List] is selected.

Selecting the method to use the HDMI OUT B jack (HDMI Out B Mode)

The HDMI OUT B/HDMI ZONE jack can be used for HDMI zone.

- 1 Select [Setup] - [HDMI Settings] from the home menu.
- 2 Select [HDMI Out B Mode].
- 3 Select the setting you want.
 - **Main:** Uses the jack for HDMI OUT B. Recommended when you enjoy TV or projector content in only one room (main zone).
 - **Zone:** Uses the jack for HDMI zone. Recommended when enjoying video and sound from a device connected to the receiver in another room (HDMI zone).

Note

- When [Zone] is selected, the Control for HDMI function does not work. For details on selecting the HDMI zone input, see [“Enjoying video and sound in another location by connecting another amplifier or TV using HDMI connections \(HDMI zone\).”](#)
- The HDMI OUT B/HDMI ZONE jack supports bandwidths up to 9 Gbps if [HDMI Out B Mode] is set to [Zone] in the [HDMI Settings] menu.

Setting the priority for the main zone (Priority)

If you select the same HDMI input for the main zone and HDMI zone when the HDMI zone function is enabled, there may be some interference to the audio and video signals in the main zone. To avoid possible interference, you can place priority on the main zone for HDMI input selection.

- 1 Select [Setup] - [HDMI Settings] from the home menu.
- 2 Select [Priority].
- 3 Select the setting you want.
 - **Main & Zone:**
You can enjoy the same input in the main zone and HDMI zone. However, there may be some interference between the audio and video signals in the main zone and those in the HDMI zone.

- **Main Only:**

You can enjoy audio and video without interference in the main zone. However, if the same input is selected in HDMI zone, there will be no video or audio output from HDMI zone.

Note

- This function works only when [HDMI Out B Mode] is set to [Zone].

Hint

- If you connect TVs that have different resolutions to the main zone and HDMI zone but select the same HDMI input for both zones, the lower of the two resolutions is used for the video signals output to both TVs.

[191] Adjusting Settings | HDMI Settings

Setting HDMI signal formats (HDMI Signal Format)

You can select the signal format so that the receiver can receive high resolution 4K signals.

1 Select [Setup] - [HDMI Settings] from the home menu.

2 Select [HDMI Signal Format].

3 Select the HDMI input you want to apply the setting.

4 Select the setting you want.

- **Standard format:** Select this when you do not use high bandwidth video format.
- **Enhanced format:** Select this when you use high bandwidth video formats such as 4K/60p 4:4:4, 4:2:2 and 4K/60p 4:2:0 10 bit.

Note

- When [Enhanced format] is selected, we recommend using a Premium High Speed HDMI Cable with Ethernet that supports 18 Gbps.
- When [Enhanced format] is selected, some devices (cable box or satellite box, Blu-ray Disc player, and DVD player) may not work. In this case, select [Standard format].
- If your TV has similar menu for high bandwidth video format, check the setting on the TV menu when you select [Enhanced format] on this receiver. For details on the setting of the TV menu, refer to the operating instructions of the TV.
- For details about the high bandwidth video format, refer to "Supported video formats" in "[About HDMI connections](#)."

Setting the color space conversion for the video signal from HDMI jacks (YCbCr/RGB (HDMI))

1 Select [Setup] - [HDMI Settings] from the home menu.

2 Select [YCbCr/RGB (HDMI)].

3 Select the setting you want.

- **Auto:** Automatically detects the type of external device, and switches to the corresponding color setting.
- **YCbCr (4 : 2 : 2):** Outputs YCbCr 4:2:2 video signals
- **YCbCr (4 : 4 : 4):** Outputs YCbCr 4:4:4 video signals.
- **RGB:** Select this when connecting to a device with an HDCP-compatible DVI jack.

Note

- [YCbCr/RGB (HDMI)] setting does not affect to video signals from the HDMI IN jacks.

Hint

- You can change the setting even when no device is connected via HDMI.
- The setting is maintained even when you disconnect the HDMI cable.

Changing the assignment and display for the input jacks

You can customize the settings for each input according to your preferences and usage. Select [Setup] - [Input Settings] from the home menu, then set each item shown below.

Input

You can change the settings of [Icon], [Name], [Watch / Listen], [Show / Hide], [OPTICAL / COAXIAL] and [Input Mode] for each input.

Note

- The settings of [HDMI], [VIDEO IN] and [AUDIO IN] on the Input Settings screen are fixed and cannot be changed.
- The setting of [OPTICAL / COAXIAL] for [TV] is fixed and cannot be changed.

Icon

You can set the icon displayed on the Watch/Listen menu.

Name

You can change the name displayed on the Watch/Listen menu.

Watch / Listen

You can set whether an input is displayed on the Watch menu or the Listen menu.

- **Watch:** Displays an input to the Watch menu.
- **Listen:** Displays an input to the Listen menu.
- **Watch / Listen:** Displays an input to both the Watch and Listen menus.

Show / Hide

You can set whether or not an input is displayed.

- **Show:** Shows the input.
- **Hide:** Hides the input.

OPTICAL / COAXIAL

You can set the digital audio input jack(s) assigned to each input.

- **OPT**
- **COAX**
- **None**

Input Mode





You can set the input mode for each input.

- **Auto**
- **Optical**
- **Coaxial**
- **Analog**

[194] Adjusting Settings | Input Settings

Changing the name for each input (Name)

You can enter up to 8 characters for each input name.

- 1 **Select [Setup] - [Input Settings] from the home menu.**
- 2 **Select the input name you want to change under [Name].**
An on-screen keyboard appears on the TV screen.
- 3 **Press /// and  to select characters one by one to enter the name.**
- 4 **Select [Enter].**

The name you entered is registered.

[195] Adjusting Settings | Network Settings

Setting up a wired LAN connection

You can set up a wired LAN connection by the following procedure.

1 Select **[Setup] - [Network Settings]** from the home menu.

2 Select **[Internet Settings]**.

3 Select **[Wired Setup]**.

The screen for selecting the IP address acquisition method appears on the TV screen.

4 Select **[Auto]**.

The confirmation screen appears.

5 Press **▲/▼** to browse information, and then press **▶**.

6 Select **[Save & Connect]**.

The receiver starts connecting to the network. For details, refer to the messages that appear on the TV screen.

If using a fixed IP address

Select **[Manual]** in step 4 and follow the on-screen instructions.

Hint

- See **[Network Connection Status]** when checking the network settings.

[196] Adjusting Settings | Network Settings

Setting up a wireless LAN connection

Before performing network settings

When your wireless LAN router (access point) is Wi-Fi Protected Setup (WPS)-compatible, you can easily set the network settings with the WPS button.

If not, you will be required to select or enter the following information. Check the following information in advance.

- The network name (SSID) (*1) of the wireless LAN router/access point
- The security key (passkey) (*2) for the network

*1 SSID (Service Set Identifier) is a name that identifies a particular access point.

*2 This information should be available from a label on your wireless LAN router/access point, from the operating instructions, from the person who set up your wireless network, or from the information provided by your Internet service provider.

- 1 Select [Setup] - [Network Settings] from the home menu.**
- 2 Select [Internet Settings].**
- 3 Select [Wireless Setup].**
- 4 Select [Wi-Fi Protected Setup (WPS)].**
- 5 Select [Start].**
- 6 Press the WPS button on the access point.**

The receiver starts connecting to the network.
After the network settings are complete, [Wi-Fi] lights up on the display panel.

If selecting the network name (SSID) you want

Select the network name (SSID) you want in step 4, enter the security key (or passkey) using the on-screen keyboard, and then select [Enter] to confirm the security key. The receiver starts connecting to the network. For details, refer to the messages that appear on the TV screen.

When manually inputting a fixed IP address

Select [New connection registration] - [Manual registration] in step 4, then follow the on-screen instructions.

If using a (WPS) PIN code

Select [New connection registration] - [(WPS) PIN Method] in step 4, then follow the on-screen instructions.

Hint

- See [Network Connection Status] when checking the network connection status.

Checking the network connection status (Network Connection Status)

You can check the current network connection status.

- 1 Select [Setup] - [Network Settings] from the home menu.
- 2 Select [Network Connection Status].

[198] Adjusting Settings | Network Settings

Checking whether the network connection has been made properly (Network Connection Diagnostics)

You can run the network diagnostic to check whether the network connection has been made properly.

- 1 Select [Setup] - [Network Settings] from the home menu.
- 2 Select [Network Connection Diagnostics].
- 3 Follow the on-screen instructions.

[199] Adjusting Settings | Network Settings

Displaying the connected home network server (Connection Server Settings)

You can change the display settings of the connected server, check the connection or remove the server from the list.

- 1 Select [Setup] - [Network Settings] from the home menu.
- 2 Select [Connection Server Settings].

[200] Adjusting Settings | Network Settings

Enabling automatic access from a newly detected

controller device (Auto Home Network Access Permission)

You can set whether or not the receiver allows automatic access from a newly detected controller device on the home network.

- 1 Select [Setup] - [Network Settings] from the home menu.
- 2 Select [Auto Home Network Access Permission].
- 3 Select [On] or [Off].

[201] Adjusting Settings | Network Settings

Setting whether to control this receiver from a controller device on the home network (Home Network Access Control)

You can check a list of products compatible with a controller on the home network and set whether or not each product is accessible via this receiver.

- 1 Select [Setup] - [Network Settings] from the home menu.
- 2 Select [Home Network Access Control].
A list of registered controllers appears (up to 20 devices).
- 3 Select the controller you want to set and press .
- 4 Select the setting you want.
 - **Allow:** Permits access from the controller.
 - **Block:** Blocks access from the controller.

[202] Adjusting Settings | Network Settings

Checking the registered Video & TV SideView device (Registered Remote Devices)

You can check the Video & TV SideView devices which are able to control the receiver.

- 1 Select [Setup] - [Network Settings] from the home menu.
- 2 Select [Registered Remote Devices].

Note

- You can register up to 5 Video & TV SideView devices. If you want to add a new device when a maximum of 5 devices are set, remove unnecessary devices before adding the new device.

[203] Adjusting Settings | Network Settings

Reducing the startup time (Network Standby) (for USA, Canadian and Asia-Pacific models only)

If this function is set to [On], the startup time can be shortened and the receiver can be turned on when it is detected from a device connected to the same network.

- 1 Select [Setup] - [Network Settings] from the home menu.
- 2 Select [Network Standby].
- 3 Select [On] or [Off].

Note

- If you agree to use the Chromecast built-in function, this function is set to [On] automatically.

[204] Adjusting Settings | Network Settings

Enabling the network function even when this receiver is in standby mode (Remote Start) (for USA, Canadian and Asia-Pacific models only)

If this function is set to [On], the receiver can be turned on by a device via the network when the receiver is in standby mode.

- 1 Select [Setup] - [Network Settings] from the home menu.
- 2 Select [Remote Start].

- 3 Select [On] or [Off].

[205] Adjusting Settings | Network Settings

Turning on the control mode for maintenance (External Control)

You can set whether a dedicated controller (home automation controller) on the home network is allowed to control the receiver.

- 1 Select [Setup] - [Network Settings] from the home menu.
- 2 Select [External Control].
- 3 Select [On] or [Off].

[206] Adjusting Settings | Bluetooth Settings

Selecting the BLUETOOTH mode (Bluetooth Mode)

You can enjoy content from remote devices via this receiver, or listen to sound from this receiver via a BLUETOOTH receiver such as headphones or speakers.

- 1 Select [Setup] - [Bluetooth Settings] from the home menu.
- 2 Select [Bluetooth Mode].
- 3 Select the setting you want.
 - **Receiver:** This receiver is in receiver mode which enables it to receive and output audio from a BLUETOOTH device.
 - **Transmitter:** This receiver is in transmitter mode which enables it to send audio to a BLUETOOTH receiver (headphones/speakers).
[BT TX] appears on the display panel.
 - **Off:** The BLUETOOTH power is turned off and [Listen] - [Bluetooth] cannot be selected from the home menu.

Note

- [Bluetooth Mode] cannot be switched while the input of this receiver is set to [Bluetooth].

- No sound is output from the speakers connected to this receiver when [Bluetooth Mode] is set to [Transmitter].
- In [Transmitter] mode, this receiver can send audio to up to 1 device.

Hint

- You can set the transmission data rate for LDAC playback using [Wireless Playback Quality] in the [Bluetooth Settings] menu.
- If you connect to this receiver from your smartphone while [Transmitter] is selected and no other BLUETOOTH receiver is connected to this receiver, the setting automatically switches to [Receiver] and you can listen to the sound from your smartphone via this receiver.
- You can also switch between [Receiver] (RX) mode and [Transmitter] (TX) by pressing BLUETOOTH RX/TX on the remote control.
- Depending on the BLUETOOTH receiver, you can adjust the volume of the BLUETOOTH receiver from this receiver when [Transmitter] is selected.

[207] Adjusting Settings | Bluetooth Settings

Checking the BLUETOOTH device list (Device List)

You can check a list of the paired and detected BLUETOOTH receivers such as headphones when [Bluetooth Mode] is set to [Transmitter]. You can perform pairing with detected devices from the list.

- 1 Select [Setup] - [Bluetooth Settings] from the home menu.
- 2 Select [Device List].

Hint

- Select [Scan] to refresh the list.

[208] Adjusting Settings | Bluetooth Settings

Setting the BLUETOOTH Standby mode (Bluetooth Standby)

You can set the BLUETOOTH Standby mode so that this receiver can be controlled by a BLUETOOTH device even when this receiver is in standby mode.

- 1 Select [Setup] - [Bluetooth Settings] from the home menu.
- 2 Select [Bluetooth Standby].

3 Select the setting you want.

- **On:** You can turn on this receiver from a paired BLUETOOTH device.
- **Off:** This receiver cannot be turned on from a paired BLUETOOTH device.

Note

- When this receiver is in standby mode, the power indicator on the front panel lights up in amber if the following conditions are met:
 - [Bluetooth Standby] is set to [On].
 - A BLUETOOTH device which already exists in the pairing registration information is paired again.
- This function works only when [Bluetooth Mode] is set to [Receiver] or [Transmitter].
- If you set [Bluetooth Standby] to [On], this receiver turns on when you establish a BLUETOOTH connection from a BLUETOOTH device (for USA, Canadian and Asia-Pacific models only).

[209] Adjusting Settings | Bluetooth Settings

Setting BLUETOOTH audio codecs (Bluetooth Codec - AAC/Bluetooth Codec - LDAC)

You can enable and disable AAC (Advanced Audio Coding) or LDAC audio.

1 Select [Setup] - [Bluetooth Settings] from the home menu.

2 Select [Bluetooth Codec - AAC] or [Bluetooth Codec - LDAC].

3 Select the setting you want.

- **On:** AAC and/or LDAC audio is available if the BLUETOOTH device supports AAC or LDAC.
- **Off:** AAC and/or LDAC audio is not available.

Note

- When you change these settings, the settings are applied from the next time you connect the BLUETOOTH device.
- These functions work only when the [Bluetooth Mode] is set to [Receiver] or [Transmitter].
- While a BLUETOOTH device is connected, the settings of these functions cannot be changed.

Hint

- You can enjoy high-quality sound if AAC or LDAC is enabled.
- LDAC is an audio coding technology developed by Sony that enables the transmission of High-Resolution (Hi-Res) Audio content, even over a BLUETOOTH connection. Unlike other BLUETOOTH compatible coding technologies such as SBC, it operates without any down-conversion of the Hi-Res Audio content (*1), and allows approximately three times more data (*2) than those other

technologies to be transmitted over a BLUETOOTH wireless network with unprecedented sound quality, by means of efficient coding and optimized packetization.

*1 excluding DSD format contents

*2 in comparison with SBC (Subband Coding) when the bitrate of 990 kbps (96/48 kHz) or 909 kbps (88.2/44.1 kHz) is selected

[210] Adjusting Settings | Bluetooth Settings

Setting the BLUETOOTH sound quality (Wireless Playback Quality)

You can set the transmission data rate for LDAC playback.

- 1 Select [Setup] - [Bluetooth Settings] from the home menu.
- 2 Select [Wireless Playback Quality].
- 3 Select the setting you want.
 - **Auto:** Sets the transmission data rate for LDAC automatically.
 - **Sound Quality:** The highest data rate is used. Sound is sent at a higher quality, but audio playback may become unstable if the link quality is not sufficient.
 - **Standard:** A medium data rate is used. This provides a balance between sound quality and playback stability.
 - **Connection:** Stability is prioritized. The sound quality may be reasonable and the connection status will most likely be stable. This setting is recommended if the connection is unstable.

Note

- This function is only available when [Bluetooth Mode] is set to [Transmitter] and [Bluetooth Codec - LDAC] is set to [On].

[211] Adjusting Settings | Zone Settings

Setting whether or not to display [Zone Controls] on the home menu (Zone Controls)

You can set whether or not to display [Zone Controls] on the home menu by following the steps below.

- 1 Select [Setup] - [Zone Settings] from the home menu.
- 2 Select [Zone Controls].

3 Select the setting you want.

- **Show:** [Zone Controls] is displayed on the home menu.
- **Hide:** [Zone Controls] is not displayed on the home menu.

[212] Adjusting Settings | Zone Settings

Setting the volume control for Zone 2 (Zone2 Line Out)

You can set variable or fixed volume control for the AUDIO ZONE 2 OUT jacks.

1 Select [Setup] - [Zone Settings] from the home menu.

2 Select [Zone2 Line Out].

3 Select the setting you want.

- **Variable:**
Recommended when using another amplifier that does not have volume control for Zone 2.
The volume for the AUDIO ZONE 2 OUT jacks can be changed.
- **Fixed:**
Recommended when using another amplifier with variable volume control for Zone 2.
The volume for the AUDIO ZONE 2 OUT jacks is fixed.

Note

- When [Variable] is set, the volume is turned down by default. Turn up the volume while listening to the sound after completing setup. The volume for the SPEAKERS ZONE 2 (*1) or SPEAKERS SURROUND BACK/HEIGHT (*2) terminals is changed together with the volume for the AUDIO ZONE 2 OUT jacks.

*1 For USA and Canadian models only

*2 For other models only

[213] Adjusting Settings | System Settings

Selecting the language (Language) (for USA, Canadian, European and Australian models only)

You can select the language of messages on the screen.

1 Select [Setup] - [System Settings] from the home menu.

2 Select [Language].

3 Select the language you want.

Note

- When the Control for HDMI function on both the receiver and the TV (BRAVIA TV) is turned on, the on-screen display language of the receiver is changed simultaneously when changing the language for the on-screen display of the TV.

[214] Adjusting Settings | System Settings

Tuning on/off the display for the volume level or sound field (Auto Display)

This function allows you to turn the information display which appears on the TV screen on or off when the volume level or sound field, etc. of the receiver is changed.

1 Select [Setup] - [System Settings] from the home menu.

2 Select [Auto Display].

3 Select [On] or [Off].

[215] Adjusting Settings | System Settings

Setting standby mode (Auto Standby)

You can set the receiver to switch to standby mode automatically when you do not operate the receiver or when no signals are input to the receiver.

1 Select [Setup] - [System Settings] from the home menu.

2 Select [Auto Standby].

3 Select [On] or [Off].

When you select [On], the receiver switches to standby mode automatically in about 20 minutes if there is no operation.

Note

- This function does not work in the following cases:
 - [FM TUNER] is selected as the input.
 - The software of the receiver is being updated.
 - BLUETOOTH receiver (headphones/speakers) are connected.
- If you use the Auto Standby mode and the sleep timer at the same time, the sleep timer has priority.

[216] Adjusting Settings | System Settings

Switching the brightness of the display panel (Dimmer)

Switch the brightness of the display panel.

- 1 Select [Setup] - [System Settings] from the home menu.
- 2 Select [Dimmer].
- 3 Select the setting you want.
 - Bright
 - Dark
 - Off

Hint

- You can also select the setting using the DIMMER button on the receiver.

[217] Adjusting Settings | System Settings

Using the sleep timer (Sleep)

You can set the receiver to turn off automatically after a specified period of time.

- 1 Select [Setup] - [System Settings] from the home menu.
- 2 Select [Sleep].
- 3 Set specified time.

- 2:00:00
- 1:30:00
- 1:00:00
- 0:30:00
- Off

[SLEEP] lights up on the display panel of the receiver when sleep timer is being used.

Hint

- You can check the remaining time before the receiver turns off on the System Settings screen. Also, the remaining time appears on the bottom right of the TV screen when it becomes 1 minute or less.
- The sleep timer will be canceled if you perform the following:
 - Select [Off] in step 3.
 - Turn the receiver on or off.
 - Update the software of the receiver.

[218] Adjusting Settings | System Settings

Receiving information on newer software (Software Update Notification)

You can set whether or not to be informed of newer software version information on the TV screen.

- 1 Select [Setup] - [System Settings] from the home menu.
- 2 Select [Software Update Notification].
- 3 Select [On] or [Off].

Note

- New software version information does not appear in the following cases:
 - The latest version is already being used.
 - The receiver cannot obtain data via a network.

[219] Adjusting Settings | System Settings

Deleting personal data (Initialize Personal Information)

You can erase personal information stored in the receiver.

If you dispose of, transfer or resell this receiver, please delete all personal information for security purposes. Please take any appropriate measures, such as logging out of any network

services you have used.

- 1 Select **[Setup]** - **[System Settings]** from the home menu.
- 2 Select **[Initialize Personal Information]**.
- 3 Follow the on-screen instructions.

Note

- This operation deletes the history for content input using the on-screen keyboard.
- If you have been playing the music on the receiver using Spotify Connect, this operation will delete your account information and Spotify Preset saved on the receiver, and you will be unable to resume Spotify playback when you press MUSIC SERVICE.

[220] Adjusting Settings | System Settings

Assigning a name to the receiver (Device Name)

You can assign a device name to the receiver to make it easily recognizable by other devices.

- 1 Select **[Setup]** - **[System Settings]** from the home menu.
- 2 Select **[Device Name]**.
An on-screen keyboard appears on the TV screen.
- 3 Press **▲/▼/◀/▶** and **[]** to select characters one by one to enter the name.
- 4 Select **[Enter]**.
The name you entered is registered.

[221] Adjusting Settings | System Settings

Checking the software version and MAC address of the receiver (System Information)

You can display the software version information and MAC address of the receiver.



- 1 Select [Setup] - [System Settings] from the home menu.
- 2 Select [System Information].

[222] Adjusting Settings | System Settings

Checking software license information (Software License Information)

You can display the software license information.

- 1 Select [Setup] - [System Settings] from the home menu.
- 2 Select [Software License Information].
- 3 Follow the on-screen instructions.

[223] Adjusting Settings | System Settings

Updating the software automatically (Auto Update Settings)

You can set the software to update automatically. If you set [Auto Update] to [On], the auto update is performed from 2:00 AM to 5:00 AM of the selected time zone.

- 1 Select [Setup] - [System Settings] from the home menu.
- 2 Select [Auto Update Settings].
- 3 Select [Auto Update] and set to [On].
- 4 Confirm [Time Zone] is selected and then press .
- 5 Select the area and then select the nearest city to where you live.

Note

- To use the auto update function, set [Auto Update] to [On].

- To update the software at the midnight while the receiver is not used, set [Auto Update] to [On] and also set [Network Standby] (*) to [On].
- If [Auto Update] is set to [On] while [Network Standby] (*) is set to [Off], update starts automatically while the receiver is turned off.
- Depending on the provided update type, the update may start automatically even if [Auto Update] is set to [Off], or the update may start automatically while the receiver is turned off.

* For USA, Canadian and Asia-Pacific models only

[224] Adjusting Settings | System Settings

Updating the software (Software Update)

1 Select [Setup] - [System Settings] from the home menu.

2 Select [Software Update].

3 Select [Update via Internet] or [Update via USB Memory].

If you select [Update via USB Memory], please visit the customer support website to download the latest software version.

4 Update the software.

[UPDATING] flashes on the display panel during the software update process. However, [UPDATING] may disappear temporary during updating.

When the update is completed, [COMPLETE] appears on the display panel and the receiver restarts automatically.

Note

- It may take about 1 hour for the update to be completed.
- Do not turn the receiver off while the software is being updated. It may cause a malfunction.
- You cannot restore the old version after updating the software.

[225] Adjusting Settings | Using the menu on the display panel

Operating the receiver with the menu on the display panel

You can operate this receiver using the display panel even if the TV is not connected to the receiver.



1 Press AMP MENU.

The menu is displayed on the display panel of the receiver.

2 Press ▲/▼ repeatedly to select the menu you want, then press [↵].

3 Press ▲/▼ repeatedly to select the parameter you want to adjust, then press [↵].

4 Press ▲/▼ repeatedly to select the setting you want, then press [↵].

To return to the previous display

Press ◀ or BACK.

To exit the menu

Press AMP MENU.

Note

- Some parameters and settings may appear dimmed on the display panel. This means that they are either unavailable or fixed and unchangeable.

[226] Adjusting Settings | Using the menu on the display panel

Viewing information on the display panel

The display panel provides various information on the status of the receiver, such as the sound field.

1 Select the input for which you want to check information.

2 Press DISPLAY MODE on the receiver repeatedly.

Each time you press DISPLAY MODE, the display will change cyclically as follows:
Index name of the input (*1) - Input you selected - Sound field currently applied (*2) -
Volume level - Stream information (*3)

When listening to FM radio

Preset station name (*1) - Frequency - Sound field currently applied (*2) - Volume level

When receiving RDS broadcasts (for European and Asia-Pacific models only)

Program service name or preset station name (*1) - Frequency, band and preset number -
Sound field currently applied (*2) - Volume level

*1 Index name appears only when you have assigned one to the input or preset station. Index name does not appear if only blank spaces have been entered or it is same as the input name.

*2 [PURE.DIRECT] appears on the display panel when the Pure Direct function is activated.

*3 Stream information may not be displayed.

Note

- Characters or marks in some languages may not be displayed.

[227] Adjusting Settings

Reverting to the factory default settings

You can clear all memorized settings and restore the receiver to the factory default settings by the following procedure. This procedure can also be used to initialize the receiver before you use it for the first time.

Be sure to use the buttons on the receiver to perform this operation.

1 Turn off the receiver.

2 Hold down  (power) on the receiver for 5 seconds.

[CLEARING] flashes on the display panel for a while, then changes to [CLEARED !].

Note

- It takes a few minutes for the memory to be cleared completely. Do not turn the receiver off until [CLEARED !] appears on the display panel.

[228] Troubleshooting | Error messages

PROTECTOR

The receiver will automatically turn off after a few seconds. Check the followings:

- There may be an electrical surge or power failure. Unplug the AC power cord (mains lead) and then plug in the cord again after 30 minutes.
- The receiver may be covered and the ventilation holes are blocked. Remove the object covering the ventilation holes of the receiver.
- The impedance of the connected speakers may be below the rated impedance range indicated on the back panel of the receiver. Connect speakers whose impedance falls within the range.
- Unplug the AC power cord (mains lead) and let the receiver cool down for 30 minutes while performing the following troubleshooting:
 - Disconnect all of the speakers and subwoofer.
 - Check that the speaker wires are tightly twisted on both ends.
 - Connect the front speaker first, increase the volume level and operate the receiver for at least 30 minutes until it completely warms up. Then, connect each additional speaker one by one and test each additional speaker until you detect which speaker is causing the protection error.

After checking the above items and fixing any problems, plug in the AC power cord (mains lead) and turn on the receiver. If the problem persists, consult your nearest Sony dealer.

[229] Troubleshooting | Error messages

[Overload occurred.] appears on the TV screen.

An over-current from the USB port was detected. Disconnect the USB device as prompted in the warning message and close the message.

[230] Troubleshooting | Error messages

List of messages after Auto Calibration measurements

- **Code 30:**
Headphones are connected. Please disconnect the headphones and retry calibration.
- **Code 31:**
The front speakers are not selected correctly. Select the correct front speaker configuration using SPEAKERS on the front panel of the receiver. Make sure that the receiver outputs sound and then try calibrating again.
- **Code 32, Code 33:**
 - Sound is not detected from speakers.
 - Sound is not detected from one or both of the front speakers. Ensure the calibration microphone is not damaged, and is connected to the CALIBRATION MIC jack on the front panel of the receiver, and that all speakers are properly connected.
 - Sound is not detected from either the left or right surround speakers. Ensure both the surround speakers are connected to the SURROUND terminals.
 - A surround back speaker is connected only to the SURROUND BACK/HEIGHT R terminals. If connecting only one surround back speaker, connect it to the SURROUND BACK/HEIGHT L terminals.
 - Sound is not detected from either the left or right height speakers. Ensure both the height speakers are connected to the SURROUND BACK/HEIGHT terminals.
 - Sound is not detected from any speakers. Please ensure the calibration microphone is not damaged and its plug is inserted all the way into the CALIBRATION MIC jack on the front panel of the receiver.
- **Code 34:**
The speakers are not placed in the proper positions. The left and right speakers or the left and right sides of the calibration microphone may be switched.
- **Code 35:**
The speaker pattern configuration does not match calibration result. Please check the speaker pattern and connection.
- **Warning 40:**
The measurement has been completed, but the noise level is high. For best results, calibrate in as quiet a place as possible.
- **Warning 41, Warning 42:**
The input signal from the calibration microphone is too large. The microphone may be too close to the speakers. Please place the calibration microphone at your desired listening position. Please note, when using the receiver as a pre-amplifier, this message may appear

by mistake. Please disregard.

- **Warning 43:**
The distance and phase of the subwoofer cannot be detected. Please check the subwoofer and re-calibrate in a quiet environment.
- **Warning 44:**
The measurement has been completed, but the speaker may need to be re-positioned.

[231] Troubleshooting | General

The receiver is turned off automatically.

- [Auto Standby] is set to [On] in the [System Settings] menu.
- The sleep timer function was activated.
- [PROTECTOR] was activated.

[232] Troubleshooting | General

Cannot find an available input when connecting several digital devices.

You can reassign the COAXIAL/OPTICAL digital audio input jacks to other inputs. See "[Using other audio input jacks \(Input Assign\)](#)."

[233] Troubleshooting | General

The receiver does not turn on even when the TV is turned on.

- Set [Control for HDMI] to [On] in the [HDMI Settings] menu. The TV must support the Control for HDMI function. For details, refer to the operating instructions of your TV.
- Check the speaker settings of the TV. The receiver power syncs with the speaker settings of the TV. For details, refer to the operating instructions of the TV.
- If sound was output from the speakers of the TV last time, the receiver does not turn on even when the TV is turned on.

[234] Troubleshooting | General

The receiver turns off when the TV is turned off.

- Check [Standby Linked to TV] in the [HDMI Settings] menu. When the function is set to [On], the receiver automatically turns off interlocked with the TV-power off operation, regardless of

the input of the receiver.

[235] Troubleshooting | General

The receiver does not turn off even when the TV is turned off.

- Check [Standby Linked to TV] in the [HDMI Settings] menu.
If you want the receiver to turn off when the TV is turned off regardless of the input of the receiver, set [Standby Linked to TV] to [On]. The TV must support the Control for HDMI function. For details, refer to the operating instructions of your TV.
- Set [Setup] - [HDMI Settings] - [Control for HDMI] to [On]. The TV must support the Control for HDMI function. For details, refer to the operating instructions of your TV.

[236] Troubleshooting | Image

No image appears on the TV screen.

- Try pressing the input button on the remote control or turning INPUT SELECTOR on the receiver to select the input to which you want to listen.
- Set your TV to the appropriate input mode.
- Make sure that cables are correctly and securely connected to devices.
- Disconnect the HDMI cable from the receiver and TV and then reconnect the cable.
- Set [HDMI Signal Format] of the selected input to [Standard format] in the [HDMI Settings] menu.
- Some playback devices need to be set up. Refer to the operating instructions supplied with each device.
- Be sure to use a High Speed HDMI Cable with Ethernet when you view images or listen to sound, especially for 1080p, Deep Color (Deep Colour), 4K or 3D transmission. Premium High Speed HDMI Cable with Ethernet that supports 18 Gbps is required for 4K/60p 4:4:4, 4:2:2 and 4K/60p 4:2:0 10 bit etc.
- The output of the HDMI video signals of the receiver may be set to [HDMI OFF]. In this case, press HDMI OUT to set to [HDMI A], [HDMI B], or [HDMI A + B].
- If you want to play HDCP 2.2 content, connect the receiver to an HDMI input jack of a TV that supports HDCP 2.2.

[237] Troubleshooting | Image

No 3D content appears on the TV screen.

- Depending on the TV or the video device, 3D content may not be displayed. Check the HDMI video formats supported by the receiver.
- Be sure to use a High Speed HDMI Cable with Ethernet.

[238] Troubleshooting | Image

No 4K content appears on the TV screen.

- Depending on the TV or the video device, 4K content may not be displayed. Check the video capability and settings of your TV and video device.
- Be sure to use a High Speed HDMI Cable with Ethernet.
- When you use high bandwidth video formats such as 4K/60p 4:4:4, 4:2:2 and 4K/60p 4:2:0 10 bit, a Premium High Speed HDMI Cable with Ethernet, which can support bandwidth up to 18 Gbps, is required.
- If your TV has similar menu for high bandwidth video format, check the setting on the TV menu when you set [HDMI Signal Format] to [Enhanced format] on this receiver. For details on the setting of the TV menu, refer to the operating instructions of the TV.
- Be sure to connect the receiver to an HDMI input jack of a TV or video device that supports 4K. You have to connect an HDMI cable to an HDMI jack that supports HDCP 2.2 when you use a playback device for 4K resolution video content, etc.

[239] Troubleshooting | Image

No image is output from the TV screen when the receiver is in standby mode.

- When the receiver enters standby mode, the image from the last HDMI device selected before you turned off the receiver is displayed. If you are enjoying content from another device, play the content on the device and perform the One-Touch Play operation, or turn on the receiver to select the HDMI device from which you want to enjoy content.
- Make sure [Standby Through] is set to [On] or [Auto] in the [HDMI Settings] menu.

[240] Troubleshooting | Image

The home menu does not appear on the TV screen.

- The home menu can only be used when you connect the TV to an HDMI OUT jack.
- When you want to display the menu on the TV screen connected to the HDMI OUT B/HDMI ZONE jack, set [HDMI Out B Mode] to [Main].
- Press HOME to display the home menu.
- Check that the TV is connected correctly.
- Disconnect the HDMI cable from the receiver and TV and then reconnect the cable.
- Check that the appropriate input is selected on the TV.
- Select the HDMI input to which the receiver is connected.
- The home menu may take some time to appear on the TV screen depending on the TV.

[241] Troubleshooting | Image

HDR (High Dynamic Range) images cannot be

displayed in HDR mode.

- Depending on the TV or video equipment, HDR images may not be displayed in HDR mode. Check the video capability and setting of your TV or video equipment.
- Some video equipment may not output HDR contents in HDR mode if [HDMI Signal Format] is set to [Standard format], even if both TV and video equipment support HDR and 18 Gbps band width. In this case, set [HDMI Signal Format] of selected input to [Enhanced format] in the [HDMI Settings] menu. When you select [Enhanced format], use Premium High Speed HDMI cables with Ethernet which can support bandwidth up to 18 Gbps.
- When you connect two Dolby Vision-compatible TVs to the receiver and select [HDMI A+B], Dolby Vision content is output in the HDR10 or SDR (Standard Dynamic Range) format. To enjoy Dolby Vision content as it is, connect only one Dolby Vision-compatible TV to the receiver, or select either [HDMI A] or [HDMI B].

[242] Troubleshooting | Image

Display does not appear on the display panel.

- If the PURE DIRECT indicator on the front panel lights up, press PURE DIRECT to turn off this function.
- Press DIMMER on the receiver to select [BRIGHT] or [DARK].

[243] Troubleshooting | Image

Image does not appear on the TV screen when the receiver is not turned on.

- Set [Control for HDMI] to [On], and then set [Standby Through] to [Auto] or [On] in the [HDMI Settings] menu.
- Turn on the receiver, then select the input to which the playing device is connected.
- If connected to other devices than those manufactured by Sony that support the Control for HDMI function, set [Control for HDMI] to [On] in the [HDMI Settings] menu.

[244] Troubleshooting | Image

When the language for the on-screen display of the TV is changed, the on-screen display language of the receiver is changed simultaneously.

- Check [Control for HDMI] to [On] in the [HDMI Settings] menu. If [Control for HDMI] is set to [On], the on-screen display language of the receiver may be changed simultaneously when you change the language for the on-screen display of the TV. Select the language on the receiver again to return to the previous setting.

No sound or only a very low level of sound is heard, no matter which device is selected.

- Check that all connecting cables are inserted to their input/output jacks on the receiver, speakers and the devices.
- Check that the receiver and all devices are turned on.
- Check that MASTER VOLUME on the receiver is not set to [VOL MIN].
- Press SPEAKERS on the receiver to select a setting other than [SPK OFF].
- Check that headphones are not connected to the receiver.
- Press \times to cancel the muting function.
- Try pressing the input button on the remote control or turning INPUT SELECTOR on the receiver to select the input to which you want to listen.
- If you want to listen to sound from the TV speaker, set [Audio Out] to [TV + AMP] in the [HDMI Settings] menu. If you cannot play multi-channel audio source, set to [AMP]. However, the sound will not be output through the TV speaker.
- Sound may be interrupted when the sampling frequency, number of channels or audio format of audio output signals from the playback device is switched.
- If you are listening with BLUETOOTH headphones/speakers, check that the [Bluetooth Mode] is set to [Transmitter] in the [Bluetooth Settings] menu.
- If you set the speaker pattern to a setting that does not have center speaker, no sound is output from the center channel when [DSD Native] is set to [On] and a DSD multi-channel source is played back.
- If you set the speaker pattern to a setting that does not have surround speakers, no sound is output from the surround channels when [DSD Native] is set to [On] and a DSD multi-channel source is played back.
- If you set the sound field to [2ch Stereo], no sound is output from the center channel and surround channels when [DSD Native] is set to [On] and a DSD multi-channel source is played back.
- DSD signals from [USB] or [Home Network] cannot be output to the Zone 2 speakers if you set [DSD Native] to [On] in the [Audio Settings] menu.

There is severe humming or noise.

- Check that the speakers and device are connected securely.
- Make sure that the connecting cables are not near a transformer or motor.
- Move your audio device away from the TV.
- If the plugs and jacks are dirty, wipe them with a cloth slightly moistened with alcohol.

No sound or only a very low level of sound is heard from specific speakers.

-
- Connect a pair of headphones to the PHONES jack to verify that sound is output from the headphones. If only one channel is output from the headphones, the device may not be connected to the receiver correctly. Check that all of the cables are fully inserted into the jacks on both the receiver and the device.
If both channels are output from the headphones, the front speaker may not be connected to the receiver correctly. Check the connection of the front speaker that is not outputting any sound.
 - Make sure you have connected to both the L and R jacks of an analog device, as analog devices require both L and R jack connections. Use an audio cable (not supplied).
 - Adjust the speaker level.
 - Check that the speaker settings are appropriate for the setup using [Auto Calibration] or [Speaker Pattern] in the [Speaker Settings] menu. Then check that sound is output from each speaker correctly using [Test Tone] in the [Speaker Settings] menu.
 - Check that the subwoofer is connected correctly and securely.
 - Make sure you have turned on your subwoofer.
 - Check the volume level of the subwoofer.
 - Depending on the selected sound field, sound may not be available from the subwoofer.
 - When you play content in the DTS format, sound may not be output from the height speakers in the following cases:
 - [A.F.D.] is selected as the sound field setting.
 - The speaker pattern is set to [5.1.2 (TM)], [5.1.2 (FD)], or [5.1.2 (SRD)].

[248] Troubleshooting | Sound

There is no sound from a specific device.

- Check that the device is correctly connected to the corresponding audio input jacks.
- Check that the cable(s) used for the connection is (are) fully inserted into the jacks on both the receiver and the device.
- Check the Input Mode setting in the [Input Settings] menu.
- Check that the device is correctly connected to the corresponding HDMI jack.
- The HDMI settings of some playback devices need to be configured. Refer to the operating instructions supplied with each device.
- Be sure to use a High Speed HDMI Cable with Ethernet when you view images or listen to sound, especially for 1080p, Deep Color (Deep Colour), 4K or 3D transmission. Premium High Speed HDMI Cable with Ethernet that supports 18 Gbps is required for 4K/60p 4:4:4, 4:2:2 and 4K/60p 4:2:0 10 bit etc.
- Sound may not be output from the receiver while the home menu is displayed on the TV screen. Press HOME to exit the home menu.
- Audio signals (format, sampling frequency, bit length, etc.) transmitted from an HDMI jack may be suppressed by the connected device. Check the setup of a device connected via an HDMI cable if the image is poor or the sound does not come out of the device.
- When a connected device does not support the copyright protection technology (HDCP), the image and/or the sound from the HDMI OUT A (TV) and HDMI OUT B/HDMI ZONE jacks may be distorted or may not be output. If this is the case, check the specifications of the connected device.
- Set the image resolution of the playback device to more than 720p/1080i to enjoy High Bitrate Audio (DTS-HD Master Audio, Dolby TrueHD).
- The image resolution of the playback device may need to be configured to certain settings before you can enjoy DSD and Multi Channel Linear PCM. Refer to the operating instructions of the playback device.
- Make sure the TV supports the System Audio Control function.
- If the TV does not have a System Audio Control function, set [Audio Out] in the [HDMI Settings] menu to:

- [TV + AMP] if you want to listen to the sound from the TV speaker and receiver.
- [AMP] if you want to listen to the sound from the receiver only.
- When you connect the receiver to a video device (projector, etc.), sound may not be output from the receiver. In this case, set [Audio Out] to [AMP] in the [HDMI Settings] menu.
- You cannot listen to the sound of a device connected to the receiver while TV input is selected on the receiver.
 - Be sure to change the input of the receiver to HDMI if you want to watch a program on a device connected via HDMI connection to the receiver.
 - Change the TV channel if you want to watch a TV broadcast.
 - Be sure to select the correct device or input when watching a program from a device connected to the TV. Refer to the section on this operation in the operating instructions of the TV.
- Check that the selected digital audio input jack is not assigned to another input.

[249] Troubleshooting | Sound

The left and right sound is unbalanced or reversed.

- Check that the speakers and device are connected correctly and securely.
- Adjust the sound level parameters using [Level] in the [Speaker Settings] menu.

[250] Troubleshooting | Sound

Dolby Digital or DTS multi-channel sound is not reproduced.

- Check that the DVD, etc., you are playing is recorded in Dolby Digital or DTS format.
- When connecting the DVD player, etc., to the digital input jacks of this receiver, make sure the digital audio output setting of the connected device is available.
- Set [Audio Out] to [AMP] in the [HDMI Settings] menu.
- You can only enjoy High Bitrate Audio (DTS-HD Master Audio and Dolby TrueHD) and object-based audio formats (DTS:X and Dolby Atmos) with an HDMI connection.
- .

[251] Troubleshooting | Sound

The surround effect cannot be obtained.

- Be sure to select the optimal sound field for the content. For details on the sound fields, see [“Selectable sound fields and their effects.”](#)
- [Dolby Surround] and [Neural:X] do not work when the speaker pattern is set to [2.0] or [2.1].

[252] Troubleshooting | Sound

A test tone is not output from the speakers.

- The speaker cables may not be connected securely. Check that they are connected securely and cannot be disconnected by pulling on them slightly.
- The speaker cables may have short-circuited.

[253] Troubleshooting | Sound

A test tone is output from a different speaker than the speaker displayed on the TV screen.

- The speaker pattern setting is incorrect. Make sure that the speaker connections and the speaker pattern match correctly.

[254] Troubleshooting | Sound

No sound is output from the TV when the receiver is in standby mode.

- When the receiver enters standby mode, sound is output from the last HDMI device selected before you turned off the receiver. If you are enjoying content from another device, play the content on the device and perform the One-Touch Play operation, or turn on the receiver to select the HDMI device from which you want to enjoy content.
- Make sure [Standby Through] is set to [On] or [Auto] in the [HDMI Settings] menu.

[255] Troubleshooting | Sound

No TV sound is output from the receiver.

- Check the type and connection of the HDMI cable, optical digital cable, or audio cable that is connected to the receiver and the TV (refer to the supplied Startup Guide).
- When the receiver is connected to a TV compatible with the Audio Return Channel (ARC) function, make sure the receiver is connected to an HDMI jack compatible with the Audio Return Channel (ARC) function (refer to the supplied Startup Guide). If sound is still not output or if sound is interrupted, connect the optical digital cable (not supplied) and set on the receiver [Setup] - [HDMI Settings] - [Control for HDMI] to [Off].
- If the TV is not compatible with the Audio Return Channel (ARC) function, connect the receiver to the TV using an optical digital cable (not supplied) or audio cable (not supplied). There will be no TV sound from the connected speakers when the receiver is connected to an HDMI input jack of a TV that is not compatible with the Audio Return Channel (ARC) function.

- Switch input of the receiver to [TV].
- Increase the volume on the receiver or cancel muting.
- If the sound of a cable box or satellite box connected to the TV is not output, connect the device to an HDMI input jack of the receiver and switch the input of the receiver to the input for the connected device (refer to the supplied Startup Guide).
- Depending on the order in which you connect the TV and the receiver, the receiver may be muted and [Muting] is displayed on the display panel of the receiver. If this happens, turn on the TV first, then the receiver.
- Set the speaker setting of the TV (BRAVIA) to “Audio System.” Refer to the operating instructions of your TV regarding how to set the TV.

[256] Troubleshooting | Sound

Image and sound are not output from the TV when the receiver is not turned on.

- Set [Setup] - [HDMI Settings] - [Control for HDMI] to [On], and then set [Standby Through] to [Auto] or [On].
- Turn on the receiver, then select the input to which the playing device is connected.
- If connected to devices other than those manufactured by Sony that support the Control for HDMI function, set [Setup] - [HDMI Settings] - [Control for HDMI] to [On].
- Make sure the HDMI OUT is set to [HDMI A] or [HDMI A+B].

[257] Troubleshooting | Sound

The sound is output from both the receiver and the TV.

- Mute the sound of the receiver or the TV.

[258] Troubleshooting | Sound

When the Wireless Multi-Room function is active, the sound lags behind the picture.

- When you listen to sound from one of the following sources and watch video using the Wireless Multi-Room function, the sound is delayed in order to synchronize it with the sound output from the speakers in another location.
 - **A** Devices connected to the HDMI IN, OPTICAL IN, COAXIAL IN, or AUDIO IN jacks
 - **B** TVs compatible with the Audio Return Channel (ARC) function and connected to the HDMI OUT A (TV) jack

If the sound lag bothers you, deactivate the synchronization with speakers in another location (*) by the following procedure.

* If you deactivate the synchronization with other speakers, the sound and video output from the receiver will be synchronized, but the sound output from speakers in another location will be delayed.

If sound is input from **A :**

1. Press **OPTIONS**.
The options menu appears.
2. Select **[Multi-room Sync] - [Off]**.

If sound is input from **B :**

1. Press **AMP MENU**.
The menu is displayed on the display panel of the receiver.
2. Press **▲/▼** and **⊞** to select **[<AUDIO>] (Audio Settings) - [M/R SYNC] - [OFF]**.

[259] Troubleshooting | Tuner

The FM reception is poor.

- Extend and adjust the position of the FM wire antenna (aerial) to a place where the reception conditions are good.
- Place the FM wire antenna (aerial) near a window.
- Position the FM wire antenna (aerial) as horizontally as possible.

[260] Troubleshooting | Tuner

The FM stereo reception is poor.

Perform the following procedure to set the FM station receiving mode to the monaural mode.

- 1 Select **[Listen] - [FM TUNER]** from the home menu.
- 2 Select a station on the FM band.
- 3 Press **OPTIONS**.
- 4 Select **[FM Mode]** from the menu.
- 5 Select **[Monaural]**.

Note

- You can set FM mode in the options menu if the frequency indication is selected in step 3.

[261] Troubleshooting | Tuner

You cannot tune to radio stations.

- Check that the antennas (aerials) are connected securely. Adjust the antennas (aerials) if necessary.
- The signal of the stations is too weak with automatic tuning. Use direct tuning.
- No stations have been preset or the preset stations have been cleared (when tuning by scanning preset stations is used). Preset the stations.
- Press DISPLAY MODE on the receiver repeatedly so that the frequency appears on the display panel.

[262] Troubleshooting | Tuner

RDS does not work (for European and Asia-Pacific models only).

- Make sure that you are tuned to an FM RDS station.
- Select a stronger FM station.
- The station you tuned to is not transmitting the RDS signal or the signal is weak.

[263] Troubleshooting | Tuner

The RDS information that you want does not appear (for European and Asia-Pacific models only).

- The service may be temporarily out of order. Contact the radio station and find out whether they actually provide the service in question.

[264] Troubleshooting | USB devices

Are you using a compatible USB device?

- If you connect an incompatible USB device, the following problems may occur.
 - The USB device is not recognized.
 - File or folder names are not displayed on this receiver.
 - Playback is not possible.
 - The sound skips.
 - There is noise.
 - Distorted sound is output.

[265] Troubleshooting | USB devices

When the music on the USB device is played back, there is noise, skipping, or distorted sound.

- Turn off the receiver, reconnect the USB device, and then turn on the receiver.
- Check if the music data itself contains noise, or the sound is distorted.

[266] Troubleshooting | USB devices

A USB device is not recognized.

- Turn off the receiver, then disconnect the USB device. Turn on the receiver again and reconnect the USB device.
- Connect a compatible USB device.
- The USB device does not work properly. Refer to the section on how to deal with this problem in the operating instructions of the USB device.

[267] Troubleshooting | USB devices

Playback does not start.

- Turn off the receiver, reconnect the USB device, and then turn on the receiver.
- Connect a compatible USB device.
- Select [USB (Connected)] on the Listen screen and select a folder/track, then press ►|| to start playback.
- The receiver can recognize and play up to the following files or folders in USB devices:
 - up to folders in the 9th layer (including the root folder)
 - up to 500 files/folders in a single layer

[268] Troubleshooting | USB devices

A USB device cannot be connected to the USB port.

- The USB device is being connected upside down. Connect the USB device in the correct orientation.
 - Check the shape of the USB device's plug. If the shape does not fit the receiver's port, you will not be able to connect the USB device to the receiver.
-

Erroneous display.

- The data stored in the USB device may have been corrupted.
- The character codes that can be displayed by this receiver are as follows:
 - Upper case letters (A to Z)
 - Lower case letters (a to z)
 - Numbers (0 to 9)
 - Symbols (' = < > * + , - . / @ [\] _ `')

Other characters may not be displayed correctly.

An audio file cannot be played.

- MP3 files in MP3 PRO format cannot be played.
 - The audio file is a multiple track audio file.
 - Some AAC files may not be played correctly.
 - If you use a partitioned USB device, only audio files on the first partition can be played.
 - Playback is possible up to 9 levels (including the root folder).
 - There are more than 500 folders (including the root folder).
 - There are more than 500 files.
 - Files that are encrypted, protected by passwords, etc. cannot be played.
-

Cannot connect to the network using WPS via a wireless LAN connection.

- You cannot connect to a network using [Wi-Fi Protected Setup (WPS)] if your access point is set to WEP. Set up your network after searching the access point using the access point scan.
-

Cannot connect to the network.

- Check that the LAN cable is connected to the receiver when you want to connect the receiver to the network via a wired LAN connection.
- Check the network information. If the connection failed, set up the network connection again.
- If the receiver is connected through a wireless network, move the receiver and the wireless

LAN router/access point closer to each other and perform the setup again.

- Make sure that you use a wireless LAN router/access point.
- Make sure that the wireless LAN router/access point is turned on.
- Check the settings of the wireless LAN router/access point and perform the setup again. For details on the settings of devices, refer to the operating instructions of the devices.
- Wireless networks are influenced by electromagnetic radiation emitted by microwave ovens and other devices. Move the receiver away from these devices.

[273] Troubleshooting | Network connection

Cannot control the receiver using a SongPal device.

- It may take some time for the receiver to connect to the network after it is turned on. Try again later.
- The smartphone or tablet device may not be connected to the same network as the receiver. Connect to the same network and try again.
- Also see [“Controller devices or applications on the home network cannot connect to the receiver.”](#)
- Refer to the SongPal help.

[274] Troubleshooting | Network connection

Cannot control the receiver using a Video & TV SideView device.

- It may take some time for the receiver to connect to the network after it is turned on. Try again later.
- The smartphone or tablet device may not be connected to the same network as the receiver. Connect to the same network and try again.
- The receiver may have been removed from the Video & TV SideView device list. Remove the Video & TV SideView device from the receiver as well, and then register again.
- The Video & TV SideView device may have been removed from the receiver device list. Remove the receiver from the Video & TV SideView device list as well, and then register again.
- Also see [“Controller devices or applications on the home network cannot connect to the receiver.”](#)
- Also refer to the Video & TV SideView help.

[275] Troubleshooting | Network connection

Cannot select the [Network Settings] menu.

- Wait for a few moments after you have turned on the receiver, and then select the [Network Settings] menu again.

Cannot connect to the network.

- Make sure the router or the wireless LAN router/access point is turned on.
- The network settings on the receiver may be incorrect.
If the connection failed, set up the network connection again.
- Confirm that the receiver is connected to the router or the wireless LAN router/access point correctly.
- If the receiver is connected to a wireless network, move the receiver and the wireless LAN router/access point closer to each other.
- If you have initialized the receiver or performed a system recovery on your server, perform the network settings again.

A server does not appear in the server list. (A message that indicates that the receiver cannot find the server appears on the TV screen.)

- You may have turned on this receiver before you turned on the server. Refresh the server list.
- Make sure that the router or the wireless LAN router/access point is turned on.
- The server may require some settings to accept the connection from the receiver. Confirm that the server has been configured correctly. Confirm that the receiver is allowed to receive music streamed from the server.
- Confirm that the receiver and the server are connected to the router or the wireless LAN router/access point correctly. Check the network settings information.
- Refer to the operating instructions of your router or wireless LAN router/access point and check the multicast setting. Try turning the multicast setting on or off on the wireless LAN router/access point.
- If your server is a software application on your PC, check the firewall setup and the security software settings.

Cannot access to the server, etc., connected to the router via a wireless LAN connection.

- If connecting the receiver to the router via a wireless LAN connection, you may not access to the computer (home network server) connected to the router via a wireless LAN connection by other network name (SSID). In this case, it is possible that the network between the devices connected to the router is separated due to the security function of the router.
Connect both the receiver and the device such as the computer to the router via a wired LAN connection. Or, refer to the operating instruction of your wireless LAN router/access

point, and then try turning off the appropriate security function.

[279] Troubleshooting | Home network

Playback does not start, or the player does not automatically proceed to the next track or file.

- Make sure that the audio file you are trying to play is in a format supported by this receiver.
- Audio content with DRM (Digital Rights Management) copyright protection cannot be played on this receiver.
- Make sure that the repeat setting and shuffle setting are configured correctly. Press **OPTIONS**, then select [Repeat Setting] or [Shuffle Setting] from the options menu to set to the playback mode.
- The receiver can recognize and play up to the following files or folders stored in the home network server:
 - up to folders in the 19th layer
 - up to 999 files/folders in a single layer

[280] Troubleshooting | Home network

The sound skips during playback.

- The bandwidth of your network may be too low. Check your router and the network environment.
- The bandwidth of your network may be too low. If using wireless LAN connection, move the receiver and the wireless LAN router/access point closer to each other, without any obstructions between them.
- The server may be busy. If using your computer as a server, the computer may be running too many applications. If anti-virus software is active on the computer, temporarily disable it as anti-virus software needs a large amount of system resources.
- Depending on the network environment, it may not be possible to play tracks with more than one device operating at the same time. Turn off other devices to enable the receiver to play tracks.

[281] Troubleshooting | Home network

[No playable file in this category.] appears.

- If there are no folders or files that can be played on the receiver in the selected folder, you cannot expand the folder to display its content.
-

Cannot play copyrighted files.

- Audio content with DRM (Digital Rights Management) copyright protection cannot be played on this receiver.

Cannot select a previously selected track.

- The track information may have been changed on the server. Refresh the server list and then reselect the server.

Controller devices or applications on the home network cannot connect to the receiver.

- Confirm that the network is correctly set up.
- Your smartphone/tablet may be set to [Block] in [Home Network Access Control], or not added to the list. If the maximum number of connectable devices has been exceeded, delete unnecessary devices from the device list and then set [Auto Home Network Access Permission] to [On].
- Server operation of the receiver is suspended if the receiver is conducting one of the following operations:
 - Playing content stored on the server (the receiver is operating as a player)
 - Updating the software
 - Displaying setting screen
- [External Control] may be set to [Off]. Set it to [On] to allow a home automation controller to connect to the receiver.
- When using Video & TV SideView, also see "[Cannot control the receiver using a Video & TV SideView device.](#)"
- When using SongPal, also see "[Cannot control the receiver using a SongPal device.](#)"

The receiver cannot be turned on by devices on a network.

- Set [Remote Start] to [On] if you want to turn the receiver on by operating the devices on a network (for USA, Canadian and Asia-Pacific models only).

[286] Troubleshooting | AirPlay

The receiver cannot be found from an iPhone/iPad/iPod or iTunes.

- Make sure the receiver and the iPhone/iPad/iPod or computer with iTunes is connected to the same network.
- Update the software of the receiver and the iPhone/iPad/iPod or iTunes to the latest version.

[287] Troubleshooting | AirPlay

The sound skips.

- The sound may skip depending on factors such as the network environment. Depending on the audio files, playback may require network speed. If you use a wired LAN connection, check the network hub and/or router. If you use a wireless LAN connection, check the router and/or access point.

[288] Troubleshooting | AirPlay

The receiver cannot be operated.

- Update the software of the iPhone/iPad/iPod or iTunes to the latest version.
- Update the software of the receiver to the latest version.
- Connection between the AirPlay device and receiver may be lost. Restart the AirPlay device and/or the receiver.
- The network connection between the iPhone/iPad/iPod or computer running iTunes, and the receiver may be unstable.
 - Check the status and settings of the router for the network.
 - Try restarting the router, the iPhone/iPad/iPod or computer running iTunes, and the receiver.
 - If using a wired LAN connection, make sure that the LAN cable is connected to the receiver securely and is not broken.
 - If using a wireless LAN connection, make sure that both of the receiver's wireless LAN antennas are pointing up. Additionally, try changing the positioning of the router and the receiver. Keep the receiver away from microwave ovens.

[289] Troubleshooting | Music services

Cannot connect the receiver to a service.

- Make sure that the router or the wireless LAN router/access point is turned on.

- Check [Network Connection Status]. If [Not accessible] or [Failed] appears, set up the network connection again.
- If the receiver is connected to a wireless network, move the receiver and the wireless LAN router/access point closer to each other.
- If your contract with your Internet provider limits Internet connection to one device at a time, this device will not be able to access the Internet when another device is already connected. Consult your carrier or service provider.

[290] Troubleshooting | Music services

The sound skips.

- The bandwidth of your network may be too low. If using wireless LAN connection, move the receiver and the wireless LAN router/access point closer to each other, without any obstructions between them.

[291] Troubleshooting | BLUETOOTH device

Pairing cannot be done.

- Move the BLUETOOTH device closer to the receiver.
- Pairing may not be possible if there are other BLUETOOTH devices near the receiver. In this case, turn off the other BLUETOOTH devices.
- Correctly enter the same passkey that was entered on the BLUETOOTH device.

[292] Troubleshooting | BLUETOOTH device

Cannot make a BLUETOOTH connection.

- Confirm that the BLUETOOTH mode is selected correctly.
- The BLUETOOTH device you attempted to connect does not support the A2DP profile, and cannot be connected with the receiver.
- Press CONNECTION  PAIRING BLUETOOTH on the receiver to connect to the last connected BLUETOOTH device.
- Turn on the BLUETOOTH function of the BLUETOOTH device.
- Establish a connection from the BLUETOOTH device.
- The pairing registration information has been erased. Perform the pairing operation again.
- While connected to a BLUETOOTH device, this receiver cannot be detected.
- Erase the pairing registration information of the BLUETOOTH device and perform the pairing operation again.

[293] Troubleshooting | BLUETOOTH device

The sound skips or fluctuates, or the connection is lost.

- The receiver and the BLUETOOTH device are too far apart.
- If there are obstructions between the receiver and your BLUETOOTH device, remove these or move the receiver and/or device avoid them.
- If there is a device that generates electromagnetic radiation, such as a wireless LAN, other BLUETOOTH device, or a microwave oven nearby, move it away.

[294] Troubleshooting | BLUETOOTH device

The sound of your BLUETOOTH device cannot be heard on the receiver.

- Turn up the volume on your BLUETOOTH device first, and then adjust the volume using  + on the remote control (or MASTER VOLUME on the receiver).

[295] Troubleshooting | BLUETOOTH device

Severe humming or noise.

- If there are obstructions between the receiver and your BLUETOOTH device, remove them or move the receiver and/or device avoid them.
- If there is a device that generates electromagnetic radiation, such as a wireless LAN, other BLUETOOTH device, or a microwave oven nearby, move it away.
- Turn down the volume of the connected BLUETOOTH device.

[296] Troubleshooting | BLUETOOTH device

Cannot control the receiver using a SongPal device.

- It may take some time for the receiver to connect to the network after it is turned on. Try again later.
- The smartphone or tablet device may not be connected to the same network as the receiver. Connect to the same network and try again.
- Also see [“Controller devices or applications on the home network cannot connect to the receiver.”](#)
- Refer to the SongPal help.

[297] Troubleshooting | “BRAVIA” Sync (Control for HDMI)

The Control for HDMI function does not work properly.

- Check the HDMI connection with the receiver (refer to the supplied Startup Guide).
- Enable the Control for HDMI function on the TV. For details, refer to the operating instructions of the TV.
- Wait for a while, and then try again. If you unplug the receiver, it will take a while before the operation is completed. Wait for 15 seconds or longer, and then try again.
- If you unplug the HDMI cable or change the connection, repeat the procedures of [“Preparing to use “BRAVIA” Sync function.”](#)
- Make sure your TV is connected to the HDMI OUT A (TV) jack of the receiver.
- Make sure the HDMI OUT setting is set to [HDMI A] or [HDMI A + B].
- Set [Control for HDMI] to [On] in the [HDMI Settings] menu.
- When [Control for HDMI] is set to [Off], “BRAVIA” Sync does not work properly, even if the device is connected to the HDMI IN jack.
- Make sure the connected device supports the Control for HDMI function.
- Enable the Control for HDMI function on the connected device. For details, refer to the operating instructions of the connected device.
- The types and number of devices that can be controlled by the “BRAVIA” Sync feature are restricted by the HDMI CEC standard as follows:
 - Recording devices (Blu-ray Disc recorders, DVD recorders, etc.): up to 3 devices
 - Playback devices (Blu-ray Disc players, DVD players, etc.): up to 3 devices
 - Tuner-related devices: up to 4 devices
 - Audio system (receiver/headphones): up to 1 device (used by this receiver)

[298] Troubleshooting | “BRAVIA” Sync (Control for HDMI)

TV sound cannot be heard from the speakers connected to the receiver.

- Make sure [Control for HDMI] is set to [On] in the [HDMI Settings] menu.
- Make sure [Input Mode] for the TV input is set to [Auto] in the [Input Settings] menu.
- Make sure your TV supports the Audio Return Channel (ARC) function. Make sure that the HDMI input of your TV is labeled “ARC.”
- If your TV has multiple HDMI input jacks, make sure the receiver is connected to the one supports the Audio Return Channel (ARC) function.
- Make sure your TV is connected to the HDMI OUT A (TV) jack of the receiver.
- Make sure the HDMI OUT setting is set to [HDMI A] or [HDMI A + B].

[299] Troubleshooting | Remote control

The remote control does not function.

- Point the remote control at the remote control sensor on the receiver.
 - Remove any obstructions between the remote control and the receiver.
 - Replace both of the batteries in the remote control with new ones if they are weak.
-

[300] Troubleshooting | If the problem is not solved

Reverting to the factory default settings

You can clear all memorized settings and restore the receiver to the factory default settings by the following procedure. This procedure can also be used to initialize the receiver before you use it for the first time.

Be sure to use the buttons on the receiver to perform this operation.

1 Turn off the receiver.

2 Hold down  (power) on the receiver for 5 seconds.

[CLEARING] flashes on the display panel for a while, then changes to [CLEARED !].

Note

- It takes a few minutes for the memory to be cleared completely. Do not turn the receiver off until [CLEARED !] appears on the display panel.

[301] Troubleshooting | If the problem is not solved

Resetting sound fields to the default settings

Be sure to use the buttons on the receiver to perform this operation.

1 Turn off the receiver.

2 Hold down MUSIC and press  (power) on the receiver.

[S.F. CLEAR] appears on the display panel and all sound fields are reset to their default setting.

[302] Troubleshooting | If the problem is not solved

Customer support websites

Refer to the following websites for the latest information on the receiver.

For customers in the USA:

<http://esupport.sony.com/>

For customers in Canada:

<http://esupport.sony.com/CA/>

For customers in Europe:

[303] Other Information

Trademarks

- This receiver incorporates Dolby (*1) Digital Surround and the DTS (*2) Digital Surround System.
 - *1 Manufactured under license from Dolby Laboratories. Dolby, Dolby Atmos, Dolby Vision, and the double-D symbol are trademarks of Dolby Laboratories.
 - *2 For DTS patents, see <http://patents.dts.com>. Manufactured under license from DTS, Inc. DTS, the Symbol, DTS in combination with the Symbol, DTS:X, and the DTS:X logo are registered trademarks or trademarks of DTS, Inc. in the United States and/or other countries. © DTS, Inc. All Rights Reserved.
- This receiver incorporates High-Definition Multimedia Interface (HDMI™) technology. The terms HDMI and HDMI High-Definition Multimedia Interface, and the HDMI Logo are trademarks or registered trademarks of HDMI Licensing, LLC in the United States and other countries.
- Apple, the Apple logo, AirPlay, iPad, iPhone, iPod, iPod touch, and Retina are trademarks of Apple Inc., registered in the U.S. and other countries. iPad Air and iPad mini are trademarks of Apple Inc. App Store is a service mark of Apple Inc., registered in the U.S. and other countries.
- “Made for iPod,” “Made for iPhone,” and “Made for iPad” mean that an electronic accessory has been designed to connect specifically to iPod, iPhone, or iPad, respectively, and has been certified by the developer to meet Apple performance standards. Apple is not responsible for the operation of this device or its compliance with safety and regulatory standards. Please note that the use of this accessory with iPod, iPhone, or iPad may affect wireless performance.
- Windows Media is either a registered trademark or trademark of Microsoft Corporation in the United States and/or other countries.
- This product is protected by certain intellectual property rights of Microsoft Corporation. Use or distribution of such technology outside of this product is prohibited without a license from Microsoft or an authorized Microsoft subsidiary.
- LDAC™ and LDAC logo are trademarks of Sony Corporation.
- MPEG Layer-3 audio coding technology and patents licensed from Fraunhofer IIS and Thomson.
- “BRAVIA” is a trademark of Sony Corporation.
- “PlayStation” is a registered trademark of Sony Computer Entertainment Inc.
- “WALKMAN” and “WALKMAN” logo are registered trademarks of Sony Corporation.
- MICROVAULT is a trademark of Sony Corporation.
- Wi-Fi®, and Wi-Fi Alliance® are registered trademarks of Wi-Fi Alliance®.
- WPA™, WPA2™ and Wi-Fi Protected Setup™ are trademarks of Wi-Fi Alliance®.
- DLNA™, the DLNA Logo and DLNA CERTIFIED™ are trademarks, service marks, or certification marks of the Digital Living Network Alliance.
- The BLUETOOTH® word mark and logos are registered trademarks owned by Bluetooth SIG, Inc. and any use of such marks by Sony Corporation is under license. Other trademarks and trade names are those of their respective owners.
- The N-Mark is a trademark or registered trademark of NFC Forum, Inc. in the United States and in other countries.
- Android™, Google Play™ and Chromecast are trademarks of Google Inc.
- This product incorporates Spotify software which is subject to 3rd party licenses found here (*3):
<https://developer.spotify.com/esdk-third-party-licenses/>
Spotify and Spotify logos are trademarks of the Spotify Group (*3).

*3 This function may not be available in some countries/regions.

- All other trademarks and registered trademarks are of their respective holders. In this manual, ™ and ® marks are not specified.
- For details of the EULA for network services, please refer to [License agreement] in options menu on each network service icon.
For details of the GPL, LGPL and other software licenses, please refer to [Software License Information] in [System Settings] of the [Setup] menu on the product.
- This product contains software that is subject to the GNU General Public License (“GPL”) or GNU Lesser General Public License (“LGPL”). These establish that customers have the right to acquire, modify, and redistribute the source code of said software in accordance with the terms of the GPL or the LGPL.
- The source code for the software used in this product is subject to the GPL and LGPL, and is available on the Web. To download, please access the following:
URL: <http://oss.sony.net/Products/Linux/>
Please note that Sony cannot answer or respond to any inquiries regarding the content of this source code.

How to connect speaker cables

Be sure to connect the speaker cables correctly to the terminals of the speaker and this receiver.

Also, be sure to tightly twist the speaker wire strands and insert them securely into the speaker terminals.

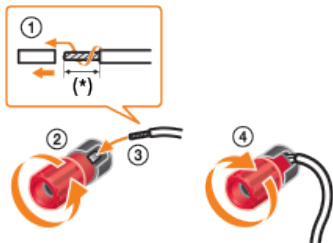

* Strip the jacket to 10 mm (13/32 in) at each end of the speaker cables.

Note

- Be sure not to remove too much of the speaker cable sleeves, so as to prevent the wires of the speaker cables from touching each other.
- Connect speaker cables properly with the polarities (+/-) matched between the receiver and the speakers.



- Improper connection may result in fatal damage to the receiver.
-

Confirming active subwoofer setup

- When a subwoofer is connected, turn on the subwoofer and turn up the volume prior to activating the subwoofer. Turn the LEVEL to just before the mid-point.



- If you connect a subwoofer with a crossover frequency function, set the value to maximum.



- If you connect a subwoofer with an auto standby function, set it to off (deactivated). For details, refer to the operating instructions of the subwoofer.

Note

- Depending on the characteristics of the subwoofer you are using, the setup distance value may be different from the actual position.

Checking the information of a connected BLUETOOTH device

You can check the BLUETOOTH device information by pressing DISPLAY MODE on the receiver repeatedly.

Each time you press DISPLAY MODE, the display will change cyclically as follows:

- **During BLUETOOTH RX mode:** Input you are selecting - BLUETOOTH device name - Sound field currently applied - Volume level
- **During BLUETOOTH TX mode:** BLUETOOTH device name - Sound field currently applied - Volume level - Input you are selecting

Menu list (on the display panel)

The following options are available in each menu.

Press AMP MENU to display the menu on the display panel.

Auto Calibration settings [<AUTO CAL>]

- **Auto Calibration start [A.CAL START]**
- **Auto Calibration type [CAL TYPE] (*1)**
FULL FLAT, ENGINEER, FRONT REF, OFF
- **Calibration Matching [C.MATCH?] (*1)**
C.MATCH?YES, C.MATCH? NO

Level settings [<LEVEL>]

- **Test Tone [TEST TONE] (*2)**
OFF, AUTO XXX (*3), FIX XXX (*3)
- **Test Tone Phase Noise [P. NOISE] (*2)**
OFF, FL/FR, FL/CNT, CNT/FR, FR/SR, SR/SBR, SR/SB, SBR/SBL, SR/SL, SBL/SL, SB/SL, SL/FL, HTL/HTR, FL/SR, SL/FR, FL/HTR, HTL/FR
- **Test Tone Phase Audio [P. AUDIO] (*2)**
OFF, FL/FR, FL/CNT, CNT/FR, FR/SR, SR/SBR, SR/SB, SBR/SBL, SR/SL, SBL/SL, SB/SL, SL/FL, HTL/HTR, FL/SR, SL/FR, FL/HTR, HTL/FR
- **Front left speaker level [FL LEVEL] (*2)**
FL -10.0 dB to FL +10.0 dB (0.5 dB interval)
- **Front right speaker level [FR LEVEL] (*2)**
FR -10.0 dB to FR +10.0 dB (0.5 dB interval)
- **Center speaker level [CNT LEVEL] (*2)**
CNT -10.0 dB to CNT +10.0 dB (0.5 dB interval)
- **Surround left speaker level [SL LEVEL] (*2)**
SL -10.0 dB to SL +10.0 dB (0.5 dB interval)
- **Surround right speaker level [SR LEVEL] (*2)**
SR -10.0 dB to SR +10.0 dB (0.5 dB interval)
- **Surround back speaker level [SB LEVEL] (*2)**
SB -10.0 dB to SB +10.0 dB (0.5 dB interval)
- **Surround back left speaker level [SBL LEVEL] (*2)**
SBL -10.0 dB to SBL +10.0 dB (0.5 dB interval)
- **Surround back right speaker level [SBR LEVEL] (*2)**
SBR -10.0 dB to SBR +10.0 dB (0.5 dB interval)
- **Height left speaker level [HTL LEVEL] (*2)**
HTL -10.0 dB to HTL +10.0 dB (0.5 dB interval)
- **Height right speaker level [HTR LEVEL] (*2)**
HTR -10.0 dB to HTR +10.0 dB (0.5 dB interval)
- **Subwoofer Level [SW LEVEL] (*2)**
SW -10.0 dB to SW +10.0 dB (0.5 dB interval)

Speaker settings [<SPEAKER>]

- **Speaker pattern [SP PATTERN]**
 - LISTENER LEVEL: 7.1 to 2.0 (16 patterns)
 - HEIGHT/OVERHEAD: SRD, FD, TM, FH, NOT USE (5 patterns)
- **Ceiling Height [CEILING H.] (*4)**
2.00 m to 10.00 m (6'6" to 32'9") (0.01 m (1 inch) interval)
- **Center Speaker Lift Up [CNT LIFT] (*5)(*6)**
LIFT 1 to LIFT 10, LIFT OFF
- **Surround Speaker Position [SUR SP POS]**
FRONT, BACK
- **Speaker Relocation/Phantom Surround Back [SP RELOCATION]**
TYPE A, TYPE B, OFF
- **Front speakers size [FRT SIZE] (*2)**
LARGE, SMALL
- **Center speaker size [CNT SIZE] (*2)**
LARGE, SMALL
- **Surround speakers size [SUR SIZE] (*2)**
LARGE, SMALL
- **Height speakers size [HT SIZE] (*2)**
LARGE, SMALL
- **SURROUND BACK/ZONE2 Priority [SB/Z2 PRIO]** (for USA and Canadian models only)
ZONE2, SUR BACK
- **Surround Back Speaker Assign [SB ASSIGN] (*7)**
ZONE2 (*8), FRONT B, BI-AMP, OFF
- **Front left speaker distance [FL DIST.] (*2)**
FL 1.00 m to FL 10.00 m (FL 3'3" to FL 32'9") (0.01 m (1 inch) interval)
- **Front right speaker distance [FR DIST.] (*2)**
FR 1.00 m to FR 10.00 m (FR 3'3" to FR 32'9") (0.01 m (1 inch) interval)

- **Center speaker distance [CNT DIST.] (*2)**
CNT 1.00 m to CNT 10.00 m (CNT 3'3" to CNT 32'9") (0.01 m (1 inch) interval)
- **Surround left speaker distance [SL DIST.] (*2)**
SL 1.00 m to SL 10.00 m (SL 3'3" to SL 32'9") (0.01 m (1 inch) interval)
- **Surround right speaker distance [SR DIST.] (*2)**
SR 1.00 m to SR 10.00 m (SR 3'3" to SR 32'9") (0.01 m (1 inch) interval)
- **Surround back speaker distance [SB DIST.] (*2)**
SB 1.00 m to SB 10.00 m (SB 3'3" to SB 32'9") (0.01 m (1 inch) interval)
- **Surround back left speaker distance [SBL DIST.] (*2)**
SBL 1.00 m to SBL 10.00 m (SBL 3'3" to SBL 32'9") (0.01 m (1 inch) interval)
- **Surround back right speaker distance [SBR DIST.] (*2)**
SBR 1.00 m to SBR 10.00 m (SBR 3'3" to SBR 32'9") (0.01 m (1 inch) interval)
- **Height left speaker distance [HTL DIST.] (*2)**
HTL 1.00 m to HTL 10.00 m (HTL 3'3" to HTL 32'9") (0.01 m (1 inch) interval)
- **Height right speaker distance [HTR DIST.] (*2)**
HTR 1.00 m to HTR 10.00 m (HTR 3'3" to HTR 32'9") (0.01 m (1 inch) interval)
- **Subwoofer distance [SW DIST.] (*2)**
SW 1.00 m to SW 10.00 m (SW 3'3" to SW 32'9") (0.01 m (1 inch) interval)
- **Distance Unit [DIST. UNIT]**
FEET, METER
- **Front speakers crossover frequency [FRT CROSS] (*9)**
CROSS 40 Hz to CROSS 200 Hz (10 Hz interval)
- **Center speaker crossover frequency [CNT CROSS] (*9)**
CROSS 40 Hz to CROSS 200 Hz (10 Hz interval)
- **Surround speakers crossover frequency [SUR CROSS] (*9)**
CROSS 40 Hz to CROSS 200 Hz (10 Hz interval)
- **Height speakers crossover frequency [HT CROSS] (*9)**
CROSS 40 Hz to CROSS 200 Hz (10 Hz interval)

Input settings [<INPUT>]

- **Input Mode [INPUT MODE] (*10)**
AUTO, OPT, COAX, ANALOG
- **Naming inputs [NAME IN]**
For details, see "[Changing the name for each input \(Name\).](#)"
- **Digital audio input assignment [A. ASSIGN]**
OPT, COAX, NONE

EQ settings [<EQ>]

- **Front speakers bass level [FRT BASS]**
FRT B. -10 dB to FRT B. +10 dB (1 dB interval)
- **Front speakers treble level [FRT TREBLE]**
FRT T. -10 dB to FRT T. +10 dB (1 dB interval)
- **Center speaker bass level [CNT BASS]**
CNT B. -10 dB to CNT B. +10 dB (1 dB interval)
- **Center speaker treble level [CNT TREBLE]**
CNT T. -10 dB to CNT T. +10 dB (1 dB interval)
- **Surround speakers bass level [SUR BASS]**
SUR B. -10 dB to SUR B. +10 dB (1 dB interval)
- **Surround speakers treble level [SUR TREBLE]**
SUR T. -10 dB to SUR T. +10 dB (1 dB interval)
- **Height speakers bass level [HT BASS]**
HT B. -10 dB to HT B. +10 dB (1 dB interval)
- **Height speakers treble level [HT TREBLE]**
HT T. -10 dB to HT T. +10 dB (1 dB interval)

Zone settings [<ZONE>]

- **Zone 2 lineout [Z2 LINEOUT]**
VARIABLE, FIXED

Tuner settings [<TUNER>]

- **FM station receiving mode [FM MODE]** (*11)
STEREO, MONO
- **Naming preset stations [NAME IN]** (*11)
For details, see “[Naming preset stations \(Preset Name Input\)](#).”

Audio settings [<AUDIO>]

- **In-Ceiling Speaker Mode [IN-CEILING]**
FRONT&CNT, FRONT, OFF
- **DSD Native output [DSD NATIVE]**
DSD ON, DSD OFF
- **Digital Legato Linear [D.L.L.]**
D.L.L. AUTO2, D.L.L. AUTO1, D.L.L. OFF
- **Sound Optimizer [OPTIMIZER]**
NORMAL, LOW, OFF
- **Synchronizes audio with video output [A/V SYNC]**
0 ms to 300 ms (10 ms interval), HDMI AUTO
- **Subwoofer Low Pass Filter [SW L.P.F.]**
L.P.F. ON, L.P.F. OFF
- **Digital broadcast language selection [DUAL MONO]**
MAIN/SUB, MAIN, SUB
- **Dynamic Range Compressor [D. RANGE]**
COMP. ON, COMP. AUTO, COMP. OFF
- **DTS:X Decoder mode [NEURAL:X]** (*12)
ON, OFF
- **DTS:X Dialog Control [DIALOG CTL]** (*13)
0 dB to 6 dB (1 dB interval)
- **Multi-room Group Sync [M/R SYNC]** (*14)
ON, OFF

HDMI settings [<HDMI>]

- **HDMI In 4K Scaling [4K SCALING]**
AUTO, OFF
- **Control for HDMI [CTRL: HDMI]**
CTRL ON, CTRL OFF
- **Standby Linked to TV [STBY LINK]**
ON, AUTO, OFF
- **Standby Through [STBY THRU]**
ON, AUTO, OFF
- **HDMI Out B Mode [OUTB MODE]**
MAIN, ZONE
- **Priority [PRIORITY]** (*15)
MAIN&ZONE, MAIN ONLY
- **HDMI Audio Out [AUDIO OUT]**
AMP, TV+AMP
- **HDMI Subwoofer Level [SW LEVEL]**
SW AUTO, SW +10 dB, SW 0 dB
- **HDMI Signal Format [SIGNAL FMT.]**
STANDARD, ENHANCED

BLUETOOTH settings [<BT>]

- **BLUETOOTH Mode [BT MODE]** (*16)
RECEIVE, TRANSMIT, OFF
- **BLUETOOTH AAC [BT AAC]** (*17)
AAC ON, AAC OFF
- **BLUETOOTH LDAC [BT LDAC]** (*17)
LDAC ON, LDAC OFF
- **Wireless Playback Quality [QUALITY]** (*18)
AUTO, SOUND, STANDARD, CONNECTION

- **BLUETOOTH Standby [BT STANDBY] (*17)**
STBY ON, STBY OFF

System settings [<SYSTEM>]

- **Remote Start [RM START]** (for USA, Canadian and Asia-Pacific models only)
ON, OFF
- **Auto standby mode [AUTO STBY]**
STBY ON, STBY OFF
- **Network Standby [NET STBY]** (for USA, Canadian and Asia-Pacific models only)(*19)
MODE ON, MODE OFF
- **Version display [VERSION] (*20)**
XXX.X.XXXX
- **Sleep timer [SLEEP]**
OFF, 0:30:00, 1:00:00, 1:30:00, 2:00:00

*1 You can select this setting only when you have performed Auto Calibration and saved the settings.

*2 Some parameters or settings may not be available depending on the speaker pattern setting.

*3 XXX represents a speaker channel (FL, FR, CNT, SL, SR, SB, SBL, SBR, HTL, HTR, SW).

*4 You cannot select this setting in the following cases:

- Headphones are connected.
- [Bluetooth Mode] is set to [Transmitter].

*5 You can only select this setting if [SP PATTERN] is set to a pattern with center speaker and front high speakers. (i.e. 5.1.2 (FH))

*6 You cannot select this setting in the following cases:

- Headphones are connected.
- [2ch Stereo] or [Multi Ch Stereo] is being used.
- A sound field for music is being used.
- [Bluetooth Mode] is set to [Transmitter].

*7 You can only select this setting if [SP PATTERN] is not set to a pattern with surround back and height speakers. (i.e. 5.1, 5.0, 4.1, 4.0, 3.1, 3.0, 2.1, 2.0)

*8 For European and Asia-Pacific models only

*9 You can only select this setting if the speaker is set to [SMALL].

*10 Sometimes the settings are dimmed and cannot be selected.

*11 This setting appears dimmed and cannot be selected except when [FM TUNER] is selected.

*12 You cannot select this setting in the following cases:

- [2ch Stereo], [Direct], [Dolby Surround] or [Neural:X] is being used.
- Headphones are connected.

*13 You can select this setting only when DTS:X content compatible with the DTS:X Dialog Control function is being played back.

*14 You can select this setting only when listening to sound from one of the following sources using the Wireless Multi-Room function:

- Devices connected to the HDMI IN, OPTICAL IN, COAXIAL IN, or AUDIO IN jacks
- TVs compatible with the Audio Return Channel (ARC) function and connected to the HDMI OUT A (TV) jack

*15 You cannot select this setting when [HDMI Out B Mode] is set to [Main].

*16 You cannot select this setting when [Bluetooth] function is selected.

*17 You cannot select this setting in the following cases:

- [Bluetooth Mode] is set to [Off].
- A BLUETOOTH device is connected.

*18 You can only select this setting when [Bluetooth Mode] is set to [Transmitter] and [Bluetooth Codec - LDAC] is set to [On].

*19 If you agree to use the Chromecast built-in function, this setting automatically switches to [MODE ON].

*20 XXXX represents the version number.

Formats compatible with home networks

Supported music formats (*1)

MP3 (MPEG 1 Audio Layer-3):

.mp3

AAC/HE-AAC (*2):

.m4a, .aac

WMA9 Standard (*2):

.wma

LPCM:

.wav

FLAC:

.flac, .fla

DSF (*2):

.dsf

DSDIFF (*2)(*3):

.dff

AIFF (*2):

.aiff, .aif

ALAC:

.m4a

Vorbis

.ogg

Monkey's Audio

.ape

*1 Compatibility with all encoding/writing software, recording devices and recording media cannot be guaranteed.

*2 The receiver may not play this file format on the home network server.

*3 The receiver does not play DST encoded files.

Note

- Some files may not play depending on the file format, the file encoding, the recording condition, or home network server condition.
- Some files that have been edited on a computer may not play.
- Fast forward or fast reverse functions may not be available for some files.
- The receiver does not play coded files such as DRM and Lossless.
- The receiver can recognize the following files or folders stored in the home network server:
 - up to folders in the 19th layer
 - up to 999 files/folders in a single layer

Adjusting the balance between adjacent speakers by outputting a test tone (Phase Noise)

You can output a test tone from adjacent speakers to adjust the balance between the speakers. This operation is only available using the display panel on the front of the receiver.

1 Press AMP MENU.

The menu is displayed on the display panel of the receiver.

2 Select [<LEVEL>] (Level settings) - [P. NOISE].

3 Select the speakers to output the test tone from.

The test tone is output from the selected speakers.

4 Adjust the speaker level using MASTER VOLUME on the receiver.

Available speakers:

FL/FR (Front left/Front right)
FL/CNT (Front left/Center)
CNT/FR (Center/Front right)
FR/SR (Front right/Surround right)
SR/SBR (Surround right/Surround back right)
SR/SB (Surround right/Surround back)
SBR/SBL (Surround back right/Surround back left)
SR/SL (Surround right/Surround left)
SBL/SL (Surround back left/Surround left)
SB/SL (Surround back/Surround left)
SL/FL (Surround left/Front left)
HTL/HTR (Height left/Height right)
FL/SR (Front left/Surround right)
SL/FR (Surround left/Front right)
FL/HTR (Front left/Height right)
HTL/FR (Height left/Front right)

Note

- Some items may not appear, depending on the connected speakers.
- This function is canceled if you perform any operation other than the following:
 - Volume adjustment
 - Level adjustment of each speaker
 - Turning the muting function on/off
- This function is not available when [Bluetooth Mode] is set to [Transmitter].

Hint

- Select [OFF] in step 3 to disable the Phase Noise function.

Adjusting the balance between adjacent speakers by outputting a source sound (Phase Audio)

You can output the source sound from adjacent speakers to adjust the balance between the speakers.

This operation is only available using the display panel on the front of the receiver.

1 Press AMP MENU.

The menu is displayed on the display panel of the receiver.

2 Select [<LEVEL>] (Level settings) - [P. AUDIO].

3 Select the speakers to output the sound from.

The front 2 channel source sound is output sequentially from adjacent speakers.

4 Adjust the speaker level using MASTER VOLUME on the receiver.

Available speakers:

FL/FR (Front left/Front right)

FL/CNT (Front left/Center)

CNT/FR (Center/Front right)

FR/SR (Front right/Surround right)

SR/SBR (Surround right/Surround back right)

SR/SB (Surround right/Surround back)

SBR/SBL (Surround back right/Surround back left)

SR/SL (Surround right/Surround left)

SBL/SL (Surround back left/Surround left)

SB/SL (Surround back/Surround left)

SL/FL (Surround left/Front left)

HTL/HTR (Height left/Height right)

FL/SR (Front left/Surround right)

SL/FR (Surround left/Front right)

FL/HTR (Front left/Height right)

HTL/FR (Height left/Front right)

Note

- Some items may not appear, depending on the connected speakers.
- This function is canceled if you perform any operation other than the following:
 - Volume adjustment
 - Level adjustment of each speaker
 - Turning the muting function on/off
- This function is not available when [Bluetooth Mode] is set to [Transmitter].

Hint

- Select [OFF] in step 3 to disable the Phase Audio function.