

TW100-BRM504

Broadband ADSL

Router

Broadband Internet Access

ADSL Modem

NAT Router

4-Port Switching Hub

User's Guide

Table of Contents

CHAPTER 1 INTRODUCTION	1
TW100-BRM504 Features.....	1
Package Contents	3
Physical Details.....	4
CHAPTER 2 INSTALLATION.....	6
Requirements.....	6
Procedure	6
CHAPTER 3 SETUP	8
Overview	8
Configuration Program	9
Setup Wizard	10
Home Screen	12
LAN Screen.....	13
Password Screen.....	15
CHAPTER 4 PC CONFIGURATION	16
Overview	16
Windows Clients.....	16
Macintosh Clients.....	28
Linux Clients.....	28
Other Unix Systems.....	28
CHAPTER 5 OPERATION AND STATUS	29
Operation	29
Status Screen.....	29
Connection Status - PPPoE & PPPoA.....	31
Connection Details - Dynamic IP Address	32
Connection Details - Fixed IP Address.....	33
CHAPTER 6 ADVANCED FEATURES	34
Overview	34
Internet.....	34
Dynamic DNS (Domain Name Server).....	36
Firewall Rules	38
Firewall Services.....	43
Options	45
Schedule.....	46
Virtual Servers.....	47
CHAPTER 7 ADVANCED ADMINISTRATION	49
Overview	49
PC Database.....	50
Config File.....	54
Logs.....	55
E-mail	57
Network Diagnostics	59
Remote Administration.....	60
Routing	62
Upgrade Firmware.....	66

APPENDIX A TROUBLESHOOTING.....	67
Overview	67
General Problems.....	67
Internet Access.....	67
APPENDIX B SPECIFICATIONS.....	69
Multi-Function TW100-BRM504	69
Regulatory Approvals.....	70

P/N: 9560NB0037

Copyright © 2003. All Rights Reserved.

Document Version: 1.2

All trademarks and trade names are the properties of their respective owners.

Chapter 1

Introduction

1

This Chapter provides an overview of the TW100-BRM504's features and capabilities.

Congratulations on the purchase of your new TW100-BRM504. The TW100-BRM504 is a multi-function device providing the following services:

- **Shared Broadband Internet Access** for all LAN users.
- **4-Port Switching Hub** for 10BaseT or 100BaseT connections.

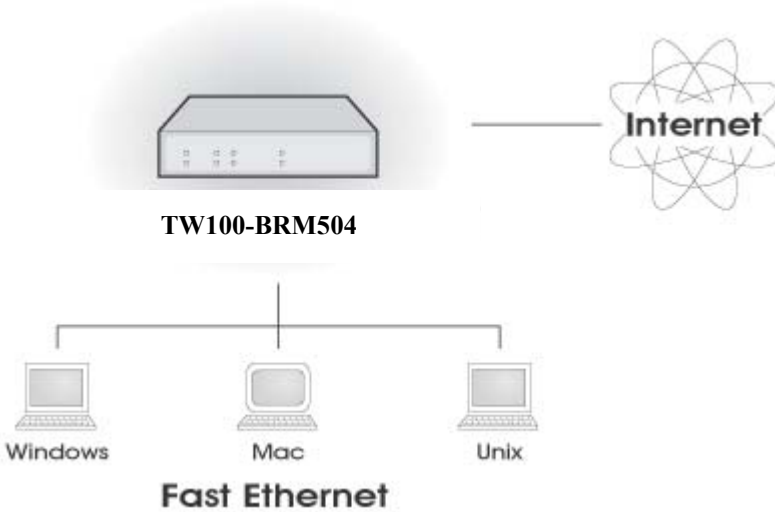

Figure 1: TW100-BRM504

TW100-BRM504 Features

The TW100-BRM504 incorporates many advanced features, carefully designed to provide sophisticated functions while being easy to use.

Internet Access Features

- **Shared Internet Access.** All users on the LAN or WLAN can access the Internet through the TW100-BRM504, using only a single external IP Address. The local (invalid) IP Addresses are hidden from external sources. This process is called NAT (Network Address Translation).
- **Built-in ADSL Modem.** The TW100-BRM504 has a built-in ADSL modem, supporting all common ADSL connections.
- **IPoA, PPPoE, PPPoA, Direct Connection Support.** The TW100-BRM504 supports all common connection methods.
- **Auto-detection of Internet Connection Method.** In most situations, the TW100-BRM504 can test your ADSL and Internet connection to determine the connection method used by your ISP.
- **Fixed or Dynamic IP Address.** On the Internet (WAN port) connection, the TW100-BRM504 supports both Dynamic IP Address (IP Address is allocated on connection) and Fixed IP Address.

Advanced Internet Functions

- **Application Level Gateways (ALGs).** Applications which use non-standard connections or port numbers are normally blocked by the Firewall. The ability to define and allow such applications is provided, to enable such applications to be used normally.
- **Virtual Servers.** This feature allows Internet users to access Internet servers on your LAN. The required setup is quick and easy.
- **URL Filter.** Use the URL Filter to block access to undesirable Web sites by LAN users.
- **Logs.** Define what data is recorded in the Logs, and optionally send log data to a Syslog Server. Log data can also be E-mailed to you.
- **Firewall.** As well as the built-in firewall to protect your LAN, you can define Firewall Rules to determine which incoming and outgoing traffic should be permitted.
- **Dynamic DNS Support.** DDNS, when used with the Virtual Servers feature, allows users to connect to Servers on your LAN using a Domain Name, even if you have a dynamic IP address which changes every time you connect.
- **VPN Pass through Support.** PCs with VPN (Virtual Private Networking) software using PPTP, L2TP and IPSec are transparently supported - no configuration is required.

LAN Features

- **4-Port Switching Hub.** The TW100-BRM504 incorporates a 4-port 10/100BaseT switching hub, making it easy to create or extend your LAN.
- **DHCP Server Support.** Dynamic Host Configuration Protocol provides a dynamic IP address to PCs and other devices upon request. The TW100-BRM504 can act as a **DHCP Server** for devices on your local LAN and WLAN.

Configuration & Management

- **Easy Setup.** Use your WEB browser from anywhere on the LAN or WLAN for configuration.
- **Configuration File Upload/Download.** Save (download) the configuration data from the TW100-BRM504 to your PC, and restore (upload) a previously-saved configuration file to the TW100-BRM504.
- **Remote Management.** The TW100-BRM504 can be managed from any PC on your LAN. And, if the Internet connection exists, it can also (optionally) be configured via the Internet.
- **Network Diagnostics.** You can use the TW100-BRM504 to perform a *Ping* or *DNS lookup*.

Security Features

- **Password - protected Configuration.** Optional password protection is provided to prevent unauthorized users from modifying the configuration data and settings.
- **NAT Protection.** An intrinsic side effect of NAT (Network Address Translation) technology is that by allowing all LAN users to share a single IP address, the location and even the existence of each PC is hidden. From the external viewpoint, there is no network, only a single device - the TW100-BRM504.
- **Firewall.** All incoming data packets are monitored and all incoming server requests are filtered, thus protecting your network from malicious attacks from external sources.
- **Protection against DoS attacks.** DoS (Denial of Service) attacks can flood your Internet connection with invalid packets and connection requests, using so much band-

width and so many resources that Internet access becomes unavailable. The TW100-BRM504 incorporates protection against DoS attacks.

Package Contents

The following items should be included:

- The TW100-BRM504 Unit
- 1 Cat-5 Ethernet (LAN) cable
- 1 RJ-11 (ADSL) cable
- Power Adapter
- Quick Installation Guide
- CD-ROM containing the on-line manual.

If any of the above items are damaged or missing, please contact your dealer immediately.

Physical Details

Front-mounted LEDs



Figure 2: Front Panel

**Power LED
(Green)**

On - Power on.
Off - No power.

**Status LED
(Yellow)**

Off - Normal operation.
Blinking - This LED blinks during start up, and during a Firmware Upgrade.

LAN

For each port, there are 2 LEDs, to indicate the connection speed (10BaseT or 100BaseT) of each port.

- **100BT** - This will be ON if the LAN connection is using 100BaseT, and Blinking if data is being transferred via the corresponding LAN port.
- **10BT** - This will be ON if the LAN connection is using 10BaseT, and Blinking if data is being transferred via the corresponding LAN port.
- If neither LED is on, there is no active connection on the corresponding LAN port.

WAN

On - ADSL connection is available.
Off - No ADSL connection.
Flashing - Data is being transmitted or received via the ADSL connection.

Rear Panel

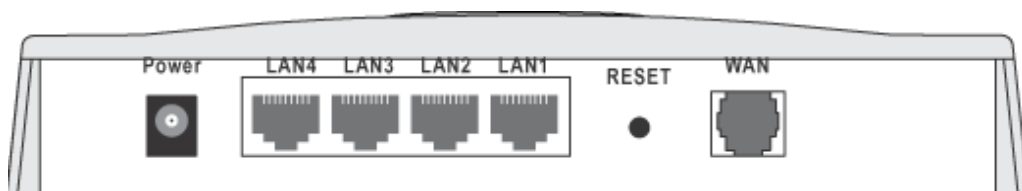

Figure 3: Rear Panel

- Power port** Connect the supplied power adapter here.
- 10/100BaseT
LAN connections** Use standard LAN cables (RJ45 connectors) to connect your PCs to these ports.
- Note:**
- Any LAN port on the TW100-BRM504 will automatically function as an "Uplink" port when required. Just connect any port to a normal port on the other hub, using a standard LAN cable.
- Reset Button
(Reset to Defaults)** This button will reset the TW100-BRM504 to the factory default values.
To do this, press and hold the Reset Button for five (5) seconds, until the Status LED is lit, then release the Reset Button, and wait the TW100-BRM504 to restart using the factory default values.
- WAN port
(ADSL port)** Connect this port to your ADSL line.

Chapter 2

Installation

2

This Chapter covers the physical installation of the TW100-BRM504.

Requirements

- Network cables. Use standard 10/100BaseT network (UTP) cables with RJ45 connectors.
- TCP/IP protocol must be installed on all PCs.
- For Internet Access, an Internet Access account with an ISP, and a DSL connection.

Procedure

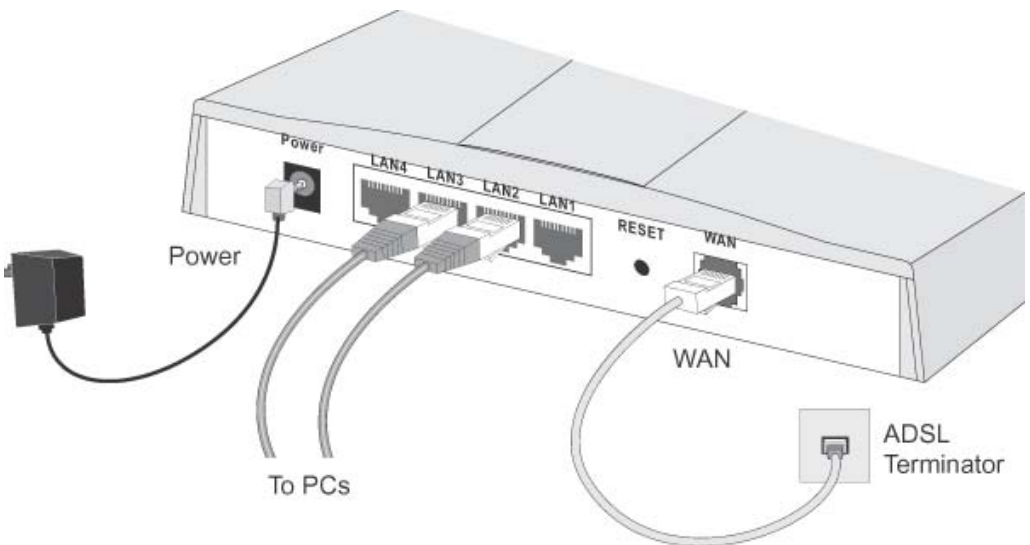

Figure 4: Installation Diagram

1. Choose an Installation Site

Select a suitable place on the network to install the TW100-BRM504.

2. Connect LAN Cables

Use standard LAN cables to connect PCs to the Switching Hub ports on the TW100-BRM504. Both 10BaseT and 100BaseT connections can be used simultaneously.

If required, connect any port to a normal port on another Hub, using a standard LAN cable. Any LAN port on the TW100-BRM504 will automatically function as an "Uplink" port when required.

3. Connect ADSL Cable

Connect the supplied ADSL cable from to the WAN port on the TW100-BRM504 (the RJ11 connector) to the ADSL terminator provided by your phone company.

4. Power Up

Connect the supplied power adapter to the TW100-BRM504 and power up.
Use only the power adapter provided. Using a different one may cause hardware damage

5. Check the LEDs

- The *Power* LED should be ON.
- The *Status* LED should flash, then turn Off. If it stays on or blinking after 60 seconds, there is a hardware error.
- , there is a hardware error.
- For each LAN (PC) connection, one of the LAN LEDs should be ON (provided the PC is also ON.)
- The *WLAN* LED should be ON
- The *WAN* LED should be ON if the ADSL line is connected.

For more information, refer to *Front-mounted LEDs* in Chapter 1.

Chapter 3

Setup



This Chapter provides Setup details of the TW100-BRM504.

Overview

This chapter describes the setup procedure for:

- Internet Access
- LAN configuration
- Assigning a Password to protect the configuration data.

PCs on your local LAN may also require configuration. For details, see *Chapter 4 - PC Configuration*.

Other configuration may also be required, depending on which features and functions of the TW100-BRM504 you wish to use. Use the table below to locate detailed instructions for the required functions.

To Do this:	Refer to:
Configure PCs on your LAN.	Chapter 4: PC Configuration
Check TW100-BRM504 operation and Status.	Chapter 5: Operation and Status
Use any of the following Advanced features: <ul style="list-style-type: none">• Internet• Dynamic DNS• Firewall Rules• Firewall Services• Schedule• Virtual Servers	Chapter 6: Advanced Features
Use any of the following Administration Configuration settings or features: <ul style="list-style-type: none">• PC Database• Config File• Logs• Diagnostics• E-mail• Remote Admin• Routing• Upgrade Firmware	Chapter 7 Advanced Administration

Configuration Program

The TW100-BRM504 contains an HTTP server. This enables you to connect to it, and configure it, using your Web Browser. **Your Browser must support JavaScript.**

The configuration program has been tested on the following browsers:

- Netscape V4.08 or later
- Netscape 7
- Internet Explorer V5.01 or later

Preparation

Before attempting to configure the TW100-BRM504, please ensure that:

- Your PC can establish a physical connection to the TW100-BRM504. The PC and the TW100-BRM504 must be directly connected (using the Hub ports on the TW100-BRM504) or on the same LAN segment.
- The TW100-BRM504 must be installed and powered ON.
- If the TW100-BRM504's default IP Address (192.168.0.1) is already used by another device, the other device must be turned OFF until the TW100-BRM504 is allocated a new IP Address during configuration.

Using your Web Browser

To establish a connection from your PC to the TW100-BRM504:

1. After installing the TW100-BRM504 in your LAN, start your PC. If your PC is already running, restart it.
2. Start your WEB browser.
3. In the *Address* box, enter "HTTP://" and the IP Address of the TW100-BRM504, as in this example, which uses the TW100-BRM504's default IP Address:

```
HTTP://192.168.0.1
```
4. When prompted for the User name and Password, enter values as follows:
 - User name admin
 - Password password

If you can't connect

If the TW100-BRM504 does not respond, check the following:

- The TW100-BRM504 is properly installed, LAN connection is OK, and it is powered ON. You can test the connection by using the "Ping" command:
 - Open the MS-DOS window or command prompt window.
 - Enter the command:

```
ping 192.168.0.1
```

 If no response is received, either the connection is not working, or your PC's IP address is not compatible with the TW100-BRM504's IP Address. (See next item.)
- If your PC is using a fixed IP Address, its IP Address must be within the range 192.168.0.2 to 192.168.0.254 to be compatible with the TW100-BRM504's default IP Address of 192.168.0.1. Also, the *Network Mask* must be set to 255.255.255.0. See *Chapter 4 - PC Configuration* for details on checking your PC's TCP/IP settings.
- Ensure that your PC and the TW100-BRM504 are on the same network segment. (If you don't have a router, this must be the case.)

Setup Wizard

The first time you connect to the TW100-BRM504, the Setup Wizard will run automatically. (The Setup Wizard will also run if the TW100-BRM504's default settings are restored.)

1. Step through the Wizard until finished.
 - You need the data supplied by your ISP. Most connection methods require some data input.
 - The common connection types are explained in the table below.
2. On the final screen of the Wizard, run the test and check that an Internet connection can be established.
3. If the connection test fails:
 - Check all connections, and the front panel LEDs.
 - Check that you have entered all data correctly.

Common Connection Types

Type	Details	ISP Data required
Dynamic IP Address	Your IP Address is allocated automatically, when you connect to you ISP.	a) ADSL parameters (VPI and VCI) may be required, if they cannot be detected automatically. b) Some ISP's may require you to use a particular <i>Hostname</i> or <i>Domain</i> name, or MAC (physical) address.

Static (Fixed) IP Address	Your ISP allocates a permanent IP Address to you. Usually, the connection is "Always on".	<p>a) ADSL parameters (VPI and VCI) may be required, if they cannot be detected automatically.</p> <p>b) IP Address allocated to you, and related information, such as Network Mask, Gateway IP address, and DNS address.</p>
PPPoE, PPPoA	You connect to the ISP only when required. The IP address is usually allocated automatically.	<p>a) ADSL parameters (VPI and VCI) may be required, if they cannot be detected automatically.</p> <p>b) User name and password are always required.</p> <p>c) If using a Static (Fixed) IP address, you need the IP address and related information (Network Mask, Gateway IP address, and DNS address)</p>
IPoA (IP over ATM)	Normally, the connection is "Always on".	<p>a) ADSL parameters (VPI and VCI) may be required, if they cannot be detected automatically.</p> <p>b) IP Address allocated to you, and related information, such as Network Mask, Gateway IP address, and DNS address.</p>

Home Screen

After finishing the Setup Wizard, you will see the *Home* screen. When you connect in future, you will see this screen when you connect. An example screen is shown below.

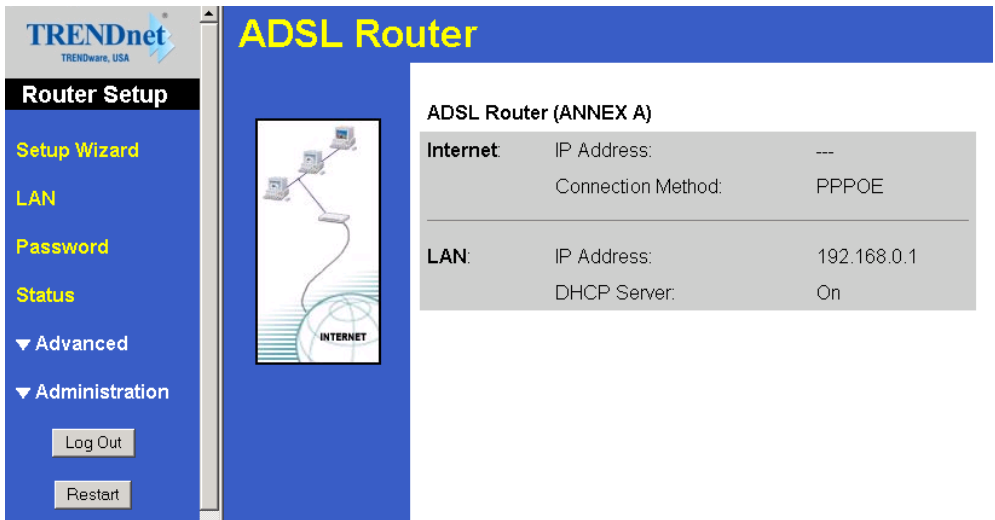

Figure 5: Home Screen

Main Menu

The main menu, on the left, contains links to the most-commonly used screen. To see the links to the other available screens, click "Advanced" or "Administration".

The main menu also contains two (2) buttons:

- **Log Out** - When finished, you should click this button to logout.
- **Restart** - Use this if you wish to restart the TW100-BRM504. Note that restarting the Router will break any existing connections to or through the Router.

Navigation & Data Input

- Use the menu bar on the left of the screen, and the "Back" button on your Browser, for navigation.
- Changing to another screen without clicking "Save" does NOT save any changes you may have made. You must "Save" before changing screens or your data will be ignored.



Note!

On each screen, clicking the "Help" button will display help for that screen.

LAN Screen

Use the *LAN* link on the main menu to reach the LAN screen. An example screen is shown below.

Figure 6: LAN Screen

Data - LAN Screen

TCP/IP	
IP Address	IP address for the TW100-BRM504, as seen from the local LAN. Use the default value unless the address is already in use or your LAN is using a different IP address range. In the latter case, enter an unused IP Address from within the range used by your LAN.
Subnet Mask	The default value 255.255.255.0 is standard for small (class "C") networks. For other networks, use the Subnet Mask for the LAN segment to which the TW100-BRM504 is attached (the same value as the PCs on that LAN segment).
DHCP Server	<ul style="list-style-type: none"> • If Enabled, the TW100-BRM504 will allocate IP Addresses to PCs (DHCP clients) on your LAN when they start up. The default (and recommended) value is Enabled. • If you are already using a DHCP Server, this setting must be Disabled, and the existing DHCP server must be re-configured to treat the TW100-BRM504 as the default Gateway. See the following section for further details. • The Start IP Address and Finish IP Address fields set the values used by the DHCP server when allocating IP Addresses to DHCP clients. This range also determines the number of DHCP clients supported. <p>See the following section for further details on using DHCP.</p>

DHCP

What DHCP Does

A DHCP (Dynamic Host Configuration Protocol) **Server** allocates a valid IP address to a DHCP **Client** (PC or device) upon request.

- The client request is made when the client device starts up (boots).
- The DHCP Server provides the *Gateway* and *DNS* addresses to the client, as well as allocating an IP Address.

- The TW100-BRM504 can act as a **DHCP server**.
- Windows 95/98/ME and other non-Server versions of Windows will act as a DHCP **client**. This is the default Windows setting for the TCP/IP network protocol. However, Windows uses the term *Obtain an IP Address automatically* instead of "DHCP Client".
- You must NOT have two (2) or more DHCP Servers on the same LAN segment. (If your LAN does not have other Routers, this means there must only be one (1) DHCP Server on your LAN.)

Using the TW100-BRM504's DHCP Server

This is the default setting. The DHCP Server settings are on the **LAN** screen. On this screen, you can:

- Enable or Disable the TW100-BRM504's *DHCP Server* function.
- Set the range of IP Addresses allocated to PCs by the DHCP Server function.



You can assign Fixed IP Addresses to some devices while using DHCP, provided that the Fixed IP Addresses are NOT within the range used by the DHCP Server.

Using another DHCP Server

You can only use one (1) DHCP Server per LAN segment. If you wish to use another DHCP Server, rather than the TW100-BRM504's, the following procedure is required.

1. Disable the DHCP Server feature in the TW100-BRM504. This setting is on the LAN screen.
2. Configure the DHCP Server to provide the TW100-BRM504's IP Address as the *Default Gateway*.

To Configure your PCs to use DHCP

This is the default setting for TCP/IP for all non-Server versions of Windows.

See *Chapter 4 - Client Configuration* for the procedure to check these settings.

Password Screen

The password screen allows you to assign a password to the TW100-BRM504.

Figure 7: Password Screen

Old Password	Enter the existing password in this field.
New password	Enter the new password here.
Verify password	Re-enter the new password here.

You will be prompted for the password when you connect, as shown below.

Figure 8: Password Dialog

- The "User Name" is always `admin`
- Enter the password for the TW100-BRM504, as set on the *Password* screen above.

Chapter 4

PC Configuration



This Chapter details the PC Configuration required on the local ("Internal") LAN.

Overview

For each PC, the following may need to be configured:

- TCP/IP network settings
- Internet Access configuration

Windows Clients

This section describes how to configure Windows clients for Internet access via the TW100-BRM504.

The first step is to check the PC's TCP/IP settings.

The TW100-BRM504 uses the TCP/IP network protocol for all functions, so it is essential that the TCP/IP protocol be installed and configured on each PC.

TCP/IP Settings - Overview

If using the default TW100-BRM504 settings, and the default Windows TCP/IP settings, no changes need to be made.

- By default, the TW100-BRM504 will act as a DHCP Server, automatically providing a suitable IP Address (and related information) to each PC when the PC boots.
- For all non-Server versions of Windows, the default TCP/IP setting is to act as a DHCP client.

If using a Fixed (specified) IP address, the following changes are required:

- The *Gateway* must be set to the IP address of the TW100-BRM504
- The *DNS* should be set to the address provided by your ISP.



Note!

If your LAN has a Router, the LAN Administrator must re-configure the Router itself. Refer to *Chapter 8 - Advanced Setup* for details.

Checking TCP/IP Settings - Windows 9x/ME:

1. Select *Control Panel - Network*. You should see a screen like the following:

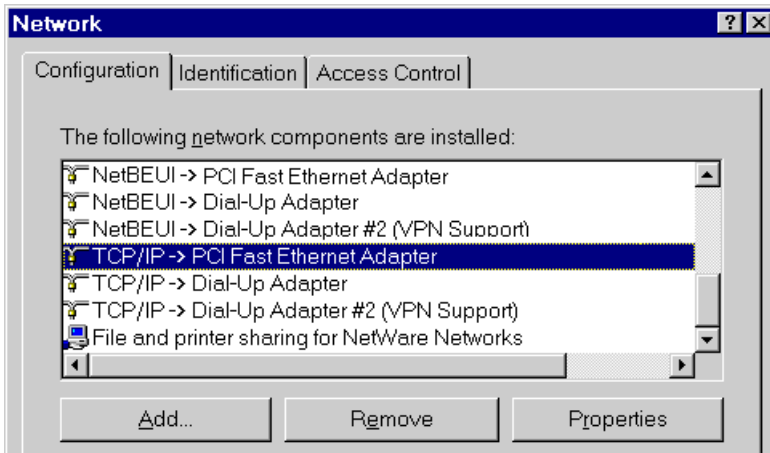

Figure 9: Network Configuration

2. Select the *TCP/IP* protocol for your network card.
3. Click on the *Properties* button. You should then see a screen like the following.

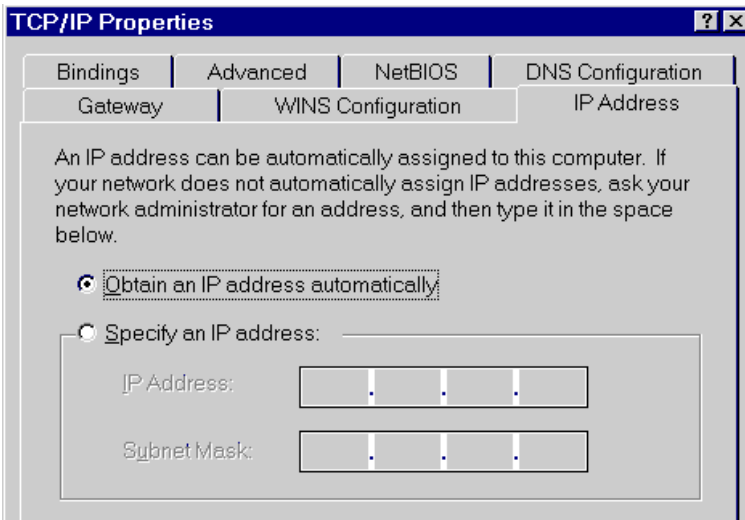

Figure 10: IP Address (Win 95)

Ensure your TCP/IP settings are correct, as follows:

Using DHCP

To use DHCP, select the radio button *Obtain an IP Address automatically*. This is the default Windows setting. **Using this is recommended.** By default, the TW100-BRM504 will act as a DHCP Server.

Restart your PC to ensure it obtains an IP Address from the TW100-BRM504.

Using "Specify an IP Address"

If your PC is already configured, check with your network administrator before making the following changes:

- On the *Gateway* tab, enter the TW100-BRM504's IP address in the *New Gateway* field and click *Add*, as shown below. Your LAN administrator can advise you of the IP Address they assigned to the TW100-BRM504.

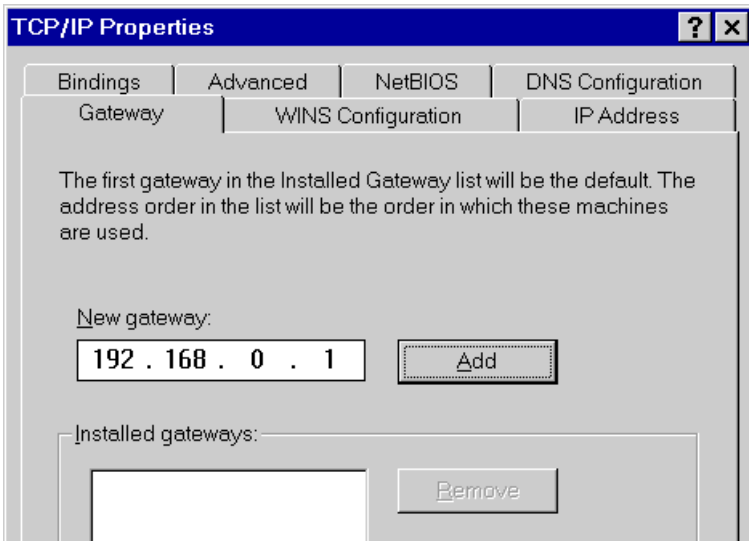

Figure 11: Gateway Tab (Win 95/98)

- On the *DNS Configuration* tab, ensure *Enable DNS* is selected. If the *DNS Server Search Order* list is empty, enter the DNS address provided by your ISP in the fields beside the *Add* button, then click *Add*.

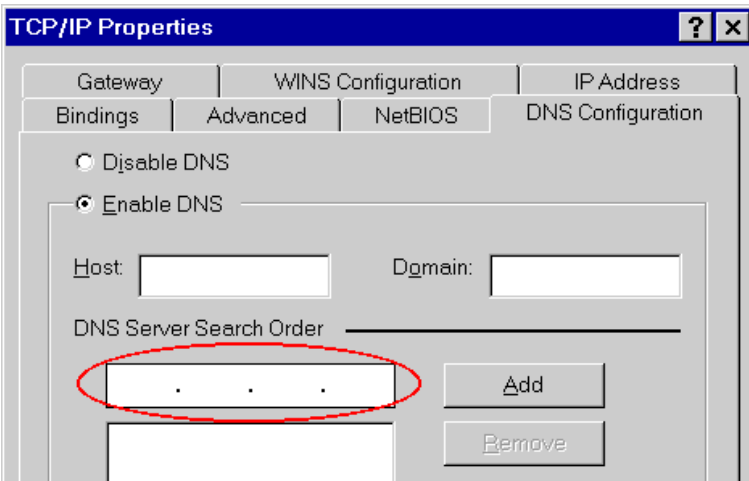

Figure 12: DNS Tab (Win 95/98)

Checking TCP/IP Settings - Windows NT4.0

1. Select *Control Panel - Network*, and, on the *Protocols* tab, select the TCP/IP protocol, as shown below.

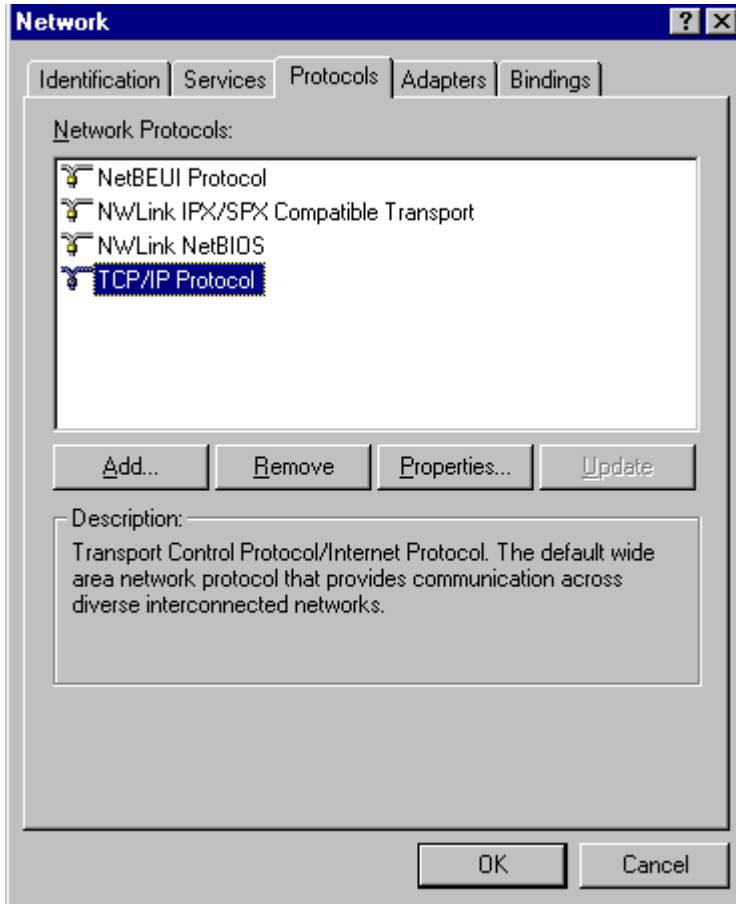

Figure 13: Windows NT4.0 - TCP/IP

2. Click the *Properties* button to see a screen like the one below.

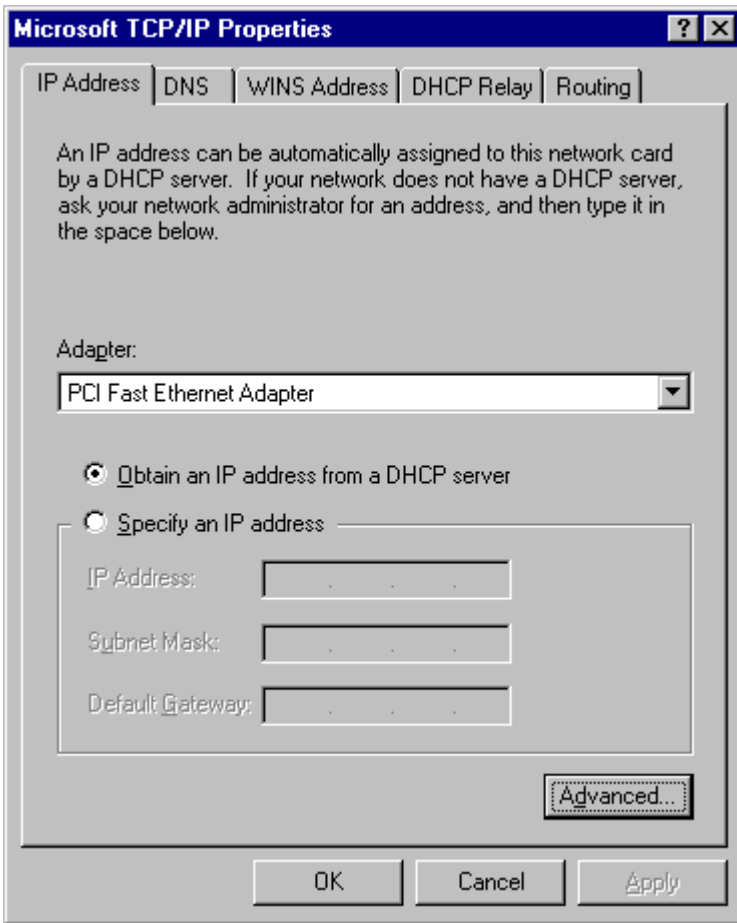

Figure 14: Windows NT4.0 - IP Address

3. Select the network card for your LAN.
4. Select the appropriate radio button - *Obtain an IP address from a DHCP Server* or *Specify an IP Address*, as explained below.

Obtain an IP address from a DHCP Server

This is the default Windows setting. **Using this is recommended.** By default, the TW100-BRM504 will act as a DHCP Server.

Restart your PC to ensure it obtains an IP Address from the TW100-BRM504.

Specify an IP Address

If your PC is already configured, check with your network administrator before making the following changes.

1. The *Default Gateway* must be set to the IP address of the TW100-BRM504. To set this:
 - Click the *Advanced* button on the screen above.
 - On the following screen, click the *Add* button in the *Gateways* panel, and enter the TW100-BRM504's IP address, as shown in Figure 15 below.
 - If necessary, use the *Up* button to make the TW100-BRM504 the first entry in the *Gateways* list.

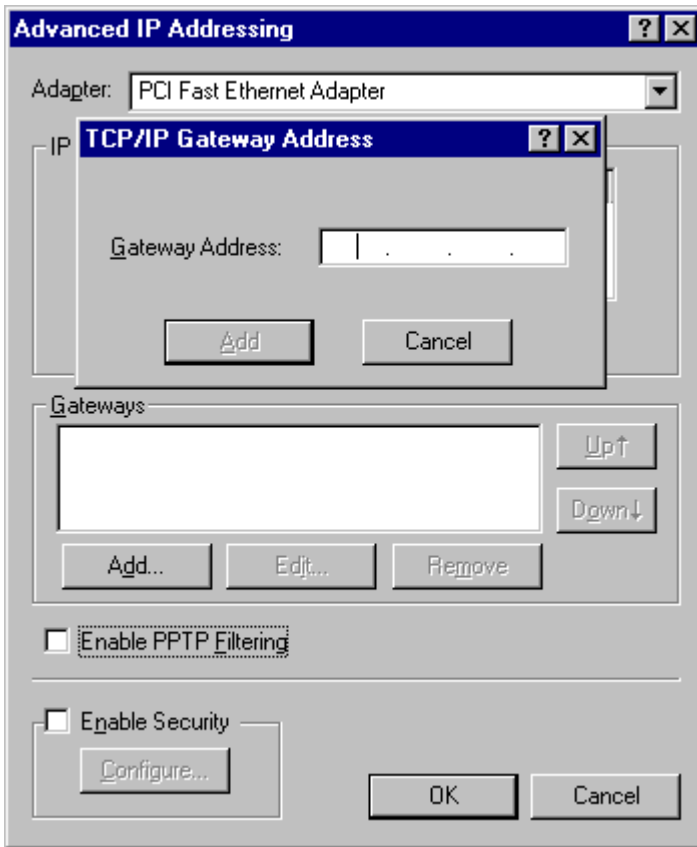

Figure 15 - Windows NT4.0 - Add Gateway

2. The DNS should be set to the address provided by your ISP, as follows:
 - Click the DNS tab.
 - On the DNS screen, shown below, click the *Add* button (under *DNS Service Search Order*), and enter the DNS provided by your ISP.

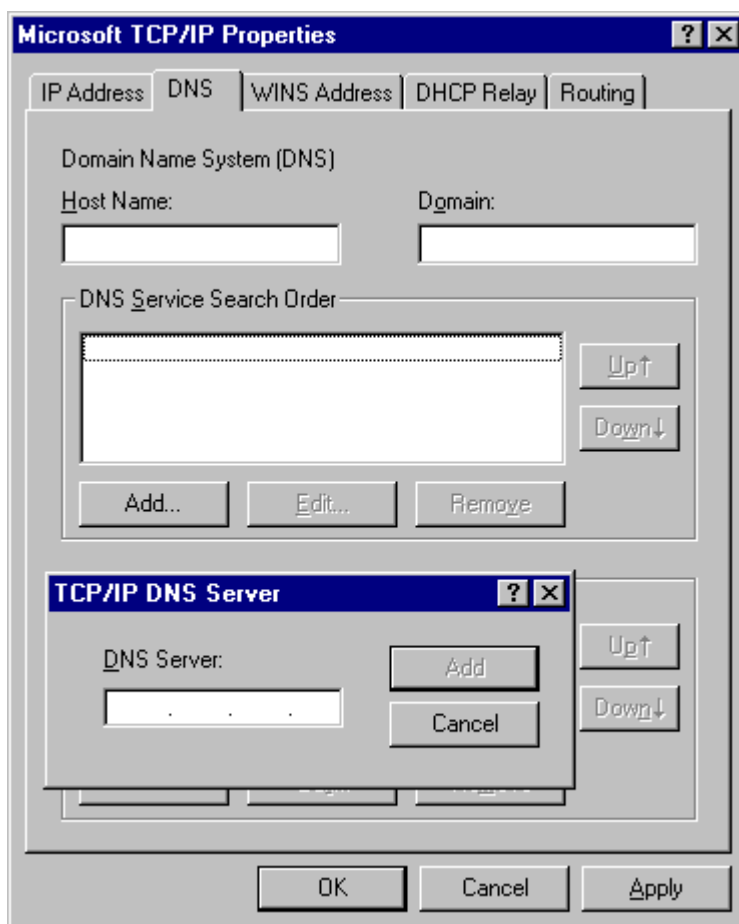

Figure 16: Windows NT4.0 - DNS

Checking TCP/IP Settings - Windows 2000:

1. Select *Control Panel - Network and Dial-up Connection*.
2. Right - click the *Local Area Connection* icon and select *Properties*. You should see a screen like the following:

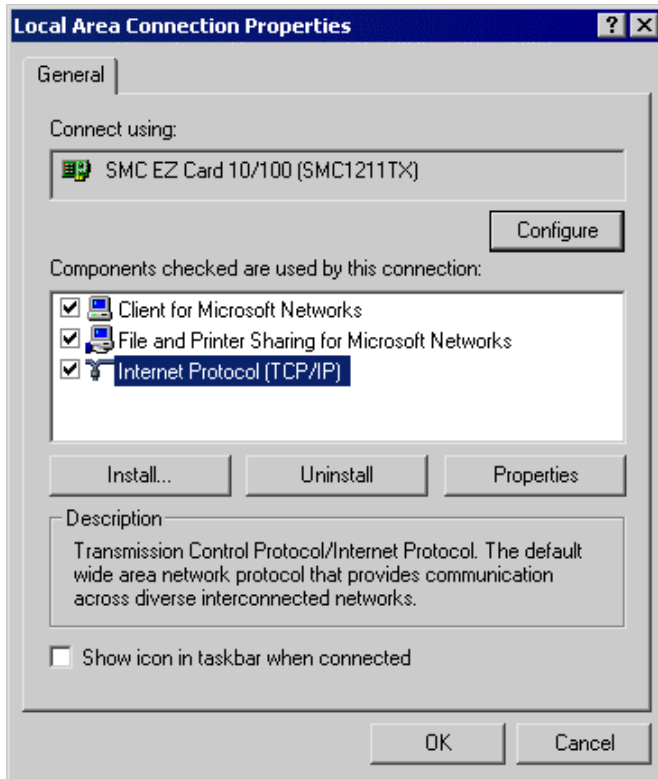

Figure 17: Network Configuration (Win 2000)

3. Select the *TCP/IP* protocol for your network card.
4. Click on the *Properties* button. You should then see a screen like the following.

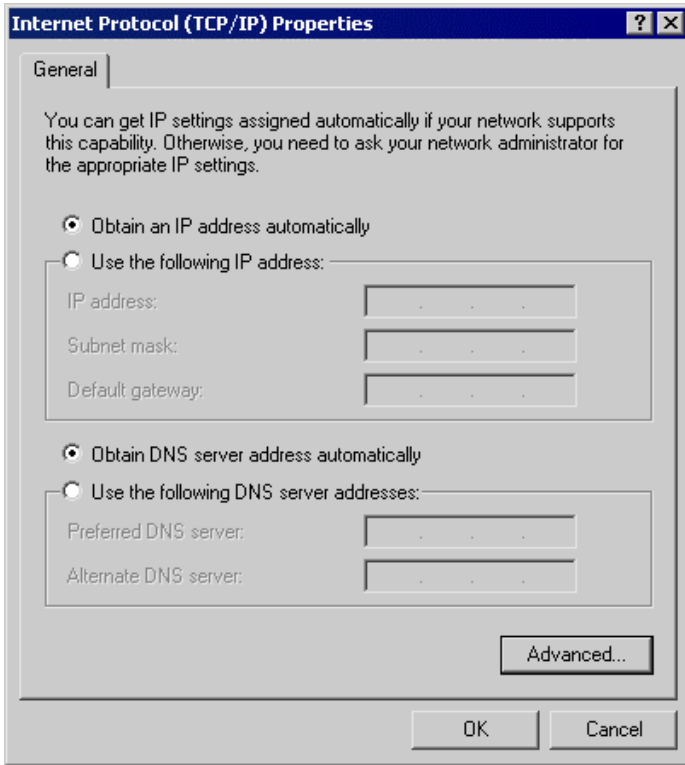

Figure 18: TCP/IP Properties (Win 2000)

5. Ensure your TCP/IP settings are correct, as described below.

Using DHCP

To use DHCP, select the radio button *Obtain an IP Address automatically*. This is the default Windows setting. **Using this is recommended.** By default, the TW100-BRM504 will act as a DHCP Server.

Restart your PC to ensure it obtains an IP Address from the TW100-BRM504.

Using a fixed IP Address ("Use the following IP Address")

If your PC is already configured, check with your network administrator before making the following changes.

- Enter the TW100-BRM504's IP address in the *Default gateway* field and click *OK*. (Your LAN administrator can advise you of the IP Address they assigned to the TW100-BRM504.)
- If the *DNS Server* fields are empty, select *Use the following DNS server addresses*, and enter the DNS address or addresses provided by your ISP, then click *OK*.

Checking TCP/IP Settings - Windows XP

1. Select *Control Panel - Network Connection*.
2. Right click the *Local Area Connection* and choose *Properties*. You should see a screen like the following:

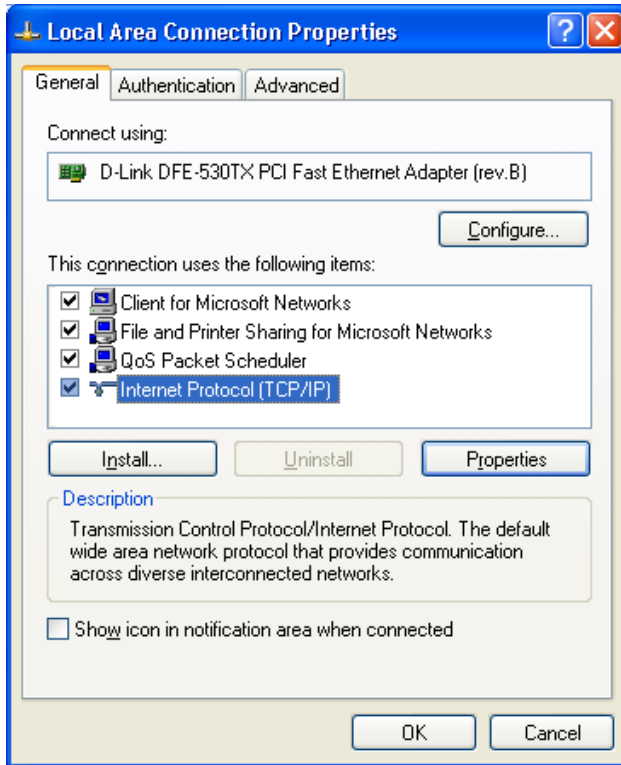

Figure 19: Network Configuration (Windows XP)

3. Select the *TCP/IP* protocol for your network card.
4. Click on the *Properties* button. You should then see a screen like the following.

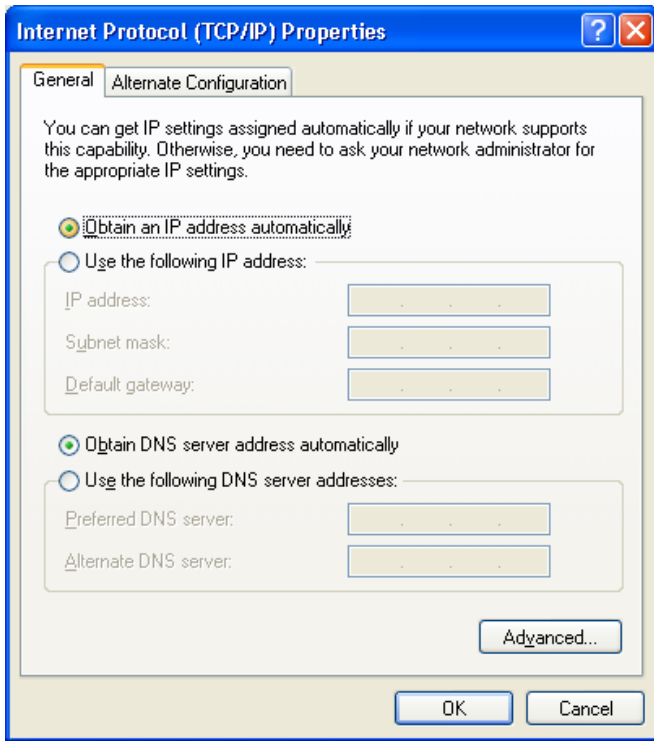

Figure 20: TCP/IP Properties (Windows XP)

5. Ensure your TCP/IP settings are correct.

Using DHCP

To use DHCP, select the radio button *Obtain an IP Address automatically*. This is the default Windows setting. **Using this is recommended.** By default, the TW100-BRM504 will act as a DHCP Server.

Restart your PC to ensure it obtains an IP Address from the TW100-BRM504.

Using a fixed IP Address ("Use the following IP Address")

If your PC is already configured, check with your network administrator before making the following changes.

- In the *Default gateway* field, enter the TW100-BRM504's IP address and click *OK*. Your LAN administrator can advise you of the IP Address they assigned to the TW100-BRM504.
- If the *DNS Server* fields are empty, select *Use the following DNS server addresses*, and enter the DNS address or addresses provided by your ISP, then click *OK*.

Internet Access

To configure your PCs to use the TW100-BRM504 for Internet access:

- Ensure that the DSL modem, Cable modem, or other permanent connection is functional.
- Use the following procedure to configure your Browser to access the Internet via the LAN, rather than by a Dial-up connection.

For Windows 9x/ME/2000

1. Select *Start Menu - Settings - Control Panel - Internet Options*.
2. Select the *Connection* tab, and click the *Setup* button.
3. Select "I want to set up my Internet connection manually, or I want to connect through a local area network (LAN)" and click *Next*.
4. Select "I connect through a local area network (LAN)" and click *Next*.
5. Ensure all of the boxes on the following Local area network Internet Configuration screen are **unchecked**.
6. Check the "No" option when prompted "Do you want to set up an Internet mail account now?".
7. Click *Finish* to close the Internet Connection Wizard.
Setup is now completed.

For Windows XP

1. Select *Start Menu - Control Panel - Network and Internet Connections*.
2. Select *Set up or change your Internet Connection*.
3. Select the *Connection* tab, and click the *Setup* button.
4. Cancel the pop-up "Location Information" screen.
5. Click *Next* on the "New Connection Wizard" screen.
6. Select "Connect to the Internet" and click *Next*.
7. Select "Set up my connection manually" and click *Next*.
8. Check "Connect using a broadband connection that is always on" and click *Next*.
9. Click *Finish* to close the New Connection Wizard.
Setup is now completed.

Accessing AOL

To access AOL (America On Line) through the TW100-BRM504, the *AOL for Windows* software must be configured to use TCP/IP network access, rather than a dial-up connection. The configuration process is as follows:

- Start the *AOL for Windows* communication software. Ensure that it is Version 2.5, 3.0 or later. This procedure will not work with earlier versions.
- Click the *Setup* button.
- Select *Create Location*, and change the location name from "New Locality" to "TW100-BRM504".
- Click *Edit Location*. Select *TCP/IP* for the *Network* field. (Leave the *Phone Number* blank.)
- Click *Save*, then *OK*.
Configuration is now complete.
- Before clicking "Sign On", always ensure that you are using the "TW100-BRM504" location.

Macintosh Clients

From your Macintosh, you can access the Internet via the TW100-BRM504. The procedure is as follows.

1. Open the TCP/IP Control Panel.
2. Select *Ethernet* from the *Connect via* pop-up menu.
3. Select *Using DHCP Server* from the *Configure* pop-up menu. The DHCP Client ID field can be left blank.
4. Close the TCP/IP panel, saving your settings.

Note:

If using manually assigned IP addresses instead of DHCP, the required changes are:

- Set the *Router Address* field to the TW100-BRM504's IP Address.
- Ensure your DNS settings are correct.

Linux Clients

To access the Internet via the TW100-BRM504, it is only necessary to set the TW100-BRM504 as the "Gateway".

Ensure you are logged in as "root" before attempting any changes.

Fixed IP Address

By default, most Unix installations use a fixed IP Address. If you wish to continue using a fixed IP Address, make the following changes to your configuration.

- Set your "Default Gateway" to the IP Address of the TW100-BRM504.
- Ensure your DNS (Name server) settings are correct.

To act as a DHCP Client (recommended)

The procedure below may vary according to your version of Linux and X -windows shell.

1. Start your X Windows client.
2. Select *Control Panel - Network*
3. Select the "Interface" entry for your Network card. Normally, this will be called "eth0".
4. Click the *Edit* button, set the "protocol" to "DHCP", and save this data.
5. To apply your changes
 - Use the "Deactivate" and "Activate" buttons, if available.
 - OR, restart your system.

Other Unix Systems

To access the Internet via the TW100-BRM504:

- Ensure the "Gateway" field for your network card is set to the IP Address of the TW100-BRM504.
- Ensure your DNS (Name Server) settings are correct.

Chapter 5

Operation and Status



This Chapter details the operation of the TW100-BRM504 and the status screens.

Operation

Once both the TW100-BRM504 and the PCs are configured, operation is automatic.

However, there are some situations where additional Internet configuration may be required. Refer to *Chapter 6 - Advanced Features* for further details.

Status Screen

Use the **Status** link on the main menu to view this screen.

The screenshot shows the 'Status' screen with a blue header and a white content area. The left sidebar is blue with white text for category labels. The main content area is white with black text for details. At the bottom, there are three buttons: 'Attached Devices', 'Refresh Screen', and 'Help'.

Category	Item	Value
ADSL	Modem Status	Connecting
	DownStream Connection Speed	0 kbps
	UpStream Connection Speed	0 kbps
	DSL Multiplexing Method:	LLC-BASED
	VPI	0
	VCI	33
Internet	Connection Method:	PPPOE
	Connection Status:	Not connected
	Internet IP Address:	---
		Connection Details
LAN	IP Address:	192.168.0.1
	Network Mask:	255.255.255.0
	DHCP Server:	On
	MAC Address	00:09:5b:70:46:6e
System	Device Name:	ADSL Router (ANNEX A)
	Firmware Version:	0.01.07

Figure 21: Status Screen

Data - Status Screen

ADSL	
Modem Status	This indicates the status of the ADSL modem component.
DownStream Connection Speed	Displays the speed for the DownStream Connection.

UpStream Connection Speed	Displays the speed for the UpStream Connection.
DSL Multiplexing Method	Indicates the current DSL Multiplexing method (LLC-Based or VC-Based)
VPI	Indicates the current VPI setting for the DSL connection
VCI	Indicates the current VCI setting for the DSL connection
Internet	
Connection Method	Displays the current connection method.
Connection Status	<p>This indicates the current status of the Internet Connection.</p> <ul style="list-style-type: none"> • Active - Connection exists • Idle - No current connection, but no error has been detected. This condition normally arises when an idle connection is automatically terminated. • Failed - The connection was terminated abnormally. This could be caused by Modem failure, or the loss of the connection to the ISP's server. <p>If there is an error, you can click the "Connection Details" button to find out more information.</p>
Internet IP Address	This IP Address is allocated by the ISP (Internet Service Provider). If using a dynamic IP address, and no connection currently exists, this information is unavailable.
Connection Details	Click this button to open a sub-window and view a detailed description of the current connection. Depending on the type of connection, a "log" may also be available.
LAN	
IP Address	The IP Address of the TW100-BRM504.
Network Mask	The Network Mask (Subnet Mask) for the IP Address above.
DHCP Server	This shows the status of the DHCP Server function. The value will be "Enabled" or "Disabled".
MAC Address	This shows the MAC Address for the TW100-BRM504, as seen on the LAN interface.
System	
Device Name	The current name of the TW100-BRM504. This is also the "hostname" provided to ISPs who request this information.
Firmware Version	The version of the current firmware installed.
Buttons	
Connection Details	Click this button to open a sub-window and view a detailed description of the current connection. Depending on the type of connection, a "log" may also be available.
Attached Devices	This will open a sub-window, showing all LAN devices currently on the network.
Refresh Screen	Update the data displayed on screen.

Connection Status - PPPoE & PPPoA

If using PPPoE (PPP over Ethernet) or PPPoA (PPP over ATM), a screen like the following example will be displayed when the "Connection Details" button is clicked.

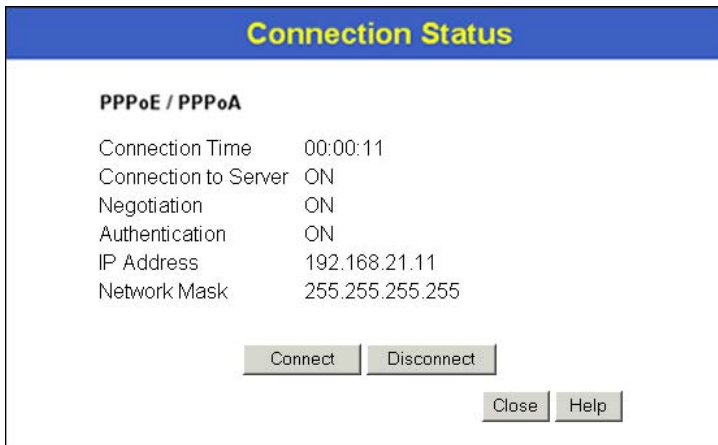

Figure 22: PPPoE/PPPoA Status Screen

Data – PPPoE/PPPoA Screen

Connection Time	This indicates how long the current connection has been established.
PPPoE Link Status	This indicates whether or not the connection is currently established. <ul style="list-style-type: none"> • If the connection does not exist, the "Connect" button can be used to establish a connection. • If the connection currently exists, the "Disconnect" button can be used to break the connection.
Negotiation	This indicates the status of the PPPoE Server login.
IP Address	The IP Address of this device, as seen by Internet users. This address is allocated by your ISP (Internet Service Provider).
Network Mask	The Network Mask associated with the IP Address above.
Buttons	
Connect	If not connected, establish a connection to your ISP.
Disconnect	If connected to your ISP, hang up the connection.
Close	Close this window.

Connection Details - Dynamic IP Address

If your access method is "Direct" (no login), with a Dynamic IP address, a screen like the following example will be displayed when the "Connection Details" button is clicked.

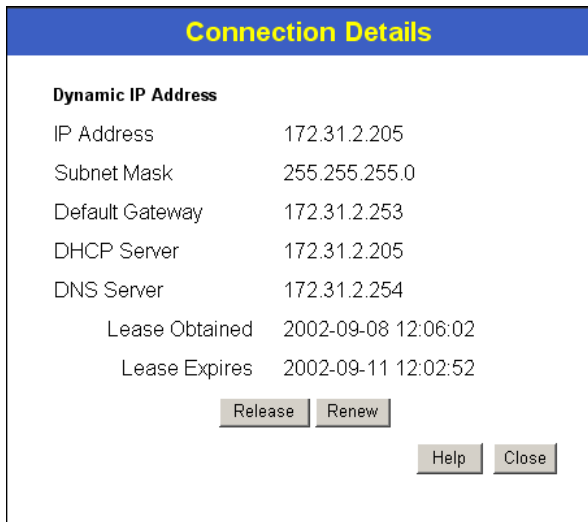

Figure 23: Connection Details - Dynamic IP Address

Data - Dynamic IP address

Internet	
IP Address	The current IP Address of this device, as seen by Internet users. This address is allocated by your ISP (Internet Service Provider).
Network Mask	The Network Mask associated with the IP Address above.
Default Gateway	The IP address of the remote Gateway or Router associated with the IP Address above.
DHCP Server	The IP address of your ISP's DHCP Server.
DNS Server	The IP address of the Domain Name Server which is currently used.
Lease Obtained Lease Expires	This indicates when the current IP address was obtained, and how long before this IP address allocation (the DHCP lease) expires.
Buttons	
Release	If an IP Address has been allocated to the TW100-BRM504 (by the ISP's DHCP Server, clicking the "Release" button will break the connection and release the IP Address.
Renew	If the ISP's DHCP Server has NOT allocated an IP Address for the TW100-BRM504, clicking the "Renew" button will attempt to re-establish the connection and obtain an IP Address from the ISP's DHCP Server.
Close	Close this window.

Connection Details - Fixed IP Address

If your access method is "Direct" (no login), with a fixed IP address, a screen like the following example will be displayed when the "Connection Details" button is clicked.

Connection Status	
Fixed IP Address	
IP Address	192.168.9.45
Subnet Mask	255.255.255.0
Default Gateway	192.168.9.254
DNS Server	168.95.1.1
<input type="button" value="Close"/> <input type="button" value="Help"/>	

Figure 24: Connection Details - Fixed/Dynamic IP Address

Data - Fixed IP address Screen

Internet	
IP Address	The IP Address of this device, as seen by Internet users. This address is allocated by your ISP (Internet Service Provider).
Network Mask	The Network Mask associated with the IP Address above.
Default Gateway	The IP Address of the remote Gateway or Router associated with the IP Address above.
DNS Server	The IP Address of the Domain Name Server which is currently used.

Chapter 6

Advanced Features

This Chapter explains when and how to use the TW100-BRM504's "Advanced" Features.

Overview

The following advanced features are provided:

- Advanced Internet
 - DMZ
 - URL filter
- Dynamic DNS
- Firewall Rules
- Firewall Services
- Schedule
- Virtual Servers

Internet

This screen provides access to the DMZ and URL Filter features.

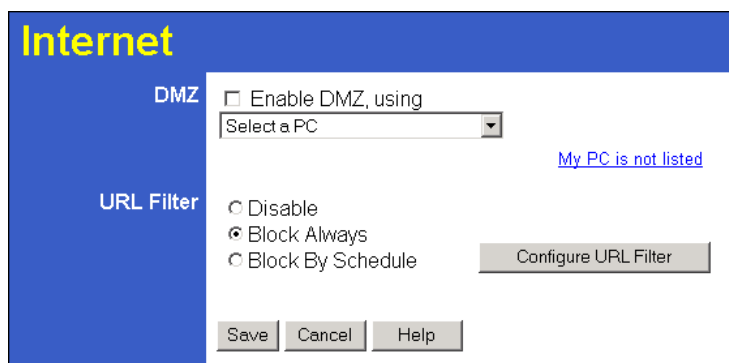

Figure 25: Advanced Internet Screen

DMZ

This feature, if enabled, allows the DMZ computer on your LAN to be exposed to all users on the Internet.

- This allows almost any application to be used on the "DMZ PC".
- The "DMZ PC" will receive all "Unknown" connections and data.
- If the DMZ feature is enabled, you must select the PC to be used as the "DMZ PC".



The "DMZ PC" is effectively outside the Firewall, making it more vulnerable to attacks. For this reason, you should only enable the DMZ feature when required.

URL Filter

If you want to limit access to certain sites on the Internet, you can use this feature. The URL filter will check each Web site access. If the address, or part of the address, is included in the block site list, access will be denied.

On the *Advanced Internet* screen, select the desired setting:

- **Disable** - disable this feature.
- **Block By Schedule** - block according to the settings on the *Schedule* page.
- **Block Always** - allow blocking all of the time, independent of the *Schedule* page.

Click the **Configure URL Filter** button to open the URL Filter screen, allowing you to create or modify the filter strings which determine which sites will be blocked.

URL Filter Screen

This screen is displayed when the **Configure URL Filter** button on the *Advanced Internet* screen is clicked.

Figure 26: URL Filter Screen

Data - URL Filter Screen

Current Filter Strings

Current Filter Strings

The list contains the current list of items to block.

- To add to the list, use the "Add" option below.
- To delete an entry, select it and click **Delete** button.
- To delete all entries, click the **Delete All** button.

Add Filter String	To add to the current list, type the word or domain name you want to block into the field provided, then click the Add button. Filter strings should be as specific as possible. Otherwise, you may block access to many more sites than intended.
Trusted PC	
Allow Trusted PC	Enable this to allow one computer to have unrestricted access to the Internet. For this PC, the URL filter will be ignored. If enabled, you must select the PC to be the trusted PC.
Trusted PC	Select the PC to be the Trusted PC.

Dynamic DNS (Domain Name Server)

This free service is very useful when combined with the *Virtual Server* feature. It allows Internet users to connect to your Virtual Servers using a URL, rather than an IP Address.

This also solves the problem of having a dynamic IP address. With a dynamic IP address, your IP address may change whenever you connect, which makes it difficult to connect to you.

The DynDNS Service works as follows:

1. You must register for the service at <http://www.dyndns.org> (Registration is free). Your password will be E-mailed to you.
2. After registration, use the "Create New Host" option (at www.dyndns.org) to request your desired Domain name.
3. Enter your data from www.dyndns.org in the TW100-BRM504's DDNS screen.
4. The TW100-BRM504 will then automatically ensure that your current IP Address is recorded at <http://www.dyndns.org>
5. From the Internet, users will be able to connect to your Virtual Servers (or DMZ PC) using your Domain name, as shown on this screen.

Dynamic DNS Screen

Select *Advanced* on the main menu, then *Dynamic DNS*, to see a screen like the following:

Figure 27: DDNS Screen

Data - Dynamic DNS Screen

DDNS Service	
Use a Dynamic DNS Service	Use this to enable or disable the DDNS feature as required.
DDNS Data	
Service Provider	Select the desired DDNS Service provider.
Host Name	Enter the domain name allocated to you by the DDNS Service. If you have more than one name, enter the name you wish to use.
User Name	Enter your Username for the DDNS Service.
Password	Enter your current password for the DDNS Service.
DDNS Status	<ul style="list-style-type: none"> • This message is returned by the DDNS Server • Normally, this message should be "Update successful" • If the message is "No host", this indicates the host name entered was not allocated to you. You need to connect to DDNS Service provider and correct this problem.

Firewall Rules

The **Firewall Rules** screen allows you to define "Firewall Rules" which can allow or prevent certain traffic.

By default:

- All Outgoing traffic is permitted.
- All Incoming traffic is denied.

"Traffic" means incoming connection attempts, not packets.

Because of this default behavior, any **Outgoing** rules will generally **Block** traffic, and **Incoming** rules will generally **Allow** traffic.

Firewall Rules Screen

An example screen is shown below.

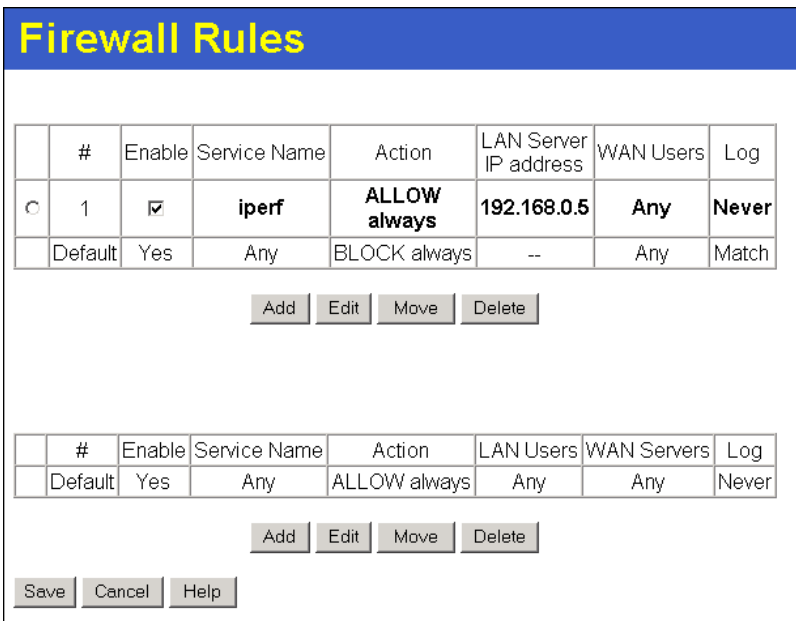

Figure 28 Firewall Screen

Data – Firewall Rules

Incoming Rules	
#	For the default rule, this will display "Default". For rules which you create, this will display a radio button which allows you to select the rule.
Enable	Indicates whether or not the rule is currently enabled. For rules you have added, this column will contain a checkbox, allowing you to easily enable or disable the rule. (Click "Save" after making any changes.)
Service Name	The Service covered by this rule.
Action	The action performed on connections which are covered by this rule.

LAN Server IP Address	The PC or Server on your LAN to which traffic covered by this rule will be sent.
WAN Users	The WAN IP address or addresses covered by this rule.
Log	Indicates whether or not connections covered by this rule should be logged.
Buttons	Use the <i>Add</i> button to create a new rule. The other buttons - <i>Edit</i> , <i>Move</i> , or <i>Delete</i> - require that a rule be selected first. Use the radio buttons in the left column to select the desired rule.
Outgoing Rules	
#	For the default rule, this will display "Default". For rules which you create, this will display a radio button which allows you to select the rule.
Enable	Indicates whether or not the rule is currently enabled. For rules you have added, this column will contain a checkbox, allowing you to easily enable or disable the rule. (Click "Save" after making any changes.)
Service Name	The Service covered by this rule.
Action	The action performed on connections which are covered by this rule.
LAN Users	The LAN PC or PCs covered by this rule.
WAN Servers	The WAN IP address or addresses covered by this rule.
Log	Indicates whether or not connections covered by this rule should be logged.
Buttons	Use the <i>Add</i> button to create a new rule. The other buttons - <i>Edit</i> , <i>Move</i> , or <i>Delete</i> - require that a rule be selected first. Use the radio buttons in the left column to select the desired rule.

Incoming Rules

This screen is displayed when the "Add" or "Edit" button for Incoming Rules is clicked.

Figure 29: Inbound Services Screen

Data – Incoming Rules Screen

Inbound Services	
Service	Select the desired Service. This determines which packets are covered by this rule. If necessary, you can define a new Service on the "Services" screen, by defining the protocols and port numbers used by the Service.
Action	<p>Select the desired action for packets covered by this rule:</p> <ul style="list-style-type: none"> • ALLOW always • ALLOW by schedule, otherwise Block • BLOCK always • BLOCK by schedule, otherwise Allow <p>Note:</p> <ul style="list-style-type: none"> • Any inbound traffic which is not allowed by rules you create will be blocked by the Default rule. • BLOCK rules are only useful if the traffic is already covered by an ALLOW rule. (That is, you wish to block a sub-set of traffic which is currently allowed by another rule.) • To define the Schedule used in these selections, use the "Schedule" screen.
Send to LAN Server	Select the PC or Server on your LAN which will receive the inbound traffic covered by this rule.
WAN Users	<p>These settings determine which packets are covered by the rule, based on their source (WAN) IP address. Select the desired option:</p> <ul style="list-style-type: none"> • Any - All IP addresses are covered by this rule. • Address range - If this option is selected, you must enter the desired values in the "Single/Start" and "Finish" fields to determine the address range. • Single address - Enter the required address in the "Single/Start" fields.

Log	<p>This determines whether packets covered by this rule are logged. Select the desired action.</p> <ul style="list-style-type: none"> • Always - always log traffic considered by this rule, whether it matches or not. (This is useful when debugging your rules.) • Never - never log traffic considered by this rule, whether it matches or not. • Match - Log traffic only if it matches this rule. (The action is determined by this rule.) • Not Match - Log traffic which is considered by this rule, but does not match (The action is NOT determined by this rule.)
------------	--

Outgoing Rules

This screen is displayed when the "Add" or "Edit" button for Outgoing Rules is clicked.

Figure 30: Outbound Services Screen

Data - Outbound Rules Screen

Outbound Services	
Service	Select the desired Service or application to be covered by this rule. If the desired service or application does not appear in the list, you must define it using the Services menu.
Action	<p>Select the desired action for packets covered by this rule:</p> <ul style="list-style-type: none"> • BLOCK always • BLOCK by schedule, otherwise Allow • ALLOW always • ALLOW by schedule, otherwise Block <p>Note:</p> <ul style="list-style-type: none"> • Any outbound traffic which is not blocked by rules you create will be allowed by the Default rule. • ALLOW rules are only useful if the traffic is already covered by a BLOCK rule. (That is, you wish to allow a subset of traffic which is currently blocked by another rule.)

	<ul style="list-style-type: none"> To define the Schedule used in these selections, use the "Schedule" screen.
LAN Users	<p>Select the desired option to determine which PCs are covered by this rule:</p> <ul style="list-style-type: none"> Any - All PCs are covered by this rule. Single PC - Only the selected PC is covered by this rule. If selected, you must select the PC. <p>PC - If using Single PC above, select the PC or Server on your LAN which will be covered by this rule.</p>
WAN Users	<p>These settings determine which packets are covered by the rule, based on their source (WAN) IP address. Select the desired option:</p> <ul style="list-style-type: none"> Any - All IP addresses are covered by this rule. Address range - If this option is selected, you must enter the "Start" and "Finish" fields. Single address - Enter the required address in the "Single/Start" fields.
Log	<p>This determines whether packets covered by this rule are logged. Select the desired action.</p> <ul style="list-style-type: none"> Always - always log traffic considered by this rule, whether it matches or not. (This is useful when debugging your rules.) Never - never log traffic considered by this rule, whether it matches or not. Match - Log traffic only it matches this rule. (The action is determined by this rule.) Not Match - Log traffic which is considered by this rule, but does not match (The action is NOT determined by this rule.)

Firewall Services

This screen is used to modify the list of *Services* which are available when creating Firewall Rules.

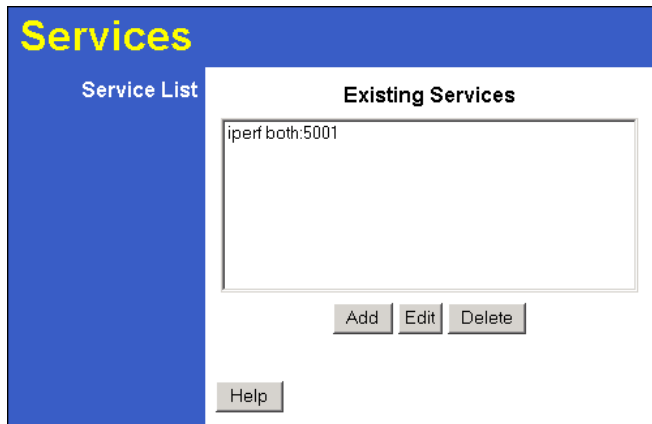

Figure 31: Services Screen

Data – Services

Services	
Services List	This lists all defined Services.
Add	Use this to open a sub-screen where you can add a new service.
Edit	To modify a service, select it, and then click this button.
Delete	Pre-defined Services can not be deleted, but you can use this button to delete any services you have defined.

Add/Edit Service

This screen is displayed when the *Add* or *Edit* button on the *Services* screen is clicked.

The screenshot shows a web form titled "Add/Edit Service". The form includes the following elements:

- Name:** A text input field.
- Type:** A dropdown menu with "TCP" selected.
- Start Port:** A text input field.
- Finish Port:** A text input field.
- Buttons:** "Save", "Cancel", "Back", and "Help".

Figure 32 : Add/Edit Service

Data – Add/Edit Service

Services	
Name	If editing, this shows the current name of the Service. If adding a new service, this will be blank, and you should enter a suitable name.
Type	Select the protocol used by the Service.
Start Port	Enter the beginning of the port range used by the Service.
Finish Port	Enter the end of the port range used by the Service.

Options

This screen allows advanced users to enter or change a number of settings. For normal operation, there is no need to use this screen or change any settings.

An example *Options* screen is shown below.

The screenshot shows a window titled "Options" with a blue header. On the left, there is a vertical menu with "Internet" and "UPnP" options. The "Internet" section is active, showing a checkbox for "Respond to Ping on Internet (WAN) Port" which is unchecked. Below it is a text input field for "MTU Size" containing the value "1492" and the text "(Bytes, 1~1500)". The "UPnP" section is also active, showing a checked checkbox for "Enable UPnP". Below it are two text input fields: "Advertisement Period" with the value "30" and "(Minutes, 1~1440)", and "Advertisement Time to Live" with the value "4" and "(Hops, 1~255)". At the bottom of the window are three buttons: "Save", "Cancel", and "Help".

Figure 33: Options Screen

Data - Options Screen

Internet	
Respond to Ping	<ul style="list-style-type: none"> If checked, the Wireless Router will repond to Ping (ICMP) packets received from the Internet. If not checked, Ping (ICMP) packets from the Internet will be ignored. Disabling this option provides a slight increase in security.
MTU Size	Enter a value between 1 and 1500. Note: MTU (Maximum Transmission Unit) size should only be changed if advised to do so by Technical Support.
UPnP	
UPnP	<ul style="list-style-type: none"> UPnP (Universal Plug and Play) allows automatic discovery and configuration of equipment attached to your LAN. UPnP is by supported Windows ME, XP, or later. If Enabled, this device will be visible via UPnP. If Disabled, this device will not be visible via UPnP.
Advertisement Period	Enter the desired value, in minutes. The valid range is from 1 to 1440.
Advertisement Time to Live	Enter the desired value, in hops. The valid range is from 1 to 255.

Schedule

This Schedule can be used for the Firewall Rules and the URL filter.

Figure 34: Default Schedule Screen

Data – Default Schedule Screen

Schedule	
Sunday, Monday...	Use these checkboxes to select the desired days.
Start Time	Enter the start using a 24 hr clock.
End Time	Enter the finish time using a 24 hr clock.
Time Zone	
Time Zone	In order to display your local time correctly, you must select your "Time Zone" from the list.
Adjust for Daylight Savings Time	If your region uses Daylight Savings Time, you must manually check "Adjust for Daylight Savings Time" at the beginning of the adjustment period, and uncheck it at the end of the Daylight Savings period.
Use this NTP Server	If you prefer to use a particular NTP server as the primary server, check the checkbox "Use this NTP Server" and enter the Server's IP address in the fields provided.. If this setting is not enabled, the default NTP Servers are used.
Current Time	This displays the current time on the TW100-BRM504.

Virtual Servers

This feature, sometimes called *Port Forwarding*, allows you to make Servers on your LAN accessible to Internet users. Normally, Internet users would not be able to access a server on your LAN because:

- Your Server does not have a valid external IP Address.
- Attempts to connect to devices on your LAN are blocked by the firewall in this device.

The "Virtual Server" feature solves these problems and allows Internet users to connect to your servers, as illustrated below.

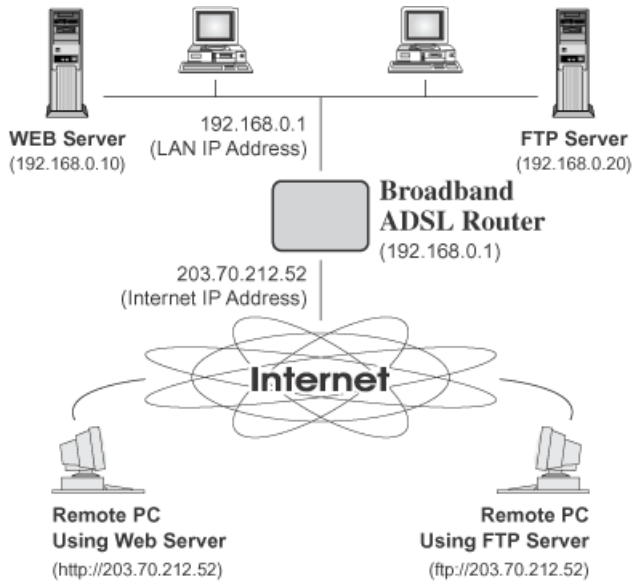

Figure 35: Virtual Servers

IP Address seen by Internet Users

Note that, in this illustration, both Internet users are connecting to the same IP Address, but using different protocols.

To Internet users, all virtual Servers on your LAN have the same IP Address. This IP Address is allocated by your ISP.

This address should be static, rather than dynamic, to make it easier for Internet users to connect to your Servers.

However, you can use the *DDNS (Dynamic DNS)* feature to allow users to connect to your Virtual Servers using a URL, instead of an IP Address.

Virtual Servers Screen

- The "Virtual Servers" feature allows Internet Users to access PCs on your LAN.
- The PCs must be running the appropriate Server Software.
- For Internet Users, ALL of your Servers have the same IP address. This IP address is allocated by your ISP.
- To make it easier for Internet users to connect to your Servers, you can use the "DDNS" feature. This allows Internet users to connect to your Servers with a URL, rather than an IP address. This technology works even if your ISP allocates dynamic IP addresses (IP address is allocated upon connection, so it may change each time you connect).

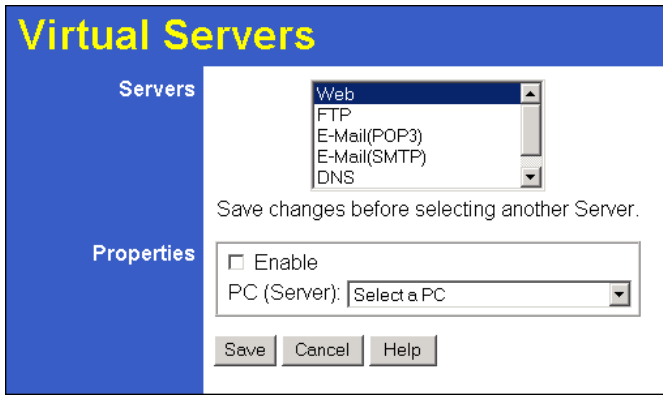

Figure 36: Virtual Servers Screen

Data - Virtual Servers Screen

Servers	
Servers	This lists a number of common Server types. If the desired Server type is not listed, you can create a Firewall Rule to achieve the same effect as the Virtual Server function.
Properties	
Enable	Use this to Enable or Disable support for this Server, as required. If Enabled, you must select the PC to which this traffic will be sent.
PC (Server)	Select the PC for this Server. The PC must be running the appropriate Server software.



Note!

For each entry, the PC must be running the appropriate Server software.

If the desired Server type is not listed, you can define your own Servers, using the Firewall Rules.

Connecting to the Virtual Servers

Once configured, anyone on the Internet can connect to your Virtual Servers. They must use the Internet IP Address (the IP Address allocated to you by your ISP).

e.g.

`http://203.70.212.52`

`ftp://203.70.212.52`

It is more convenient if you are using a Fixed IP Address from your ISP, rather than Dynamic. However, you can use the *Dynamic DNS* feature, described in the following section, to allow users to connect to your Virtual Servers using a URL, rather than an IP Address.



Note!

From the Internet, ALL Virtual Servers have the IP Address allocated by your ISP

Chapter 7

Advanced Administration



This Chapter explains the settings available via the "Administration" section of the menu.

Overview

Normally, it is not necessary to use these screens, or change any settings. These screens and settings are provided to deal with non-standard situations, or to provide additional options for advanced users.

The available settings and features are:

PC Database	This is the list of PCs shown when you select the "DMZ PC" or a "Virtual Server". This database is maintained automatically, but you can add and delete entries for PCs which use a Fixed (Static) IP Address.
Config File	Backup or restore the configuration file for the TW100-BRM504. This file contains all the configuration data.
Logs	View or clear all logs, set E-Mailing of log files and alerts.
Diagnostics	Perform a Ping or DNS Lookup.
E-mail	View or clear all logs, set E-Mailing of log files and alerts.
Remote Admin	Allow settings to be changed from the Internet..
Routing	Only required if your LAN has other Routers or Gateways.
Upgrade Firmware	Upgrade the Firmware (software) installed in your TW100-BRM504.

PC Database

The PC Database is used whenever you need to select a PC (e.g. for the "DMZ" PC).

- It eliminates the need to enter IP addresses.
- Also, you do not need to use fixed IP addresses on your LAN.

However, if you do use a fixed IP address on some devices on your LAN, you should enter details of each such device into the PC database, using the PC Database screen.

PC Database Screen

An example *PC Database* screen is shown below.

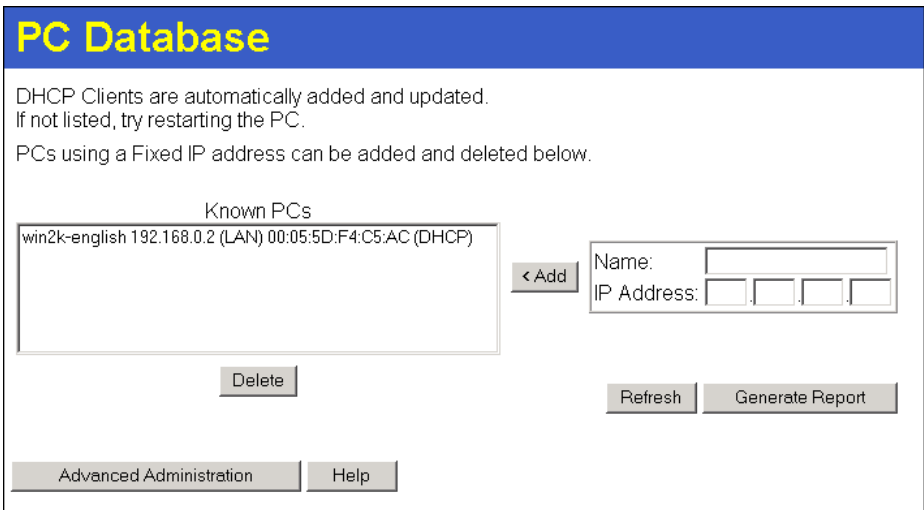

Figure 37: PC Database

- PCs which are "DHCP Clients" are automatically added to the database, and updated as required.
- By default, non-Server versions of Windows act as "DHCP Clients"; this setting is called "Obtain an IP Address automatically".
- The TW100-BRM504 uses the "Hardware Address" to identify each PC, not the name or IP address. The "Hardware Address" can only change if you change the PC's network card or adapter.
- This system means you do NOT need to use Fixed (static) IP addresses on your LAN. However, you can add PCs using Fixed (static) IP Addresses to the PC database if required.

Data - PC Database Screen

Known PCs	This lists all current entries. Data displayed is <i>name (IP Address) type</i> . The "type" indicates whether the PC is connected to the LAN.
Name	If adding a new PC to the list, enter its name here. It is best if this matches the PC's "hostname".
IP Address	Enter the IP Address of the PC. The PC will be sent a "ping" to determine its hardware address. If the PC is not available (not connected, or not powered On) you will not be able to add it.
Buttons	
Add	This will add the new PC to the list. The PC will be sent a "ping" to determine its hardware address. If the PC is not available (not connected, or not powered On) you will not be able to add it.
Delete	Delete the selected PC from the list. This should be done in 2 situations: <ul style="list-style-type: none"> • The PC has been removed from your LAN. • The entry is incorrect.
Refresh	Update the data on screen.
Generate Report	Display a read-only list showing full details of all entries in the PC database.
Advanced Administration	View the Advanced version of the PC database screen - <i>PC Database (Admin)</i> . See below for details.

PC Database (Admin)

This screen is displayed if the "Advanced Administration" button on the *PC Database* is clicked. It provides more control than the standard *PC Database* screen.

PC Database - Advanced

Any PC may be added, edited or deleted. If adding a PC which is not connected and On, you must provide the MAC (hardware) address

Known PCs

win2k-english 192.168.0.2 (LAN) 00:05:5D:F4:C5:AC (DHCP)

PC Properties

Name:

IP Address: Automatic (DHCP Client)
 DHCP Client - reserved IP address:
 Fixed IP address (set on PC):

MAC Address: Automatic discovery (PC must be available on LAN)
 MAC address is

Figure 38: PC Database (Admin)

Data - PC Database (Admin) Screen

Known PCs	This lists all current entries. Data displayed is <i>name (IP Address) type</i> . The "type" indicates whether the PC is connected to the LAN.
PC Properties	
Name	If adding a new PC to the list, enter its name here. It is best if this matches the PC's "hostname".
IP Address	<p>Select the appropriate option:</p> <ul style="list-style-type: none"> Automatic - The PC is set to be a DHCP client (Windows: "Obtain an IP address automatically"). The TW100-BRM504 will allocate an IP address to this PC when requested to do so. The IP address could change, but normally won't. DCHP Client - Reserved IP Address - Select this if the PC is set to be a DCHP client, and you wish to guarantee that the TW100-BRM504 will always allocate the same IP Address to this PC. Enter the required IP address. Fixed IP Address - Select this if the PC is using a Fixed (Static) IP address. Enter the IP address allocated to the PC. (The PC itself must be configured to use this IP address.)

MAC Address	<p>Select the appropriate option</p> <ul style="list-style-type: none"> • Automatic discovery - Select this to have the TW100-BRM504 contact the PC and find its MAC address. This is only possible if the PC is connected to the LAN and powered On. • MAC address is - Enter the MAC address on the PC. The MAC address is also called the "Hardware Address", "Physical Address", or "Network Adapter Address". The TW100-BRM504 uses this to provide a unique identifier for each PC. Because of this, the MAC address can NOT be left blank.
Buttons	
Add as New Entry	<p>Add a new PC to the list, using the data in the "Properties" box. If "Automatic discovery" (for MAC address) is selected, the PC will be sent a "ping" to determine its hardware address. This will fail unless the PC is connected to the LAN, and powered on.</p>
Update Selected PC	<p>Update (modify) the selected PC, using the data in the "Properties" box.</p>
Clear Form	<p>Clear the "Properties" box, ready for entering data for a new PC.</p>
Refresh	<p>Update the data on screen.</p>
Generate Report	<p>Display a read-only list showing full details of all entries in the PC database.</p>
Standard Screen	<p>Click this to view the standard <i>PC Database</i> screen.</p>

Config File

This feature allows you to download the current settings from the TW100-BRM504, and save them to a file on your PC.

You can restore a previously-downloaded configuration file to the TW100-BRM504, by uploading it to the TW100-BRM504.

This screen also allows you to set the TW100-BRM504 back to its factory default configuration. Any existing settings will be deleted.

An example *Config File* screen is shown below.

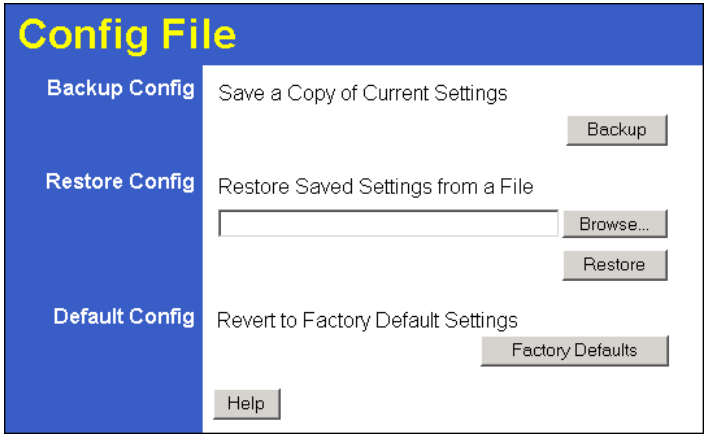

Figure 39: Config File Screen

Data - Config File Screen

Backup Config	Use this to download a copy of the current configuration, and store the file on your PC. Click <i>Download</i> to start the download.
Restore Config	<p>This allows you to restore a previously-saved configuration file back to the TW100-BRM504.</p> <p>Click <i>Browse</i> to select the configuration file, then click <i>Restore</i> to upload the configuration file.</p> <p>WARNING !</p> <p>Uploading a configuration file will destroy (overwrite) ALL of the existing settings.</p>
Default Config	<p>Clicking the <i>Factory-e Defaults</i> button will reset the TW100-BRM504 to its factory default settings.</p> <p>WARNING !</p> <p>This will delete ALL of the existing settings.</p>

Logs

The Logs record various types of activity on the TW100-BRM504. This data is useful for troubleshooting, but enabling all logs will generate a large amount of data and adversely affect performance.

Since only a limited amount of log data can be stored in the TW100-BRM504, log data can also be E-mailed to your PC. Use the *E-mail* screen to configure this feature.

Figure 40: Logs Screen

Data - Logs Screen

Logs	
Current Time	The current time on the TW100-BRM504 is displayed.
Log Data	Current log data is displayed in this panel.
Buttons	<p>There are three (3) buttons</p> <ul style="list-style-type: none"> • Refresh - Update the log data. • Clear Log - Clear the log, and restart it. This makes new messages easier to read. • Send Log - E-mail the log immediately. This is only functional if the <i>E-mail</i> screen has been configured.

Logs	
Include (Checkboxes)	<p>Use these checkboxes to determine which events are included in the log. Checking all options will increase the size of the log, so it is good practice to disable any events which are not really required.</p> <ul style="list-style-type: none"> • Attempted access to blocked sites - If checked, attempted Internet accesses which were blocked are logged. • Connections to the Web-based interface of this Router - If checked, this will log connections TO this Router, rather than through this Router to the Internet. • Router operation - If checked, other Router operations (not covered by the selections above) will be logged. • Known DoS attacks and Port Scans - If checked, Denial of Service attacks, as well as port scans, will be logged.
Syslog	
Disable	Data is not sent to a Syslog Server.
Broadcast on LAN	The Syslog data is broadcast, rather than sent to a specific Syslog server. Use this if your Syslog Server does not have a fixed IP address.
Send to this Syslog Server IP Address	If your Syslog server has a fixed IP address, select this option, and enter the IP address of your Syslog server.

E-mail

This screen allows you to E-mail Logs and Alerts. A sample screen is shown below.

Figure 41: E-mail Screen

Data – E-mail Screen

E-Mail Notification	
Turn E-mail Notification on	Check this box to enable this feature. If enabled, the E-mail address information (below) must be provided.
Send to this E-mail address	Enter the E-mail address the Log is to be sent to. The E-mail will also show this address as the Sender's address.
Outgoing (SMTP) Mail Server	Enter the address or IP address of the SMTP (Simple Mail Transport Protocol) Server you use for outgoing E-mail.
My SMTP Mail Server requires authentication	To stop spammers, many SMTP mail servers require you to log in to send mail. In this case, enable this checkbox, and enter the login information (User name and Password) in the fields below.
User Name	If you have enabled "My SMTP Mail Server requires authentication" above, enter the User Name required to login to your SMTP Server.
Password	If you have enabled "My SMTP Mail Server requires authentication" above, enter the password required to login to your SMTP Server.

E-mail Alerts	
Send E-mail alerts immediately	<p>You can choose to have alerts E-mailed to you, by checking the desired checkboxes. The Broadband ADSL Router can send an immediate alert when it detects a significant security incident such as</p> <ul style="list-style-type: none"> • A known hacker attack is directed at your IP address • A computer on the Internet scans your IP address for open ports • Someone on your LAN (Local Area Network) tries to visit a blocked site.
E-mail Logs	
Send Logs	<p>Select the desired option for sending the log by E-mail.</p> <ul style="list-style-type: none"> • Never (default) - This feature is disabled; Logs are not sent. • When log is full - The time is not fixed. The log will be sent when the log is full, which will depend on the volume of traffic. • Hourly, Daily, Weekly... - The log is sent on the interval specified. <ul style="list-style-type: none"> • If "Daily" is selected, the log is sent at the time specified. • If the day is specified, the log is sent once per week, on the specified day. • Select the time of day you wish the E-mail to be sent. • If the log is full before the time specified to send it, it will be sent regardless.

Network Diagnostics

This screen allows you to perform a "Ping" or a "DNS lookup". These activities can be useful in solving network problems.

An example *Network Diagnostics* screen is shown below.

Figure 42: Network Diagnostics Screen

Data - Network Diagnostics Screen

Ping	
IP Address	Enter the IP address you wish to ping. The IP address can be on your LAN, or on the Internet. Note that if the address is on the Internet, and no connection currently exists, you could get a "Timeout" error. In that case, wait a few seconds and try again.
Ping Button	After entering the IP address, click this button to start the "Ping" procedure. The results will be displayed in the <i>Ping Results</i> pane.
DNS Lookup	
Internet name	Enter the Domain name or URL for which you want a DNS (Domain Name Server) lookup. Note that if the address is on the Internet, and no connection currently exists, you could get a "Timeout" error. In that case, wait a few seconds and try again.
Lookup Button	After entering the Domain name/URL, click this button to start the "DNS Lookup" procedure.
Routing	
Display	Click this button to display the internal routing table. This information can be used by Technical Support and other staff who understand Routing Tables.

Remote Administration

If enabled, this feature allows you to manage the TW100-BRM504 via the Internet.

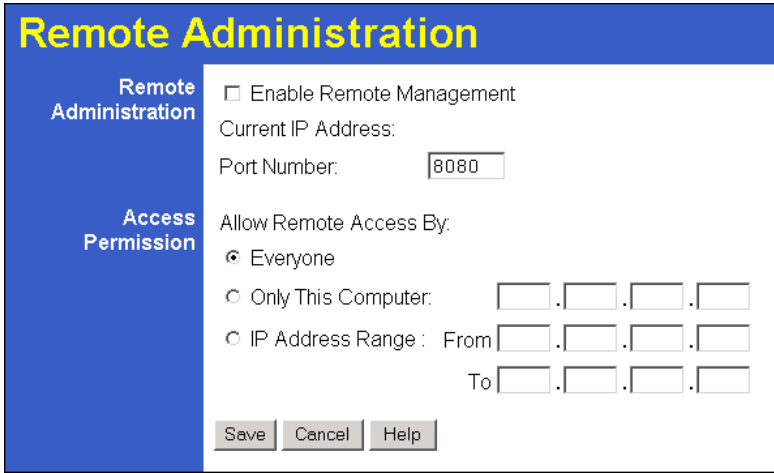

Figure 43: Remote Administration Screen

Data - Remote Administration Screen

Remote Administration	
Enable Remote Management	<p>Check to allow administration/management via the Internet. (To connect, see below).</p> <p>If Disabled, this device will ignore Administration connection attempts from the Internet.</p>
Current IP Address	<p>This is the current address you will use when accessing this device from the Internet. To connect, see details and an example below.</p>
Port Number	<p>Enter a port number between 1024 and 65535. The default for HTTP (Web) connections is port 80, but using port 80 will prevent the use of a Web "Virtual Server" on your LAN. So using a different port number is recommended. The default value is 8080.</p> <p>The port number must be specified in your Browser when you connect, as detailed above.</p>
Access Permission	
Allow Remote Access	<p>Select the desired option.</p> <ul style="list-style-type: none"> • Only This Computer - allow access by only one IP address. Enter the desired IP address. • IP Address Range - allow access from a range of IP addresses on the Internet. Enter a beginning and ending IP address to define the allowed range. • Everyone - allow access by everyone on the Internet. <p>For security, you should restrict access to as few external IP addresses as practical.</p>

To connect from a remote PC via the Internet

1. Ensure your Internet connection is established, and start your Web Browser.
2. In the "Address" bar, enter "HTTP://" followed by the Internet IP Address of the TW100-BRM504. If the port number is not 80, the port number is also required. (After the IP Address, enter ":" followed by the port number.)
e.g.

HTTP://123.123.123.123:8080

This example assumes the WAN IP Address is 123.123.123.123, and the port number is 8080.

3. You will then be prompted for the login name and password for this device.

Routing

Overview

- If you don't have other Routers or Gateways on your LAN, you can ignore the "Routing" page completely.
- If the TW100-BRM504 is only acting as a Gateway for the local LAN segment, ignore the "Routing" page even if your LAN has other Routers.
- If your LAN has a standard Router (e.g. Cisco) on your LAN, and the TW100-BRM504 is to act as a Gateway for all LAN segments, enable RIP (Routing Information Protocol) and ignore the Static Routing table.
- If your LAN has other Gateways and Routers, and you wish to control which LAN segments use each Gateway, do NOT enable RIP (Routing Information Protocol). Configure the Static Routing table instead. (You also need to configure the other Routers.)
- If using Windows 2000 Data center Server as a software Router, enable RIP on the TW100-BRM504, and ensure the following Windows 2000 settings are correct:
 - Open *Routing and Remote Access*
 - In the console tree, select *Routing and Remote Access*, [server name], *IP Routing*, *RIP*
 - In the "Details" pane, right-click the interface you want to configure for RIP version 2, and then click "Properties".
 - On the "General" tab, set *Outgoing packet protocol* to "RIP version 2 broadcast", and *Incoming packet protocol* to "RIP version 1 and 2".

Routing Screen

The routing table is accessed by the *Routing* link on the *Administration* menu.

Using this Screen

Generally, you will use either RIP (Routing Information Protocol) OR the Static Routing Table, as explained above, although it is possible to use both methods simultaneously.

Static Routing Table

- If RIP is not used, an entry in the routing table is required for each LAN segment on your Network, other than the segment to which this device is attached.
- The other Routers must also be configured. See *Configuring Other Routers on your LAN* later in this chapter for further details and an example.

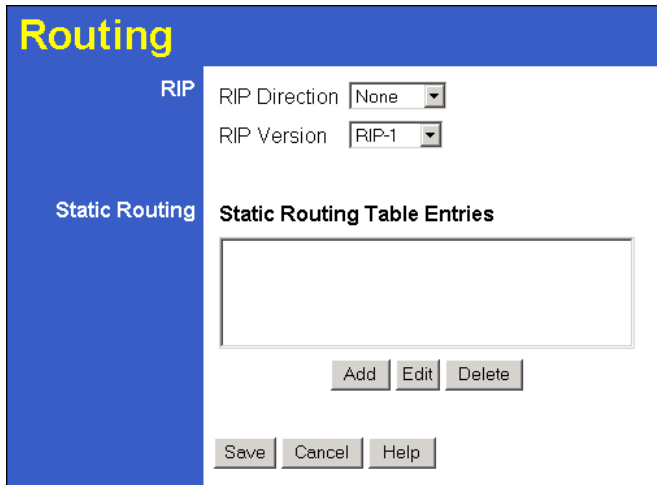

Figure 44: Routing Screen

Data - Routing Screen

RIP	
RIP Direction	Select the desired RIP Direction.
RIP Version	Choose the RIP Version for the Server.
Static Routing	
Static Routing Table Entries	<p>This list shows all entries in the Routing Table.</p> <ul style="list-style-type: none"> This area shows details of the selected item in the list. Change any the properties as required, then click the "Edit" button to save the changes to the selected entry.
Buttons	
Add	Add a new entry to the Static Routing table, using the data shown in the "Properties" area on screen. The entry selected in the list is ignored, and has no effect.
Edit	Update the current Static Routing Table entry, using the data shown in the table area on screen.
Delete	Delete the current Static Routing Table entry.
Save	Save the RIP setting. This has no effect on the Static Routing Table.

Configuring Other Routers on your LAN

It is essential that all IP packets for devices not on the local LAN be passed to the TW100-BRM504, so that they can be forwarded to the external LAN, WAN, or Internet. To achieve this, the local LAN must be configured to use the TW100-BRM504 as the *Default Route* or *Default Gateway*.

Local Router

The local router is the Router installed on the same LAN segment as the TW100-BRM504. This router requires that the *Default Route* is the TW100-BRM504 itself. Typically, routers have a special entry for the *Default Route*. It should be configured as follows.

Destination IP Address	Normally 0.0.0.0, but check your router documentation.
Network Mask	Normally 0.0.0.0, but check your router documentation.
Gateway IP Address	The IP Address of the TW100-BRM504.
Metric	1

Other Routers on the Local LAN

Other routers on the local LAN must use the TW100-BRM504's *Local Router* as the *Default Route*. The entries will be the same as the TW100-BRM504's local router, with the exception of the *Gateway IP Address*.

- For a router with a direct connection to the TW100-BRM504's local Router, the *Gateway IP Address* is the address of the TW100-BRM504's local router.
- For routers which must forward packets to another router before reaching the TW100-BRM504's local router, the *Gateway IP Address* is the address of the intermediate router.

Static Routing - Example

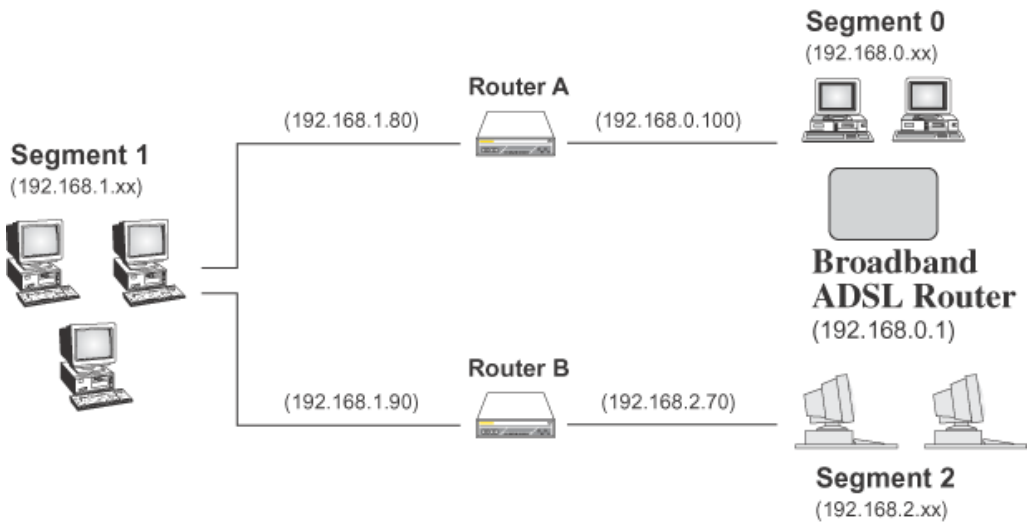

Figure 45: Routing Example

For the TW100-BRM504's Routing Table

For the LAN shown above, with 2 routers and 3 LAN segments, the TW100-BRM504 requires 2 entries as follows.

Entry 1 (Segment 1)	
Destination IP Address	192.168.1.0
Network Mask	255.255.255.0 (Standard Class C)
Gateway IP Address	192.168.0.100 (TW100-BRM504's local Router)
Metric	2

Entry 2 (Segment 2)	
Destination IP Address	192.168.2.0
Network Mask	255.255.255.0 (Standard Class C)
Gateway IP Address	192.168.0.100
Metric	3

For Router A's Default Route

Destination IP Address	0.0.0.0
Network Mask	0.0.0.0
Gateway IP Address	192.168.0.1 (TW100-BRM504's IP Address)

For Router B's Default Route

Destination IP Address	0.0.0.0
Network Mask	0.0.0.0
Gateway IP Address	192.168.1.80 (TW100-BRM504's local router)

Upgrade Firmware

The firmware (software) in the TW100-BRM504 can be upgraded using your Web Browser. You must first download the upgrade file, then select *Upgrade Firmware* on the *Administration* menu. You will see a screen like the following.

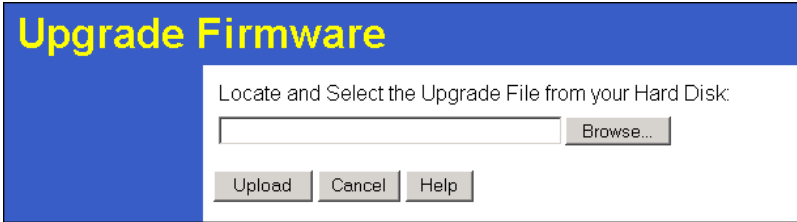

Figure 46: Router Upgrade Screen

To perform the Firmware Upgrade:

1. Click the *Browse* button and navigate to the location of the upgrade file.
2. Select the upgrade file. Its name will appear in the *Upgrade File* field.
3. Click the *Start Upgrade* button to commence the firmware upgrade.



The TW100-BRM504 is unavailable during the upgrade process, and must restart when the upgrade is completed. Any connections to or through the TW100-BRM504 will be lost.

Appendix A

Troubleshooting



This Appendix covers the most likely problems and their solutions.

Overview

This chapter covers some common problems that may be encountered while using the TW100-BRM504 and some possible solutions to them. If you follow the suggested steps and the TW100-BRM504 still does not function properly, contact your dealer for further advice.

General Problems

Problem 1: Can't connect to the TW100-BRM504 to configure it.

Solution 1: Check the following:

- The TW100-BRM504 is properly installed, LAN connections are OK, and it is powered ON.
- Ensure that your PC and the TW100-BRM504 are on the same network segment. (If you don't have a router, this must be the case.)
- If your PC is set to "Obtain an IP Address automatically" (DHCP client), restart it.
- If your PC uses a Fixed (Static) IP address, ensure that it is using an IP Address within the range 192.168.0.2 to 192.168.0.254 and thus compatible with the TW100-BRM504's default IP Address of 192.168.0.1. Also, the Network Mask should be set to 255.255.255.0 to match the TW100-BRM504.

In Windows, you can check these settings by using *Control Panel-Network* to check the *Properties* for the TCP/IP protocol.

Internet Access

Problem 1: When I enter a URL or IP address I get a time out error.

Solution 1: A number of things could be causing this. Try the following troubleshooting steps.

- Check if other PCs work. If they do, ensure that your PCs IP settings are correct. If using a Fixed (Static) IP Address, check the Network Mask, Default gateway and DNS as well as the IP Address.
- If the PCs are configured correctly, but still not working, check the TW100-BRM504. Ensure that it is connected and ON. Connect to it and check its settings. (If you can't connect to it, check the LAN and power connections.)
- Check the TW100-BRM504's status screen to see if it is working correctly.

Problem 2: Some applications do not run properly when using the TW100-BRM504.

Solution 2: The TW100-BRM504 processes the data passing through it, so it is not transparent.

For incoming connections, you must use the Virtual Server or Firewall Rules to specify the PC which will receive the incoming traffic.

You can also use the *DMZ* function. This should work with almost every application, but:

- It is a security risk, since the firewall is disabled.
- Only one (1) PC can use this feature.

Appendix B

Specifications



Multi-Function TW100-BRM504

Model	TW100-BRM504
ADSL Interface	T1.413, G.DMT, G.lite, multi-mode
Dimensions	189mm(W) * 122mm(D) * 33mm(H)
Operating Temperature	0° C to 40° C
Storage Temperature	-10° C to 70° C
Network Protocol:	TCP/IP
Network Interface:	4 * 10/100BaseT (RJ45) LAN connection 1 * RJ11 for ADSL line
LEDs	12
Power Adapter	15 V AC External

Regulatory Approvals

FCC Statement

This equipment has been tested and found to comply with the limits for a Class B digital device, pursuant to Part 15 of the FCC Rules. These limits are designed to provide reasonable protection against harmful interference in a residential installation.

This equipment generates, uses and can radiate radio frequency energy and, if not installed and used in accordance with the instructions, may cause harmful interference to radio communications. However, there is no guarantee that interference will not occur in a particular installation. If this equipment does cause harmful interference to radio or television reception, which can be determined by turning the equipment off and on, the user is encouraged to try to correct the interference by one of the following measures:

- Reorient or relocate the receiving antenna.
- Increase the separation between the equipment and receiver.
- Connect the equipment into an outlet on a circuit different from that to which the receiver is connected.
- Consult the dealer or an experienced radio/TV technician for help.

To assure continued compliance, any changes or modifications not expressly approved by the party responsible for compliance could void the user's authority to operate this equipment. (Example - use only shielded interface cables when connecting to computer or peripheral devices).

FCC Radiation Exposure Statement

This equipment complies with FCC RF radiation exposure limits set forth for an uncontrolled environment. This equipment should be installed and operated with a minimum distance of 20 centimeters between the radiator and your body.

This device complies with Part 15 of the FCC Rules. Operation is subject to the following two conditions:

- (1) This device may not cause harmful interference, and
- (2) This device must accept any interference received, including interference that may cause undesired operation.

This transmitter must not be co-located or operating in conjunction with any other antenna or transmitter.

CE Approval

CE Standards

This product complies with the 99/5/EEC directives, including the following safety and EMC standards:

- EN55022
- EN55024

CE Marking Warning

This is a Class B product. In a domestic environment this product may cause radio interference in which case the user may be required to take adequate measures.