

Technika

EXCLUSIVELY FROM **TESCO**

Model: STBHDIS2010



Technika STBHDIS2010 Freeview HD Set Top Box

Contents

Connecting your box	4	Digital text	19
Tuning your box	5	Menu operations	19
Receiving Channel Zero	5	Channels menu	20
Safety is important	6	Channel organizer	20
In the box	6	Channel groups	21
Safety information.....	7	Install menu	22
Keep these instructions	7	Channel tune	22
Important	8	Factory reset	23
Electrical information	8	Version	23
Mains supply	8	Ethernet.....	24
Parts identification	9	Settings	25
Front Panel.....	9	Language	25
Rear Panel.....	9	TV	25
Remote control	10	Time	26
Installing batteries in the remote control ..	11	Audio Description.....	26
Using the remote control	11	Parental pin	27
Connecting the TV aerial	12	Advanced.....	27
Connecting to the TV and other devices ...	12	Updates	28
Coaxial cable	12	Channel Zero	29
SCART cable	12	Accessing Channel Zero services	29
HDMI cable	13	Troubleshooting guide	30
Basic operating instructions	14	Additional information	31
Switching on for the first time	14	Specifications	31
Standby	14	Warranty	31
Source selection	14		
Selecting a channel	15		
Volume	15		
Programme swap	15		
Information display	15		
Subtitles.....	16		
Audio Description	16		
Channel list	16		
Channel favourites list	17		
TV Guide	17		
Setting the timer	18		

Quick start guide

Connecting your box

1. Connecting to your TV

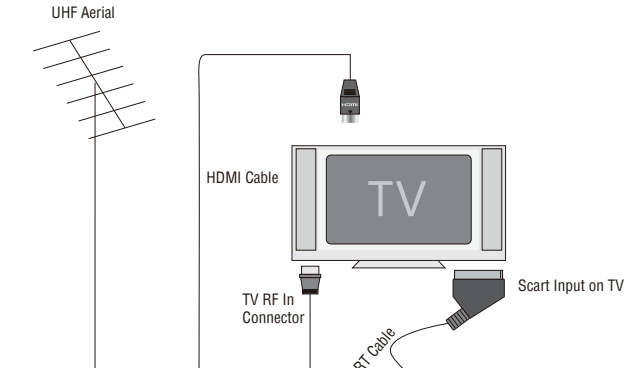

2. Connecting to a VCR or DVD recorder

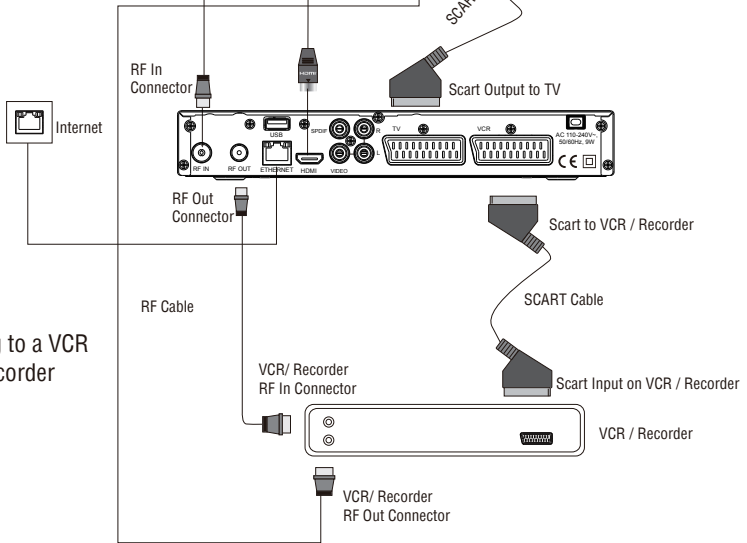

Quick start guide

Tuning your box

The first time you switch your box on, it will automatically tune all available Freeview TV and radio channels.

1. Press the  button to turn the box on. A welcome menu appears after a short time

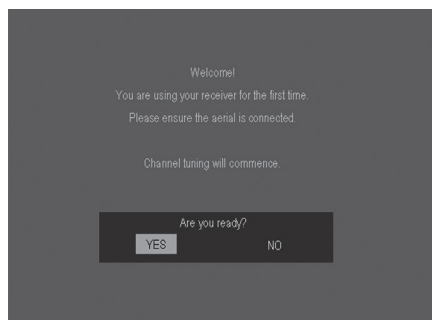

2. Press the **OK** button to enter the tuning menu.
3. Once the automatic search has been completed, all channels are stored and the first available channel is shown.



Receiving Channel Zero

Press the  button to put the box into standby, Channel Zero interactive services will now be downloaded to your box. See Channel Zero on page 29.



Services will be fully loaded when the red light on the front of the box changes to amber. This should take a few hours.



Introduction

Safety is important

To ensure your safety and the safety of others, please read the Safety information **BEFORE** you operate this product.

Keep this information in a safe place for future reference.

In the box

You will find the following:

1. Set Top Box
2. Remote Control
3. Quick Start Guide
4. User Guide



Note: If any of the items listed are damaged or missing, please contact the TESCO electrical help line on 0845 456 6767.

Safety information

IMPORTANT SAFETY INSTRUCTIONS -

READ CAREFULLY BEFORE USE

Keep these instructions

1. Do not use this box near water
2. Clean only with a slightly damp cloth
3. Do not block any ventilation openings
4. Install in accordance with the supplied Quick Start Guide and this User Guide
5. Do not install or operate near any heat sources such as radiators, stoves, or other apparatus that produce heat
6. Protect the power cord from being walked on or pinched, particularly at plugs, and the point where it exits from the box
7. Do not allow the power cord to overhang the edge of a table
8. Unplug this box from the mains and aerial during lightning storms or when unused for long periods of time
9. To avoid interference, switch this box off while operating other radio devices in the immediate vicinity
10. Refer all servicing to qualified service personnel. Servicing is required when the box has been damaged in any way, such as the power cord or plug being damaged, liquid being spilled on or objects have fallen onto the box, the box has been exposed to rain or moisture, does not operate normally, or has been dropped
11. No naked flame sources such as candles should be placed on the box

WARNING: TO REDUCE THE RISK OF FIRE OR ELECTRICAL SHOCK, DO NOT EXPOSE THIS BOX TO WATER OR MOISTURE.



THE BOX MUST NOT BE EXPOSED TO DRIPPING AND SPLASHING AND NO OBJECTS FILLED WITH LIQUIDS SHOULD BE PLACED ON THE BOX

WARNING: RISK OF ELECTRIC SHOCK. THIS BOX CONTAINS NO USER SERVICEABLE PARTS. DO NOT REMOVE ANY COVERS



Safety information

Important

This box generates, uses and can radiate radio frequency energy and, if not installed and used in accordance with these instructions, may cause harmful interference to radio communication.

However, this is no guarantee that interference will not occur in a particular installation. If the set top box does cause harmful interference to electrical devices, which can be determined by turning the box off and on, the user is encouraged to try to correct the interference by one of the following measures:

1. Re-orient or relocate the receiving aerial
2. Increase the separation between the external device and the box
3. Connect the external device into an outlet on a circuit different from that to which the box is connected
4. Consult the dealer or an experienced radio/TV technician for help

Electrical information

Mains supply

The mains operating voltage is detailed on the rear of the box

The mains lead on this box may be supplied with a moulded plug incorporating a fuse. Should the fuse need to be replaced, an ASTA or BSI approved BS1362 fuse must be used of the same rating. If the fuse cover is detachable never use the plug with the cover removed. If a replacement fuse cover is required, ensure it is of the same colour as that visible on the pin face of the plug.

If there is no alternative to cutting off the mains plug, dispose of it immediately, having first removed the fuse, to avoid a possible shock hazard by inadvertent connection to the mains supply

Parts identification

Front Panel



1. STANDBY Power On/Standby.
2. Channel up / channel down
3. Volume up / volume down
4. OK Confirm selection in menu/on screen displays.
5. MENU Open the menu so that you can change the settings of your Digital Box

Rear Panel

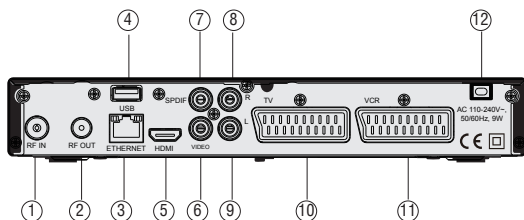

1. Connect to RF in
2. Connect to RF out
3. ETHERNET- for future interactivity
4. USB- for future interactivity
5. HDMI output (High Definition Multimedia Interface)
6. Composite video
7. Coaxial Digital audio
8. Right Audio Out
9. Left Audio Out
10. TV Scart: connect to TV
11. VCR Scart: connect to a VCR or a DVD Recorder
12. Power lead

Parts identification

Remote Control

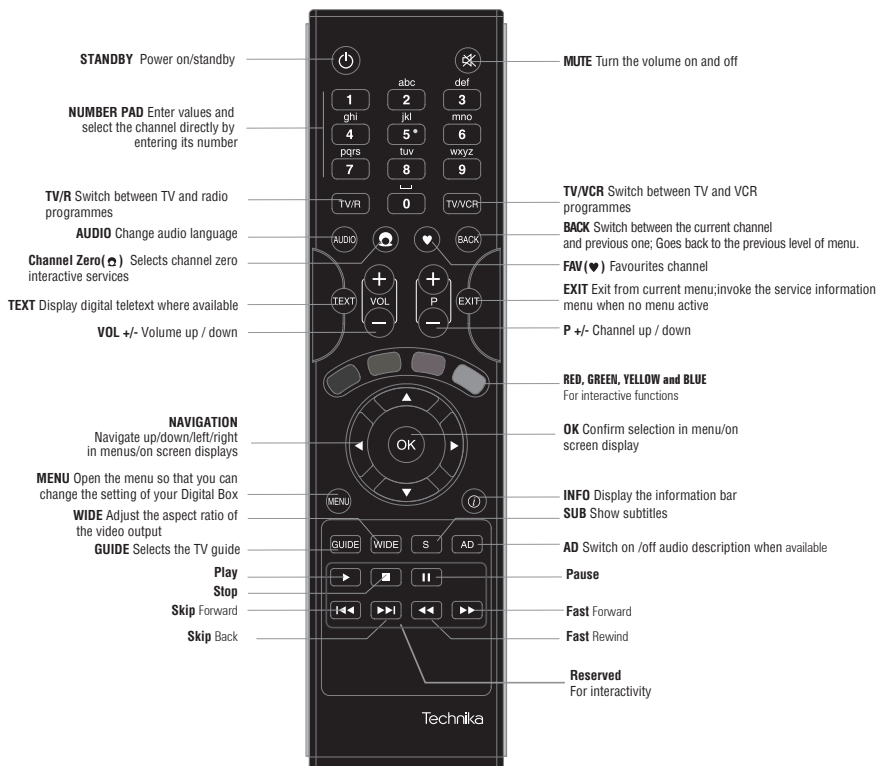

Remote control

Installing batteries in the remote control

1. Remove the battery compartment cover at the rear of the remote control by depressing the retaining clip.
2. Install two AAA batteries as shown, ensuring the polarity matches that shown in the battery compartment.
3. Replace the battery compartment cover.



Using the remote control

To use the remote control, point it at the box and press the required buttons.

You must be within 6 metres and at an angle of less than 30 degrees from the centre of the box.



Note: Sunshine or other strong light sources may interfere with the signal from the remote control. In this situation turn the box away from the light source.



WARNING! DO NOT LEAVE BATTERIES IN THE REMOTE CONTROL FOR EXTENDED PERIODS AS THEY CAN LEAK OR CORRODE CAUSING DAMAGE TO THE REMOTE CONTROL. CHECK THEM PERIODICALLY AND REPLACE THEM AS REQUIRED.



WARNING! DO NOT MIX BATTERY TYPES. WHEN INSERTING BATTERIES, REPLACE ALL BATTERIES AT THE SAME TIME. DO NOT MIX OLD AND NEW BATTERIES.



WARNING! EXHAUSTED BATTERIES MUST BE TREATED WITH CARE AND DISPOSED OF ACCORDING TO ANY SAFETY OR RECYCLING REGULATIONS IN FORCE IN YOUR LOCAL AREA. NEVER DISPOSE OF BATTERIES INTO GENERAL WASTE, OR FIRE.

Connecting the box



WARNING! ENSURE THE TV AND ALL ANCILLARY EQUIPMENTS ARE UNPLUGGED FROM THE MAINS BEFORE MAKING ANY CONNECTIONS!

Connecting the TV aerial

Connect the TV aerial to the 'RF IN' socket on the rear of the box with a 75 ohm co-axial plug. For best results use a high gain TV aerial, preferably roof or loft mounted.

Use a professionally installed external, roof mounted aerial wherever possible.

To improve the picture quality in a poor signal area, purchase and install a signal amplifier.

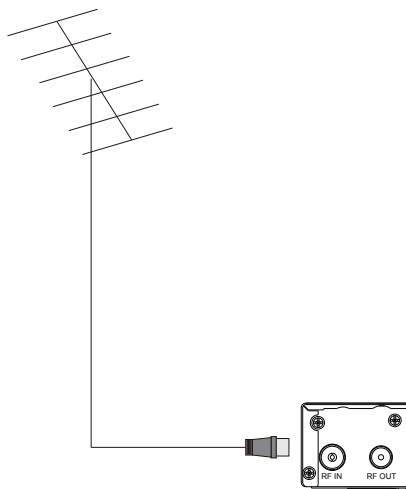

Connecting to the TV and other devices

The Quick Start Guide shows the simplest and most effective way to connect the box to ancillary equipment. Alternate methods are listed below.

Coaxial cable

If your TV does not have a SCART socket, you can connect the box to the TV using a coaxial cable. Connect the coaxial cable between the 'RF OUT' socket on the rear of the box and the aerial socket on your TV.

Using this connection method will also allow your TV to receive a signal when the box is switched off.

SCART cable

You can connect the box to your TV and VCR using a SCART cable. This connection uses component video signals, i.e. the red, green and blue (RGB) content of the video are sent on separate signals.

To connect the box to your TV, connect the SCART cable between the 'TV' SCART socket on the rear of the box and the SCART socket on your TV.

Connecting the box



Note: Please consult your VCR instruction guide for details on how to connect your box to your VCR.

HDMI cable

You can connect the box to your TV HDMI socket with a HDMI cable. This connection will output the uncompressed digital video and audio signals.

To connect the box to your TV, connect the HDMI cable between the HDMI socket on the rear of the box and the HDMI socket on your TV.

Operating the box

Basic operating instructions

Switching on for the first time

You need to perform automatic channel tuning when you turn the box on for the first time

To perform automatic tuning:

1. Make sure your box is connected to the mains and that it is connected to the aerial
2. Press **⏻** to turn the box on. After a short time, a welcome menu appears 2. Press the **OK** button to enter the tuning menu.

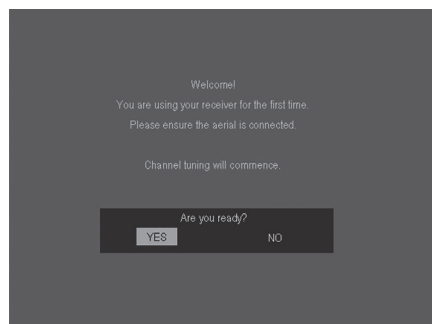

3. Press **OK** to begin the automatic tune
4. The box searches for and displays all the available TV and radio channels
5. Once the automatic search has been completed, you will be prompted to select 'Yes' to see the list of channels or 'No' to start watching TV.



Note: You can re-tune your box again at any time. See Channel tune on page 22~23.

Standby

Press **⏻** to put the box into standby, Channel Zero's services and content are loaded in standby. See Channel Zero on page 29.

The box automatically goes into standby after 3 hours if you do not use the remote control. You can adjust this time by changing the TV settings. See TV on page 25.

Note: You can make the box into passive standby pressing **⏻** for 3 seconds.



However, this will cause Channel Zero's content to be lost and the box will have to be re-loaded according to the basic operating instructions – see Accessing Channel Zero services on page 29.

Source selection

Press the **TV / R** button to switch between TV and radio channels.

Operating the box

Selecting a channel

Press the **NUMERIC** buttons to select the channel you require. Do not use leading '0's. For example to select channel 17, press the 1 button, the 7 button and then the **OK** button.

Press the **P+** or **P-** to scroll up or down through the channels.



Note: Pressing a leading '0' causes activation of the Channel Zero interactive service feature. See Channel Zero on page 29

Volume

Press the **V+** or **V-** buttons to increase or decrease the volume. A volume indicator appears at the bottom of the screen.

Mute

Press the **MUTE** button to mute the sound. The speaker symbol on the volume indicator is crossed out. Press the **MUTE** button again or the **V+** or **V-** buttons to restore the sound. The speaker symbol on the volume indicator will no longer be crossed out.

Programme swap

Press the **BACK** button to switch between the current channel and previous channel.

Information display

Press the **INFO** button to show the Information display screen. Press it again to clear the display.

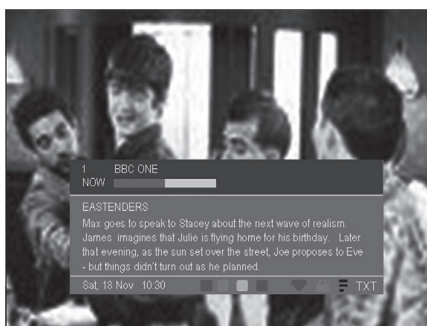

The Information display provides information on the following:

- Channel name and number.
- Viewing progress bar.
- Programme description.
- Date and time.
- Colour icons show which groups a channel belongs to.
- A heart icon is displayed if the channel

Operating the box

has been set as a favourite.

- A lock icon is displayed if parental lock has been set.
- A stripe icon is displayed if the channel has subtitles.
- A 'TXT' icon is displayed if a digital text service is available.
- An 'AD' icon is displayed if the channel has audio description.
- A 'HD' icon is displayed if the channel is a high definition program.
- A 'SD' icon is displayed if the channel is a standard definition program.

1. Press the ◀ or ▶ buttons to display information for the next programme on the same channel.
2. Press the ▲ or ▼ buttons to see information for the previous or next channel without changing channel
3. Press the **INFO** button again to clear the Information display screen .

Subtitles

1. To turn subtitles on, press the **SUB** button. A subtitles 'ON' indicator is shown at the top of the screen with language.
2. To turn subtitles off, press the **SUB** button again. A subtitles 'OFF' indicator is shown at the top of the screen.



Note: See Language on page 25 to change the subtitle language within the Settings Menu.

Audio Description

1. To turn Audio Description on, press the **AD** button. An Audio Description 'ON' indicator is shown at the top of the screen with language.
2. To turn Audio Description off, press the **AD** button again. An Audio Description 'OFF' indicator is shown at the top of the screen.

Channel list

The Channel list provides a complete listing of all the available TV and Radio channels.

1. Press the **OK** button to display the Channel List.



2. Press the ▲ or ▼ buttons to select a channel. Also, you can press the **P+** and **P-** buttons to scroll up and down a page of channels at a time.
3. Press the **OK** button to change the selected channel in the Channel list.

Operating the box

4. Press the **BACK** button to exit the Channel list without changing channel.

If you have created any channel groups, press the corresponding colour button to display only the channels that belong to that group.



Press the **0** button to display all channels.



Note: Refer to Channel groups on page 21 for how to create groups of channels.

Channel favourites list

The Channel favourites list displays just your favourite channels.

1. Press the **FAV** button to display the Channel favourites list.

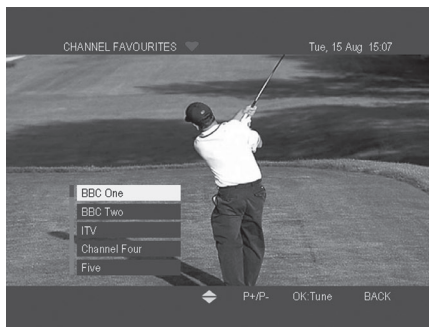

2. Press the **▲** or **▼** buttons to select a favourite channel. You can also press the **P+ and P-** buttons to scroll up and down a page of channels at a time.
3. Press the **OK** button to change the selected channel.
4. Alternatively, you can press the **BACK** button to exit the Channel favourites list without changing the channel.

TV Guide

Press the **GUIDE** button to display a guide of channel and programme information for the next 7 days in the form of a list. Typically the **GUIDE** will provide

- Current time and date
- Current channel number and name
- Preview pane of the current channel
- Broadcast schedule of programmes for the next 7 days, 5 channels at a time

Operating the box

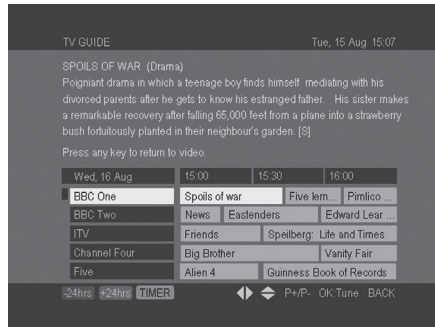

1. To display the TV Guide, press the **GUIDE** button.
2. Press the **▲/▼/◀** and **▶** buttons to navigate through the channels and programmes. You can also press the **P+** and **P-** buttons to scroll up and down a page of channels at a time.
3. Press the **GREEN** button to view the programme schedule for the next day.
4. Press the **RED** button to view the programme schedule for the previous day.

With a programme selected, you can view information, such as the start and finish time, the programme name and a brief description.

1. Press the **▲/▼/◀** and **▶** buttons to highlight the programme.
2. Press the **INFO** button once. The full programme description is shown in the upper half of the screen.

3. Press the **INFO** button again to clear the description.
4. Press the **BACK** button to exit the TV Guide.

Setting the timer

You can set your box within TV Guide to wake up and tune to a programme. To do this:

1. Press the **▲/▼/◀** and **▶** buttons to highlight the programme.
2. Press the **YELLOW** button. The highlighted programme changes colour to indicate that the programme is scheduled to be played. (You can clear the timer recording by pressing the **YELLOW** button again).

Operating the box

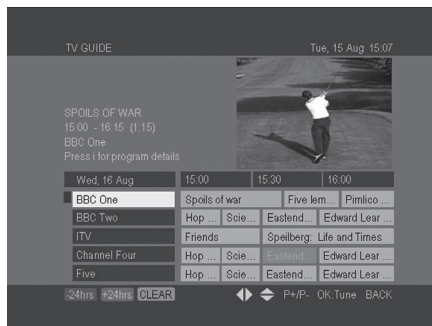

3. Press **⏻** to put the box into standby.
4. The box will wake up and tune to the programme and return to standby when it is finished.



Note: Please consult your VCR instruction guide for details on how to connect your box to your VCR, and how to programme it to record from the box at the right time.

Digital text

Digital text is an information service that displays text on your TV screen.

You can view pages of information on a variety of topics which are listed in the Digital text menu.



Note: Digital text may not be available for all channels

1. Press the **TEXT** button to display Digital text.
2. Press the **▲** and **▼** buttons to select a topic such as weather or news.
3. Press the **OK** button to select a topic.
4. Press the **▲/▼/◀** and **▶** buttons to navigate around the topic pages.
5. Press the **RED, GREEN, YELLOW and BLUE** buttons to use the Digital Text shortcuts.
6. Press the **TEXT** button to exit Digital text.

Menu operations

The on-screen menus allows you to adjust and control the box.

1. Press the **MENU** button to access the on screen menus.
2. Press the **▲** and **▼** buttons to view the different menus.
3. Press the **▶** or **OK** buttons to access the menu options.
4. Press the **▲** and **▼** buttons to view the menu options.
5. Press the **OK** button to access a menu option, Press the **BACK** or **◀** button to exit the menu options.
6. Press the **BACK** button to exit an on screen menu.

Operating the box

Channels menu

The Channels sub-menu allows you to manage your channels. You can create groups, choose favourites, and much more.

Channel organizer

The Channel organizer sub-menu allows you to manage your channels.

- mark a channel as a favourite
- set a parental lock
- skip a channel when the **P+** and **P-** buttons are pressed when watching TV
- delete a channel

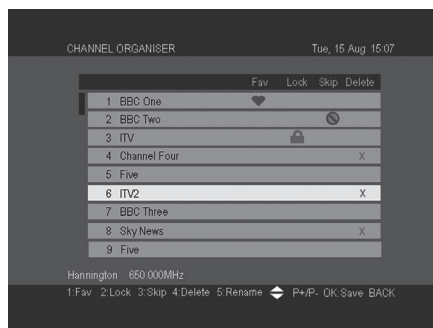

Note: Any changes made in this menu will affect the Channel list, Favourite list and TV Guide

1. Press the **MENU** button, then press the **▲/▼ / ◀▶** buttons to navigate to the 'Organise' label under the 'Channels' section in Menu.
2. Press the **▲** and **▼** buttons to select a channel.
3. Press the **1** button to mark the channel as a favourite. A heart icon appears in the 'Fav' column. The channel can be unmarked by pressing the **1** button again.
4. Press the **2** button to lock a channel. A lock icon appears in the 'lock' column next to the channel name. Once a channel is locked, the channel can only be viewed by entering the password. For more information on passwords, see Parental Pin on page 27.
5. Press the **3** button to skip a channel. A tick icon appears in the 'skip' column next to the channel name. Once you choose to skip a channel, you can no longer select it using the **P+** and **P-** buttons. The 'skip' feature can be cleared by pressing the **3** button again.
6. Press the **4** button to choose a channel to delete. A cross icon appears in the 'delete' column next to the channel name. Press the **OK** button to delete the channels marked for deletion. Press the **BACK** button to exit Channel organiser without deleting the channels.
7. Press the **5** button to rename a channel. A keypad screen (similar to a mobile phone) is displayed.

Operating the box



Note: You must re-tune in menu to restore deleted channels. See Channel tune on page 22.

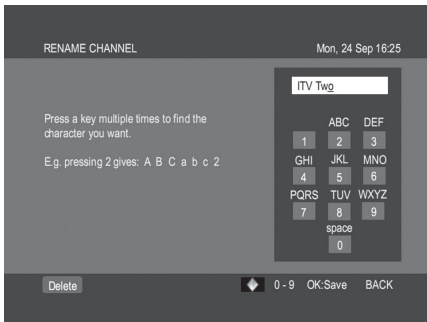

8. Press the ◀ and ▶ buttons to move the cursor and the **NUMERIC** buttons, one or more times to enter a character.
9. You can delete the character under the cursor by pressing the **RED** button.
10. Press the **OK** button to accept the new channel name and return to the previous menu.

Alternatively, press the **BACK** button if you want to exit to the previous menu without changing the channel name .

Channel groups

You can create groups of channels by a

common theme (e.g. 'news', 'children', 'movies') or by interest to a user (e.g. 'Sue', 'Michelle', 'Dad').

1. Press the **MENU** button, then press the ▲ / ▼ / ◀ and ▶ buttons to navigate to the 'Groups' label under the 'Channels' section in Menu.

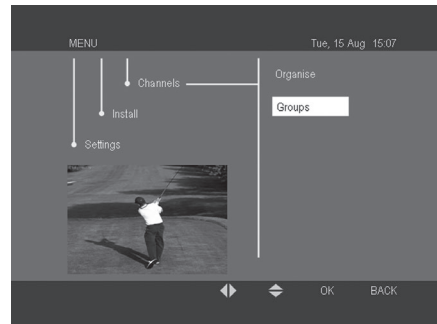

2. Press the **OK** button.
3. Press the press the ▲ / ▼ buttons to navigate to a channel of interest.

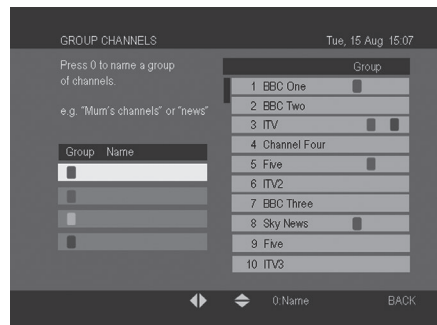

Operating the box

- Press a **COLOURED** button to add or remove that channel from the group of the same colour.
- You can give each group a name by pressing the **▲ / ▼ / ◀** and **▶** buttons to select the required group.



- Press the **0** button to add or rename a group. A keypad screen (similar to a mobile phone) is displayed.

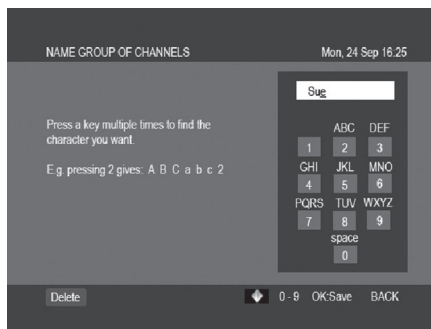

- Press the **◀** and **▶** buttons to move the cursor and the **NUMERIC** buttons, one or

- more times to enter a character.
- You can delete the character under the cursor by pressing the **RED** button.
- Press the **OK** button to accept the new group name and return to the previous menu. Alternatively, press the **BACK** button, if you want to exit to the previous menu without changing the group's name.

Install menu

The Install sub-menu allows you to tune or reset your box.

Channel tune

You can re-tune your box:

- Press the **MENU** button.
- Press the **▲ / ▼ / ◀** and **▶** buttons to select the 'Tune' label under the 'Install' section in the Menu.

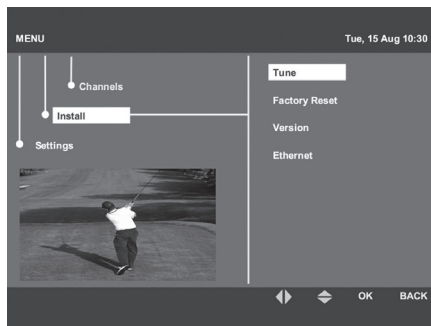

Operating the box

3. Press the **OK** button to begin.
4. You are asked to confirm whether you want to proceed. Press the **OK** or **BACK** button if you do not want to re-tune, otherwise press ► and then OK to confirm.
5. The box searches for and displays all the available TV and radio channels.
6. Once the automatic search has been completed, all channels are stored and the first available channel is shown.



Note: You should re-tune your box if you move home.



Note: You should re-tune your box periodically because new channels may become available.

Factory reset

You can restore the default settings for your box to the original factory values:

1. Press the **MENU** button.
2. Press the ▼ button to select the 'Install' option.
3. Press the ◀ and ▶ buttons to select the 'Factory Reset' option.
4. Press **OK** to begin.
5. You are asked to confirm that you want to proceed. Press the **OK** or **BACK** button if you do not want to re-tune, otherwise

press ► and then **OK** to confirm.

Once the "**OK**" button press, a password require dialog display, enter the correct password to perform the factory reset (default password is 0000).



CAUTION: RETURNING THE BOX TO ITS FACTORY DEFAULT CLEARS ALL SETTINGS.

THE PIN IS RESTORED TO THE DEFAULT '0000' VALUE

Note: To prevent accidental erasure, factory reset does not reset the Channel Zero settings in your box.



To perform a full reset that includes also the Channel Zero settings, press the following sequence of buttons: MENU, 2, 7, 1, 8, 2, 8, 4, 5, 9, 0.

The box will go into standby automatically

Version

The Version menu shows hardware and software information.

To see the version number:

1. Press the **MENU** button, then press the ▲ / ▼ / ◀ and ▶ buttons to navigate to

Operating the box

the 'Version' label under the 'Install' section in Menu.

2. The version number is displayed beneath the 'Version' label.



Ethernet

"Ethernet" allows you to set IP address manually or automatically.

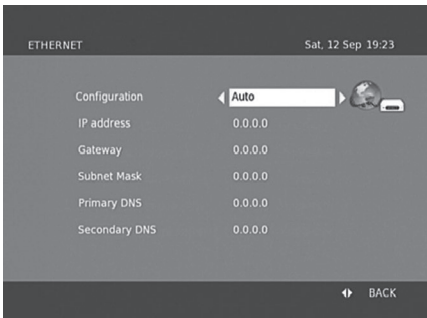

When selecting the AUTO function and an Ethernet cable is not connected then, the circle marked around the icon will be in red colour. And the default value of the ethernet settings will be 0 as shown in the snapshot.

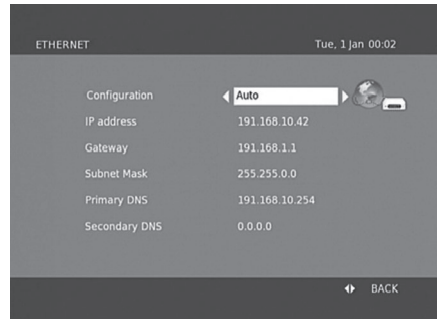

When selecting the AUTO function and an Ethernet cable is connected then, the circle marked around the icon will be in green colour. And the Ethernet settings will be configured automatically as shown in the figure below.

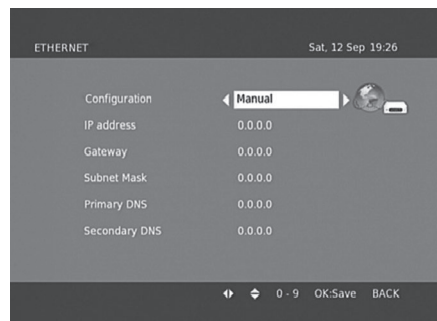

When the user select the MANUAL and an Ethernet cable is connected then, the circle marked around the icon will be in green colour due to successful link up. The ethernet settings need to be entered manually as in the snapshot.

Operating the box

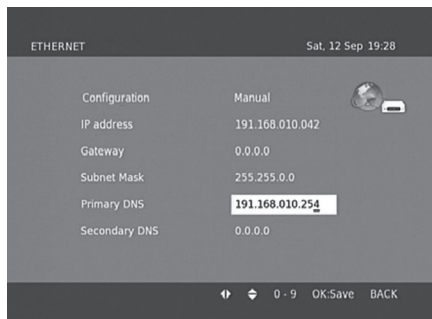

Once correct settings have been entered the settings need to be saved. Please select the **OK** key to save the new settings as shown in the snapshot.

Settings

You can customize the operation of your box according to your needs and the type of equipment that your box is connected to.

1. Press the **MENU** button, then press the ▲/▼ / ◀ and ▶ buttons to navigate to the relevant type of setting in the 'Settings' section in Menu.
2. Press the **OK** button.
3. Press the ◀ or ▶ buttons to obtain the correct setting value.
4. Press the **OK** button to save the settings and return to the previous menu.

Language

- **'Preferred audio'** allows you to set your first choice for audio.
- **'Alternative audio'** allows you to set your second choice for audio.
- **'Subtitles'** allows you to set the language in which subtitles are displayed (if subtitles are enabled, see Subtitles on page 16).
- **'MHEG Language'** allows you to set the language in which digital text is displayed (see digital text on page 19).
- **'Hearing impaired'** allows you to activate special subtitles for the hearing impaired (if they are available).

TV



- **'Brightness'** allows you to adjust the display brightness settings.
- **'Contrast'** allows you to adjust the display contrast settings.

Operating the box

- **'Aspect ratio'** allows you to choose from 4:3, 4:3 pan scan, 4:3 letter box and 16:9.
- **'Resolution'** allows you to choose the HDMI video output format.
- **'Video output'** allows you to choose the output signal type according to what your TV can display.
- **'Antenna power'** allows you to turn the aerial power on or off.
- **'Auto standby'** allows you to set the period after which the box will go into standby to reduce power consumption.

Time

- **'Time mode'** allows you to control whether the time and date are set manually or automatically.



Note: It is strongly recommended that you leave 'Time mode' in 'Auto'.

- **'Date'** allows you to set the date when in manual time mode.
- **'Time'** allows you to set the time of day when in manual time mode.
- **'Local time'** allows you to set the time zone when in manual time mode.

Audio Description

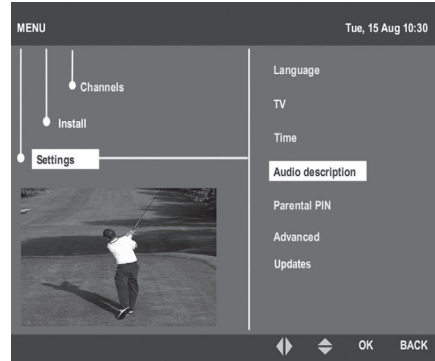

Audio Description allows you to adjust audio description language, audio type, volume.

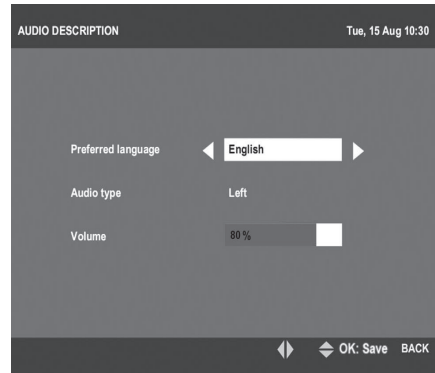

'Preferred language' allows you to set audio description preferred language.

'Audio type' Allow you select the audio mode as stereo/left/right for audio description.

'Volume' Allow to set the volume level of Audio Description from 0 to 100%. The default value is 80%.

Operating the box

Parental PIN

The Parental pin menu allows you to set a pin in order to protect locked channels. To set a password and apply a parental rating.

1. Press the MENU button, then press the ▲ / ▼ / ◀ and ▶ buttons to navigate to the 'Parental PIN' label under the 'Settings' section in Menu.

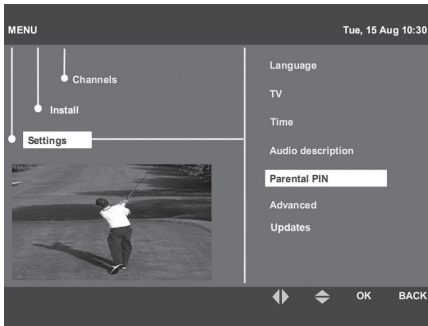

2. Press **OK**.
3. Press the **NUMERIC** buttons to enter the old password. If you have not changed the password before, the default is '0000'.

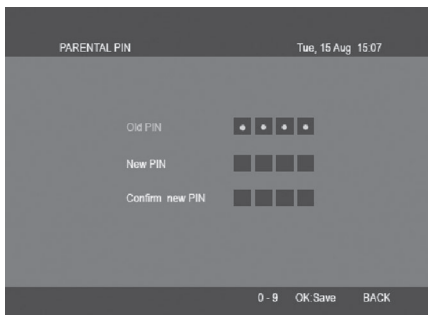

4. Press the **NUMERIC** buttons to enter the new password.
5. Confirm your new password by re-entering again using the **NUMERIC** buttons.

Advanced

The advanced menu allows you to adjust the HDCP switch, digital audio output mode, SPDIF Synch delay.

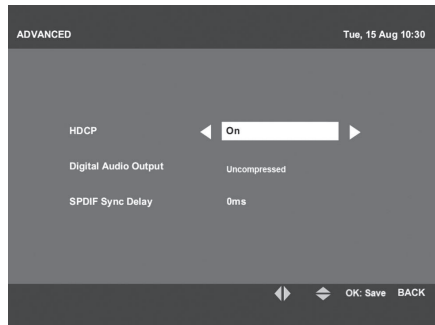

'**HDCP**' HDCP means High Bandwidth Digital Content Protection. It's one of the digital content protection mechanisms. HDCP On means the HDMI output is only visible to HDCP supported TV's. HDCP off means the HDMI output can be seen in any TV's.

Operating the box

'Digital Audio Output' This option is used to select compressed/uncompressed mode for Digital Audio output.

Digital Audio output mode compressed means compressed data is routed through the Digital Audio output.

Digital Audio output mode uncompressed means PCM data is routed through the Digital Audio output

'SPDIF SYNC delay' SPDIF SYNC delay is the user preferred delay in the SPDIF audio output to sync between the video and the SPDIF output audio.

Updates

The Settings menu includes an Updates sub-menu. This controls how the box handles automatic software updates which are received via the aerial. These updates are only downloaded when the box is in the normal standby mode.

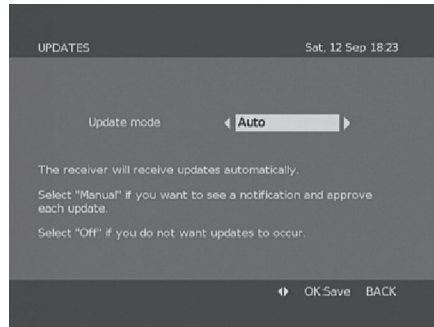
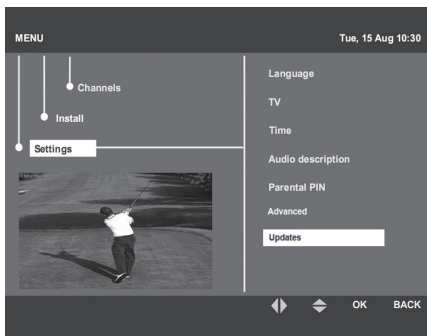

Auto: The box will automatically download and install any updates received.

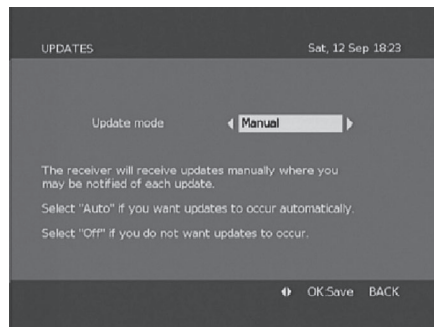

Manual: When you turn the box on for the next time, an update notice will be shown on screen. You can then choose to install the update by pressing the **OK** button.

Press **▶** and then the **OK** button to cancel the update. The update will also be cancelled if no keys are pressed within 5 minutes.

Operating the box

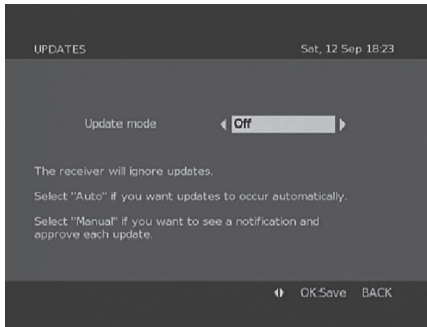

Off: The Receiver will ignore the updates.

Channel Zero

Channel Zero is an interactive system that allows your box to receive enhanced services such as news, weather, TV magazines and games without changing channels.

Channel Zero downloads and stores the latest services when your box is in standby.

There are no services in the box when it is unpacked for the first time.

Press  to put your box in standby (which reduces power consumption) overnight or when you are not using it. The light on the front of the box will change to red.

The box will load the Channel Zero services ready for you to use within a few hours

The light on the front of your box changes from red to amber when Channel Zero is ready.

If you accidentally disconnect the box from the mains, just plug it back in and leave it in standby and it will reload automatically.

Channel Zero is broadcast periodically to keep your box completely up to date.

Accessing Channel Zero services

Press either the Channel Zero button or the **0** button on your handset to access the Channel Zero services. See Remote control on page 10.

Troubleshooting guide

TROUBLESHOOTING

No picture, no sound	<p>Check that the box is correctly plugged in</p> <p>Check the television is connected to a suitable power source</p> <p>Check the electrical supply is turned on</p>
No picture	<p>Ensure that the box and TV are powered on</p> <p>Check that the cables are fitted securely</p> <p>Ensure the aerial is connected</p> <p>Press the TV / RADIO button to change the channel type</p>
No sound	<p>Press the MUTE button and check if Mute mode is set</p> <p>Switch to another channel and see if the same problem occurs</p> <p>Press V+ button to see if the problem can be solved</p>
No picture on some channels	<p>Re-tune your box</p> <p>Check that your aerial is correctly installed</p> <p>Ensure the selected channel is broadcasting</p>
Cannot receive Channel Zero services	<p>Leave your box in standby when it is not in use: see Standby on page 14</p> <p>The light changes from red to amber when Channel Zero is ready</p> <p>You may not be able to receive a signal in your area – see www.ch-zero.tv for more details</p>
No colour on some channels (black and white)	<p>Check if the same problem exists on other channels</p> <p>Ensure the correct picture settings are selected</p>
Spots on some or all channels	<p>Check that the aerial is correctly connected</p> <p>Check that the aerial is in good condition</p>
Controls not working	<p>Disconnect the box from the power supply, wait 10 seconds, reconnect the box to the power supply</p>
No response to remote control	<p>The remote control is not aimed correctly at the box</p> <p>The front panel of the box is obstructed</p> <p>The remote control batteries are inserted incorrectly</p> <p>The remote control batteries are exhausted</p>

Additional Information

Specifications

Specifications of the box that you have just purchased may vary from the information in this table due to technical innovations.

Power requirements AC 110-240V~, 50/60Hz

Power consumption On: 9W

Temperature Working: 0° C~40° C
Storage: -30° C~80° C

Humidity Working: 20%~80%
Storage: 5%~90%

Warranty

Your TESCO appliance is covered by a warranty for 12 months from the date of purchase. If a fault develops during this period, please contact the TESCO electrical help line on 0845 456 6767. Please have your original purchase receipt with you when you call. This warranty in no way affects your consumer rights.



UK: Waste electrical products/batteries should not be disposed of with household waste. Separate disposal facilities exist, for your nearest facilities. See www.recycle-more.co.uk or in-store for details.

ROI: Produced after 13th August 2005. Waste electrical products/ batteries should not be disposed of with household waste. Please recycle where facilities exist. Check with your Local Authority or retailer for recycling advice.

Technika

Tesco Stores Ltd,
Delamare Road, Cheshunt, Herts, EN8 9SL

Technika Helpline: 0845 456 6767 (Calls cost up to 4p per
minute from a BT landline, other providers may vary)