

AV Control Receiver

Operating Instructions

Model No. **SA-DX1050**
SA-DX950



SA-DX1050

Technics®



Note:

"EB" on the packaging indicates the United Kingdom.

Before connecting, operating or adjusting this product,
please read these instructions completely.
Please keep this manual for future reference.

E EB GN

RQT5802-B

Dear customer

Thank you for purchasing this product.
For optimum performance and safety, please read these instructions carefully.

These operating instructions are applicable to models SA-DX1050 and SA-DX950, however, are intended primarily for model SA-DX1050.

Model SA-DX1050 is only for Europe.

Table of contents

Before use	
Supplied accessories.....	3
Safety precautions.....	3
Caution for AC Mains Lead.....	4
Control reference guide.....	5
Connections	
Connections.....	6
Connecting video equipment.....	6
Connecting audio equipment.....	7
Connecting digital equipment.....	7
Antenna connections.....	8
Connecting the AC mains lead and other information.....	9
Speaker connections.....	10
Placement of speakers.....	10
Connecting speakers.....	10
Preparations	
Customizing your receiver.....	12
Basic steps.....	13
Adjusting speaker output level.....	15
Operations	
DSP sound modes.....	16
STEREO mode.....	16
SURROUND mode.....	16
SFC modes.....	17
Enjoying the sounds.....	18
Adjusting the tone and balance.....	20
Using the VCR 2 terminals.....	20
Using headphones.....	20
Muting the volume.....	21
Adjusting the subwoofer level.....	21
Using the TAPE MONITOR.....	21
Radio functions	
The radio.....	22
Manual tuning.....	22
Preset tuning.....	23
RDS broadcasts Only for Europe	24
To display RDS information.....	24
PTY search.....	24
EON tuning.....	25
PTY displays.....	25
Reference	
Making a recording.....	26
Timer function.....	27
The HELP function.....	28
Maintenance.....	28
Troubleshooting guide.....	29
Specifications.....	30

Enjoying surround sound

Pages

Connect your equipment

6–9

Position and connect the speakers

10–11

Change the settings

12–13

Adjust speaker output level

15

Sit back and enjoy the experience

18

CAUTION

Do not place anything on top of this unit or block the heat radiation vents in any way. In particular, do not place tape decks or CD/DVD players on this unit as heat radiated from it can damage your software.

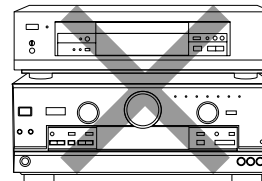

NO

Supplied accessories

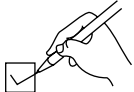

Please check and identify the supplied accessories.

AC mains lead.....1

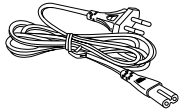

For Continental Europe
(RJA0019-2K)

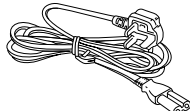

For the United Kingdom
(VJA0733)

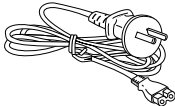

For Australia and New Zealand
(RJA0035-X)

AM loop antenna set (RSA0012)1
(AM loop antenna, antenna holder, screw)

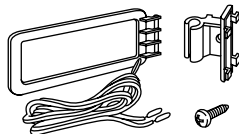

FM indoor antenna (RSA0007-L).....1

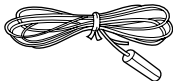

Antenna plug (SJP9009)1
(Only for the United Kingdom)



Antenna plug (RFE0014).....1
(Only for Australia and New Zealand)

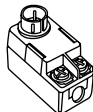

Batteries2

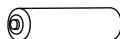

Remote control1

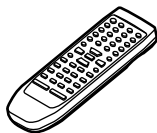

SA-DX1050
(EUR7702KC0)

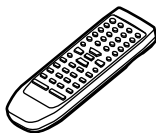

SA-DX950 for Europe
(EUR7702030)

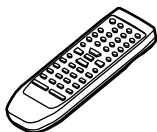

SA-DX950 for Australia and New Zealand
(EUR7702040)

Refer to the separate booklet, "Remote Control", for remote control operation details.

Use the numbers indicated in parentheses when asking for replacement parts.

Safety precautions

Placement

Set the unit up on an even surface away from direct sunlight, high temperatures, high humidity, and excessive vibration. These conditions can damage the cabinet and other components, thereby shortening the unit's service life.

Do not place heavy items on the unit.

Voltage

Do not use high voltage power sources. This can overload the unit and cause a fire.

Do not use a DC power source. Check the source carefully when setting the unit up on a ship or other place where DC is used.

AC mains lead protection

Ensure the AC mains lead is connected correctly and not damaged. Poor connection and lead damage can cause fire or electric shock. Do not pull, bend, or place heavy items on the lead.

Grasp the plug firmly when unplugging the lead. Pulling the AC mains lead can cause electric shock.

Do not handle the plug with wet hands. This can cause electric shock.

Foreign matter

Do not let metal objects fall inside the unit. This can cause electric shock or malfunction.

Do not let liquids get into the unit. This can cause electric shock or malfunction. If this occurs, immediately disconnect the unit from the power supply and contact your dealer.

Do not spray insecticides onto or into the unit. They contain flammable gases which can ignite if sprayed into the unit.

Service

Do not attempt to repair this unit by yourself. If sound is interrupted, indicators fail to light, smoke appears, or any other problem that is not covered in these operating instructions occurs, disconnect the AC mains lead and contact your dealer or an authorized service center. Electric shock or damage to the unit can occur if the unit is repaired, disassembled or reconstructed by unqualified persons.

Extend operating life by disconnecting the unit from the power source if it is not to be used for a long time.

Caution for AC Mains Lead

(For United Kingdom)

("EB" area code model only)

For your safety, please read the following text carefully.

This appliance is supplied with a moulded three pin mains plug for your safety and convenience.

A 5-ampere fuse is fitted in this plug.

Should the fuse need to be replaced please ensure that the replacement fuse has a rating of 5-ampere and that it is approved by ASTA or BSI to BS 1362.

Check for the ASTA mark  or the BSI mark  on the body of the fuse.

If the plug contains a removable fuse cover you must ensure that it is refitted when the fuse is replaced.

If you lose the fuse cover the plug must not be used until a replacement cover is obtained.

A replacement fuse cover can be purchased from your local dealer.

CAUTION!

IF THE FITTED MOULDED PLUG IS UNSUITABLE FOR THE SOCKET OUTLET IN YOUR HOME THEN THE FUSE SHOULD BE REMOVED AND THE PLUG CUT OFF AND DISPOSED OF SAFELY.

THERE IS A DANGER OF SEVERE ELECTRICAL SHOCK IF THE CUT OFF PLUG IS INSERTED INTO ANY 13-AMPERE SOCKET.

If a new plug is to be fitted please observe the wiring code as stated below.

If in any doubt please consult a qualified electrician.

IMPORTANT

The wires in this mains lead are coloured in accordance with the following code:

Blue: Neutral, Brown: Live.

As these colours may not correspond with the coloured markings identifying the terminals in your plug, proceed as follows:

The wire which is coloured Blue must be connected to the terminal which is marked with the letter N or coloured Black or Blue.

The wire which is coloured Brown must be connected to the terminal which is marked with the letter L or coloured Brown or Red.

WARNING: DO NOT CONNECT EITHER WIRE TO THE EARTH TERMINAL WHICH IS MARKED WITH THE LETTER E, BY THE EARTH SYMBOL  OR COLOURED GREEN OR GREEN/YELLOW.

THIS PLUG IS NOT WATERPROOF—KEEP DRY.

Before use

Remove the connector cover.

How to replace the fuse

The location of the fuse differ according to the type of AC mains plug (figures A and B). Confirm the AC mains plug fitted and follow the instructions below. Illustrations may differ from actual AC mains plug.

1. Open the fuse cover with a screwdriver.

Figure A

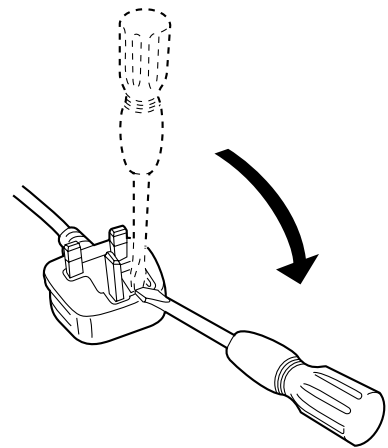
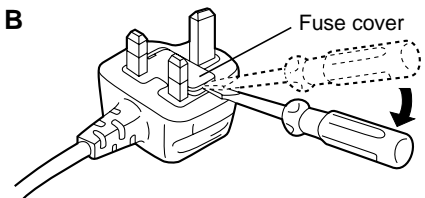

Figure B



2. Replace the fuse and close or attach the fuse cover.

Figure A

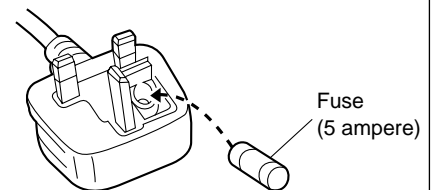
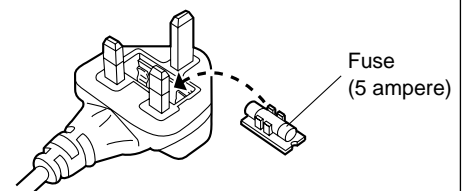
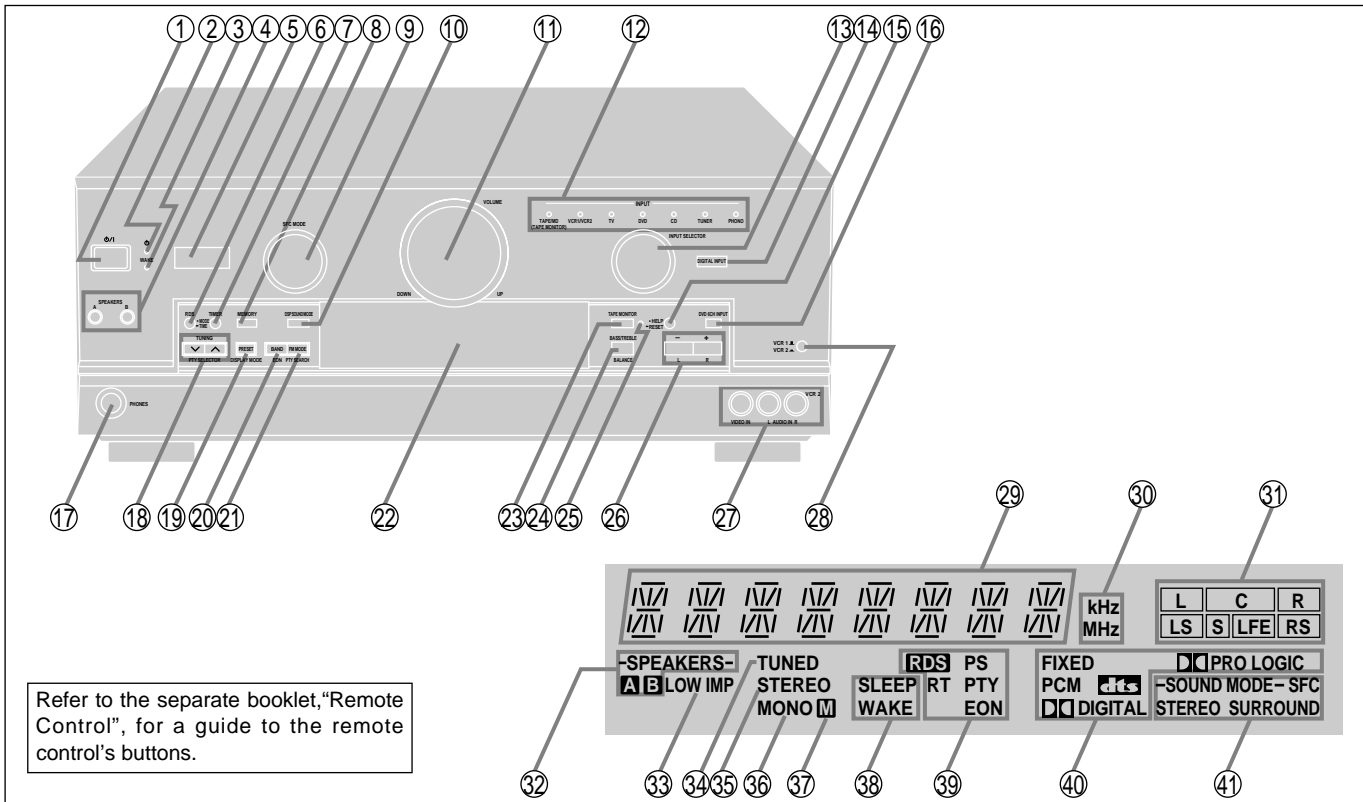

Figure B





Reference pages are given in parentheses.

Main unit

- ① **Standby/on switch** [⏻/⏻].....(13)
Press to switch the unit from on to standby mode or vice versa.
In standby mode, the unit is still consuming a small amount of power.
- ② **Standby indicator** [⏻]
When the unit is connected to the AC mains supply, this indicator lights up in standby mode and goes out when the unit is turned on.
- ③ **Wake indicator** [WAKE](27)
- ④ **Speaker select buttons** [SPEAKERS, A, B].....(13, 18)
- ⑤ **SA-DX1050 only**
MOS-FET light [MOS-FET](12)
- ⑥ **Only for Europe**
RDS button [RDS].....(24)
For Australia and New Zealand
- Timer button** [TIMER, -MODE, -TIME](27)
- ⑦ **For Europe**
Timer button [TIMER, -MODE, -TIME](27)
- ⑧ **Memory button** [MEMORY].....(23)
- ⑨ **SFC mode selector** [SFC MODE](18)
- ⑩ **DSP sound mode select button**
[DSP SOUND MODE].....(18)
- ⑪ **Volume control** [VOLUME](18)
- ⑫ **SA-DX1050 only**
Input indicators [INPUT](18)
- ⑬ **Input selector** [INPUT SELECTOR](13, 18)
- ⑭ **Digital input select button/indicator** [DIGITAL INPUT].....(18)
- ⑮ **Help/reset button** [-HELP, -RESET].....(28)
- ⑯ **DVD 6ch input select button/indicator** [DVD 6CH INPUT](19)
- ⑰ **Headphone jack** [PHONES](20)
- ⑱ **For Europe**
Tuning/PTY select buttons
[TUNING, PTY SELECTOR, ∇, ∆].....(22, 24)
For Australia and New Zealand
Tuning buttons [TUNING ∇, ∆].....(22)
- ⑲ **For Europe**
Preset channel/display mode button
[PRESET, DISPLAY MODE](23, 24)
For Australia and New Zealand
Preset channel buttons [PRESET].....(23)

- ⑲ **For Europe**
Band select/EON button [BAND, EON].....(22, 25)
For Australia and New Zealand
Band select buttons [BAND](22)
- ⑲ **For Europe**
FM mode select/PTY search button
[FM MODE, PTY SEARCH].....(22, 24)
For Australia and New Zealand
FM mode select button [FM MODE].....(22)
- ⑲ **Display section**
- ⑲ **Tape monitor button** [TAPE MONITOR].....(21)
- ⑲ **Tone and balance select button**
[BASS/TREBLE, BALANCE](20)
- ⑲ **SA-DX950 only**
Tape monitor indicator(21)
- ⑲ **Tone and balance adjust buttons** [-, +, L, R](20)
- ⑲ **SA-DX1050 only**
VCR 2 terminals [VCR 2].....(6)
- ⑲ **SA-DX1050 only**
VCR 1/VCR 2 select button [VCR 1 ▸, VCR 2 ▸](20)

Display section

- ⑲ **Display**
- ⑲ **Frequency unit indicators** [kHz, MHz](22)
- ⑲ **Program format indicators** [L, C, R, LS, S, LFE, RS].....(18)
- ⑲ **Front speaker indicators** [-SPEAKERS-, A, B].....(18)
- ⑲ **Low impedance indicator** [LOW IMP](14)
- ⑲ **Tuned indicator** [TUNED].....(22)
- ⑲ **Stereo indicator** [STEREO].....(22)
- ⑲ **Monaural indicator** [MONO].....(22)
- ⑲ **Memory indicator** [M](23)
- ⑲ **Timer indicators** [SLEEP, WAKE](27)
- ⑲ **Only for Europe**
RDS indicators [RDS, PS, RT, PTY, EON](24)
- ⑲ **Signal format indicators**
[FIXED, PCM, ,](16, 18)
- ⑲ **DSP sound mode indicators**
[-SOUND MODE-, SFC, STEREO, SURROUND].....(18)

Connections

Stereo phono cable

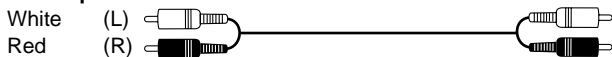

Video connection cable



To connect equipment, refer to the appropriate operating instructions.

Peripheral equipment and cables sold separately unless otherwise indicated.

Note

- Turn off all components before making any connections.
- Use digital connection to enjoy Dolby Digital or DTS (➔ page 18).
- Use analogue connection to enjoy sources that cannot be decoded on this unit and to record a source (➔ pages 16, 19 and 26).

Connecting video equipment

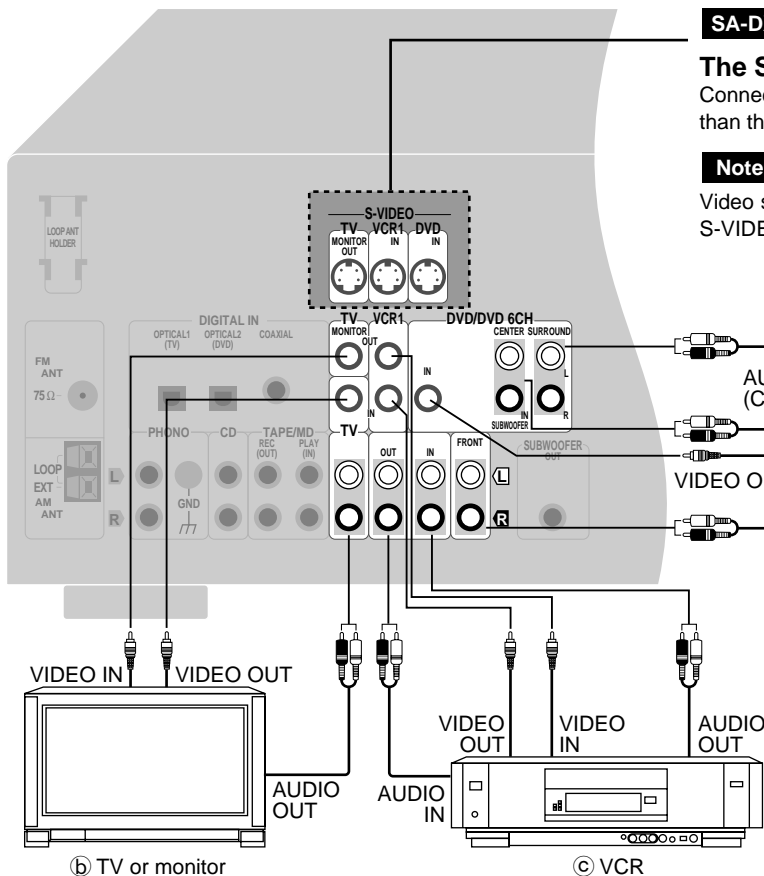

SA-DX1050 only

The S-VIDEO terminals

Connections through these terminals provide higher quality pictures than through the video terminal.

Note

Video signals input into the VIDEO terminals cannot be output from S-VIDEO terminals or vice versa.

Note

Connect to FRONT L, R if your DVD player does not have 6 channel output.

Connection with 21 pin scart cable

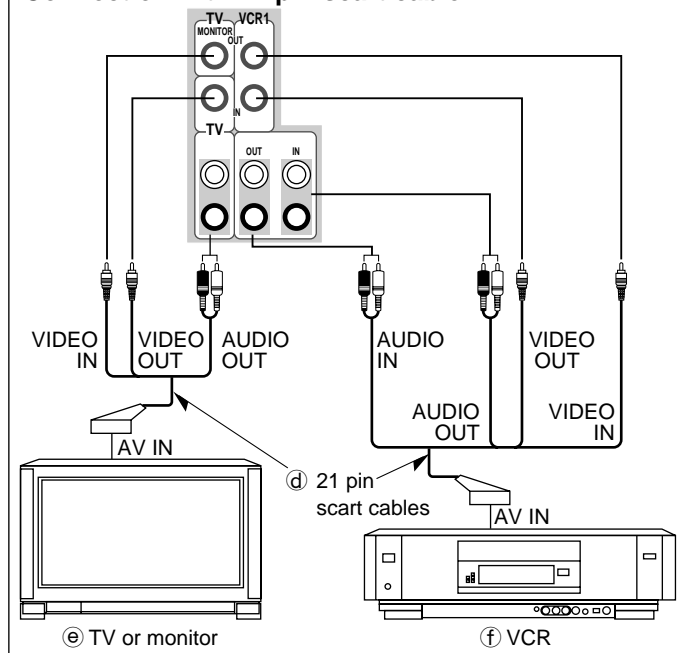

SA-DX1050 only

Connecting to the VCR 2 terminals on the front panel

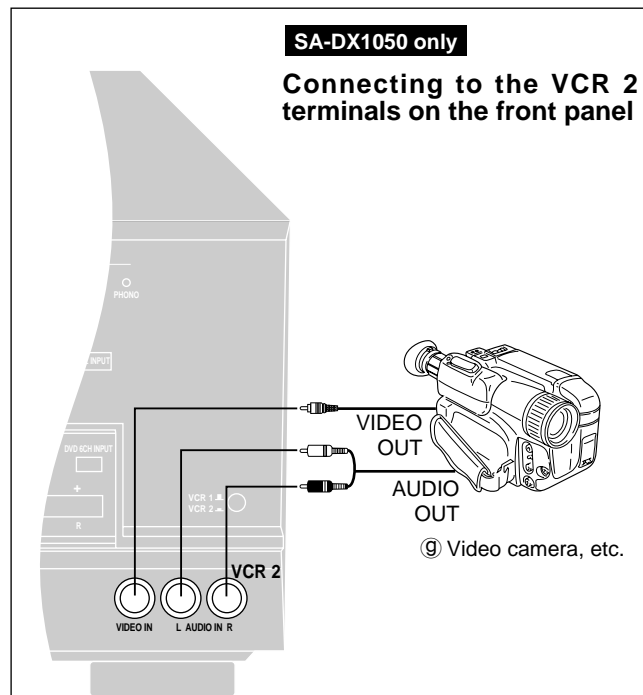

Optical fiber cable

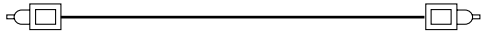

Coaxial cable

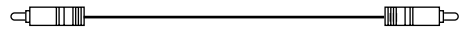

Connecting audio equipment

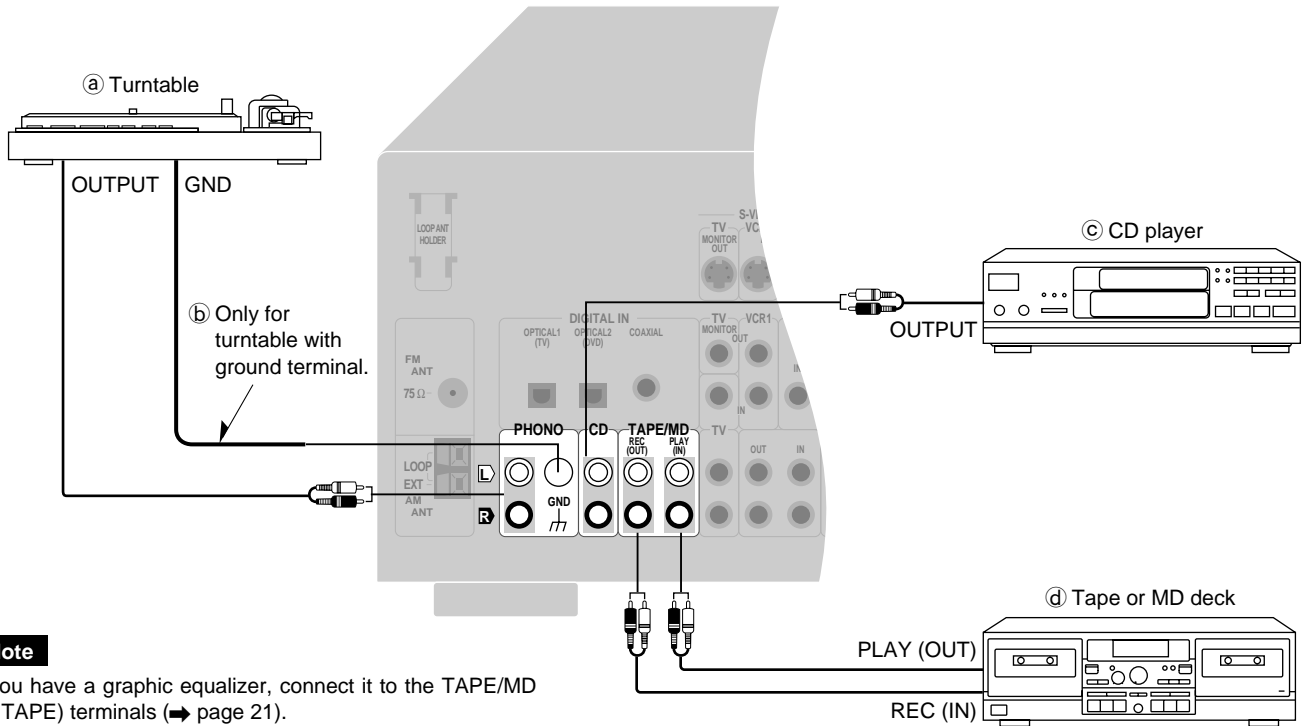

Note

If you have a graphic equalizer, connect it to the TAPE/MD (or TAPE) terminals (➔ page 21).

Connecting digital equipment

⑤ Satellite receiver, etc.

Optical fiber cable connection

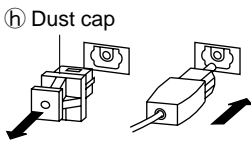

- Do not bend the optical fiber cable.
- If the digital optical connector is not going to be used, be sure to attach the dust cap to prevent exposure to dust.

Note

This unit cannot decode Dolby Digital RF (radio frequency) signals from a laser disc player.

Changing the digital input settings

You can change the input settings for the digital terminals if necessary (for example, if your CD player doesn't have a coaxial output terminal). Note the equipment you have connected to the terminals, then change the settings (➔ pages 12–13).

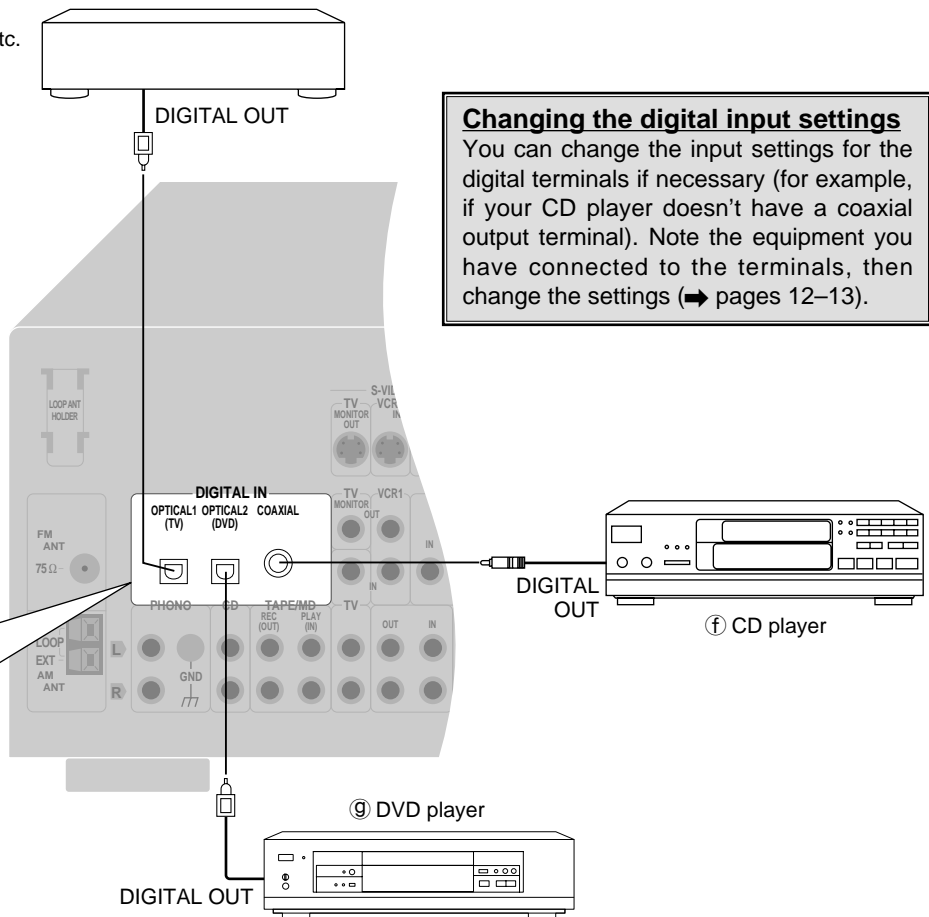

Antenna connections

FM antenna

Fix the other end of the antenna where reception is best.

Ⓐ FM indoor antenna (included)

Ⓑ Adhesive tape

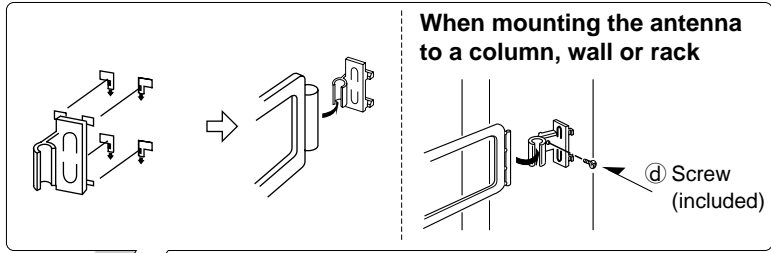

Ⓒ AM loop antenna (included)

AM loop antenna

- Fit the AM loop antenna holder (included) onto the rear panel of this unit and then attach the AM loop antenna to it (facing in the direction of best reception).
- Keep the antenna cord away from tape decks, DVD players, and other cords.

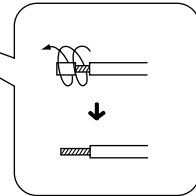
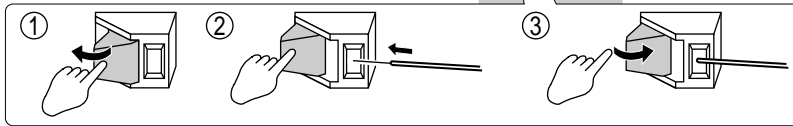

To connect an outdoor antenna

Ⓔ Vinyl-covered wire
5–12 m

AM outdoor antenna

- Run a piece of vinyl wire horizontally across a window or other convenient location.
- Leave the loop antenna connected.
- Disconnect the antenna when the unit is not in use. Do not use the antenna during an electrical storm.

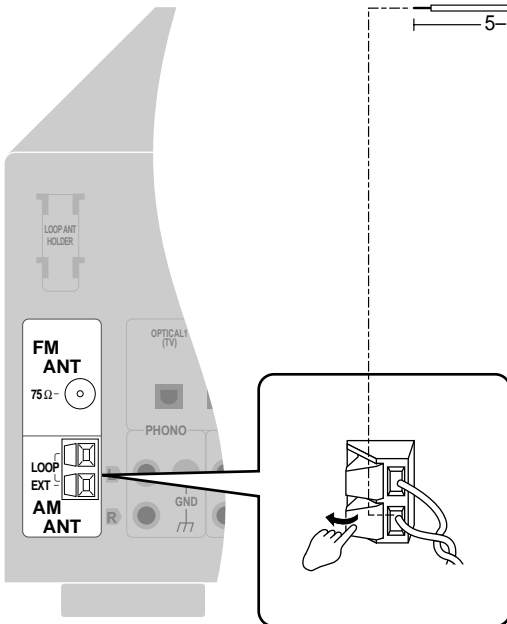

FM outdoor antenna

- Disconnect the FM indoor antenna.
- The antenna should be installed by a competent technician.

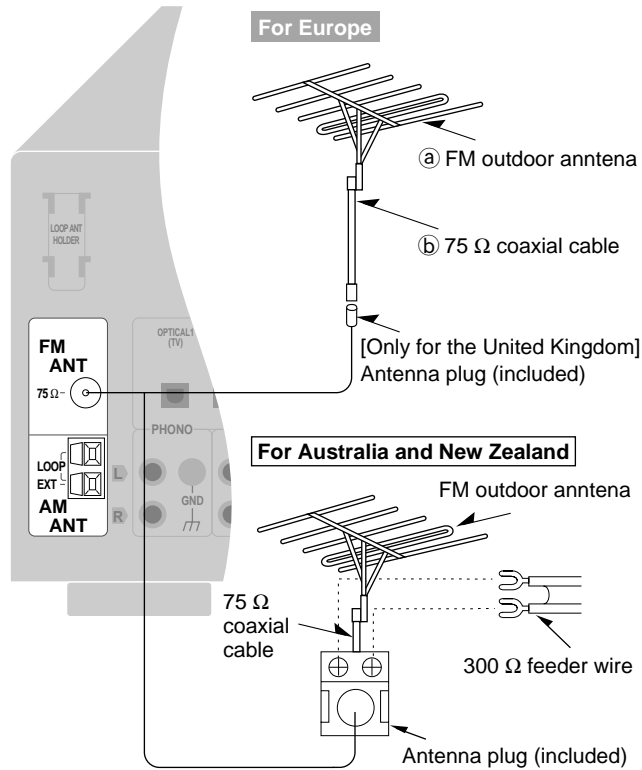

How to use the antenna plug (included)

Only for Australia and New Zealand

Two types of wire are most commonly used for connection from the antenna: 300 Ω parallel feeder wire or 75 Ω coaxial cable. For best resistance to outside interference, the use of 75 Ω coaxial cable is suggested.

● To connect a 75 Ω coaxial cable

- ① Remove a piece of the outer vinyl insulator.

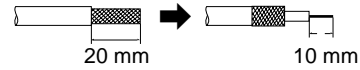

- ② Carefully pull the tabs apart to remove the cover.

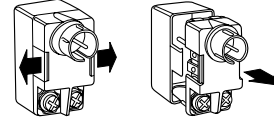

- ③ Remove the lead wire and clamp it with the plastic bar.

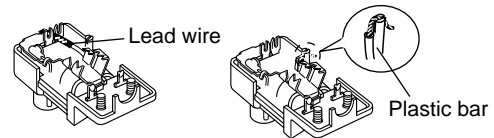

- ④ Install the coaxial cable.

Clamp the cable conductor, and wind it on so that it doesn't contact anything else.

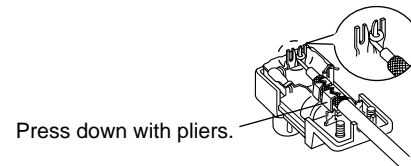

- ⑤ Attach the cover.

● To connect a 300 Ω feeder wire

Loosen the screws, connect the wires, and tighten the screws to secure the connection.

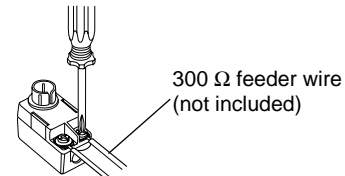

Connecting the AC mains lead and other information

(FOR THE UNITED KINGDOM ONLY)
READ THE CAUTION FOR THE AC MAINS LEAD ON PAGE 4 BEFORE CONNECTION.

© Cooling fan

The cooling fan operates at high power output levels only.

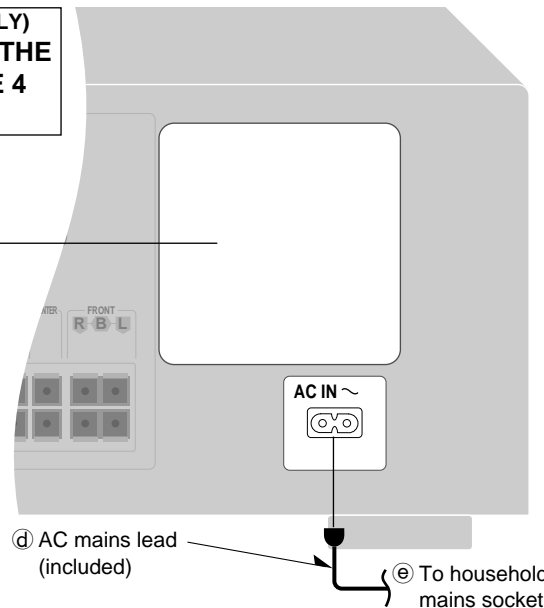

AC mains lead

Connect this lead only after all other cables and cords are connected.

Note

The included AC mains lead is for use with this unit only. Do not use it with other equipment.

Insertion of Connector

Even when the connector is perfectly inserted, depending on the type of inlet used, the front part of the connector may jut out as shown in the drawing.

However there is no problem using the unit.

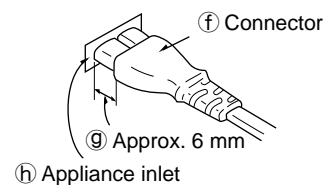

Speaker connections

Placement of speakers

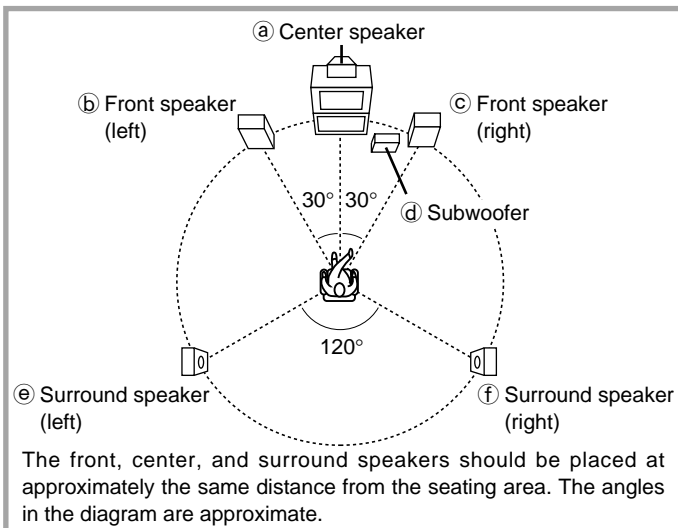

Front speakers

Place on the left and right of the TV at seated ear height so that there is good coherency between the picture and sound.

Center speaker

Place underneath or above the center of the TV. Aim the speaker at the seating area.

Surround speakers

Place on the side of or slightly behind the seating area, about one meter higher than ear level.

Subwoofer

The subwoofer can be placed in any position as long as it is at a reasonable distance from the TV.

Note that some experimentation can yield the smoothest low frequency performance. Placement near a corner can increase the apparent output level, but can result in unnatural bass.

Connecting speakers

Other connections are possible depending on your speaker system. See your speaker system's operating instructions for details.

Front speakers

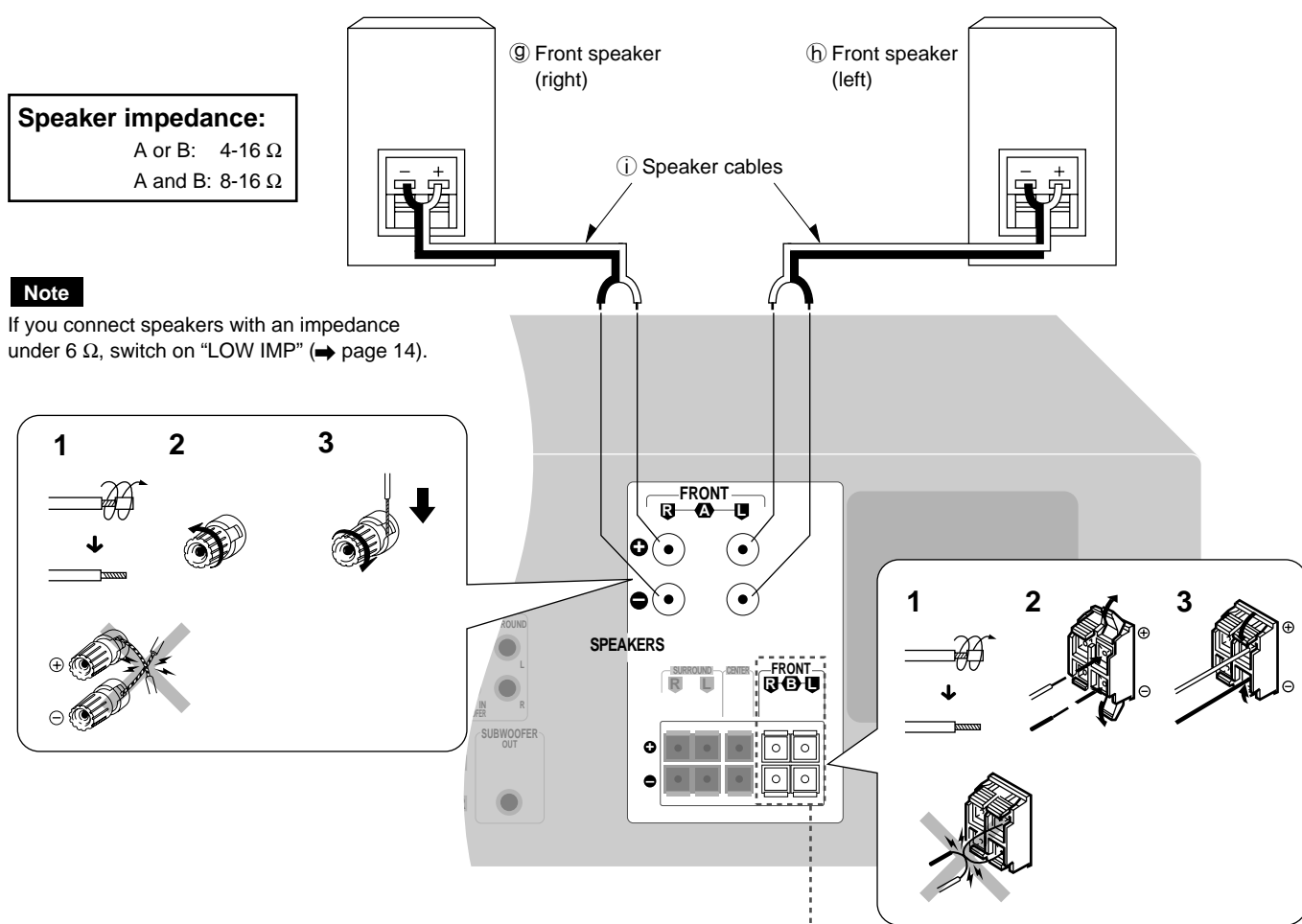

"B" terminals

For connection to a second pair of speakers.

Note

Use the A terminals to enjoy SURROUND, SFC and DVD 6CH INPUT.

Center speaker

Speaker impedance: 6-16 Ω

Ⓐ Center speaker

Ⓑ Speaker cable

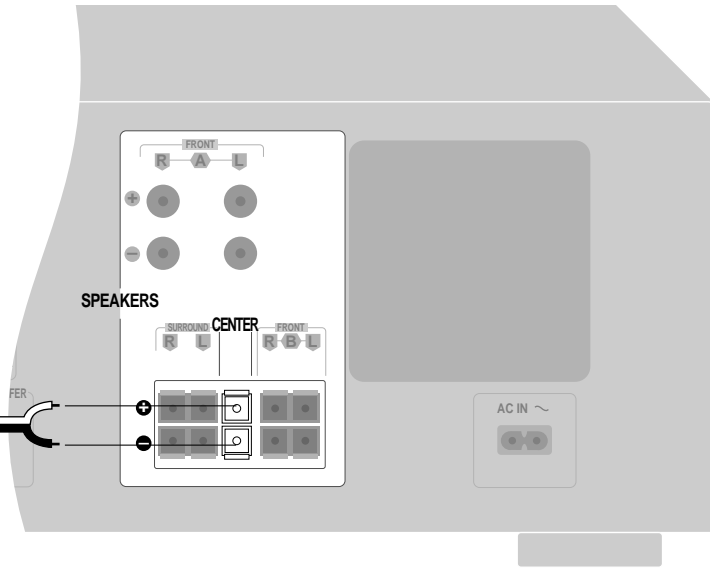

Surround speakers

Speaker impedance: 6-16 Ω

Ⓒ Surround speaker (right)

Ⓔ Surround speaker (left)

Ⓓ Speaker cable

Ⓕ Speaker cable

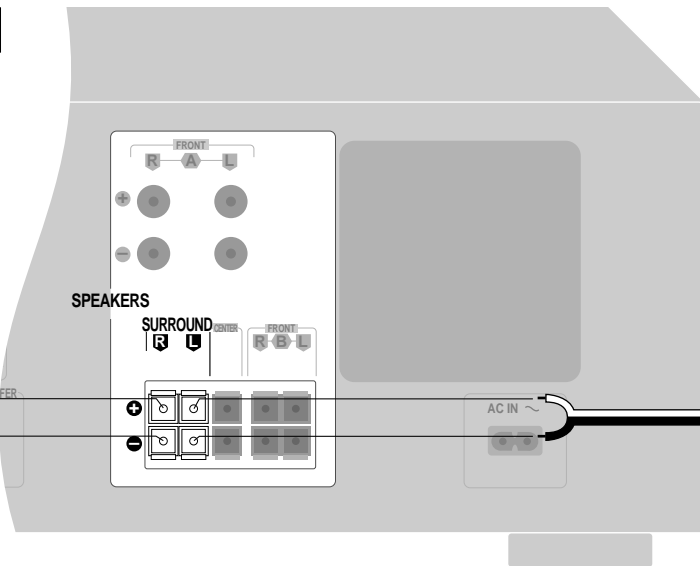

Subwoofer

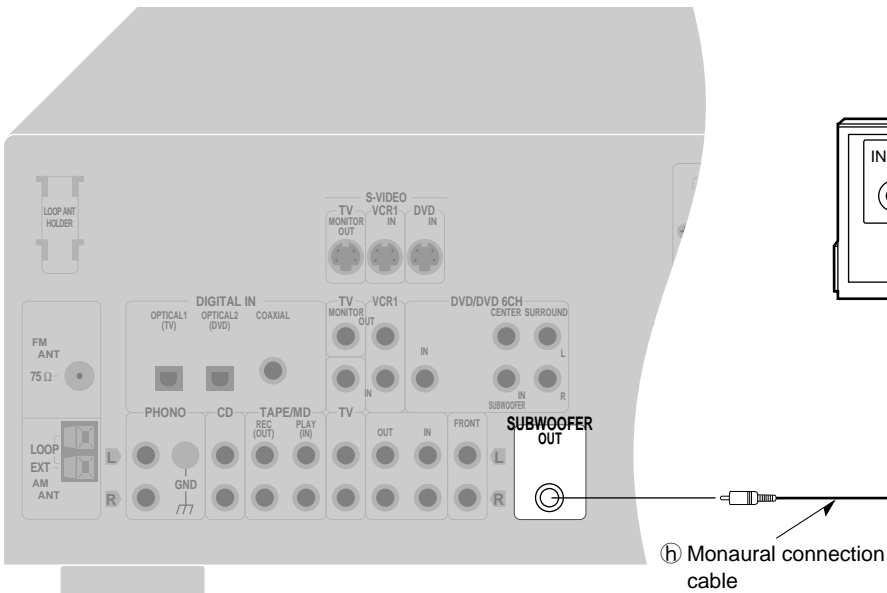

Ⓖ Active subwoofer

Ⓗ Monaural connection cable

Note

This receiver does not have an amplifier for the subwoofer.

To connect a passive subwoofer

- Connect another amplifier and connect the subwoofer to it.

Or

- Connect a passive subwoofer that has front speaker terminals (See the operating instructions of the speaker system for details.)

Customizing your receiver

SIZE

FRONT

FRONT → CENTER
↑ ↓
SUB-WFR ← SURROUND

LARGE

FRONT SMALL ↔ LARGE
CENTER, SURROUND
NONE ↔ SMALL ↔ LARGE
SUB-WFR NO ↔ YES

DISTANCE

FRONT

FRONT → CENTER
↑ ↓
SURROUND

3.0 m

1.0 m 10.0 m

FILTER

100

100 ↔ 150 ↔ 200

DR COMP

OFF

OFF ↔ STANDARD ↔ MAX

D-INPUT

CD COAX

CD → DVD
↑ ↓
TV

COAX

COAX ↔ OPT1 ↔ OPT2

DIMMER

OFF

OFF ↔ ON

Change the settings to suit your speakers and equipment and to suit the environment in which the unit is to be used. Before making any changes, read the following descriptions, note the factory settings and ranges, and refer to the instructions for the speakers and equipment.

The settings remain intact until they are changed, even after the power is turned off.

Setting descriptions

SIZE

Change to suit the speakers you have connected.

LARGE: For speakers that can reproduce a full sound range, particularly the bass range below 100 Hz.

SMALL: For speakers that cannot adequately reproduce the bass range. This setting is sufficient for most speakers if you are using a subwoofer.

NONE: For speakers you haven't connected (center or surround).

The factory settings are: Front: LARGE

Center and surround: SMALL

For the subwoofer, select YES if you have connected one (factory setting), or NO if you have not.

DISTANCE

Enter the distance of the speakers from the seating position so that the sound from all the speakers (except for the subwoofer) reaches you at the same time.

You can select distances between 1.0 and 10.0 m at 0.1 m intervals.

The factory settings are: Front and center: 3.0 m

Surround: 1.5 m

FILTER

This setting allows you to change the cut-off for bass output from the front speakers. If you set the front speakers to "SMALL", the filter is set to 100 Hz. Raise the cut-off if the bass from the front speakers is unsatisfactory so that this bass is output through the subwoofer.

You can raise the cut-off from 100 Hz to either 150 Hz or 200 Hz.

DR COMP - Dynamic range compression

Change this setting to view software at low volume (such as late at night) and maintain audio clarity. This setting works with Dolby Digital software. It reduces the peak level in loud scenes without affecting the sound field.

OFF: The software is played with the original dynamic range (factory setting).

STANDARD: The level recommended by the producer of the software for household viewing.

MAX: The maximum allowable compression (recommended for night viewing).

D-INPUT - Digital input

Change these settings to suit the connections you have made to the three digital input terminals, COAX, OPT1, and OPT2 (➔ page 7), so that the correct source is selected when you turn [INPUT SELECTOR] (➔ page 18).

The factory settings are: CD: COAX

DVD: OPT2

TV: OPT1

DIMMER

This setting allows you to dim the unit's display (and turn off the MOS-FET light on SA-DX1050) for better viewing in a darkened room.

The factory setting is OFF (normal brightness).

Basic steps

If you allow about 10 seconds to elapse between settings, the procedure is canceled, all settings are returned to how they were, and the previous display is restored. Begin again if this occurs.

- 1 Press [⏻/|].
- 2 Press [A] and [B] at the same time.
- 3 Press [A] to select the item you want to change.

Each time you press the button:

SIZE → DISTANCE → FILTER → DR COMP → D-INPUT → DIMMER

- 4 Change the settings (⇒ below).

Repeat steps 3 and 4 to complete the necessary settings.

- 5 Press [A] and [B] at the same time.

Changing the settings

SIZE

- ① Press [B] to select the speaker you want to set.

Each time you press the button:

FRONT → CENTER → SURROUND → SUB-WFR (Subwoofer)

- ② Turn [INPUT SELECTOR] to change the setting.

When you turn the selector:

FRONT: SMALL ↔ LARGE

CENTER and SURROUND: NONE ↔ SMALL ↔ LARGE

SUB-WFR: NO ↔ YES

- ③ Repeat ① and ② to change other SIZE settings.

DISTANCE

- ① Press [B] to select the speaker you want to set.

Each time you press the button:

FRONT → CENTER → SURROUND

- ② Turn [INPUT SELECTOR] to set the distance.

- ③ Repeat ① and ② to change other DISTANCE settings.

FILTER

Turn [INPUT SELECTOR] to set the cut-off.

When you turn the selector:

100 ↔ 150 ↔ 200

DR COMP

Turn [INPUT SELECTOR] to change the setting.

When you turn the selector:

OFF ↔ STANDARD ↔ MAX

D-INPUT

- ① Press [B] to select the input position you want to set.

Each time you press the button:

CD COAX → DVD OPT2 → TV OPT1

These are the factory settings. Actual displays depend on the changes you make. If you change one setting, the other corresponding setting will also change.

- ② Turn [INPUT SELECTOR] to change the setting.

When you turn the selector:

COAX ↔ OPT1 ↔ OPT2

- ③ Repeat ① and ② to change other D-INPUT settings.

DIMMER

Turn [INPUT SELECTOR] to change the setting.

When you turn the selector:

OFF ↔ ON

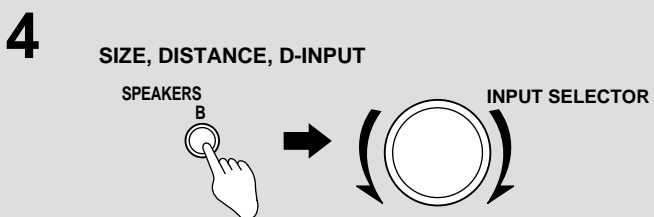
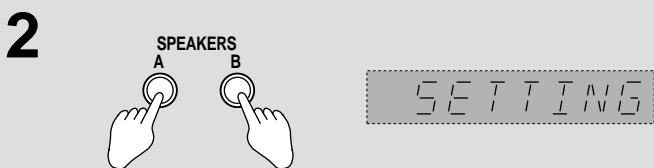
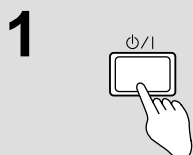
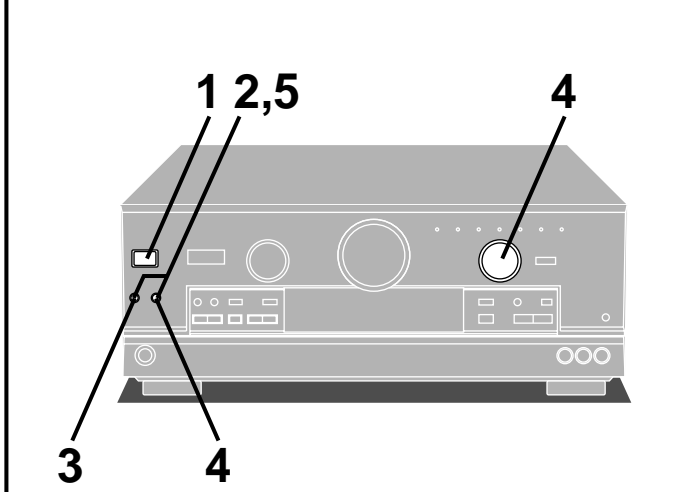

FILTER, DR COMP, DIMMER

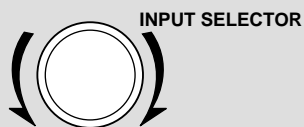

SPEAKERS A, B

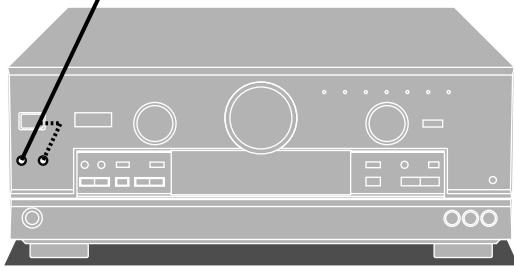

For front speakers with an impedance under 6 Ω

Turn "LOW IMP" on if even one of your speakers has an impedance under 6 Ω.

Press and hold [A] or [B] until "LOW IMP" lights up on the display.

Press and hold down again to cancel "LOW IMP".

Note that when "LOW IMP" is on, SPEAKERS A and B cannot be used at the same time.

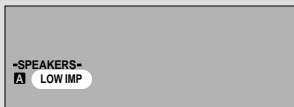
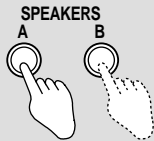

Adjusting speaker output level

Adjust the level of the speakers so they are the same apparent level as the front speakers when you are sitting where you would normally enjoy a source.

1 Press [A] to turn on SPEAKERS A.
You cannot adjust output level when SPEAKERS B is on.

2 Press [TEST] to output the test signal.
DSP sound mode switches to SURROUND mode.
The signal is output from each speaker in order for about two seconds each:

L: Front speaker (left)

C: Center speaker

R: Front speaker (right)

RS: Surround speaker (right)

LS: Surround speaker (left)

SW: Subwoofer

Speakers set as "NONE" or "NO" are skipped.

Note

The test signal will not be output if DSP is defeated (➔ page 22) or DVD 6CH INPUT is on (➔ page 19).

3 Adjust the volume to the level normally used.

Adjust the balance of the front speakers if necessary (➔ page 20).

4 Press [LEVEL] to select the speaker channel to adjust.

The current level appears on the display.
Press again to change the speaker channel.

Speakers set as "NONE" or "NO" are skipped.

5 Press [-] or [+] to adjust the level to the same apparent level as the front speakers.

C, RS, and LS can be adjusted between -10 dB and +10 dB, with zero being the current level of the front speakers.
SW can be set to MIN, between 1 to 19, or MAX.

Repeat steps 4 and 5 for each speaker channel.

6 Press [TEST] to stop the test signal.

For your reference

Subwoofer output is easily influenced by the source played. You can achieve better results by adjusting its output while listening to a source (➔ page 21).

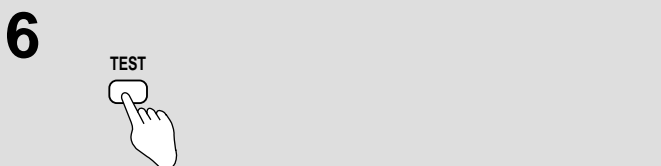
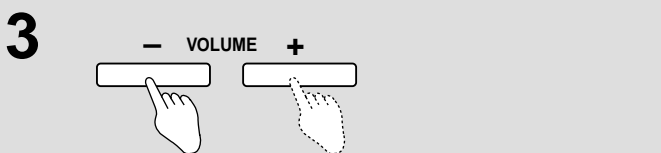
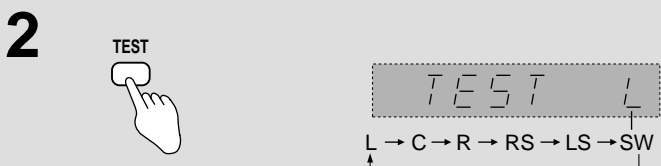
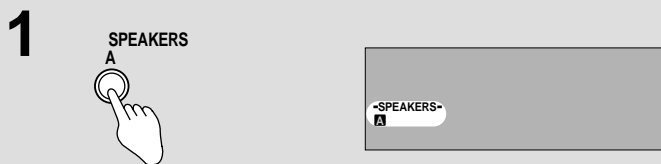
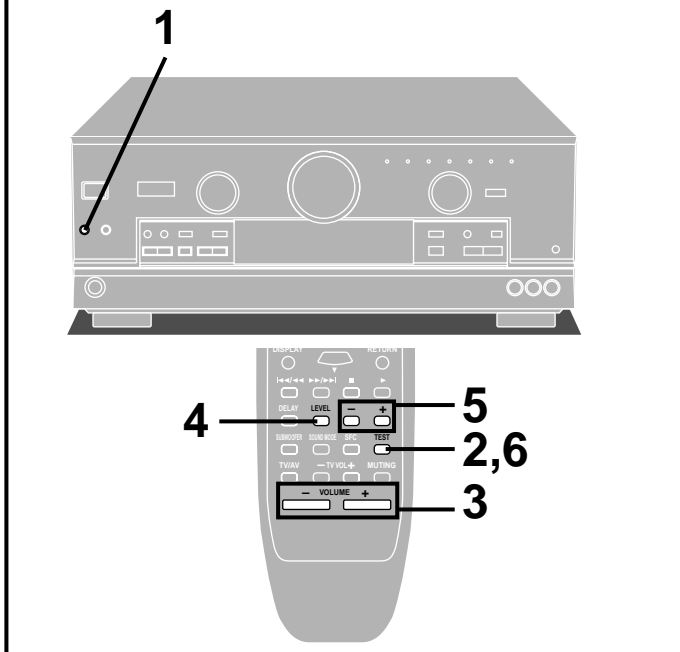

DSP sound modes

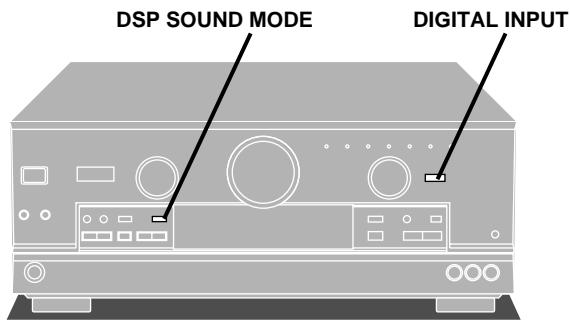

The digital sound processor (DSP) in this unit can decode Dolby Digital and DTS digital signals. It automatically determines the type of signal, PCM, Dolby Digital, or DTS, and processes it accordingly. The DSP can add surround-like effects to stereo sources (analogue or PCM signals).

Choose from the STEREO, SURROUND, or SFC modes.

The DSP may interfere with radio reception. You can turn it off if this occurs (→ page 22).

Output is in stereo when you turn the DSP off so sound is only heard through the front speakers.

Note

- PCM with a sampling frequency of 44.1 kHz is the digital signal format normally found on CDs. Some DVDs also use this format but often with a higher sampling rate.
- This unit cannot process other digital signal formats, such as PCM signals with sampling frequencies of 96 kHz and 192 kHz and MPEG.

A

DSP SOUND MODE

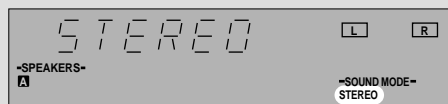

B

DSP SOUND MODE

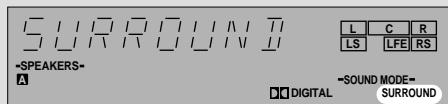

C

DIGITAL INPUT

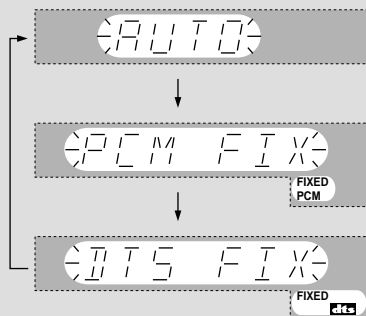

A STEREO mode

Use this mode to play digital or analogue stereo sources or to play surround sources through two speakers. When surround sources are played in this mode, the sounds intended for the other speaker channels are played through the front speakers.

B SURROUND mode

Select this mode when you are playing a digital surround source (Dolby Digital or DTS) or an analogue source that is recorded with Dolby Surround (VCR, for example).

C Changing the recognition mode

In rare cases, the unit may have trouble recognizing the digital signals on discs. With the PCM signals on CDs, this may cause the beginning of a track to be cut off. Engage the PCM FIX mode if this occurs. With DTS, the signals may not be recognized at all. Engage the DTS FIX mode if this occurs.

This mode does not need to be changed under normal circumstances. Change it only if the unit appears to be having trouble recognizing the software you are playing.

While the input source is selected and digital input is engaged:

Press and hold [DIGITAL INPUT].

The current mode is displayed. Press again to change the mode.

Each time you press the button:

AUTO → PCM FIX → DTS FIX

When a FIX mode is on, the unit cannot process other signals. This may cause noise to be output. Select "AUTO" if this occurs.

The selected mode is stored even if the unit is turned off.

DSP sound modes

A SFC modes

Enjoy an enhanced sound experience with greater presence and spread by using these SFC (sound field control) modes with PCM or analogue stereo sources.

The SFC modes cannot be used if the input signal is Dolby Digital or DTS.

Choose from the following modes.

HALL

Imparts the reflection and spread of a large concert hall.

CLUB

Conveys the exciting and intimate atmosphere of a jazz club.

LIVE

Brings you up close for "live" stage performance and smoother vocals.

THEATER

Recreates natural sound ambience and direction.

SIM SURR (Simulated Surround)

Heightens the sensation of expanded space with stereo sources, and augments monaural sources.

B Adjusting the sound field

You can adjust the sound field by adjusting the level of the speakers and the delay time of the surround speakers. These adjustments can be made for each SFC mode.

To adjust the speaker level

① Press [LEVEL] to select the speaker channel.

Each time you press the button:

C → RS → LS → SW



Speakers set as "NONE" or "NO" are skipped.

② Press [-] or [+] to adjust the level.

C, RS, and LS:

-10 dB to +10 dB

SW:

--- (off) ↔ MIN ↔ 1 - 19 ↔ MAX

To adjust the delay time

① Press [DELAY].

② Press [-] or [+] to change the delay time.

Delay time can be set at 10-millisecond (ms) intervals between 10 and 100 ms.

The factory setting is 50 ms for each mode.

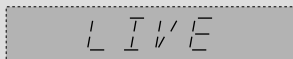
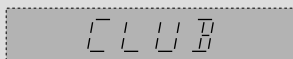
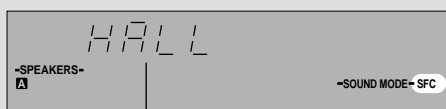
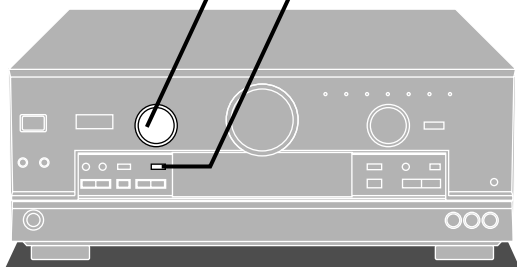
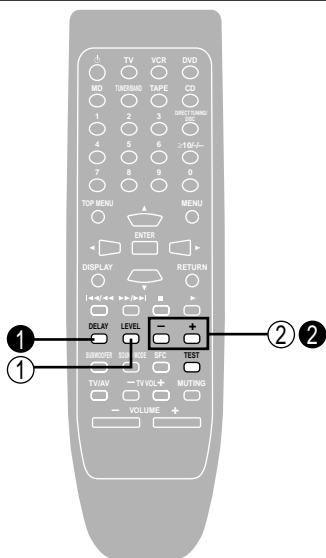
A**SFC MODE** **DSP SOUND MODE****B**

Enjoying the sounds

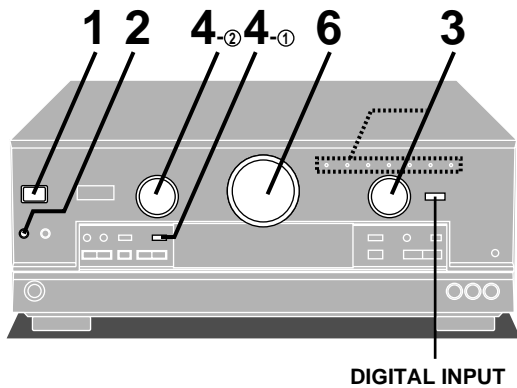

DIGITAL INPUT

- 1** Press [⏻/⏪].
- 2** Press [SPEAKERS A].
"SURROUND" and "SFC" do not work if you select "B".
- 3** Turn [INPUT SELECTOR] to select the input source.
(SA-DX1050) The indicator corresponding to the selected source lights.

To switch between analogue and digital input (CD, DVD, and TV)

Press [DIGITAL INPUT].

Each time you press the button:

ANALOG ↔ DIGITAL

The indicator lights when you select "DIGITAL".

Once you have set the mode for a source, that mode is engaged whenever you select that source.

- 4** Select the DSP sound mode.

① Press [DSP SOUND MODE].

The indicator corresponding to the mode lights.

Select the mode appropriate to the source (➔ pages 16–17).

② When you select "SFC"

Turn [SFC MODE].

Once you have set the mode for a source, that mode is engaged whenever you select that source.

- 5** Start playing the source.

Refer to the equipment's instructions for details.

- 6** Adjust the volume.

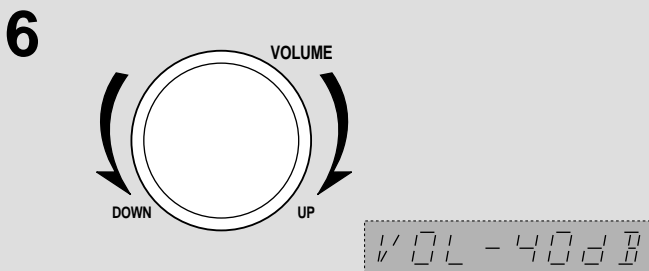
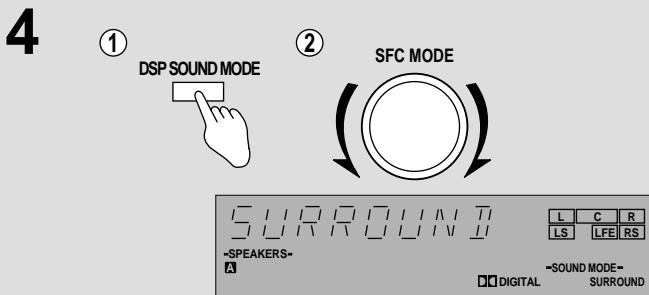
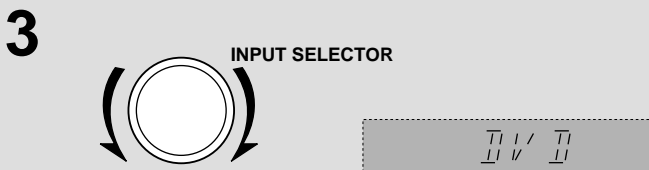
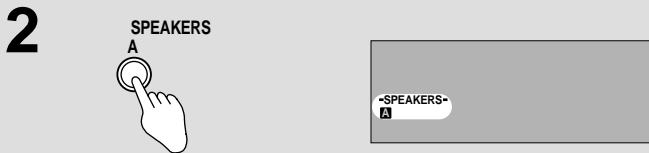
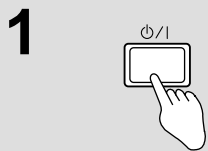

When you finish listening

Be sure to reduce the volume and press [⏻/⏪] to switch the unit to standby.

For your reference

- **If you are using a VCR and you select TAPE/MD (or TAPE), CD, TUNER, or PHONO**
The picture will remain on the screen.
- **The signal format indicators**
The following indicators light depending on the source you are playing.
 - ■ **DIGITAL:**
Dolby Digital sources
 - ■ **dts:**
DTS sources
 - ■ **PRO LOGIC:**
Analogue sources in SURROUND mode
Digital sources with PCM signals in SURROUND mode
Dolby Digital sources that contain Dolby Pro Logic in SURROUND mode
- **The program format indicators (L, C, R, LS, S, LFE, RS)**
The program format indicators light up to indicate the channels contained in the digital input signal. They do not light when input is analogue.
 - L: Front channel (left)
 - C: Center channel
 - R: Front channel (right)
 - LS: Surround channel (left)
 - RS: Surround channel (right)
 - S: If the surround channel is monaural
 - LFE (Low Frequency Effect): Deep-bass effect

Enjoying the sounds

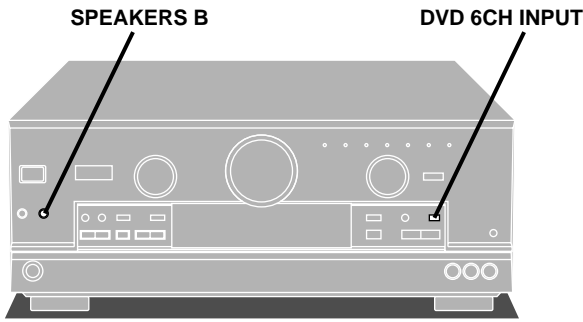

A To switch between DVD 2 channel and 6 channel input

There may be times when you need to use analogue input for DVD, such as to enjoy sources recorded with MPEG, linear PCM and multiple channel linear PCM.

Select the analogue input mode to suit the source.

DVD: For two-channel audio.

DVD 6CH: For multiple channel audio.

Press [DVD 6CH INPUT].

Each time you press the button:

DVD ↔ DVD 6CH

Input switches automatically to DVD if you press this button while another source is selected.

The indicator lights when you select "DVD 6CH".

Once you have set the mode, that mode is engaged whenever you select "DVD".

Note

- DVD 6CH INPUT only works when SPEAKERS A is on and SPEAKERS B is off.
- You cannot use any of the DSP sound modes while DVD 6CH INPUT is on.
- Speaker settings (➔ page 13) are ineffective while DVD 6CH INPUT is on. Change the settings on the DVD player if necessary.

B To use SPEAKERS B

Use SPEAKERS B if you have connected another set of speakers to the B terminals.

Sound will be heard in stereo while SPEAKERS B is on.

Press [B].

If you don't want sound coming from the speakers connected to the A terminals, press [A] to turn them off.

A

DVD 6CH INPUT



DVD 6CH

B

SPEAKERS B



-SPEAKERS-
B

Manufactured under license from Dolby Laboratories.
"Dolby", "Pro Logic" and the double-D symbol are trademarks of Dolby Laboratories.
Confidential Unpublished Works. © 1992-1997 Dolby Laboratories. All rights reserved.

Manufactured under license from Digital Theater Systems, Inc.
"DTS" and "DTS Digital Surround" are trademarks of Digital Theater Systems, Inc. © 1996 Digital Theater Systems, Inc. All rights reserved.

Enjoying the sounds

A

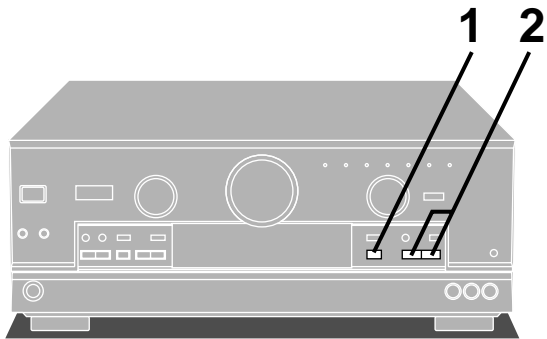

1



BASS

2

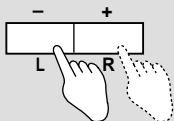

BASS, TREBLE

0dB

-10 dB — +10 dB

BALANCE

L 7 R

A

Adjusting the tone and balance

You can adjust the tone (BASS and TREBLE) only when the DSP sound mode is STEREO and input is either analogue or PCM. You cannot adjust the tone while the DSP is defeated or if DVD 6CH INPUT is selected.

1 Press [BASS/TREBLE, BALANCE].

Each time you press the button:
BASS → TREBLE → BALANCE

BASS: To adjust the bass

TREBLE: To adjust the treble

BALANCE: To adjust the left/right sound balance

2 Press [-, L] or [+ , R].

-, L: to lower the selected tone or shift the balance to the left speaker.

+, R: to raise the selected tone or shift the balance to the right speaker.

The previous display returns after a few seconds.

B

Using the VCR 2 terminals

SA-DX1050 only

This button only works when "VCR 1" is selected as the input source.

Press [VCR 1 , VCR 2 ] to select "VCR 1 " or "VCR 2 ".

C

Using headphones

① Press [A] and/or [B] to turn off the speakers.

Turning the speakers off automatically engages STEREO mode and ensures no sound is heard from the subwoofer.

(Sound will seem unusual if you use another DSP mode.)

② Reduce the volume.

③ Connect the headphones (not included).

Plug type: 6.3 mm stereo

④ Adjust the volume.

Note

Avoid listening for prolonged periods of time to prevent hearing damage.

B

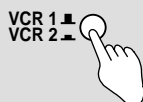
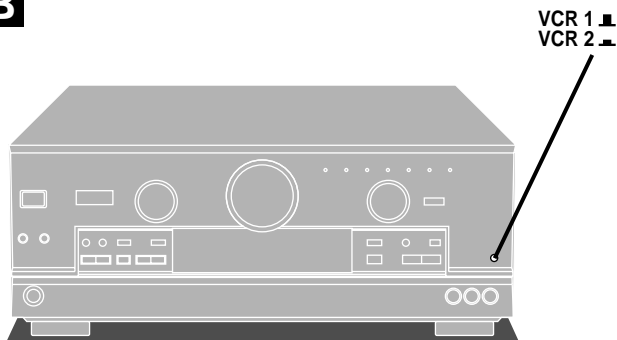

C

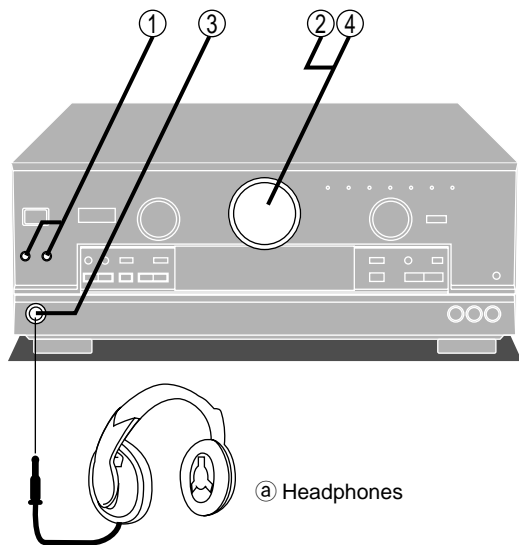

Enjoying the sounds

A Muting the volume

Press [MUTING].

The message "MUTING ON NOW" runs repeatedly from right to left across the display as long as the muting function is on.

To cancel

Press [MUTING].

Muting is also canceled when the unit is turned off.

B Adjusting the subwoofer level

You can adjust the volume of the subwoofer while listening to a source. No sound is heard from the subwoofer if "SW ---" is selected. This setting can be done for each DSP mode.

You cannot adjust the subwoofer level while the DSP is defeated or if DVD 6CH INPUT is selected.

The factory setting is "SW 10".

Press [SUBWOOFER].

The current setting is shown.

Each time you press the button:

SW --- → SW MIN → SW 5 → SW 10 → SW 15 → SW MAX

To make finer adjustments

- 1 Press [LEVEL] to select "SW".
- 2 Press [-] or [+].

Note

Sound from the subwoofer can be distorted if you raise the unit's volume while subwoofer level is high. Reduce subwoofer level if this occurs.

C Using the TAPE MONITOR

Use the tape monitor if you have connected a graphic equalizer to the TAPE/MD (or TAPE) terminals.

Press [TAPE MONITOR].

The "TAPE MONITOR" indicator lights and the tape monitor comes on.

Sources other than TAPE/MD (or TAPE) can still be selected with [INPUT SELECTOR] while the "TAPE MONITOR" indicator is on. Press [TAPE MONITOR] again to turn the tape monitor off.

(→ See "Making a recording" on page 26 for details on how to use the tape monitor during recording.)

Note

- The tape monitor cannot be used when input is digital and turns off if you select digital input.
- Depending on the setting, the graphic equalizer can cause distortion.

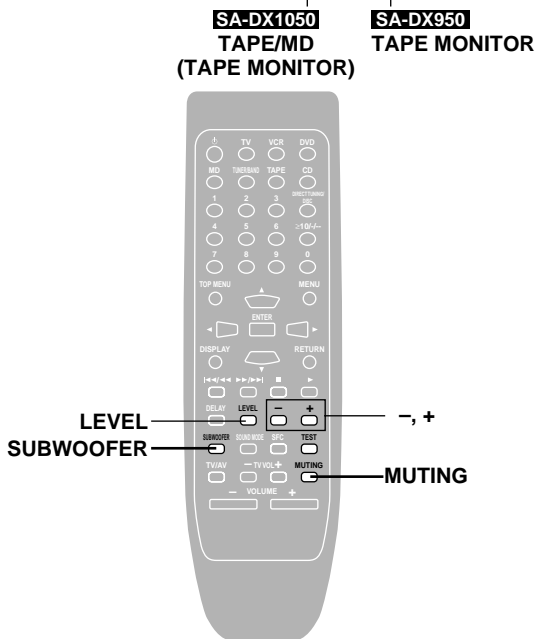
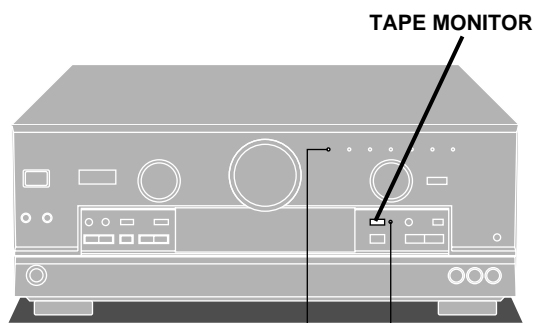

A

MUTING



B

SUBWOOFER

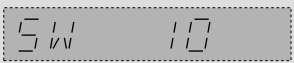

C

TAPE MONITOR



The radio

A Manual tuning

You can tune radio stations manually by selecting the station's frequency, or you can preset up to 30 stations into channels to make tuning simpler (→ page 23).

- 1 Turn **[INPUT SELECTOR]** to select "TUNER".
- 2 Press **[BAND]** to select "FM" or "AM".
- 3 Press **[TUNING ∨ or ∧]** to select the frequency of the station.

"TUNED" lights when tuned.

"STEREO" lights during FM stereo broadcasts.

Automatic tuning

Hold down **[TUNING ∨ or ∧]** until the frequency begins to scroll. Tuning stops when a station is found. (Tuning may stop if there is interference.)

Improving reception

• FM mode

You can improve FM reception by switching reception to monaural.

Press **[FM MODE]**.

"MONO" lights.

Press the button again to cancel.

• DSP DEFEAT

You can improve reception by turning off the DSP (→ page 16).

Press and hold **[DSP SOUND MODE]** until "DEFEAT" appears.

Press and hold **[DSP SOUND MODE]** again to turn the DSP on.

• For your reference

DVD players can interfere with radio reception. Turn the DVD player off or move it further away from the antennas if this occurs.

To change the AM frequency step

Press and hold **[BAND]** for about 3 seconds when AM band is selected. (The frequency step changes from 9 kHz to 10 kHz.)

To return to the previous step, press and hold **[BAND]** for about 3 seconds again.

B Direct tuning

- 1 Press **[TUNER/BAND]**.

The band changes each time you press the button.

- 2 Press **[DIRECT TUNING/DISC]**.

- 3 Press the numbered buttons to enter the frequency.

e.g. To select 107.90 MHz, press [1] → [0] → [7] → [9] → [0]

Note

1. If you do not press a button while the cursor is flashing, the display returns to the frequency being received.
2. If the frequency has not been input correctly, "ERROR" will be displayed.

A

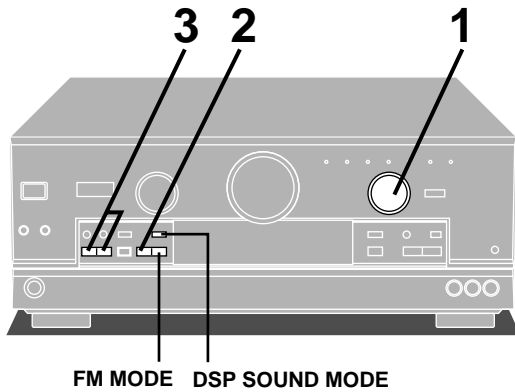

1

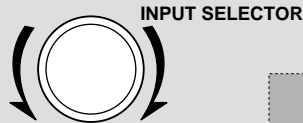

2

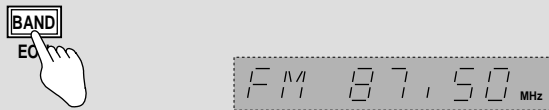

3

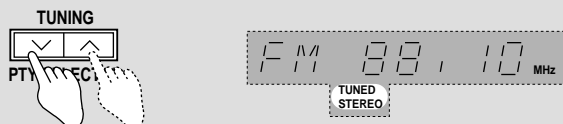

B

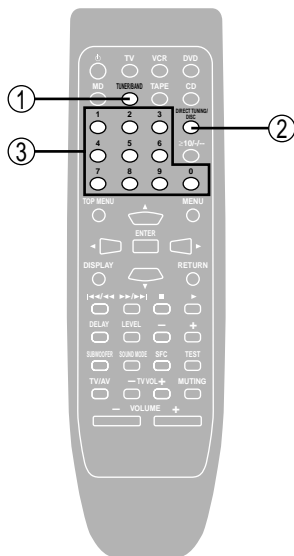

A
C

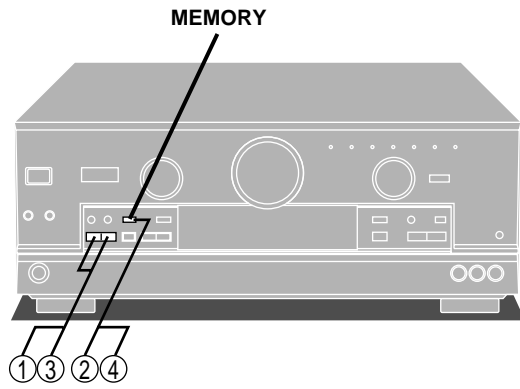

A



B

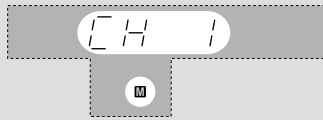

D

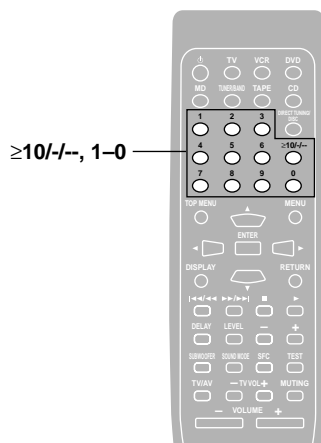
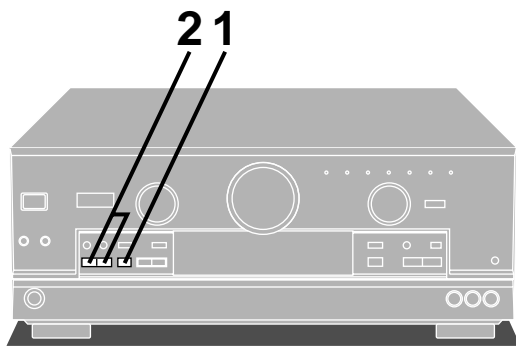

1



2

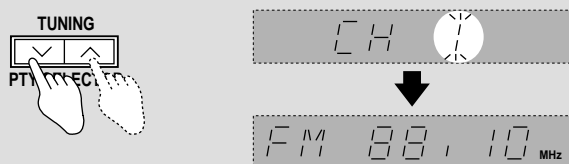

The radio

Preset tuning

Choose either automatic presetting, which presets the stations the tuner can receive, or manual presetting, which allows you to select the stations to preset and the order in which they are to be preset. There are 30 channels available for presetting.

Remember

If a new station is preset into a channel, the old station is erased.

A Automatic presetting

Presetting FM stations

Preparation: Tune to the FM frequency where you want to begin presetting (→ page 22).

Press and hold [MEMORY].

The FM stations the unit can receive are preset in channels 1 to 30.

Presetting AM stations

Preparation: Tune to the AM frequency where you want presetting to begin (→ page 22).

Press and hold [MEMORY].

The AM stations the unit can receive are preset in channels 21 to 30. (FM stations are replaced if any were preset in these channels.)

During automatic presetting, the memory indicator flashes and the frequency scrolls. The memory indicator and channel numbers are displayed for a second when a station is preset (B). The last station to be preset is displayed when presetting finishes.

For your reference

Even if the AC mains lead is disconnected from the household mains socket, the stations remain in memory for approximately one month.

C Manual presetting

Preset the stations one at a time.

- ① Tune to the station.
- ② Press [MEMORY].
- ③ Press [TUNING ∨ or ∧] to select a channel.
- ④ Press [MEMORY].

D Selecting channels

1 Press [PRESET].

The channel number flashes for about 5 seconds.

2 Press [TUNING ∨ or ∧].

Hold down the buttons to change channels faster.

On the remote control

Press the numbered buttons.

For channels 1 to 9, press the corresponding number.

For channels 10 or over, press [≥10/-/-,] then the two digits.

e.g. To select channel 21

[≥10/-/-,] → [2] → [1]

RDS (radio data system) is a multiplex broadcasting system where, along with FM audio signals, stations transmit other signals to help you enjoy radio more and tune into programs easier. This unit can use the following types of signals. Some stations do not have PTY, EON, and RT.

- **PS** (Program service): Station name.
- **PTY** (Program type): Displays the program type (➡ below) and is used to search for a type of program (➡ page 25).
- **EON** (Enhanced other networks): This signal is used between networked stations to make it easier for you to tune into a type of program (➡ page 25).
- **RT** (Radio text): This unit can show up to 64 letters by scrolling them across the display. This text could be about the song, traffic or weather, phone-in numbers, or police information.

Note

This unit does not have the emergency broadcasts system (EBS) that tunes automatically into emergency broadcasts.

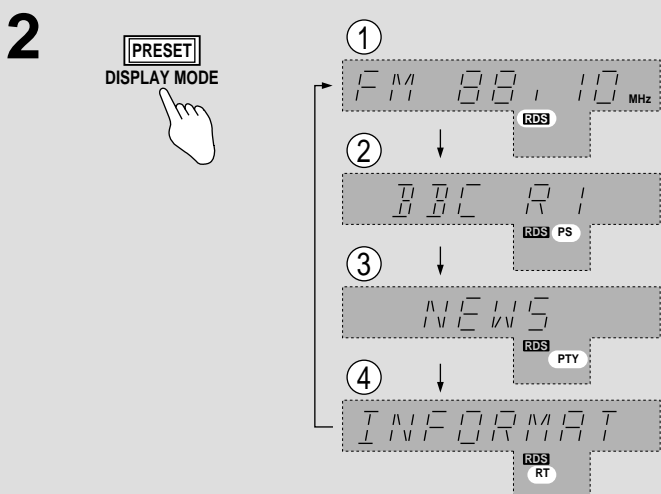
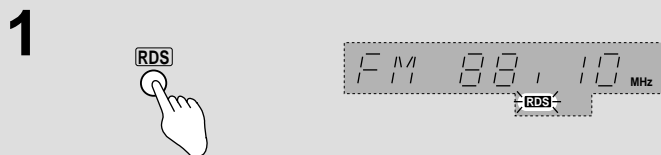
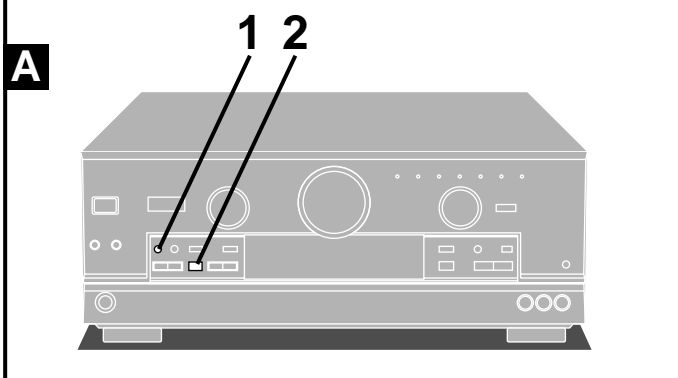

A To display RDS information

The display normally shows the radio frequency. "RDS" lights when the station is broadcasting RDS signals. You cannot change the display if "RDS" is off.

- 1 Press [RDS].**
- 2** While "RDS" is flashing
Press [PRESET, DISPLAY MODE].
The display changes each time you press the button.
 - ① **Frequency display**
 - ② **PS display**
 - ③ **PTY display** ("NO PTY" if there are no PTY signals, then the frequency is shown again)
 - ④ **RT display** (no change if there are no RT signals)

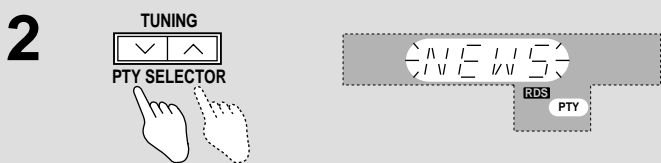
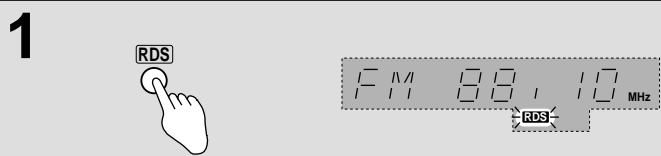
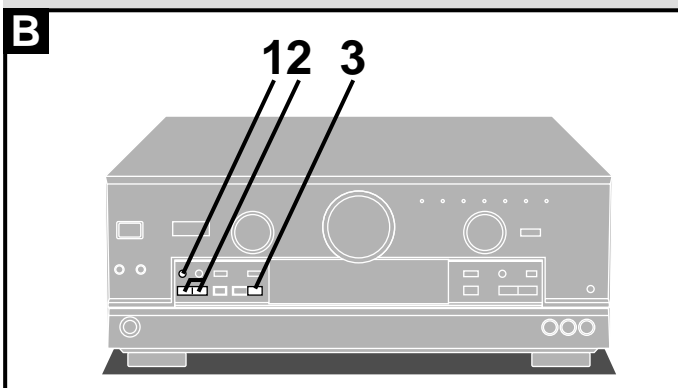

B PTY search

PTY finds programs currently broadcasting from amongst the preset FM stations. Preset FM stations before proceeding.

- 1 Press [RDS].**
- 2** While "RDS" is flashing
Press [TUNING, PTY SELECTOR, ↓, ↑] to select the program type.
The display changes each time you press the button (➡ page 25 for PTY displays).
- 3** While the PTY display is flashing
Press [FM MODE, PTY SEARCH].
The PTY indicator flashes while searching. The unit switches to the station broadcasting the program. The PTY indicator flashes for another two seconds. "SELECT PTY FIRST" scrolls across the display if you try to start a PTY search without selecting a program type.

A

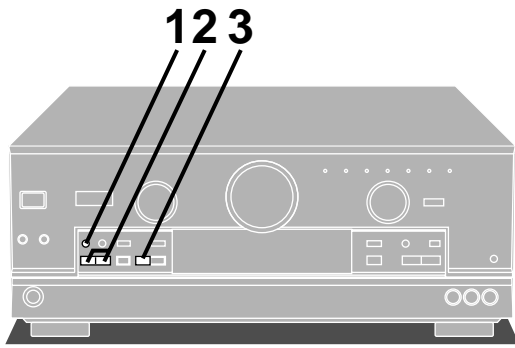

A EON tuning

EON puts the unit on standby to receive programs that are going to be broadcast on a station that shares RDS signals with the current station. Preset FM stations before proceeding. EON tuning does not work if the unit is not receiving EON signals ("NO EON" is displayed.)

1 Press [RDS].

2 While "RDS" is flashing Press [TUNING, PTY SELECTOR, ∇, ▲] to select the program type.

3 While the PTY display is flashing Press [BAND, EON].

"EON" lights.

The current station remains tuned in until the program type starts, then the unit switches to the station and "OTHER PROGRAM SERVICE" scrolls across the display. (It changes immediately if the selected program is broadcasting.)

To cancel EON tuning

1. Press [RDS].
2. Press [BAND, EON].

EON tuning is also canceled if you operate the tuner, change the input source, or turn the unit off.

B PTY displays

NEWS	News
AFFAIRS	Current affairs
INFO	Information
SPORT	Sport
EDUCATE	Education
DRAMA	Drama
CULTURE	Culture
SCIENCE	Science
VARIED	Varied
POP M	Pop music
ROCK M	Rock music
M. O. R. M	Middle-of-the-road Music
LIGHT M	Light classical
CLASSICS	Serious classical
OTHER M	Other music
WEATHER	Weather information
FINANCE	Finance
CHILDREN	Children
SOCIAL A	Social affairs
RELIGION	Religion
PHONE IN	Phone in
TRAVEL	Travel
LEISURE	Leisure
JAZZ	Jazz music
COUNTRY	Country music
NATIONAL	National music
OLDIES	Oldies
FOLK M	Folk music
DOCUMENT	Documentary
TEST	Test broadcast
ALARM	Emergency announcement

Making a recording

Note

- You cannot record a source connected through a digital terminal. When recording CD, DVD, or TV, ensure the source is connected through the corresponding analogue terminals (➔ pages 6–7) and “ANALOG” input is selected (➔ page 18).
- When you select DVD 6CH INPUT mode, only sound from the front left and right channels is recorded.

A Recording on a tape or MD deck, or VCR

You can record to a tape deck connected to TAPE/MD (or TAPE) REC (OUT) or to a VCR connected to VCR 1 (or VCR) OUT.

See the recording unit's operating instructions for details on how to prepare it for recording.

When recording with a tape or MD deck, you can record any source except TAPE/MD (or TAPE).

When recording with a VCR, you can record any source except TAPE/MD (or TAPE) or VCR 1/2 (or VCR).

1 Turn [INPUT SELECTOR] to select the source to be recorded.

2 SA-DX1050 only

If you selected “VCR 1” in step 1, set [VCR 1 ▬, VCR 2 ▬] to the required position.

3 Begin recording.

Follow your recording unit's operating instructions.

4 Begin the source to be recorded.

Follow your equipment's operating instructions.

B To monitor sound being recorded onto a tape deck

It is possible to check the sound being recorded if your tape deck is a 3 head system.

Press [TAPE MONITOR] on this unit and set the monitor button on the tape deck to “TAPE”.

Press [TAPE MONITOR] once again to turn it off.

A

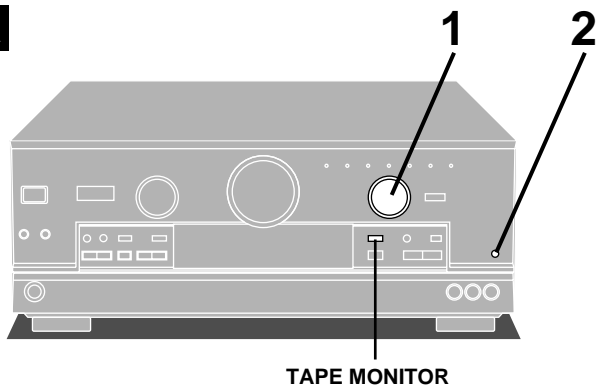

1

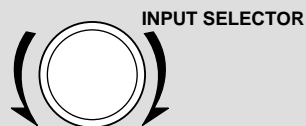

2

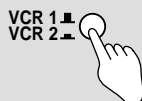

B



For Europe

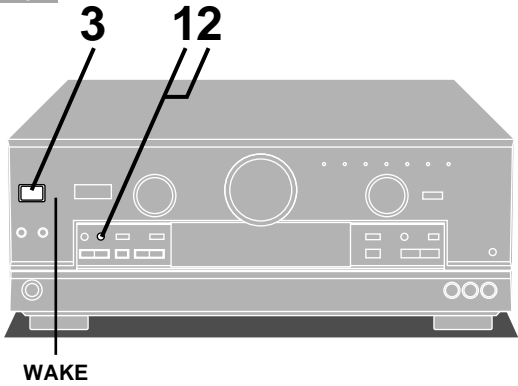

For Australia and New Zealand

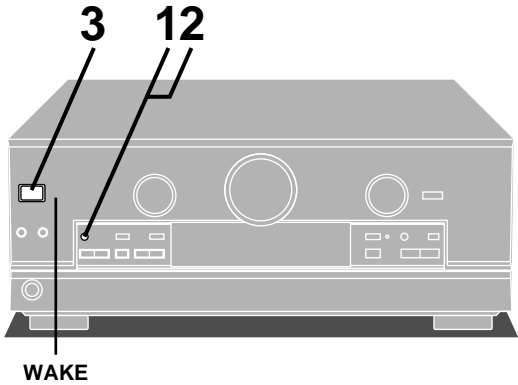

Timer function

There are two timer functions: the sleep timer and the wake timer.

Note

• Sleep timer:

The unit turns off after a set time.
It can be set for 30, 60, or 90 minutes.

• Wake timer:

The unit can be set to turn on a certain number of hours after it is turned off.
It can be set for 5, 7, or 9 hours.

Setting the timers

1 Press [TIMER, -MODE, -TIME] to select the desired timer mode.

2 [Within 5 seconds]
Press [TIMER, -MODE, -TIME] and release when the time you require is displayed.

The display changes as follows:

- In sleep timer mode
30 → 60 → 90 (minutes)
- In wake timer mode
5H → 7H → 9H (hours)

The display is restored 5 seconds after the setting is completed.

3 **Wake timer mode only**
Press [⏻/⏪] to turn off the unit.
The "WAKE" indicator lights up.

Checking the remaining time on the sleep timer and the time set for the wake timer

Press [TIMER, -MODE, -TIME] once.

Note

Do not press [TIMER, -MODE, -TIME] again before the remaining time indication goes out.
The setting may change if you do this.

Changing a setting

Repeat steps 1 and 2.

To cancel the timer

Press [TIMER, -MODE, -TIME] until "OFF" is displayed.
"SLEEP" or "WAKE" will go out.

Note

- The timers cannot be used together.
- The sleep timer turns off the receiver, and the wake timer turns on the receiver, but they do not turn off/on any externally connected components.

1

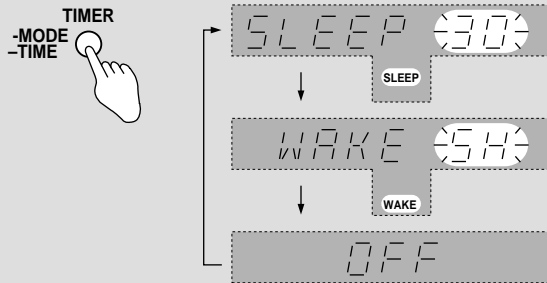

2



3



The HELP function

If you make a mistake in operation or if sound output stops, the HELP function displays information that indicates how you can remedy the situation.

If "ERROR" or scrolling characters ("SPEAKER OFF NOW", for example) appear on the display, do the following.

Press [-HELP, -RESET].

The remedy for the situation is displayed.

For your reference

You can reset the unit's settings to the factory settings. If this is ever necessary, press and hold [-HELP, -RESET] for about 2 seconds until "RESET" is displayed.

This will not erase radio stations you have preset

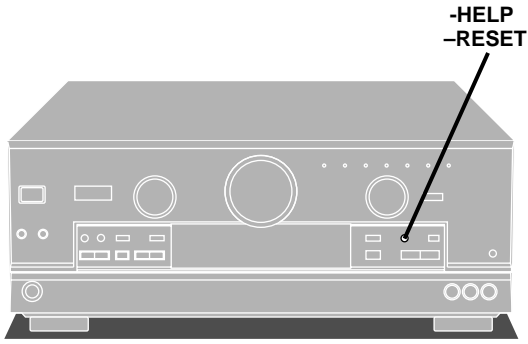

Maintenance

If the surfaces are dirty

To clean this unit, wipe with a soft, dry cloth.

If the surfaces are extremely dirty, use a soft cloth dipped in a soap-and-water solution or a weak detergent solution.

- Never use alcohol, paint thinner or benzine to clean this unit.
- Before using chemically treated cloth, read the instructions that came with the cloth carefully.

Troubleshooting guide

Before requesting service, make the below checks. If you can't fix the system as described below, or if something not listed here occurs, refer to the enclosed directory to locate an Authorized Service Center convenient to you or contact your dealer.

Common problems		Ref.Pages
<p>No power.</p> <p>No sound.</p> <p>Cannot select "DIGITAL" input.</p> <p>Sound stops. "OVERLOAD" appears on the display.</p> <p>"F 70" appears on the display.</p> <p>The picture doesn't appear on the television.</p>	<ul style="list-style-type: none"> ● Ensure the AC mains lead is connected. 	9
	<ul style="list-style-type: none"> ● Turn the volume up. ● Turn muting off. ● Check connections to speakers and other equipment. ● Turn on the speakers. ● Turn off the tape monitor. ● Select the correct source. ● Change the DIGITAL input setting to suit the type of connection you have made. ● Check that the digital signals can be decoded by this unit. ● Turn PCM FIX or DTS FIX off. 	18 21 6–11 18 21 18 12–13 16 16
	<ul style="list-style-type: none"> ● Cancel "DSP DEFEAT". 	22
	<ul style="list-style-type: none"> ● Switch off the unit, determine and correct the cause, then switch the unit on. Causes include shorting of the positive and negative speaker wires, using speakers with an impedance lower than rated for this unit, straining of the speakers through excessive volume or power, and using the unit in a hot environment. ● Use speakers with the right impedance rating. 	– 10–11
	<ul style="list-style-type: none"> ● Turn the unit off, disconnect the AC mains lead, then reconnect and turn the unit on. Consult your dealer if "F 70" remains on the display. 	–
<ul style="list-style-type: none"> ● Change the television's input mode to suit the connections between this unit and the television. 	–	

DSP sound modes		Ref.Pages
<p>Sound is not heard from the center, surround, or subwoofer speakers.</p>	<ul style="list-style-type: none"> ● Ensure the size settings for your speakers are correct. ● Check the DSP sound mode. ● Cancel "DSP DEFEAT". 	12–13 16–17 22
<p>DSP sound modes cannot be selected.</p>	<ul style="list-style-type: none"> ● Cancel "DSP DEFEAT". ● Turn SPEAKERS B off. ● Turn DVD 6CH INPUT off. 	22 19 19

Radio		Ref.Pages
<p>The radio cannot be tuned in or there is a lot of noise and interference.</p>	<ul style="list-style-type: none"> ● Adjust the position of the FM or AM antenna. ● Reduce the treble. ● Select "DSP DEFEAT". ● Turn off nearby televisions, video decks, DVD players, and satellite receivers. ● You may need an outdoor antenna or an antenna with more elements. ● Separate the antenna from other cables, leads, and appliances. 	8–9 20 22 22 8–9 –
<p>The correct AM frequency cannot be turned in.</p>	<ul style="list-style-type: none"> ● Change the frequency step. Hold [BAND] down for 10 seconds to change the step to 9 kHz. 	22

Specifications (DIN 45 500)

■ AMPLIFIER SECTION

Power output (at 230 V for Continental Europe) (at 240 V for the United Kingdom, Australia and New Zealand)	
DIN 1 kHz (T.H.D. 1%) [SA-DX1050]	2 x 100 W (6 Ω)
20 Hz–20 kHz continuous power output both channels driven [SA-DX950]	2 x 80 W (6 Ω)
40 Hz–20 kHz continuous power output both channels driven	2 x 80 W (6 Ω)
Total harmonic distortion	
[SA-DX1050] rated power at 20 Hz–20 kHz	0.09 % (6 Ω)
[SA-DX950] rated power at 40 Hz–20 kHz	0.09 % (6 Ω)
half power at 1 kHz	0.03 % (6 Ω)
Power output at 1 kHz each channel driven	
DIN 1 kHz (T.H.D. 1%)	
Front	2 x 100 W (6 Ω)
Center	100 W (6 Ω)
Surround	2 x 100 W (6 Ω)
Power bandwidth	
both channels driven, –3 dB	10 Hz–70 kHz (6 Ω, 0.9 %)
Damping factor	30 (6 Ω)
Load impedance	
Front	
A or B	4–16 Ω
A and B	8–16 Ω
Center	6–16 Ω
Surround	6–16 Ω
Frequency response	
PHONO RIAA standard curve (30 Hz–15 kHz) ±0.8 dB	
[SA-DX1050] CD, TAPE/MD, DVD, TV, VCR 1, VCR 2	10 Hz–40 kHz, ±3 dB
[SA-DX950 for Europe]	
CD, TAPE/MD, DVD, TV, VCR	10 Hz–40 kHz, ±3 dB
[SA-DX950 for Australia and New Zealand]	
CD, TAPE, DVD, TV, VCR	10 Hz–40 kHz, ±3 dB
Input sensitivity and impedance	
PHONO	3 mV/47 kΩ
[SA-DX1050] CD, TAPE/MD, DVD, TV, VCR 1, VCR 2	200 mV/22 kΩ
[SA-DX950 for Europe]	
CD, TAPE/MD, DVD, TV, VCR	200 mV/22 kΩ
[SA-DX950 for Australia and New Zealand]	
CD, TAPE, DVD, TV, VCR	200 mV/22 kΩ
S/N at rated power (6 Ω)	
PHONO	70 dB (IHF, A: 80 dB)
[SA-DX1050] CD, TAPE/MD, DVD, TV, VCR 1, VCR 2	75 dB (IHF, A: 85 dB)
[SA-DX950 for Europe]	
CD, TAPE/MD, DVD, TV, VCR	75 dB (IHF, A: 85 dB)
[SA-DX950 for Australia and New Zealand]	
CD, TAPE, DVD, TV, VCR	75 dB (IHF, A: 85 dB)
DVD 6CH	
	100 dB (IHF A, Rated Power, S=2 V), 75 dB (IHF, A: 85 dB)
Output voltage	
[SA-DX1050] TAPE/MD REC (OUT), VCR 1 OUT	200 mV
[SA-DX950 for Europe]	
TAPE/MD REC (OUT), VCR OUT	200 mV
[SA-DX950 for Australia and New Zealand]	
TAPE REC (OUT), VCR OUT	200 mV
Tone controls	
BASS	50 Hz, +10 to –10 dB
TREBLE	20 kHz, +10 to –10 dB
Channel balance (250 Hz–6.3 kHz)	±1 dB
Channel separation	55 dB
Headphones output level and impedance	430 mV/330 Ω
Subwoofer frequency response (–6 dB)	7–200 Hz

Digital input

Optical	2
Coaxial	1

■ FM TUNER SECTION

Frequency range	87.50–108.00 MHz
Sensitivity	
S/N 30 dB	1.5 μV/75 Ω
S/N 26 dB	1.3 μV/75 Ω
S/N 20 dB	1.2 μV/75 Ω
IHF usable sensitivity (IHF'58)	1.5 μV/75 Ω
IHF 46 dB stereo quieting sensitivity	22 μV/75 Ω
Total harmonic distortion	
MONO	0.2 %
STEREO	0.3 %
S/N	
MONO	60 dB (73 dB, IHF)
STEREO	58 dB (67 dB, IHF)
Frequency response	
20 Hz–15 kHz	+1 dB, –2 dB
Alternate channel selectivity	
±400 kHz	65 dB
Capture ratio	1.5 dB
Image rejection at 98 MHz	40 dB
IF rejection at 98 MHz	70 dB
Spurious response rejection at 98 MHz	70 dB
AM suppression	50 dB
Stereo separation	
1 kHz	40 dB
Carrier leak	
19 kHz	–30 dB (–35 dB, IHF)
38 kHz	–50 dB (–55 dB, IHF)
Channel balance (250 Hz–6.3 kHz)	±1.5 dB
Limiting point	1.2 μV
Bandwidth	
IF amplifier	180 kHz
FM demodulator	1000 kHz
Antenna terminal	75 Ω (unbalanced)

■ AM TUNER SECTION

Frequency range	522–1611 kHz (9 kHz steps)
	530–1620 kHz (10 kHz steps)
Sensitivity	20 μV, 330 μV/m
Selectivity (at 999 kHz)	55 dB
IF rejection (at 999 kHz)	50 dB

■ VIDEO SECTION

Output voltage at 1 V input (unbalanced)	1±0.1 V _{p-p}
Maximum input voltage	1.5 V _{p-p}
Input/output impedance	75 Ω (unbalanced)

■ GENERAL

Power supply	
For Continental Europe	AC 230 V, 50 Hz
For the United Kingdom, Australia and New Zealand	AC 230–240 V, 50 Hz
Power consumption	230 W
Dimensions (W x H x D)	430 x 158 x 375 mm
Mass	[SA-DX1050] 10.0 kg
	[SA-DX950] 9.8 kg

Power consumption in standby mode:	2 W
---	------------

Notes:

- Specifications are subject to change without notice.
Mass and dimensions are approximate.
- Total harmonic distortion is measured by the digital spectrum analyzer.

MEMO

WARNING:

TO REDUCE THE RISK OF FIRE, ELECTRIC SHOCK OR PRODUCT DAMAGE, DO NOT EXPOSE THIS APPLIANCE TO RAIN, SPLASHING, DRIPPING OR MOISTURE.

CAUTION!

DO NOT INSTALL, OR PLACE THIS UNIT, IN A BOOKCASE, BUILT-IN CABINET OR IN ANOTHER CONFINED SPACE. ENSURE THE UNIT IS WELL VENTILATED. TO PREVENT RISK OF ELECTRIC SHOCK OR FIRE HAZARD DUE TO OVERHEATING, ENSURE THAT CURTAINS AND ANY OTHER MATERIALS DO NOT OBSTRUCT THE VENTILATION VENTS.

SUOMI**VAROITUS:**

TULIPALO-, SÄHKÖISKUVAARAN TAI MUUN VAHINGON VÄHENTÄMISEKSI EI LAITETTA SAA ALTISTAA SATEELLE, ROISKEELLE, VESIPISAROILLE TAI KOSTEUDELLE.

VAROITUS!

ÄLÄ ASENNATA TAI LAITA TÄTÄ LAITETTA KABINETTITYYPPISEEN KIRJAKAAPPIIN TAI MUUHUN SULJETTUUN TILAAN, JOTTA TUULETUS ONNISTUISI. VARMISTA, ETTÄ VERHO TAI MIKÄÄN MUU MATERIAALI EI HUONONNA TUULETUSTA, JOTTA VÄLTETTÄISIIN YLIKUUMENEMISESTA JOHTUVA SÄHKÖISKU- TAI TULIPALOVAARA.

NORSK**ADVARSEL:**

FOR Å REDUSERE FAREN FOR BRANN, STRØMSJOKK ELLER SKADER PÅ PRODUKTET, MÅ DETTE APPARATET IKKE UTSETTES FOR REGN, VANNSPRUT, VANNDRÅPER ELLER FUKTIGHET.

ADVARSEL!

APPARATET MÅ IKKE Plasseres i en bokhylle, et innebygget kabinet eller et annet lukket sted hvor ventilasjonsforholdene er utilstrekkelige. SØRG FOR AT GARDINER ELLER lignende ikke forverrer ventilasjonsforholdene, SÅ RISIKO FOR ELEKTRISK SJOKK ELLER BRANN FORÅRSAKET AV OVERHETING UNNGÅS.