

SunBriteTV[®]

All-Weather Outdoor LCD Television

Operator's Manual



Model SB-2220HD

Important Safety Instructions

Dear SunBriteTV Customer:

Congratulations on the ownership of Model 2220HD all-weather outdoor LCD TV, and welcome to the family of satisfied SunBrite customers. You are in great company with thousands of homeowners and esteemed commercial facilities such as Yankee Stadium, Fenway Park, Disney World, and Sea World who have trusted us to deliver superior performance, lasting durability and the enjoyment of superb television viewing in the great outdoors.

With a traditional sense of customer satisfaction and attention to detail, our products are designed to withstand the rigors of the outdoor environment and provide our customers with many years of optimum viewing.

To ensure safety and long product life, please read the Important Safety Instructions and complete manual carefully before using the TV. If you have any questions about the installation procedures, please contact our qualified SunBriteTV Customer Support Team at 800.331.4626.

IMPORTANT SAFETY INSTRUCTIONS

- 1) Read these instructions, and keep them for future use.
- 2) Heed all warnings and follow all instructions.
- 3) Do not block any ventilation openings. Install in accordance with the manufacturer's instructions.
- 4) Do not install near any heat sources such as radiators, heat registers, stoves, or other apparatus (including amplifiers) that produce heat.
- 5) Do not defeat the safety purpose of the polarized or grounding-type plug. A polarized plug has two blades with one wider than the other. A grounding type plug has two blades and a third grounding prong. The wide blade or the third prong are provided for your safety. If the provided plug does not fit into your outlet, consult an electrician for replacement of the obsolete outlet.
- 6) Protect the power cord from being walked on or pinched particularly at plugs, convenience receptacles, and the point where the cord exits from the apparatus.
- 7) Only use attachments/accessories specified by the manufacturer.
- 8) Use only the cart, stand, tripod, bracket or table specified by the manufacturer, or sold with the apparatus. When a cart is used, use caution when moving the cart/apparatus combination to avoid injury from tip-over.
- 9) Unplug this apparatus during lightning storms.
- 10) Refer all servicing to qualified service personnel. Servicing is required when the apparatus has been damaged in any way, such as power-supply cord or plug is damaged, liquid has been spilled or objects have fallen into the apparatus, does not operate normally, or has been dropped.

PORTABLE CART WARNING



WARNING: TV must be plugged into a GFCI receptacle. TV and GFCI RECEPTACLE MUST BE INSTALLED NO LESS THAN 5 FEET FROM ANY BODY OF WATER (SUCH AS POOL OR SPA). Check local building codes for proper installation guidelines.

WARNING: This unit is equipped with a 3-pin grounded plug. The plug will only fit into a grounded power outlet. This is a safety feature. If you are unable to insert the plug into the outlet, contact your electrician. Do not alter this plug, as this will defeat the safety feature.

WARNING: The main plug is used as the disconnect device and shall remain readily operable.

WARNING: This product shall be connected to a mains socket outlet with a protective earthing connection.

CAUTION: TO PREVENT ELECTRIC SHOCK, MATCH WIDE BLADE OF PLUG TO WIDE SLOT, FULLY INSERT.

WARNING: FCC Regulations state that any unauthorized changes or modifications to this equipment not expressly approved by the manufacturer could void the user's authority to operate this equipment.

NOTE TO CATV SYSTEM INSTALLER: This reminder is provided to call the CATV system installer's attention to Article 820-40 of the National Electrical Code that provides guidelines for proper grounding and, in particular, specifies that the cable ground shall be connected to the grounding system of the building, as close to the point of cable entry as practical.

WARNING: To reduce the risk of fire or electric shock, do not expose the inside of this apparatus to rain or moisture.

This product utilizes tin-lead solder, and fluorescent lamp containing a small amount of mercury. Disposal of these materials may be regulated due to environmental considerations. For disposal or recycling information, please contact your local authorities or the Electronic Industries Alliance: www.eia.org.

Disclaimer: While SunBriteTV LLC intends to make this manual accurate and complete, we do not make claims that the information contained within covers all details, conditions or variations, nor does it provide for every possible contingency in connection with the installation or use of this product. The information contained in this manual may change without notice.

Cleaning Instructions: See "Care of SunBriteTV" on page 32





Attachments: Do not use attachments not specifically recommended by the manufacturer. Use of improper attachments can result in accidents.

Power Source: SunBriteTV must operate on a power source indicated on the specification label. If you are not sure of the type of power supply used in your home, consult your dealer or local power company. When using the TV outdoors, you must use a GFI-protected AC outlet with "in-use" waterproof cover.

Installation: Do not place the product on an unstable cart, stand, tripod, table, or anywhere the unit is not permanently installed. Placing the product on an unstable place can cause the product to fall, resulting in potential serious personal injuries, as well as damage to the product.

Precautions when Transporting the TV: Carrying the television requires at least two people.

WARNING: DO NOT IMMERSIVE TELEVISION IN WATER OR OTHER LIQUID. DO NOT INSTALL TV WITHIN 5 FEET OF BODY OF WATER (SUCH AS SPA OR POOL).

 CAUTION RISK OF ELECTRIC SHOCK. DO NOT OPEN.		 <p>The lightning flash with arrow-head symbol, within an equilateral triangle, is intended to alert the user to the presence of uninsulated "dangerous voltage" within the product's enclosure that may be of sufficient magnitude to constitute a risk of electric shock to persons.</p>
<p>CAUTION: TO REDUCE THE RISK OF ELECTRIC SHOCK, DO NOT REMOVE COVER (OR BACK), FROM THE TELEVISION OR EXTERNAL POWER PACK, EXCEPT WHERE SPECIFIED IN THE MANUAL. NO USER-SERVICEABLE PARTS INSIDE. REFER SERVICING TO QUALIFIED SERVICE PERSONNEL.</p>		<p>The exclamation point within a triangle is intended to alert the user to the presence of important operating and maintenance (servicing) instructions in the literature accompanying the product.</p>

FCC Statement

This equipment complies with the limits for a Class B digital device, pursuant to part 15 of the FCC Rules. These limits are designed to provide reasonable protection against harmful interference in a residential installation. This equipment generates, uses, and can radiate radio frequency energy and, if not installed and used in accordance with the instructions, may cause harmful interference to radio communications. However, there is no guarantee that interference will not occur in a particular installation. If this equipment does cause harmful interference to radio or television reception, which can be determined by turning the equipment off and on, the user is encouraged to try to correct the interference by one or more of the following measures:

1. Reorient or relocate the receiving antenna.
2. Increase the separation between the equipment and receiver.
3. Connect the equipment into an outlet on a circuit different from that to which the receiver is connected.
4. Consult the dealer or an experienced radio/TV technician for help.

Modifications not expressly approved by the manufacturer could void the user's authority to operate the equipment under FCC rules.

This device complies with part 15 of the FCC Rules. Operation is subject to the following two conditions:

1. This device may not cause harmful interference.
2. This device must accept any interference received, including interference that may cause undesired operation.

IMPORTANT SAFETY PRECAUTIONS

- If an outside antenna is connected to the television equipment, be sure the antenna system is grounded so as to provide some protection against voltage surges and built-up static charges. Section 810 of the National Electrical Code provides information with respect to proper grounding of the mast and supporting structure, grounding of the lead-in wire to an antenna discharge unit, size of grounding conductors, location of antenna discharge unit, connection to grounding electrodes, and requirements for the grounding electrode.

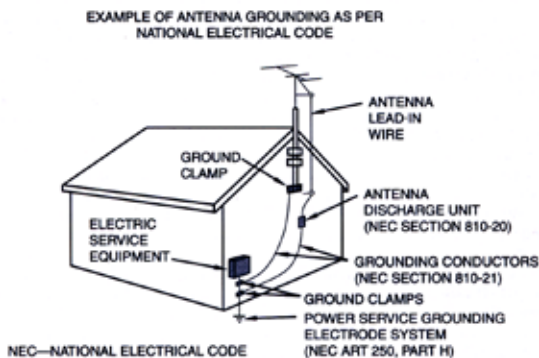

- For added protection for this television equipment during a lightning storm, or when it is left unattended and unused for long periods of time, unplug it from the wall outlet and disconnect the antenna. This will prevent damage to the equipment due to lightning and power-line surges.



- An outside antenna system should not be located in the vicinity of overhead power lines or other electric light or power circuits, or where it can fall into such power lines or circuits. When installing an outside antenna system, extreme care should be taken to keep from touching such power lines or circuits as contact with them might be fatal.



Important Safety Instructions

Ventilation: Adequate ventilation must be maintained to ensure reliable and continued operation and to protect the television from overheating. Do not block ventilation slots and openings with objects, or install the television in a place where ventilation may be hindered. There must be at least 1.5" of space on all sides.

Power cord protection: The power cord must be routed properly to prevent people from stepping on it, or objects from resting on it. Check the cords at the plugs and product.

Power source: This product must operate on a power source specified on the specification label. If you are unsure of the type of power supply used in your home, consult your dealer or local power company.

Do not let metal pieces or objects of any kind fall into the television from ventilation holes. High voltage flows in the product, and inserting an object can cause electric shock and/or short internal parts.

Do not mount SunBriteTV near a motor or transformer where strong magnetism is generated. Images on the television will become distorted and the color irregular.

Do not mount SunBriteTV near heat sources such as radiators, heaters, stoves and other heat-generating products (including amplifiers).

Do not submerge SunBriteTV in water: The SunBriteTV will resist water exposure from normal rain, sprinklers, garden hoses, etc.; However, it is not designed to be submerged in water.

Do not pressure-wash SunBriteTV: SunBriteTV will resist water exposure from normal rain, sprinklers, garden hoses, etc.; However, it is not designed to withstand pressure washers, high-pressure water jets, or hurricane-type weather.

Do not service SunBriteTV yourself: Removal of the television screen cover may expose you to high voltage or other dangerous risks. Refer all servicing to a qualified service professional. Warranty will not be honored if you service the unit yourself.

Repair: If any of the following conditions occurs, unplug the power cord, and call a qualified service professional to perform repairs:

When power cord or plug is damaged.

When objects have fallen into the product.

If unit was submerged in water or pressure-washed.

When product does not operate properly as described in the operating instructions. Do not touch the controls other than as described in the operating instructions. Improper adjustments of controls not described in the instructions can cause damage, which can require extensive repair work by a qualified technician.

When the product has been dropped or damaged.

When the product displays an abnormal condition. Any noticeable abnormality in the product indicates that the product needs servicing.

Replacement parts: In case the product needs replacement parts, make sure that the service person uses replacement parts provided by SunBriteTV. Use of unauthorized parts can result in fire, electric shock and/or other danger.

Safety checks: Upon completion of service or repair work, ask the service technician to perform safety checks to ensure that the product is in proper operating condition.

Table of Contents

Important Safety Instructions	2
Table of Contents	5
Supplied Accessories	6
TV Installation	
Choose a Location for the TV	7
Detachable Speaker Module Installation	8
Rear Panel Internal Connect Source	9
Rear Panel Connections	10
IR Emitter Connections	18
Side Panel and Front Panel Controls	19
Remote Control Guide	20
On-Screen Display Controls	21
Adjusting On-Screen Displays	21
Picture Menu	22
Sound Menu	23
Setting Menu	24
Channel Menu	29
Trouble Shooting	31
Care of SunBriteTV	32
Specifications	33
Features Information and Instructions	
Extreme Climate Warning	34
Programming Other Manufacturers' Universal Remote Control Devices	34
SunBriteTV Pixel Quality Policy	34
Appendix A - RS232 Control Cable Pinout	34
Appendix B - RS232 Control Codes	35

Supplied Accessories

Unpacking

After unpacking the SunBriteTV television, please make sure that the following items are included in the carton and that they are in good condition. If items are damaged or missing, contact your dealer immediately.

SunBriteTV LCD Television Model 2220HD

Remote Control with Batteries

Operator's Manual

Table Stand Installation Kit



Model 2220HD



Operator's
Manual



Water-Resistant
Wireless Remote
Control with
Batteries

● Small Plastic Plug in the event
the Speaker Module is removed

TV Installation - Choose a Location for the TV

Choose a Location for the TV

Important: The TV must be installed at least 5 feet from pool, spa, or other body of water.

The TV should be installed so the screen is not facing direct sunlight, or can be easily turned away from direct sunlight.

Ideal placement is in an area where the TV is shaded by trees, landscape and/or structures, or under a patio cover or gazebo.

If the sun shines directly on the screen for long periods of time, dark areas may develop on the screen. This is a normal reaction for the LCD panel, and will not cause damage to the screen. Either turn the screen away from the sun, or apply shade to the TV, and the dark areas will quickly disappear.

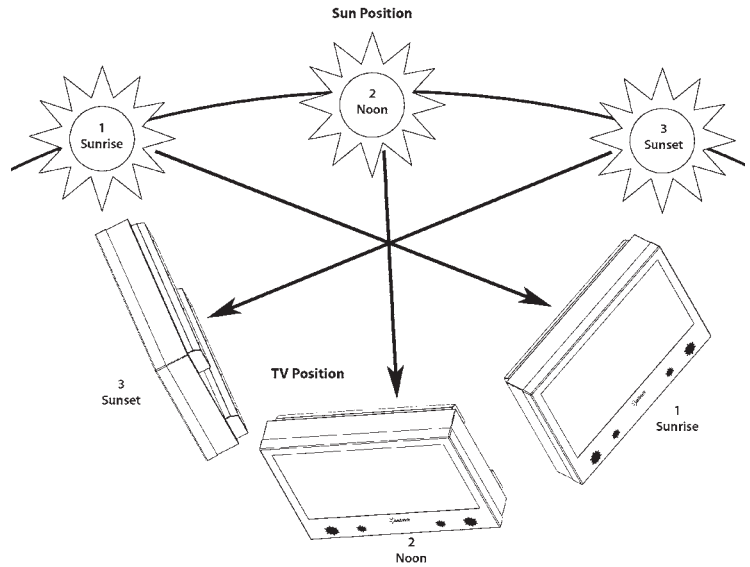

TV Installation - Detachable Speaker Module Installation

Removing the Detachable Speaker Module

This model is shipped with the speaker module attached to the TV. Follow these instructions if, for any reason, you wish to remove the speaker module.

Tools Needed: Phillips screwdriver, Plastic Plug that is packaged in the Operator's Manual plastic envelope.

Note: If you plan to mount the TV on the Table Stand or wall mount, it is best to remove the *Detachable Speaker Module first*.

1. Prepare a flat work surface, free of any debris or items which may scratch the front surface of the TV.
2. Lay the TV face-down on the work surface with the bottom of the unit closest to you
3. Position the TV so that the bottom edge overhangs the table by about one inch.
4. Unscrew the Speaker Module Pan Head Screws on the bottom edge of the TV, that attach the Speaker Module to the TV (Figure 2)

WARNING: Always replace Speaker Module Mounting Screws. Failure to do so will allow water to seep inside your TV. This can cause serious injury and can damage your TV.

4. Gently remove the Speaker Module away from the TV. Note that the Speaker Module Cable Connector is connected to the TV Cable Connector (Figure 3).
5. Disconnect the Speaker Module Cable Connector from the TV Cable Connector (Figure 3-A).
6. Push the TV Cable Connector back into the TV (Figure 4).

7. Push the Plastic Plug (found in Operators Manual Plastic Envelope) into the hole (Figure 5).

WARNING: Make sure the plastic plug is put in the hole securely. Failure to do so will allow water to seep inside your TV. This can cause serious injury and can damage your TV (Figure 6.)

Figure 1

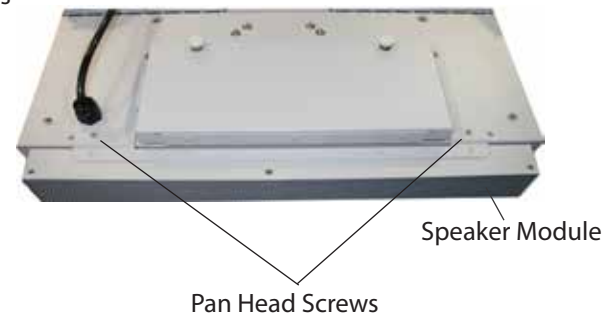

Unscrew the two Speaker Module Pan Head Screws

Figure 2



Figure 3



Figure 3-A



Figure 4



Figure 5



Figure 6



TV Installation – Rear Panel Internal Connect Source

WARNING: Do not connect the power source before making connections.

Internal Connect Source

The Internal Connect Source allows you to easily connect to the Audio, Video, S-Video, SVGA, HDMI, Audio Out, and RF connectors. The Internal Connect Source is inside the Cable Cover located on the back of the unit (Figure 1).

1. Unscrew the two gray Thumb Screws (Figure 1), and pull the cover towards you.
2. Route the cables to the proper inputs, and place the cable cords over the Rubber Sealing Gasket (Figure 2).
3. Close the cover.
4. Press firmly on the cover, and screw the Thumb Screws tightly (Figure 3).

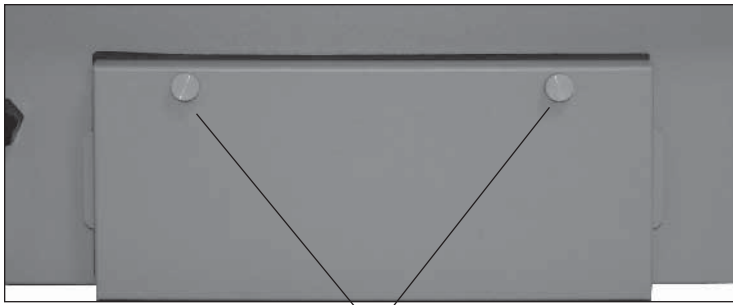

Figure 1

Thumb Screws



Figure 2

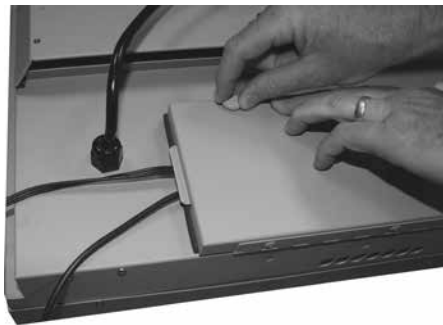

Figure 3

TV Installation - Connecting the Power Cord

Do not connect power cord until all cable connections have been made.

Connect the power cord to a GFCI protected AC outlet with an "in-use" waterproof cover.

WARNING:

TV AND GFCI RECEPTACLE MUST BE INSTALLED AT LEAST 5 FEET AWAY FROM STANDING WATER , SUCH AS (BUT NOT LIMITED TO) A POOL OR SPA.

TV Installation – Rear Panel Connections

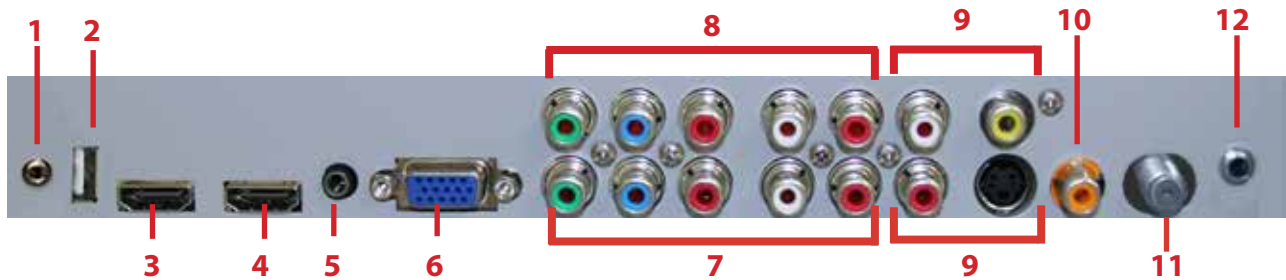

1. **SERVICE PORT** - This USB Service Port is for factory service only...do not use.
2. **SERVICE PORT** - This Service Port is for factory service only...do not use.
3. **HDMI 1** - Connects to devices that use HDMI cables such as Blu-ray or HD DVD player or HD cable / satellite set-top box. This connection port receives pure digital audio and high definition signal through one single cable. This connection port also can accept a HDCP video device for video or PC for monitor display usage. Use the SOURCE button to select HDMI1 on your MAIN SOURCE to view this connection. Please note: when using HDMI, your sound signal must be PCM for the TV to decode digital audio. When using this source for PC display, you must connect the audio cable to VGA Stereo Input for audio.
4. **HDMI 2** - Same as HDMI 1
5. **VGA STEREO INPUT** - This connection port is for people who want to provide audio to the TV when using a PC or a DVI video device. Use a 3.5mm mini-jack audio cable (headphone jack) to provide audio for a HDCP enabled DVI video device or PCs with VGA or DVI connection.
6. **VGA** - This connection port connects to a PC for video using VGA cable. Be sure to connect your audio cable to the VGA Stereo input if you want sound out of the VGA video source. Use the SOURCE button to select VGA on your MAIN SOURCE to view this connection.
7. **COMPONENT 1 (Lower)** - This connection ports are for DVD players or satellite/cable set-top boxes that use component cables. From left to right, connect green, blue and red for video, and then connect white for left channel audio, red for right channel audio. Use the Source Button to select YPbPr1 to review this connection.
8. **COMPONENT 2 (Upper)** - his connection ports are for DVD players or satellite/cable set-top boxes that use component cables. From left to right, connect green, blue and red for video, and then connect white for left channel audio, red for right channel audio. Use the Source Button to select YPbPr2 to review this connection.
9. **AV 1 (CVBS or S-Video)** - Connects to devices that use composite or s-video cables such as VCR or camcorder or video game consoles. Connect the video portion with either the yellow connector or the S-Video connector. Do NOT connect both video connectors. Use the SOURCE button to select AV1 (CVBS) on your MAIN SOURCE if you are using the yellow plug for video, use the SOURCE button to select AV1 (S-Video on your MAIN SOURCE if you are using the S-Video connector to view this connection.
10. **DIGITAL AUDIO OUT** - This connection port is used for sending out audio signals to other audio devices such as stereo/surround sound receivers. The orange (SPDIF OUT) connector sends out either bit-stream or PCM digital sound signal to a home theater receiver with digital input.
11. **ATSC/NTSC/QAM** – This connection is for digital or analog cable without the cable box or over-the-airwave antennas. The tuner is a hybrid tuner that tunes to both analog and digital channels. This connection uses coaxial RF cable. For over- the airwave digital stations please check <http://www.antennaweb.org>.
12. **ANALOG AUDIO OUT (Variable)** - Used to connect headphones, stereo receivers and amplified speakers via a 3.5mm headphone jack.
13. **RS232** - For remote control using RS232 commands.
14. **IR WINDOW** - The Internal Infrared (IR) Control Window allows the TV to be controlled from a remote system using IR commands. (See installation instructions on page 18)
15. **12-VOLT OUT**

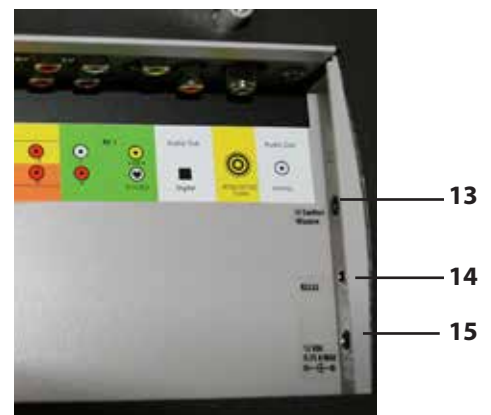

TV Installation – Rear Panel Connections

Connection Descriptions:

Port Quality & Name	Port Picture	Cable Used & Resolution	Devices that use this Port
Best HDMI (Digital HD Capable)		HDMI 1080i, 720p, 480p, 480i	Blu-ray DVD Player, HD-DVD Player, High Definition Cable or Satellite Set-top Box, HDCP devices
Best/Fair ATSC/NTSC (Digital HD Capable)		Coaxial RF 1080i, 720p, 480p, 480i	Antenna or Digital Cable with out the cable box
Best VGA (HD Capable)		VGA 1980 x 1080 or lower	PC or MAC with VGA connection
Better COMPONENT 1 & 2 (HD Capable)		Component 1080i, 720p, 480p, 480i	DVD Player, Video Game Console, High Definition Cable or Satellite Set-top Box
Good COMPOSITE (Non-HD)		S-Video 480i only	Non High Definition Cable or Satellite Set-top Box, S-Video VCR
Fair COMPOSITE (Non-HD)		Composite 480i only	Non High Definition Cable or Satellite Set-top Box, VCR, Old Game Console, Camcorder





Cable Descriptions:

Cable Name	Cable Picture
HDMI	
Coaxial RF	
VGA	
Component	 Red Green Blue
S-Video	
Composite	 Yellow
3.5 mm Mini-jack	 Green
RCA Audio	 Red White
AC Power	
Coaxial SPDIF	

TV Installation – Rear Panel Connections

Switching Sources for Ports:

This model offers several options when connecting your devices to the TV. The chart below will help you understand which source you switch to for each of the ports.

Port Picture	Cable Used	Source Name to Switch to
	HDMI or HDMI-DVI	HDMI 1 or HDMI 2
	COAXIAL RF	TV (CABLE / AIR)
	VGA	VGA
	YPBPR	YPBPR 1 or YPBPR 2
	S-VIDEO	AV 1 (S-VIDEO) or AV 2 (S-VIDEO)
	COMPOSITE	AV 1 (CBVS) or AV 2 (CVBS)

CONNECTING TO AN ANTENNA



Connecting to Digital Cable without Cable Box or Antenna

- 
1. Make sure the power to the TV is turned off.
 2. Connect the Coaxial RF cable from your antenna or digital cable to the ATSC/NTSC port off the back of the TV.
 3. Turn on the TV.
 4. Select TV (Air) for antenna or TV (Cable) for digital cable from either your remote control's source button or source button on the right side of the TV.
 5. Use the On-Screen Display to scan for channels.

Connecting to Cable or Antenna

- 
1. Make sure the power of the TV is turned off.
 2. Connect the Coaxial RF cable from your antenna or cable to the ATSC/NTSC port off the back of the TV.
 3. Turn on the TV.
 4. Select TV (Air) for antenna or TV (Cable) for cable from either your remote control's source button or source button on the right side of the TV.
 5. Use the On Screen Display to scan for channels.

Please Note :

1. Not all broadcasts are in High Definition (HD). Please refer to your local broadcasting stations for more information.
2. The TV's tuner is designed for HDTV therefore requires a stronger signal than normal TVs. If you cannot achieve that signal level with your antenna or cable, the TV might lose picture or sound.

TV Installation – Rear Panel Connections

CONNECTING TO AN ANTENNA--(Continued)

Connecting to Cable or Antenna through VCR

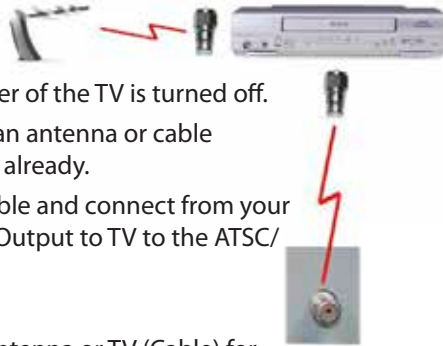

1. Make sure the power of the TV is turned off.
2. Make sure there is an antenna or cable connection to the VCR already.
3. Use a Coaxial RF cable and connect from your VCR's Antenna Out or Output to TV to the ATSC/NTSC port of your TV.
4. Turn on the TV.
5. Select TV (Air) for antenna or TV (Cable) for digital cable from either your remote control's source button or source button on the TV.
6. Use the On-Screen Display to scan for channels.

Please Note :

1. Some VCRs must be turned On before its output will have a signal to the TV. Please consult your VCR manual for further reference.
2. Not all broadcasts are in High Definition (HD). Please refer to your local broadcasting stations for more information.
3. This tuner is designed for HDTV therefore requires a stronger signal than normal TVs. If you cannot achieve that signal level with your antenna or cable, the TV might lose picture or sound.
4. This TV will turn off automatically if there's no signal present for more than 15 minutes.

CONNECTING TO A DVD PLAYER

Connecting with HDMI (Best)



1. Make sure the power of the TV and your DVD player is turned off.
2. Connect a HDMI cable to the HDMI port of your DVD player and the other end to the HDMI port off the back of your TV.
3. Turn on the TV and your DVD player.
4. Use the remote control's source button or the source button on the TV to switch to HDMI.

Please Note :

Refer to the DVD player's manual to make sure the DVD player is configured to output correctly to the TV.

Please Note :

1. Refer to the DVD player's manual to make sure the DVD player is configured to output correctly to the TV.
2. This TV does not decode Bit stream digital audio, so make sure the DVD is setup for PCM digital audio through HDMI.
3. If HDMI 1 is occupied, use HDMI 2 as your connection port.

Connecting with Component (Better)



1. Make sure the power of TV and your DVD player is turned off.
2. With a Component Cable, connect the green connector to the DVD player and Component 1's green connector port on the TV.
3. Connect the blue color connector to your DVD player and Component 1's blue connector port on the TV.
4. Connect the red color connector to both your DVD player and Component 1's red connector port on the TV.
5. With an RCA Audio Cable, connect the white color connector to both your DVD player and Component 1's white connector port on the TV.
6. Connect the red color connector to both your DVD player and Component 1's red connector port on the TV.
7. Component 1's red connector port on the TV.
8. Turn on the TV and your DVD player. Use the remote control's source button or the source button on the TV to switch to YPbPr1.

Please Note :

1. If Component 1 is already occupied, please use Component 2 as your connection port and switch to source YPbPr2.
2. Refer to the DVD player's manual to make sure the DVD player is configured to output correctly to the TV.
3. This TV will turn off automatically if there's no signal present for more than 15 minutes.

TV Installation – Rear Panel Connections

CONNECTING TO A DVD PLAYER (Continued)

Connecting with S-Video (Fair)

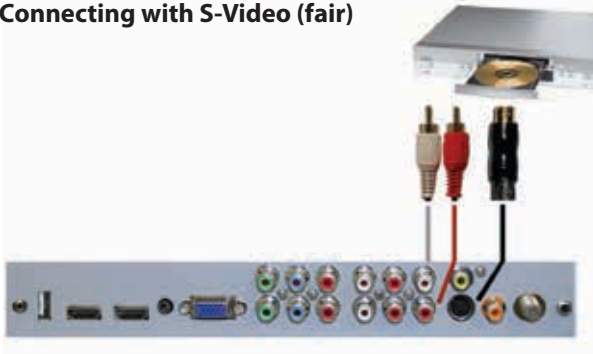

1. Make sure the power of the TV and your DVD player is turned off.
2. Obtain an S-Video Cable. Connect the S-Video connector to both your DVD player and Composite's S-Video connector port off the back of your TV.
3. Obtain a RCA Audio Cable. Connect the white color connector to both your DVD player and Composite's white connector port off the back of your TV.
4. Connect the red color connector to both your DVD player and Composite's red connector port off the back of your TV.
5. Turn on the TV and your DVD player.
6. Use the remote control's source button or the source button on the right side of the TV to switch to AV1 (S-Video).

Connecting with Composite (Fair)



1. Make sure the power of the TV and your DVD player is turned off.
2. Obtain a Yellow Video Cable. Connect the Yellow Video connector to both your DVD player and Composite's Yellow Video connector port off the back of your TV.
3. Obtain a RCA Audio Cable. Connect the white color connector to both your DVD player and Composite's white connector port off the back of your TV.
4. Connect the red color connector to both your DVD player and Composite's red connector port off the back of your TV.
5. Turn on the TV and your DVD player.
6. Use the remote control's source button or the source button on the right side of the TV to switch to AV1 (CVBS).

Please note:

1. If AV 1 is already occupied, use AV2, as your connection port, and switch source to AV 2 (S-Video)
2. Reference the DVD player's manual to make sure the DVD player is configured to output correctly to the TV.
3. This TV will turn off automatically if there's no signal present for more than 15 minutes.

TV Installation – Rear Panel Connections

CONNECTING TO A SATELLITE OR CABLE SET-TOP BOX

Connecting with HDMI (Best)

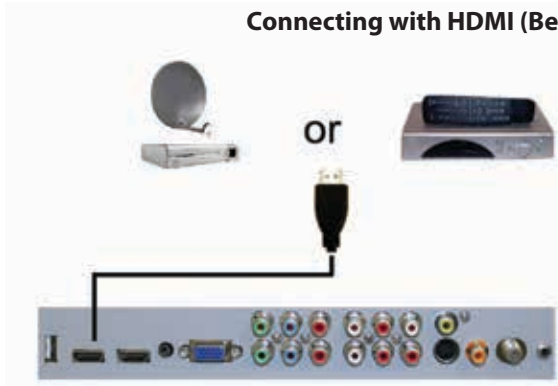

1. Make sure the power of the TV and your set-top box is turned off.
2. Connect a HDMI cable to the HDMI output of your set-top box and the other end to the HDMI port off the back of your TV.
3. Turn on the TV and your set-top box.
4. Use the remote control's source button or the source button on the right side of the TV to switch to HDMI 1.

Please Note :

1. Refer to the set-top box's manual, to make sure the set-top box is configured to output correctly to the TV.
2. If HDMI 1 is already occupied, use HDMI 1 as your connection port and switch source to HDMI 2.
3. This SunBriteTV model supports SONY's universal remote code. If SunBriteTV is not listed in the manufacturer list, look up SONY's codes in your universal remote's hand book.
4. This TV will turn off automatically if there's no signal present for more than 15 minutes.

Connecting with Component (Better)

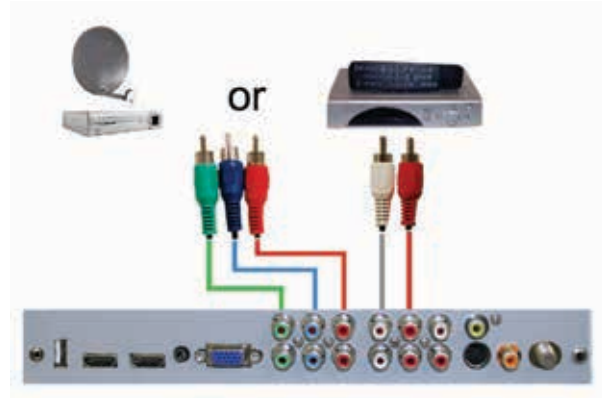

1. Make sure the power of TV and your set-top box is turned off.
2. Obtain a Component Cable. Connect the green color connector to both your set-top box and Component 1's green connector port off the back of your TV.
3. Connect the blue color connector to both your set-top box and Component 1's blue connector port off the back of your TV.
4. Connect the red color connector to both your set-top box and Component 1's red connector port off the back of your TV.
5. Obtain a RCA Audio Cable. Connect the white color connector to both your set-top box and Component 1's white connector port off the back of your TV to the right side of your green, blue, red component connection.
6. Connect the red color connector to both your set-top box and Component 1's red connector port off the back of your TV to the right side of your green, blue, red component connection.
7. Turn on the TV and your set-top box.
8. Use the remote control's source button or the source button on the TV to switch to YPbPr1.

Please Note :

1. If Component 1 is already occupied, please use Component 2 is your connection port and switch to source YPbPr2.
2. Please refer to the set-top box's manual to make sure the set-top box is configured to output correctly to the TV.
3. This SunBriteTV model supports SONY's universal remote code. If SunBriteTV is not listed in the manufacturer list, look up SONY's codes in your universal remote's hand book.
4. This TV will turn off automatically if there's no signal present for more than 15 minutes.

TV Installation – Rear Panel Connections

CONNECTING TO A SATELLITE OR CABLE SET-TOP BOX (Continued)

Connecting with S-Video (Fair)

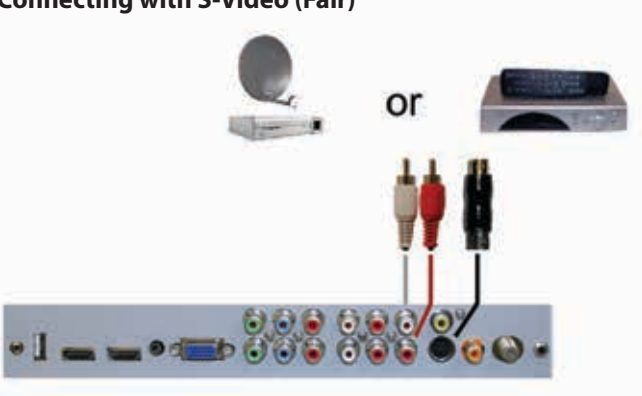

1. Make sure the power of the TV and your set-top box is turned off.
2. Obtain an S-Video Cable. Connect the S-Video connector to both your set-top box and Composite's S-Video connector port off the back of your TV.
3. Obtain a RCA Audio Cable. Connect the white color connector to both your set top box and Composite's white connector port off the back of your TV.
4. Connect the red color connector to both your set top box and Composite's red connector port off the back of your TV.
5. Turn on the TV and your set top box.
6. Use the remote control's source button or the source button on the right side of the TV to switch to AV1 (S-Video).

Please Note :

1. If AV 1 is already occupied, use AV 2 as your connection port and switch source to AV 2 (S-Video).
2. Refer to the set-top box's manual to make sure the set-top box is configured to output correctly to the TV.
3. This SunBriteTV model supports SONY's universal remote code. If SunBriteTV is not listed in the manufacturer list, look up SONY's codes in your universal remote's hand book.
4. This TV will turn off automatically if there's no signal present for more than 15 minutes.

Connecting with Composite (Fair)

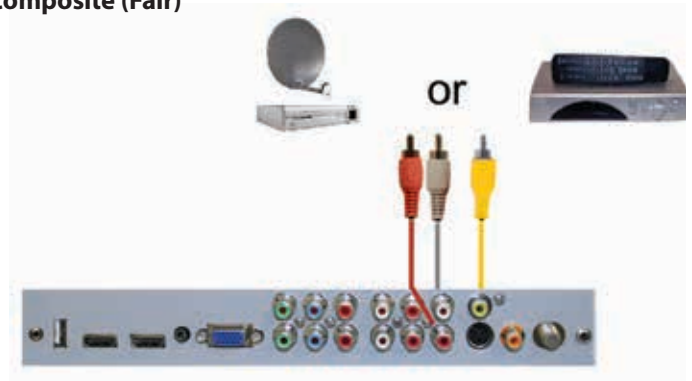

1. Make sure the power of the TV and your set top box is turned off.
2. Connect a Yellow Video connector to both your set top box and Composite's Yellow Video connector port off the back of your TV.
3. Connect a white color connector to both your set top box and Composite's white connector port off the back of your TV.
4. Connect the red color connector to both your set top box and Composite's red connector port off the back of your TV.
5. Turn on the TV and your set top box.
6. Use the remote control's source button or the source button on the right side of the TV to switch to AV1 (CVBS).

Please Note :

1. If AV 1 is already occupied, use AV 2 as your connection port and switch source to AV 2 (S-Video).
2. Refer to the set-top box's manual to make sure the set-top box is configured to output correctly to the TV.
3. This SunBriteTV model supports SONY's universal remote code. If SunBriteTV is not listed in the manufacturer list, look up SONY's codes in your universal remote's hand book.
4. This TV will turn off automatically if there's no signal present for more than 15 minutes.

TV Installation – Rear Panel Connection Diagrams

CONNECTING TO AN EXTERNAL AMPLIFIER OR AMPLIFIED SPEAKERS

Connecting with Coaxial SPDIF Digital (Best)



1. Make sure the power of the TV and your receiver is turned off.
2. Obtain a Coaxial SPDIF cable, connect it to your receiver's coaxial SPDIF digital input and the Coaxial SPDIF connection on the LINE OUT port off the back of the TV.
3. Turn on the TV and your receiver.

Please Note :

1. If you want pure digital stream for your receiver to decode, you must also configure the TV's OSD Sound->Digital Audio Out function. Make sure the option is on Bit Stream.
2. If your receiver is making static noises when receiving Bit Stream, you must use the PCM option instead.
3. Refer to the receiver's manual to make sure the receiver is configured to receive signals correctly from the TV

Connecting with RCA Audio Analog (Good)



1. Make sure the power of the TV and your receiver is turned off.
2. Obtain a 3.5mm stereo/audio cable (if your amplifier audio connection requires RCA audio out jacks you will need to obtain an 1/8" Stereo Mini Plug to RCA adapter cable). Connect it to your receiver's audio input connection and the 3.5mm stereo/audio connection on the Analog Audio port on the back of the TV.
3. Turn on the TV and your receiver.

Please Note :

1. If you want pure digital stream for your receiver to decode, you must also configure the TV's OSD Sound->Digital Audio Out function. Make sure the option is on Bit Stream.
2. If your receiver is making static noises when receiving Bit Stream, you must use the PCM option instead.
3. Stream, you must use the PCM option instead.
4. Refer to the receiver's manual to make sure the receiver is configured to receive signals correctly from the TV

CONNECTING TO A PC

Connecting with DVI Digital (Best)



1. Make sure the power of the TV and your receiver is turned off.
2. Obtain a HDMI to DVI conversion cable; connect the DVI side of the conversion cable to the DVI output of your PC, and the HDMI side of the conversion cable to the HDMI port off the back of TV.
3. Obtain a 3.5 mm Mini-jack, connect to the audio out of your PC and the other end to the VGA Stereo Input Port.
4. Turn on the power to the TV and the PC.
5. From the remote control's source button, or the Source button from the TV's panel, switch to HDMI.

Please Note :

1. For the best picture, set your PC resolution to 1920 x 1080 at 60 Hz. Refer to the PC or graphic card manual for further instructions on how to set your resolution and refresh rate.
2. Refer to your PC manual for video output requirements of the video card.
3. The TV will turn off automatically if there's no signal present for more than 15 minutes.
4. If HDMI 1 is already occupied, use HDMI 2 as your connection port, and switch source to HDMI 2.

Continued on next page

TV Installation – Rear Panel Connection Diagrams

CONNECTING TO A PC (Continued)

Connecting with VGA Analog (Good)



1. Make sure the power of the TV and your PC is turned off.
2. Obtain a 15-pin D-Sub VGA cable, connect to the VGA output of your PC and the other end to the VGA port off the back of your TV.
3. Obtain a 3.5 mm Mini-jack, connect to the audio out of your PC and the other end to the VGA Stereo Input port.
4. Turn on the power of the TV and your PC.
5. Use the remote control's source button or the source button the TV to switch to VGA.

Please Note :

1. For the best results, please set your PC resolution to
2. 1920 x 1080 at 60 Hz. Refer to the PC or graphic card's manual for further instructions on how to set your resolution and refresh rate.
3. Refer to your PC manual for video output requirements of the video card.
4. The VGA port of the TV features a power saving mode which will automatically turn off the TV if there is no signal provided for more than 15 minutes.

IR Emitter Installation

To install the IR Emitter:

The photo to the right shows an IR Emitter* installed.

The end of the Emitter is to be mounted in front of the IR Emitter Window.

Place the emitter on the white tie-down block and use the tie-down to secure it in place.

Place the emitter cable over the right or left side of the cable box and connect the other end of the emitter to the appropriate control block*.

** Neither the emitter or control block are supplied by SunBriteTV. See instructions that come with your IR Emitter and control block to determine how to make the connections.*

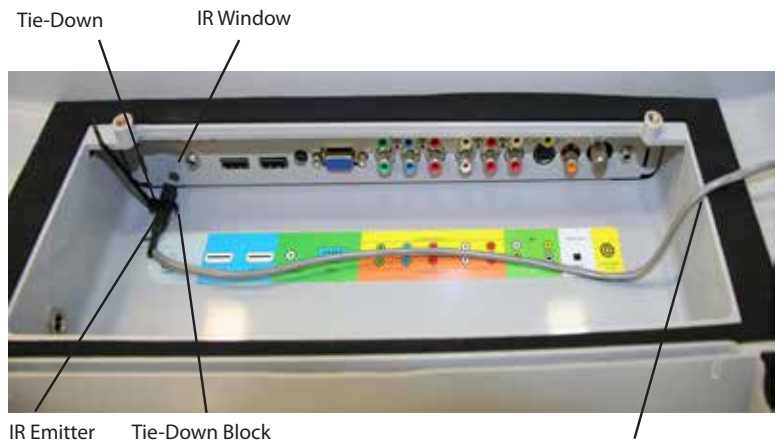

Place IR Emitter Cable over right or left side of the cable box.

TV Installation--Side Panel and Front Panel Controls

Connecting the Power Cord

WARNING:

TV AND GFCI RECEPTACLE MUST BE INSTALLED AT LEAST 5 FEET AWAY FROM STANDING WATER , SUCH AS (BUT NOT LIMITED TO) A POOL OR SPA.

Connect the power cord after you have made connections to your video equipment.



Connect the power cord to a GFCI-protected AC outlet with "in-use" waterproof cover.

Warning: TV must be installed at least 5 feet away from standing water, such as (but not limited to) a pool or spa.

Side Panel



Power	Turns TV on/off.
Input	Press to change the input sources.
Menu	Displays the On-Screen Display (OSD) menu. In OSD menu, press key to return to pre-phase.
CH+/CH-	Adjusts channels. In OSD menu, both keys are used to navigate within the menu.
Vol+ /Vol-	Adjusts volume. In OSD menu, both keys are used to navigate within menu. Vol+ is used to select the highlighted options.

Front Panel



IR Sensor

Remote Control Guide



ON – Powers the TV On.

OFF – Powers the TV Off.

0~9 – Allows you to set the channels directly. To access a digital channel, use these buttons with the (-) button to switch channels.

Dash (-) – Insert the dash for selecting digital channels directly.

R – Returns to the previous channel.

FREEZE – Freezes the TV picture. Press the button again to unfreeze the picture.

SLEEP – Sets time for the TV to turn Off.

CC – Selects Closed Caption (CC only works under sources TV, AV1 and AV2.)

V+ – Functions the Volume Up.

V- – Functions the Volume Down.

MUTE – Mutes the TV's Audio.

MENU – Opens / Exits the TV menu.

CH+ – Functions the Channel Up.

CH- – Functions the Channel Down.

MTS – Selects stereo, mono, or second audio programming.

↑ / ↓ / ← / → / – Allow you to navigate inside the OSD menu. They also function as CH+/- and Vol +/-.

↵ – Allows you to select functions inside the OSD menu, acts as the Enter button for OSD menu for changing channels.

SOUND – Selects various preset sound settings.

EXIT – Exits the TV menu.

PICTURE – Selects various preset picture settings.

GUIDE – Opens the current digital channel information guide.

SOURCE – Cycles between different input sources of the TV.

INFO – Shows current channel information, display input and resolution.

SHIFT – Used with the 0-9 numeric pad to select inputs

ASPECT – Selects different screen sizes

FAVORITE – Cycles the favorite channels.

FAVORITE ADD / DEL – Adds or deletes the current channel from the favorites channel list.

The following functions (*illustrated with bold squares on the remote*) are not applicable to this TV:

SRS

DNR

ADD/Del

CH Lock

The **Picture In Picture/Picture On Picture** functions Audio, Video, Source, On/Off, Size and Pos

About the Water-Resistant Remote Control

The SunBriteTV Water-Resistant Remote Controller is engineered to give you many years of service.

“Water-resistant” means that the remote control can be in water for short periods of time without damaging the internal workings of the unit. It can be left in the rain, and even dropped in water, as long as it is retrieved quickly. **The remote control should not be left floating in water.**

The functionality of the remote control is under warranty for one year. If the remote control malfunctions within the one-year warranty period, replace the batteries with new long-life alkaline batteries.

If the problem is not solved with new batteries, contact the SunBriteTV Customer Care Center. SunBriteTV will repair or replace the remote control at SunBriteTV's option.

If you have a warranty claim, contact the SunBriteTV Customer Care Center for further instructions.

800.331.4626

www.sunbrite.tv.com

Remote Control Guide

On-Screen Display Controls

Via Remote Control

In order to adjust most of the options inside the On Screen Display (OSD), the picture below shows all the buttons used on the remote control.



- This button functions as up direction in the OSD.
- This button functions as down direction in the OSD.
- This button functions as left direction in the OSD.
- This button functions as right direction in the OSD.
- This button changes the channel in conjunction with the number pad and also functions as enter for selecting options in the OSD.
- This button opens the OSD and also exits the OSD by going to the previous level of the OSD.
- This button exits the OSD entirely.

Via the TV's Side Panel Buttons

In order to provide more than one type of OSD control buttons, the side panel's buttons have also been made functional for adjusting the OSD.

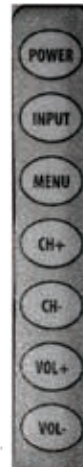

- MENU** – This button opens the OSD.
- CH(▲)** – This button changes the channel to a higher number and also functions as up direction in the OSD.
- CH(▼)** – This button changes the channel to a lower number and also functions as down direction in the OSD.
- VOL(+)** – This button decreases the volume and functions as left direction in the OSD. It also is used to select the highlighted options.
- VOL(-)** – This button decreases the volume and functions as right direction in the OSD.

On-Screen Display Menu

Your TV has been factory-set to plug-in and enjoy your programming. In the event you turn on the TV and get the message, "Please run Channel Auto Scan," press your remote's Menu button, press the Channel function and press Auto Scan.

Note: To run the Channel function, you must be in the TV Source. To access the TV source, click Input on the TV's side panel or Source button on the Remote Control. Press TV from the Input Select option.

PICTURE	SOUND	SETTING	CHANNEL
<p>Picture: This menu changes the picture settings for all ports, such as: Picture Mode, Contrast, Brightness, Color, Sharpness. Advanced Video controls: Color Temper, Zoom Mode, Noise Reduction and Adaptive Contrast</p>	<p>Audio: This menu manages the audio settings such as: Bass, Treble, Balance, AVC, Digital Output and Audio Language, etc.</p>	<p>Settings This menu manages: Parental Controls Time Closed Caption Menu Settings Language, and Transparency</p>	<p>Channel: This menu manages Channel functions such as: Scanning Channels, Editing Channels, Checking Signal Strength, etc.</p>

On-Screen Display Menu - Picture Menu

Picture Menu

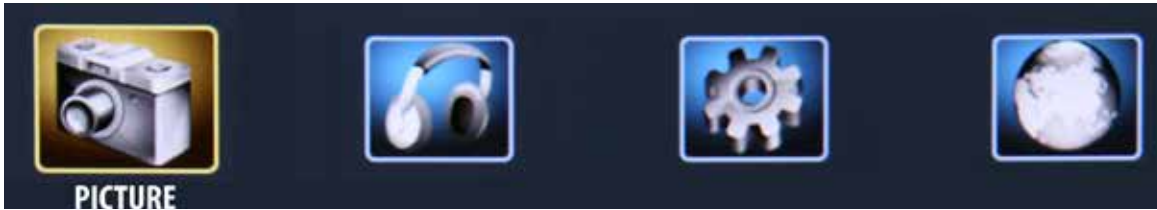

From the PICTURE menu you can adjust PICTURE MODE, CONTRAST, BRIGHTNESS, COLOR, TINT SHARPNESS, ADVANCED VIDEO.

1. Press ▼▲ buttons to move the cursor to the item to be selected.
2. Press ◀▶ buttons to make the desired adjustments.
3. When you are satisfied with your adjustments, press MENU or EXIT to exit the main menu.

Picture Menu



Picture Mode

Press ▼▲ buttons to Picture Mode, then use ◀▶ to adjust the Picture Mode such as Personal/Standard/Dynamic/Soft.

Contrast

Press ▼▲ buttons to Contrast, then use ◀▶ to adjust the contrast of the picture.

Brightness

Press ▼▲ buttons to Brightness, and use ◀▶ to adjust the brightness of the picture.

Color

Press ▼▲ button to Color, then use ◀▶ to adjust the color saturation.

Tint - Tint is not supported on this model.

Sharpness

Press ▼▲ buttons to Sharpness, then use ◀▶ to adjust the sharpness level of picture.

Advanced Video - (see below)

Press ▼▲ buttons to Advanced Video, then use ◀▶ to adjust the selections for: Color Temper, Zoom Mode, Noise Reduction, and Overscan and Adaptive Contrast.

Advanced Video



Press ▼▲ buttons to Color Temper, then use ◀▶ to select Personal/Nomal/Cool/Warm

Press ▼▲ buttons to Zoom Mode, then use ◀▶ to select Wide/Zoom/Cinema/Normal mode

Press ▼▲ buttons to Noise Reduction, then use ◀▶ to select Off/Weak/Middle/Strong/Auto

(Overscan is not available on this model.)

Press ▼▲ buttons to Adaptive Contrast, then use ◀▶ to select on/off to decide the function operation.

Adjusting On-Screen Displays – Sound Menu

Sound Menu



1. Press ▼▲ buttons to move the cursor to the item to be selected.
2. Press ◀▶ buttons to make the desired adjustments.
3. When you are satisfied with your adjustments, press MENU or EXIT to exit the main menu.

Sound Menu



Sound Mode

Allows you to choose your sound preferences. Press ▼▲ buttons to Sound Mode, then use ◀▶ to adjust the Sound Mode such as Custom/Standard/Music/Movie. Pressing Custom allows you to adjust the following:

Bass

Press ▼▲ buttons and then use ◀▶ button to increase or decrease the level of the Bass response.

Treble

Press ▼▲ buttons and then use ◀▶ buttons to increase or decrease the level of the Treble sounds.

Balance

Press ▼▲ buttons and then use ◀▶ buttons to adjust the audio output level between Left and Right Speakers.

Surround

Surround Sound is not supported on this model.

AVC - Automatic Volume Control

Press ▼▲ buttons and then use ◀▶ buttons to select AVC On or Off.

Digital Out

Press ▼▲ buttons and then use ◀▶ buttons to select Digital Out selection of PCM or RAW.

Audio Language

Press ▼▲ buttons to select one of the audio languages such as English/French/Spanish.

The language code must be programmed for this option to be available. If there is no selection it has not been programmed for this model.

Note: Digital Out and Audio Language are available only in DTV.

Adjusting On-Screen Displays – Setting Menu

Setting Menu

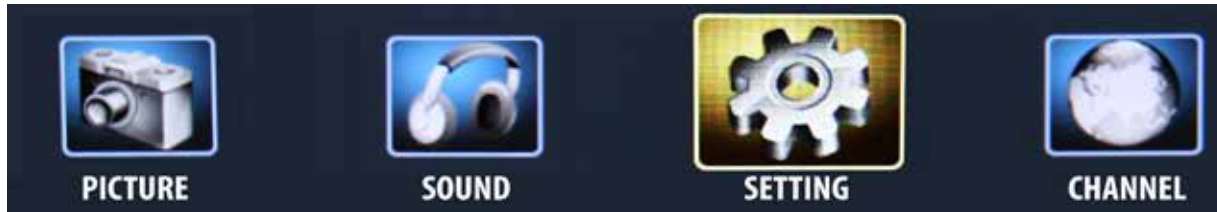

1. Press ▼▲ buttons to move the cursor to the item to be selected.
2. Press ► buttons to make the desired adjustments.
3. When you are satisfied with your adjustments, press MENU or EXIT to exit the main menu.

Setting Menu



Parental Controls

Press ▼▲ buttons to Parental Controls, then use ► button to change Parental Control settings. Follow sub-menu directions on following pages.

Time

Press ▼▲ buttons to Time, then use ► button to change Time settings. Follow sub-menu directions on following pages.

Closed Caption

Press ▼▲ buttons to Time, then use ► button to change Closed Caption settings. Follow sub-menu directions on following pages.

Menu Settings

Press ▼▲ buttons to Menu Settings, then use ► button to change Menu settings. Follow sub-menu directions on following pages.

VGA Settings

Press ▼▲ buttons to Parental Controls, then use ► button to change VGA settings. Follow sub-menu directions on following pages. Note: VGA settings may not be available on this TV.

Restore Default

Press ▼▲ buttons to Restore Default, then use ► button to the Restore Default control panel.

Adjusting On-Screen Displays – Setting Menu

Parental Control



Change Password

The Parental Control Menu allows you to change programming options. To change settings, you must enter a password.

Press ▼▲ buttons to move the cursor to the Enter Password selection.

Press “Enter Password” to enter the password. (The default password is 0000.)

Press ► button to enter the Change Password submenu. Enter your old password, then enter the new password and confirm it. The password will be changed.

Note: If you change the password, write down the new password, and keep it in a safe place

Parental Control Sub-Menu



System Lock

The TV is set with the System Lock in the Off position. To turn the System Lock ON, press ▼▲ buttons and then use ◀▶ buttons to select system lock ON. When you do this, the menu options will light up.

The Menu Items are: Unrated Lock, US, Canada Reset RRT.

Unrated Lock

Press ▼▲ buttons and then use ◀▶ buttons to select system lock ON or OFF. When System Lock is ON, Unrated programming cannot be accessed

US

Press the ► button to enter the submenu list to set the US rating functions. (US Menu is on the next page.)

Adjusting On-Screen Displays – Setting Menu

Parental Control - US Menu



From the US Menu, press ▼▲ buttons to the TV function. Press ► button to enter the submenu shown below.

TV Menu



- TV-Y:** For all children
- TV-Y7:** For children above 7
- TV-G:** For anyone
- TV-PG:** Children can watch with guardian
- TV-14:** Need parent guide
- TV-MA:** Only for adult
- ALL:** Select all functions above
- FV:** Fantasy Violence
- L:** Language (abusive, sexual)
- S:** Sexual
- V:** Violence
- D:** Dialog (sexual)

MPAA



MPAA
From the US Menu, press ▼▲ buttons to block or unblock the following ratings:

- G
- PG
- PG-13
- R
- NC-17
- X.
- N/A (None)

Note: The cursor is set to rest on the N/A rating. As you press the ▲ button, you will automatically block each rating.

Adjusting On-Screen Displays – Setting Menu

Parental Control - Canada Menu

From the Parental Control submenu, press ▼▲ buttons to Canada, then press ► button for the Canada submenu.

Canada Menu



Canada English

Press the ◀▶ button to select one of C / C8+ / G / PG / 14+ / 18+.

Canada French

Press the ◀▶ button to select one of G / 8ans+ / 13ans+ / 16ans+ / 18ans+.

Time Sub-Menu



Sleep Timer

Press ▼▲ buttons to Sleep Timer, then use ◀▶ buttons to select the sleep timer. The options are: Off; 5Min; 10Min; 15Min; 30Min; 45Min; 60Min; 90Min; 120Min; 180Min; 240Min.

Time Zone

Press ▼▲ buttons to Time Zone, then use ◀▶ buttons to select the correct time zone. The options are: Alaska; Hawaii; Pacific; Mountain; Central; Eastern.

Daylight Saving Time

Press ▼▲ buttons and then use ◀▶ buttons to select Daylight Saving Time ON or OFF. When Daylight Saving Time is ON, the clocks are set one hour ahead of local standard time.

Clock

The time is decoded from the digital signal and displayed (such as DTV,HDMI)

This item is available only in English.

Adjusting On-Screen Displays – Setting Menu

Closed Caption

From the Setup Menu, press ▼▲ buttons to Closed Caption, then press ► button to enter the Closed Caption submenu shown below. To turn on the CC Mode.



Closed Caption Submenu

CC Mode

Press ▼▲ buttons and then use ◀▶ buttons to turn the CC Mode ON or OFF

Basic Selection

Press ▼▲ buttons and then use ◀▶ buttons to select setting options. The options are CC1 / CC2 / CC3 / CC4 / TEXT1 / TEXT2 / TEXT3 / TEXT4.

Advanced selection

Press ▼▲ buttons and then use ◀▶ buttons to select current zoom mode, the options are Service1 / Service 2 / Service 3 / Service 4 / Service 5 / Service 6.

Option

Press the ► button to enter the submenu list shown below.

Closed Caption-OptionSub-Menu



Closed Caption-OptionSub-Menu

Mode: Press ▼▲ keys to select either Default and Custom. If you set Automatic, the other choices are disabled and can't be adjusted.

Font Style: press ◀▶ keys to select one of the Defaults and from Font0 to Font7.

Font Size: press ◀▶ to select one of Default / Normal / Large / Small.

Font Edge Style: press ◀▶ keys to select one of Default / None/Raised/Depressed/Uniform/Left Shadow/Right Shadow.

Font Edge Color: press ◀▶ keys to select one of Default / Black / White / Red / Green / Blue / Yellow / Magenta / Cyan.

FG Color: press ◀▶ keys to select one of Default / White / Black / Red / Green / Blue / Yellow / Magenta / Cyan.

BG Color: press ◀▶ keys to select one of Default / Black / White / Red / Green / Blue / Yellow / Magenta / Cyan.

FG Opacity: press ◀▶ to select one of Default / Solid / Flashing / Translucent / Transparent.

BG Opacity: press ◀▶ to select one of Default / Solid / Flashing / Translucent /Transparent.

Menu Options

From the Setting Menu, press ▼▲ buttons to Menu Options, then press ► button to enter the Menu submenu shown below.



Menu Settings

Transparency

Press ▼▲ buttons to select Transparency, and then press ◀▶ buttons to select 0% / 25% / 50% / 75% / 100%

Menu Language

Press ▼▲ buttons to select Menu Language, and then press ◀▶ buttons to select English/French/Spanish

Adjusting On-Screen Displays – Channel Menu

Channel Menu

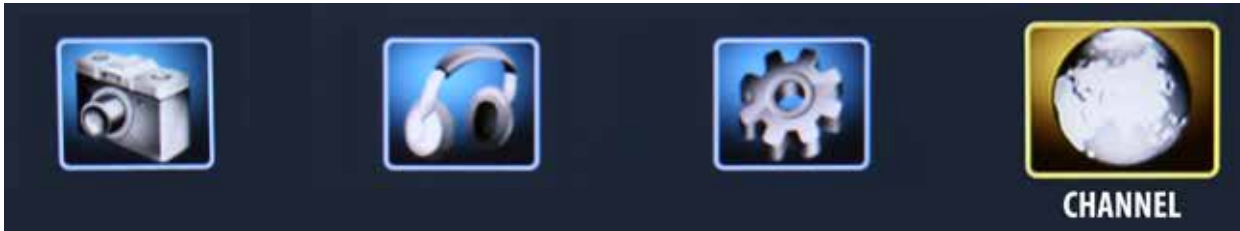

1. Press ▼▲ buttons to move the cursor to the item to be selected.
2. Press ◀▶ buttons to make the desired adjustments.
3. When you are satisfied with your adjustments, press MENU or EXIT to exit the main menu.



Channel Menu

The CHANNEL MENU can be used in the TV Source mode only.

To access the TV Source, click Input on the TV's side panel or the Source button on the Remote Control. Press TV from the Input Select option.

To search:

Air/Cable

Press ◀▶ buttons to select Air or Cable.

Auto Scan

Press the ▶ button to enter the submenu list below

Auto Scan



Cable system

Press the ◀▶ button to select the cable system.

Start to Scan

Press the ▶ button to start auto scan.

Adjusting On-Screen Displays – Channel Menu

Favorite



Favorite

From the Channel Menu, press the ▼▲ buttons to select Favorite. Press the ► button to enter the submenu shown at left.

Press ▼▲ keys to select channels, and press OK to add current channel to Favorite Channel Table.

Follow the same directions to delete a channel from the Favorite Channel Table.

Show/Hide Menu



Show/Hide

From the Channel Menu, press the ▼▲ buttons to select Show/Hide. Press the ► button to enter the submenu (shown left).

Press ▼▲ keys to your desired channel. Press OK to show or hide the specified channel.

If the channel is Hidden, user will be unable to see the channel by pressing CH+ or CH-. They can select the channel by pressing the channel number directly.

Channel Menu



From the Channel Menu, press the ▼▲ buttons to select the following functions:

Channel No.

Press the ◀▶ button to select the channel No.

Channel Label

Press the ► button to enter the submenu, where you can edit the channel label.

DTV Signal

This item shows current DTV signal strength.

Trouble Shooting

The following table contains the common problems and the solutions to these problems. Please check this list before you contact the technicians.

Trouble	Solutions
No picture	Check the following: Power cord is connected correctly. Power is turned on. The video cable is connected correctly. You have selected the proper input signal source. If you have done the above, without resolve, unplug TV for at least one hour to perform Hard Reset.
Abnormal colors	Match the colors on the cable to the connector. (Red cable to red colored port.)
Picture is too dark	Adjust your contrast, brightness and lamp settings from the OSD Menu
Audio only, no picture	Make sure both the Audio and Video cables are connected. The TV Tuner signal must not be lower than 65 per cent. Unplug TV for at least one hour to perform Hard Reset.
Picture only, no audio	Make sure the Audio cable is connected. Readjust your volume via the remote control. The TV Tuner signal must not be lower than 65 per cent.
Remote Control does not work	Turn off the TV, unplug it from the socket. Remove the batteries out of the remote for 30 minutes. Press the remote buttons and the power button randomly for two full seconds, then reinstall the batteries. The TV's remote sensor is housed in the same place as the power indicator light. Make sure there is line of sight from the remote control's first sensor to the remote sensor of the TV.
Cannot receive sufficient channels through the ATSC/NTSC Tuner	The TV's tuner signal must not be lower than 65 percent. Change the direction of your antenna and re-scan the channels. If you have cable, call the cable provider and ask to have your signal strength checked.
No color	Adjust your picture setup and make sure the saturation and the RGB are not turned all the way down.
Weak Signal or no program symbol on screen	The TV's tuner signal must not be lower than 65 percent. Change the direction of your antenna and re-scan the channels. If you have cable, call the cable provider and ask to have your signal strength checked.
TV's Universal Remote Code	This television follows SONY's universal remote code. If SunBriteTV is not listed in the manufacturer list, look up SONY's codes in your universal remote's hand book.
TV channels are blocked	Check the Auto Lock function settings on the OSD. Channels may have been locked previously.
The TV turns on or off slowly, and the screen shows up slowly	This is a High Definition liquid crystal display panel TV. It requires a few more seconds than normal TVs to power up and show the picture.
No sound to PC	Make sure you have a 3.5 mm mini-jack cable connected from your PC's sound output to the TV's VGA Stereo Input.
HDCP video says no HDCP support	Reboot your HDCP video device by turning it off, and unplugging the power cord. Wait up to 8 minutes to plug the power back in to see if that works.
HDCP video has no audio	Make sure you have a 3.5 mm mini-jack cable connected from your HDCP video device sound output to the TV's VGA stereo input. If your HDCP video device uses RCA audio jacks, you'll need to obtain a RCA audio converted into a 3.5 mm mini-jack cable.
Cannot get 1920 x 1080 from PC VGA	The screen's max resolution is 1920 x 1080. Your video card may not support this resolution. Check your video card's maximum resolution, and use that setting.
Picture is distorted or has an abnormal sound	This might be from interference from large electrical appliances, cars, motorcycles or fluorescent lights. If the TV is close to the wall, try moving the TV to another location to see if the problem still occurs.
Picture does not cover the entire screen	If you are using HDMI or a TV digital channel, use the Aspect button to switch to 16:9 format. If you are using VGA, use the AUTO ADJUST function to adjust to the screen. Note: If you are using regular analog TV, AV or component in 480i resolution, use the ASPECT button to switch to 16:9 in order to fill up the screen. However, this feature will distort the picture.

Trouble	Solutions
Picture quality is very poor	For best image quality, view HD wide screen programs. If HD content is not available, view "Standard Definition" from a digital source. Standard, analog TV will be noticeable inferior to HD quality.
Some pixels are always displaying the same color	SunBriteTV LCD screens are manufactured with rigorous standards to maintain optimal viewing. However, the LCD screen may have minor defects that appear as a small bright or dark pixel. This is common to all LCD screens used in display and television products, and is not specific to SunBriteTV. For more information, see SunBriteTV's Pixel Quality Policy in this manual.
Switching a channel or source changes the volume	Different channels and inputs sometimes have this effect because the channel signal's volume is pre-set.
There is noise or trash pixels on the screen	When your TV's resolution is higher than the digital channel's broadcast resolution, the signal is up-converted to match your TV's resolution. Up-converting can cause this kind of effect.
Tips for high-definition users	The TV is an ideal platform for viewing High-definition content. The best image quality can be achieved by HDMI, YPbPr (component), then VGA. However, due to variances in broadcast practices, it is possible that some image distortion may occur.
Tips for letterbox content users	Letterbox (widescreen) versions of DVD movies are most commonly formatted for standard 4:3 TVs. The TV has the capability of expanding this content so the entire screen is filled, at the expense of the image proportion. To use this function, press the aspect button on the remote control and cycle among the available options.
The TV turns off automatically	The TV features a power-saving mode which will automatically turn off the TV if there is no signal provided for 15 minutes.

Important Information About the Anti-Reflective Window on your SunBriteTV Outdoor Television

The anti-reflective window on your all-weather TV is designed to dramatically reduce reflection and improve the contrast of the image on your TV. In order to preserve the anti-reflective properties of the window, it is imperative that you follow the maintenance guidelines below:

CLEANING THE ANTI-REFLECTIVE WINDOW

Do not use any abrasive cleaners or acrylic cleaning products to clean the windows as they damage the anti-reflective surface. For best results, we recommend the use of 91% isopropyl alcohol applied with a damp lint-free cloth. Windex (or other common household cleaners) can also be used. Also available is SunBriteTV's special outdoor formula Cleaning Kit.

OUTDOOR DUST COVER

When the TV is not in use, we recommend that you keep it covered with a SunBriteTV fitted Outdoor Dust Cover. This will keep the TV clean, protect the finish and ensure years of maximum enjoyment.

To Order the Dust Cover or Cleaning Kit, contact your Authorized SunBriteTV Dealer, SunBriteTV's Customer Care Center at 800.331.4626, or visit our website at www.sunbrite.com.

General Cleaning

Remove any dirt and salt deposits from the unit, being careful to rinse the cloth frequently to avoid scratching the TV or screen surface. Avoid using harsh chemicals, abrasives, or solvents when cleaning any surface on the unit.

Snow and Ice

Use a soft brush and towel to remove snow and ice from the unit.

Fiber Filter

Over time, the fiber filter collects dirt and must be cleaned or replaced.

The Fiber Filters are housed in Filter Holders located on the back of the TV, inside the Intake Vent and Cooling Exhaust (Figure 1). Over time, the fiber filter collects dirt and must be cleaned or replaced.

1. Release the Fiber Filters by unscrewing the screws above the Filter Holder (Figure 2).
2. Pull Filter Holder from the TV. (Figures 3 and 4)
3. With your fingers, Pull the Fiber Filters out of the Filter Holder. Clean by removing the filter and washing with warm soapy water. Allow to completely air dry overnight prior to reinstalling. (Do not compress or squeeze filters as it will break down it's cellular structure.)
4. Put the Fiber Filters back into the Filter Holder, place back into the TV and screw securely.

CAUTION! NEVER SPRAY OR DIRECT A HOSE INTO THE VENT AREA OF THE TV.

To Order Replacement Filters, contact SunBriteTV's Customer Care Center at 800.331.4626.

Figure 1

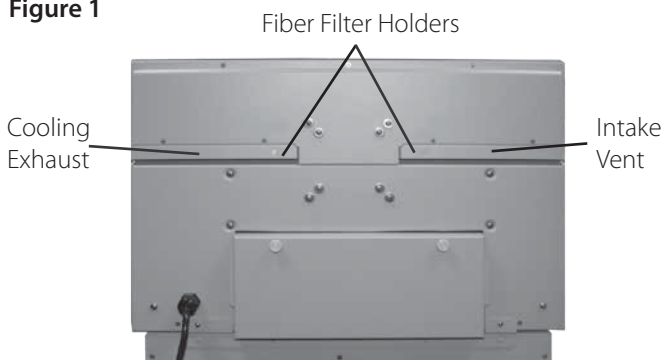

Figure 2

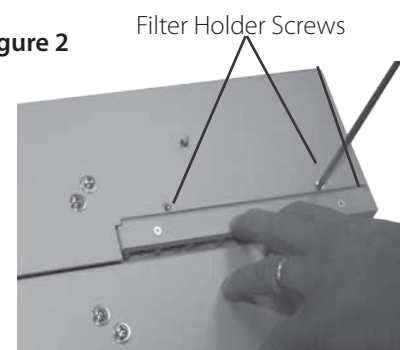

Figure 3

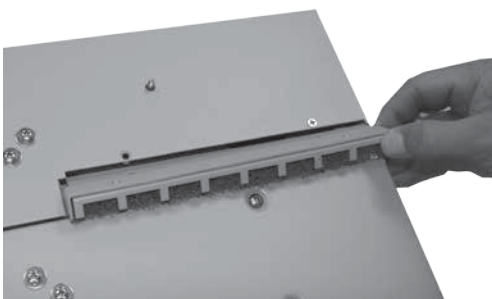
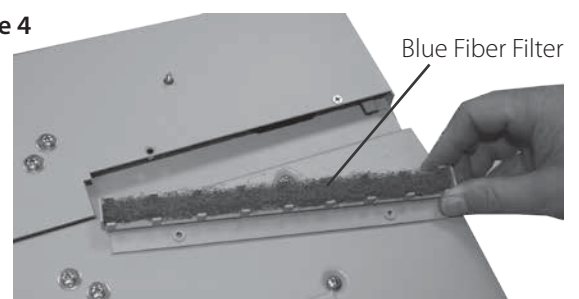

Figure 4



Specifications

Specifications for SunBriteTV Model 2220HD

LCD Screen	21.6-inch diagonal TFT Active Matrix
Resolution	1366 x 768
Aspect Ratio	16:9
Contrast Ratio	2500:1
H/V Viewing Angle	176° by 176°
Response Time	6.5 milliseconds
TV Formats	1080p, 1080i, 720p, 480i, 480p
Input Connectors:	
RF	Antenna/CATV (NTSC, ATSC, QAM)
HDMI	HDMI Input x 2
Video Composite	S-Video x1 and Composite Video x1, L/R Audio Inputs x1
Video Component	YPbPr x1 plus Stereo Audio x 2
PC	15-pin D-sub VGA plus Stereo Audio
Control Set	RS232 Serial, Discrete IR Control, Concealed IR Window
Audio Out	SPDIF Audio (fixed output) Analog Headphone Jack (variable output)
Speakers	5-watt x 2 channels, detachable speaker module
Exterior	Powder-coated aluminum
Input Power	100-240 VAC, 50-60 Hz 1.5A Max
Operating Temp.	-24° to 122° F. (-31° to 50° C.) *
Non-op. Temp. (Off-mode with power applied)	-24° to 140° F. (-31° to 60° C.) The non-operating temperature feature requires power to be applied
Accessories Included	Water-resistant remote control Removable table top stand
TV Dimensions	23 in. W x 16.49 in H w/speaker module, 14.80 in. H w/o speaker module x 4.55 in. D
Weight	20 lbs., 23 lbs. with feet
Shipping Dimensions	30.31 in. W x 19.49 in. H x 8.86 in. D
Shipping Weight	25 lbs.
Warranty, Residential	Two-year, in-factory, parts and labor
Warranty, Commercial	One year, in factory, parts and labor
Mount Pattern	75mm x 75mm or 100mm x 100mm

Specifications are subject to change.

*Temperature range is for operation in shaded location.

SunBriteTV Model 2220HD

(All dimensions are in inches)

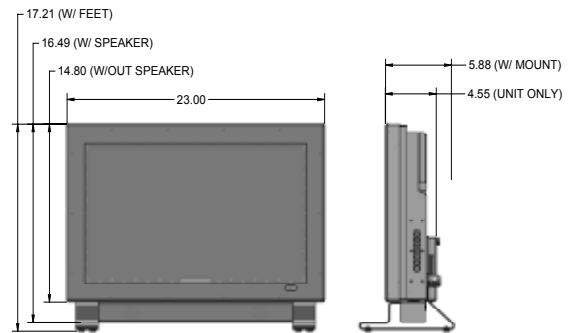

TV Dimensions are:

23 in. W x 16.49 in. H x 4.55 in. D

Height dimension without speaker module is 14.80

Height dimension with table top stand is 16.62 in.

TV with optional wall mount measures 5.88 in. when folded flush against the wall.

Features Information and Instructions

Extreme Climate Warning

If temperatures below -24° F. are expected, we recommend that you bring your SunBriteTV inside to prevent damage to the LCD screen.

Programming Other Manufacturers' Universal Remote Control Devices

When programming a DirectTV, local cable universal remote control or Control system, you may find that SunBriteTV is not on the list of TV manufacturers. If that is the case, this model supports SONY's universal remote code.

SunBriteTV Pixel Quality Policy

SunBriteTV's Pixel Quality Policy

(Applicable to LCD TVs sold within USA and Canada only.)

SunBriteTV LCD screens are manufactured with rigorous standards to maintain optimal viewing. However, the LCD screen may have minor defects that appear as a small bright or dark pixel. This is common to all LCD screens used in display and television products, and is not specific to SunBriteTV.

Bright dots are dots that appear bright and unchanged in size when a LCD TV screen displays a black pattern.

Dark dots are dots that appear dark and unchanged in size when a LCD TV screen displays a pure red, green, or blue pattern.

Adjacent dots are pixels located directly next to each other.

Your SunBriteTV will be replaced under warranty if it meets one of the following criteria:

- A total of 7 defective pixels, including both bright dots and dark dots are present. (The LCD TV screen on this TV has over a million pixels.)
- 2 or more pairs of adjacent bright dots are present.
- 3 adjacent bright dots are present.
- 3 adjacent dark dots are present.

To locate defective pixels, the LCD panel should be examined under normal operating conditions, in its native display resolution, with a 90 degree viewing angle, from a distance of a approximately 20 inches.

To qualify for replacement, a defective LCD screen must be reported to SunBriteTV within 60 days from the day the customer receives the TV.

For questions, please call our toll-free service number at 800.331.4626.

Appendix A - RS232 Control Cable Pinout

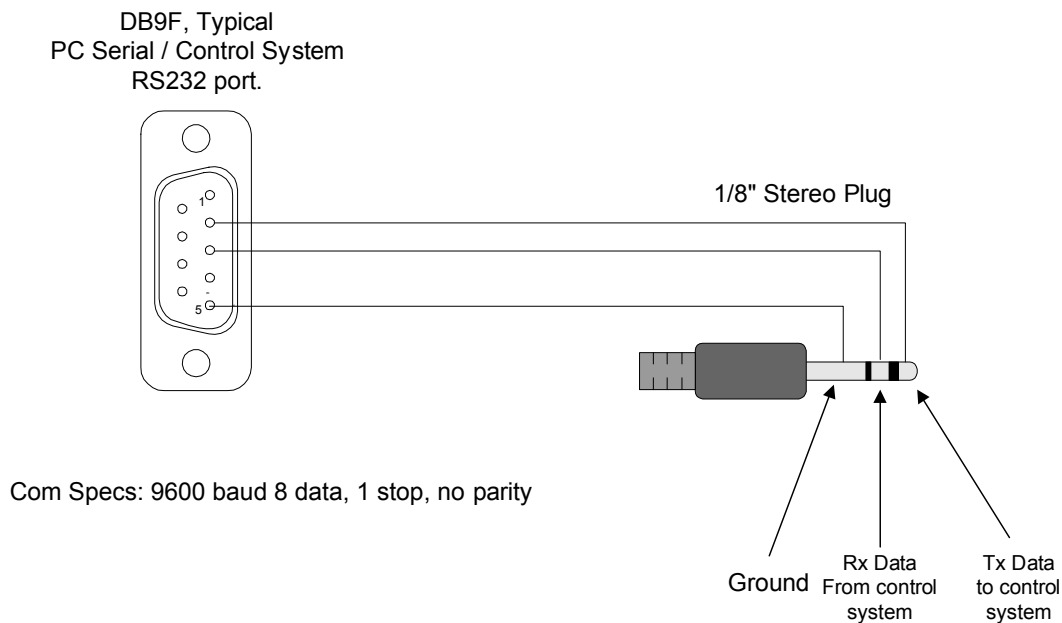

Appendix B - RS232 Control Codes

RS 232 Control codes SunbriteTV

Com Spec: 9600,8,1,n

Function	ASCII	HEX	Command Received from TV to control system	Response from TV to cc
Model Class ID	[ESC]?	1B 3F	[B3220AHD-X.XX] or [B4610AHD-X.XX]	na
Power Status	[ESC]!	1B 21	[PWRON] [PWROFF]	na
Power Toggle	[ESC]\$	1B 24	[\$]	[PWR]
Power ON	[ESC]A	1B 41	[A]	[PWRON]
Power OFF	[ESC]B	1B 42	[B]	[PWROFF]
Tuner Input	[ESC]C	1B 43	[C]	[TN1]
Composite Video Input 1	[ESC]D	1B 44	[D]	[AV1(CVBS)]
S-Video Input 1	[ESC]E	1B 45	[E]	[AV1(S-VIDEO)]
Composite Video Input 2	[ESC]F	1B 46	[F]	[AV2(CVBS)]
S-Video Input 2	[ESC]G	1B 47	[G]	[AV2(S-VIDEO)]
Component1 Input	[ESC]H	1B 48	[H]	[YpbPr1]
Component2 Input	[ESC]I	1B 49	[I]	[YpbPr2]
HDMI Input 1	[ESC]J	1B 4A	[J]	[HDMI1]
VGA Input	[ESC]K	1B 4B	[K]	[VGA]
HDMI Input 2	[ESC]L	1B 4C	[L]	[HDMI2]
Mute	[ESC]X	1B 58	[X]	[MUTE]
Vol Up	[ESC]Y	1B 59	[Y]	[VOL+]
Vol Down	[ESC]Z	1B 5A	[Z]	[VOL-]
Channel Up	[ESC]V	1B 56	[V]	[CH+]
Channel Down	[ESC]W	1B 57	[W]	[CH-]
1	[ESC]1	1B 31	[1]	na
2	[ESC]2	1B 32	[2]	na
3	[ESC]3	1B 33	[3]	na
4	[ESC]4	1B 34	[4]	na
5	[ESC]5	1B 35	[5]	na
6	[ESC]6	1B 36	[6]	na
7	[ESC]7	1B 37	[7]	na
8	[ESC]8	1B 38	[8]	na
9	[ESC]9	1B 39	[9]	na
0	[ESC]0	1B 30	[0]	na
-	[ESC]-	1B 2D	[-]	na
Channel Return(Previous Channel)	[ESC]r	1B 72	[r]	na
Source Toggle	[ESC]b	1B 62	[SRC]	na
Aspect	[ESC]a	1B 61	[ASPECT]	na
Enter	[ESC]e	1B 65	[ENTER]	na
Info	[ESC]i	1B 69	[INFO]	na
CC	[ESC]c	1B 63	[CC]	na
Sleep	[ESC]z	1B 7A	[SLEEP]	na
Picture	[ESC]p	1B 70	[PICT]	na
Sound	[ESC]s	1B 73	[SND]	na

SunBriteTV[®]

www.sunbritetv.com