

\$30.⁰⁰



Operation and Installation Manual
EX Series Screenless Granulator

Important! Read Carefully Before Attempting to Install or Operate Equipment



Bulletin No. BJ1-625

Write down your granulator _____
serial numbers here _____
for future reference _____

Ball & Jewell can advise you on proper selection and sizing of systems for your operating environment.

Ball & Jewell is committed to a continuing program of product improvement. Specifications, appearance, and dimensions described in this manual are subject to change without notice.

Bulletin No. BJ1-625

Effective 7/10/02

DCN No. _____
© Copyright Ball & Jewell Corp. 2002
All rights reserved.

Safety Considerations

Ball & Jewell EX Series Granulator Sprue and Runner Cutters are designed to provide safe and reliable operation when installed and operated within design specifications, following national and local safety codes.

To avoid possible personal injury or equipment damage when installing, operating, or maintaining this granulator, use good judgment and follow these safe practices:

- LEARN AND OBEY** your company's safety policy regarding granulating equipment.
- MOVING OR LIFTING THE GRANULATOR:** Although our equipment is built and engineered for great ruggedness in operation, care must be taken when moving the machine along the floor or lifting it. Damage may occur to sheet metal covers, electrical cabinets, or small brackets if pressure is applied to them when moving the granulator. When lifting the granulator, be certain of total machine weight and the capability of the lifting equipment (see the Granulator Specification Sheets for machine weights and dimensions).
- GRANULATOR LOCATION:** Adequate area for routine maintenance should be provided in order to open the machine for knife, screen, or cleanout service. Proper service area clearances also should allow people who are working on the machine to be clearly visible to others, thereby reducing the potential safety hazards.
- SAFE HOUSEKEEPING:** The work area must be kept clean and uncluttered to allow personnel safe movement around the granulator during periods of operation or maintenance. No hand tools or other metal objects should be left on or about the machine. Any tools or other metal objects which mistakenly fall into the hopper feed opening can cause severe damage to internal cutting chamber and screen chamber components.
- SAFETY GLASSES OR A FACE SHIELD MUST ALWAYS BE WORN** when servicing or operating the machine. Although our machines are designed for the maximum in flyback control, caution must be used when operating near the area of the hopper feed opening in order to guard against unexpected material flyback.

- ☑ **EAR PROTECTION** may be required when operating the machine during granulation of very hard/noisy materials. The Occupational Safety and Health Act of 1970 has established guidelines for Permissible Noise Exposures (OSHA 1910.95) that should be followed.
- ☑ **NEVER** attempt to operate the granulator unless it is fully assembled with all guards and interlocks in place and functional.
- ☑ **OBSERVE** all danger, warning, caution and safety labels on the equipment.
- ☑ Upon completion of any machine maintenance, be certain **ALL SAFETY GUARDS AND COVERS** are securely and properly fastened prior to resuming machine operation. All fasteners must be in place and properly tightened. **ANY SHORTCUTS MAY RESULT IN INJURY TO PERSONNEL OR DAMAGE TO EQUIPMENT.**
- ☑ **NEVER** wear any loose fitting clothes, neckties, or dangling items such as earrings, belts or shoestrings. Jewelry such as wristwatches, bracelets, or rings should **NEVER** be worn. Long hair must be tied back or placed in a tight fitting hairnet. **NEVER** lean against or rest hands/feet on the granulator when it is in operation or open for maintenance. **NEVER** stand on the granulator when it is in operation.
- ☑ **ROTATION OF MOTORS:** All rotating items in the granulator are clearly marked on the machine. Always check for proper rotation of motors.
- ☑ **ELECTRICAL GROUNDING:** All electrical equipment on the granulator must be grounded in accordance to all local codes and Article 250 of the National Electric Code.
- ☑ **ALWAYS DISCONNECT AND LOCKOUT THE MAIN ELECTRICAL POWER TO THE GRANULATOR BEFORE PERFORMING ANY SERVICE.**
- ☑ **SAFETY INTERLOCKS MUST NOT BE BYPASSED.** The mechanical and electrical safety interlocks ensure the safety of personnel. They should never be tampered with or removed for **ANY** reason. They should be checked frequently by a qualified mechanic for proper operation.
- ☑ **NEVER** modify the machine configuration or any individual component without written consent from Cumberland Engineering Corp.

For further information on granulator safety, installation, and operation, see the American National Standard for Plastics Machinery - Granulators, Pelletizers, And Dicers Used For Size Reduction of Plastics - Construction, Care, and Use. ANSI B151.11-1982.

Ball & Jewell has long recognized the importance of safety and has designed and manufactured its equipment with operator safety as a prime consideration. We expect you, as a user, to abide by the foregoing recommendations in order to make operator safety a reality.

SAFETY IS NO ACCIDENT

Table of Contents

Error! No table of contents entries found.

1	<i>General Information</i>	11
1-1	Introduction	11
	1-1-1 How to Use This Manual	11
	1-1-2 Safety Symbols Used in This Manual	12
1-2	Granulator Specifications	13
1-3	Standard Features	13
1-4	Available Options	14
2	<i>Shipping Information</i>	15
2-1	Unpacking and Inspection	15
2-2	In the Event of Shipping Damage	15
2-3	If the Shipment is Not Complete	16
2-4	If the Shipment is Not Correct	16
2-5	Returns	16
2-6	Uncrating Your Granulator	16
3	<i>Installation</i>	18
3-1	Scope	18
3-2	General Set-Up	18
3-3	Inspecting and Cleaning Granulator Components	18
3-4	Completing the Installation of Your Granulator	19
3-5	Electrical Considerations	20
3-6	Electrical Service Connections	21
3-7	Electrical Testing	21
	3-7-1 Hopper Safety Disconnect	22
	3-7-2 Motor Rotation Direction	22
	3-7-3 Accessory Equipment	22
4	<i>General Operation</i>	23
4-1	Scope	23
4-2	Pre-Operational Checklist	23
4-3	Granulator Operation	24
4-4	Cleaning Out the Granulator	24
4-5	Shutdown Conditions	25
	4-5-1 Emergency Stops	25
	4-5-2 Temporary Machine Stops	25
	4-5-3 Final Machine Stops	25

5	<i>Maintenance</i>	26
5-1	Maintaining Drive Components	26
5-2	Replacing Timing Belts	27
5-3	Lubrication Specifications and Considerations	27
5-4	Knife Recommendations and Adjustments	28
	5-4-1 Removing, Replacing and Adjusting Granulator Combs	28
	5.4.1.a. <i>Removing Rotor Combs:</i>	28
	5.4.1.b. <i>Removing Bed Combs:</i>	29
	5.4.1.c. <i>Installing Bed Combs:</i>	29
5-5	Adjusting the Sensitivity of the Optional Bin Level Monitor	30
5-6	Recommended Spare Parts List	31
6	<i>Troubleshooting</i>	33
7	<i>Charts and Figures</i>	39

List of Figures

<u>1.</u> <i>Belt Tensioning Chart</i>	27
<u>2.</u> <i>Recommended Spare Parts List Categories</i>	32
<u>3.</u> <i>S Series Screenless Granulator (Front)</i>	39
<u>4.</u> <i>S Series Screenless Granulator (Back)</i>	39
<u>5.</u> <i>Segregation Chamber Access</i>	40
<u>6.</u> <i>Cutting Chamber Detail</i>	40
<u>7.</u> <i>Discharge Options</i>	41
<u>8.</u> <i>Knife Bolt/Screw Tightening Torque Specifications</i>	42

Ball & Jewell Warranty Information

Thank you for your purchase of your new EX Series Screenless Granulator. We are confident that you will have excellent results and trouble-free operation with this machine.

When the machine arrives at your plant, inspect it carefully for shipping damage before uncrating and immediately report any damage to your transportation company. All shipments are FOB South Attleboro, Massachusetts.

Customer Satisfaction Warranty Program for EX Series Screenless Granulator.

The terms and conditions of the warranty set forth are for one (1) year from the original date of purchase by the original purchaser.

Ball & Jewell warrants to the original purchaser the product and/or goods to which this disclaimer is attached, and manufactured by us, to be free from defects in material and workmanship under normal use and service. **THIS WARRANTY IS EXPRESSLY IN LIEU OF ALL OTHER WARRANTIES EXPRESSED OR IMPLIED, INCLUDING WARRANTIES OF MERCHANTABILITY AND FITNESS FOR A PARTICULAR PURPOSE, AND ALL OTHER OBLIGATIONS AND LIABILITIES ON OUR PART.**

This warranty shall not apply to any goods or product manufactured by us which has been subject to accident, negligence, alteration of any kind, abuse or misuse. We further make no warranty whatsoever in respect to accessories or parts not supplied by us. Any warranty of any nature shall apply only to an “original purchaser” which shall be deemed to mean that person or entity for whom the goods and/or product were originally ordered and installed.

We neither assume nor authorize any person to assume for us any liability in connection with the sale or use of the products and goods sold hereunder, and shall not be responsible for damages for which a purchaser may be liable to other persons, damages to property, or injuries to any other persons.

Our sole obligation under this warranty shall be limited to replacing, repairing, or exchanging any part or parts of goods and/or products sold which we determine are defective under normal use and service within one (1) year of date of installation by the original purchaser. We shall not be liable for any loss or damage resulting directly or indirectly from the use or loss of the goods and/or products purchased. In no event shall we be liable for any general, direct, consequential, incidental or special damages of any kind.

We do not warrant any of our products that are installed in other machines or apparatus as meeting requirements of any safety code of any nature. The purchaser assumes all risks and liabilities resulting from the installation and use of product sold by us in combination with other machines or apparatus.

Ball & Jewell Warranty Information

We warrant our product to be of the kind and quality quoted, and no other warranty except of title shall be implied. Our company shall repair or replace, at our discretion, any manufactured item on your S Series granulator without charge FOB factory, within one (1) year after date of original purchase, which is proved to be defective when shipped. Claims for labor or consequential damages are not allowed.

Excluded from the above are knives, screens, and belts. Purchased items, including electrical components, motors, etc., shall carry the warranty of the supplier and no extension of that warranty is allowed.

Refer to this manual for assistance in installing and maintaining a highly efficient machine. Questions regarding areas that are not covered in the manual should be referred to the Customer Service Manager at the factory at (800) 229-2919.

1 **General Information**

1-1 **Introduction**

The Ball & Jewell EX Series Screenless Granulators are designed to uniformly and consistently size-reduce solid material scrap. They have been engineered to consistently deliver clean granulate with a minimum of fines and longs.

The rotor on which the combs and breaker bars are mounted is a machined steel unit supported by bearings mounted outside the cutting chamber. The rotor is driven by a gear motor capable of producing high torque loads. The granulator is equipped with a magnetic reversing starter protected by manually resettable overload heaters. The rotor combs and bed combs create a shearing cutting action, producing a very consistent particle size.

Motors are individually fused for maximum protection in compliance with the National Electric Code. The control enclosure houses all of the necessary wiring, fuses, overload heaters, and motor starter coils, along with the 115V control transformer and granulator operating controls. The control enclosure is built to meet NEC regulations and also contains a fused disconnect switch.

1-1-1 **How to Use This Manual**

Use this manual as a guide and reference for installing, operating, and maintaining your EX Series Granulator. The purpose is to assist you in applying efficient, proven techniques that enhance equipment productivity.

The General Information section outlines models covered, standard features, and available options. Additional sections within the manual provide instructions for installation, pre-operational procedures, operation, preventive maintenance, and corrective maintenance.

Installation instructions include all required data for receiving, unpacking, inspecting, and setup of the granulator. We can provide the assistance of a factory-trained technician to help train your operator(s) for a nominal charge.

Pre-operational procedures include instructions, checks, and adjustments that should be followed before operating the granulator. These instructions are intended to supplement

standard shop procedures performed at shift, daily, and weekly intervals.

The Operation chapter includes a description of electrical and mechanical controls, in addition to information for operating the granulator safely and efficiently.

The Maintenance chapter is intended to serve as a source of detailed assembly and disassembly instructions for those areas of the equipment requiring service. Preventive maintenance sections are included to ensure that your EX Series Granulator provides excellent, long service. The Customer-Recommended Spare Parts section in the Maintenance chapter contains a list of parts that may require replacement. A spare parts list with part numbers specific to your machine is provided with your shipping paperwork package. Refer to this section for a listing of spare parts for purchase. Have your serial number and model number ready when ordering.

The Troubleshooting chapter serves as a guide for identification of most common problems. Potential problems are listed, along with possible causes and related solutions.

1-1-2 Safety Symbols Used in This Manual

The following safety alert symbols are used to alert you to potential personal injury hazards. Obey all safety messages that follow these symbols to avoid possible injury or death.

DANGER indicates an *imminently* hazardous situation, which, if not avoided, *will* result in death or serious injury.

WARNING indicates a *potentially hazardous* situation or practice which, if not avoided, *could* result in death or serious injury.

CAUTION indicates a potentially hazardous situation or practice which, if not avoided, *may* result in minor or moderate injury, or in property damage.

1-2 Granulator Specifications

Table 1: Granulator Specifications

	EX909	EX913	EX918
Cutting Circle	9.7" (247 mm)	9.7" (247 mm)	9.7" (247 mm)
Throughput	30 lbs./hr (14 kg/hr)	40 lbs./hr (18 kg/hr)	50 lbs./hr (23 kg/hr)
Cutting Chamber	9" x 9" (229 mm x 229 mm)	9" x 13" (229 mm x 330 mm)	9" x 18" (229 mm x 457 mm)
Rotor Knives	Hardened 8620 alloy steel	Hardened 8620 alloy steel	Hardened 8620 alloy steel
Bed Comb	Reversible 1/4" (6.4 mm) comb	Reversible 1/4" (6.4 mm) comb	Reversible 1/4" (6.4 mm) comb
Discharge Bin	0.70 cu. ft. (.0198 cu. meters)	0.85 cu. ft. (.0241 cu. meters)	1.00 cu. ft. (.0283 cu. meters)
Motor	1 hp (.75 kW)	2 hp (1.5 kW)	2 hp (1.5 kW)
Drive	Cyclodial speed reducer – 34rpm	Cyclodial speed reducer – 34rpm	Cyclodial speed reducer – 34rpm
Electrical Components	Start/stop pushbutton	Start/stop pushbutton	Start/stop pushbutton
Controls	NEMA type 12	NEMA type 12	NEMA type 12
Feed Height	52" (1321 mm)	52" (1321 mm)	52" (1321 mm)
Length	25.25" (641 mm)	25.25" (641 mm)	25.25" (641 mm)
Width	19" (483 mm)	23" (584 mm)	28" (711 mm)
Weight	550 lbs (250 kg)	650 lbs (295 kg)	750 lbs (341 kg)

1-3 Standard Features

Standard features of the EX Series Granulator are

- 34 RPM rotor speed
- 230 or 460 voltages
- Segmented rotor comb design
- Timing belt drive system with taper lock bushings
- Totally-enclosed fan-cooled gear motor
- Front hopper cleanout door
- NEMA 1 drop-down rear access electrical enclosure with fused disconnect switch
- Start-stop control button mounted on NEMA 12 box
- Front-access bed comb cam adjusting system
- 8620 heat treated cutter segments
- Manual discharge bin
- Positive break safety switch to interlock hopper and chute doors

- No Tools Required to open the cutting chamber/segment chamber/hopper chute
- Four (4) swivel casters

1-4 Available Options

Available standard options for EX Series Granulators include:

- Alternate feed chutes.
- Alternative voltages: 208/3/60, 380/3/50, 415/3/50, 575/3/60
- Alternate comb tooth sizes .185"(~5MM) and .220"(~6MM),
- Vacuum bin design
- Bin level-sensing proximity switch and light
- Abrasion resistance package
- Compressed air venturi

2

Shipping Information

2-1 Unpacking and Inspection

You should inspect your Ball & Jewell EX Series Screenless Granulator for possible shipping damage.

Thoroughly check the equipment for any damage that might have occurred in transit, such as broken or loose wiring and components, loose hardware and mounting screws, etc.

2-2 In the Event of Shipping Damage

Important!

According to the contract terms and conditions of the Carrier, the responsibility of the Shipper ends at the time and place of shipment.

- Notify the transportation company's local agent if you discover damage
- Hold the damaged goods and packing material for the examining agent's inspection. **Do not return any goods to Ball & Jewell before the transportation company's inspection and authorization.**
- File a claim with the transportation company. Substantiate the claim by referring to the agent's report. A certified copy of our invoice is available upon request. The original Bill of Lading is attached to our original invoice. If the shipment was prepaid, write us for a receipted transportation bill.
- Advise Ball & Jewell regarding your wish for assistance and to obtain an RMA (return material authorization) number.

2-3 If the Shipment is Not Complete

Check the packing list as back-ordered items are noted on the packing list. You should have:

- Ball & Jewell EX Series Screenless Granulator
- Bill of lading
- Packing list
- Operating and Installation packet
- Detailed recommended spare parts list
- Electrical schematic and panel layout drawings
- Component instruction manuals

Re-inspect the container and packing material to see if you missed any smaller items during unpacking.

2-4 If the Shipment is Not Correct

If the shipment is not what you ordered, **contact the Ball & Jewell shipping department immediately**. For shipments in the United States and Canada, call 1 (800) 229-2919; for all other countries, call our international desk at (508) 399-6400. Have the order number and item number available.

Hold the items until you receive shipping instructions.

2-5 Returns

Important!

Do not return any damaged or incorrect items until you receive shipping instructions from Ball & Jewell.

2-6 Uncrating Your Granulator

Prepare in advance the site you have selected for installation of the granulator. Be certain that the area to be occupied by the machine is clean, level, and free of obstructions. The site you have selected must have a floor rating to adequately support the weight of the machine. A concrete floor of 4" (10.2cm) minimum thickness is recommended.

Your EX Series Screenless Granulator is mounted on a wooden skid and blocked and banded to secure it for shipment. All non-painted items subject to corrosion are coated with a quality rust preventative, and the machine is covered with heavy-duty polyethylene to protect it from moisture and dirt. Granulators are normally shipped completely assembled unless the size of the machine or an agreement for special shipping arrangements prompts partial assembly.

If inspection after shipment has revealed no shipping damage, unpack the unit by removing the polyethylene protective covering and banding. Remove the envelope with the parts list, assembly drawings, electrical schematics, and manual from the base evacuation area.

You can now have the machine lifted from the skid. A forklift is ideal for the purpose, but take care to **properly position the forks** between the casters and the centrally mounted evacuation pipe from the side of the machine.

! CAUTION !

Do not attempt to lift the granulator by means of any shaft or protruding member, ESPECIALLY THE HOPPER

3-1 Scope

This chapter contains all instructions required for experienced installation personnel to install the granulator and prepare it for production. You must follow all instructions carefully and in the sequence presented. Be sure to observe all **DANGER**, **WARNING**, **CAUTION**, and **NOTE** statements to prevent personal injury or machine damage. These statements are designed to make installation procedures safe and easy.

3-2 General Set-Up

1. Make certain the floor is clean, level, and free of obstructions before placing the machine into position.
2. Visually inspect the hopper infeed opening to ensure that no stray packing material or debris is present.

3-3 Inspecting and Cleaning Granulator Components

! CAUTION !

The cutting chamber combs are EXTREMELY SHARP. Always wear heavy gloves and exercise care when working in the cutting chamber.

1. Open the front base door and the hopper access door by unlatching the two (2) latches and swinging the doors into their open positions. Carefully inspect the interior of the hopper and above the rotor for foreign material or debris. **Slowly and carefully turn the rotor by hand to verify that it rotates freely and without obstruction.** Make sure that the rotor does not make any contact with the bed combs. Wipe the inside of the hopper and cutting chamber clean.

With the hopper door opened, the cutting chamber safety switch located in the base of the machine will automatically disengage the switch body from the main switch assembly in the base.

2. Ensure that nothing has been left inside the machine.

3. Look inside the base evacuation area. Spare parts, such as combs, are often placed inside this area for shipping purposes.

! CAUTION !

The cutting chamber combs are EXTREMELY SHARP. Always wear heavy gloves and exercise care when working in the cutting chamber.

4. Carefully inspect the interior of the cutting chamber and evacuation area for foreign material or debris.
5. Noting the location of each segmented chamber, lower and remove them from the cutting chamber by loosening the handknob on each. Lift the rear of each segmented chamber off of the rear support bar to aid removal. Carefully inspect the interior of each segmented chamber for material or debris. See Figure 5.
6. Wipe all interior surfaces clean.
7. Place the three (3) segmented chambers back into their original position and tighten each handknob securely.
8. Verify that no material has been left inside the machine
9. Close the front base door and the hopper access door and secure the latches.

! CAUTION !

Do not run granulator until upper machine assembly is fully latched down.

3-4 Completing the Installation of Your Granulator

1. Open the drive guard by removing the bolts that attach the guard cover to the timing belt backing plate.
2. Check the timing belt for proper tension and alignment.
3. Upon completion, close the guard by placing the cover back into position, insert all the bolts originally removed, and tighten them fully.

4. Position and connect any optional accessory equipment such as vacuum lines, conveyors, and separators. Ensure all tubing joints are securely clamped and supported.

3-5 Electrical Considerations

!!! DANGER !!!

Improper electrical connections can damage the granulator and CAUSE SERIOUS OPERATOR INJURY OR DEATH!

EX Series Screenless Granulators are designed for three-phase voltage operation. Refer to the unit nameplate or ID plate for proper voltage and amperage requirements.

NOTE: Make sure to provide a correctly-sized and protected supply of electrical power to the unit.

Maintain a safe ground and disconnect the power supply before servicing the unit. A qualified electrician should make electrical connections, and disconnect and lock out electrical power following OSHA 29CFR 1910.147.

Check serial tag voltage/amperage requirements and make sure your electrical service conforms before making any electrical connections. Full load amps for EX Series Granulators are listed on the nameplate or ID plate. Make sure that all three phases are wired correctly.

Bring properly sized power leads and grounds from a fused disconnect to the unit. Provide external overcurrent protection to the unit, using circuit breakers or fuses. If you use fuses, make sure that they are dual-element time-delay fuses, sized according to your electrical code. Make sure **all** electrical connections are *tight*.

! CAUTION !

Electrical connections must comply with all applicable electrical codes. Voltage must be within plus or minus ten percent (+/- 10%) of the nameplate rating. Make sure your installer provides external protection.

Make certain all electrical connections are properly made and supported between accessories and the control enclosure (refer to the wiring diagram for wire and terminal connections).

!!! DANGER !!!

Before undertaking any machine repairs or maintenance, always make certain that the machine disconnect switch is turned to the OFF position or that the control enclosure is disconnected from the main power source.

LOCK OUT all sources of power, including the main disconnect switch, and follow all of your plant lockout procedures.

3-6 Electrical Service Connections

Carefully check the diagrams packed with the machine. All internal wiring has been done at the factory. All safety interlocks have been verified to be functional before shipment. It is only necessary to connect the electrical power source to the machine at the control enclosure. A straight screwdriver is required to open the enclosure door.

!!! DANGER !!!

All equipment must be grounded in compliance with Article 250 of the National Electric Code and all local codes.

Customer's means of disconnection and branch circuit protection must also be in compliance with the National Electric Code and all local codes.

3-7 Electrical Testing

Before applying power to the machine, check the incoming voltage from **L1 to L2**, **L2 to L3**, and **L1 to L3** (see the wiring diagram packed with the machine). The voltage should be the same as indicated on the silver or red tag in the control enclosure. If the voltage is not the same, contact the Ball & Jewell Service

Department at 1-800-229-2919 for voltage modification instructions.

3-7-1 Hopper Safety Disconnect

1. Turn the main disconnect to the ON position.
2. Press the granulator START button to start the machine.
3. Test the front base door and the hopper access door: unlatch the two (2) latches and open the doors approximately two (2) inches to verify that the machine shuts off.
4. Latch the (2) latches to close the doors and re-engage the cutting chamber safety switch.

!!! DANGER !!!

If the machine does not shut off as a result of this test, disconnect the machine from the power source immediately and call the Ball & Jewell Service Department at 1-800-229-2919.

3-7-2 Motor Rotation Direction

1. Turn the main disconnect to the ON position.
2. Press the granulator START button to start the machine.
3. Note the direction of the rotor rotation. It should be counterclockwise when viewed from the right hand side of the machine. If the rotor rotation is not as described, turn off the machine, turn the main disconnect to OFF, and reverse any two (2) incoming power leads.

3-7-3 Accessory Equipment

For granulators equipped with conveyors, vacuum systems, etc., test their operation by pressing the appropriate button.

4-1 Scope

This chapter contains the information required to carry out pre-operational procedures, as well as general operation. The checklist of items listed below should always be reviewed prior to a production run.

4-2 Pre-Operational Checklist

To ensure the granulator is ready for operation, perform the tasks listed on the following pre-operational checklist. Make sure that all electrical and mechanical machine elements are inspected and any defects corrected *first*.

- Have all installation and preparation instructions been read and followed?
- Have the granulator operators and all other necessary personnel, such as the cleanout, maintenance and service persons, been fully trained on machine operation and all machine safety mechanisms?
- Have the granulator operators and all other necessary personnel, such as the cleanout, maintenance and service persons, read the Operation and Installation Manual?
- Have sufficient location clearances been allowed?
- Has the equipment been grounded as required by local codes and/or Article 250 of the National Electric Code?
- Have all motors been checked for proper rotation?
- Have all machine controls, pushbuttons, and limit switch interlocks been checked for proper functioning?
- Have the cutting chamber and breaker segregation chambers been checked for foreign matter?
- Have the drive components been checked for alignment and tension?
- Is the machine properly closed with all visible fasteners tight?
- Are all accessory components electrically and mechanically connected with proper support and with all fasteners tight?

- Are all electrical enclosure boxes tightly closed and clamped shut?
- Are all personnel clear of the machine?

4-3 Granulator Operation

The machine is ready for operation when all doors, covers, guards, and limit switches are in place, securely fastened and functional, and all accessory components are properly connected.

1. Turn the main disconnect to the ON position.
2. Start the granulator by pressing the start button at the operator station.
3. Load feedstock at a uniform rate that does not exceed the capacity of the machine; see Table 1: Granulator Specifications.
4. For color and/or material changes, allow all existing material to clear the granulator and any downstream equipment before stopping the machine. Doing so reduces cleaning requirements.

4-4 Cleaning Out the Granulator

To open the granulator and obtain access to the cutting chamber and base for cleanout, follow these steps:

1. Shut **OFF** and **LOCK OUT** all power including the main disconnect switch.
2. Open the cutting chamber doors.
3. Loosen the hand knobs on the segregation chambers and swing down. Lift up from rear mounting bar and remove for easy cleaning.
4. After cleaning each segregation chamber, replace in its former position on the cutting chamber. Swing hand knob into position and tighten securely.

! CAUTION !

Never close the chamber access doors without checking that all three (3) segregation chambers are in place and hand knobs are tight. Never attempt to run machine without all three (3) segregation chambers in place and tightened.

Always wear heavy gloves and exercise care when working in the cutting chamber.

4-5 Shutdown Conditions

4-5-1 Emergency Stops

Feedstock must be cleaned out of the hopper and cutting chamber prior to restarting.

4-5-2 Temporary Machine Stops

To temporarily stop the machine, **first** allow all material to run out of the cutting chamber. **Never** try to restart the machine with material remaining inside the cutting chamber.

4-5-3 Final Machine Stops

To shut the machine down, allow all material to pass through the transition before pressing the STOP pushbutton to stop the machine.

! CAUTION !

This model series of granulator is NOT designed to grind purgings, large chunks of solid plastic, or other heavy cross-sectional pieces.

5-1 Maintaining Drive Components

For continuing reliable operation of the granulator, it is of the utmost importance that the motor drive belt tension is correct. Correct tension reduces wear on the rotor and motor bearings and reduces slip to a minimum.

Belt drives must be tensioned at the “Run-In” recommended force. Check the tension at least twice during the first two days’ operation. After the belts have seated themselves in the sheave grooves and the initial stretch is removed, re-tension the belts to the “Normal Running” recommended force.

A gauge is available from customer service or the belt manufacturer which facilitates the measurement of belt deflection and force.

The Belt Tensioning Chart in Figure 1 gives the recommended force required to deflect each belt by an amount equal to the belt span divided by 64. The Deflection Force Value relates to a single V-belt element.

1. Verify that the alignment of the sprockets is correct. Using a straightedge of sufficient length to span from one sprocket to the other, place it along the sides of both sprockets. The entire edge of each sprocket should contact the straightedge.
2. Measure the timing belt sag. See Figure 1.
3. Determine the force required to deflect one belt 1/64” (0.40 mm) per 1 inch (25.4 mm) of span length as follows:
 - a. Measure span length (t) of your drive.
 - b. At the center of span (t), apply a force perpendicular to the span large enough to deflect one belt on the drive 1/64” (0.40 mm) span length from its normal position.
4. Compare this deflection force with range of forces in the Belt Tensioning Chart as follows:
 - a. If it is less than the minimum recommended force, belts should be tightened.
 - b. If it is more than the maximum recommended deflection force, the drive is as tight as it needs to be.

Figure 1: Belt Tensioning Chart

Design HP	New Belt		Used Belt	
	Min	Max	Min	Max
1	442	443	438	440
2	466	469	459	462
3	490	495	480	485

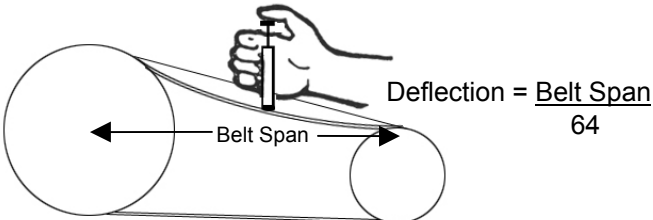

5-2 Replacing Timing Belts

1. Remove the guard cover.
2. Find and loosen the two (2) interior guard plate screws near the gearmotor timing belt drive from inside the sprocket guard housing.
3. Loosen the gear motor hold-down screws and move the motor towards the granulator rotor to allow more slack in the belt.
4. Remove the old timing belt.
5. Install the new timing belt over the sprockets.
6. Move the motor back from the granulator to reduce belt sag.
7. Verify the alignment between the gear motor and rotor sprockets; then tighten the gear motor hold-down screws.
8. Adjust the interior guard plate to re-center the opening around the gearmotor shaft and tighten the two (2) mounting screws.
9. Replace the guard cover.

5-3 Lubrication Specifications and Considerations

All beside-the-press granulators and accessories are supplied with bearings that are pre-lubricated at the factory.

Mounting the bearings external to the cutting chamber results in low maintenance and trouble-free operation.

The bearings used require a high quality, lithium-based EP (extreme pressure) type of grease, which conforms to the NGLI Grade 2 consistency. This grease has been chosen due to its

suitability for use in heavy-duty applications under heavy shock loads. It also contains rust inhibitors, has high temperature stability, and exhibits good water resistance.

Bearings should be lubricated with care. Too much grease applied to the bearings at one time can rupture bearing seals. Under normal operating conditions, a moderate amount of grease applied every 2,000 hours should be adequate to ensure long life. **Severe operating conditions require more frequent lubrication intervals.**

5-4 Knife Recommendations and Adjustments

IMPORTANT!

The rotor and bed combs are subjected to severe conditions, and you should inspect combs periodically for sharpness. The sharper the combs are kept, the better the machine operates, producing quality regrind. If the combs become severely rounded, chipped, or otherwise damaged, the granulator experiences heavy shock loads during operation causing additional and significant reduction in comb life.

5-4-1 Removing, Replacing and Adjusting Granulator Combs

5.4.1.a. Removing Rotor Combs:

1. Shut **OFF** and **LOCK OUT** all power, including the main disconnect switch.

!!! DANGER !!!

Before undertaking any machine repairs or maintenance, always make certain that the machine disconnect switches are turned to the OFF position or that the control enclosure is disconnected from the main power source.

Lock out all sources of power, including the main disconnect switch, and follow all of your plant lockout procedures.

2. Remove the bolts that hold the hopper on the cutting chamber.
3. Remove the timing belt drive.
4. Remove the timing belt guard.
5. Remove the rotor blocks.

6. Lift the rotor out of cutting chamber
7. Remove the three (3) socket head cap screws that hold the rotor assembly together.
8. Slide the cutters and spacers from the hex shaft.
9. Replace the necessary cutter(s). (Make sure the cutters are staggered by indexing the clearance hold 1 turn clockwise for each cutter.)
10. Re-install the three (3) socket head cap screws.
11. Replace the rotor in the chamber.
12. Re-install the rotor blocks
13. Re-install the timing belt guard.
14. Re-install the timing belt drive.
15. Bolt the hopper to the cutting chamber.

! CAUTION !

EXERCISE EXTREME CARE when rotating the rotor and handling combs.

5.4.1.b. Removing Bed Combs:

1. Working on either side of the cutting chamber, remove the two (2) hex cap screws on each bed comb adjustment cam. (refer to Figure 6)
2. Remove the two (2) washers, adjustment cams, and bushings.
3. Remove the bed comb.

5.4.1.c. Installing Bed Combs:

1. Install a bed comb by positioning it onto either cutting chamber seat. Take care to orient the bed comb with the "short" slot (approximate 1.0" deep x .75" wide) towards the outside of the cutting chamber.
2. While holding the comb, place the bushing and adjustment cam into each of the two (2) bed comb adjustment holes. In order to simplify bed comb adjustment, orient the adjustment cams in the outboard comb holes with the eccentrics "out". Locate the middle adjustment cam with the eccentric "down". Note that

the hex cams have a “dot” machined on the cam face to show the high point when installed.

3. Assemble a washer and hex cap screws into each adjustment cam hole and finger tighten them.
4. Slowly turn the rotor back and forth. Using the right hand and left hand adjustment cams, move the bed comb in or out as required to clear the rotor combs. The rotor/bed comb clearance is normally set to approximately .005". Once the in or out position is determined, lightly tighten the left hand and right hand adjustment cam screws. Check that the clearance left to right between the rotor and bed combs is approximately .005". Position the bed comb by using the center adjustment cam. Once positioned, lightly tighten the adjustment cam screw.
5. Turn the rotor through 360° in both rotation directions to ensure clearance with the bed comb. Once clearance is established, fully tighten the adjustment cam screws.
6. Repeat steps 1 through 5 for all bed combs.
7. Fully tighten all bed comb adjustment screws to 12 ft/lbs.

5-5 Adjusting the Sensitivity of the Optional Bin Level Monitor

!!! DANGER !!!

Because electrical power must be supplied to the sensor to permit testing and adjustment, it is EXTREMELY VITAL that you secure the machine for normal operations.

Do so by closing the cutting chamber and hopper access door, which returns the safety limit switch to the closed position, PRIOR to beginning any sensor adjustments to ensure the safety of personnel.

Although the bin level sensor was installed and tested at the factory to ensure reliable operation, variations in the physical properties of the material run through the granulator require that you adjust the sensor to suit your particular requirements. Follow these steps during initial pre-operational electrical testing and whenever you change the type of material run through the granulator.

Step 1:

Fill the bin with granulate of the material you intend to run through the granulator. Make sure the bin is filled to a level that covers the front face of the latex sensor covering located on the rear wall of the bin.

Step 2:

Make sure that power is supplied to the machine by turning the main disconnect switch to the ON position and connecting the control enclosure to the main power source.

DO NOT START THE MACHINE.

Step 3:

Locate the sensor on the rear wall of the machine base.

Using a small screwdriver, locate and turn the potentiometer located on the rear face of the sensor.

- Turning the potentiometer clockwise (CW) **increases** sensitivity and **activates** the alarm.
- Turning counterclockwise (CCW) **decreases** sensitivity and **shuts off** the alarm.

With the bin in place, turn the potentiometer so that the alarm sounds, then rotate counterclockwise (CCW) until the alarm just goes off. Now rotate clockwise (CW) one-half to one ($\frac{1}{2}$ to 1) turn.

The sensor is now set and the unit is ready to granulate new material

5-6 Recommended Spare Parts List

A Recommended Spare Parts List is part of the operation and installation package that arrives with your new machine. Look for a Recommended Spare Parts List to find the specific part numbers that pertain to the categories listed in Figure 2: Recommended Spare Parts List Categories. The list in Figure 2: Recommended Spare Parts List Categories reflects a general list of spare parts that should be kept on hand to keep your new granulator running at optimum performance.

Please keep the Recommended Spare Parts List in a place where you can easily retrieve it. Please have the machine serial number

available when calling Spare Parts Express at 1-800-229-2919 for new replacement OEM parts.

NOTE: Refer to part numbers when ordering replacement parts. Check the parts carefully, as they may have numbers etched or stamped on them. The recommended spare parts list does not include all parts that are available for purchase—just the parts most appropriate for your particular machine.

See your machine shipment package for recommended spare parts list specific to your machine. Part numbers are listed on that specific list for your reference.

Figure 2: Recommended Spare Parts List Categories

Description
Set of rotor combs and wedge screws
Set of bed combs and cap screws
Set of fuses
Overload relay
Motor reversing contactor

6

Troubleshooting

Problem	Possible Cause	Solution
No granulate	Feedstock may be hung up inside the hopper.	Shut machine down and check.
	Vacuum line may be clogged.	Clean as needed.
Stringy granulate	Comb gap is too large.	Adjust to proper gap specification.
	Combs are dull.	Reverse bed comb or replace combs and re-install.
Fines	Combs are dull.	Reverse bed comb or replace combs and re-install.
Excessive power required; blown fuses	Overloading of the machine.	Reduce amount/size of feedstock put into the machine.
	Combs are dull.	Reverse bed comb or replace combs and re-install.
	Comb gap is too large.	Adjust to proper gap specification.
Machine stalls	Overloading of machine.	Reduce amount/size of feedstock put into the machine.
	Pieces of feedstock jammed in the rotor.	Clear the jammed material then visually inspect the rotor to insure it is not damaged and that the comb gaps are correct.
Bearings sound noisy or are hot	Lack of lubrication.	Lubricate per maintenance instructions.
	Overloading of the machine.	Reduce amount/size of feedstock put into the machine.
	Bearings have exceeded their rated life.	Consult with Ball & Jewell Service Department at 1-800-966-8664 for replacement instructions.
	Bearings are not properly installed or tightened.	Consult Ball & Jewell Service Department at 1-800-966-8664 for installation instructions.
Motor does not start	Fuses are blown.	Replace fuses with the size and type shown on the wiring diagram (located in the control enclosure).
	A limit switch is open.	Check the limit switch at the machine front and any hopper cleanout door. Ensure proper actuation and adjust or replace as needed.
		Verify that the correct pushbuttons are being depressed and that the main disconnect switch is in the ON position.
Overload relay tripped	Reset by electrician/technician.	
Feedstock hangs up in the hopper or cutting chamber	Material being placed into the machine for processing is too large for the hopper, cutting chamber, or rotor diameter.	Reduce the initial size of the feedstock.

Problem	Possible Cause	Solution
	Combs are dull.	Reverse bed comb or replace combs and re-install.
	Overloading of the machine.	Regulate the infeed of scrap to uniformly feed the machine.
Granulate builds up in the transition or tubing	Transition tubing is clogged.	Clean as required.
	Vacuum is not evacuating properly.	Check per manufacturer specifications.

Service Notes

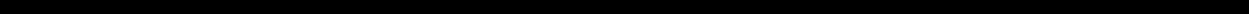

A series of 20 thin, horizontal black lines spaced evenly down the page, providing a template for writing service notes.

Service Notes

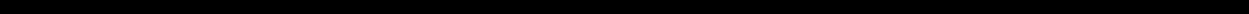

A series of 20 thin, horizontal black lines spaced evenly down the page, providing a template for writing service notes.

Service Notes

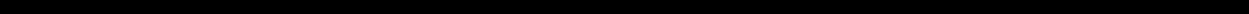

A series of 20 thin, horizontal black lines spaced evenly down the page, providing a template for writing service notes.



Parts Department

Call *Spare Parts Express* toll-free 8am – 8PM EST (800) 229-2919. Ball & Jewell OEM quality replacement and spare parts ensure operation at design specifications. Please have the model and serial number of your equipment when you call. Consult the Customer Parts List included in your information packet for replacement part numbers.



Service Department

Call toll free (800) 966-8664 8am – 8pm EST- *Emergency service available 24 hours a day.*

Ball & Jewell has a qualified service department ready to help. Service contracts are available for most Ball & Jewell products.



Sales Department

Call (508) 399-3100 Monday – Friday, 8am – 5pm EST

Ball & Jewell products are sold by a worldwide network of independent sales representatives. Contact our Sales Department for the name of the sales representative nearest you.



Ball & Jewell
124 Roddy Avenue
South Attleboro, MA 02703
Tel: (508) 399-3100

Fax: (508) 399-3050

Figure 3: EX Series Screenless Granulator (Front)

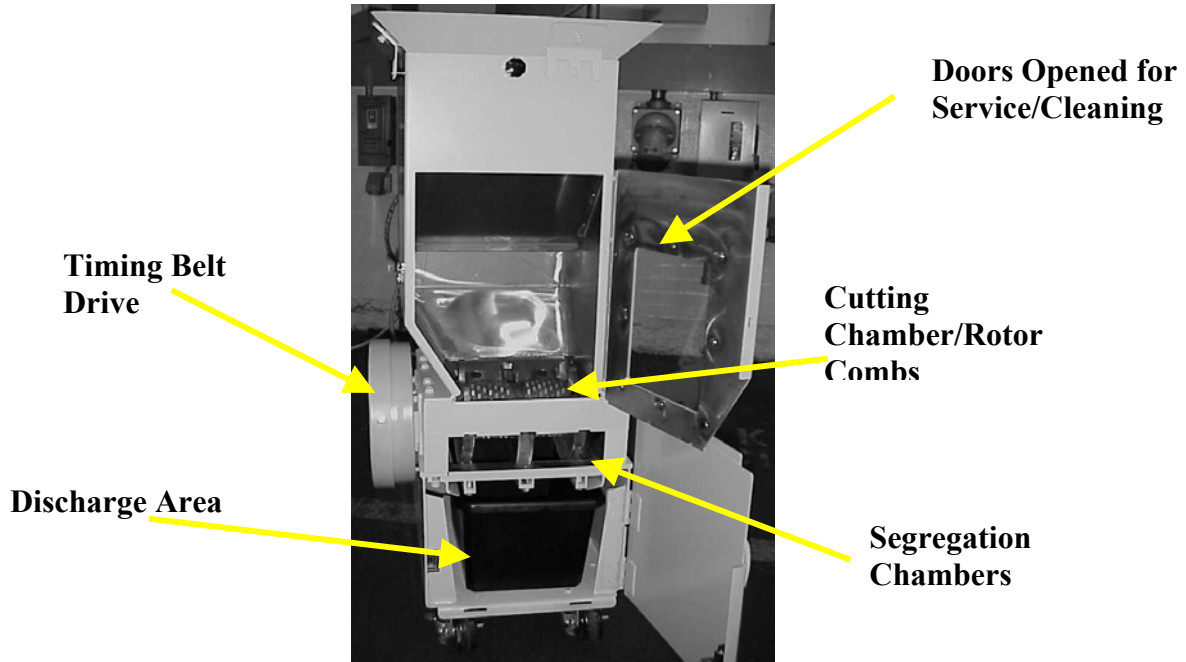

Figure 4: EX Series Screenless Granulator (Back)

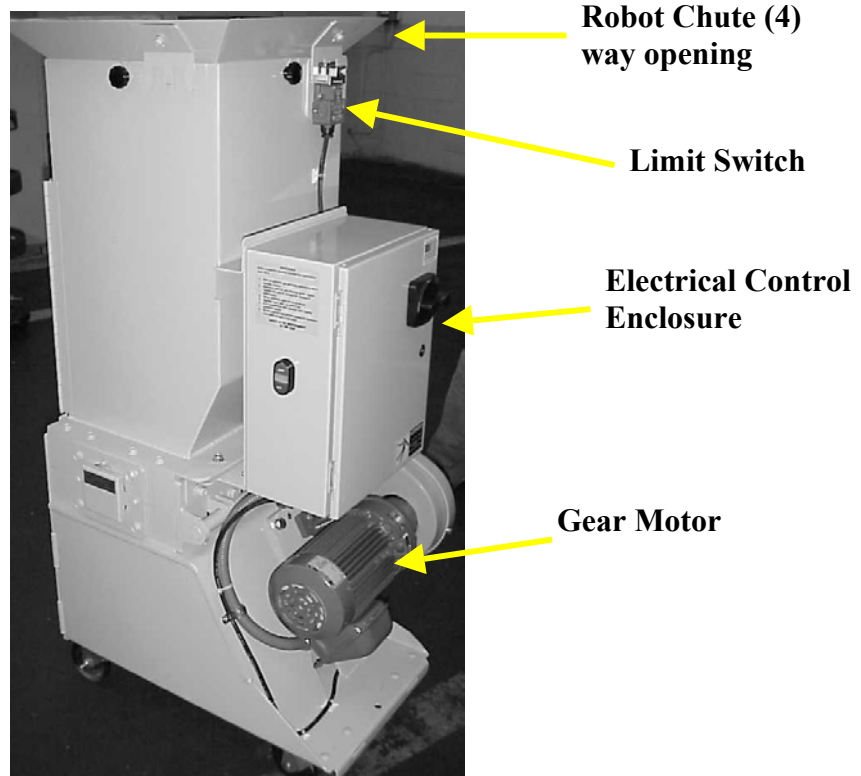

Figure 5: Segregation Chamber Access

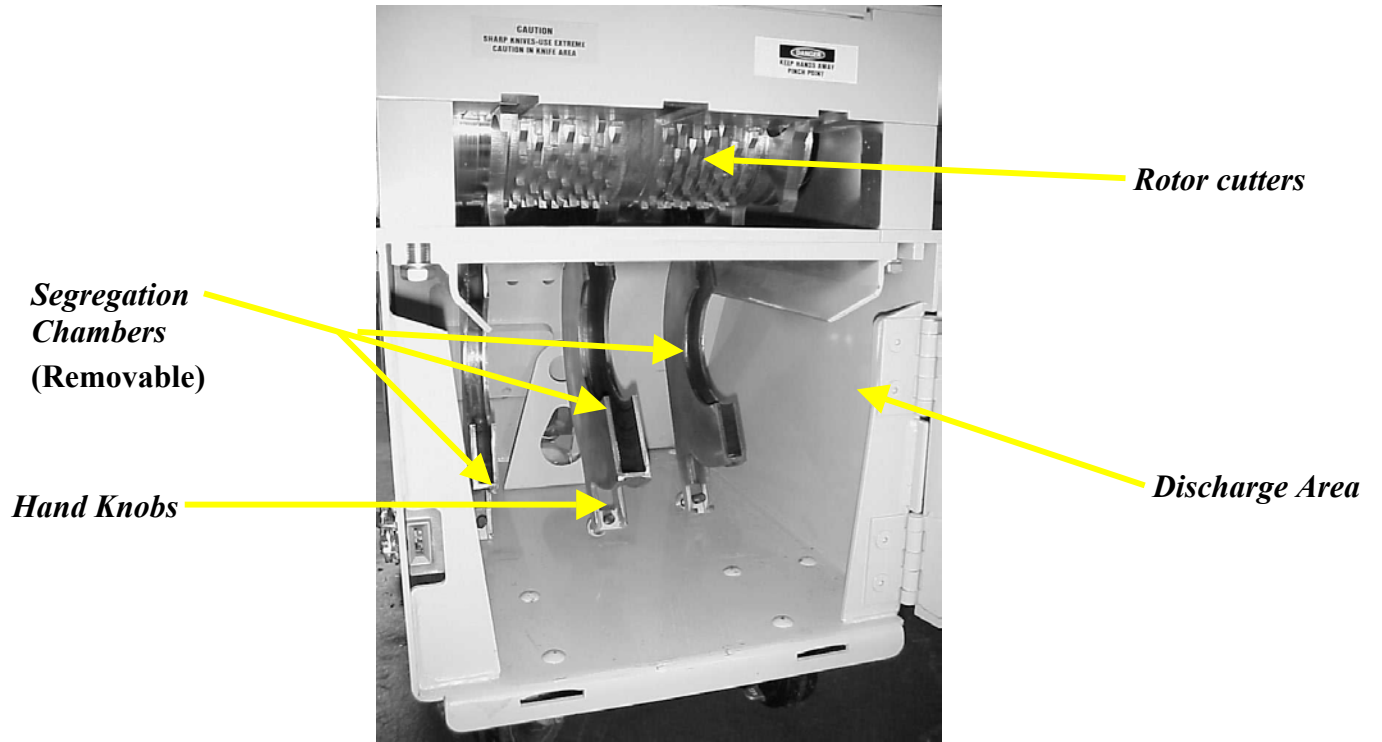

Figure 6: Cutting Chamber Detail

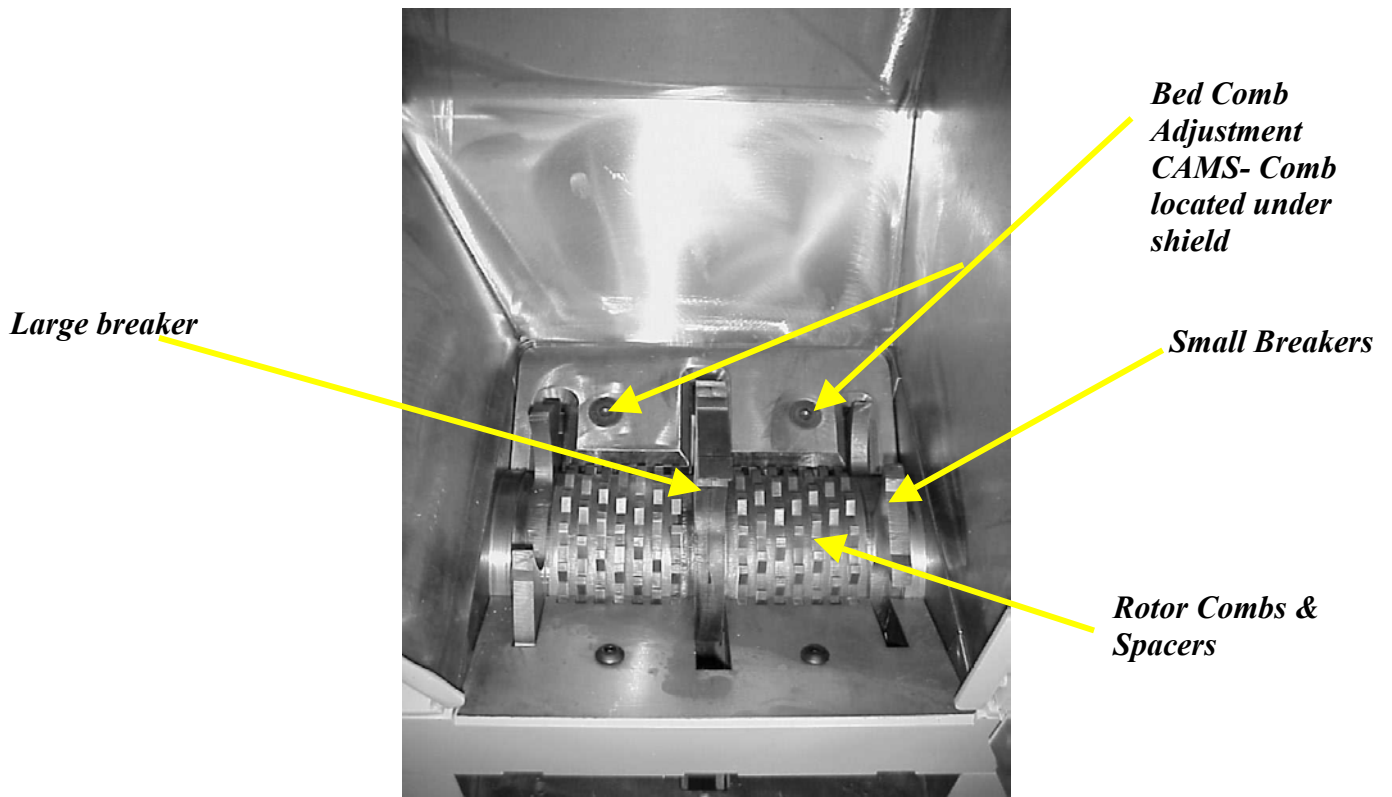
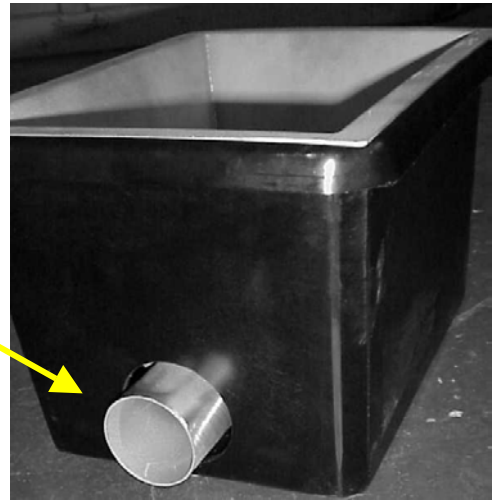
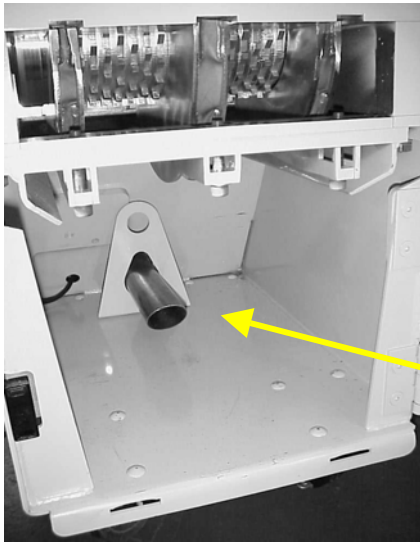
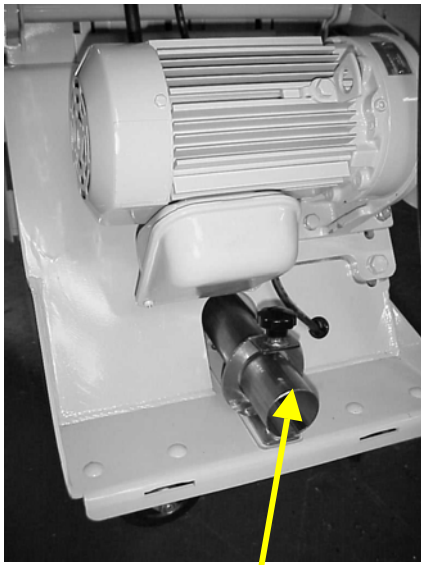

Figure 7: Discharge Options



Rear- Vacuum



Compressed Air Venturi

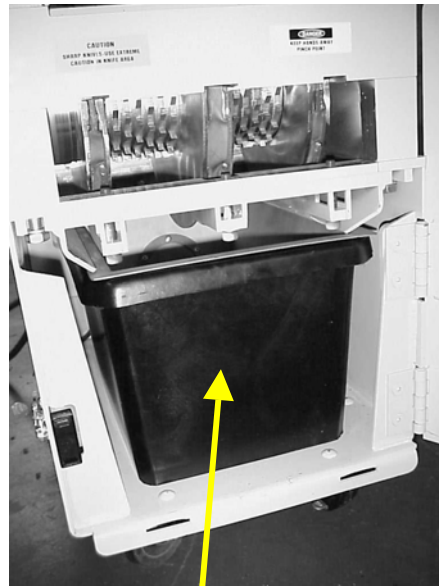

Manual

Figure 8: Knife Bolt/Screw Tightening Torque Specifications

Screw Size	Tightening Torque	
	Lbs./Ft.	NM.
M8	28	38
M10	54	73
M12	100	135
M14	155	210
M16	232	315
M18	340	460
M20	472	640
M24	810	860

Specifications are for Grade 10.9 Fine Threads, in un-lubricated conditions.

Warranty

Sterling, Inc. warrants all equipment manufactured by it to be free from defects in workmanship and material when used under recommended conditions. The Company's obligation is limited to repair or replace (FOB the factory) any parts for a period of 12 months from initial start-up or 18 months from the date of start-up, whichever is less, which in the Company's opinion, are defective.

This parts warranty does not cover any labor charges for replacement of parts, adjustment repairs, or any other work. This warranty does not apply to any equipment which, in the Company's opinion, has been subjected to misuse, negligence, or operation in excess of recommended limits, including freezing or which has been repaired or altered without the Company's express authorization. If the serial number has been defaced or removed from the component, the warranty on that component is void. Defective parts become the property of the warrantor and are to be returned.

The Company is not liable for any incidental, consequential, or special damages or expenses. The Company's obligation for parts not furnished as components of its manufactured equipment is limited to the warranty of the manufacturers of said parts.

Any sales, use, excise, or other tax incident to the replacement of parts under this warranty is the responsibility of the purchaser.

The company neither assumes nor authorizes any other persons to assume for it any liability in connection with the sale of its equipment not expressed in this warranty.

Many types of Sterling, Inc. equipment carry an additional one-year service policy. Consult your Sterling/Sterlco sales representative for specific details.

Sterling, Inc.

PO Box 245018 • 5200 West Clinton Avenue • Milwaukee, WI 53224-9518
Phone (414) 354-0970 • Fax (414) 354-6421
<http://www.sterlco.com>

Sterling, Inc.

Auxiliary Equipment for the Process Industries

PO Box 245018

5200 West Clinton Avenue • Milwaukee, WI 53224-9518

(414) 354-0970 • Fax (414) 354-6421



Scrap

Recovery Systems



Process Heating/

Cooling



**AUTOMATION
Automated**

Parts Removal