



# SD67

## HYDRAULIC SPIKE DRIVER



### SAFETY, OPERATION AND MAINTENANCE USER MANUAL



© 2011 Stanley Black & Decker, Inc.  
New Britain, CT 06053  
U.S.A.  
17488 4/2013 Ver. 4



# TABLE OF CONTENTS

SAFETY SYMBOLS .....	4
SAFETY PRECAUTIONS.....	5
TOOL STICKERS & TAGS .....	6
HOSE TYPES.....	7
HOSE RECOMMENDATIONS .....	8
FIGURE 1. TYPICAL HOSE CONNECTIONS .....	8
HTMA REQUIREMENTS.....	9
OPERATION.....	10
TOOL PROTECTION & CARE .....	11
TROUBLESHOOTING .....	12
FIGURE 2. CHARGING THE ACCUMULATOR.....	13
CHARGING THE ACCUMULATOR.....	13
SPECIFICATIONS.....	14
ACCESSORIES.....	14
SPECIAL TOOLS .....	14
SD67 PARTS ILLUSTRATION .....	15
SD67 PARTS LIST .....	16

## IMPORTANT

To fill out a Product Warranty Recording form, and for information on your warranty, visit [Stanleyhydraulic.com](http://Stanleyhydraulic.com) and select the Warranty tab.  
**(NOTE:** The warranty recording form must be submitted to validate the warranty).

**SERVICING THE STANLEY HYDRAULIC SPIKE DRIVER.** This manual contains safety, operation, and routine maintenance instructions. Stanley Hydraulic Tools recommends that servicing of hydraulic tools, other than routine maintenance, must be performed by an authorized and certified dealer. Please read the following warning.

## ⚠ WARNING

**SERIOUS INJURY OR DEATH COULD RESULT FROM THE IMPROPER REPAIR OR SERVICE OF THIS TOOL.**

**REPAIRS AND / OR SERVICE TO THIS TOOL MUST ONLY BE DONE BY AN AUTHORIZED AND CERTIFIED DEALER.**

For the nearest authorized and certified dealer, call Stanley Hydraulic Tools at the number listed on the back of this manual and ask for a Customer Service Representative.

# SAFETY SYMBOLS

Safety symbols and signal words, as shown below, are used to emphasize all operator, maintenance and repair actions which, if not strictly followed, could result in a life-threatening situation, bodily injury or damage to equipment.



This is the safety alert symbol. It is used to alert you to potential personal injury hazards. Obey all safety messages that follow this symbol to avoid possible injury or death.



This safety alert and signal word indicate an imminently hazardous situation which, if not avoided, will result in death or serious injury.



This safety alert and signal word indicate a potentially hazardous situation which, if not avoided, could result in death or serious injury.



This safety alert and signal word indicate a potentially hazardous situation which, if not avoided, could result in death or serious injury.



This signal word indicates a potentially hazardous situation which, if not avoided, may result in property damage.



This signal word indicates a situation which, if not avoided, will result in damage to the equipment.



This signal word indicates a situation which, if not avoided, may result in damage to the equipment.

Always observe safety symbols. They are included for your safety and for the protection of the tool.

## LOCAL SAFETY REGULATIONS

Enter any local safety regulations here. Keep these instructions in an area accessible to the operator and maintenance personnel.

---

---

---

---

---

---

---

---

---

---

---

---

---

---

---

---

---

---

---

---

---

---

---

---

# SAFETY PRECAUTIONS

Tool operators and maintenance personnel must always comply with the safety precautions given in this manual and on the stickers and tags attached to the tool and hose.

These safety precautions are given for your safety. Review them carefully before operating the tool and before performing general maintenance or repairs.

Supervising personnel should develop additional precautions relating to the specific work area and local safety regulations. If so, place the added precautions in the space provided in this manual.

The SD67 Hydraulic Spike Driver will provide safe and dependable service if operated in accordance with the instructions given in this manual. Read and understand this manual and any stickers and tags attached to the tool and hoses before operation. Failure to do so could result in personal injury or equipment damage.

- Do not operate the tool at oil temperatures above 140 °F/60 °C. Operation at higher temperatures can cause higher than normal temperatures at the tool which can result in operator discomfort.
- Do not operate a damaged, improperly adjusted, or incompletely assembled spike driver.
- Do not weld, cut with an acetylene torch, or hardface the spike driver ram or foot.
- To avoid personal injury or equipment damage, all tool repair, maintenance and service must only be performed by authorized and properly trained personnel.



- Operator must start in a work area without bystanders. The operator must be familiar with all prohibited work areas such as excessive slopes and dangerous terrain conditions.
- Establish a training program for all operators to ensure safe operation.
- Do not operate the tool unless thoroughly trained or under the supervision of an instructor.
- Always wear safety equipment such as goggles, ear and head protection, and safety shoes at all times when operating the tool.
- Do not inspect or clean the tool while the hydraulic power source is connected. Accidental engagement of the tool can cause serious injury.
- Always connect hoses to the tool hose couplers before energizing the hydraulic power source. Be sure all hose connections are tight.

# TOOL STICKERS & TAGS



15431  
SD67 Name Tag

## NOTE:

THE INFORMATION LISTED ON THE STICKERS SHOWN, MUST BE LEGIBLE AT ALL TIMES.

REPLACE DECALS IF THEY BECOME WORN OR DAMAGED. REPLACEMENTS ARE AVAILABLE FROM YOUR LOCAL STANLEY DISTRIBUTOR.

The safety tag (P/N 15875) at right is attached to the tool when shipped from the factory. Read and understand the safety instructions listed on this tag before removal. We suggest you retain this tag and attach it to the tool when not in use.

## DANGER

1. FAILURE TO USE HYDRAULIC HOSE LABELED AND CERTIFIED AS NON-CONDUCTIVE WHEN USING HYDRAULIC TOOLS ON OR NEAR ELECTRICAL LINES MAY RESULT IN DEATH OR SERIOUS INJURY.  
BEFORE USING HOSE LABELED AND CERTIFIED AS NON-CONDUCTIVE ON OR NEAR ELECTRICAL LINES BE SURE THE HOSE IS MAINTAINED AS NON-CONDUCTIVE. THE HOSE SHOULD BE REGULARLY TESTED FOR ELECTRIC CURRENT LEAKAGE IN ACCORDANCE WITH YOUR SAFETY DEPARTMENT INSTRUCTIONS.
2. A HYDRAULIC LEAK OR BURST MAY CAUSE OIL INJECTION INTO THE BODY OR CAUSE OTHER SEVERE PERSONAL INJURY.
  - A. **DO NOT** EXCEED SPECIFIED FLOW AND PRESSURE FOR THIS TOOL. EXCESS FLOW OR PRESSURE MAY CAUSE A LEAK OR BURST.
  - B. **DO NOT** EXCEED RATED WORKING PRESSURE OF HYDRAULIC HOSE USED WITH THIS TOOL. EXCESS PRESSURE MAY CAUSE A LEAK OR BURST.
  - C. CHECK TOOL HOSE COUPLERS AND CONNECTORS DAILY FOR LEAKS. **DO NOT** FEEL FOR LEAKS WITH YOUR HANDS. CONTACT WITH A LEAK MAY RESULT IN SEVERE PERSONAL INJURY.

## IMPORTANT

READ OPERATION MANUAL AND SAFETY INSTRUCTIONS FOR THIS TOOL BEFORE USING IT.

USE ONLY PARTS AND REPAIR PROCEDURES APPROVED BY STANLEY AND DESCRIBED IN THE OPERATION MANUAL.

TAG TO BE REMOVED ONLY BY TOOL OPERATOR.

SEE OTHER SIDE

## DANGER

- D. **DO NOT** LIFT OR CARRY TOOL BY THE HOSES. **DO NOT** ABUSE HOSE. **DO NOT** USE KINKED, TORN OR DAMAGED HOSE.
3. **MAKE SURE** HYDRAULIC HOSES ARE PROPERLY CONNECTED TO THE TOOL BEFORE PRESSURING SYSTEM. SYSTEM PRESSURE HOSE MUST ALWAYS BE CONNECTED TO TOOL "IN" PORT. SYSTEM RETURN HOSE MUST ALWAYS BE CONNECTED TO TOOL "OUT" PORT. REVERSING CONNECTIONS MAY CAUSE REVERSE TOOL OPERATION WHICH CAN RESULT IN SEVERE PERSONAL INJURY.
4. **DO NOT** CONNECT OPEN-CENTER TOOLS TO CLOSED-CENTER HYDRAULIC SYSTEMS. THIS MAY RESULT IN LOSS OF OTHER HYDRAULIC FUNCTIONS POWERED BY THE SAME SYSTEM AND/OR SEVERE PERSONAL INJURY.
5. **BYSTANDERS** MAY BE INJURED IN YOUR WORK AREA. **KEEP BYSTANDERS CLEAR** OF YOUR WORK AREA.
6. **WEAR** HEARING, EYE, FOOT, HAND AND HEAD PROTECTION.
7. **TO AVOID PERSONAL INJURY** OR EQUIPMENT DAMAGE, ALL TOOL REPAIR MAINTENANCE AND SERVICE MUST ONLY BE PERFORMED BY AUTHORIZED AND PROPERLY TRAINED PERSONNEL.

## IMPORTANT

READ OPERATION MANUAL AND SAFETY INSTRUCTIONS FOR THIS TOOL BEFORE USING IT.

USE ONLY PARTS AND REPAIR PROCEDURES APPROVED BY STANLEY AND DESCRIBED IN THE OPERATION MANUAL.

TAG TO BE REMOVED ONLY BY TOOL OPERATOR.

SEE OTHER SIDE

SAFETY TAG P/N 15875 (Shown smaller than actual size)

The rated working pressure of the hydraulic hose must be equal to or higher than the relief valve setting on the hydraulic system. There are three types of hydraulic hose that meet this requirement and are authorized for use with Stanley Hydraulic Tools. They are:

**Certified non-conductive** — constructed of thermoplastic or synthetic rubber inner tube, synthetic fiber braid reinforcement, and weather resistant thermoplastic or synthetic rubber cover. *Hose labeled **certified non-conductive** is the only hose authorized for use near electrical conductors.*

**Wire-braided** (conductive) — constructed of synthetic rubber inner tube, single or double wire braid reinforcement, and weather resistant synthetic rubber cover. *This hose is **conductive** and must never be used near electrical conductors.*

**Fabric-braided** (not certified or labeled non-conductive) — constructed of thermoplastic or synthetic rubber inner tube, synthetic fiber braid reinforcement, and weather resistant thermoplastic or synthetic rubber cover. *This hose is **not certified non-conductive** and must never be used near electrical conductors.*

## HOSE SAFETY TAGS

To help ensure your safety, the following DANGER tags are attached to all hose purchased from Stanley Hydraulic Tools. **DO NOT REMOVE THESE TAGS.**

If the information on a tag is illegible because of wear or damage, replace the tag immediately. A new tag may be obtained from your Stanley Distributor.

### THE TAG SHOWN BELOW IS ATTACHED TO “CERTIFIED NON-CONDUCTIVE” HOSE

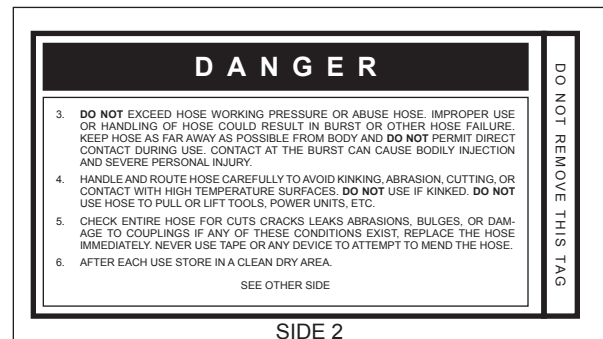
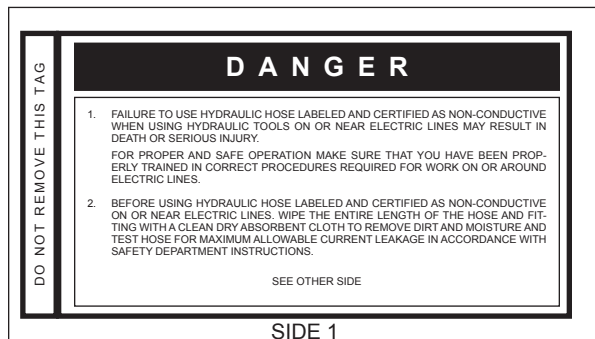

(Shown smaller than actual size)

### THE TAG SHOWN BELOW IS ATTACHED TO “CONDUCTIVE” HOSE.

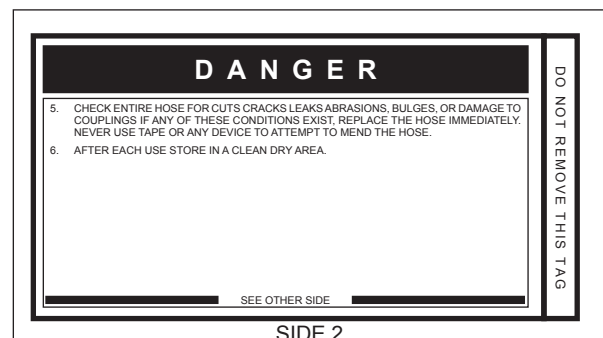
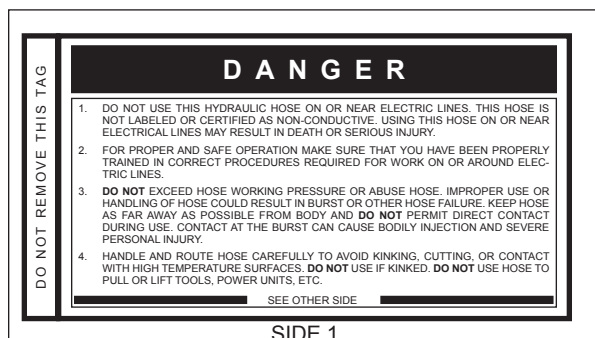

(Shown smaller than actual size)

# HOSE RECOMMENDATIONS

## Tool to Hydraulic Circuit Hose Recommendations

The chart to the right shows recommended minimum hose diameters for various hose lengths based on gallons per minute (gpm)/liters per minute (lpm). These recommendations are intended to keep return line pressure (back pressure) to a minimum acceptable level to ensure maximum tool performance.

This chart is intended to be used for hydraulic tool applications only based on Stanley Hydraulic Tools tool operating requirements and should not be used for any other applications.

All hydraulic hose must have at least a rated minimum working pressure equal to the maximum hydraulic system relief valve setting.

**All hydraulic hose must meet or exceed specifications as set forth by SAE J517.**

Oil Flow		Hose Lengths		Inside Diameter		USE (Press/Return)	Min. Working Pressure	
GPM	LPM	FEET	METERS	INCH	MM		PSI	BAR
<b>Certified Non-Conductive Hose - Fiber Braid - for Utility Bucket Trucks</b>								
4-9	15-34	up to 10	up to 3	3/8	10	Both	2250	155
<b>Conductive Hose - Wire Braid or Fiber Braid -DO NOT USE NEAR ELECTRICAL CONDUCTORS</b>								
4-6	15-23	up to 25	up to 7.5	3/8	10	Both	2500	175
4-6	15-23	26-100	7.5-30	1/2	13	Both	2500	175
5-10.5	19-40	up to 50	up to 15	1/2	13	Both	2500	175
5-10.5	19-40	51-100	15-30	5/8	16	Both	2500	175
5-10.5	19-40	100-300	30-90	5/8	16	Pressure	2500	175
10-13	38-49	up to 50	up to 15	3/4	19	Return	2500	175
10-13	38-49	51-100	15-30	5/8	16	Both	2500	175
10-13	38-49	100-200	30-60	3/4	19	Pressure	2500	175
13-16	49-60	up to 25	up to 8	5/8	16	Pressure	2500	175
13-16	49-60	26-100	8-30	3/4	19	Return	2500	175
				1	25.4	Return	2500	175
				5/8	16	Pressure	2500	175
				3/4	19	Return	2500	175
				3/4	19	Pressure	2500	175
				1	25.4	Return	2500	175

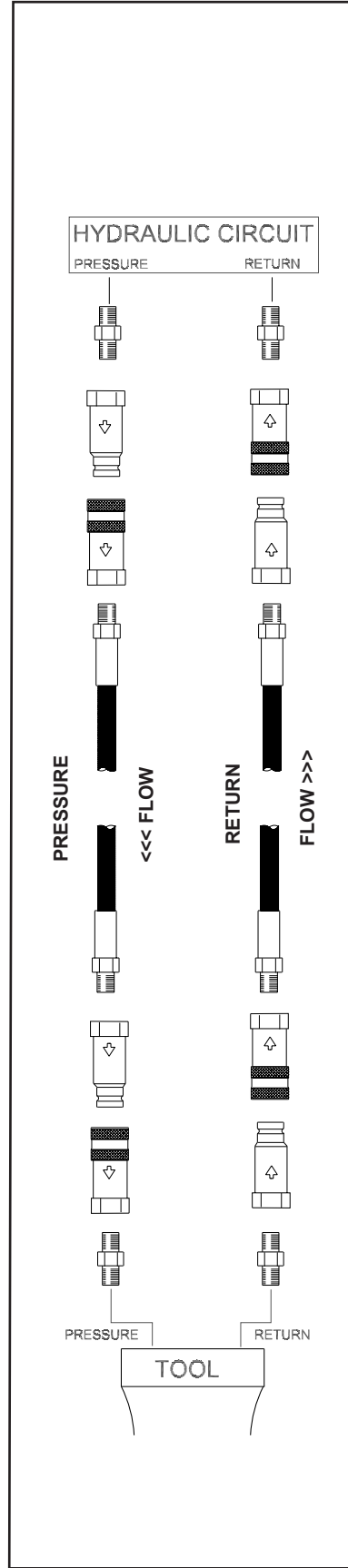

Figure 1. Typical Hose Connections



# HTMA / EHTMA REQUIREMENTS

## HTMA / EHTMA REQUIREMENTS

### HTMA





#### HYDRAULIC SYSTEM REQUIREMENTS

#### TOOL TYPE

	TYPE I	TYPE II	TYPE RR	TYPE III
Flow Range	4-6 gpm (15-23 lpm)	7-9 gpm (26-34 lpm)	9-10.5 gpm (34-40 lpm)	11-13 gpm (42-49 lpm)
Nominal Operating Pressure (at the power supply outlet)	1500 psi (103 bar)	1500 psi (103 bar)	1500 psi (103 bar)	1500 psi (103 bar)
System relief valve setting (at the power supply outlet)	2100-2250 psi (145-155 bar)	2100-2250 psi (145-155 bar)	2200-2300 psi (152-159 bar)	2100-2250 psi (145-155 bar)
Maximum back pressure (at tool end of the return hose)	250 psi (17 bar)	250 psi (17 bar)	250 psi (17 bar)	250 psi (17 bar)
Measured at a max. fluid viscosity of: (at min. operating temperature)	400 ssu* (82 centistokes)	400 ssu* (82 centistokes)	400 ssu* (82 centistokes)	400 ssu* (82 centistokes)
Temperature: Sufficient heat rejection capacity to limit max. fluid temperature to: (at max. expected ambient temperature)	140° F (60° C)	140° F (60° C)	140° F (60° C)	140° F (60° C)
Min. cooling capacity at a temperature difference of between ambient and fluid temps	3 hp (2.24 kW) 40° F (22° C)	5 hp (3.73 kW) 40° F (22° C)	6 hp (5.22 kW) 40° F (22° C)	7 hp (4.47 kW) 40° F (22° C)
<b>NOTE:</b> Do not operate the tool at oil temperatures above 140° F (60° C). Operation at higher temperatures can cause operator discomfort at the tool.				
Filter Min. full-flow filtration Sized for flow of at least: (For cold temp. startup and max. dirt-holding capacity)	25 microns 30 gpm (114 lpm)	25 microns 30 gpm (114 lpm)	25 microns 30 gpm (114 lpm)	25 microns 30 gpm (114 lpm)
Hydraulic fluid Petroleum based (premium grade, anti-wear, non-conductive) Viscosity (at min. and max. operating temps)	100-400 ssu*	100-400 ssu* (20-82 centistokes)	100-400 ssu*	100-400 ssu*
<b>NOTE:</b> When choosing hydraulic fluid, the expected oil temperature extremes that will be experienced in service determine the most suitable temperature viscosity characteristics. Hydraulic fluids with a viscosity index over 140 will meet the requirements over a wide range of operating temperatures.				
*SSU = Saybolt Seconds Universal				

### EHTMA HYDRAULIC SYSTEM REQUIREMENTS

#### CLASSIFICATION

					
Flow Range	3.5-4.3 gpm (13.5-16.5 lpm)	4.7-5.8 gpm (18-22 lpm)	7.1-8.7 gpm (27-33 lpm)	9.5-11.6 gpm (36-44 lpm)	11.8-14.5 gpm (45-55 lpm)
Nominal Operating Pressure (at the power supply outlet)	1870 psi (129 bar)	1500 psi (103 bar)	1500 psi (103 bar)	1500 psi (103 bar)	1500 psi (103 bar)
System relief valve setting (at the power supply outlet)	2495 psi (172 bar)	2000 psi (138 bar)	2000 psi (138 bar)	2000 psi (138 bar)	2000 psi (138 bar)

**NOTE:** These are general hydraulic system requirements. See tool specification page for tool specific requirements

# OPERATION

## PRE-OPERATION PROCEDURES

### PREPARATION FOR INITIAL USE

Each unit as shipped has no special unpacking or assembly requirements prior to usage. Inspection to assure the unit was not damaged in shipping and does not contain packing debris is all that is required.

### CHECK HYDRAULIC POWER SOURCE

1. Using a calibrated flowmeter and pressure gauge, check that the hydraulic power source develops a flow of 7–10 gpm/26–38 lpm at 2000 psi/105–140 bar.
2. Make certain the hydraulic power source is equipped with a relief valve set to open at 2100–2250 psi/145–155 bar minimum.
3. Check that the hydraulic circuit matches the tool for open-center (OC) operation.

### CHECK TOOL

1. Make sure all tool accessories are correctly installed. Failure to install tool accessories properly can result in damage to the tool or personal injury.
2. There should be no signs of leaks.
3. The tool should be clean, with all fittings and fasteners tight.

### CHECK TRIGGER MECHANISM

1. Check that the trigger operates smoothly and is free to travel between the **ON** and **OFF** positions.

### CONNECT HOSES

1. Wipe all hose couplers with a clean lint-free cloth before making connections.
2. Connect the hoses from the hydraulic power source to the hose couplers on the spike driver. It is a good practice to connect the return hose first and disconnect it last to minimize or avoid trapped pressure within the spike driver.
3. Observe flow indicators stamped on hose couplers to be sure that oil will flow in the proper direction. The female coupler is the inlet coupler.

### NOTE:

The pressure increase in uncoupled hoses left in the sun may result in making them difficult to connect. **When possible, connect the free ends of operating hoses together.**

## OPERATING PROCEDURES

1. Observe all safety precautions.
2. Move the hydraulic circuit control valve to the **ON** position.
3. Place the spike driver foot firmly on the spike to be driven.
4. Squeeze the trigger to start the spike driver. Adequate down pressure is very important. When the spike fully sets in the tie, release the trigger.

### NOTE:

**Partially depressing the trigger allows the tool to operate at a slow speed, making it easy to start the spike in the tie.**

## COLD WEATHER OPERATION

If the spike driver is to be used during cold weather, pre-heat the hydraulic fluid at low engine speed. When using the normally recommended fluids, fluid temperature should be at or above 50 °F/10 °C (400 ssu/82 centistokes) before use.

## NOTICE

In addition to the Safety Precautions found in this manual, observe the following for equipment protection and care.

- Always store an idle tool in a clean dry space, safe from damage or pilferage.
- Do not exceed the rated limits or use the tool for applications beyond its design capacity.
- Always keep critical tool markings, such as labels and warning stickers legible.
- Always replace hoses, couplings and other parts with replacement parts recommended by Stanley Hydraulic Tools. Supply hoses must have a minimum working pressure rating of 2500 psi/175 bar.
- Permit only experienced personnel to perform tool repair.
- Be sure to wipe all couplers clean before connecting. Use only lint-free cloths.
- The hydraulic circuit control valve must be in the **OFF** position when coupling or uncoupling the grinder. Failure to do so may result in damage to the quick couplers and cause overheating of the hydraulic system.
- Check fastener tightness often and before each use daily.

# TROUBLESHOOTING

If symptoms of poor performance develop, the following chart can be used as a guide to correct the problem.

When diagnosing faults in operation of the spike driver, always check that the hydraulic power source is supplying the correct hydraulic flow and pressure to the spike driver as listed in the table. Use a flowmeter known to be accurate. Check the flow with the hydraulic oil temperature at least 80 °F/27 °C.

<b>Problem</b>	<b>Cause</b>	<b>Solution</b>
Spike driver does not run.	Power unit not functioning.	Check power unit for proper flow and pressure (7–10 gpm   26–38 lpm, 2000 psi   140 bar).
	Couplers or hoses blocked.	Remove restriction.
	Pressure and return line hoses reversed at ports.	Be sure hoses are connected to their proper ports.
	Mechanical failure of piston or automatic valve.	Have inspected and repaired by authorized dealer.
Spike driver does not hit effectively.	Power unit not functioning.	Check power unit for proper flow and pressure (7–10 gpm   26–38 lpm, 2000 psi   140 bar).
	Couplers or hose blocked.	Remove restriction.
	Low accumulator charge (pressure hose will pulse more than normal).	Have recharge by authorized dealer.
	Fluid too hot (above 140 °F/60 °C).	Provide cooler to maintain proper fluid temperature.
	Ram is not sliding freely in the spike driver foot.	Remove, clean and replace as required.
Spike driver operates slow.	Low oil flow from power unit.	Check power source for proper flow.
	High back pressure.	Check hydraulic system for excessive back pressure and correct as required.

# CHARGING THE ACCUMULATOR

To check or charge the accumulator the following equipment is required:

- Accumulator tester (Part Number 02835).
  - Charging assembly (P/N 31254—includes a regulator, hose and fitting).
  - Nitrogen bottle with an 800 psi/56 bar minimum charge.
1. On charge valves containing 5/8 inch hex locking nuts, first loosen the locking nut 1-1/2 turns.
  2. Holding the chuck end of the Stanley tester (P/N 02835), turn the gauge fully counterclockwise to ensure the stem inside the chuck is completely retracted.
  3. Thread the tester onto the charging valve of the tool accumulator (do not advance the gauge end into the chuck end. Turn as a unit). Seat the chuck on the accumulator charging valve and hand tighten only.
  4. Advance the valve stem by turning the gauge end clockwise.
  5. Connect the charging assembly to the valve on the tester.

6. Adjust the regulator on the nitrogen bottle to 600 psi/42 bar.

## NOTE:

**It may be necessary to set the regulator at 650–700 psi/45–48 bar to overcome any pressure drop through the charging system.**

7. Open the valve on the charging assembly hose. When the tester gauge reads 600–700 psi/42–48 bar, close the valve on the charging assembly hose and remove the charging valve.
8. Turn the gauge end of the tester fully counterclockwise to retract the plunger in the chuck. Remove the tester from the charger valve.
9. On charge valves containing 5/8 inch hex locking nuts, tighten the locking nut.

## TESTING THE ACCUMULATOR

1. Follow Steps 1 through 4 under CHARGING THE ACCUMULATOR.
2. Read the pressure on the gauge (pressure should be between 500–600 psi/35–42 bar).
3. If the pressure is low, recharge the tool.

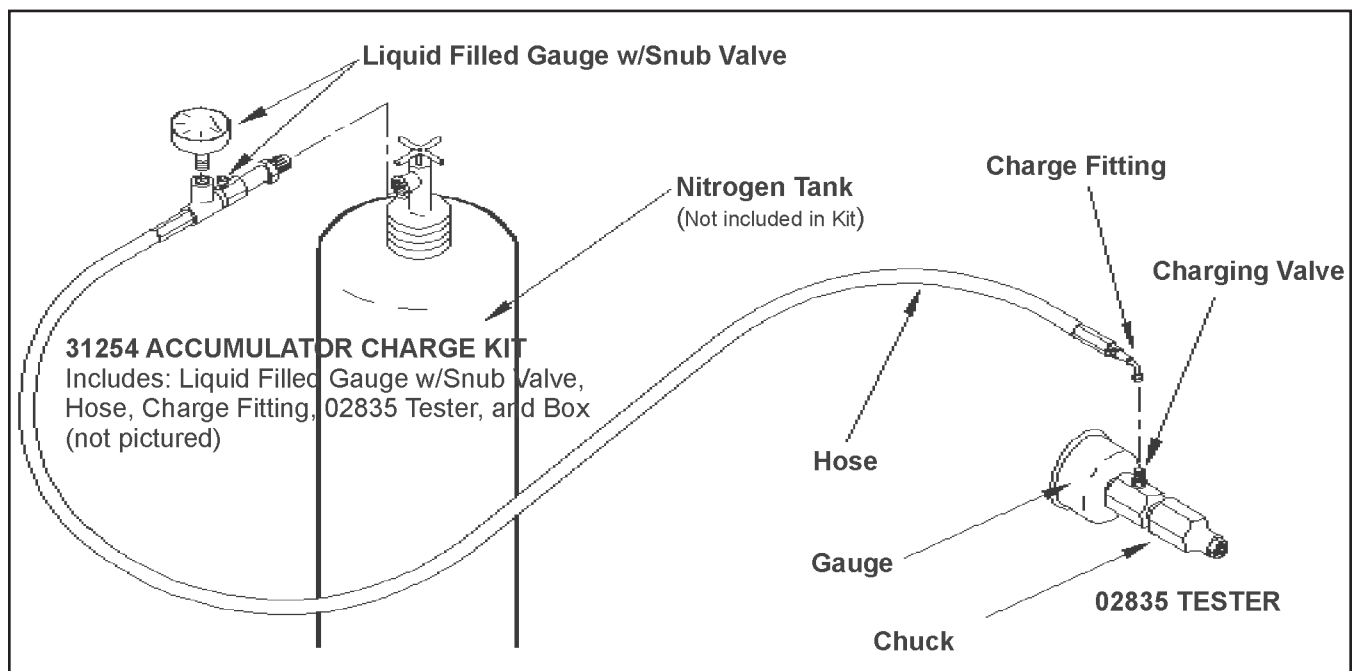

Figure 2. Charging the Accumulator

# SPECIFICATIONS

Capacity (Spike Head).....	1.9 in dia/4.8 cm dia
Pressure Range.....	2000 psi/140 bar
Blows Per Minute.....	1300 to 1800
Maximum Back Pressure.....	250 psi/17 bar
Flow Range .....	5–10 gpm/20–38 lpm
Porting .....	-8 SAE O-ring
Couplers .....	HTMA/EHTMA Flush Face Type Male & Female
Connect Size and Type .....	3/8 in. Male Pipe Adapter
Hose Whips .....	Yes
Weight	
Anti-Vibration Handle Model.....	65 lbs/30 kg
Anti-Vibration Handle w/ Extended Foot Model.....	68 lbs/31 kg
Overall Length – Standard Foot .....	25.25 in/64 cm
Overall Length – Extended Foot.....	28.75 in/73 cm
Overall Width – Anti-Vibration Handle .....	16 in/40.6 cm
Maximum Fluid Temperature .....	140 °F/60 °C
EHTMA Category.....	“C” (20 lpm@ 138 bar) or “D” (30 lpm@ 138 bar)
Noise Level.....	Lwa 106
Vibration Level.....	20.0 m/s <sup>2</sup>

## ACCESSORIES

Dome Head Spike Cup.....	25525
Hairpin Cup.....	23345
Cutspike Cup.....	23344

## SPECIAL TOOLS

O-ring Tool Kit.....	04337
Split Rings (Used with 04910) .....	04908
Spacer .....	04909
Flow Sleeve Removal Tube (Used with 04908 & 05508) .....	04910
Accumulator Disassembly Tool (Used with 04910) .....	05508
Accumulator Cylinder Puller .....	05640
Accumulator Plug Wrench .....	29135
Sleeve.....	30939
Collet 7/8 inch.....	30956

# SD67 PARTS ILLUSTRATION

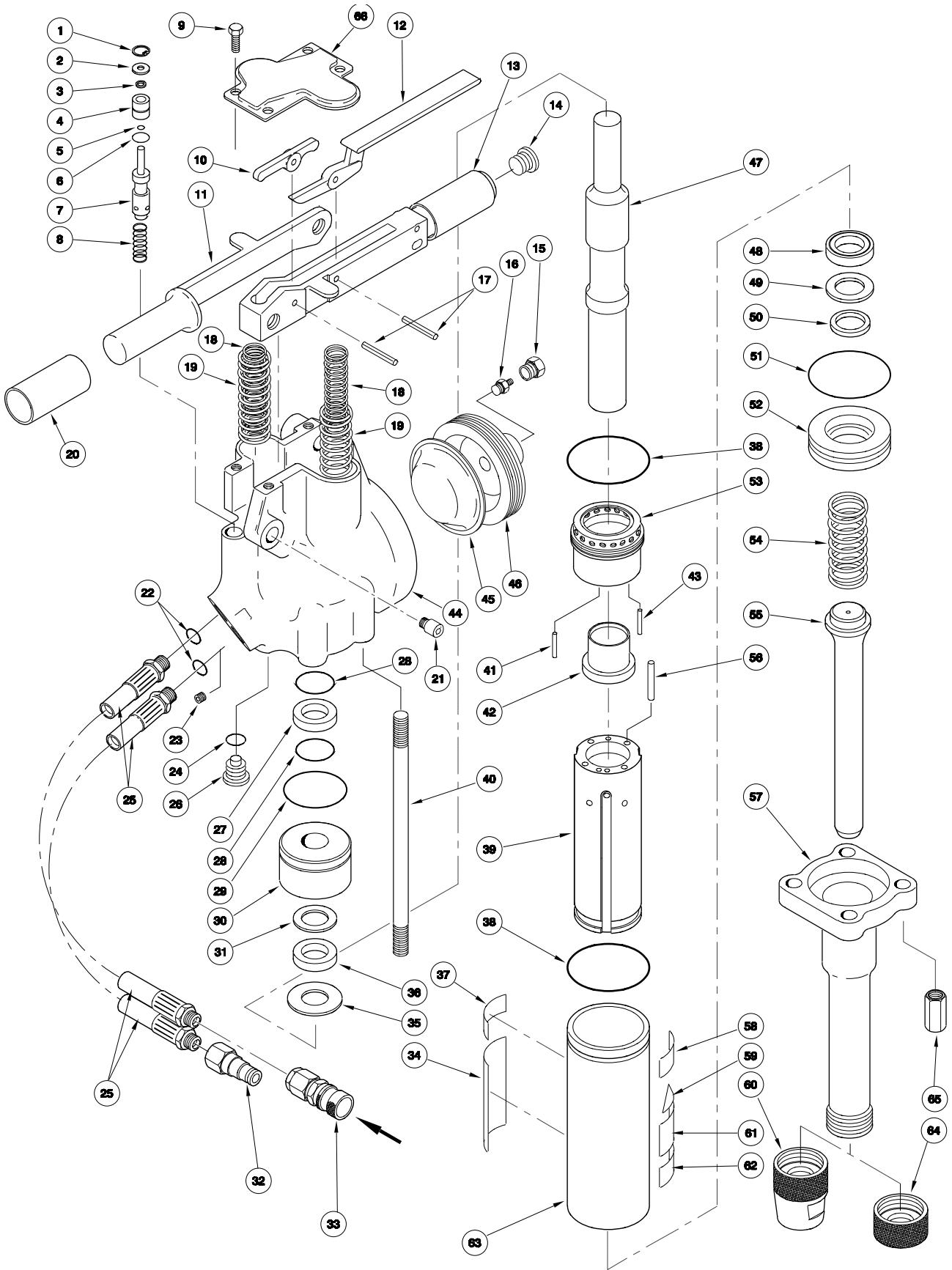

# SD67 PARTS LIST

ITEM	PART NO.	QTY	DESCRIPTION
1	24067	1	RETAINING RING
2	04055	1	WASHER
3	04056	1	ROD WIPER *
4	26451	1	BUSHING
5	01362	1	O-RING 5/16 × 7/16 × 1/16 *
6	00293	1	O-RING 11/16 × 7/8 × 3/32 *
7	20515	1	VALVE SPOOL
8	04058	1	SPRING
9	07628	4	CAPSCREW
10	20511	1	LEVER
11	28369	1	HANDLE
12	20502	1	TRIGGER
13	29045	1	TRIGGER HANDLE
14	16607	1	SAE PLUG
15	07493	1	PLUG
16	20499	1	CHARGE VALVE
17	20500	2	SPIROL PIN
18	20541	2	SPRING
19	20498	2	SPRING
20	02494	2	HANDLE GRIP
21	20508	2	PIVOT SCREW
22	01605	2	O-RING 3-908-R17 *
23	12832	1	ORIFICE PLUG
24	06891	1	O-RING *
25	56725	2	HOSE ASSY PARKER
	66727	2	HOSE ASSY AEROQUIP
26	31067	1	PLUG
27	26452	1	SINTERED FILTER
28	04795	2	O-RING 2-218-70D *
29	16732	1	O-RING 2-230-90D *
30	26448	1	SPACER
31	04062	1	BACKUP WASHER
32	03973	1	MALE COUPLER BODY
33	03972	1	FEMALE COUPLER BODY
34	15431	1	NAME TAG STICKER
35	04064	1	WASHER
36	04063	1	CUP SEAL
37	25610	1	RAILROAD HELP DESK STICKER
38	04054	2	O-RING 2-7/8 × 3-1/8 × 1/8 90D *
39	04069	1	FLOW SLEEVE
40	04071	4	SIDE ROD
41	07890	1	ROLL PIN
42	04065	1	AUTOMATIC VALVE
43	04571	2	PUSH PIN

ITEM	PART NO.	QTY	DESCRIPTION
44	26596	1	ACCUMULATOR VALVE BLOCK
45	26574	1	ACCUMULATOR DIAPHRAGM
46	26449	1	ACCUMULATOR PLUG
47	04070	1	PISTON
48	34127	1	CUP SEAL *
49	13837	1	SEAL WASHER
50	04074	1	ROD WIPER *
51	04073	1	O-RING 2-5/8 × 2-7/8 × 1/8 90D*
52	15419	1	SEAL CARRIER
53	04066	1	AUTOMATIC VALVE BODY
54	44873	1	SPRING
55	15420	1	RAM (STD FOOT)
	28207	1	RAM (EXTENDED FOOT)
56	04067	4	PUSH PIN
57	23342	1	SPIKE DRIVER FOOT (STD)
	28206	1	SPIKE DRIVER FOOT (EXTENDED)
58	—	—	NO ITEM
59	—	—	NO ITEM
60	23345	1	HAIR PIN SPIKE CUP
61	—	—	NO ITEM
62	—	—	NO ITEM
63	04068	1	FLOW SLEEVE TUBE
64	23344	1	HEADED SPIKE CUP
65	04075	4	SIDE ROD NUT
66	26450	1	TOP PLATE
	04596	1	SEAL KIT (INCL PARTS W/ *)

## MODEL DESCRIPTIONS

**SD67121:** Anti-Vibration Handles and Standard Foot with Changeable Cups

**SD67131:** Anti-Vibration Handles and Extended Foot with Changeable Cups







Stanley Hydraulic Tools  
3810 SE Naef Road  
Milwaukie, Oregon 97267-5698 USA  
(503) 659-5660 / Fax (503) 652-1780  
[www.stanleyhydraulic.com](http://www.stanleyhydraulic.com)

**IMPORTANT**

To fill out a Product Warranty Recording form, and for information on your warranty, visit [Stanleyhydraulic.com](http://Stanleyhydraulic.com) and select the Warranty tab.  
**(NOTE:** The warranty recording form must be submitted to validate the warranty).