

Portable MiniDisc Recorder

Operating Instructions



"WALKMAN" is a registered trademark of Sony Corporation to represent Headphone Stereo products.  WALKMAN is a trademark of Sony Corporation.

MZ-R410/R410DPC

WARNING

To prevent fire or shock hazard, do not expose the unit to rain or moisture.

Do not install the appliance in a confined space, such as a bookcase or built-in cabinet.

To prevent fire, do not cover the ventilation of the apparatus with news papers, table cloths, curtains, etc. And don't place lighted candles on the apparatus.

To prevent fire or shock hazard, do not place objects filled with liquids, such as vases, on the apparatus.

Certain countries may regulate disposal of the battery used to power this product. Please consult with your local authority.

Caution

The use of optical instruments with this product will increase eye hazard.

**CAUTION — INVISIBLE LASER
RADIATION WHEN OPEN
AVOID EXPOSURE TO BEAM**

Information

IN NO EVENT SHALL SELLER BE LIABLE FOR ANY DIRECT, INCIDENTAL OR CONSEQUENTIAL DAMAGES OF ANY NATURE, OR LOSSES OR EXPENSES RESULTING FROM ANY DEFECTIVE PRODUCT OR THE USE OF ANY PRODUCT.



The validity of the CE marking is restricted to only those countries where it is legally enforced, mainly in the countries EEA (European Economic Area).

Table of contents

Checking the supplied accessories	8
<hr/>	
Looking at the controls	9
<hr/>	
Getting started!	11
<hr/>	
Recording an MD right away! (Synchro-recording)	13
<hr/>	
Playing an MD right away!	17
<hr/>	
Various ways of recording	19
Note on digital and analog recording (Digital input and analog input)	19
Recording in analog (Analog Recording)	20
Long-time recording (MDLP)	21
When you do not want “LP:” added automatically at the beginning of a track	22
Recording tracks using the group function (Group Mode Recording)	22
To activate group mode (Group Mode Recording)	23
Recording a track into a new group	23
Recording a track into an existing group	24
Recording without overwriting existing material	24
Adding track marks automatically (Auto Time Stamp)	25
Adjusting the recording level manually (Manual Recording)	26
Checking the remaining recordable time	27

Various ways of playback	29
Using the group function (Group Mode)	29
Listening to tracks in a specific group (Group Mode Playback) ...	29
Selecting and playing groups (Group Skip Mode)	29
Changing play modes	30
Creating a program (Program Play)	31
Adjusting treble or bass (Digital Sound Preset)	32
Selecting the sound quality	32
Adjusting the sound quality	32
Checking the remaining time or the playing position	33

Editing recorded tracks	34
Labeling/relabeling recordings	34
Labeling recordings	35
Relabeling recordings	36
Registering tracks or groups as a new group (Group Setting)	36
To release a group setting	37
Moving recorded tracks	38
Moving a track to a different group	39
Changing the order of a group on a disc (Group Move)	39
Adding a track mark	40
Erasing a track mark	40
Erasing tracks	41
To erase a track	41
To erase the whole disc	42
To erase a group	42

Other operations	43
Protecting your hearing (AVLS)	43
Turning off the beep sound	43
Locking the controls (HOLD)	44

Power sources	45
Battery life	45

Additional information	46
Precautions	46
System limitations	48
Troubleshooting	49
Messages	52
List of menus	54
Specifications	59
Explanations	60
Index	62

Checking the supplied accessories

- AC power adaptor (1)
- Headphones/earphones (1)
- Optical cable (1)

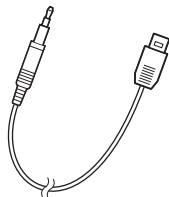
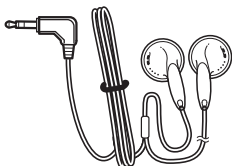
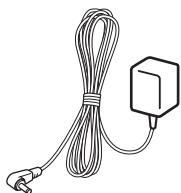

- Digital PCLink kit (supplied with MZ-R410DPC only) (1)
- AC plug adaptor (supplied with MZ-R410DPC) (1)

Looking at the controls

The recorder

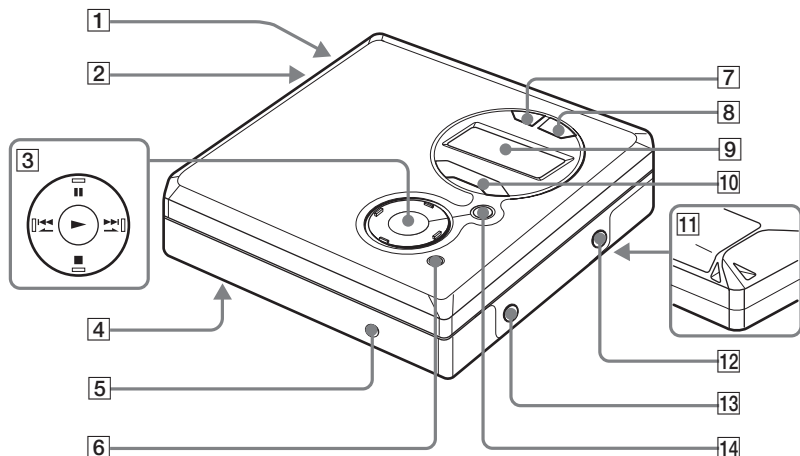

- 1** OPEN button
- 2** Battery compartment
- 3** 5-position control key
 - ▶ *(play)
 - ▬▬ (pause)
 - (stop)
 - ◀◀▶▶ (search, AMS)
 - * The ▶ has a tactile dot.
- 4** HOLD switch
- 5** DC IN 3V jack
- 6** MENU/ENTER button
- 7** GROUP/CANCEL button
- 8** END SEARCH button
- 9** Display window
- 10** VOL +, - button
The VOL + button has a tactile dot.
- 11** Handstrap hole
Use the hole to attach your own strap.
- 12** LINE IN (OPTICAL) jack
- 13** ◡ (headphones/earphones) jack
- 14** REC/T MARK button

The display window of the recorder

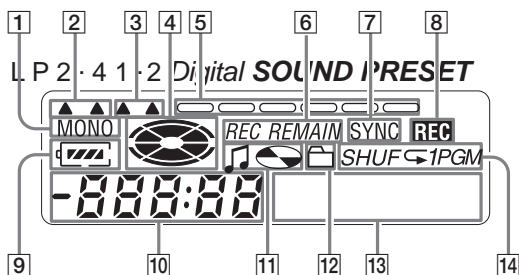

- | | |
|--|--|
| <p>1 MONO (monaural) indication</p> <p>2 LP mode indication</p> <p>3 Sound indication</p> <p>4 Disc indication
Shows that the disc is rotating for recording, playing or editing an MD.</p> <p>5 Level meter
Shows the volume of the MD being played or recorded.</p> <p>6 REC REMAIN/REMAIN (remaining time/tracks) indication
Lights up along with the remaining time of the track, the remaining time of the MD, or the remaining number of tracks.</p> <p>7 SYNC (synchro-recording) indication</p> | <p>8 REC indication
Lights up while recording. When flashing, the recorder is in record standby mode.</p> <p>9 Battery indication
Shows approximate battery condition.</p> <p>10 Time display</p> <p>11 Disc name/track name indication
Lights up when labeling a disc or a track.</p> <p>12 Group indication
Lights up when group mode is on.</p> <p>13 Character information display
Displays the disc and track names, error messages, track numbers, etc.</p> <p>14 Play mode indication
Shows play mode of the MD.</p> |
|--|--|

Getting started!

1 Connecting to a power source.

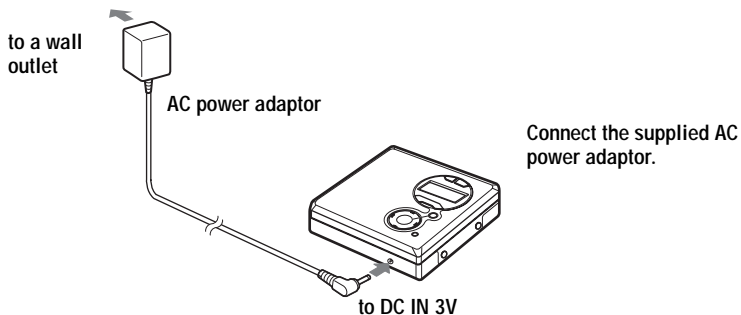

Using the dry battery

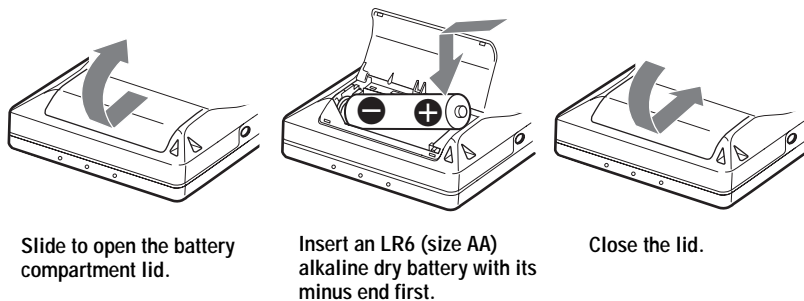

2 Make connections and unlock the control.

- ① Connect the headphones/earphones to .

- ② Slide HOLD in the opposite direction of the arrow indicated on the recorder (HOLD ) to unlock the control.

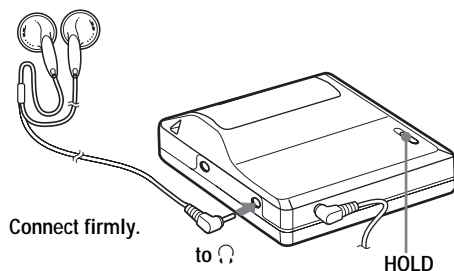

For models supplied with the AC plug adaptor

If the AC power adaptor does not fit the wall outlet, use the AC plug adaptor.

Battery life

For details, refer to “Battery life” (page 45).

(Unit: approx.hours)

LR6 (size AA) Sony alkaline dry battery	SP Stereo	LP2 Stereo	LP4 Stereo
When recording	8	13	19
When playing	37	46	51

Recording an MD right away! (Synchro-recording)

This section explains the basic procedure for making digital recordings using an optical cable connected to a CD player, Digital TV or other digital equipment. (For further information, see “Note on digital recording” (page 60).) During synchro-recording, the recorder starts and stops recording in sync with the sound source. Track marks are added wherever they appear in the sound source. It is recommended to use the AC power adaptor when recording.

To record from an analog source such as a cassette deck or a radio → “Recording in analog (Analog Recording)” (page 20).

To record using group mode → “Recording tracks using the group function (Group Mode Recording)” (page 22).

1 Insert an MD.

(Use a recordable MD for recording)

① Press OPEN to open the lid.

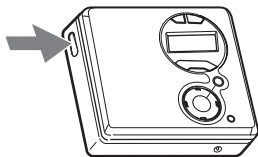

② Insert an MD with the label side facing front, and press the lid down to close.

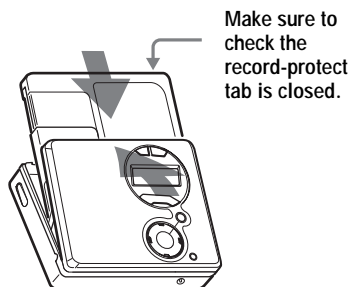

continued

2 Make connections. (Insert the cables firmly and completely into the appropriate jacks)

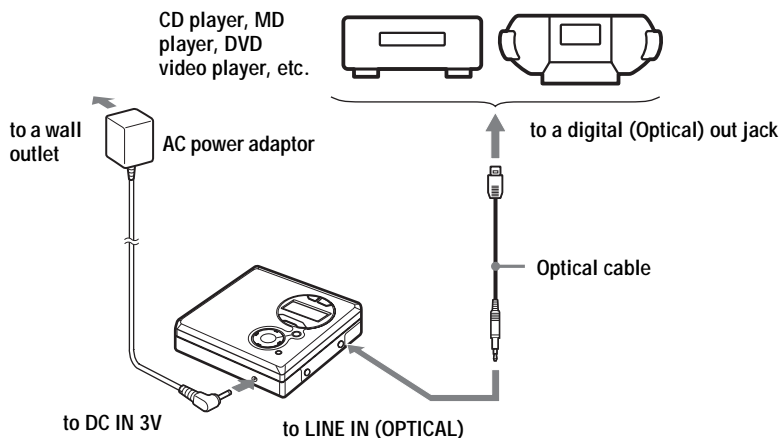

3 Record an MD.

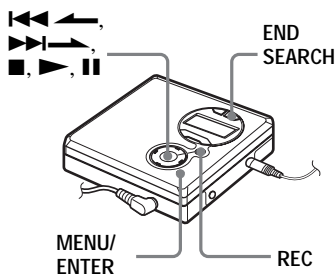

- 1 While the recorder is stopped, press MENU.
Menu items appear in the display.

- 2 Press or repeatedly until "SYNC-R" flashes in the display, and then press ENTER.
- 3 Press or repeatedly until "ON" flashes in the display, and then press ENTER.
- 4 Press while pressing REC.
The recorder pauses and stands by for recording.
- 5 Play the source you want to record.
The recorder starts recording automatically when it receives the playing sound.

To stop recording, press ■.

After you press ■ to stop, the recorder will automatically turn off in about 10 seconds (when using the dry battery) or about 3 minutes (when using the AC power adaptor).

To cancel synchro-recording

Press ◀ or ▶ repeatedly until "OFF" flashes in the display in step 3, and then press ENTER.

Note

If you record on a previously recorded disc, the recorder is factory set to overwrite the entire contents of the disc. If you want the recording to start after the existing contents, do the procedure "Recording without overwriting existing material" (page 24) before doing step 3, "Record an MD." (page 14).

To	Press
Record from the end of the current contents ¹⁾	If "R-Posi" (the record-starting position setting) is set to "FrHere", press END SEARCH, and then press ▶ while pressing REC. ¹⁾ If "R-Posi" is set to "Fr End", press ▶ while pressing REC.
Record over partway through the previous recording ¹⁾	▶, ◀◀, or ▶▶ to find the start point of recording and press ■ to stop. Then press ▶ while pressing REC.
Pause	²⁾ . Press again to resume recording.
Remove the MD	■ and open the lid. ³⁾ (The lid does not open while "Edit" is flashing in the display.)

¹⁾ If "R-Posi" is set to "Fr End", recording operations will always start from the end of the previously recorded material without pressing END SEARCH button (page 25).

²⁾ A track mark is added at the point where you press || again to resume recording while pausing; thus the remainder of the track will be counted as a new track.

³⁾ If you open the lid while "R-Posi" is set to "FrHere", recording will begin from the top of the disc the next time you record. Check the point to start recording on the display.

If the recording does not start

- Make sure the recorder is not locked (page 12, 44).
- Make sure the MD is not record-protected (page 61).
- Premastered MDs cannot be recorded over.

About the DSP TYPE-R for ATRAC

"TYPE-R" is a high-level Sony specification used in the Digital Signal Processor (DSP), which is the heart of the MiniDisc sound. This technology gives the MiniDisc recorder twice the signal processing capability as previous MiniDisc Walkman models, producing a sound quality close to that of MiniDisc decks. This unit supports the "TYPE-R" function only during recording or playback in normal stereo (or monaural) mode. It does not support this function in MDLP mode.

Notes

- The pause function cannot be turned on or off manually during synchro-recording. Press ■ to stop recording.
- Do not change “SYNC-R” setting while recording. Recording may not be done properly.
- Even when there is no recorded sound on the sound source, there may be cases when recording does not pause automatically during synchro-recording due to the noise level emitted from the sound source.
- If a silent portion is encountered for approximately 2 seconds during synchro-recording from a sound source other than a CD or an MD, a new track mark is automatically added at the point where the silent portion ends.
- Synchro-recording cannot be done if the connecting cord is not an optical cable.
- You cannot change the recording mode during recording.
- “Saving” or “Edit” flashes while data of the recording (the track’s start and end points, etc.) is being recorded. Do not move the recorder or disconnect the power source while the indication is flashing in the display.
- The lid does not open until “Edit” disappears in the display.
- If the power supply is disrupted (i.e. the battery is removed or becomes exhausted or the AC power adaptor is disconnected) during a recording or editing operation, or while “Edit” appears in the display, then it will not be possible to open the lid until power is restored.
- You can make a digital recording only from an optical type output.
- When recording from a portable CD player, set the CD player to pause, and then do the recording procedure on the recorder.
- Note the following when recording from a portable CD player:
 - Some portable CD players may not be capable of digital out when the AC power adaptor is disconnected. If this is the case, connect the AC power adaptor to the portable CD player and use it on AC power as the power source.
 - On some portable CD players, optical output may not be possible when using an anti-skip function (e.g., ESP* or G-PROTECTION). If this is the case, turn off the anti-skip function.

* Electronic Shock Protection



- When there is no sound (page 60) from the player for more than 3 seconds during synchro-recording, the recorder goes into the standby mode automatically. When the sound comes from the player again, the recorder resumes synchro-recording. If the recorder is kept in the standby mode for 5 minutes or longer, the recorder stops automatically.
- For MDLP recording, follow steps 1 to 3 of “Long-time recording (MDLP)” (page 21) to select the recording mode, and then start the procedure of synchro-recording.
- LINE IN (OPTICAL) jack is for both digital and analog input. The recorder automatically recognizes the type of line cable and switches to digital or analog input.
- The recording level is adjusted automatically. To adjust the level manually, see “Adjusting the recording level manually (Manual Recording)” (page 26).
- You can monitor the sound during recording. Connect the headphones/earphones to  and adjust the volume by pressing VOL +, -. This does not affect the recording level.

Playing an MD right away!

1 Insert an MD.

① Press OPEN to open the lid.

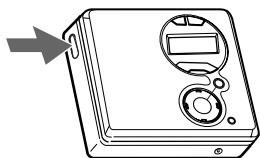

② Insert an MD with the label side facing front, and press the lid down to close.

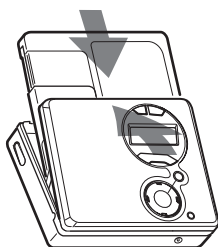

2 Play an MD.

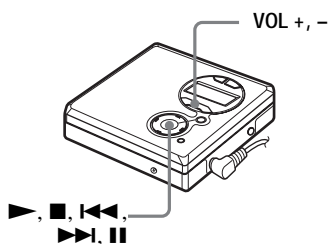

To stop play, press ■.

A long beep sounds in the headphones/earphones.

After you press ■, the recorder will automatically turn off in about 10 seconds (when using the dry battery) or about 3 minutes (when using the AC power adaptor). Playback starts from the point you last stopped playing. To start playback from the beginning of the first track, press and hold ► for 2 seconds or more.

① Press ►.

A short beep sounds in the headphones/earphones.

② Press VOL +, - to adjust the volume.

The volume will be shown in the display.

continued

To	Operation on the recorder
Find the beginning of the current track or a previous track ¹⁾	Press ⏮ . Press ⏮ repeatedly until the beginning of the desired track.
Find the beginning of the next track ²⁾	Press ⏭ once.
Go backwards while playing	Press and hold ⏮ .
Go forward while playing	Press and hold ⏭ .
Pause	Press ⏸ . Press ⏸ again to resume play.
Remove the MD	Press ⏻ , and open the lid. ³⁾

¹⁾ If you press **⏮** twice continuously while playing the first track of the disc, the recorder goes to the beginning of the last track on the disc.

²⁾ If you press **⏭** during the last track of the disc, the recorder goes to the beginning of the first track on the disc.

³⁾ Once you open the lid, the point to start play will change to the beginning of the first track.

If the play does not start

Make sure the recorder is not locked (page 12, 44).

Suppressing the skips of the sound (G-PROTECTION)

The G-PROTECTION function was developed to provide a higher level of shock resistance than that of existing players.

Note

The playback sound may skip if:

- the recorder receives stronger continuous shock.
- a dirty or scratched MiniDisc is played.



- The playback mode will switch automatically (stereo, LP2 stereo, LP4 stereo, or monaural).
- To play only the tracks in a certain group, see “Using the group function (Group Mode)” (page 29).

Note on digital and analog recording (Digital input and analog input)

The input jack of this recorder works as both digital and analog input jacks. Connect the recorder to a CD player or a cassette recorder using either digital (optical) input or analog (line) input. To record, see “Recording an MD right away! (Synchro-recording)” (page 13) to record using digital (optical) input, and “Recording in analog (Analog Recording)” (page 20) to record using analog (line) input.

Difference between digital (optical) and analog (line) inputs

Difference	Digital (optical) input	Analog (line) input
Connectable source	Equipment with a digital (optical) output jack (CD player, DVD player, etc.)	Equipment with an analog (line) output jack (Cassette deck, radio, record player, etc.)
Usable cord	Optical cable (with an optical or an optical-mini plug) (page 14)	Line cable (with 2 phono plugs or a stereo-mini plug) (page 20)
Signal from the source	Digital	Analog Even when a digital source (such as a CD) is connected, the signal sent to the recorder is analog.
Track marks ¹⁾	Marked (copied) automatically <ul style="list-style-type: none">• at the same positions as the source (when the sound source is a CD or an MD).• after more than 2 seconds of blank (page 60) or low-level segment (with a sound source other than a CD or an MD).• when the recorder is paused (3 seconds of no sound is encountered while synchro-recording).	Marked automatically <ul style="list-style-type: none">• after more than 2 seconds of blank (page 60) or low-level segment.• when the recorder is paused while recording.
Recorded sound level	Same as the source. Can also be adjusted manually (Digital REC level control) (“Adjusting the recording level manually (Manual Recording)”, page 26).	Adjusted automatically. Can also be adjusted manually (“Adjusting the recording level manually (Manual Recording)”, page 26).

¹⁾ You can erase unnecessary marks after recording. (“Erasing a track mark”, page 40).

Note

Track marks may be copied incorrectly:

- when you record from some CD players or multi disc players using digital (optical) input.
- when the source is in shuffle or program play mode while recording using digital (optical) input. In this case, play the source in normal play mode.
- when programs with audio that is digitally broadcast (e.g., digital TV) are recorded through the digital (optical) input.

Recording in analog (Analog Recording)

The sound will be input from the connected equipment as an analog signal, but recorded digitally to the disc. To connect to a sound source, an optional line cable is required. When connecting the cable, make sure to insert the connectors firmly.

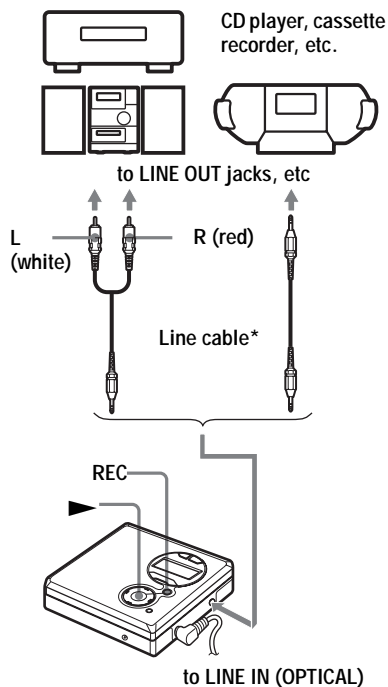

* Use the connecting cords without an attenuator. To connect to a portable CD player having a stereo mini-jack, use a connecting cord with a stereo-mini plug on both ends (not supplied).

- 1 Press while pressing REC. REC indication lights up in the display and recording starts.
- 2 Play the source you want to record. For other recording operations, see “Recording an MD right away! (Synchro-recording)” (page 13).



- LINE IN (OPTICAL) jack is for both digital and analog input. The recorder automatically recognizes the type of the cable and switches to digital or analog input.
- If you press while pressing REC in step 1 above, the recorder will enter recording standby mode. To start recording, press again.

Note

If you temporarily stop a recording operation by pressing , a track mark will be added at that point when you press again to resume recording. The recording continues from a new track.

Long-time recording (MDLP)

Select each recording mode according to the recording time that you want.

Stereo recording is possible at 2 times (LP2) or 4 times (LP4) the normal (stereo) recording time. Monaural recording at 2 times normal recording time is also possible.

MDs recorded in monaural, LP2, or LP4 mode can be played back only on MD players or recorders with monaural, LP2, or LP4 playback mode.

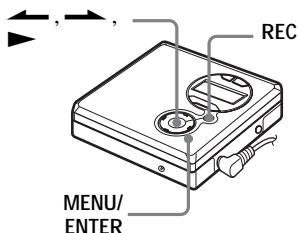

1 While the recorder is stopped, press MENU.

2 Press ◀ or ▶ repeatedly until "R-MODE" flashes in the display, and then press ENTER.

3 Press ◀ or ▶ repeatedly to select the desired recording mode, and then press ENTER.

Each time you press ▶, **A** changes. When you press ENTER, **B** appears.

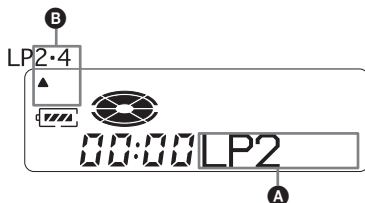

Recording mode ¹⁾	Display A/B	Recording time ³⁾
SP Stereo	SP/— (none)	Approx. 80 min.
LP2 stereo	LP2/▲	Approx. 160 min.
LP4 stereo	LP4/▲	Approx. 320 min.
Monaural ²⁾	MONO/ MONO	Approx. 160 min.

¹⁾ For better sound quality, record in normal stereo (SP) or LP2 stereo mode.

²⁾ If you record a stereo source in monaural, the sound from left and right will be mixed.

³⁾ When using an 80-minute recordable MD

4 Press ▶ while pressing REC.

5 Play the sound source.

To stop recording

Press ■.

The recorder remains at the previous setting of the recording mode when you record the next time.

When you do not want “LP:” added automatically at the beginning of a track

When recording in MDLP mode, this recorder adds “LP:” at the front of every track name automatically. “LP:” appears when you try to play or edit these tracks on a recorder or player that does not support MDLP mode (but not on a recorder or player that supports MDLP mode).

If you change the recorder setting so that “LP:” is not added, you’ll be able to enter longer track names by using the entire text string.

- 1 While the recorder is stopped, press MENU.
- 2 Press **←** or **→** repeatedly until “OPTION” flashes in the display, and then press ENTER.
- 3 Press **←** or **→** repeatedly until “LPStmp” flashes in the display, and then press ENTER.
- 4 Press **←** or **→** repeatedly until “OFF” flashes in the display, and then press ENTER.

If you want “LP:” added, select “ON” in this step, and then press ENTER.



- Audio components that support the LP2 stereo or LP4 stereo modes are indicated by the **MDLP** or **MDLP** logo marks.
- You can achieve high sound quality and rich tones when recording in SP stereo (or monaural) thanks to the newly developed DSP TYPE-R for ATRAC (Adaptive Transform Acoustic Coding) (page 15).

Notes

- It is recommended that you use the AC power adaptor for long recordings.
- During monaural recording of a stereo sound source connected through the digital (optical) input jack, you can still monitor the recorded sound in stereo by using headphones or earphones connected to the  jack.
- When you record in LP4 mode, momentary noise may be produced on very rare occasions with certain sound sources. This is because of the special digital audio compression technology that enables a recording time of 4 times longer than normal. If noise is produced, it is recommended that you record in normal stereo or LP2 mode to obtain better sound quality.

Recording tracks using the group function (Group Mode Recording)

What is the group function (Group Mode)?

It is a function that allows you to separate tracks on a disc into different groups for playback, recording and editing.

When group mode is OFF.

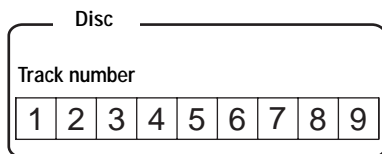

When group mode is ON.

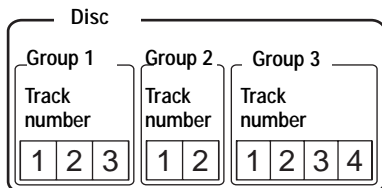

It is convenient for managing multiple CD albums recorded in MDLP (LP2 stereo/ LP4 stereo) mode onto a single MD. You can create a maximum of 99 groups on a disc.

How is group information recorded?

When recording in group mode, the group information is written to the disc name recording area.

This information consists of text strings that are written as shown in the following example.

Disc name recording area

Example

0;Favorites//1-5;Rock//6-9;Pops//
① ② ③

- ① Disc name: "Favorites"
- ② Group name for tracks 1 to 5: "Rock"
- ③ Group name for tracks 6 to 9: "Pops"

Therefore, the above character string is displayed in its entirety as the disc name if you load an MD recorded in group mode into a system that does not support group mode, or if you try to edit the contents of a disc on this recorder with group mode turned off.

It is possible to change the character string by doing "Relabeling recordings" (page 36) procedure in the "Labeling/ relabeling recordings". Note that if you rewrite this character string by mistake, you may be unable to use the group function of that MD.

Notes

- The group function setting is stored even if you eject the MD or turn off the recorder.
- In group mode, the recorder treats all tracks without group settings as belonging to the last group on the disc. The last group is indicated in the display window on the recorder as "GP --". Within a group, the tracks appear in their order on the disc, not their order within the group.

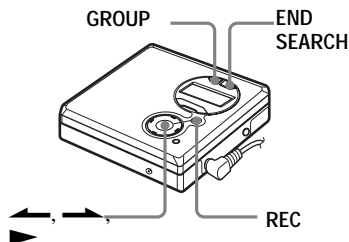

To activate group mode (Group Mode Recording)

To record tracks in group mode, you must first turn group mode on before the start of recording.

- 1 Press GROUP for 2 seconds or more. " " and "GP ON" light up and group mode turns on.

To cancel group mode

Press GROUP for 2 seconds or more again.

Recording a track into a new group

- Turn group mode on.

- 1 Press END SEARCH while the recorder is stopped.

continued

- 2 Press ► while pressing REC.
- 3 Play the source sound.

To stop recording

Press ■.

The material that was recorded up until ■ was pressed is entered as a new group.

Recording a track into an existing group

- Turn group mode on.
- Insert a disc with group settings.

- 1 Press GROUP.
“” flashes in the display and you can select a group directly (Group Skip Mode) (page 29).
- 2 Within 5 seconds, press ◀ or ▶ repeatedly until the group you want the track to belong to appears.
- 3 Press ► while pressing REC.
- 4 Play the source sound.
Newly recorded track is added after the current contents.

Notes

- Even if “R-Posi” is set to “FrHere”, newly recorded tracks are inserted after the existing tracks in the specified group without recording over the current contents (page 24).
- Group skip mode turns off automatically in step 2 if nothing is done within 5 seconds. To continue the procedure, do step 1 again.



To add a track that is playing to a group, stop playing the track first, and then do the procedure from step 3.

Recording without overwriting existing material

If you wish to avoid overwriting the current contents of an MD, do the following procedure. All new material will then be recorded from the end of the current contents. The recorder is factory set to record over existing material.

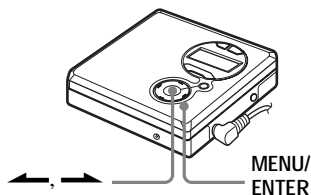

- 1 While the recorder is stopped, press MENU.
- 2 Press ◀ or ▶ until “OPTION” flashes in the display, and then press ENTER.
- 3 Press ◀ or ▶ repeatedly until “R-Posi” flashes in the display, and then press ENTER.
- 4 Press ◀ or ▶ repeatedly until “Fr End” flashes in the display, and then press ENTER.

To start recording from the current point

Select “FrHere” in step 4.



- To temporarily record without recording over the current contents, press END SEARCH before the start of recording. The recording will begin after the last track, even if “R-Posi” is set to “FrHere” (factory setting). The remaining recordable time on the disc will appear in the display when you press END SEARCH.
- The recorder will not overwrite existing material when group mode is on. In group mode, you can only record tracks to create a new group (page 23) or record tracks within an existing group (page 24).

Notes

- The setting will remain even after the power is turned off.
- If you start recording while the recorder is in play-pause mode, the recording will begin from the point at which it is paused even when the “R-Posi” is set to “Fr End”.

Adding track marks automatically (Auto Time Stamp)

Use this feature to add track marks automatically at specified intervals when recording through the analog input connector.

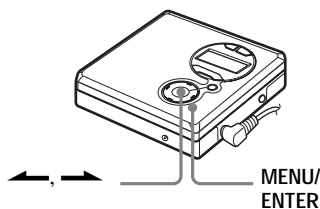

- 1 While the recorder is recording or in recording pause, press MENU.
- 2 Press ◀ or ▶ repeatedly until “TimeMk” flashes in the display, and then press ENTER.
- 3 Press ◀ or ▶ repeatedly until the desired time interval flashes in the display, and then press ENTER.

Select one of the following intervals:

Display	Time
OFF	—
5 min	Approx. 5 min.
10 min	Approx. 10 min.
15 min	Approx. 15 min.

To cancel Auto Time Stamp Select “OFF”, and then press ENTER in step 3, or stop recording.

Using Auto Time Stamp to add track marks while recording

When the elapsed recording time exceeds the time interval for Auto Time Stamp:

The recorder adds track marks at the point you set the time interval and from that point the recorder adds a track mark whenever the time interval has elapsed.

Example: Eight minutes of recording has been completed when the Auto Time Stamp time interval is set to 5 minutes. A track mark will be added at the 8-minute point (after the start of recording) and after each 5-minute interval thereafter.

When the time interval set for Auto Time Stamp exceeds the elapsed recording time:

The recorder adds a track mark when the set Auto Time Stamp time interval has elapsed.

Example: Three minutes of recording has been completed when the Auto Time Stamp time interval is set to 5 minutes. A track mark will be added at the 5-minute point (after the start of recording) and after each 5-minute interval thereafter.



“T” appears before the track display on the recorder for track marks added by Auto Time Stamp.

Notes

- Automatic track marking by Auto Time Stamp starts when you add a normal track mark to the disc (i.e., by pressing T MARK or **II**, etc.).
- The setting will be lost when the recording stopped.

Adjusting the recording level manually (Manual Recording)

When you record, the sound level is adjusted automatically. If necessary, you can set the recording level manually during both analog and digital recording.

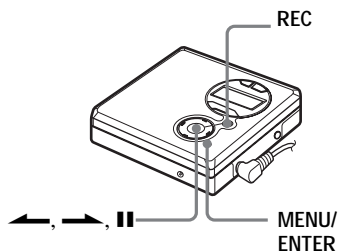

- 1 Press **II** while pressing REC. The recorder stands by for recording.
- 2 Press MENU.
- 3 Press **←** or **→** repeatedly until “RecVol” flashes in the display, and then press ENTER.
- 4 Press **←** or **→** repeatedly until “Manual” flashes in the display, and then press ENTER.



- 5 Play the source.

- 6 While observing the level meter in the display, adjust the recording level by pressing ◀ or ▶.

Set the level so that the maximum input lights up the fifth segment on the level meter. If the sixth segment lights up, lower the level by pressing ◀.

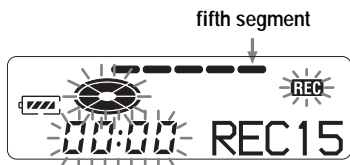

Recording does not start in this step. If your source is an externally connected component, be sure to cue the source to the beginning of the material to be recorded before you start playback.

- 7 Press **II** again to start recording.

To stop recording

Press **■**.

The recorder will revert to automatic recording level adjustment mode the next time you start a recording operation.

To switch back to automatic level control

Select "Auto" in step 4.

Notes

- To set the recording level manually during synchro-recording, do the procedure below.
 - Select "OFF" in step 3 of "Record an MD." (page 14).
 - Do steps 1 to 6 of manual recording procedure (page 26). Then do the procedure of "Record an MD." (step 3 of "Recording an MD right away! (Synchro-recording)" (page 13) again.
Recording starts automatically whenever the source sound is played.
- You cannot switch from "Auto" to "Manual" (or vice-versa) during recording.

Checking the remaining recordable time

You can check the remaining time, track number, etc. when recording or during stop. Group-related items appear only when a track with group settings is played and then stopped.

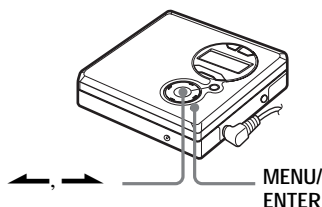

- While the recorder is recording or stopped, press MENU.
- Press ◀ or ▶ repeatedly until "DISP" flashes in the display, and then press ENTER.
- Press ◀ or ▶ repeatedly until the information you want flashes in the display.
Each time you press ▶, the display changes as follows:

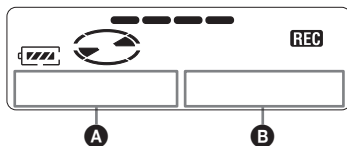

continued

On **B**

LapTim

The elapsed time of the current track.

RecRem

The remaining recordable time.

GP Rem

The remaining time after the current track in a group.

AllRem

The remaining time after the current location.

4 Press ENTER.

The information selected in step 3 appears in **A** and **B**.

A — the information selected in step 3.

B — track number, track name, group name, or disc name.

Note

Items may appear differently or may not be selectable depending on group mode's on/off status, the recorder's operating status, or the recorder settings.



If you want to check the playing position or track name while playing, see page 33.

Using the group function (Group Mode)

The recorder can operate various playback with a disc which has group setting. For more information on group mode, see “Recording tracks using the group function (Group Mode Recording)” (page 22).

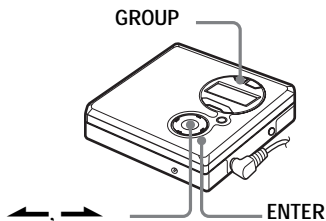

Listening to tracks in a specific group (Group Mode Playback)

- Insert a disc with group settings.

- 1 Start playback.
- 2 Press GROUP for 2 seconds or more. “☐” and “GP ON” light up in the display and the group mode turns on. Playback stops at the end of the last track in the selected group. For details on selecting another group, see “Selecting and playing groups (Group Skip Mode)” (page 29).



- You can also change play mode (repeat play, or shuffle play) in the selected group. After the procedures here, follow the steps of “Changing play modes” (page 30).
- In group mode, pressing ► during the last track of the group moves playback to the first track of the group, and pressing ◀ twice continuously during the first track of the group moves playback to the last track of the group.

To turn off the group function
Press GROUP for 2 seconds or more again.

Note

In group mode, the recorder treats all tracks without group settings as belonging to the last group on the disc. The last group is indicated in the display window on the recorder as “GP --”. Within a group, the tracks appear in their order on the disc, not their order within the group.

Selecting and playing groups (Group Skip Mode)

Operations are possible regardless of whether group mode is on or off. However, playback on the recorder will differ, depending on whether group mode is on or off.

- **When group mode is on:**
Playback starts from the first track of the selected group and ends with the last track in the group.
- **When group mode is off:**
Playback starts from the first track of the selected group and ends with the last track in the disc.

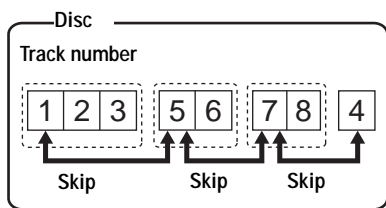

When group mode is off:

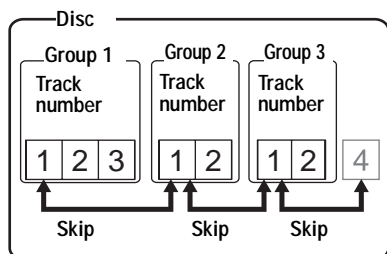

When group mode is on:



• Insert a disc with group settings.

- 1 Press GROUP.
“” flashes in the display and groups become selectable.
- 2 Within 5 seconds, press  or  repeatedly to select your desired group, and then press ENTER.
The recorder starts playing from the first track in the group.





Note

If no operation is performed within 5 seconds after step 1, group skip mode will be canceled and you will not be able to perform step 2 thereafter. To continue with step 1 at this point, repeat from the beginning of the procedure.

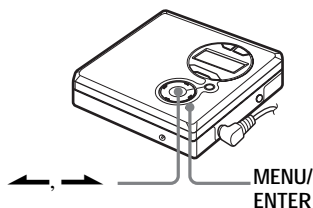
Changing play modes

You can select from various play modes such as single play (1Track), shuffle play (Shuff), and program play (PGM). You can also select repeat play in any of play mode.



- 1 While the recorder is playing, press MENU.
- 2 Press  or  repeatedly until “P-MODE” flashes in the display, and then press ENTER.
- 3 Press  or  repeatedly to select play mode, and then press ENTER.

Each time you press , **B** changes.
When you press ENTER, **A** appears.



On **B/A**

Normal/(none)

All the tracks are played once.

AllRep/☐

All the tracks are played repeatedly.

1Track/1

A track is played once.

1 Rep./☐ 1

A single track is played repeatedly.

Shuff/SHUF

After the currently selected track finishes playing, the remaining tracks are played in random order.

Shuf.R/SHUF ☐

After the currently selected track finishes playing, the remaining tracks are played repeatedly in random order.

PGM/PGM

Tracks are played in the order that you specified.

PGMRep/☐ PGM

Tracks are played repeatedly in the order that you specified.

Creating a program (Program Play)

You can set the program play up to 20 tracks.

- 1 Press MENU while “PGM” flashes in the display in step 3 of “Changing display modes” (page 30).
- 2 Press ← or → repeatedly to select a track and then press ENTER. The selected track enters.

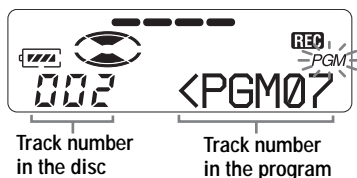

- 3 Repeat step 2 to program more tracks.
- 4 Press ENTER for 2 seconds or more. The program is set and the playback starts from the first track.



- The program play setting will remain in memory even after playback finished or is stopped.
- You can specify play mode for a selected group when group mode is on. To activate group mode, see “To activate group mode (Group Mode Recording)” (page 23).
- Play mode can also be selected when the recorder is stopped.

Notes

- All program settings are lost when the lid of the recorder is opened.
- If the recorder is stopped and left inactive for 5 minutes in the middle of a programming operation, the tracks selected up to that point are entered as the program.
- If you turn group mode on or off while setting a program, the program setting mode will be canceled but the program you set up to that point will remain.
- If you turn group mode on during program play, the program setting is canceled.

Adjusting treble or bass (Digital Sound Preset)

You can adjust the treble and bass to suit your taste. The player can store two sets of treble-bass adjustments, which can then be selected later during playback.

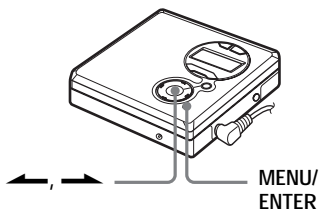

Selecting the sound quality

Factory settings

Factory settings of the Digital Sound Preset are as follows:

- “SOUND1”: bass +1, treble ± 0
- “SOUND2”: bass +3, treble ± 0

- 1 Press MENU.
- 2 Press \leftarrow or \rightarrow repeatedly until “S-SEL” flashes in the display, and then press ENTER.
- 3 Press \leftarrow or \rightarrow repeatedly until “SOUND1” or “SOUND2” flashes in the display, and then press ENTER.

To cancel Digital Sound Preset
Select “OFF” in step 3.

Adjusting the sound quality

You can change the preset sound quality. To change the preset sound quality, select “SOUND1” or “SOUND2”, the one you want to change, in advance.

- 1 While playing and “SOUND1” or “SOUND2” has been selected, press MENU.
- 2 Press \leftarrow or \rightarrow repeatedly until “S-SET” flashes in the display, and then press ENTER.
The display shows the currently selected “BASS” sound setting.
- 3 Press \leftarrow or \rightarrow repeatedly to adjust the sound level.

Shows “SOUND1” or “SOUND2” is selected



The sound can be adjusted in 8 steps
(-4, -3, ... ± 0 , ...+2, +3).

- 4 Press ENTER.
“BASS” is set and the display changes to “TRE” (treble) setting mode.
- 5 Press \leftarrow or \rightarrow repeatedly to adjust the sound level, and then press ENTER.
“TRE” (treble) is set.
The sound settings are saved and the playback display appears again.

To cancel selecting
Press CANCEL.



- Settings can also be changed while playback is momentarily paused (II).
- If the recorder is not operated approximately for 5 minutes, the current setting is stored and the display automatically switches to normal playback.

Notes

- When you use the Digital Sound Preset, the sound may break or become distorted depending on the settings or the track. In this case, change the settings of the sound quality.
- Changing to another Digital Sound Preset during a recording operation will not affect the quality of recorded sound.

Checking the remaining time or the playing position

You can check the track name, disc name, etc. during playback. Group-related items appear only when a track with group settings is played.

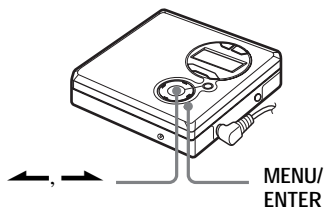

- 1 While the recorder is playing, press MENU.
- 2 Press ◀ or ▶ repeatedly until “DISP” flashes in the display, and then press ENTER.
- 3 Press ◀ or ▶ repeatedly until the information you want flashes in the display.
Each time you press ▶, the display changes as follows:

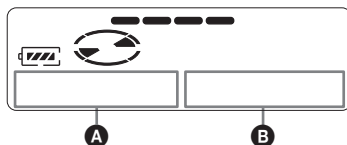

On **B**

LapTim

The elapsed time of the current track.

1 Rem

The remaining time of the current track.

GP Rem

The remaining time after the current location in the group.

AllRem

The remaining time after the current location.

- 4 Press ENTER.

The display changes as follows:

The information selected in step 3 appears in **A** and **B**.

A — the information selected in step 3.

B — track number, track name, group name, or disc name.

Note

Items may appear differently or may not be selectable, depending on group mode's on/off status, the recorder's operating status, or the recorder settings.



If you want to check the remaining time or the recording position while recording or in stop mode, see page 27.

You can edit your recordings by adding/erasing track marks or labeling tracks and MDs. Premastered MDs cannot be edited.

Notes on editing

- You cannot edit tracks on an MD that is record-protected. Before editing tracks, close the tab on the side of the MD (page 61).
- If you perform an editing operation while playing, be sure not to turn the power off until "Edit" disappears in the display.
- Do not move the recorder while "Edit" is flashing in the display.
- The lid will not open until "Edit" disappears in the display after editing.
- When group mode is on, editing can be performed only for the tracks registered into the selected group.

Labeling/relabeling recordings

You can name tracks, groups and discs using the recorder's character palette.

Available characters

- Capital and small letters of the English alphabet
- Numbers 0 to 9
- ! " # \$ % & () * . : ; < = > ?
@ _ ` + - ' , / : _ (space)

Numbers of characters you can input

Track, group, or disc name: Approx. 200 each

Numbers of characters you can input in a disc

Numbers/marks: Approx. 1,700

Notes

- "FULL" appears when you try to enter more than 1,700 characters on a disc. Enter a shorter name for the track, group, or disc, or set the "LPStmp" setting to "OFF" when recording in MDLP mode so that "LP:" is not be added at the beginning of the track name (page 22).
- When labeling a disc which has been recorded using the group function, make sure group mode is on in order to prevent the group management information from being overwritten by mistake.
- If you enter the symbol "/" between the characters in disc names such as "abc//def", you may be unable to use the group function.

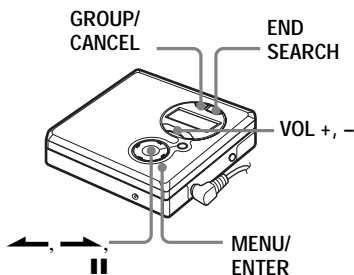

Labeling recordings

- 1 Insert a disc and do the following operations:

To label a track

Start playing or recording a track you want to label, and label the track while playing or recording operations.





To label a group

Turn group mode on (page 23) and start playing or recording a track within the group you want to label, and label the group while playing or recording operations.

To label a disc

If a disc is already recorded, follow the procedures from step 2 while the recorder is stopped. If a disc is new, start recording and label a disc while recording.

If you label a disc with group settings, turn group mode on (page 23).

- 2 Press MENU.
- 3 Press  or  repeatedly until "EDIT" flashes in the display, and then press ENTER.
- 4 Press  or  repeatedly until the following item appears in the display, and then press ENTER.

When labeling a track

"T: Name"



When labeling a group



"G: Name"

When labeling a disc

"D: Name"

The cursor flashes and the track, group, or disc is ready to be labeled.

- 5 Press  or  repeatedly to select a letter and press ENTER.
- The selected letter stops flashing and the cursor moves to the next input position.
- The buttons used for character input and their functions are listed below:

Functions	Operations
To move the cursor	Press VOL +, -.
To switch between capital letters, small letters and numbers/marks	Press II .
To select a character	Press  or  .
To enter a letter	Press ENTER.
To enter a name	Press ENTER for 2 second or more.
To insert a blank space to type in a new letter	Press VOL + and END SEARCH at the same time.
To delete a letter and move back all following letters to the left	Press VOL - and END SEARCH at the same time.
To cancel labeling	Press CANCEL.

- 6 Repeat step 5 and enter all characters of the label name.
- 7 Press ENTER for 2 seconds or more. The track or disc is labeled.

To cancel labeling,
Press CANCEL.

Notes

- When the recording is stopped while labeling a track, a group, or a disc during recording, or when the recording moves on to the next track while labeling a track, the input at that point is entered automatically.
- "LP:" is automatically added at the beginning of the track name for tracks recorded in MDLP mode (page 21).

Relabeling recordings

- 1 Insert a disc and do the following operations:

To relabel a track

Start playing a track you want to relabel, and change a track name during playback operation.

To relabel a group

Turn group mode on (page 23) and start playing or recording a track within the group you want to relabel, and change the group name while playing or recording operations.

To relabel a disc

If the disc is already recorded, follow the procedures from step 2 while the recorder is stopped.

If you relabel a disc with group settings, turn group mode on (page 23).

- 2 Follow steps 3 to 4 of “Labeling recordings” (page 35) to display a track, group, or disc name.
- 3 Follow steps 5 to 7 of “Labeling recordings” (page 35), and then keep pressing ENTER for 2 seconds or more.

Notes

- You cannot label or relabel the premastered disc or blank disc.
- The recorder is able to display, but cannot label using Japanese “Katakana” characters.
- The recorder cannot rewrite a disc or track name of more than 200 letters that was created by another device.

To cancel labeling

Press CANCEL.

Registering tracks or groups as a new group (Group Setting)

Do the following procedure to register tracks or groups as a new group. The tracks or groups must, however, be sequential. If the desired tracks or groups are not consecutive, you must move them to make them consecutive before you can register them (“Moving recorded tracks”, page 38). The operation of this function depends on whether group mode is on or off.

- When group mode is ON:
Several groups are registered as one group.
- When group mode is OFF:
Several groups are registered as one group.

The following section explains the operation when group mode is on.

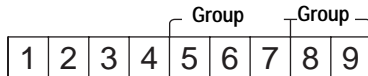

Making a new group with tracks 1 to 3.



Making a new group with 2 groups.



- Registration of non-consecutive tracks is not possible (for example, track 3 cannot be registered into a group with track 5 to 7).
- Tracks always appear according to their order on the disc, not their order within the group (even when group mode is on).

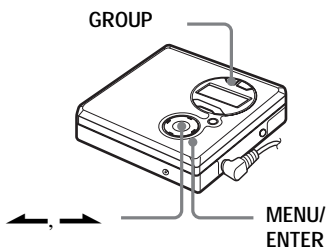

- 1 While the recorder is stopped, press MENU.
- 2 Press ◀ or ▶ repeatedly until "EDIT" flashes in the display, and then press ENTER.
- 3 Press ◀ or ▶ repeatedly until "G:Set" flashes in the display, and then press ENTER.
The track number of the first track ("STR") appears in the display.



- 4 Press ◀ or ▶ repeatedly until the number or name of the desired first track flashes in the display, and then press ENTER.
This selects the first track of the new group.
Even when group mode is on, track numbers appear according to their order on the disc, not their order within the group.

- 5 Press ◀ or ▶ repeatedly until the number or name of the desired last track flashes in the display, and then press ENTER.
The track number of the last track in the group ("END") appears in the display.
This selects the last track of the new group.

- 6 Follow steps 3 to 7 of "Labeling recordings" (page 35) to label a group.

Notes

- In step 4, the first track must either be the first track of an existing group or a track that does not belong to a group.
- When selecting the last track in step 5, make sure the track comes after the one selected in step 4. The last track must either be the last track of an existing group or a track that does not belong to a group.

To release a group setting

- Insert a disc with group settings.

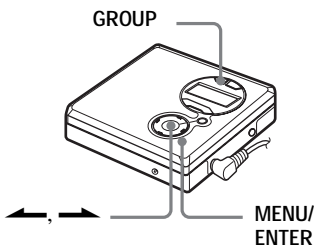

- 1 Press GROUP for 2 seconds or more to turn on group mode.
- 2 Select a group that you want to release and check the contents (see "Selecting and playing groups (Group Skip Mode)" (page 29)).

continued

- 3 Press MENU.
- 4 Press ◀ or ▶ repeatedly until “EDIT” flashes in the display, and then press ENTER.
- 5 Press ◀ or ▶ repeatedly until “G:Rls” flashes in the display, and press ENTER.
“G:Rls?” and “ENTER” appear in the display.
- 6 Press ENTER.
The group setting of the selected group is released.

To cancel releasing
Press CANCEL.

Moving recorded tracks

You can change the order of the recorded tracks.

Example

Move track C from the third to the second track.

Before moving

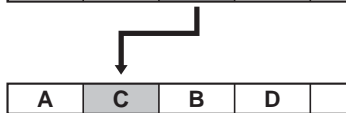

After moving

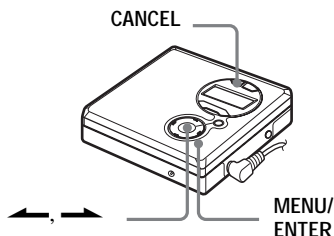

- 1 While playing the track you want to move, press MENU.
- 2 Press ◀ or ▶ repeatedly until “EDIT” flashes in the display, and then press ENTER.
“♪” and “T:Name” flashes in the display and the recorder plays the selected track repeatedly.
- 3 Press ◀ or ▶ repeatedly until “♪” and “T:Move” flashes in the display, and then press ENTER.
For the example above, “003 →” and “→ 003” appear alternately in the display.
- 4 Press ◀ or ▶ to select the destination track number.
For the example above, “003 →” and “→ 002” appear alternately in the display.
- 5 Press ENTER.
The track moves to the selected destination track.

To cancel moving
Press CANCEL.

Moving a track to a different group

- Insert a disc with group settings.

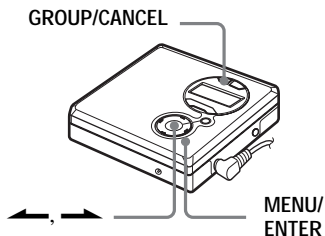

- 1 Press GROUP for 2 seconds or more. "☐" lights up in the display group mode turns on.
- 2 While playing the track you want to move, press MENU.
- 3 Press ◀ or ▶ repeatedly until "EDIT" flashes in the display, and then press ENTER. The recorder plays the selected track repeatedly.
- 4 Press ◀ or ▶ repeatedly until "T:Move" flashes in the display, and then press ENTER.
- 5 Press ◀ or ▶ repeatedly until the destination group flashes in the display, and then press ENTER.
- 6 Press ◀ or ▶ repeatedly until the number of the destination track within the group flashes in the display, and then press ENTER.

To cancel moving
Press CANCEL.

Changing the order of a group on a disc (Group Move)

- Insert a disc with group settings.

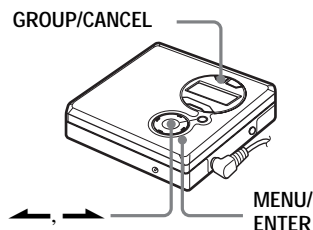

- 1 Press GROUP for 2 seconds or more. "☐" lights up in the display and group mode turns on.
- 2 While playing a track within a group whose order you want to change, press MENU.
- 3 Press ◀ or ▶ repeatedly until "EDIT" flashes in the display, and then press ENTER.
- 4 Press ◀ or ▶ repeatedly until "G:Move" flashes in the display, and then press ENTER. You can now move the selected group.
- 5 Press ◀ or ▶ repeatedly to select the destination point on the disc, and then press ENTER.

To cancel moving
Press CANCEL.

Adding a track mark

You can add track marks so that the part after the new track mark is counted as a new track. The track numbers will increase as follows:

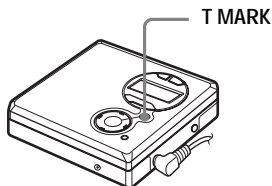
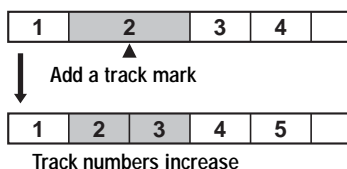

- 1 While playing or pausing an MD, press T MARK at the point you want to mark.

"MK ON" appears in the display, and a track mark is added. The track number will increase by one.

To add track marks while recording (except while synchro-recording)

Press T MARK at the point you want to add a track mark.

You can use Auto Time Stamp to add track marks automatically at specified intervals (except while digital recording) (page 25).

Erasing a track mark

When you record with analog (line) input, unnecessary track marks may be recorded where recording level is low. You can erase a track mark to combine the tracks before and after the track mark. The track numbers will change as follows:

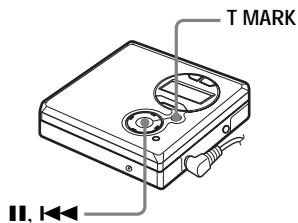
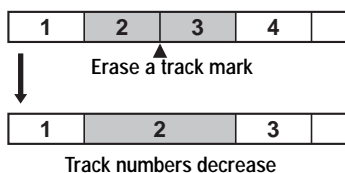

- 1 While playing the track with the track mark you want to erase, press || to pause.
- 2 Find the track mark by pressing <<< slightly.
For example, to erase the third track mark, find the beginning of the third track. "00:00" appears in the display. "MK 003" appears in the display for 2 seconds.
- 3 Press T MARK to erase the mark. "MK OFF" appears in the display. The track mark is erased and the two tracks are combined.



When you erase a track mark, name assigned to the mark is also erased.

Notes

- When you erase a track mark between the two consecutive tracks that are registered into different groups while group mode is off, the second track is re-registered into the group containing the first track. In addition, if you combine a track that is registered to a group with a track that is not registered to a group (two consecutive tracks), the second track takes the same registration setting as the first track. However, when group mode is on, you can only combine tracks within the selected group.
- You cannot erase track marks according to the system limitations. For details, see “System limitations” (page 48).

Erasing tracks

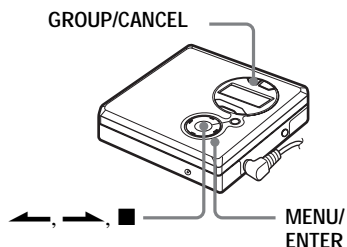

To erase a track

Note that once a recording has been erased, you cannot retrieve it. Make sure of the track you are erasing.

- 1 While playing the track you want to erase, press MENU.
- 2 Press \leftarrow or \rightarrow repeatedly until “EDIT” flashes in the display, and then press ENTER.
“ ♪ ” and “T:Name” flash in the display, and the recorder plays the selected track repeatedly.

- 3 Press \leftarrow or \rightarrow repeatedly until “ ♪ ” and “T:Ers” flash in the display, and then press ENTER. “Erase?” and “ENTER” appear alternately in the display.

- 4 Press ENTER again.
The track is erased and the next track starts to play. All the tracks after the one erased are automatically renumbered.



To erase a part of a track
Add track marks at the beginning and the end of the part you want to erase (page 40), then erase the part.

To cancel erasing
Press CANCEL.

To erase the whole disc

You can quickly erase all the tracks and data of the MD at the same time.

Note that once a recording has been erased, you cannot retrieve it. Be sure to check the contents of the disc before you erase it.

- 1 Play the disc you want to erase to check the contents.
- 2 Press **■** to stop.
- 3 While the recorder is stopped, press MENU.
- 4 Press **←** or **→** repeatedly until “EDIT” flashes in the display, and then press ENTER.
“” and “D:Name” flash in the display.
- 5 Press **←** or **→** repeatedly until “” and “D:Ers” flash in the display, and then press ENTER.
“Erase?” and “ENTER” appear alternately in the display.
- 6 Press ENTER again.
“Edit” flashes in the display, and all the tracks will be erased.
When erasing is complete, “BLANK” appears in the display.

To cancel erasing

Press CANCEL.

To erase a group

You can erase tracks in a selected group.

Note that once a recording has been erased, you cannot retrieve it. Be sure to check the contents of the group before you erase it.

- Insert a disc with group settings.

- 1 Press GROUP for 2 seconds or more.
“” lights up in the display and group mode turns on.
- 2 Select a group you want to erase (“Selecting and playing groups (Group Skip Mode)”, page 29) to check the contents.
- 3 Press **■** to stop.
- 4 While the recorder is stopped, press MENU.
- 5 Press **←** or **→** repeatedly until “EDIT” flashes in the display, and then press ENTER.
- 6 Press **←** or **→** repeatedly until “G:Ers” flash in the display, and then press ENTER.
“Erase?” and “ENTER” appear alternately in the display.
- 7 Press ENTER again.
The group is erased.

To cancel erasing

Press CANCEL.

Protecting your hearing (AVLS)

The AVLS (Automatic Volume Limiter System) function keeps down the maximum volume to protect your ears.

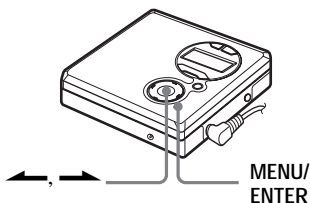

- 1 Press MENU.
- 2 Press or repeatedly until "OPTION" flashes in the display, and then press ENTER.
- 3 Press or repeatedly until "AVLS" flashes in the display, and then press ENTER.
- 4 Press or repeatedly until "ON" flashes in the display, and then press ENTER.

When you try to turn the volume too high, "AVLS" flashes in the display. The volume is kept to a moderate level.

To cancel AVLS

Select "OFF" in step 4.

Turning off the beep sound

Using the recorder, you can turn off the beep sound.

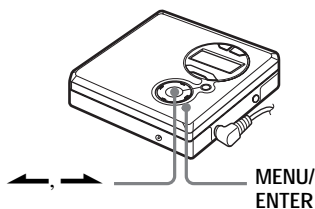

- 1 Press MENU.
- 2 Press or repeatedly until "OPTION" flashes in the display, and then press ENTER.
- 3 Press or repeatedly until "BEEP" flashes in the display and then press ENTER.
- 4 Press or repeatedly until "OFF" flashes in the display, and then press ENTER.

To turn on the beep sound

Select "ON" in step 4.

Locking the controls (HOLD)

To prevent the buttons from being accidentally operated when you carry the recorder, use this function.

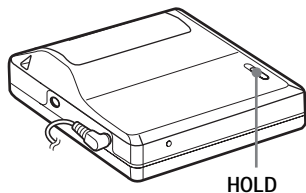

- 1 Move HOLD in the direction of the .

To unlock the controls
Move HOLD in the opposite direction of
the arrow to unlock the controls.

You can use the recorder on house current or an LR6 (size AA) alkaline dry battery.

It is preferable to use the recorder on house current when recording for a long time. When using a battery, make sure it is a new alkaline dry battery to prevent operations (e.g., recording and editing) from failing due to insufficient battery power.

When to replace the battery

When the dry battery is weak, flashing , "LoBATT", etc. appear in the display. Replace the dry battery. Note that the battery level indicated by the battery indication is only approximate and varies with the recorder condition.

Note

Stop the recorder before replacing battery.

Battery life

The battery life may be shorter due to operating conditions, the temperature of the location, and varieties of batteries.

(Unit: approx.hours)(JEITA¹⁾)

LR6 (SG) Sony alkaline dry battery²⁾	SP Stereo	LP2 Stereo	LP4 Stereo
When recording ³⁾	8	13	19
When playing	37	46	51

¹⁾ Measured in accordance with the JEITA (Japan Electronics and Information Technology Industries Association) standard.

²⁾ When using a Sony LR6 (SG) "STAMINA" alkaline dry battery (produced in Japan).

³⁾ To prevent interrupted recording due to drained battery, use a new battery for recording operations.

Precautions

On safety

- Do not put any foreign objects in the DC IN 3V jack.
- Keep the terminals on the recorder away from metallic objects or surfaces. Such contact may short-circuit the terminals and cause dangerous heat generation.

On power sources

- Use house current, LR6 (size AA) battery, or car battery.
- For use in your house: Use the AC power adaptor supplied with this recorder. Do not use any other AC power adaptor since it may cause the recorder to malfunction.

Polarity of the plug



- Connect the AC power adaptor to an easily accessible AC outlet. Should you notice an abnormality in the AC power adaptor, disconnect it from the AC outlet immediately.
- The recorder is not disconnected from the AC power source (mains) as long as it is connected to the wall outlet, even if the recorder itself has been turned off.
- If you are not going to use this recorder for a long time, be sure to disconnect the power supply (AC power adaptor, dry battery, or car battery cord). To remove the AC power adaptor from the wall outlet, grasp the adaptor plug itself; never pull the cord.

On heat build-up

Heat may build up in the recorder if it is used for an extended period of time. In this case, leave the recorder turned off until it cools down.

On installation

- Never use the recorder where it will be subjected to extremes of light, temperature, moisture or vibration.
- Never wrap the recorder in anything when it is being used with the AC power adaptor. Heat build-up in the recorder may cause malfunction or damage.

On the headphones/earphones

Road safety

Do not use headphones/earphones while driving, cycling, or operating any motorized vehicle. It may create a traffic hazard and is illegal in many areas. It can also be potentially dangerous to play your recorder at high volume while walking, especially at pedestrian crossings. You should exercise extreme caution or discontinue use in potentially hazardous situations.

Preventing hearing damage

Avoid using headphones/earphones at high volume. Hearing experts advise against continuous, loud and extended play. If you experience a ringing in your ears, reduce the volume or discontinue use.

Caring for others

Keep the volume at a moderate level. This will allow you to hear outside sounds and to be considerate of the people around you.

On the MiniDisc cartridge

- When carrying or storing the MiniDisc, keep it in its case.
- Do not break open the shutter.
- Do not place the cartridge where it will be subject to light, extreme temperatures, moisture or dust.
- Attach the supplied MD label only in the space designated for it on the disc. Do not stick it on any other disc surface.

On cleaning

- Clean the recorder casing with a soft cloth slightly moistened with water or a mild detergent solution. Do not use any type of abrasive pad, scouring powder or solvent such as alcohol or benzene as it may mar the finish of the casing.
- Wipe the disc cartridge with a dry cloth to remove dirt.
- Dust on the lens may prevent the unit from operating properly. Be sure to close the disc compartment lid after inserting or ejecting an MD.
- To obtain the best sound quality, use a dry cloth to wipe the plugs of the headphones/earphones. Dirty plugs may cause sound distortion or intermittent breaks in the sound.

Notes on battery

Incorrect battery usage may lead to leakage of battery fluid or bursting battery. To prevent such accidents, observe the following precautions:

- Install the + and - poles of the battery correctly.
- Do not try to recharge dry battery.
- When the recorder is not to be used for a long time, be sure to remove the battery.
- Do not carry or store the dry battery with metallic objects such as coins, key rings, or necklaces. This may cause a short-circuit and the generation of heat.
- If a battery leak should develop, carefully and thoroughly wipe away battery fluid from the battery compartment before inserting new ones.

Note on mechanical noise

The recorder gives off mechanical noise while operating, which is caused by the power-saving system of the recorder and it is not a problem.

Note on maintenance

Clean the terminals periodically with a cotton swab or a soft cloth as illustrated.

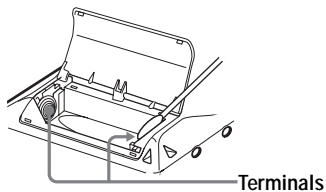

If you have any questions or problems concerning your recorder, please consult your nearest Sony dealer. (If a trouble occurred when the disc was in the recorder, we recommend that the disc be left in the recorder when you consult your Sony dealer so that the cause of trouble may be better understood.)

System limitations

The recording system in your MiniDisc recorder is radically different from those used in cassette and DAT decks and is characterized by the limitations described below. Note, however, that these limitations are due to the inherent nature of the MD recording system itself and not to mechanical causes.

Symptom	Cause
“TrFULL” appears even before the disc has reached the maximum recording time (60, 74, or 80 minutes).	When 254 tracks have been recorded on the disc, “TrFULL” appears regardless of the total recorded time. More than 254 tracks cannot be recorded on the disc. To continue recording, erase unnecessary tracks.
“TrFULL” appears even before the disc has reached the maximum track number or recording time.	Repeated recording and erasing may cause fragmentation and scattering of data. Although those scattered data can be read, each fragment is counted as a track. In this case, the number of tracks may reach 254 and further recording is not possible. To continue recording, erase unnecessary tracks.
Track marks cannot be erased.	When the data of a track is fragmented, the track mark of a fragment under 12 seconds long (recorded in stereo), 24 seconds long (recorded in monaural or LP2 mode), or 48 seconds long (recorded in LP4 mode) cannot be erased. You cannot combine a track recorded in different recording mode, e.g., a track recorded in stereo and a track recorded in monaural; nor can you combine a track recorded with digital connection and a track recorded with analog connection.
The remaining recording time does not increase even after erasing numerous short tracks.	Tracks of under 12 seconds, 24 seconds, or 48 seconds in length are not counted and so erasing them may not lead to an increase in the recording time.
The total recorded time and the remaining time on the disc may not total the maximum recording time (60, 74, or 80 minutes).	Normally, recording is done in minimum units of approximately 2 seconds (in stereo), 4 seconds (in monaural or LP2 mode), or 8 seconds (in LP4 mode). When recording is stopped, the last unit of recording always uses this unit of 2 seconds, 4 seconds, or 8 seconds even if the actual recording is shorter. Likewise, when recording is restarted after the stop, the recorder will automatically insert a blank space amounting to 2 seconds, 4 seconds, or 8 seconds before the next recording. (This is to prevent accidental erasing of a previous track whenever a new recording is started). Therefore, the actual recording time will decrease whenever a recording is stopped by a maximum of 6 seconds, 12 seconds, or 24 seconds.
The edited tracks may exhibit sound dropout during search operations.	The fragmentation of data may cause sound dropout while searching because the tracks are played in higher speed than normal playback.

Symptom	Cause
A track cannot be recorded to a new group. A new group cannot be created.	Group information has been written to the area where the disc name is stored. The disc name and track names are recorded in the same area, which can store a maximum of approximately 1,700 characters. If the total number exceeds this amount, a new group cannot be created even though group mode is on. It is also impossible to make group settings at this time.

Troubleshooting

Should any problem persist after you have made these checks, consult your nearest Sony dealer. Refer to “Messages” (page 52) as well.

Symptom	Cause/Solution
The recorder does not work or works poorly.	<ul style="list-style-type: none"> • Audio sources may not be securely connected. <ul style="list-style-type: none"> ➔ Disconnect the audio sources once and connect them again (pages 14, 20). • The HOLD function is turned on (“HOLD” appears in the display when you press an operation button). <ul style="list-style-type: none"> ➔ On the recorder, disable HOLD by sliding the HOLD switch to the opposite direction of the arrow (pages 12, 44). • The lid is not firmly closed. <ul style="list-style-type: none"> ➔ Close the lid until it clicks. Then press OPEN to open the lid. • Moisture has condensed inside the recorder. <ul style="list-style-type: none"> ➔ Take the MD out and leave the recorder in a warm place for several hours until the moisture evaporates. • The dry battery is weak (“LoBATT” flashes or nothing appears). <ul style="list-style-type: none"> ➔ Replace the dry battery with the new one (page 11), or connect the supplied AC power adaptor to the recorder. • The dry battery have been inserted incorrectly. <ul style="list-style-type: none"> ➔ Insert the battery correctly (page 11). • You pressed a button while the disc indication was rotating quickly. <ul style="list-style-type: none"> ➔ Wait until the indication rotates slowly. • When recording digitally from a portable CD player, you did not use the AC power adaptor or did not disable the anti-skip function such as ESP (page 16). • The analog recording was made using a connecting cord with an attenuator. <ul style="list-style-type: none"> ➔ Use a connecting cord without an attenuator (page 20). • The AC power adaptor was unplugged during recording or a power outage occurred.

Symptom	Cause/Solution
The recorder does not work or works poorly.	<ul style="list-style-type: none"> • While operating, the recorder received a mechanical shock, too much static, abnormal power voltage caused by lightning, etc. <ul style="list-style-type: none"> ➔ Restart the operation as follows. <ol style="list-style-type: none"> 1 Disconnect all the power sources. 2 Leave the recorder for about 30 seconds. 3 Connect the power source. • The disc is damaged or does not contain proper recording or editing data. <ul style="list-style-type: none"> ➔ Reinsert the disc. Rerecord the disc. If the error message still appears, replace it with another disc. • The disc is record-protected (“SAVED” appears). <ul style="list-style-type: none"> ➔ Slide the tab (page 61). • Recording level is too small to record (when recording manually). <ul style="list-style-type: none"> ➔ Pause the recorder and adjust the recording level. • A premastered MD is inserted (“PbONLY” appears) when recording. <ul style="list-style-type: none"> ➔ Insert a recordable MD. • You tried to turn group mode on while setting the program. <ul style="list-style-type: none"> ➔ Turn group mode on before setting the program.
The recorder does not start recording.	<ul style="list-style-type: none"> • The recorder may be in recording standby mode (i.e., you pressed II while pressing REC). <ul style="list-style-type: none"> ➔ Press II to start recording.
The recorder overwrites existing materials when record.	<ul style="list-style-type: none"> • The record starting-position setting (“R-Posi”) is set to “FrHere”. <ul style="list-style-type: none"> ➔ Set “R-Posi” setting to “Fr End”.
“No SIG” appears in the display when recording from a portable CD player.	<ul style="list-style-type: none"> • There is no digital signal from the portable CD player. <ul style="list-style-type: none"> ➔ When recording digitally from a portable CD player, use the AC power adaptor and disable the anti-skip function (such as ESP) on the CD player (page 16).
There is no recording on the MD after a recording operation.	<ul style="list-style-type: none"> • The AC power adaptor was unplugged or a power outage occurred during recording.
The lid does not open.	<ul style="list-style-type: none"> • The power sources have been disconnected during recording or editing, or the battery have been exhausted. <ul style="list-style-type: none"> ➔ Set the power sources again, or replace the exhausted battery with new ones. • The lid is not firmly closed. <ul style="list-style-type: none"> ➔ Close the lid until it clicks. Then press OPEN to open the lid.
No sound comes through the headphones/earphones.	<ul style="list-style-type: none"> • The headphones/earphones plug is not firmly connected. <ul style="list-style-type: none"> ➔ Plug in the plug of the headphones/earphones firmly to . • Volume is too low. <ul style="list-style-type: none"> ➔ Adjust the volume by pressing VOL +, -. • The plug is dirty. <ul style="list-style-type: none"> ➔ Clean the plug.

Symptom	Cause/Solution
Volume cannot be turned up.	<ul style="list-style-type: none"> • AVLS is on. ➔ Set AVLS to “OFF” (page 43).
An MD is not played normally.	<ul style="list-style-type: none"> • Playback mode is changed. ➔ Change to the normal play.
An MD is not played from the first track.	<ul style="list-style-type: none"> • Disc playing stopped before it came to the last track. ➔ Press ► for 2 seconds or more to start playing. • Group mode is turned on. ➔ Turn group mode off and play from the first track (press ► for 2 seconds or more to start playing).
Playback sound skips.	<ul style="list-style-type: none"> • The recorder is placed where it receives continuous vibration. ➔ Put the recorder on a stable place. • A very short track may cause sound to skip. ➔ Try not to create a track under one second long.
Sound has a lot of static.	<ul style="list-style-type: none"> • Strong magnetism from a television or such device is interfering with operation. ➔ Move the recorder away from the source of strong magnetism.
Cannot find the track marks.	<ul style="list-style-type: none"> • You pressed after pressing ◀◀ or ▶▶. ➔ Press before pressing ◀◀ or ▶▶.
The disc cannot edit on other component.	<ul style="list-style-type: none"> • The component does not support LP2 stereo or LP4 stereo. ➔ Edit on other component that support LP2 stereo or LP4 stereo.
Momentary noise is heard.	<ul style="list-style-type: none"> • Due to the special digital audio compression technology used in LP4 stereo mode, momentary noise may occur on very rare occasions with certain sound sources. ➔ Record in normal stereo or LP2 stereo mode.
The display window is not normal.	<ul style="list-style-type: none"> • The recorder was disconnected from the power source. ➔ Let the recorder sit for a while, or disconnect the power source, reconnect it, and then press any of the operation buttons.

Messages

If the following messages flash in the display window, check the messages below.

Error message	Meaning/Remedy
BLANK	<ul style="list-style-type: none">• An MD with no recording on it is inserted.
BUSY	<ul style="list-style-type: none">• You tried to operate the recorder while it was accessing the recorded data.<ul style="list-style-type: none">➔ Wait until the message goes out (in rare cases, it may take a few minutes).
Edit	<ul style="list-style-type: none">• The MD player is recording information (track start and end position) from the memory to the disk.<ul style="list-style-type: none">➔ Wait until this process is completed. Do not expose the player to physical shock, nor disrupt power supply.
ERROR	<ul style="list-style-type: none">• Recording was not correctly done.<ul style="list-style-type: none">➔ Place the recorder at a place with no vibrations and record again.• The disc is soiled with an oil film or finger prints, is scratched, or is not a standard disc.<ul style="list-style-type: none">➔ Try recording again with another disc.• The recorder cannot read the disc information correctly.<ul style="list-style-type: none">➔ Reinsert the disc.• The recorder cannot read the disc information correctly.<ul style="list-style-type: none">➔ Insert another disc.➔ If it is no problem to erase the entire disc, do so (page 42).
FULL	<ul style="list-style-type: none">• The remaining recording time on the disc is 12 seconds (stereo), 24 seconds (LP2 stereo or monaural), 36 seconds (LP4 stereo), or less.<ul style="list-style-type: none">➔ Replace the disc.• You tried to enter more than 200 letters to label a single track or disc.• You tried to enter a total of more than 1,700 letters for track or disc names.<ul style="list-style-type: none">➔ Enter a shorter name for the track, group, or disc (page 34), or set the “LPStmp” setting to “OFF” so that “LP:” is not added at the beginning of the track name (page 22).
HiDCin	<ul style="list-style-type: none">• Voltage of the power supply is too high (The supplied AC power adaptor or the recommended car battery cord is not used).<ul style="list-style-type: none">➔ Use the supplied AC power adaptor or the recommended car battery cord.
HOLD	<ul style="list-style-type: none">• The recorder is locked.<ul style="list-style-type: none">➔ Slide HOLD against the arrow to unlock the recorder (page 12).
LoBATT	<ul style="list-style-type: none">• Battery is weak.<ul style="list-style-type: none">➔ Replace the dry battery (page 11).
MEMORY	<ul style="list-style-type: none">• You tried to record with the recorder placed where it receives continuous vibration.<ul style="list-style-type: none">➔ Put the recorder on a stable place, and start recording again.

Error message	Meaning/Remedy
NoCOPY	<ul style="list-style-type: none"> • You tried to make a copy from a disc that is protected by the Serial Copy Management System. You cannot make copies from a digitally connected source which was itself recorded using digital connection. ➔ Use analog connection instead (page 20).
NoDISC	<ul style="list-style-type: none"> • You tried to play or record with no disc in the recorder. ➔ Insert an MD.
No SIG	<ul style="list-style-type: none"> • The recorder could not detect digital input signals. ➔ Make sure that the source is connected firmly (page 13).
PbONLY	<ul style="list-style-type: none"> • You tried to record or edit on a pre mastered MD (Pb stands for “playback”). ➔ Insert a recordable MD.
SAVED	<ul style="list-style-type: none"> • You tried to record or edit on a MD with the tab in the record-protect position. ➔ Slide the tab back (page 61).
Saving	<ul style="list-style-type: none"> • The MD player is recording information (sounds) from the memory to the disc. ➔ Wait until this process is completed. Do not expose the player to any physical shock, nor disrupt power supply.
SORRY	<ul style="list-style-type: none"> • You tried to erase the track mark at the beginning of the first track. • You tried to erase a track mark to combine tracks the recorder cannot combine (a track recorded in stereo and in mono, for example). • You tried to overwrite a track marks. • You tried to press II or T MARK during synchro-recording. • You tried to turn on the group function while programming. ➔ Turn the group function on before programming.
TEMP	<ul style="list-style-type: none"> • Heat has built up in the recorder. ➔ Let the recorder cool down.
TrFULL	<ul style="list-style-type: none"> • Track number 254 has been reached. ➔ Erase unnecessary tracks (page 41).
TrPROT	<ul style="list-style-type: none"> • You tried to record or edit on a track that is protected from erasing. ➔ Record or edit on other tracks. • You tried to edit a track that has been checked out from a computer. ➔ Check the track back in to the computer and then edit (page 61).

List of menus

Menu functions

Press MENU to enter the menu, and press ◀ or ▶ to select the item.

Menu on the recorder ¹⁾	Functions
EDIT	Selecting editing operations (labeling, erasing tracks, discs, or groups, etc.) (page 35 to 39, 41 and 42).
DISP	Displaying elapsed playing time, remaining playing time, etc. (page 27 and 33).
P-MODE	Selecting play mode (repeat play, shuffle play, etc.) (page 30).
RecVol	Selecting the automatic or manual recording level adjustment (page 26).
R-MODE	Selecting recording mode (SP stereo, LP2 stereo, LP4 stereo, or monaural) (page 21).
S-SEL	Selecting “SOUND1” or “SOUND2” (Digital Sound Preset) (page 32).
S-SET	Changing the sound quality of the preset sound (“SOUND1” or “SOUND2”) (page 32).
TimeMk	Selecting the Auto Time Stamp setting (page 25).
SYNC-R	Selecting “ON” or “OFF” of synchro recording (page 13).
OPTION	<ul style="list-style-type: none">• AVLS (Automatic Volume Limiter System) — Selecting “ON” or “OFF” (page 43).• BEEP — Selecting “ON” or “OFF” (page 43).• R-Posi — Selecting the start point when recording (page 24).• LPStmp — Selecting “ON” (“LP:” will be added at the beginning of the track name) or “OFF” (page 22).

¹⁾ The menu items that can be selected vary according to the on/off status of group mode or the operating status of the recorder.

Tables of Menus on the recorder

The menus provided on the recorder for each operating status are shown on this and the following pages. Each chart shows the various menus and the menu items that can be selected at each menu level. See "List of menus" (page 54) for details on menu operations. Menus and menu items toggle in the display.

Menus and menu items selected while the recorder is stopped

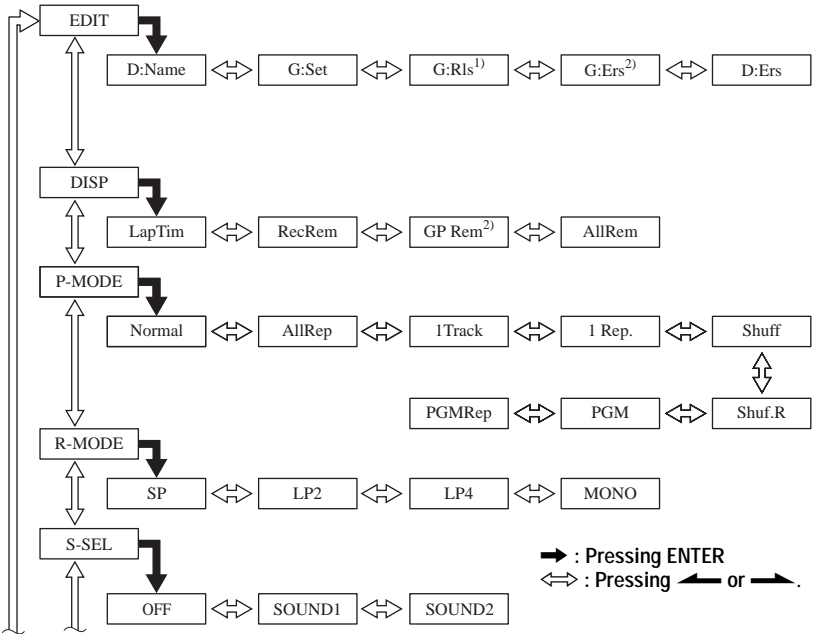

continued from the previous page

➔ : Pressing ENTER
↔ : Pressing ← or →

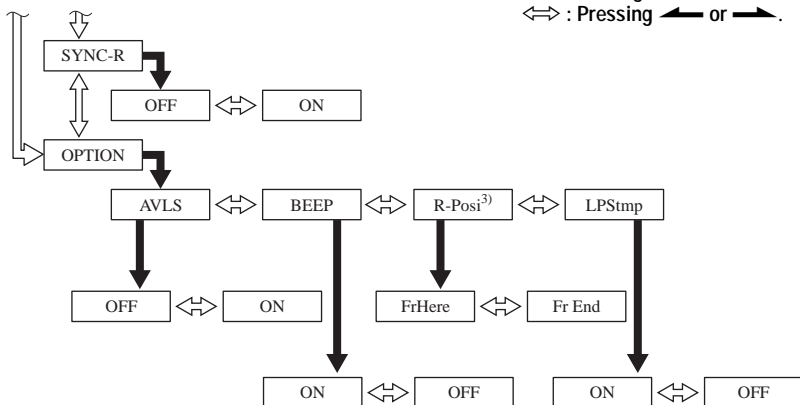

¹⁾ Appears only when the recorder is in group mode and a group other than “GP --” is selected.

²⁾ Appears only when the recorder is in group mode.

³⁾ Selectable only when group mode is turned off.

Press CANCEL to cancel a menu operation.

Menus and menu items selected while the recorder is playing

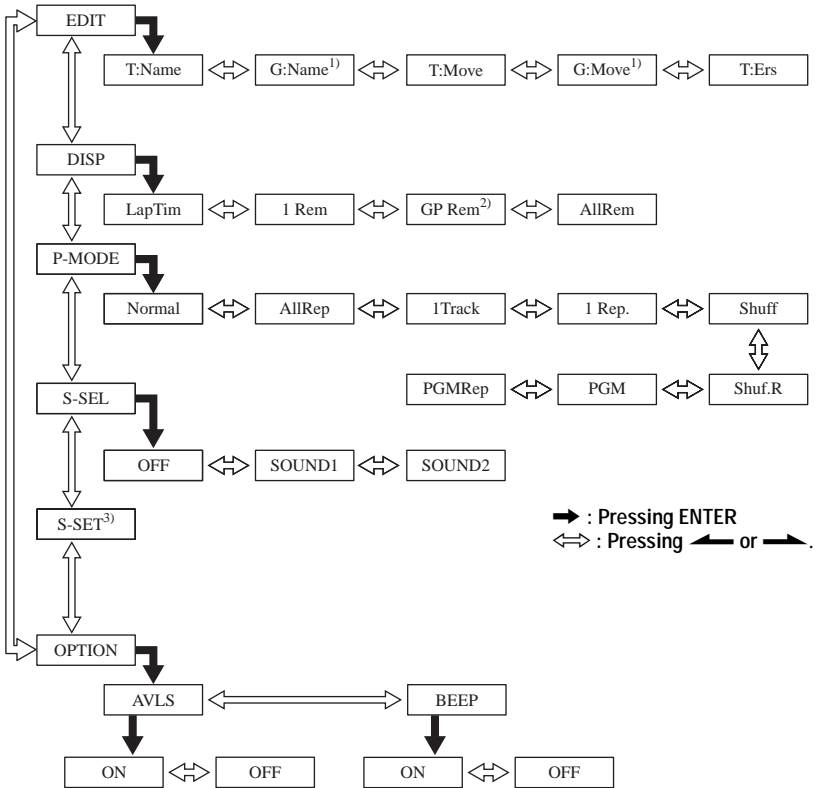

¹⁾ Appears only when the recorder is in group mode and a group other than “GP --” is selected.

²⁾ Appears only when the recorder is in group mode.

³⁾ Appears only when “SOUND1” or “SOUND2” is selected.

Press CANCEL to cancel a menu operation.

Menus and menu items selected while the recorder is recording

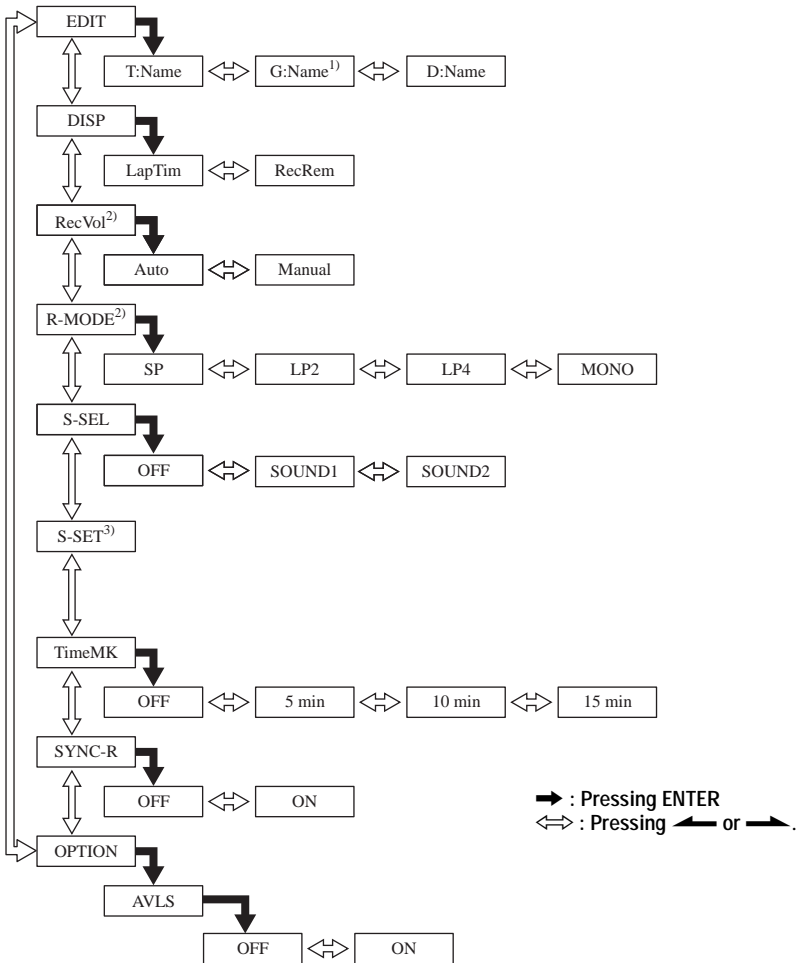

¹) Appears only when the recorder is in group mode.
 ²) Appears only when the recorder is in standby mode.
 ³) Appears only when "SOUND1" or "SOUND2" is selected.

Press CANCEL to cancel a menu operation.

Specifications

MD Recorder

Audio playing system

MiniDisc digital audio system

Laser diode properties

Material: GaAlAs MQW

Wavelength: $\lambda = 790$ nm

Emission duration: continuous

Laser output: less than $44.6 \mu\text{W}$

(This output is the value measured at a distance of 200 mm from the lens surface on the optical pick-up block with 7 mm aperture.)

Recording and playback time

When using MDW-80

Maximum 160 min. in monaural

Maximum 320 min. in stereo

Revolutions

Approx. 380 rpm to 2,700 rpm (CLV)

Error correction

ACIRC (Advanced Cross Interleave Reed

Solomon Code)

Sampling frequency

44.1 kHz

Sampling rate converter

Input: 32 kHz/44.1 kHz/48 kHz

Coding

ATrac (Adaptive TRansform Acoustic

Coding)

ATrac3 — LP2/LP4

Modulation system

EFM (Eight to Fourteen Modulation)

Number of channels

2 stereo channels

1 monaural channel

Frequency response

20 to 20,000 Hz \pm 3 dB

Wow and Flutter

Below measurable limit

Inputs

Line in: stereo mini-jack, minimum input level

49 mV

Optical (Digital) in: optical (digital) mini-jack

Outputs

⌚: stereo mini-jack, maximum output level

5 mW + 5 mW, load impedance 16 ohm

General

Power requirements

Sony AC Power Adaptor (supplied) connected at the DC IN 3 V jack (country model in parentheses):

120 V AC, 60 Hz (USA, Canada and Taiwan)

230 V AC, 50/60 Hz (Continental Europe and Singapore)

240 V AC, 50 Hz (Australia)

220 V AC, 50 Hz (China)

230 - 240 V AC, 50 Hz (UK and Hong Kong)

110/220 V AC, 60 Hz (Korea)

100 - 240 V AC, 50/60 Hz (Other countries)

LR6 (size AA) alkaline dry battery

Battery operation time

See "Battery life" (page 45)

Dimensions

Approx. $81 \times 27.9 \times 74.4$ mm (w/h/d) ($3\frac{1}{4} \times 1\frac{1}{8} \times 3$ in.) without projections.

Mass

Approx. 101 g (3.6 oz) the recorder only

US and foreign patents licensed from Dolby Laboratories.

Design and specifications are subject to change without notice.

Optional accessories

Optical Cable

POC-15B, POC-15AB, POC-DA12SP

Stereo Headphones/earphones* MDR-EX70LP,

MDR-72LP, MDR-A34LP

Active Speakers SRS-Z500

Recordable MDs MDW-series

Your dealer may not handle some of the above listed accessories. Please ask the dealer for detailed information about the accessories in your country.

* When using optional headphones, use only headphones/earphones with stereo mini plugs. You cannot use headphones/earphones with micro plugs.

Explanations

How the MiniDisc got so small

The 2.5-inch MiniDisc, encased in a plastic cartridge that looks like a 3.5-inch diskette (see illustration above), uses a new digital audio compression technology called ATRAC (Adaptive TRansform Acoustic Coding). To store more sound in less space, ATRAC extracts and encodes only those frequency components actually audible to the human ear.

Quick Random Access

Like CDs, MDs offer instantaneous random access to the beginning of any music track. Premastered MDs are recorded with location addresses corresponding to each music selection.

Recordable MDs are manufactured with a “User TOC Area” to contain the order of the music. The TOC (Table of Contents) system is similar to the “directory management system” of floppy disks. In other words, starting and ending addresses for all music tracks recorded on the disc are stored in this area. This lets you randomly access the beginning of any track as soon as you enter the track number (AMS), as well as label the location with a track name as you would a file on a diskette.

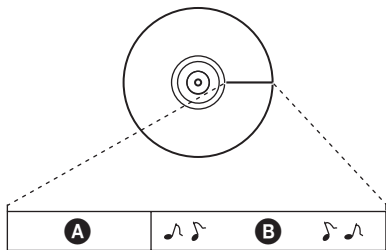

A — User TOC Area
Contains the order and start/end points of the music.

B — Music Data

The meaning of “no sound”

“No sound” describes a recorder condition in which the input level is about 4.8 mV during analog input or less than -89 dB during optical (digital) input (with 0 dB as full bit (the maximum recordable level for a MiniDisc)).

Note on digital recording

This recorder uses the Serial Copy Management System, which allows only first-generation digital copies to be made from premastered software. You can only make copies from a home-recorded MD by using the analog connections.

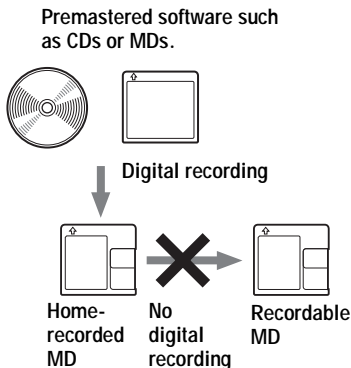

Microphone, record player, tuner, etc.
(with analog output jacks).

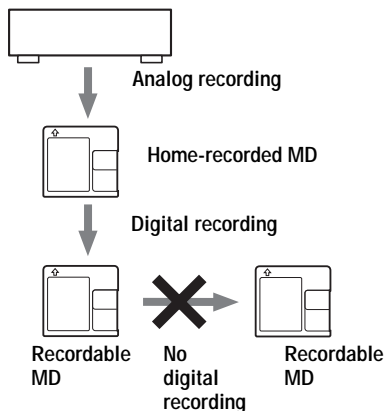

Restrictions on the editing of tracks checked out from the computer

This unit was designed so that editing functions (i.e., erasing tracks, adding track marks, and erasing track marks) do not function for tracks that have been checked out from the computer using a unit which support Net MD. This is to prevent the loss of check-in authorization by the checked-out tracks. To edit these tracks, first check them back into the computer, and then edit them on the computer.

To protect a recorded MD

To record-protect an MD, slide open the tab at the side of the MD. In this position, the MD cannot be recorded or edited. To record again, slide the tab back so the tab is visible.

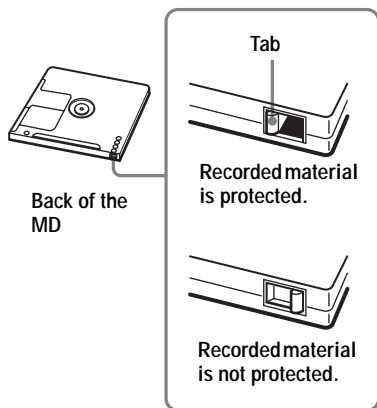

Index

A

- Accessories
 - supplied 8
- Auto Time Stamp 25
- AVLS 43

B

- Battery
 - battery life 12, 45
 - dry battery 11
- Beep sound 43

C

- Checking
 - playing position 27
 - remaining time 27, 33
- Cleaning 46
- Connecting
 - analog 20
 - digital 14

D

- Digital Sound Preset 32
- DSP TYPE-R 15

E

- Erasing
 - a group 42
 - a track 41
 - a whole disc 42

G

- G-PROTECTION 18
- Group
 - erase 42
 - Group Mode Playback 29
 - Group Mode Recording 23
 - Group Move 39
 - Group Skip Mode 29
 - release 37
 - Setting 36

H

- HOLD 12, 44

L

- Labeling 35

M

- Manual Recording 26
- MDLP 21
- Menus 54

P

- Play mode 30

R

- Recording
 - adding track marks (Auto Time Stamp)
 - 25
 - digital 13
 - Group Mode Recording 22
 - MDLP mode 21
 - without overwriting tracks 24

- Relabeling 36

T

- Track mark
 - Adding 40
 - Erasing 40



Printed using VOC (Volatile Organic
Compound)-free vegetable oil ink.

<http://www.sony.net/>

Printed in Malaysia