



The Leader in Architectural Audio™

PN.33-2381 4.02

IMPORTANT SAFETY INSTRUCTIONS

CAUTION: Read all of these instructions before you operate and save instructions for later use.

1. Read Instructions - all the safety and operating instructions should be read before the appliance is operated.
2. Retain Instructions - The safety and operating instructions should be retained for future reference.
3. Heed Warnings - All warnings on the appliance and in the operating instructions should be adhered to.
4. Follow Instructions - All operating and use instructions should be followed.
5. Water and Moisture- The appliance should not be used near water - for example, near a bathtub, washbowl, kitchen sink, laundry tub, in a wet basement, or near a swimming pool.
6. Carts and Stands - The appliance should be used only with a cart or stand that is stable and sturdy enough to hold the product. An appliance and cart combination should be moved with care. Quick stops, excessive force and uneven surfaces may cause the appliance and cart combination to overturn.
7. Caution: To prevent electric shock, do not use this (polarized) plug with an extension cord, receptacle or other outlets unless the blades can be fully inserted to prevent blade exposure.
8. Ventilation - The appliance should be situated so that its location or position does not interfere with its proper ventilation. For example, the appliance should not be situated on a bed, sofa, rug, or similar surface that may block the ventilation openings or, placed in a built-in installation, such as a bookcase or cabinet that may impede the flow of air through the ventilation openings.
9. Heat - The appliance should be situated away from heat sources such as radiators, heat registers, stoves, or other appliances (including amplifiers) that produce heat.
10. Power Sources - The appliance should be connected to a power supply only of the type described in the operating instructions or as marked on the appliance.
11. Grounding or Polarization - Precautions that should be taken so that the grounding or polarization of the appliance is not defeated.
12. Power-Cord Protection - Power supply cords should be routed so that they are not likely to be walked on or pinched by items placed upon or against them, paying particular attention to cords at plugs, convenience receptacles, and the point where they exit from the appliance.
13. Cleaning - Dust the product with a clean cloth. NEVER use water.
14. Non-use Periods - The power cord of the appliance should be unplugged from the outlet when left unused for a long period of time.
15. Object and Liquid Entry - Care should be taken so that objects do not fall and liquids are not spilled into the enclosure through openings.
16. Damage Requiring Service - The appliance should be serviced by qualified service personnel when:
 - A. The power-supply cord or the plug has been damaged.
 - B. Objects have fallen, or liquid has been spilled into the appliance.
 - C. The appliance has been exposed to rain.
 - D. The appliance does not appear to operate normally or exhibits a marked change in performance.
 - E. The appliance has been dropped, or the enclosure damaged.
17. Servicing - The user should not attempt to service the appliance beyond that described in the operating instructions. All other servicing should be referred to qualified service personnel.

INSTALLATION INSTRUCTIONS

SONAMP® ASAP2 SAT
STEREO POWER AMPLIFIER

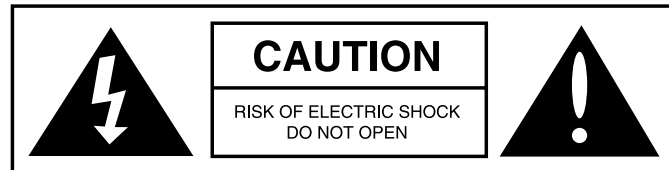

CAUTION: TO REDUCE THE RISK OF ELECTRIC SHOCK, DO NOT REMOVE COVER (OR BACK) NO USER SERVICEABLE PARTS INSIDE REFER SERVICING TO AUTHORIZED SERVICE PERSONNEL.

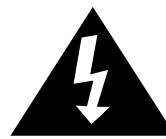

The lightning flash with arrowhead symbol, within an equilateral triangle, is intended to alert the user to the presence of uninsulated dangerous voltage within the product's enclosure that may be of sufficient magnitude to constitute a risk of electric shock to persons.



The exclamation point within an equilateral triangle is intended to alert the user to the presence of important operating and maintenance (servicing) instructions in the literature accompanying the appliance.

WARNING: TO PREVENT FIRE OR SHOCK HAZARD, DO NOT EXPOSE THIS APPLIANCE TO RAIN OR MOISTURE. THE APPARATUS SHALL NOT BE EXPOSED TO DRIPPING, SPLASHING, AND THAT NO OBJECTS FILLED WITH LIQUIDS, SUCH AS VASES, SHALL BE PLACED IN THE APPARATUS.



**WARNING
MOVE WITH CARE**

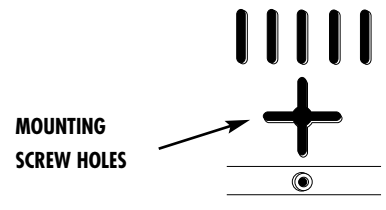
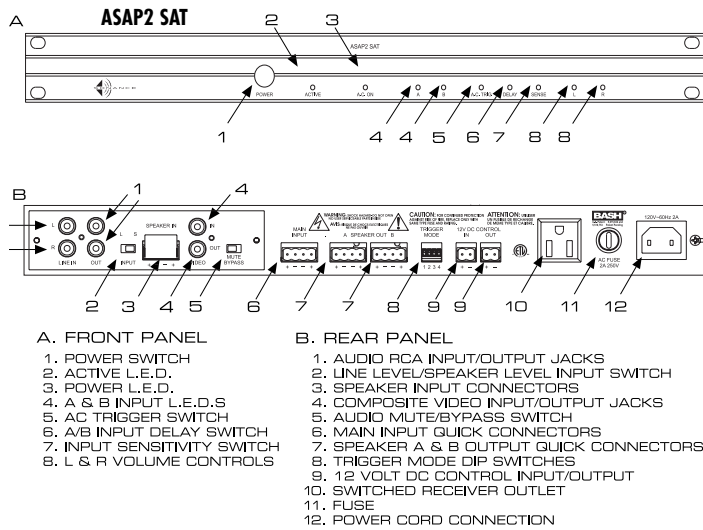

DO NOT PLUG THE ASAP2 IN UNTIL ALL OTHER CONNECTIONS ARE MADE. MAKE SURE ALL SOURCE AMPLIFIERS BEING CONNECTED TO THE UNIT ARE OFF

MAKING CONNECTIONS

Before making any signal or speaker connections, make sure your power amplifier is turned off and unplugged. When making connections, make sure there is no strain or tension on input leads or speaker wires that could cause them to pull loose later on.

BASIC CONCEPT

The audio amplifiers in most televisions, even monitors, usually deliver a few watts - not enough to properly drive many external speakers connected to the set. The ASAP2 amplifies any local sound source (like a TV or Multimedia), and will deliver 50 Watts per channel into 8 ohms or 65 watts per channel into 4 ohms. It also provides flawless automatic switching between the Local source (TV) and a Main house audio system. The versatile triggering system will allow multitude of automation possibilities. When connected to both sources, the ASAP2 enables the local area speakers to play the Main music system normally, and then switch to the Local music source automatically.

BASH® POWER AMPLIFICATION

The Sonamp® ASAP2 uses a new revolutionary power amplifier technology called BASH® that is high efficiency and requires very little heat sink area. Conventional power amplifier technology to produce the same power output would require massive heat sinks and a larger chassis for cooling. The amplifier is fully protected against overheating, short circuits and low impedance loading.

UNPACKING

Save your carton and the styrofoam inserts for future safe transport in case you move or the unit ever requires shipping for repair. **Note, it is best if you place it into an additional outer "overcarton" before shipment to minimize a chance of theft in shipment.**

Before you proceed, find the serial number which is located on the rear panel of the unit and note it here for future reference.

Serial # _____

PLACEMENT OF YOUR ASAP2 SAT

The ASAP2 is designed to operate automatically and is housed in a compact chassis that can be mounted out of sight. The unit can be placed horizontally on its rubber feet, or the rubber feet can be easily removed by peeling them off of the bottom of the chassis for rack mounting. When used with a TV set, it may be convenient to hide the unit on the back or side wall of the cabinet or bookshelf (not on the TV itself). The ASAP2 features screw mounting holes on the bottom of the chassis (see figure on top of next column). Mount the ASAP2 vertically with the heat sinks on top. As with any other power amplifier, allow for adequate air circulation around the unit and do not mount it in direct sunlight or near a heat source such as hot air ducts or radiators.

* BASH is a registered trademark of Indigo Incorporated.

Input and Output Connections

Speaker Level Outputs from a Local TV

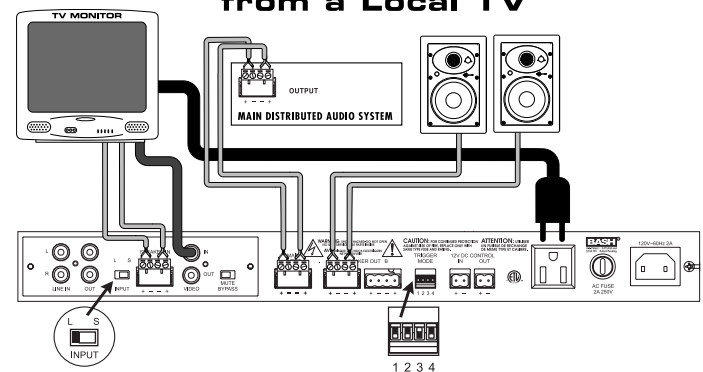

Line Level Outputs from a Local TV

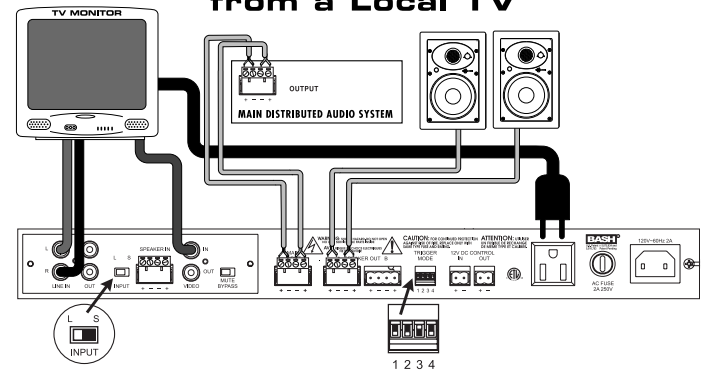

Use the RCA jacks for the R and L channels. Make sure these are consistent with the R and L outputs from your preamplifier/receiver.

Looping Jacks

Your ASAP2 provides a pair of RCA output jacks, which duplicate the input signal. These facilitate connection of additional power amplifiers from a single source component. With these un-buffered output jacks, you can link or "loop" amplifiers without messy Y-cord adaptors.

Speaker Connections

Very Important: Before starting, the output connections are naturally in bridged mode. This means that the negative terminals are inverting power amplifiers. **NO COMMON GROUNDS!** Do not connect negative terminals together under any circumstances. Never use 3 conductor wire, sharing the negative output terminals.

Polarity

It is important to observe correct polarity when using stereo mode. One side of the speaker lead will have some sort of mark, either printing, a raised ridge on the insulation or different color of conductor. This permits you to know which wire you had connected to the + and which to the - speaker terminals so you can do exactly the same at the power amplifier terminals.

Use Good Wire

For best results you should never use thin gauge speaker wire – it will constrict the sound and deteriorate bass response. We recommend use of premium Sonance MediaLinQ® speaker cable, which also complies with UL fire rating. Be sure to check local codes governing wire that may be installed within walls or ceilings. Each brand of wire will have a different characteristic sound and some may be more compatible with the sonic “signature” of your various components. Your Sonamp ASAP2 is stable with any reputable brand of wire and speaker cable.

AC Line cord

The ASAP2 features a removable IEC power cord, allowing for easy installation. Plug the female end of the power cord into the inlet in the rear panel and plug the male end into a grounded wall socket. DO NOT plug the power cord into an AC outlet on your preamplifier/receiver. **CAUTION: THE PREVENT ELECTRIC SHOCK, DO NOT DEFEAT THE THIRD PRONG OF THE POWER CORD PLUG. ATTENTION: A FIN D'EVITER TOUT RISQUE D'ELECTROCUTION, NEPAS ENLEVER LA 3EME FICHE DE LA PRISE ELECTRIQUE.** Use only a heavy duty extension cord, if required, to avoid starving the amplifier of all the current necessary for full power operation.

Speaker Wiring

Two pairs of parallel output quick-connect screw terminals are provided. Connect the local loudspeakers to the Speaker A or B terminals on the back of the ASAP2. If using two pairs of speakers, use only speakers with an impedance of 6 ohms or greater. Use bare wire and strip only enough wire (1/4") to fit into the slot in the terminal. Before inserting the wire, twist all its strands tightly to prevent stray strands that could cause a short circuit between + and - terminals! Tighten each terminal connection securely.

Main Input

This speaker level input is the default or main input when no trigger stimulus is applied. If the power is disconnected, the audio passes through the main input directly to the speaker outputs. If the Red Main source LED is lit, then you are listening to Main input. Pressing the power button "off", will force the unit to Main input. This will lock out all Local input automatic mode activity.

Voltage Turn On Mode (switch set to CENTER or "External Volt" position)

The Sonamp ASAP2 features a removable voltage input connector to connect other electronics with voltage control outputs. When the dip switch is set to Voltage Trigger mode, the voltage trigger monitors the voltage input connector and turns on the amplifier when voltage (either AC or DC) between 5V and 24V is detected.

Voltage Output Connector

The Sonamp ASAP2 features a removable voltage output connector to provide 12VDC to control other devices such as Sonance Industry Upgrades, 12-V relays, or other Sonamps. The current draw should not exceed 200mA.

OPERATING THE ASAP2

Make all speaker, input and control connections before applying AC power. Connect the ASAP2 to an unswitched AC outlet. (Or switched outlet for bypass mode) Power up the rest of the system and proceed with the adjustments below.

Audio Muting Bypass Switch (rear panel)

Set this switch to ON position if using the AC trigger function to minimize thumps or pops from television audio outputs. If using Audio/Video triggering, set to OFF for fastest transition to local source.

Line Level / Speaker Level input switch (rear panel)

Set to the appropriate input used, choosing the best input for the application. Line level is preferred for lowest noise and distortion. Line level and Speaker sources cannot be used together.

Trigger Mode DIP Switch (rear panel)

On the rear panel there is a small DIP switch for selecting one or more combination of trigger to local source. The default factory setting is audio/video triggering switch #1.

Switch functions:

DIP switch 1	Audio/ Video source trigger (Default)
DIP switch 2	External low voltage trigger. 5 to 24 Volts AC or DC
DIP switch 3	AC power outlet trigger
DIP switch 4	Bypass of automatic triggering. Forced local source setting.

A combination trigger application would be an Audio/ Video trigger by VCR signal and an AC Trigger by television power draw.

Audio Trigger (Dip switch #1 On -- UP Position)

ASAP2 includes two source inputs. The default, or "A" input is for the remote (house) music system that will play whenever the local source is off or completely muted. These inputs are at speaker-level and are direct pass through. Connect the remote (house) music system here. The Sensing, or B, input is for the local source component such as a TV, DVD or CD player, tape player or portable stereo. Whenever this local source is turned on and there is an audio signal present at the B inputs, the ASAP2 automatically switches itself into the circuit amplifying the local signal and driving the room loudspeakers.

The B inputs have both speaker-level connections and line-level connections (RCA jacks). Select either one by sliding the switch on the rear panel to connect to the local system. If you use the speaker-level inputs, use bare wire and strip only enough wire (1/2") to fit into the slot in the terminal. Before inserting the wire, twist all its strands tightly to prevent strays that could cause a short circuit between + and - terminals! If you use line level inputs, run RCA patch cords from the variable outputs on the TV set or other local source. If the local source has both line level and speaker level outputs, use the line level outputs for better performance.

Video Trigger (Dip switch #1 On -- UP Position)

The B input relay may also be activated by the video trigger. This is a composite video (RCA jack) which allows the ASAP2 to stay locked on to the local TV even when the audio signal is muted for an extended period of time. Run a single RCA patch cord from the video output source on the receiver or TV to the video trigger input on the ASAP2. An additional looping jack output is provided to pass through on to the TV video input. Set the trigger by selecting DIP switch 1 to ON position. Set Audio trigger to 1/2 rotation.

Note: the video jack is for triggering purposes only; video signal switching is not possible.

External Voltage Trigger (Dip switch #2 On -- UP Position)

The B input relay may also be activated by a low voltage control source. This is by connecting a 5 to 24 Volts AC or DC power source to the screw terminal block on rear panel. This allows the ASAP2 to stay locked on the local source any time power is applied.

Typical applications would be:

- Control from switched outlet through a wall wart.
- DC Voltage output of preamp or control device.
- Relay drive output from out Navigator Master Keypad.
- Individual zone control such as Sonance Nav Net controller.

Caution: NEVER Connect to 120VAC line current.

AC Power Trigger (Dip switch #3 On -- UP Position)

The B input relay may also be activated by the AC power trigger. This is controlled by an AC outlet on rear panel which allows the ASAP2 to stay locked on to the local TV even when the audio signal is muted for an extended period of time. Plug your TV into this outlet, set trigger select DIP switch 2 to On position.

No Automatic Trigger (Dip switch #4 On -- UP Position)

This allows the ASAP2 to stay locked on to the local source bypassing all automatic functions. This application would be used when ASAP2 is in a switched outlet. When off, there would be direct pass through. When on, local ASAP2 inputs would be active. Pressing front panel power button would allow manual switching from Main to Local sources.

Time Delayed Input Muting (for AC Trigger Mode)

The ASAP2 mutes the input for 3 seconds to prevent thumps and pops created from low quality audio sources. (Typically television audio will produce audible thumps on the line out jacks). This application would be used when ASAP2 is in the AC trigger mode. When off, there would be direct pass through. When TV is powered on, local ASAP2 inputs would be active and wait for 3 seconds for audio to pass. The muting is instant turn off, to catch quick off thump. This feature may be defeated if source equipment does not exhibit turn on /off thumps, or is using modes other than AC triggering.

Audio / Video Trigger Control Adjustment - Input Sensitivity

The ASAP2 can be adjusted for input sensitivity using the recessed screw adjustment labeled "sense" on the front panel. As it is turned clockwise, the sensitivity increases; counterclockwise makes it less sensitive. The unit should be set for the highest level of sensitivity that allows proper continuous operation. Operate the B source at a moderate volume, then mute the signal (if using a CD or tape player, put it in pause). The ASAP2 should switch back to the A source (after the time delay period you set above) and stay there. If the sensitivity is set too high, random switching may occur as the unit sense the residual noise level of the B source. Some experimentation may be necessary, but once it is set properly the ASAP2 will not need re-adjusting unless the components are changed.

AC Trigger Control Adjustment (front panel)

With TV or component on, adjust trigger control by using the recessed screw adjustment labeled "A.C. Trig" to the point of trigger. Then turn 1/8 past that setting. Check operation by switching TV or component on and off. If switching remains on, reduce the trigger setting slightly. Some components have a small change in current draw and may be

more difficult to trigger. In this case audio, video or low voltage may be an alternative option for better triggering stability.

Local to Main Delay Control Time Adjustment (front panel)

The ASAP2 features an adjustable time delay which varies the amount of time it takes for the device to revert to the A input after the B input signal has been discontinued. This delay time is set using the screw adjustment on the ASAP2 front panel labeled "Delay". The range is from 3 seconds (fully counterclockwise) to 90 seconds (fully clockwise). Set it for somewhat longer times if the video trigger is not used, or the local system is used for classical music or other sources containing long, quiet passages. If using audio for triggering, set the timing longer. If triggering other than audio, the delay time can be set to the shortest time setting (counterclockwise).

Local Source Volume Control Adjustment (front panel)

There are screw adjustments on the front panel for left and right volume control (marked "L" & "R") of local or internal power amplifier. Use these controls for the volume:

- If the Local input signal is distorted or increase it if Local source has weak output. Typically TV variable output falls into the category.
- If using a variable preamp/receiver output, leave them in the fully clockwise position.
- If using ASAP2 with passive volume controls, set the passive volume control to maximum. Then adjust ASAP2 volume controls to nominal level without distortion.

AC Fuse

This will blow to protect the unit for possible internal parts failure. Never replace the fuse with any size other than indicated on the rear panel to avoid more serious damage. Substitution of a larger fuse may create serious damage to internal parts and will void your Sonance warranty. **Note: For continued protection against fire, replace fuse with only same type and rating.**

SAT MODULE BAY INSTALLATION

The Sonamp ASAP2 features a Smart Amplifier Technology (SAT) module bay for future upgradability, greatly increasing the flexibility of the amplifier and making it compatible with new protocols. A new module can be easily inserted or swapped with another SAT module. Refer to the following steps and the figure below for SAT Module removal and installation. **Note: Make sure power switch is Off and AC Voltage is disconnected.**

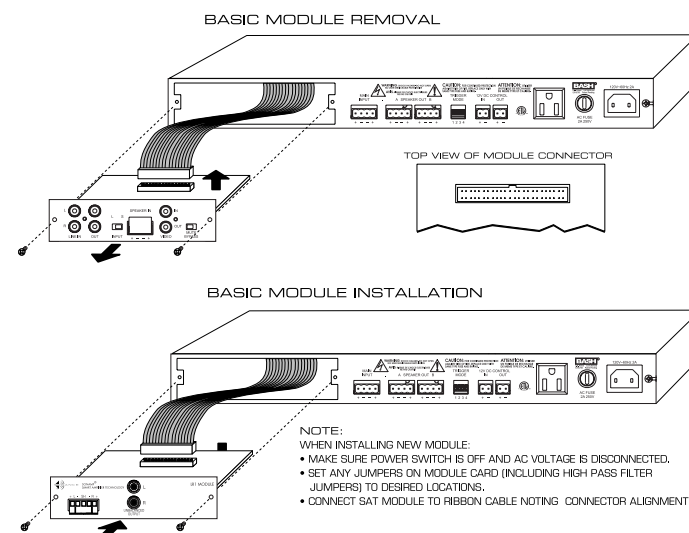

1. Unscrew and save the two screws holding the current module in place.
2. Pull the module out of the SAT module bay.
3. Disconnect the ribbon cable.
4. Select the desired position of any jumpers on the SAT module (i.e. high pass filter).
5. Connect the ribbon cable to the ribbon cable connector on the new module.
6. Slide the SAT module into the SAT module bay.
7. Replace the two mounting screws.

The following diagrams explain how each SAT module can be used with the ASAP2. SAT modules such as the LR1, AL1, and ASL1(all sold separately) are available. Contact your Sonance-Authorized installer or dealer for more information.

LR1 Module (sold separately):

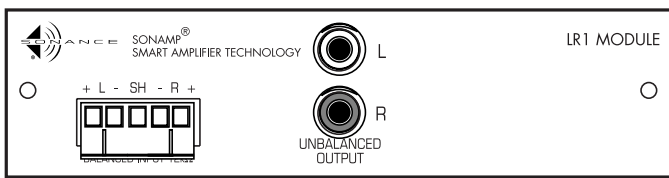

The LR1 – Balanced Line Receiver Module (sold separately) features a circuit that cancels out noise on long audio runs, usually greater than thirty feet. This module has an input impedance of 10KΩ and is perfectly matched with the Sonance LS1 Balanced Line Sender. The LR1 Module provides unbalanced stereo output jacks to feed the signal to other amplifiers. The output is set at unity gain. The following diagram shows a clean-looking Plasma TV/ In-Wall Speaker installation by using the Sonamp ASAP2 with the LR1 module at the equipment rack, with the plasma AC triggered by the ASAP2. Simply swap out the SAT module with the LR1 module, and connect the equipment as shown in Figure below.

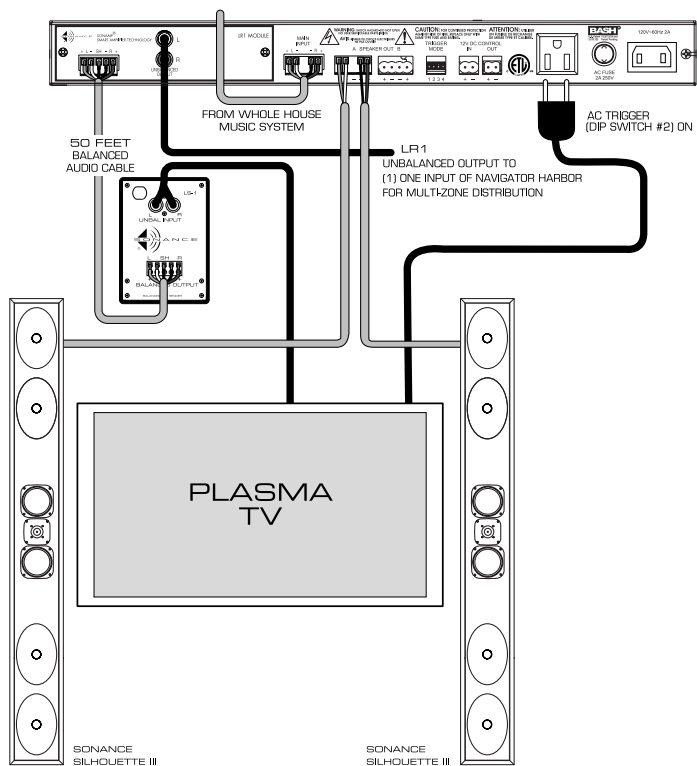

AL1 Module (sold separately):

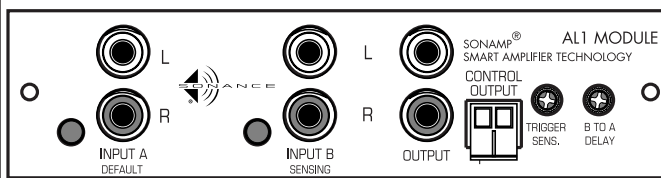

The AL1 – Automatic Line Level Switcher Module (sold separately) has a default input as well as a sensing input. When signal is detected at the sensing input, that signal is fed to the amplifier as well as the output jacks. At the same time a 12VDC control signal is present on the removable screw connector.

The sensing input has a sensitivity control as well as a delay adjustment which controls the time the module waits after the sensing jack signal subsides before switching back to the default input. The following diagram shows a ASAP2 amplifier with the AL1 module in a restaurant installation. The default input is connected to the house restaurant audio and the sensing input monitors to the paging microphone. The output is feeding a second ASAP2 for two source & whole house switching. Simply swap out the Basic SAT module with the AL1 module, and connect the equipment as shown in the figure below.

MAINTAINING YOUR SONAMP ASAP2

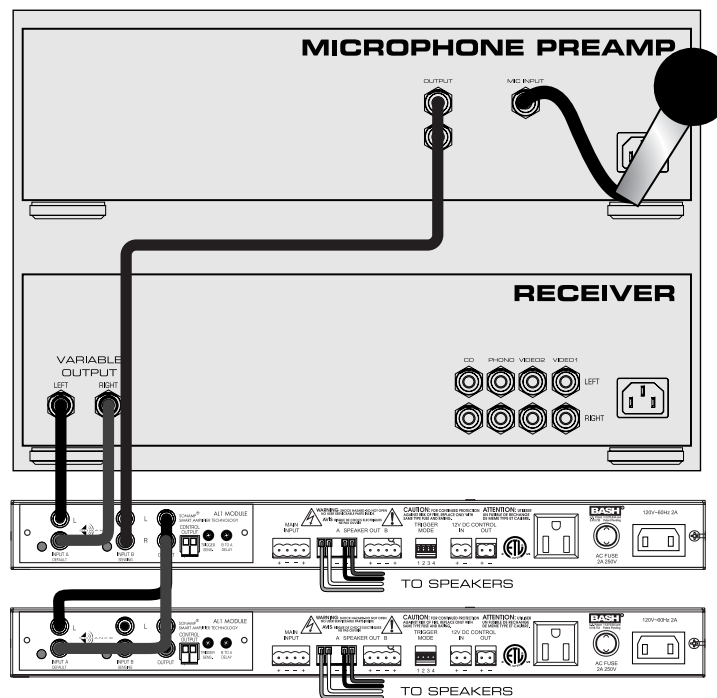

The Sonamp ASAP2 requires no periodic maintenance and has no user serviceable parts inside. Do not remove the top cover to avoid risk of electric shock. To keep it clean use only a soft cloth and never use any solvents or abrasives. Fingerprints may be removed with a soft cloth moistened only with a few drops of water.

SERVICE

If you have any questions about the operation or installation of your Sonamp® ASAP2, please call our Technical Assistance Department on any business day at: (800)582-0772 or (949)492-7777 from 7 a.m. to 5 p.m. PST.

Should your product require repair or service, contact your authorized Sonance retailer for help, or use the following procedure:

1. Prior to calling, note the product model number, serial number, purchase date, and original retailer's name and address.
2. Contact our Technical Assistant Department at the number(s) above and describe the problem. If required a Return Merchandise Authorization (RMA) number will be issued. **IMPORTANT: Do not return the unit to Sonance without first obtaining an RMA number or it will be returned to you.**
3. If you are directed to return the unit to Sonance for repair, pack the unit in its original shipping cartons (inner & outer). Replacement packaging can be obtained from Sonance for a small charge.
4. Contact United Parcel Service, Federal Express, or RPS to arrange prepaid (not collect) shipping. Do not use the United States Postal Service. **IMPORTANT: Freight collect shipments will be refused.**
5. Write the Return Merchandise Authorization number on the outside of the shipping carton.
6. For warranty work, please include a copy of the original bill of sale inside the package.

Ship the packaged unit to:

Technical Assistance Department
Sonance
212 Avenida Fabricante
San Clemente, CA 92672-7531

WARRANTY COVERAGE (USA ONLY)

If, within five (5) years from the date shown on the bill of sale, the unit fails due to a defect in workmanship or materials, Sonance will, at its option and at no charge to the purchaser, repair or replace the components of such unit which proves to be defective.

For this warranty to be effective, the bill of sale must show that the unit was purchased from an authorized Sonance retailer. This warranty shall apply exclusively to the original purchaser and shall not apply to units purchased for industrial or commercial use.

Furthermore, this warranty shall not apply if:

1. Damage to the unit was caused by accident, abuse or misuse.
2. The unit was modified, or repaired by unauthorized personnel.
3. The unit was not used as outlined in the operating instructions.

Exclusions and Limitations

The warranty set forth above is in lieu of all other warranties; express or implied, of merchantability, fitness for a particular purpose, or otherwise. The warranty is limited to Sonance products registered herein and specifically excludes any damage to any associated equipment, which may result for any reason from use with this product.

Sonance shall, in no event, be liable to incidental or consequential damages arising from any breach of this warranty or otherwise. This warranty gives you specific legal rights, and you may have other rights, which vary from state to state.

SPECIFICATIONS

Output Power, Stereo mode, RMS:	50 Watts per channel @ 8Ω 65 Watts per channel @ 4Ω
Total Harmonic Distortion:	0.2% 20Hz-20kHz @ 8Ω 1.0% 20Hz-20kHz @ 4Ω
B to A Delay:	3 seconds to 90 seconds (adjustable)
BTU/HR:	785
Protection Circuits:	AC fuse, thermal, short circuit
Signal to Noise Ratio:	-100dB below rated output (A-weighted)
Input Sensitivity:	300MV for 59W @ 8Ω
Input Impedance:	47k Ω, Min.
Power Requirement:	120 VAC, 50/60 Hz
Power Consumption:	360 watts
Dimensions (WxHxD):	13 1/2" x 1 3/4" x 4 3/4" (343mm x 45mm x 121mm)

Specifications and features subject to change without notice.