



*Featuring NITRO™...  
the Dawn of a New Age  
in Robotic Pool Cleaning!*

**SMARTPOOL**  
**2008**  
**CATALOG**

**NEW** FOR

**2008**



**NITRO**





**ROBOTIC POOL CLEANER**

**NITRO™ Robotic Pool Cleaner for Inground Pools**

**#NC31**

**What Makes NITRO Better Than Any Other Robotic Cleaner?**

**NEW TECHNOLOGY**

*NITRO has so many technological advancements that more patents have been written for it than on ALL robotic pool cleaners combined over the last 20 years! Cleans any type of pool - vinyl liner, concrete, fiberglass!*

**TWICE THE FILTER AREA**

*NITRO's extra-large filter bag offers more than double the capacity of any other pool cleaner in the world.*

**CLEANS WHERE THE DIRT IS**

*The patented location of NITRO's intake ports gets into corners, ridges and angles to clean the entire floor - where the dirt is!*

**LIGHTWEIGHT & EASY TO LIFT**

*With its "Rapid Drain System", debris remains trapped in the filter while clean water quickly flows back into the pool, immediately lightening the cleaner for easy removal.*

**ANTI-TWIST CABLE**

*Another outstanding feature is NITRO's power cable with Super-Cord™ technology. Unlike other robotic pool cleaners, the cable is both twist-resistant and delamination-proof, using a patented design.*

**SIMPLE TO SERVICE AND REPAIR**

*NITRO's modular construction allows for easy servicing. The only tool required is a screwdriver. Parts are readily available and can be sold at the retail level.*

**GREAT FOR ALL POOL SURFACES**

*NITRO is gentle enough for vinyl liner pools, but rugged enough to clean the dirtiest of concrete and fiberglass pools as well!*

- Recommended for Pools up to 20' x 40'
- Scrubs and Vacuums Entire Pool Floor from Wall to Wall
- Built-in Pool Pump and Filter - No Wear and Tear on Pool's Pump and Filter
- Microfilters Water - Like Adding Another Filter to Pool
- Saves up to 50% on Electricity and Backwashing Costs
- Saves up to 30% on Chemical Costs
- No Installation Required
- Includes Convenient Carry Caddy
- Machine-Washable Filter Bag
- Automatic Shutoff
- 50 ft. Cable
- ETL-Listed to UL Standard
- Manufactured in an ISO 9000 Facility
- One year Full/Two Year Limited Warranty

# NITRO

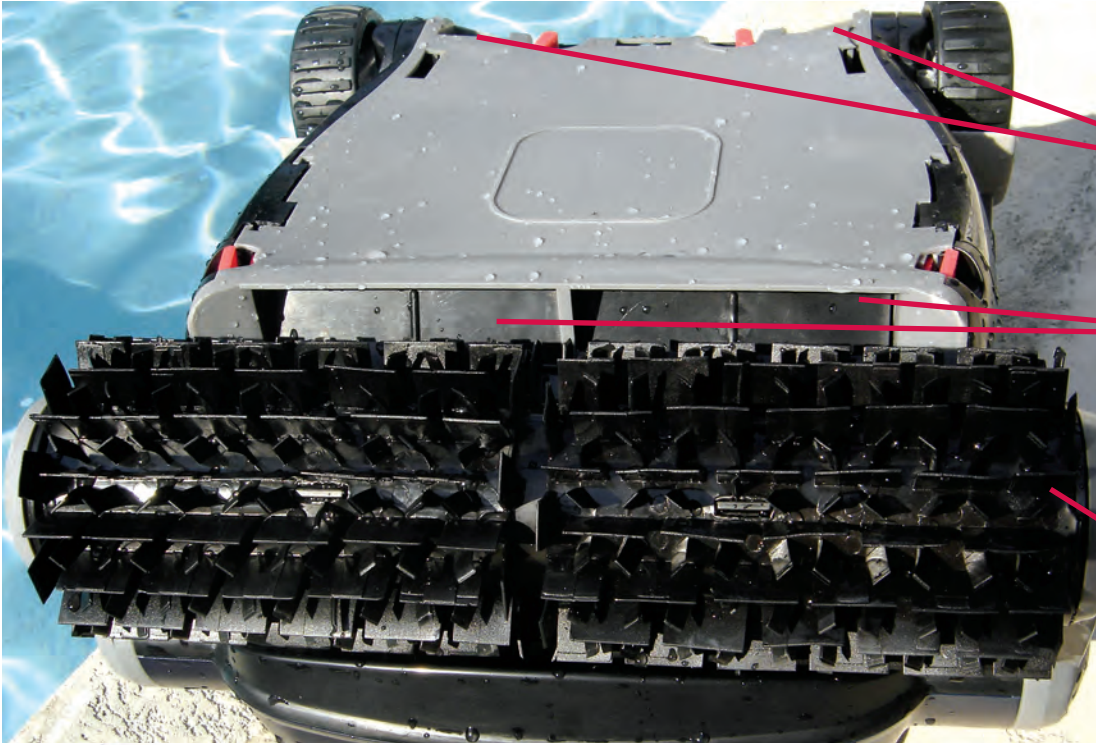

Two of the intake ports are placed near the outer corners of the cleaner, making the robot's cleaning path the largest in the industry.

Two of the NITRO's extra-large intake ports are placed directly behind the cleaning brush, which sweeps the debris right into them.

Motor contained in brush housing, freeing up interior space for extra-large filter capacity.

**CADDY INCLUDED!**



Another of NITRO's many innovations is its "NITRO rapid-drain system". When removing the cleaner from the pool, the debris remains trapped in the filter while clean water quickly flows back into the pool, immediately lightening the cleaner for easy removal.

# NITRO

## YOUR NITRO PARTS CENTER!



FC1002 Sensor Wheel



FC1003 Impeller Cover



FC1006 Drive Motor Assembly

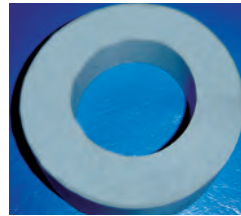

FC1014 Foam Ring



FC1015 Impeller



FC1007 Drive Wheel Tube



FC1011 Chassis Bumper



FC1005 Quick Drain Flap



FC1010 Drive Tube Mount



FC1008 Handle



FC1019 Rear Intake



FC1012 Anti-Twist Floating Cord



FC1009 Pump Motor



FC1001 Chassis



FC1004 Drive Brush



FC1013 Power Supply

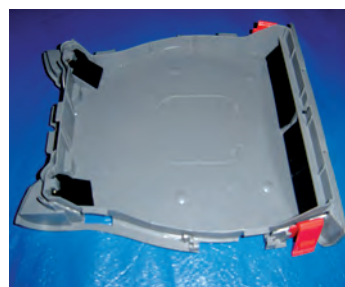

FC1016 Bottom Lid



FC1017 Filter Bag



FC1018 Front Intake

- ✓ **Cleans**
- ✓ **Vacuums**
- ✓ **Filters**

**FOR  
ABOVEGROUND  
POOLS**



# ROBO-KLEEN™

## ROBOTIC POOL CLEANER

**R**obo-Kleen's advanced microprocessor and powerful motors combine to thoroughly clean your pool's floor of leaves, acorns, dirt and debris.

Robo-Kleen™ outperforms water-powered cleaners - it features a built-in pump and filter system, which eliminates the additional wear and tear on your pool pump caused by water-powered cleaners. In fact, Robo-Kleen™ costs just pennies to operate, saving you up to 50% on your electrical and backwashing costs compared to water-powered cleaners.

<b>Robo-Kleen™ Outperforms Water-Powered Cleaners</b>	<b>Robo-Kleen™</b>	<b>Water-Powered Cleaners</b>
<i>Hose assembly Required?</i>	No	Yes
<i>Computerized Cleaning Coverage?</i>	Yes	No
<i>Independent Pump and Filter System?</i>	Yes	No
<i>Extends Life of Pool Filter and Pump?</i>	Yes	Reduces Life of both
<i>Drastically Reduces Electricity Use?</i>	Yes	Increases Electricity Use
<i>Drastically Reduces Backwashing?</i>	Yes	Increases Backwashing

# ROBO-KLEEN™

## ROBOTIC POOL CLEANER

Robo-Kleen™ Robotic Pool Cleaner for Aboveground Pools

#RK01A

### What Makes Robo-Kleen Better

- *The Most Affordable Robotic Aboveground Pool Cleaner Available.*
- *Separate Drive And Pump Motors For Efficient Operation And Maneuverability*
- *The Drive Motor Is Direct-Drive, Eliminating The Need For Belts, Which Can Stretch And Break.*

- for Aboveground Pools up to 31' Round or 41' x 21' Oval
- Thoroughly Vacuums Pool Floor
- Operates Independently of Pool Pump and Filter
- Microfilters Water - Like Adding Another Filter to Pool
- Saves up to 50% on Electricity and Backwashing Costs

- Saves up to 30% on Chemical Costs
- No Installation Required
- Uses Low Voltage Pump Motor - Costs Pennies to Operate
- Machine Washable Filter Bag
- Manufactured in an ISO 9000 Facility

- Automatic Shut-Off After 2 Hours
- Self-Contained, Reusable Filter Bag - Filters Most Algae and Bacteria
- One Year Full Warranty
- Certified to CE Standards
- 40' Cable
- Transformer, 27.5 V, 160 Watts in Weatherproof Casing

UNIT WEIGHT: 18 lbs Without Transformer

CARTON WEIGHT: 31

CARTON SIZE: 22" x 20" x 15" (UPS-able)

UNITS/PALLET: 24



### Robo-Kleen™ & Robo-Kleen Plus Filter Bag #RKF99

Robo-Kleen™ filter bags trap all the dirt and microfilter the pool water - It's like adding another filter to a pool.



**PERFECT  
ALTERNATIVE TO  
DOLPHIN\* HD!**

# PRO-KLEEN™

## ROBOTIC POOL CLEANER

### KADET

**ProKleen Kadet #P100**

- for Commercial Pools up to 25' x 60'
- Thoroughly Vacuums Pool Floor
- Operates Independently of Pool Pump and Filter
- Microfilters Water - Like Adding Another Filter to Pool
- Saves up to 50% on Electricity and Backwashing Costs

- Saves up to 30% on Chemical Costs
- No Installation Required
- Uses Low Voltage Pump Motor - Costs Pennies to Operate
- Machine Washable Filter Bag
- 3-Hour Auto Shutoff

- One-Year Full Warranty
  - ETL-Listed to UL Standards
  - 80' Cable
  - Transformer, 24 V, 160 Watts in Weatherproof Casing
- UNIT WEIGHT: 18.5 lbs  
 CARTON WEIGHT: 34 lbs  
 CARTON SIZE: 20" X 18" X 21"  
 UNITS/PALLET: 24

**NEW!  
COMMERCIAL  
POOL CLEANER**



**CADDY  
INCLUDED!**



**NEW!**  
**AQUAPILL™ #AP61 CLARIFIER**  
**FOR COMMERCIAL POOLS**  
**TREATS UP TO 85,000 GALLONS!**

\*Dolphin™ is a registered trademark of Maytronics, Ltd.



# PRO-KLEEN™

## ROBOTIC POOL CLEANER

PERFECT  
ALTERNATIVE TO  
DOLPHIN® DYNAMIC  
PRO X

# PRO

**ProKleen Pro #P200**

- for Commercial Pools up to 100' in Length
- Thoroughly Vacuums Pool Floor
- Operates Independently of Pool Pump and Filter
- Microfilters Water - Like Adding Another Filter to Pool
- Saves up to 50% on Electricity and Backwashing Costs

- Saves up to 30% on Chemical Costs
- No Installation Required
- Uses Low Voltage Pump Motor - Costs Pennies to Operate
- Machine Washable Filter Bag
- Programmable Cleaning Cycle

- Warranty - One-Year/1500 Hours
  - ETL-Listed to UL Standards
  - 100' Cable
  - Transformer, 24 V, 160 Watts in Weatherproof Casing
- UNIT WEIGHT: 19.5 lbs  
 CARTON WEIGHT: 72 lbs  
 CARTON SIZE: 36" X 21" X 22"  
 UNITS/PALLET: 6

**NEW!**  
COMMERCIAL  
POOL CLEANER

REMOTE  
MODEL!

**CADDY  
INCLUDED!**



**NEW!**  
AQUAPILL™ #AP61 CLARIFIER  
FOR COMMERCIAL POOLS  
TREATS UP TO 85,000 GALLONS!



\*Dolphin™ is a registered trademark of Maytronics, Ltd.

**COMPLETELY  
NEW FOR 2008!**

# PROKLEEN™

## ROBOTIC POOL CLEANER

### PLUS

**ProKleen Plus #P300**

- for Commercial Pools up to 100' in Length
- Thoroughly Vacuums Pool Floor
- Features 2 Vacuum Pump Motors for Twice the Suction Power
- Microfilters Water - Like Adding Another Filter to Pool
- Saves up to 50% on Electricity and Backwashing Costs
- Saves up to 30% on Chemical Costs
- No Installation Required
- Uses Low Voltage Pump Motors - Costs Pennies to Operate
- Machine Washable Filter Bag
- Programmable Cleaning Cycle

- Warranty - One-Year/1500 Hours
  - ETL-Listed to UL Standards
  - 120' Cable
  - Transformer, 25 V, 375 Watts in Weatherproof Casing
- UNIT WEIGHT: 30 lbs  
 CARTON WEIGHT: 94.5 lbs  
 CARTON SIZE: 36" X 21" X 22"  
 UNITS/PALLET: 6

**NEW!  
COMMERCIAL  
POOL CLEANER**

**REMOTE  
MODEL!**



**CADDY  
INCLUDED!**



**NEW!**  
**AQUAPILL™ #AP61 CLARIFIER**  
 FOR COMMERCIAL POOLS  
 TREATS UP TO 85,000 GALLONS!

# PROKLEEN™

## ROBOTIC POOL CLEANER

PERFECT  
ALTERNATIVE TO  
DOLPHIN 2 X 2

**4 X 4**

**ProKleen 4 x 4** **#P400**

- for Commercial Pools up to 200' in Length
- Thoroughly Vacuums Pool Floor
- Operates Independently of Pool Pump and Filter
- Microfilters Water - Like Adding Another Filter to Pool
- Saves up to 50% on Electricity and Backwashing Costs

- Saves up to 30% on Chemical Costs
- No Installation Required
- Uses Low Voltage Pump Motor - Costs Pennies to Operate
- Machine Washable Filter Bag
- Programmable Cleaning Cycle

- Warranty - One-Year/1500 Hours
  - ETL-Listed to UL Standards
  - 150' Cable
  - Transformer, 25 V, 375 Watts in Weatherproof Casing
- UNIT WEIGHT: 40 lbs  
 CARTON WEIGHT: 98 lbs  
 CARTON SIZE: 36" X 21" X 22"  
 UNITS/PALLET: 6

**REMOTE  
MODEL!**

**NEW!**  
COMMERCIAL  
POOL CLEANER

**CADDY  
INCLUDED!**



**NEW!**  
AQUAPILL™ #AP61 CLARIFIER  
FOR COMMERCIAL POOLS  
TREATS UP TO 85,000 GALLONS!



\*Dolphin™ is a registered trademark of Maytronics, Ltd.

## Commercial Pool Cleaners - Line of products

	KADET	PRO	PLUS	4 X 4
ProKleen Cleaners for Commercial and Public Pools				
Cleans Pools up to:	25' x 60'	100' in Length	100' in Length	200' in Length
Cord Length:	80'	100'	120'	150'
Pump Motors	1	1	2	2
Gallons Per Hour	4,500*	4,500*	9,000*	10,000*
Cleaning Cycle:	3 Hours	Programmable	Programmable	Programmable
Remote Included:	No	Yes	Yes	Yes
Caddy Included:	Yes	Yes	Yes	Yes
Warranty:	1 Year Full	1 Year Full / 1500 cycles	1 Year Full / 1500 cycles	1 Year Full / 1500 cycles

\* Gallons Per Hour are Approximate



**Universal Carry Caddy**

**#UC59**

- For all Models of Robo-Kleen™, Robo-Kleen Plus, PoolHog™, and Most Other Robotic Pool Cleaners
- Stores Unit, Cord and Power Supply Conveniently, Neatly, and Safely
- Allows for Easy Transportation of Unit To and From Pool
- Heavy-Duty Construction
- Easy to Assemble

UNIT WEIGHT: 8.4 lbs  
 CARTON SIZE: 22.5" X 17" X 4.75" (UPS-able)  
 UNITS/PALLET: 64



Note: actual unit colors may vary.



### Smart-Ring™ Drain Ramp for Automatic Pool Cleaners\*

#DC11

- Prevents Automatic Pool Cleaners from Getting Stuck on an Anti-Vortex Main Drain.

- Works with MOST Automatic Pool Cleaners



**Won't Get Caught!**

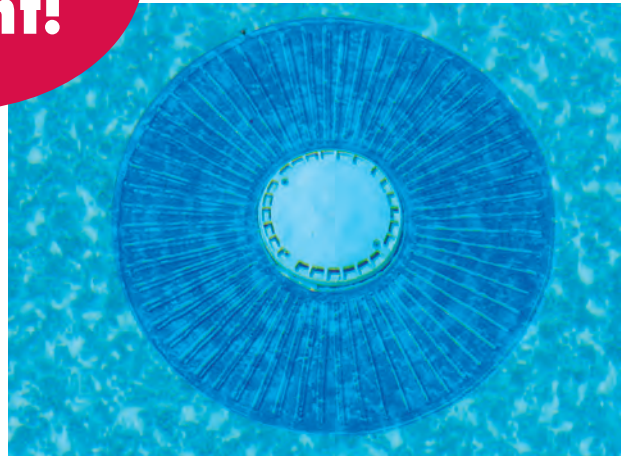

\*Patent Pending

# aquapill™

SALTWATER  
COMPATIBLE!

**C**URE **P**REVENT **R**ETAIN  
**POOL CARE MADE EASY!**

**No Measuring!**  
**No Storing!**  
**No Waste!**

**DYNAMIC  
 THREE-SIDED  
 FLOOR DISPLAY  
 for AQUAPILL  
 C.P.R. EASY  
 POOL CARE**

- **CURE**
- **PREVENT**
- **RETAIN**

**Available FREE to  
 Qualified Dealers!**

*AquaPill is Easy to use...  
 Simply Drop it in your Pool's Skimmer,  
 and its Patented Time-Release  
 Dispensing System will do the Rest!*



**SALTWATER COMPATIBLE!**

# aquapill™

**No Measuring! No Storing! No Waste!**

**RED FOR CURE**

## aquapill™

**CURE PREVENT RETAIN**  
POOL CARE MADE EASY!

**NO MEASURING! NO STORING! NO WASTE!**



1. Pierce Dots
2. With Filter Running, Place Pill in Skimmer

**SALTWATER COMPATIBLE!**

**RED FOR CURE**

**aquapill 1**  
Eliminates Cloudy Water and Improves Filter Efficiency  
Éclaircit l'eau trouble et améliore l'efficacité du filtre  
**CLARIFIER (Floculant) • CLARIFICATEUR (Floculant)**

**aquapill 1**  
Clarificateur (Floculant)

**PILL NO. 1 CLARIFIER (FLOCULANT)**

**Eliminates Cloudy Water & Improves Filter Efficiency**

**aquapill 4**  
Removes Stains Caused by Copper, Iron & Manganese  
Enlève les taches causées par le cuivre, le fer et le manganèse  
**STAIN REMOVER • DÉTACHANT**

**aquapill 4**  
Détachant

**PILL NO. 4 STAIN REMOVER**

**Removes Stains Caused by Copper, Iron & Manganese**

**aquapill 7**  
Effectively Cleans All Types of Filters  
Nettoie efficacement tous les types de filtres  
**FILTER CLEANER & DEGREASER • AGENT NETTOYANT ET DÉGRASSANT**

**aquapill 7**  
Agent nettoyant et dégrasant

**PILL NO. 7 FILTER CLEANER & DEGREASER**

**Effectively Cleans All Types of Filters**

**aquapill 11**  
Eliminates Chemical Odors and Scum Lines  
Supprime les odeurs de produits chimiques et l'écume  
**ODOR ELIMINATOR • ÉLIMINATEUR D'ODEURS**

**aquapill 11**  
Éliminateur d'odeurs

**PILL NO. 11 ODOR ELIMINATOR**

**Eliminates Pool Odors & Scum Lines**

**Aquapill™ is Easy to Use! Simply Drop it in your Pool's Skimmer, and its Patented Time-Release Delivery System will do the Rest! One Pill Lasts up to 2 Weeks and Treats up to 20,000 Gallons!**

**aquapill 1**  
Eliminates Cloudy Water and Improves Filter Efficiency  
Éclaircit l'eau trouble et améliore l'efficacité du filtre  
**CLARIFIER (Floculant) • CLARIFICATEUR (Floculant)**

**aquapill 1**  
Clarificateur (Floculant)

**KEEP OUT OF REACH OF CHILDREN**  
Store in a safe, cool, dry place.

**DANGER: HORS DE PORTÉE DES ENFANTS**  
Mettre dans un endroit sûr, frais, sec.

**Net content: 5.25 oz (148 g)**  
Dosage: 1 pill per 10,000 gallons (37,854 l) of water

**Contents net: 999 oz (28,214 g)**  
Dosage: 1 pill per 10,000 gallons (37,854 l) of water

**aquapill 4**  
Removes Stains Caused by Copper, Iron & Manganese  
Enlève les taches causées par le cuivre, le fer et le manganèse  
**STAIN REMOVER • DÉTACHANT**

**aquapill 4**  
Détachant

**KEEP OUT OF REACH OF CHILDREN**  
Store in a safe, cool, dry place.

**DANGER: HORS DE PORTÉE DES ENFANTS**  
Mettre dans un endroit sûr, frais, sec.

**Net content: 5.25 oz (148 g)**  
Dosage: 1 pill per 10,000 gallons (37,854 l) of water

**Contents net: 999 oz (28,214 g)**  
Dosage: 1 pill per 10,000 gallons (37,854 l) of water

**aquapill 7**  
Effectively Cleans All Types of Filters  
Nettoie efficacement tous les types de filtres  
**FILTER CLEANER & DEGREASER • AGENT NETTOYANT ET DÉGRASSANT**

**aquapill 7**  
Agent nettoyant et dégrasant

**KEEP OUT OF REACH OF CHILDREN**  
Store in a safe, cool, dry place.

**DANGER: HORS DE PORTÉE DES ENFANTS**  
Mettre dans un endroit sûr, frais, sec.

**Net content: 9 FL oz (266 g)**  
Dosage: 1 pill per 20,000 gal (75,708 l) of water

**Contents net: 999 oz (28,214 g)**  
Dosage: 1 pill per 20,000 gal (75,708 l) of water

**aquapill 11**  
Eliminates Chemical Odors and Scum Lines  
Supprime les odeurs de produits chimiques et l'écume  
**ODOR ELIMINATOR • ÉLIMINATEUR D'ODEURS**

**aquapill 11**  
Éliminateur d'odeurs

**KEEP OUT OF REACH OF CHILDREN**  
Store in a safe, cool, dry place.

**DANGER: HORS DE PORTÉE DES ENFANTS**  
Mettre dans un endroit sûr, frais, sec.

**Net content: 5 FL oz (148 g)**  
Dosage: 1 pill per 20,000 gal (75,708 l) of water

**Contents net: 999 oz (28,214 g)**  
Dosage: 1 pill per 20,000 gal (75,708 l) of water

**1 CLARIFIER (FLOCULANT)**

**Eliminates Cloudy Water & Improves Filter Efficiency**

**4 STAIN REMOVER**

**Removes Stains Caused by Copper, Iron and Manganese**

**7 FILTER CLEANER & DEGREASER**

**Effectively Cleans all Types of Filters**

**11 ODOR ELIMINATOR**

**Eliminates Pool Odors and Scum Lines**



# aquapill™

**SALTWATER COMPATIBLE!**

**No Measuring! No Storing! No Waste!**

**GREEN FOR PREVENT**

## aquapill™

**CURE PREVENT RETAIN**  
POOL CARE MADE EASY!

**NO MEASURING! NO STORING! NO WASTE!**



1. Pierce Dots
2. With Filter Running, Place Pill in Skimmer

**SALTWATER COMPATIBLE!**

**GREEN FOR PREVENT**

**aquapill 3**  
Prevents Scale Formation • Empêche la formation de tartre  
SCALE INHIBITOR • ANTI-TARTRE

**PILL NO. 3 SCALE INHIBITOR**  
Prevents Scale Formation

**aquapill 5**  
Inhibits the Growth of All Types of Algae  
NON-FOAMING ALGAECIDE

**PILL NO. 5 NON-FOAMING ALGAECIDE**  
Inhibits the Growth of all Types of Algae

**aquapill 6**  
Helps Prevent Stains Caused by Copper, Iron and Manganese  
Permet d'éviter l'apparition des taches de cuivre, de fer et de manganèse  
STAIN PREVENTOR • ANTI-TACHE

**PILL NO. 6 STAIN PREVENTOR**  
Inhibits Copper, Iron and Manganese Stains

**aquapill 9**  
Inhibits Scale Build-up on Salt Cells  
Empêche la formation de tartre sur les cellules de sel  
SALT CELL GUARD • PROTECTION POUR CELLULE DE SEL

**PILL NO. 9 SALT CELL GUARD**  
Inhibits Scale Build-up on Salt Cells

**AquaPill™ is Easy to Use! Simply Drop it in your Pool's Skimmer, and its Patented Time-Release Delivery System will do the Rest! One Pill Lasts up to 2 Weeks and Treats up to 20,000 Gallons!**

**aquapill 3**  
Prevents Scale Formation • Empêche la formation de tartre  
SCALE INHIBITOR • ANTI-TARTRE

**PILL NO. 3 SCALE INHIBITOR**  
Prevents Scale Formation

**aquapill 5**  
Inhibits the Growth of All Types of Algae  
NON-FOAMING ALGAECIDE

**PILL NO. 5 NON-FOAMING ALGAECIDE**  
Inhibits the Growth of all Types of Algae

**aquapill 6**  
Helps Prevent Stains Caused by Copper, Iron and Manganese  
Permet d'éviter l'apparition des taches de cuivre, de fer et de manganèse  
STAIN PREVENTOR • ANTI-TACHE

**PILL NO. 6 STAIN PREVENTOR**  
Inhibits Copper, Iron and Manganese Stains

**aquapill 9**  
Inhibits Scale Build-up on Salt Cells  
Empêche la formation de tartre sur les cellules de sel  
SALT CELL GUARD • PROTECTION POUR CELLULE DE SEL

**PILL NO. 9 SALT CELL GUARD**  
Inhibits Scale Build-Up on Salt Cells

**3 SCALE INHIBITOR**  
Prevents Scale Formation

**5 NON-FOAMING ALGAECIDE**  
Inhibits the Growth of all Types of Algae

**6 STAIN PREVENTOR**  
Inhibits Copper, Iron and Manganese Stains

**9 SALT CELL GUARD**  
Inhibits Scale Build-Up on Salt Cells

**SALTWATER COMPATIBLE!**

# aquapill™

**No Measuring! No Storing! No Waste!**

## YELLOW FOR **RETAIN**

# aquapill™

**CURE PREVENT RETAIN**  
POOL CARE MADE EASY!

**NO MEASURING! NO STORING! NO WASTE!**



1. Pierce Dots
2. With Filter Running, Place Pill in Skimmer

**SALTWATER COMPATIBLE!**

**YELLOW FOR**

# RETAIN

**aquapill 2**  
Restores, Polishes and Maintains Water Clarity  
Élimine, égalse et maintient la clarté de l'eau  
**CLARIFIER PLUS • CLARIFICATEUR PLUS**

**2** **CLARIFIER PLUS**

Improves and Maintains Water Clarity

**aquapill 8**  
Clarifier, Filter Cleaner, Metal Inhibitor, Prevents Scum Lines, Reduces Shocking  
Agent clarifiant, nettoyeur de filtre, inhibiteur de tartre, anti-choc, selon l'ajout des traitements suivants  
**COMPLETE POOL CARE • TRAITEMENT COMPLET POUR PISCINE**

**8** **COMPLETE POOL CARE**

Clarifier; Filter Cleaner; Metal Inhibitor; Prevents Scum Lines; Reduces Shocking

**aquapill 10**  
Cleans and Restores Plumbing to Original Condition  
Nettoie et remet les tuyaux à neuf  
**PIPE CLEAR • NETTOYAGE DES TUYAUX**

**10** **PIPE CLEAR**

Cleans and Restores Plumbing to Original Condition

**aquapill 12**  
Removes and Prevents Phosphates (Removes 1,000 ppb)  
Élimine et prévient les phosphates (élimine 1 000 parties par million)  
**PHOSPHATE 1000**

**12** **PHOSPHATE 1000**

Removes and Prevents Phosphates (Removes 1000 ppb)

**Aquapill™ is Easy to Use! Simply Drop it in your Pool's Skimmer, and its Patented Time-Release Delivery System will do the Rest! One Pill Lasts up to 2 Weeks and Treats up to 20,000 Gallons!**

**aquapill 2**  
Restores, Polishes and Maintains Water Clarity  
Élimine, égalse et maintient la clarté de l'eau  
**CLARIFIER PLUS • CLARIFICATEUR PLUS**

**2** **CLARIFIER PLUS**

Improves and Maintains Water Clarity

**aquapill 8**  
Clarifier, Filter Cleaner, Metal Inhibitor, Prevents Scum Lines, Reduces Shocking  
Agent clarifiant, nettoyeur de filtre, inhibiteur de tartre, anti-choc, selon l'ajout des traitements suivants  
**COMPLETE POOL CARE • TRAITEMENT COMPLET POUR PISCINE**

**8** **COMPLETE POOL CARE**

Clarifier; Filter Cleaner; Metal Inhibitor; Prevents Scum Lines; Reduces Shocking

**aquapill 10**  
Cleans and Restores Plumbing to Original Condition  
Nettoie et remet les tuyaux à neuf  
**PIPE CLEAR • NETTOYAGE DES TUYAUX**

**10** **PIPE CLEAR**

Cleans and Restores Plumbing to its Original Condition

**aquapill 12**  
Removes and Prevents Phosphates (Removes 1,000 ppb)  
Élimine et prévient les phosphates (élimine 1 000 parties par million)  
**PHOSPHATE 1000**

**12** **PHOSPHATE 1000**

Removes and Prevents Phosphates (Removes 1000 ppb)

**2** **CLARIFIER PLUS**

Improves and Maintains Water Clarity

**8** **COMPLETE POOL CARE**

Clarifier, Filter Cleaner, Metal Inhibitor, Prevents Scum Lines, Reduces Shocking

**10** **PIPE CLEAR**

Cleans and Restores Plumbing to its Original Condition

**12** **PHOSPHATE 1000**

Removes and Prevents Phosphates (Removes 1000 ppb)

SALTWATER  
COMPATIBLE!

# SOLARPILL™

## POOL BLANKET IN A PILL

- *Easy To Use - Simply Place In Skimmer; Automatically Dispenses*
- *Reduces Heat & Chemical Loss By Preventing Water Evaporation*
- *Helps Extend Your Swimming Season*
- *Nontoxic - 100% Safe For Your Family & The Environment*



Blue Base  
Turns Counter  
Displays into  
Floor Display



SolarPill Counter or Shelf Display

### AVAILABLE IN 2 SIZES!



AP72 For Pools up to 30,000 Gallons



AP73 For Pools up to 12,000 Gallons

SALTWATER COMPATIBLE!

# WINTERPILL™

## POOL WINTERIZER IN A PILL

### MAINTAINS HEALTHY, CLEAR WATER ALL WINTER LONG!



AP71 WinterPill Treats up to 30,000 Gallons



AP75 WinterPill Treats up to 15,000 Gallons

- *Floats Under All Types Of Winter Covers*
- *Patented 6-Month Delivery System*
- *Safe For Use With All Pool Surfaces & Filters*
- *Performs Well With Mesh Safety Covers*

**NOW 2 SIZES AVAILABLE!**  
**ONE TREATS UP TO 30,000 GALLONS!**  
**AND ONE UP TO 15,000 GALLONS!**

Note: May be used Alone or with Other Winter Kits

WinterPill™ All-in-One Formula is an Exclusive 4-Part Blend to Make Spring Openings Faster and Easier than Ever! It Clarifies the Pool Water and Prevents Scaling and Staining. WinterPill is Enzyme Enhanced. It Naturally Destroys ALL Organics, Preventing Water Ring, Enhancing Filter Performance, and Improving Sanitizer Efficiency



Blue Base Turns Counter Displays into Floor Display

**SALTWATER  
COMPATIBLE!**

# SPRINGPILL™

## POOL START-UP IN A PILL

**CLARIFIES & CLEANS; MAKES POOL OPENINGS EASIER THAN EVER**



AP70 SpringPill Treats up to 30,000 Gallons



AP74 SpringPill Treats up to 15,000 Gallons

- *Easy To Use; Simply Place In Skimmer; Automatically Dispenses*
- *Makes Pool Openings Faster & Easier Than Ever*
- *Saves You Time & Money*
- *Safe For Use With All Pool Surfaces & Filters*

**NOW 2 SIZES  
AVAILABLE!  
ONE TREATS UP TO  
30,000 GALLONS!  
AND ONE UP TO  
15,000 GALLONS!**

Note: May be used Alone  
or with Other Startup Kits



Blue Base Turns Counter  
Displays into Floor Display

SpringPill™ All-in-One Formula is an Exclusive 4-Part Blend to Make Spring Openings Faster and Easier than Ever! It Clarifies the Pool Water and Prevents Scaling and Staining. SpringPill is Enzyme Enhanced. It Naturally Destroys ALL Organics, Preventing Water Ring, Enhancing Filter Performance, and Improving Sanitizer Efficiency

# PHOSPHATE 1500



- *Easy To Use; Simply Place In Skimmer; Automatically Dispenses*
- *Removes Up To 1500 Parts-Per-Billion Of Ortho-phosphates Per 20,000-Gallons Of Water*
- *Eliminates Phosphates From Fertilizers, Rainwater, Soaps, Decaying Vegetation and Other Pollutants*
- *Nontoxic - 100% Safe For Your Family and The Environment*
- *Treats Up To 20,000 Gallons*

AP77 Phosphate 1500 Available in Counter and Floor Displays

# 90-DAY-PLUS ALGAEICIDE



- *Easy To Use; Simply Place In Skimmer; Automatically Dispenses*
- *Use Against Blue-Green, Black and Mustard (Yellow) Algae*
- *A Single Treatment Lasts THREE MONTHS*
- *Non-Staining Formula*
- *Guaranteed Superior Performance*
- *Treats Up To 10,000-Gallons*

AP76 90-Day-Plus Algaecide Available in Counter and Floor Displays

# COMPLETE POOL CARE



- *Easy To Use; Simply Place In Skimmer; Automatically Dispenses*
- *Clarifies Cloudy Water*
- *Eliminates Oil & Scum*
- *Removes Excess Metals*
- *Removes Grime, Oil & Organic Debris From Filters*
- *Treats Up To 50,000 Gallons*

AP78 Complete Pool Care Available in Counter and Floor Displays

# SALT CELL GUARD



- *Easy To Use; Simply Place In Skimmer; Automatically Dispenses*
- *Inhibits Scale Build-Up On Salt Cells*
- *Extends The Life Of Salt Cells*
- *Compatible With All Sanitizing Chemicals*
- *Treats Up To 50,000 Gallons*

AP79 Salt Cell Guard Available in Counter and Floor Displays



**ChlorEase Saltwater Chlorinator for Aboveground Pools**

#CL01

**What Makes ChlorEase Better?**

- *The Most Affordable Aboveground Pool Saltwater Chlorinator Available..*
- *Easy DIY Installation - No Cutting, Draining, Gluing, Etc.*
- *Easy To Clean And Maintain*

- Produces Chlorine Right in the Pool - Automatically and Continuously
- Automates Your Customer's Pool - No Need to Add Chlorine
- Can be Used with all Chemicals used in Chlorine-Maintained Pools
- Cord has Windable Spool for easy Cleaning and Winterization
- Affordably Priced for the Aboveground Pool Owner
- Treats Aboveground Pools up to 18,000 Gallons

- Easily Installs on New and Existing Pools - No Plumbing Required
- Heavy Duty
- High-Efficiency Cell
- Uses any 110V GFI-Protected Outlet
- Swimmers love the soft water feel
- Better for skin, hair and eyes than regular chlorine

- 1-Year Limited Warranty
- ETL Listed to UL 1081

MASTER CARTON WEIGHT: 20.5 lbs (2/Master)  
 UNIT BOX SIZE 22.5" X 4" X 10.75"  
 UNITS/PALLET: 108  
 MINIMUM ORDER: 1 Case (2 Units)



**AquaPill 9 - Salt Cell Guard -  
 A Perfect Choice for all  
 Saltwater Chlorinators!**







**ChlorEase "Ultra" Saltwater Chlorinator for Aboveground Pools #CL02**

**What Makes ChlorEase Better?**

- *The Most Affordable Aboveground Pool Saltwater Chlorinator Available..*
- *Easy DIY Installation - No Cutting, Draining, Gluing, Etc.*
- *Easy To Clean And Maintain*

- Produces Chlorine Right in the Pool - Automatically and Continuously
- Automates Your Customer's Pool - No Need to Add Chlorine
- Can be Used with all Chemicals used in Chlorine-Maintained Pools
- 110v/220v convertible
- Cord has Windable Spool for easy Cleaning and Winterization
- Affordably Priced for the Aboveground Pool Owner
- Treats Aboveground Pools up to 18,000 Gallons
- Easily Installs on New and Existing Pools - No Plumbing Required

- Heavy Duty
- High-Efficiency Cell
- Uses any 110V GFI-Protected Outlet
- Swimmers love the soft water feel
- Better for skin, hair and eyes than regular chlorine
- LED Status Indicator
- Digital Timer
- On/Off Control Switch

- 3-Year Limited Warranty
  - ETL Listed to UL 1081
- 
- MASTER CARTON WEIGHT: 20.5 lbs (2/Master)  
 UNIT BOX SIZE 22.5" X 4" X 10.75"  
 UNITS/PALLET: 108  
 MINIMUM ORDER: 1 Case (2 Units)



**AquaPill 9 - Salt Cell Guard - A Perfect Choice for all Saltwater Chlorinators!**





**ChlorEase Saltwater Chlorinator for Inground Pools**

**#CL03**

**What makes ChlorEase Better**

- *The Most Affordable Inground Pool Saltwater Chlorinator Available..*
- *Built-in 110/220 Volt Convertibility*
- *Self-Cleaning NEW 7-Blade Cell*
- *View Port For Easy Cell Inspection*

• Purifies up to 25,000- Gallons of Water

• **NEW!** 7-Blade Cell for Maximum Chlorine Output

• Self- Cleaning Cell

• Cell View Port for Easy-to-See Cell Inspection

• Weekly Chlorine Production is Equivalent to 8- 8oz Chlorine Tablets of Trichlor

• Easy- to-Install on New or Existing Pools

• 2" Unions for Easy Access to Cell

• Independent Flow Switch to Ensure Proper Water Flow

• Control Dial - 0% - 100% Chlorine Generation

• Self Diagnostic Test (Sdt) Feature

• Operation Indicator Light

• System Check Indicator Light

• Super- Chlorination Button- 100% Chlorine Generation

• ETL-Listed to UL Standards

• 5- Year Limited Cell Warranty (2 Years Full)

• Weather-Proof 6 Volt/6 Amp Transformer Rated for Outdoor Use

**UNIT WEIGHT:**

11 lbs

**UNIT BOX SIZE:**

21.65" x 13" x 4.75"

UNITS/PALLET: 144

MINIMUM ORDER: 1 Unit



# ChlorEase™

Saltwater Chlorinator

## CHLOREASE™ CONTROL UNIT

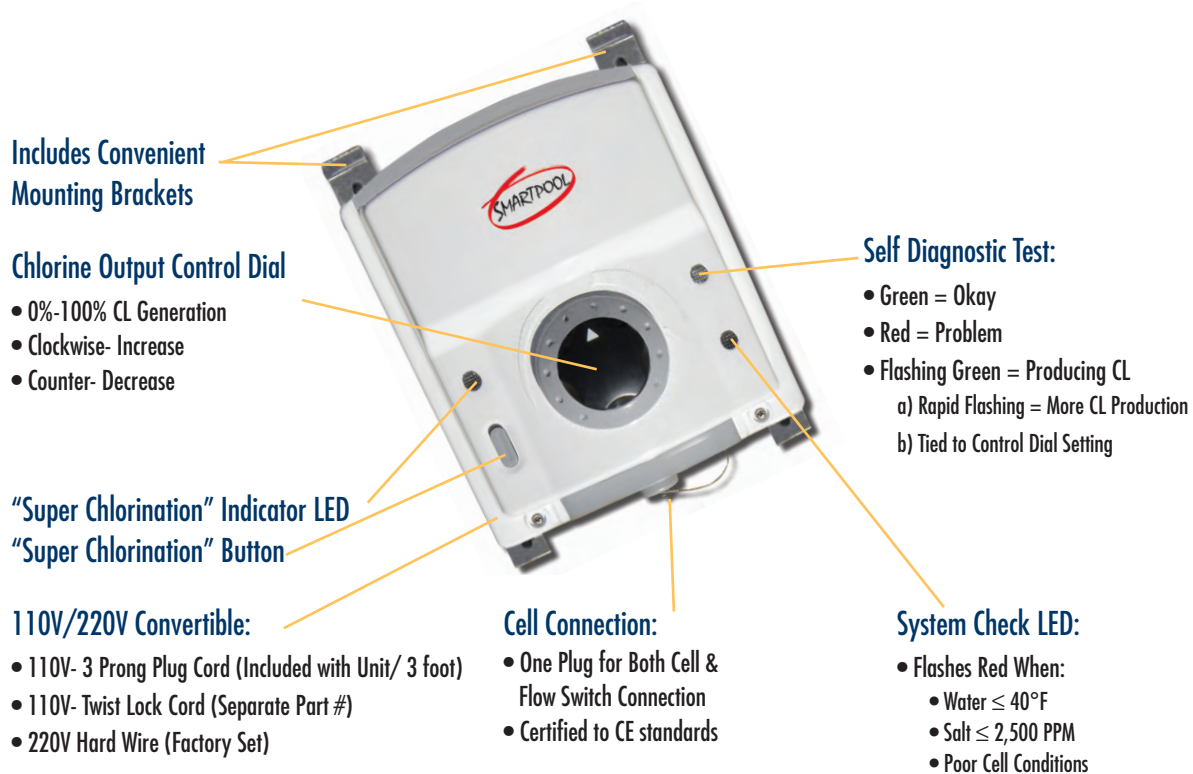

Includes Convenient Mounting Brackets

**Chlorine Output Control Dial**

- 0%-100% CL Generation
- Clockwise- Increase
- Counter- Decrease

"Super Chlorination" Indicator LED  
"Super Chlorination" Button

**110V/220V Convertible:**

- 110V- 3 Prong Plug Cord (Included with Unit/ 3 foot)
- 110V- Twist Lock Cord (Separate Part #)
- 220V Hard Wire (Factory Set)

**Cell Connection:**

- One Plug for Both Cell & Flow Switch Connection
- Certified to CE standards

**Self Diagnostic Test:**

- Green = Okay
- Red = Problem
- Flashing Green = Producing CL
  - a) Rapid Flashing = More CL Production
  - b) Tied to Control Dial Setting

**System Check LED:**

- Flashes Red When:
  - Water  $\leq 40^{\circ}\text{F}$
  - Salt  $\leq 2,500$  PPM
  - Poor Cell Conditions

## CHLOREASE™ CELL UNIT

2" Unions for Easy Access to Cell

1.5" & 2" Plumbing for Easy "DIY" Installations for New or Existing Pools

Durable HDPE Construction

**Cell Facts:**

- Seven-Blade Self-Cleaning Cell
- Maximum CL Output up to 30,000 Gallons
- 5-Year Limited Cell Warranty/2- Years Full



Replaceable Flow Switch

Certified to CE standards

Self-Cleaning Cell

View Port for Cell Inspection



## REPLACEMENT UNITS

ChlorEase Replacement Transformer for Standard CL01 Model	#CL01UPS
ChlorEase Replacement Transformer for Twist-Lock CL01TL Model	#CL01UPSTL
ChlorEase Ultra Replacement Transformer for Standard CL02 Model	#CL02UPS
ChlorEase Ultra Replacement Transformer for Twist-Lock CL02TL Model	#CL02UPSTL
ChlorEase Inground Replacement Transformer for Standard CL03 Model (Control Unit Incl.)	#CL03UPS
ChlorEase Inground Replacement Transformer for Twist-Lock CL03TL Model (Control Unit Incl.)	#CL03UPS
ChlorEase Inground Replacement Flow Switch	#CL03FLO
ChlorEase Replacement Cell (no transformer) for CL01	#CL01X
ChlorEase Replacement Cell (no transformer) for CL02	#CL02X
ChlorEase Replacement Cell (no Control Unit or transformer) for CL03	#CL01X
ChlorEase Inground Replacement Bulkhead	#CL03BLK
ChlorEase Inground Bypass	#CL03BLK
ChlorEase Inground Pipe Fitting - 1.5"	#CL03PF15
ChlorEase Inground Pipe Fitting - 2"	#CL03PF2
ChlorEase Inground O-Ring	#CL03ORING
ChlorEase Inground Control Knob	#CL03CK

# SPAroma™

More than Just a Great Fragrance  
with ENZYME-ENHANCED Spa Care!

## SPAroma™

More than Just a Great Fragrance  
with ENZYME-ENHANCED Spa Care!

An enchanting assortment of spa fragrances with the added benefit of enzyme technology in convenient, easy-to-use time-release capsules. Available in 12 different scents that help to soften skin, but also prevent scum lines, eliminate odors, enhance sanitizer performance, and reduce the need for filter cleaning, all while providing the ultimate aromatherapy experience. SPAroma is available in 3-capsule or single-capsule sample packs.



- SPA01 - Cherry Blossom
- SPA02 - Citrus Blast
- SPA03 - Florida Mango
- SPA04 - Vanilla Crème

- SPA05 - Eucalyptus
- SPA06 - Gardenia
- SPA07 - Lavender
- SPA08 - Pina Colada

- SPA09 - Spring Mist
- SPA10 - Forest Glen
- SPA11 - Pear Delight
- SPA12 - Tropical Paradise

- SPA61 - Fragrance Bouquet 1 (Cherry Blossom • Eucalyptus • Gardenia)
- SPA62 - Fragrance Bouquet 2 (Pear Delight • Spring Mist • Tropical Paradise)
- SPA63 - Fragrance Bouquet 3 (Citrus Blast • Florida Mango • Forest Glen)
- SPA64 - Fragrance Bouquet 4 (Lavender • Pina Colada • Vanilla Crème)

## SPAroma™

More than Just a Great Fragrance  
with ENZYME-ENHANCED Spa Care!

**NEW!**  
**SAMPLE PACKS!**

Easy-To-Choose, Easy-To-Use  
Single SPAroma Capsules!

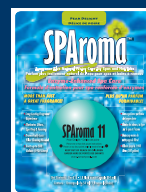
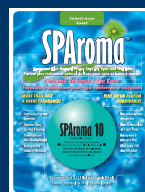
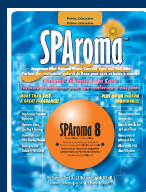
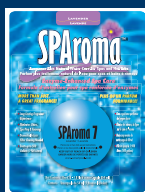

# SUNHEATER™

SOLAR POOL HEATING SYSTEMS

Aboveground Pool 2' x 20' (40 sq. ft.) Solar Heating System

#S220

## What Makes SunHeater Better?

- Over-Molded Fiberglass Crush-Proof Header Pipes
- Direct-Flow System For Efficient Heating And Winterizing
- Tube On Web Design For Better Heating
- 2' Panel Height For Easier Shipping And Stocking

• For Smaller Aboveground Pools or Add-On to S421

• Install on Ground, Roof, or Rack

• Small Box Size Easy to Merchandise and Ship

• Raises Pool Water Temperature 10° F (6° C) or More

• Simple Do-It-Yourself Installation

• Uses Existing Pool Pump

• Tube on Web Design for Maximum Exposure to Sun's Rays

• No Fuel Bills or Expensive Installation of Equipment and Connections

• Drain for Winter as with All Pool Equipment



**NEW!**

**FREE SOLARPILL PACKED INSIDE!**



- 1 - 2' x 20' Polypropylene Solar Collector
- 2 Threaded Elbow Adapters
- 2 End Caps
- Connector Hose For Second Collector
- 2 Stainless Steel Hose Clamps
- 1 Roll of Teflon Tape
- Trilingual Installation/Operation Manual (English/French/Spanish)
- Bilingual 4-Color Box (English/French)

UNIT SIZE: 2' x 20'

CARTON WEIGHT: 21 lbs

CARTON SIZE: 13" x 13" x 27.5" (UPS-able)

UNITS/PALLET: 27

### ORDER GUIDE FOR 40 sq. ft. SYSTEM (A/G POOLS)

Raises Water Temperature 10° F. (6° C.) or More During Swimming Season

Round Pools up to	Quantity	Oval Pools up to	Quantity
12' - 18'	1 Solar Box	12' x 24'	1 Solar Box
21' - 24'	2 Solar Boxes	15' x 30'-16' x 25'	2 Solar Boxes
27' - 28'	3 Solar Boxes	16' x 32'-18' x 34'	3 Solar Boxes

Add A Solar Blanket To Retain The Heat  
For Year-Round Swimming Areas, Add 1 Solar Box

Can be Connected to S421 or S425 System!

- Packed in Half-Size Box**
- Cheaper to Ship!
  - Easy to Stock!



Aboveground Pool 2 X 2' x 20' (80 sq. ft.) Solar Heating System

#S421

**What Makes SunHeater Better?**

• *Over-Molded Fiberglass Crush-Proof Header Pipes* • *Direct-Flow System For Efficient Heating And Winterizing* • *Tube On Web Design For Better Heating* • *2' Panel Height For Easier Shipping And Stocking*

- One Box is Sufficient to Heat Most Aboveground Pools
- Install on Ground, Roof, or Rack
- Small Box Size Easy to Merchandise and Ship
- Raises Pool Water Temperature 10° F (6° C) or More
- Simple Do-It-Yourself Installation

- Uses Existing Pool Pump
- Tube on Web Design for Maximum Exposure to Sun's Rays
- No Fuel Bills or Expensive Installation of Equipment and Connections
- Drain for Winter as with All Pool Equipment

- 2 - 2' x 20' Polypropylene Solar Collectors
- 2 Threaded Elbow Adapters
- 4 End Caps
- 4 Stainless Steel Hose Clamps
- 1 Roll of Teflon Tape
- 1 Rubber Connector Hose
- Trilingual Installation/Operation Manual (English/French/Spanish)
- Bilingual 4-Color Box (English/French)

UNIT SIZE: 2 - 2' x 20'  
 CARTON WEIGHT: 39 lbs  
 CARTON SIZE: 16" x 16" x 27.5" (UPS-able)  
 UNITS/PALLET: 18

**ORDER GUIDE FOR 80 sq. ft. SYSTEM (A/G POOLS)**

Raises Water Temperature 10° F (6° C) or More During Swimming Season

Round Pools up to	Quantity	Oval Pools up to	Quantity
15' - 24'	1 Solar Box	12 x 24' - 16' x 25'	1 Solar Box
27' - 28'	2 Solar Boxes	16' x 32' - 18' x 34'	2 Solar Boxes

Add A Solar Blanket To Retain The Heat  
 For Year-Round Swimming Areas, Add 1 Solar Box

*Can be Connected to S220 System!*

**Packed in Half-Size Box**

- **Cheaper to Ship!**
- **Easy to Stock!**

**NEW!**

**FREE SOLARPILL PACKED INSIDE!**



# SUNHEATER™

SOLAR POOL HEATING SYSTEMS

Inground Pool 2' x 2' x 20' (80 sq. ft.) Solar Heating System

#S601

## What Makes SunHeater Better?

• Over-Molded Fiberglass Crush-Proof Header Pipes • Direct-Flow System For Efficient Heating And Winterizing • Tube On Web Design For Better Heating • 2' Panel Height For Easier Shipping And Stocking

- One Box is Sufficient to Heat Most Aboveground Pools
- Install on Ground, Roof, or Rack
- Smaller Box Size Easy to Merchandise and Ship
- Raises Pool Water Temperature 10° F (6° C) or More
- Simple Do-It-Yourself Installation

- Uses Existing Pool Pump
- Tube on Web Design for Maximum Exposure to Sun's Rays
- No Fuel Bills or Expensive Installation of Equipment and Connections
- Best Selling Solar Collector in the Industry
- Drain for Winter as with All Pool Equipment



Packed in Half-Size Box  
 • Cheaper to Ship!  
 • Easy to Stock!

- 2 - 2' x 20' Polypropylene Solar Collectors
- 10 Stainless Steel Mounting brackets
- 10 - 2" #14 Stainless Steel Screws
- 4 Rubber Connector Hoses
- 8 Stainless Steel Clamps
- Trilingual Installation/Operation Manual (English/French/Spanish)
- Bilingual 4-Color Box (English/French)

UNIT SIZE: 2 - 2' x 20'  
 CARTON WEIGHT: 39 lbs  
 CARTON SIZE: 16" x 16" x 27.5" (UPS-able)  
 UNITS/PALLET: 18

### ORDER GUIDE FOR 80 sq. ft. SYSTEM (I/G POOLS)

Raises Water Temperature 10° F (6° C) or More During Swimming Season

Pool Sizes up to	Quantity
15' x 30'	.2 Solar Boxes & 1 System Kit
16' x 36'	.3 Solar Boxes & 1 System Kit
20' x 40'	.4 Solar Boxes & 1 System Kit

Add A Solar Blanket To Retain The Heat  
 For Year-Round Swimming Areas, Add 1 Solar Box

### Note:

One System Kit (SK21) is Required for all Inground Pool Solar Installations (up to 4 Solar Boxes in an Installation). Use Only SmartPool Mounting & System Hardware. (See Opposite Page)





System Kit for Inground Pool 80 sq. ft. (#S601) Solar Heating System

#SK21

- **Contains Everything You Need to Complete the Recommended Installation**
- **All Necessary Valves • Mounting Hardware • Instructions**

• 1 - 1.5" Diverter Valve

• 1 - 3.75" Hose

• 2 Pipe Adapters

• 1 End Cap

• 1 Vacuum Relief End Cap

• 5 Stainless Steel Mounting Brackets

CARTON WEIGHT: 6 lbs

CARTON SIZE: 11.5" x 11.5" x 6" (UPS-able)

• 5 - 2" #14 Stainless Steel Screws

• 100' Web Strap (Mounts up to 4 Solar Boxes)

• 1 Spring Check valve

• 3 Stainless Steel Clamps

• Trilingual Installation/Operation Manual (English/French/Spanish)

**Note:**

One System Kit (SK21) is Required for all Inground Pool Solar Installations (up to 4 Solar Boxes in an Installation). Use Only SmartPool Mounting & System Hardware. (See Opposite Page)

# SOLARPILL

POOL BLANKET IN A PILL



- **Easy To Use - Simply Place In Skimmer; Automatically Dispenses**
- **Reduces Heat & Chemical Loss By Preventing Water Evaporation**
- **Helps Extend Your Swimming Season**
- **Nontoxic - 100% Safe For Your Family & The Environment**



AP72 For Pools up to 30,000 Gallons



AP73 For Pools up to 12,000 Gallons



SolarPill Counter Display



Blue Base Turns Counter Displays into Floor Display



## ACCESSORIES

### Roof/Rack Mounting Kit (One per Box)

#SK43

- Safely Mounts Aboveground Solar Collectors to a roof or rack

- 5 - Six ft. Straps of Black Webbing
- 15 Stainless Steel Mounting Brackets
- 15 - #14 Stainless Steel Screws

- Multilingual Installation Manual

CARTON WEIGHT: 2 lbs  
CARTON SIZE: 9" x 3.5" x 3.5" (UPS-able)

### High Wind Mounting Accessory (One per Collector)

#SK34

- For High-Wind Areas ; Used in Addition to SK43 and SK21

- 4 - Six ft. Straps of Black Webbing
- 4 Stainless Steel Mounting Brackets
- 4 - #14 Stainless Steel Screws

- Trilingual Installation Manual (English/French/Spanish)

CARTON WEIGHT: 2 lbs  
CARTON SIZE: Polybagged (UPS-able)

### Manual Diverter Valve Kit (for Aboveground Pools)

#SK35

- Allows Control of Water through Collector(s) or Directly Back to Pool

- 1 - 1.5" Ball Valve
- 2 - 1.5" Tees
- 4 Flex hoses Adapters

- Multilingual Installation Manual

CARTON WEIGHT: 3 lbs  
CARTON SIZE: 8.5" x 7" x 5.5" (UPS-able)

### Helio-Matic® HM4000 Combo - Electronic Controller /Valve/Sensor Pack

#SK39

- Allows Automatic Control of Solar Heating System for Perfect Pool Water Temperature

- Helio-matic® Electronic Controller
- Flo-Verter® Valve
- Sensor Pack - One Water/One Solar
- 50 Ft. of Sensor Wire

- Installation Manual

CARTON WEIGHT: 7 lbs  
CARTON SIZE: 10.5" x 9" x 10.5" (UPS-able)



Electronic Controller



Flo-Verter® Valve

# POOLEYE™

SWIMMING POOL ALARMS

## Aboveground Pool Alarm System

#PE12

### What Makes PoolEye Alarms Better?

- Uses Subsurface Wave Detection Technology - The Most Accurate Pool Intrusion Detection Available
- Affordable And Easy To Install

- Patented Sub-Surface Wave Detector
- Sensor Placed Below Water Surface Eliminates False Alarms Due to Wind, Rain, etc.
- Detects Objects 15 lbs or More
- Adjustable Sensitivity
- 120 dB Alarm Siren (Stainless Steel Speaker) (95 dB at 10 ft.)
- ETL-Listed to UL standards
- Child-Proof Locking ON/OFF Switch w/Audio Indicator
- Automatic Low Battery Check - Chirps Every 60 Seconds
- Recommended for Pools up to 24' Round or 16' x 32' Oval (Larger Pools Require an additional Alarm)
- Automatic Reset in 3 Minutes
- Power Check Test Button
- Sensor Mounts Under Top Ledge/Siren on Vertical Support Post Outside of Pool
- Water-Resistant/Weatherproof Construction
- Runs on 4 AA Batteries (not incl.)
- Bilingual Installation/Operation Manual (English/French)
- Bilingual 4-Color Box (English/French)

MASTER CARTON WEIGHT: 14 lbs (6/Master)  
 UNIT BOX SIZE: 13.5" x 6" x 3.5"  
 UNITS/PALLET: 378  
 MINIMUM ORDER: 1 Case (6 Units)

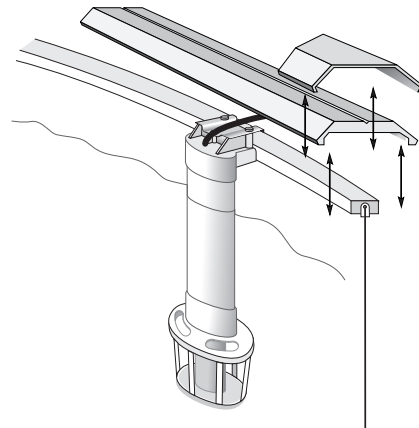

Poolside Siren



# POOLEYE™

SWIMMING POOL ALARMS

## Aboveground Pool Alarm System w/ In-Home Remote Receiver

#PE13

### What Makes PoolEye Alarms Better?

- Uses Subsurface Wave Detection Technology - The Most Accurate Pool Intrusion Detection Available
- Affordable And Easy To Install

- Patented Sub-Surface Propagation Wave Detector
- Eliminates False Alarms Due to Wind, Rain, etc.
- Detects Objects 15lbs or More
- 120 dB Alarm Siren (Stainless Steel Speaker) at Poolside (95 dB at 10 ft.)
- ETL Listed to Tested to UL 464
- Child-Proof ON/OFF Switch w/Audio Indicator
- Built-in RF Channel A or B Select
- Remote Receives Signal up to 100' Away
- Remote can be Connected to a Home Security System
- Automatic Low Battery Check - Chirps Every 60 Seconds
- Recommended for Pools up to 24' Round or 16' x 32' Oval (Larger Pools Require an Additional Alarm)
- Automatic Reset in 3 Minutes
- Power Check Test Button
- Sensor Mounts Under Top Ledge/Siren Mounts on Top Ledge
- Water-Resistant/Weatherproof Construction
- Poolside Alarm Operates on One 9 Volt Battery (not incl.)
- Remote Receiver Operates on UL/CSA Listed AC Adapter
- Remote Features 9 Volt Battery back up (Battery not Incl.)
- Bilingual Installation/Operation Manual (English/French)
- Bilingual 4-Color Box (English/French)



Features In-Home Remote Receiver



Poolside Siren

MASTER CARTON WEIGHT: 18 lbs (6/Master)

UNIT BOX SIZE: 14.5" x 5.5" x 4"

UNITS/PALLET: 288

MINIMUM ORDER: 1 Case (6 Units)

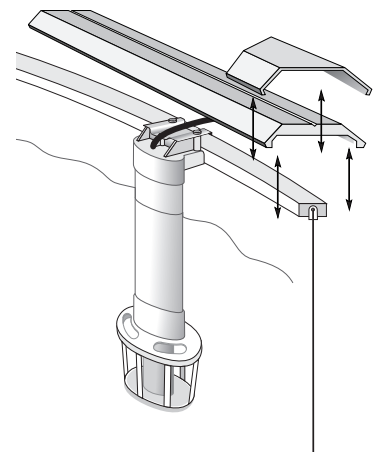

# POOLEYE™

SWIMMING POOL ALARMS

## Inground Pool Alarm System

#PE20

### What Makes PoolEye Alarms Better?

- Uses Subsurface Wave Detection Technology - The Most Accurate Pool Intrusion Detection Available
- Affordable And Easy To Install

- Patented Sub-Surface Propagation Wave Detector
- Sensor Placed Below Water Surface Eliminates False Alarms Due to Wind, Rain, etc.
- Detects Objects 15lbs or More (Sensitivity Adjustable)
- Stainless Steel Deck Mounting System and Ladder Mounting System Included
- 120 dB Alarm Siren at Poolside, 95 dB at 10 ft.
- ETL-Listed to UL 464
- Child-Proof ON/OFF Switch w/Audio Indicator
- Built-in RF Channel A or B Select
- Remote Receives Signal up to 100' Away
- Remote can be Connected to a Home Security System
- 2 Thermostats for Monitoring Both Water and Air Temperature in o F or o C
- Automatic Low Battery Check - Chirps Every 60 Seconds

MASTER CARTON WEIGHT: 28 lbs (6/Master)

UNIT BOX SIZE: 21.5" x 5.5" x 4.5"

UNITS/PALLET: 288

MINIMUM ORDER: 1 Case (6 Units)

- Recommended for Pools up to 18' x 36'  
(Larger Pools Require an Additional Alarm)
- Automatic Reset in 3 Minutes
- Power Check Test Button
- LCD Display
- Water-Resistant/Weatherproof Construction
- Operates on 1 - 9 Volt & 1 AA Battery (not incl.)
- Remote Uses AC Power Adapter (UL/CSA Listed)
- Back-up 9 Volt Battery (not incl.) for Remote
- English/French Installation/Operation Manual
- Bilingual 4-Color Box (English/French)

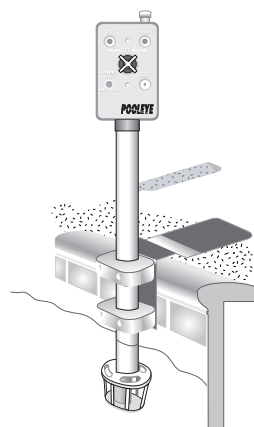

Deck and Ladder Mount Included



Poolside Siren



# POOLEYE™

SWIMMING POOL ALARMS

## Inground Pool Alarm System w/ In-Home Remote Receiver and Water/Air Temperature Monitor

#PE21

### What Makes PoolEye Alarms Better?

- Uses Subsurface Wave Detection Technology - The Most Accurate Pool Intrusion Detection Available
- Affordable And Easy To Install

- Patented Sub-Surface Propagation Wave Detector
- Sensor Placed Below Water Surface Eliminates False Alarms Due to Wind, Rain, etc.
- Detects Objects 15lbs or More (Sensitivity Adjustable)
- Stainless Steel Deck Mounting System and Ladder Mounting System Included
- 120 dB Alarm Siren at Poolside, 95 dB at 10 ft.
- Tested to UL 464 and CSA C22.2
- Child-Proof ON/OFF Switch w/Audio Indicator
- Built-in RF Channel A or B Select
- Remote Receives Signal up to 100' Away
- Remote can be Connected to a Home Security System
- 2 Thermostats for Monitoring Both Water and Air Temperature in o F or o C
- Automatic Low Battery Check - Chirps Every 60 Seconds
- Recommended for Pools up to 18' x 36' (Larger Pools Require an Additional Alarm)
- Automatic Reset in 3 Minutes
- Power Check Test Button
- LCD Display
- Water-Resistant/Weatherproof Construction
- Operates on 1 - 9 Volt & 1 AA Battery (not incl.)
- Remote Uses AC Power Adapter (UL/CSA Listed)
- Back-up 9 Volt Battery (not incl.) for Remote
- English/French Installation/Operation Manual
- Bilingual 4-Color Box (English/French)



In-Home Remote Included



Ladder Mount Included



Deck Mount Included

MASTER CARTON WEIGHT: 28 lbs (6/Master)  
 UNIT BOX SIZE: 21.5" x 5.5" x 4.5"  
 UNITS/PALLET: 288  
 MINIMUM ORDER: 1 Case (6 Units)



# POOLEYE™

SWIMMING POOL ALARMS

## Inground Pool Alarm W/Remote Receiver & Infrared Perimeter Detection

#PE22

**INFRARED NIGHTVISION!**

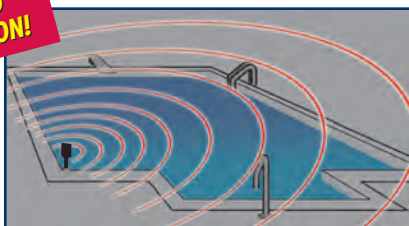

**2 LAYERS OF PROTECTION!**



Deck and Ladder Mounting Hardware Included

**SUB-SURFACE WAVE DETECTION!**



### LAYER 1 - Perimeter Detection

- Preventive Alert System
- Passive Infrared Motion Detector (PIR) Range of 1800 and up to 50'
- Independent On/Off Control with Child-Proof Lock
- In-Home Remote Receiver Features Voice Announcements When Perimeter Alarm is Set Off
- Automatic Reset in 30 seconds
- Adjustable PIR Sensitivity

### System Features

- ETL-Listed to UL 464
- Child-Proof ON/OFF Switch w/ Audio Indicator
- Stainless Steel Deck Mounting and Ladder Mounting Systems Included
- Automatic Low Battery Check - Chirps Every 60 Seconds
- Recommended for Pools up to 18' x 36' (Larger Pools Require an Additional Alarm)
- Power Check Test Button
- Water-Resistant/Weatherproof Construction
- Interactive Weather-Resistant Control
- Back-up 9 Volt Battery (not incl.) for Remote
- Poolside Unit Operates on Six AA Batteries (not incl.)
- Bilingual Installation/Operation Manual
- Bilingual 4-Color Box

### LAYER 2 - Immersion Detection

- Patented Sub-Surface Wave Detection
- Sensor Placed Below Water Surface Eliminates False Alarms Due to Wind, Rain, etc.
- Detects Objects 15lbs or More
- Adjustable Sensitivity
- 120 dB Alarm Siren, 95 dB at 10 ft. at Poolside

### Remote Features

- Built-in RF Channel A or B Select
- Remote Receives Signal up to 100' Away
- Remote can be Connected to a Home Security System
- Remote Announces "Check The Pool" (3x) When Perimeter Alarm Signal Detected
- Remote Announces: "Emergency! Check The Pool!", and Sounds Alarm When Underwater Alarm Signal Received
- Remote Announces "Check The Battery" When Low Battery Signal Received from Poolside Unit
- Remote Uses AC Power Adapter (UL/CSA Listed)
- Back-up 9 Volt Battery (not incl.) for Remote

MASTER CARTON WEIGHT: 29 lbs (6/Master)  
 UNIT BOX SIZE: 21.5" x 5.5" x 4.5"  
 UNITS/PALLET: 288  
 MINIMUM ORDER: 1 Case (6 Units)



In-Home Remote Included



Inground Perimeter Infrared Pool Alarm W/Remote

#PE41

**What Makes the PoolEye PE41 Alarm Better?**

- Alarm is Activated **BEFORE** Pool Entry – Preventative Rather than Reactive
- European Design - Complies with Stringent Pool & Barrier Alarm Codes

- Active Infrared for Complete Perimeter Protection up to 25 Meters
- Fewer False Alarms with Advanced SMARTFENCE Software.
- Not Affected by Outside Forces: Wind, Rain, etc.
- Works Easily with all Robotic Pool Cleaners.
- Powerful 100 dB Alert Siren
- Pass Mode Allows for EASY Entry and Automatically Re-Arms at a Preset Interval.
- Battery Back up Provides 6 hours of Perimeter Protection Even in the Event of a Power Outage.
- Unit Emits Low AC "CHIRP" for 24 Hours to a Alert consumer that there has been an Interruption in their Source Voltage.

- Installs in Minutes with Common Tools.
- Alarms **BEFORE** Pool Entry – Preventative Rather than Reactive
- Recommended for all Sizes of Inground Pools
- Child-Proof/Water-Resistant/Weatherproof Construction
- Runs on AC Transformer with Battery Backup
- LED Poles Bolt to Deck or Patio
- Control box/Siren Mounts to Wall or Fence
- Trilingual Installation/Operation Manual (English/French/Spanish)
- Bilingual 4-Color Box (English/French)

The PoolEye PE41 was designed to meet the stringent demands of France's new NF P90-307 pool alarm standard - a standard that may form the basis for future U.S. state and local alarm requirements.

UNIT WEIGHT: 15 lbs  
 UNIT BOX SIZE: 22.5" X 13.5" X 12.5"  
 UNITS/PALLET: 30  
 MINIMUM ORDER: 1 Unit

**POOLEYE**

- *Protect Your family with Infrared Technology*
- *Do-It-Yourself Installation Easy to Operate*
- *Use with any Inground Pool - Any Shape, Any Size*
- *L'alarme intelligente qui prévient du danger*
- *Rapide et facile à installer, simple à utiliser*
- *Esthétique et discrète, elle s'intègre à l'environnement de la piscine*

**PERIMETER SWIMMING POOL ALARM**  
**ALARME PÉRIMÉTRIQUE POUR PISCINE**



# YARDGUARD™

## GATE ALARM SYSTEMS

Gate/Door/Window Alarm System

#YG03

### What Makes YardGard Gate Alarms Better?

- YardGard Complies with U.S. State and Local Barrier Alarm Codes
- Easy to Install and Operate - for All Wooden and Metal Gates and Sliding Glass Doors

- Convenient Single Button Pass/Reset Operation
- 7-Second Delay Allows for Adult Pass-Through
- 120 dB Alarm Siren - Minimum 95 dB at 10 Feet
- Auto Low Battery Chirp
- All Hardware Included for Gate, Door or Window Mount
- Listed by ETL to UL 2017
- Water-Resistant
- Always On Device as Required by Barrier Codes
- Can be Manually Reset or will Automatically Reset in 3 Minutes to Continue Siren
- Alarm Goes Off Immediately When Triggered as Required by Barrier Codes
- Operates on One - 9 Volt Battery (not incl.)
- Bilingual Installation/Operation Manual (English/French)
- Bilingual 4-Color Box (English/French)

MASTER CARTON WEIGHT: 6 lbs (6/Master)

UNIT BOX SIZE: 9.5" x 7" x 3"

UNITS/PALLET: 648

MINIMUM ORDER: 1 Case (6 Units)



Contact Set Included



Adult Pass Button Included



# YARDGUARD™

GATE ALARM SYSTEMS

Programmable Gate/Door/Window Alarm System

#YG18

## What Makes The YardGard YG18 Gate Alarm Better?

- Features a Programmable Entry Code for Greater Security
- 2 Adult Pass-Through Settings for Convenience

- Program Your Own Entry/Exit Code
- Convenient Single Button Pass/Reset Operation
- 7 or 15 Second Delay Allows for Adult Pass-Through
- 120 dB Alarm Siren - Minimum 95 dB at 10 Feet
- Auto Low Battery Chirp
- All Hardware Included for Gate, Door or Window Mount
- Listed by ETL to UL 2017
- Water-Resistant
- Always On Device as Required by Barrier Codes
- Can be Manually Reset or will Automatically Reset in 3 Minutes to Continue siren
- Always Resets to Standby State in 30 Seconds After Last Switch Activation
- Alarm Goes Off Immediately When Triggered as Required by Barrier Codes
- Operates on 6 AA batteries (not incl.)
- Bilingual Installation/Operation Manual (English/French)
- Bilingual 4-Color Box (English/French)



MASTER CARTON WEIGHT: 6 lbs (6/Master)

UNIT BOX SIZE: 9.5" x 7" x 3"

UNITS/PALLET: 648

MINIMUM ORDER: 1 Case (6 Units)



Contact Set Included



Adult Pass Button Included

# YARDGARD™

GATE ALARM SYSTEMS

## Wired Gate/Door/Window Alarm System

#YG04

### What Makes YardGard Gate Alarms Better?

- YardGard Complies with U.S. State and Local Barrier Alarm Codes
- Easy to Install and Operate - for All Wooden and Metal Gates and Sliding Glass Doors

- Convenient Single Button Pass/Reset Operation
- 7 Second Delay Allows for Adult Pass-Through
- 120 dB Alarm Siren - Minimum 95 dB at 10 Feet
- UL-Listed Low-Voltage Adapter
- Mounting Hardware Included for Gate, Door or Window
- Contacts, Pass Buttons, and Wire Sold Separately
- Listed by ETL to UL 2017
- Water-Resistant
- Always On Device as Required by Barrier Codes
- Can be Manually Reset or will Automatically Reset in 3 Minutes to Continue Siren
- Alarm Goes Off Immediately When Triggered as Required by Barrier Codes
- Bilingual Installation/Operation Manual (English/French)
- Bilingual 4-Color Box (English/French)

MASTER CARTON WEIGHT: 8 lbs (6/Master)

UNIT BOX SIZE: 6" x 5.5" x 3"

MINIMUM ORDER: 1 Case (6 Units)

### UL XTW Wire (20 AWG x 2) per 1000' YG31

Case Count: 1 Roll/1000 ft.

Case Weight: 14 lbs

Minimum Order: 1 Case

### Contact Set YG32

Case Count: 48 Units

Case Weight: 5 lbs

Minimum Order: 1 Case



### Pass Button YG33

Case Count: 24 Units

Case Weight: 31 lbs

Minimum Order: 1 Case



# NITELIGHTER

UNDERWATER LIGHTING SYSTEMS

## 35 Watt Underwater Lighting System for Aboveground Pools

#NL35

### What Makes NiteLighter Better?

- Easy To Install - No Drilling Or Draining Required
- The Most Affordable Aboveground Pool Light Available

- Tested to UL Standard 676 and Certified by ETL

- 12 Volt/35 Watt Outdoor Pool Transformer

- Easy Installation - No Drilling or Draining of Pool

- 35 Watt Long-Life UV-Coated Halogen Bulb

- Patented Reflector Design Engineered for Maximum Illumination

- One Light Sufficient to Illuminate Most Aboveground Pools

- Will Not Interfere with Water Return

- Chemical-Resistant Lens

- Fuse Overload Protection

- 28' Cord (Including Transformer and Plug)

- Bilingual Installation/Operation Manual (English/French)

- Bilingual 4-Color Box (English/French)



MASTER CARTON WEIGHT: 25 lbs (4/Master)

UNIT BOX SIZE: 14.65" x 4.75" x 7"

UNITS/PALLET: 288

Minimum ORDER: 1 Case (4 Units)

### NITELIGHTER™ UNDERWATER POOL LIGHTING

Specifications



NL35

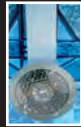

NL50



NL52



NL100



NLMC



NL55

	NL35	NL50	NL52	NL100	NLMC	NL55
Pool Type	Rigid-Wall Aboveground	Rigid-Wall Aboveground	Framed Soft-Sided	Rigid-Wall Aboveground	Rigid-Wall Aboveground	Inground
Power	12 Volt/35 Watt	12 Volt/50 Watt	12 Volt/50 Watt	12 Volt/100 Watt	RGB 100 W Total	12 Volt/50 Watt
Cord Length	28'	28'	28'	28'	28'	50'
Mounting	Over Wall Under Top Rail	Over Wall Under Top Rail	Over Frame	Over Wall Under Top Rail	Over Wall Under Top Rail	Deck Mount Bolted or Dual Lock
Auto Shutoff	--	--	3-Hour	3-Hour	3-Hour	3 or 6-Hour
Colored Lens Covers	Optional	Optional	3 Included	Optional	--	3 Included
Carton Size (Unit)	16" x 6.5" x 4"	16" x 6.5" x 4"	18.5" x 6.5" x 4"	16" x 6.5" x 4"	16" x 6.5" x 4"	21" x 12" x 4.5"
Master Carton/Weight	4 per Master/24 lbs	4 per Master/24 lbs	4 per Master/30 lbs	4 per Master/33 lbs	4 per Master/35 lbs	3 per Master/41 lbs
Units Per Pallet	180	180	180	180	180	108

# NITELIGHTER

UNDERWATER LIGHTING SYSTEMS

50 Watt Underwater Lighting System for Aboveground Pools

#NL50

## What Makes The NiteLighter NL50 Better?

- *Easy To Install - No Drilling Or Draining Required*
- *The Most Affordable 50 Watt Aboveground Pool Light Available*

- Tested to UL Standard 676 and Certified by ETL
- 12 Volt/50 Watt Outdoor Pool Transformer
- Easy Installation - No Drilling or Draining of Pool
- 50 Watt Long-Life UV-Coated Halogen Bulb
- Patented Reflector Design Engineered for Maximum Illumination
- One Light Sufficient to Illuminate any Aboveground Pool
- Will Not Interfere with Water Return
- Chemical-Resistant Lens
- Fuse Overload Protection
- 28' Cord (Including Transformer and Plug)
- Bilingual Installation/Operation Manual (English/French)
- Bilingual 4-Color Box (English/French)

MASTER CARTON WEIGHT: 27 lbs (4/Master)

UNIT BOX SIZE: 14.65" x 4.75" x 7"

UNITS/PALLET: 288

MINIMUM ORDER: 1 Case (4 Units)



# NITELIGHTER

UNDERWATER LIGHTING SYSTEMS

100 Watt Underwater Lighting System for Aboveground Pools

#NL100

## What Makes NiteLighter NL100 Better?

- *Easy To Install - No Drilling Or Draining Required*
- *The Most Affordable 100 Watt Aboveground Pool Light Available*

- |   |  |
|---|--|
| • Tested to UL Standard 676 and Certified by ETL                | • One Light Sufficient to Illuminate All Aboveground Pools |
| • 12 Volt/100 Watt Outdoor Pool Transformer                     | • Will Not Interfere with Water Return                     |
| • Easy Installation - No Drilling or Draining of Pool           | • Chemical-Resistant Lens                                  |
| • 100 Watt Long-Life UV-Coated Halogen Bulb                     | • Fuse Overload Protection                                 |
| • On/Off Switch   | • 28' Cord (Including Transformer and Plug)                |
| • Snap-on Colored Lens Kit Included                             | • Bilingual Installation/Operation Manual (English/French) |
| • Patented Reflector Design Engineered for Maximum Illumination | • Bilingual 4-Color Box (English/French)                   |

MASTER CARTON WEIGHT: 31 lbs (4/Master)  
 UNIT BOX SIZE: 14.65" x 5.5" x 7"  
 UNITS/PALLET: 288  
 Minimum ORDER: 1 Case (4 Units)

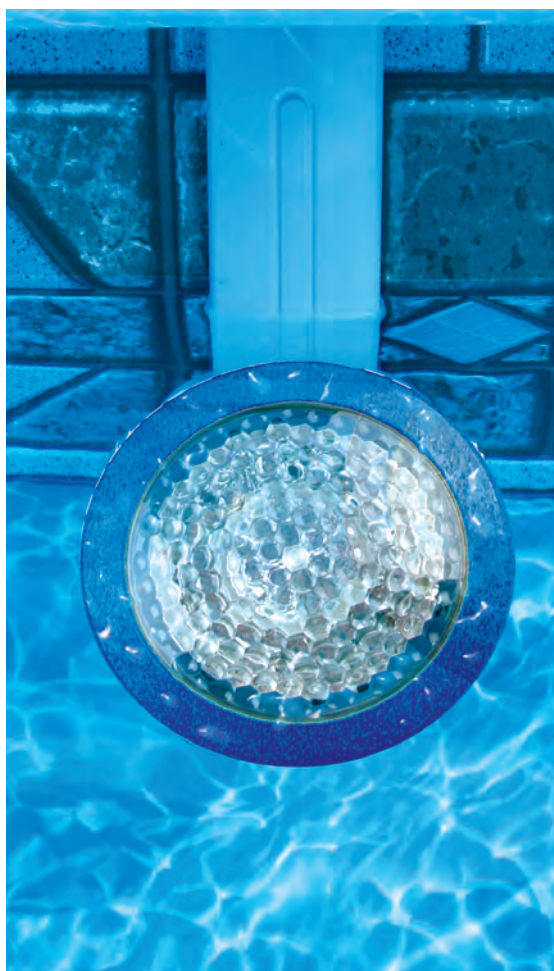

# NITELIGHTER

UNDERWATER LIGHTING SYSTEMS

100 Watt Multi-Colored Underwater Light

#NLMC

## What Makes NiteLighter NLMC Better?

- *Easy To Install - No Drilling Or Draining Required*
- *The Most Affordable 100 Watt Multi-Colored Aboveground Pool Light Available*

- Tested to UL Standard 676 and Certified by ETL
- RGB Halogen Bulbs Produce Beautiful Vibrant Colors AUTOMATICALLY
- 12 Volt/100 Watt Outdoor Pool Transformer
- Easy Installation - No Drilling or Draining of Pool
- On/Off Switch
- Built-in 3-Hour Timer with Auto Shut-Off
- Patented Reflector Design Engineered for Maximum Illumination
- One Light Sufficient to Illuminate any Aboveground Pool

- Will Not Interfere with Water Return
- Chemical-Resistant Lens
- Fuse Overload Protection
- Stainless Steel Mounting Bracket
- 28' Cord (Including Transformer and Plug)
- Bilingual Installation/Operation Manual (English/French)
- Bilingual 4-Color Box (English/French)

MASTER CARTON WEIGHT: 31 lbs (4/Master)  
 UNIT BOX SIZE: 14.65" x 5.5" x 7"  
 UNITS/PALLET: 288  
 Minimum ORDER: 1 Case (4 Units)



**MULTI-COLORED NITELIGHTER  
 HALOGEN UNDERWATER LIGHT  
 WITH MANUAL SELECT OR  
 AUTO CYCLE!**



# NITELIGHTER

UNDERWATER LIGHTING SYSTEMS

50 Watt "ULTRA" Underwater Light for Framed Soft-Sided Pools

#NL52

## What Makes NiteLighter NL52 Better?

- Easy To Install - No Drilling Or Draining Required
- The Most Affordable Soft-Side Aboveground Pool Light Available

- |   |  |
|---|--|
| • 12 Volt/50 Watt Outdoor/Pool Transformer                      | • Includes 3 Snap-On Colored Lenses                        |
| • Easy Installation - No Drilling or Draining of Pool           | • Chemical-Resistant Lens                                  |
| • Dual Lighting Modes (Mood Lighting/High Intensity Lighting)   | • Fuse Overload Protection                                 |
| • 50 Watt Long-Life UV-Coated Halogen Bulb                      | • Dual Mounting Points with All Mounting Hardware Included |
| • On/Off Switch   | • Stainless Steel Mounting Bracket                         |
| • Built-in 3-Hour Timer with Auto Shut-Off                      | • 28' Cord (Including Transformer and Plug)                |
| • Patented Reflector Design Engineered for Maximum Illumination | • Bilingual Installation/Operation Manual (English/French) |
| • One Light Sufficient to Illuminate any Aboveground Pool       | • Bilingual 4-Color Box (English/French)                   |
| • Will Not Interfere with Water Return                          |  |



MASTER CARTON WEIGHT: 30 lbs (4/Master)  
 UNIT BOX SIZE: 18.5" x 6.5" x 4"  
 UNITS/PALLET: 288  
 MINIMUM ORDER: 1 Case (4 Units)





# NITELIGHTER

UNDERWATER LIGHTING SYSTEMS

**"ULTRA" Underwater Lighting System for Inground Pools**

**#NL55**

## What Makes NiteLighter NL55 Better?

- *Easy To Install - No Drilling Or Draining Required*
- *The Most Affordable Inground Pool Light Available*

- One Light Sufficient to Illuminate Most Inground Pools
- 12 Volt Outdoor Pool Transformer
- Easy Installation - No Drilling or Draining of Pool
- Comes Completely Assembled with Choice of two Mounting methods:
  - Drilled to Deck (Lag Screws Included)
  - Adhesive (3M Dual Lock™) - Unit can be Removed for Winter Storage
- Deck Cord Cover (8 ft.)
- 3 Color Snap-On Lens Kit Included
- Built-in 3 or 6 Hour Timer with Auto Shut-Off
- Patented Reflector Design Engineered for Maximum Illumination
- Chemical-Resistant Lens
- Fuse Overload Protection
- Stainless Steel Mounting Bracket
- 50' Low Profile Cord (Including Transformer and Plug)
- Bilingual Installation/Operation Manual (English/French)
- Bilingual 4-Color Box (English/French)

MASTER CARTON WEIGHT: 41 lbs (3/Master)  
 UNIT BOX SIZE: 21" x 12" x 4.5"  
 UNITS/PALLET: 108  
 MINIMUM ORDER: 1 Case (3 Units)

**PERFECT  
 FOR PARTIES!  
 EASILY  
 REMOVABLE!**



# NITELIGHTER

UNDERWATER LIGHTING SYSTEMS

## ACCESSORIES

**3-Color Snap-On Lens Kit for Rectangular Lens Models**

**#NLK4**



Case Count: 12 Units  
 Case Weight: 6 lbs  
 Minimum Order: 1 Case

**Replacement Bulb Kit (20 Watts for NL20)**

**#NLK1**

**Replacement Bulb Kit (35 Watts for NL35 Rectangular Lens Model)**

**#NLK2**

**Replacement Bulb Kit (50 Watts for NL50, 52, & 55 Rectangular Lens Models)**

**#NLK3**

**Replacement Clear lens Kit (all Rectangular Lens Models)**

**#NLK0**

**Replacement Bulb Kit (35 Watts for NL35 Round Lens Model)**

**#NLK6**

**Replacement Bulb Kit (50 Watts for NL50 Round Lens Model)**

**#NLK7**

**Replacement Bulb Kit (100 Watts for NL100)**

**#NLK8**

**Replacement Bulb Kit (RGB Bulbs for Multi-Colored Model)**

**#NLK9**

*Single Bulb Kits:*

Case Count: 12 Units  
 Case Weight: 3 lbs  
 Minimum Order: 1 Case



# 2008 DEALER MARKETING PROGRAMS

## DYNAMIC POP

In addition to product innovation, SmartPool is dedicated to helping you, the dealer, achieve your sales objectives by providing you with attention-getting, dynamic POP displays. Call us today to find out how you can qualify to receive free SmartPool displays for your store!



Display Subject to Change

## SMARTPOOL.COM DEALER LOCATOR

Be part of our new web-based SmartPool Dealer Locator. Take advantage of the thousands of daily visits to our website by consumers looking to buy our products. Sign up online today. It's Free!

[CLICK HERE TO FIND A DEALER NEAR YOU](#)

## NEW PROMO VIDEOS FOR DEALERS

A New Video is now available on the Nitro™ Robotic Pool Cleaner along with videos on Robo-Kleen and SunHeater™. Order continuous loop videos for your stores and single viewing format to loan to your customers. Not only are these videos great for promoting your SmartPool product, they also provide an overview for installation and operation.



## FREE LITERATURE FOR DEALERS

In addition to using this catalog in your retail store to explain SmartPool products, individual product brochures are available in packages of 25. Use them in your store or mail to your customers. Each brochure has a place for your store address stamp.



## FREE TRAINING IN YOUR STORE

Your staff can get the very best product training from our professional representatives. We'll come to you!

For More Information on These Dealer Marketing Programs,  
Please Call SmartPool Customer Service Toll-Free at 1-888-560-7665



687 Prospect Street • Lakewood, NJ 08701

Toll-Free: 1-888-560-7665

Tel: (732) 730-9880 • Fax: (732) 730-9881

Email: [info@smartpool.com](mailto:info@smartpool.com) • [www.smartpool.com](http://www.smartpool.com)