

PE13



Table of contents

Important - Please read first	2
Rectangular or oval pools	3
Round pools	3
Installation	4
Pool Side Alarm Transmitter Assembly	5
Sensitivity Adjust	5
Battery Installation	6
Low Battery Indication	6
Turn The Unit ON	7
Turn The Unit OFF	7
Reset The Unit	7
Sensor Calibration	8
Test The Unit	8
RF (Radio Frequency) Signal Link Testing	8
Transmitter channel A/B Select	10
Remote Receiver	11
Receiver Channel A/B Select	11
Back Up Power	12
How To Connect To Your Home Security System	12
Trouble Shooting	14
Warranty	16

IMPORTANT - Please read first

THIS PRODUCT DOES NOT REPLACE THE NEED FOR ADULT SUPERVISION OF ALL PERSONS IN THE POOL AREA. IT IS NOT A LIFE SAVING DEVICE. IT IS AN AID TO A MULTI LEVEL PROGRAM OF POOL SAFETY INCLUDING ADULT SUPERVISION, KNOWLEDGE OF CPR AND SWIMMING INSTRUCTION FOR ALL PERSONS USING THE POOL. IT IS INTENDED FOR USE ON RESIDENTIAL SWIMMING POOLS ONLY AND THE MANUFACTURER ASSUMES NO RESPONSIBILITY FOR INJURIES OR CONSEQUENTIAL PROPERTY DAMAGE WHILE THIS PRODUCT IS IN USE ON A SWIMMING POOL. PROPER INSTALLATION AND MAINTENANCE ARE THE SOLE RESPONSIBILITY OF THE POOL OWNER.



WARNING: To reduce the risk of injury to bathers, or damage to your product:



This product is not a life-saving device. It is an aid to a multi-level protection program, including adult supervision, knowledge of CPR and swimming instruction for your child.



Do not use if unit is damaged in any way.



Use this product only for its intended use as described in this manual.



Unit must be submerged in water to operate properly.

Rectangular or oval pools

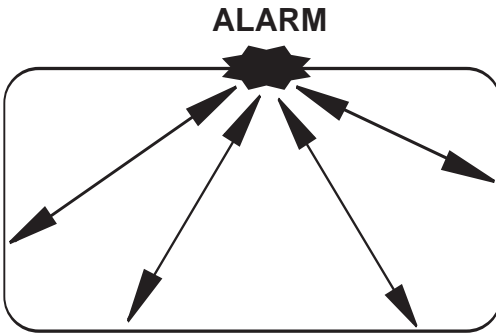

Place alarm in a central location for shortest distance from all parts of the pool

Round pools

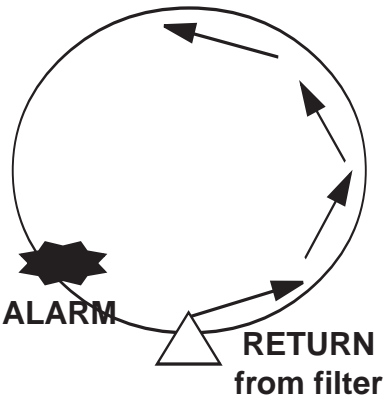

If the water returning from the filter is positioned at 6 o'clock and the flow is counterclockwise, the best location to put the alarm is between 8 o'clock to 9 o'clock position.

On the other hand, if the flow is clockwise, the alarm should be placed between 3 o'clock to 4 o'clock position.

ALL POOLS

Do not point the eyeball of the return towards the center with the alarm at the side. The flow from the return will interfere, so the alarm sensor cannot detect the wave motion properly.

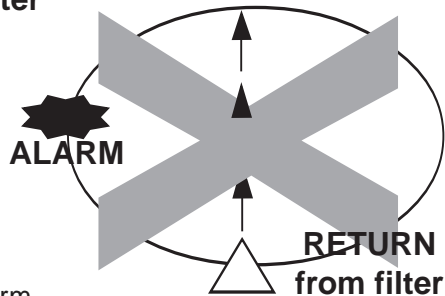

WARNING: Every pool condition varies, test the alarm before use

Installation

1. Take top seat cap of pool off and remove the screws holding one end of the top seat
2. Lift up one end of the top seat of pool
3. Hang the sensor tube onto the guide rail. Back of the sensor unit should rest against the inside of pool wall.

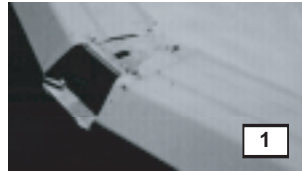

4. For wider guide rail, move the stainless bracket forward by removing the three stainless steel screws and moving the bracket.
5. Tighten the set screws on the stainless steel mounting bracket against the pool wall after inserting the plastic spacer to protect wall and liners.

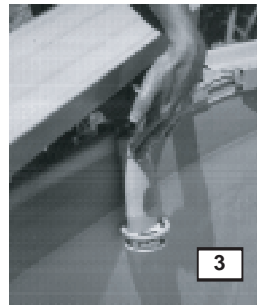

6. Replace the top seat and top cap.

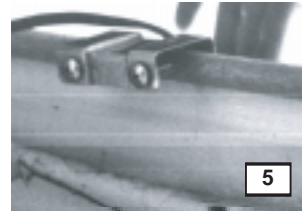
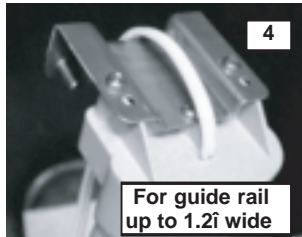
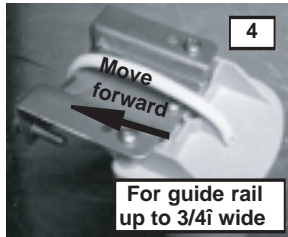

Sensitivity Adjust

Loosen the two screws on the bottom of the sensor.

Move the plastic piece with the pointer pointed to iHî if you want higher sensitivity or to ìLî if you want lower sensitivity. The unit is preset at factory to iHî.

If you have to place the unit near the return, snap the cap onto the sensor cage facing the direction of water flow.



NOTE: The deflector will reduce sensitivity.
Test the alarm unit as described in section 4.0 before use



Pool Side Alarm Assembly

The *POOLEYE* pool side alarm comes with a control head and a separate sensor tube. Before the unit can be used, the two pieces must be assembled together as follows:

Locate the phone jack at the bottom of the control head, and a phone plug coming out from one end of the sensor tube. Place this phone plug into the phone jack.

Gently push the tube into the bottom of the control head. The sensor tube end should fit snugly into the bottom of the control head.

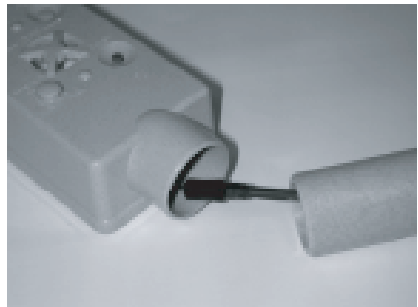

Using the base as a template, drill 3 holes of 1/8" diameter on the top seat. Mount the unit onto the top seat as shown (right).

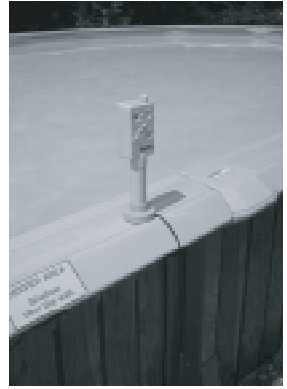

Battery Installation

The pool side alarm is designed to be powered by a standard 9V alkaline battery.

After installing battery, press the **TEST** button located at the front on the control unit. The alarm will sound either one beep, or 5 consecutive beeps. This will depend whether the unit is turned ON or OFF.



Low Battery Indicator

The unit has a built-in microprocessor which automatically monitors the 9V battery level. When this battery is running low, it will sound a chirping tone approximately once every 60 seconds. Simply replace the 9V battery with a new one when this occurs.

Turn the unit ON

Press the green ON button and the unit will sound one short beep to indicate it is on. The alarm siren will sound when the sensor picks up any water wave motion. Therefore you should wait a few minutes for the water wave to settle down before turning on the unit.

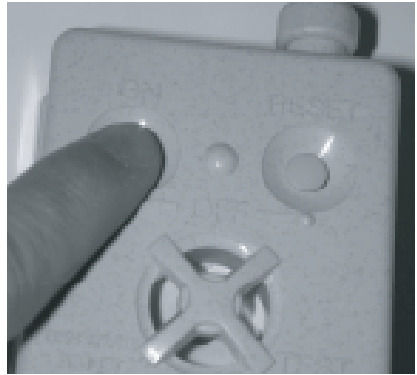

If the alarm goes off immediately after you hit this green ON button, recheck the mounting of the alarm unit. If the unit is not securely mounted, pushing the control head will cause the alarm to sound off. If the alarm continues to sound off whenever it is turned on, please read the Sensitivity Adjust section.

Turn the unit OFF

Press and hold both the green ON and the yellow RESET button simultaneously for 3 seconds, until you hear 5 consecutive beeps. The unit is now turned OFF.



Reset the unit

Press the yellow RESET button to turn OFF the siren. This will reset the unit to the ON state automatically.



Alarm unit function test

Fill a 5 Gal pail 1/3 full with water and drop the pail from a height of a few inches from the surface of water. The wave created should activate the alarm. If this test is unsuccessful, adjust the sensitivity (refer to Sensitivity Adjust section).

Between each weight drop test, you should turn the unit OFF. Then wait until the water settles.

Repeat the same process at all locations of your pool. If the alarm fails to sound, move the alarm unit to another position and try again. If you find a dead zone in your pool, this may be an indication that your pool needs a second alarm unit.



Do not use the unit until the test results are satisfactory.

IMPORANT NOTES:

Pools larger than 18 feet by 36 feet, L-shaped, or some other free form pools, may require more than one pool side alarm for effective monitoring.

The pool side alarm unit should be able to detect an object that weighs over 15 lbs.

Sensor Calibration

While the life expectancy of this alarm system is in excess of five years, the effects of a swimming pool environment may shorten this period. It is recommended that the alarm be recalibrated or refurbished by the manufacturer every 5 years after installation. For questions about installation and warranty, call 1-877-799-7665 1-4 pm EST Monday - Friday.

RF (radio frequency) signal link testing

This unit provides a convenient RF link test, to ensure good RF transmission without setting off the alarm.

Hit the **TEST** button and hold for a couple of seconds. The unit will sound one beep or five consecutive beeps. This will depend on whether the unit is set to ON or OFF. Continue to hold this **TEST** button for three seconds until you hear three consecutive beeps. The unit will send out a RF alarm signal to the receiver inside the house without setting itself off.

The receiver inside the house should sound within ten seconds after this three consecutive beeps. If the receiver does not ring, move the receiver to another location and check the installation again. Ensure all *POOLEYE* devices are set to the same channel. (Refer to channel A/B select of both pool side alarm transmitter and receiver).

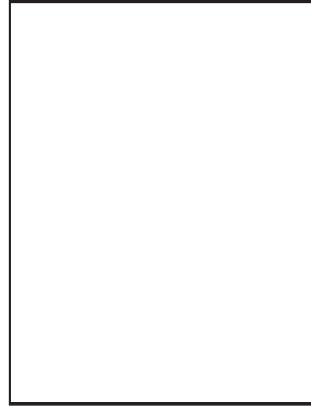

IMPORANT NOTES:

Remember to check the RF link periodically to ensure good RF transmission. If the RF signal is weak, replace the battery in the pool side alarm with a new one.

RF signal can be transmitted through a solid wall. However, it is possible that this may weaken the RF signal. To avoid this, it is important to place the receiver in a straight line of sight to the transmitter whenever possible.

The microprocessor (built in the transmitter) is programmed to make three attempts to send the encoded RF signal out to the receiver. If the first attempt fails, the transmitter will change the coding and make a second attempt. If it fails again, the transmitter will change the coding and try for the third time. As a result, you may experience a few seconds delay between setting off the pool side alarm transmitter to the receiver.

Battery level affects RF signal strength. Weak battery in the pool side alarm transmitter will give weak RF signal out.

Transmitter Channel A/B select

The pool side alarm RF (radio frequency) signal can be transmitted from the transmitter to the receiver inside the house by two different channels (A or B). All units are preset at channel A in the factory. However, if your alarm system interferes your neighbor's alarm system, you may have to change your alarm unit to channel B.

The pool side alarm unit has a built-in channel select switch. This is located inside the battery compartment. Follows these instructions to change the channel.

1. Open the battery door and remove the battery. You can see an A/B slide switch located at the corner of battery compartment.
2. Use a screw driver to push the switch handle from A to B. Make sure to do the same channel adjustment on **ALL** your *POOLEYE* devices, including the receiver.

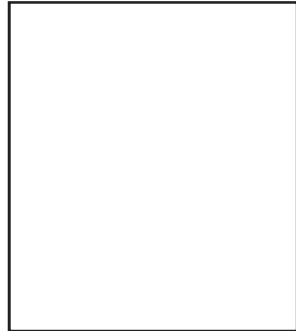

Remote receiver

Place the remote receiver inside your house but close to the pool side alarm unit and at a straight line of sight. DO NOT place the unit near large metal objects or large motors, such as a refrigerator, or washing machine. This will adversely affect the RF reception

Plug in the A/C adapter and the green LED will stay ON, indicating it is ready to receive signals.

Hit the RESET button located between the two LEDs, to reset the receiver. Each reset will disable the receiver for 10 seconds, allowing you enough time to go to the pool side alarm transmitter to reset it, or turn it off. During this 10 second timeframe, the red LED will flash every 1 second. If you do not reset the receiver, it will reset automatically in four minutes.



Remote Receiver Channel A/B select

The pool side alarm or other POOLEYE alarms RF (radio frequency) signal can be transmitted from the transmitter to the receiver inside the house by two different channels (A or B). All units are preset at channel A in the factory. However, if your alarm system interferes your neighbor's alarm system, you may have to change them to channel B.

The remote receiver has a built in channel select switch, located inside the receiver box. Loosen the four screws and remove the battery door. You can find a slide switch at the corner that mark 'A' and 'B'. Push the switch handle from position 'A' to position 'B'. Make sure you do the same channel adjust on all your POOLEYE devices, including the pool side alarm transmitter. Check the RF link periodically to ensure good RF transmission.

Back up power

The receiver unit is designed to use a regular alkaline 9V battery as back up power source. To install this back up battery, remove the 4 screws and open the battery door.

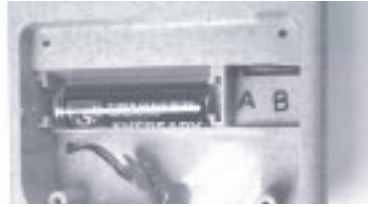

**9V alkaline battery
Back up power**

How to connect to your home security system

The remote receiver has a three junction terminal block, so that you can connect it to your home security system or other third party safety device. When the receiver receives a RF (radio frequency) alarm signal, it will activate the terminal block in 3 seconds. Resetting the receiver within 3 seconds ensures that you will not activate your home security system.

Loosen the screw at the top and remove the blue cap. Remove the battery door and loosen the two screws. Open up the box and you can find a 3 junctions terminal block near the A/C adapter power jack.



The terminal block signal switching is controlled by microprocessor. For current switching, it is recommended to connect a K-1 type relay (not included) to the terminal block as shown.

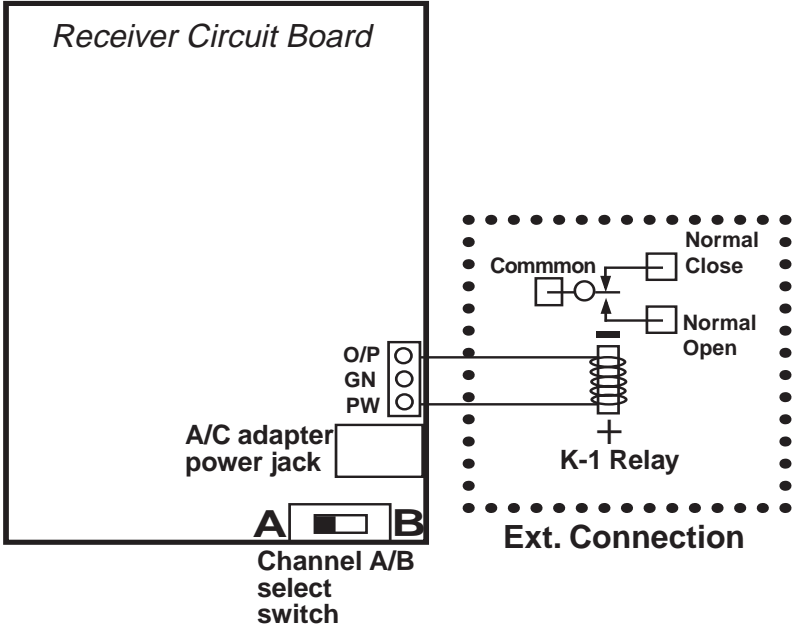

Trouble Shooting

Q. Alarm unit cannot detect underwater wave signal

- ★ Check the unit by hitting the TEST button. If the unit does not give any beep, replace the 9V battery with a new one.
- ★ Check the headphone jack connection between the sensor tube and the alarm unit control head. Make sure it is connected properly.
- ★ Check the sensitivity setting on the bottom of the underwater sensor and the depth of the sensor into the water.

Q. The alarm unit gives frequent false alarms

- ★ Check the sensitivity setting. The sensitivity may be set too high.
- ★ The sensor can detect any water disturbance including the flow from the filter pump. Place the alarm unit away from the return, or put a deflector cap on the sensor cage.

Q. The poolside alarm unit siren cannot be turned OFF

- ★ Push and hold BOTH the green button and yellow button for 3 seconds until you hear 5 consecutive beeps.
- ★ Wait until the water settles down before you turn on the unit again.

Q. The receiver does not sound alarm immediately when the poolside alarm goes off

- ★ The transmitter makes 3 attempts in 10 seconds. If the receiver missed the first transmission because of interference, it has the 2nd and then the 3rd chance to pick up the RF alarm signal. Because of this, occasionally the receiver may experience a time delay.
- ★ Weak RF signal is more susceptible to any interference. Replace the 9V battery with a new one.

Q. The receiver cannot receive RF alarm signal.

- ★ When the blue RESET button on the front is pressed, the unit is disabled for 10 seconds. During this 10 seconds, it will not receive any RF signal. This allows you enough time to go to the poolside to turn off or reset the poolside alarm.
- ★ Check the channel A or B select. Make sure every unit is set at the same channel.
- ★ Place the receiver closer to the transmitter and at a straight line of sight. The RF signal sending out from the transmitter is directional. Placing the receiver at another location may give a better reception. Avoid any big metal object such as refrigerator, oven or washing machine etc. between them.
- ★ The transmitter has an antenna inside the control head. Rotating the control head may affect the RF signal sending out, similar to your TV antenna. Make sure the wide side of the underwater sensor remains parallel to the pool wall.

Q. The receiver alarm siren cannot be turned OFF

- ★ Press the SYSTEM RESET switch located on the back of the unit.

Q. Pool alarm sounds off when I use my pool cleaner

- ★ Your pool cleaner can create the same type of water disturbance as that created by a child falling into water. Therefore the pool alarm will be set off if you activate your automatic pool cleaner while the alarm is ON.