

SMART Board® 800i5 and 800i5-SMP

Interactive whiteboard systems

Configuration and user's guide

Read this guide on your smart phone or other mobile device.



Extraordinary made simple® | **SMART.**

FCC warning

This equipment has been tested and found to comply with the limits for a Class A digital device, pursuant to Part 15 of the FCC Rules. These limits are designed to provide reasonable protection against harmful interference when the equipment is operated in a commercial environment. This equipment generates, uses and can radiate radio frequency energy and, if not installed and used in accordance with the manufacturer's instructions, may cause harmful interference to radio communications. Operation of this equipment in a residential area is likely to cause harmful interference in which case the user will be required to correct the interference at his own expense.

Trademark notice

SMART Board, SMART GoWire, SMART Meeting Pro, DVIT, smarttech, the SMART logo and all SMART taglines are trademarks or registered trademarks of SMART Technologies ULC in the U.S. and/or other countries. Texas Instruments, BrilliantColor, DLP, and DLP Link are trademarks of Texas Instruments. Microsoft, Windows and Internet Explorer are either registered trademarks or trademarks of Microsoft Corporation in the U.S. and/or other countries. Blu-ray is a trademark of Blu-ray Disc Association. All other third-party product and company names may be trademarks of their respective owners.

Copyright notice

© 2012 SMART Technologies ULC. All rights reserved. No part of this publication may be reproduced, transmitted, transcribed, stored in a retrieval system or translated into any language in any form by any means without the prior written consent of SMART Technologies ULC. Information in this manual is subject to change without notice and does not represent a commitment on the part of SMART.

One or more of the following patents: US6320597; US6326954; US6540366; US6563491; US6741267; US6803906; US6829372; US6919880; US6954197; US7151533; US7184030; US7236162; US7411575; US7532206; US7619617; US7643006; US7692625; US7757001; US7880720; USD612396; USD616462; USD617332; USD635189; USD636183; and USD636784. Other patents pending.

01/2012

Important information

Before you install and use your SMART Board® 800i5 interactive whiteboard system, read and understand the safety warnings and precautions in this user's guide and the included warnings document. These safety warnings and precautions describe the safe and correct operation of your interactive whiteboard system and its accessories, helping you to prevent injuries and equipment damage. Ensure that your interactive whiteboard system is always being used correctly.

In this document, "interactive whiteboard system" refers to the following:

- SMART Board 800 series interactive whiteboard
- SMART UF75 or SMART UF75w projector
- Accessories and optional equipment

The projector included with your system is designed to work only with certain SMART Board interactive whiteboard models. Contact your authorized SMART reseller (smarttech.com/where) for more information.

Safety warnings, cautions and important information

Installation



WARNING

- Failure to follow the installation instructions shipped with your SMART product could result in personal injury and damage to the product.
- To reduce the risk of fire or electric shock, do not expose the SMART product to rain or moisture.

IMPORTANT INFORMATION

- Two people are required to mount your SMART product because it may be too heavy for one person to safely maneuver.

When you lift your interactive whiteboard, you and your assistant should stand on either side of the screen, supporting its weight at the bottom while balancing the top with your other hands.

- When mounting the projector boom on a framed or hollow wall, attach both the mounting bracket and the safety tether to a stud to safely support the projector's weight. If you use only drywall anchors, the drywall can fail, resulting in possible personal injury, and damage to the product which may not be covered by your warranty.
- Do not leave cables on the floor where they can be a tripping hazard. If you must run a cable over the floor, lay it in a flat, straight line and secure it to the floor with tape or a cable management strip of a contrasting color. Handle cables carefully and avoid excessive bending.

CAUTION

- Do not operate this unit immediately after moving it from a cold location to a warm location. When the unit is exposed to such a change in temperature, moisture can condense on the lens and crucial internal parts. Allow the system to stabilize to room temperature before operation to prevent possible damage to the unit.
- Do not place the unit in hot locations, such as near heating equipment. Doing so could cause a malfunction and shorten the life of the projector.
- Avoid setting up and using the SMART product in an area with excessive levels of dust, humidity and smoke.
- Do not place your SMART product in direct sunlight or near any appliance that generates a strong magnetic field.
- If you need to lean the interactive whiteboard against a wall before you mount it, make sure it remains in an upright position, resting on the pen tray brackets, which can sustain the weight of the interactive whiteboard.



Do not rest the interactive whiteboard on its side or on the top of the frame.

IMPORTANT INFORMATION

- You must connect the USB cable that came with your SMART Board interactive whiteboard to a computer that has a USB compliant interface and that bears the USB logo. In addition, the USB source computer must be compliant with CSA/UL/EN 60950 and bear the CE mark and CSA and/or UL Mark(s) for CSA/UL 60950. This is for operating safety and to avoid damage to the SMART Board interactive whiteboard.

IMPORTANT

- Use the *SMART Board 880i5 and 885i5 interactive whiteboard system installation guide* (smarttech.com/kb/154546) or *SMART Board 880i5-SMP or 885i5-SMP interactive whiteboard system installation guide* (smarttech.com/kb/170130) to install your interactive whiteboard, projector and ECP.
- Make sure an electrical socket is near your SMART product and remains easily accessible during use.
- Using your SMART product near a TV or radio could cause interference to the images or sound. If this happens, move the TV or radio away from the projector.

Operation

WARNING

- If you are using an audio system, use only the power supply included with that product. Using the wrong power supply might create a safety hazard or damage the equipment. If in doubt, refer to the specification sheet for your product to verify the power supply type.
- Do not climb (or allow children to climb) on a wall- or stand-mounted SMART Board interactive whiteboard.

Do not climb on, hang from or suspend objects from the projector boom.

Climbing on the interactive whiteboard or projector boom could result in personal injury or product damage.



- Viewing 3D content from a projector may cause epileptic seizures or strokes. If you or any member of your family has a history of light-sensitive seizures, consult a doctor before viewing 3D content.
- Viewing 3D content while you are consuming alcohol, experiencing sleep deprivation or in poor physical condition may be unsafe.
- Pregnant women and elderly individuals should avoid viewing 3D content.

IMPORTANT INFORMATION

- Viewing 3D content may cause sickness, including nausea, dizziness, headache, eyestrain, blurred vision or numbness. If you experience any of these symptoms, stop viewing 3D content immediately. If these symptoms persist, consult a doctor.
- Parents and teachers should monitor children and students for adverse effects resulting from viewing 3D content since children and teenagers may be more susceptible than adults to related health risks.
- To avoid adverse effects resulting from viewing 3D content with your interactive whiteboard system, observe the following precautions:
 - Do not use 3D glasses for viewing any material other than 3D content.
 - Maintain a minimum distance of 7' (2 m) from your interactive whiteboard system's screen. Viewing 3D content from too close a distance may result in eyestrain.
 - Avoid viewing 3D content for a prolonged period of time. Take a break of 15 minutes or longer after every hour of viewing.
 - Face the screen squarely when viewing 3D content. Viewing 3D content from an angle may cause fatigue or eyestrain.

CAUTION

- Do not block the projector's ventilation slots and openings.
- Avoid putting the projector into Standby mode during the lamp ignition phase because this can lead to premature lamp failure. Keep the projector lamp on for a minimum of 45 minutes before putting it into Standby mode to preserve the lamp life.
- In a high altitude location over 6000' (1800 m), where the air is thin and cooling efficiency is reduced, use the projector with the fan mode set to High.
- Cycling power to the projector repeatedly can lock or damage your SMART product. After you put the product into Standby mode, wait at least 45 minutes for cooling before starting the product again.
- If dust or small items prevent pen tray buttons from being pressed or cause constant button contact, remove the obstructions carefully.

IMPORTANT

- If you have peripheral devices that do not use a 4-pin mini-DIN S-video connector, an RCA Composite video jack or an HDMI video connector, or if your device has an audio connection that does not use RCA jacks, you may need to purchase third-party adapters.

IMPORTANT INFORMATION

- There are no projector menu options on the ECP. Keep your remote control in a safe place because the ECP is not a substitute for the remote control.
- Do not disconnect cables from the ECP to connect peripheral devices because you could disconnect controls for your interactive whiteboard.
- Disconnect the product from its power source when it's not used for a long period.

Cleaning

CAUTION

- Before you clean the projector, press the **Power**  button twice on the ECP or remote control to put the system in Standby mode, and then allow the lamp to cool for at least 30 minutes.
- Do not spray cleaners, solvents or compressed air near any part of the projector because they can damage or stain the unit. Spraying the system could spread a chemical mist on some of the projector's components and lamp, resulting in damage and poor image quality.
- Do not allow liquids or commercial solvents of any kind to flow into the projector.

IMPORTANT

- Put your SMART product into Standby mode before cleaning it.
- Follow these guidelines to clean the projector:
 - Wipe the exterior of the projector with a lint-free cloth.
 - If necessary, use a soft cloth moistened with a mild detergent to clean the projector housing.
 - Do not use abrasive cleaners, waxes or solvents.
 - Avoid touching the lens. If it is necessary to clean the lens:
 - Use liquids or commercial solvents (such as glass cleaners) to clean the lens, but do not spray them directly on the system.
 - Use protective gloves and dip a lint-free cloth (such as Purestat PW2004) in an anti-static solvent (such as Hyperclean EE-6310).
 - Gently wipe the lens from the center to the edge. Do not apply any pressure to the lens.

Service

WARNING

- There are no user-serviceable parts inside the pen tray. Only qualified personnel should disassemble the pen tray's printed circuit boards, and this procedure must be done with proper electrostatic discharge (ESD) protection.

CAUTION

- Do not adjust any settings in the service menu other than those listed in the following procedures. Changing other settings might damage or affect the operation of your projector and may invalidate your warranty.
- When transporting your SMART product, repack it with as much of the original packaging as possible. This packaging was designed with optimal shock and vibration protection.
- If your SMART product requires replacement parts, make sure the service technician uses replacement parts specified by SMART Technologies or parts with the same characteristics as the original.

Environmental requirements

Before you install your SMART Board 800i5 interactive whiteboard system, review the following environmental requirements.

Environmental requirement	Parameter
Operating temperature	<ul style="list-style-type: none"> 41°F to 95°F (5°C to 35°C) from 0' to 6000' (0 m to 1800 m) 41°F to 86°F (5°C to 30°C) from 6000' to 9800' (1800 m to 3000 m)
Storage temperature	<ul style="list-style-type: none"> -40°F to 122°F (-40°C to 50°C)
Humidity	<ul style="list-style-type: none"> 30% to 80% relative humidity, non-condensing
Water and fluid resistance	<ul style="list-style-type: none"> Intended for indoor use only. Doesn't meet any salt-spray or water ingress requirements. Don't pour or spray liquids directly onto your interactive whiteboard, the projector or any of its sub-components.
Dust	<ul style="list-style-type: none"> Intended for use in office and classroom environments. Not for industrial use where heavy dust and pollutants can cause malfunctions or impaired operation. Periodic cleaning is required in areas with heavier dust. See <i>Cleaning the projector</i> on page 37 for information on cleaning the projector. Designed for pollution degree 1 (P1) as per EN61558-1, which is defined as "No pollution or only dry non-conductive pollution".
Electrostatic discharge (ESD)	<ul style="list-style-type: none"> EN61000-4-2 severity level 4 for direct and indirect ESD No malfunction or damage up to 8kV (both polarities) with a 330 ohm, 150 pF probe (air discharge) Unmated connectors meet no malfunction or damage up to 4kV (both polarities) for direct (contact) discharge
Cables	<ul style="list-style-type: none"> All SMART Board 800i5 interactive whiteboard system cables should be shielded to prevent potential accidents and degraded video and audio quality.
Conducted and radiated emissions	<ul style="list-style-type: none"> EN55022/CISPR 22, Class A

Contents

Important information	i
Safety warnings, cautions and important information.....	i
Environmental requirements.....	vii
Chapter 1: About your interactive whiteboard system	1
SMART Board 800i5 interactive whiteboard system features.....	2
Included accessories.....	4
Optional accessories.....	6
Chapter 2: Installing your interactive whiteboard system	7
Choosing a location.....	7
Choosing a height.....	8
Securing your interactive whiteboard system.....	9
Routing the cables.....	9
Installing SMART software.....	10
Chapter 3: Using your interactive whiteboard system	11
Using your projector.....	11
Using your interactive whiteboard.....	24
Using the Extended Control Panel (ECP).....	24
Using the RCA connector pod.....	26
Using the SMART GoWire cable.....	27
Chapter 4: Integrating other devices	29
Video format compatibility.....	29
Connecting peripheral sources and outputs.....	34
Chapter 5: Maintaining your interactive whiteboard system	37
Maintaining your interactive whiteboard.....	37
Cleaning the projector.....	37
Focusing and adjusting the projector image.....	38
Replacing the projector lamp.....	39
Chapter 6: Troubleshooting your interactive whiteboard system	45
Before you start.....	46
Determining you interactive whiteboard system's status.....	48
Resolving interactive whiteboard issues.....	49
Resolving projector issues.....	50
Resolving ECP issues.....	57

CONTENTS

Accessing the service menu	57
Transporting your interactive whiteboard system	59
Appendix A: Remotely managing your system through a network interface.....	61
Web page management	61
Simple Network Management Protocol (SNMP).....	69
Appendix B: Remotely managing your system through an RS-232 serial interface.....	71
Connecting your room control system to the ECP.....	71
Projector programming commands.....	73
Appendix C: Remote control code definitions.....	85
Appendix D: Hardware environmental compliance.....	87
Waste Electrical and Electronic Equipment regulations (WEEE directive).....	87
Restriction of Certain Hazardous Substances (RoHS directive).....	87
Batteries.....	87
Packaging.....	88
China's Electronic Information Products regulations.....	88
Index.....	89

Chapter 1

About your interactive whiteboard system

SMART Board 800i5 interactive whiteboard system features.....	2
SMART Board 800 series interactive whiteboard.....	2
SMART UF75 or SMART UF75w projector.....	3
Extended Control Panel (ECP).....	4
Included accessories.....	4
Remote control.....	4
Pens.....	4
Eraser.....	5
VGA connection kit.....	5
SMART Board 800i5 interactive whiteboard system accessories.....	5
RCA connector pod.....	5
SMART Board 800i5-SMP interactive whiteboard system accessories.....	5
SMART GoWire™ auto-launch cable.....	5
CAT 5 USB extender.....	6
Optional accessories.....	6

Your SMART Board 800i5 interactive whiteboard system combines the following components:

- SMART Board 800 series interactive whiteboard
- Wall-mounted, short-throw SMART UF75 or SMART UF75w projector
- Accessories and optional equipment

This chapter describes the features of your interactive whiteboard and provides information about product parts and accessories.

CHAPTER 1

About your interactive whiteboard system

SMART Board 800i5 interactive whiteboard system features

Your SMART Board 800i5 interactive whiteboard system uses the short-throw, high-offset SMART UF75 or SMART UF75w projector. The throw distance of the SMART UF75 or SMART UF75w projectors is half that of the SMART UF65 projector, resulting in a shorter boom and reduced shadows on the projected image.

When the projector displays an image from your computer on the touch-sensitive interactive whiteboard, you can do everything that you can do at your computer—open and close applications, scroll through files, conference with others, create new documents or edit existing ones, visit websites, play video clips and more—by touching the screen. Two users can also draw on the interactive surface at the same time, and you can use an array of gestures within applications.

This projector also supports video and audio connections from a variety of devices, including DVD/Blu-ray™ players, VCRs, document cameras and digital cameras, and can project media from these sources onto the interactive screen.

When you use SMART software with your SMART Board 800i5 interactive whiteboard system, you can write or draw over the projected computer image in digital ink using a pen tray pen or your finger, and then save these notes to a .notebook file or directly into any Ink Aware application.

SMART Board 800 series interactive whiteboard

Your SMART Board 800 series interactive whiteboard, featuring SMART's proprietary DVIT® (Digital Vision Touch) technology, is the most intuitive touch-sensitive front projection interactive whiteboard in the world.

The SMART Board 800 series interactive whiteboard performs best with the SMART UF75 or SMART UF75w projector because of its exceptional color performance and input response.

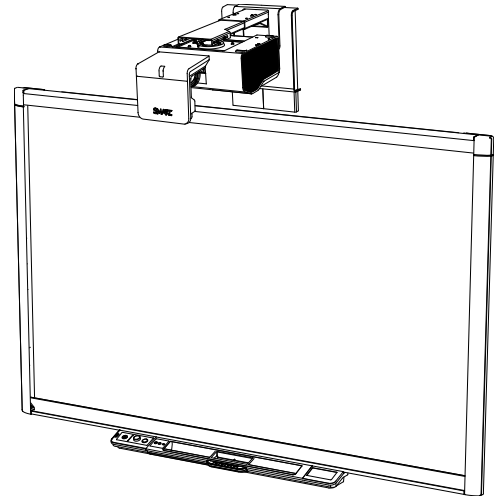

CHAPTER 1

About your interactive whiteboard system

Other features of your interactive whiteboard include:

- A modular pen tray that automatically detects when you pick up a pen tray pen or the eraser
- Pen tray buttons that activate the pens' colors and the on-screen keyboard, right-click, Orientation and Help functions
- A durable hard-coated surface that is optimized for projection and easily cleaned
- A security cable lock feature that enables you to lock your interactive whiteboard to help safeguard it from theft

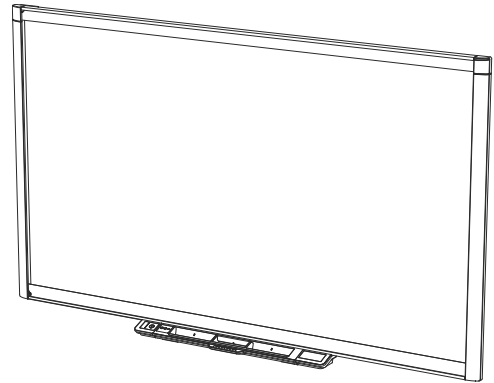

For more information about your SMART Board interactive whiteboard, see the *SMART Board 800 series interactive whiteboard user's guide* (smarttech.com/kb/144817).

SMART UF75 or SMART UF75w projector

The SMART UF75 or SMART UF75w projector system includes a short-throw projector for use with SMART Board interactive whiteboards and a sturdy support system suitable for many different environments.

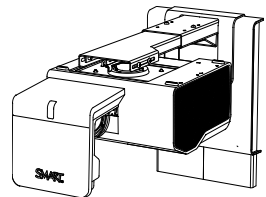

Other features of your projector system include:

- A wall-mounted, high-offset projector engine that uses DLP® technology by Texas Instruments™, providing BrilliantColor™ performance and Gamma 2.2 correction with SMART Presentation, Bright Room, Dark Room, sRGB and User modes
- PAL, PAL-N, PAL-M, SECAM, NTSC, and NTSC 4.43 video system compatibility
- HDMI, Composite, S-video, and VESA® RGB video inputs with additional interface support for Component YPbPr and Component YCbCr inputs with the proper adapters (not included)
- WXGA, QVGA, VGA, SVGA, XGA, SXGA, SXGA+ and UXGA video format compatibility
- Native 1024 × 768 resolution (SMART UF75 projector)
OR
Native 1280 × 800 resolution (SMART UF75w projector in 16:10 aspect ratio mode)
OR
Native 1280 × 720 resolution (SMART UF75w projector in 16:9 aspect ratio mode)
- Remote management via a serial RS-232 interface, web page or SNMP

CHAPTER 1

About your interactive whiteboard system

- An alert broadcast feature that enables administrators to send notification messages to network-connected projector systems for immediate on-screen display
- DLP Link™ technology that ensures compatibility with the emerging 3D content ecosystem
- Protected cable routing through a cable cover that limits tampering and clutter
- A secure mounting and installation system that includes the following:
 - An optional projector padlock ring to prevent removal of the projector from the boom
 - Mounting hardware for solid masonry or framed wall installations, as well as a safety tether
 - Templates and instructions for positioning the system safely

Extended Control Panel (ECP)

Your projector system ECP attaches to the interactive whiteboard pen tray. The ECP features controls for power, source selection and volume adjustment, as well as a USB A receptacle for USB drives.

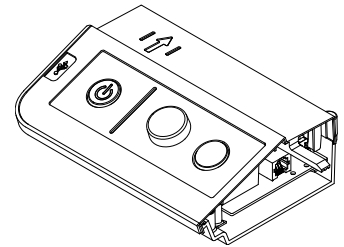

Included accessories

The following accessories are included with your interactive whiteboard system.

Remote control

The remote control enables you to control the system and set up your projector. Use the remote control to access menu options, system information and input selection options.

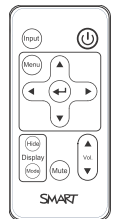

Pens

There are two pens included with your interactive whiteboard. Pick up a pen and press one of the four color buttons on the pen tray (black, red, green or blue) to select the color of digital ink you write on the interactive whiteboard.

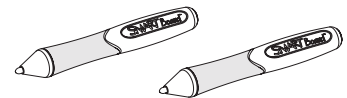

IMPORTANT

Do not substitute the pens with other items, such as dry-erase markers, if Touch Recognition is enabled. (Touch Recognition enables you to pick up a pen tray pen, and then write, select or erase without replacing the pen.)

CHAPTER 1

About your interactive whiteboard system

Eraser

The eraser resembles a rectangular chalkboard eraser. You can use a substitute object, as long as it has a similar shape, reflects infrared light and doesn't scratch or mark the interactive whiteboard surface.

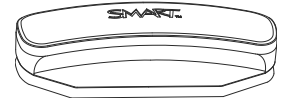

VGA connection kit

The VGA connection kit allows you to connect a laptop to your interactive whiteboard system using a VGA cable. The end of the VGA connection kit can be attached to either side of the interactive whiteboard or to a wall in a convenient location.

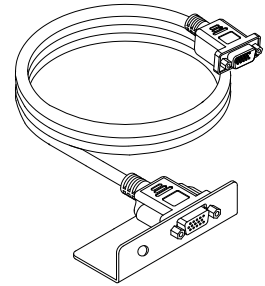

SMART Board 800i5 interactive whiteboard system accessories

The following accessory is included with SMART Board 800i5 interactive whiteboard systems.

RCA connector pod

The RCA connector pod includes two RCA jacks for dual-channel audio input and one for composite video input. You can use the RCA connector pod to connect DVD/Blu-ray players and similar devices (see *Connecting peripheral sources and outputs* on page 34).

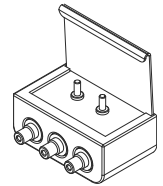

SMART Board 800i5-SMP interactive whiteboard system accessories

The following accessories are included with SMART Board 800i5-SMP interactive whiteboard systems.

SMART GoWire™ auto-launch cable

The SMART GoWire cable is a USB to USB connection that enables you to use SMART Meeting Pro™ software on computers where the software is not installed.

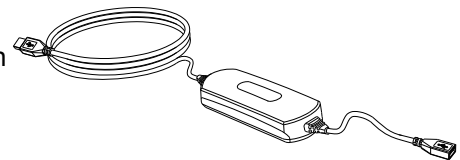

IMPORTANT

The SMART Meeting Pro software on the cable is compatible with only Windows® operating systems.

Ensure that Autoplay is enabled on your computer before you connect the cable. See the SMART Support website (smarttech.com/support) for additional information.

CHAPTER 1

About your interactive whiteboard system

If you are using a laptop that doesn't have SMART Meeting Pro software installed, connect the laptop to the interactive whiteboard using your SMART GoWire cable. The SMART Meeting Pro icon  appears in the notification area on your laptop once you connect the cable.

CAT 5 USB extender

The CAT 5 USB extender (Part No. SBX8-CAT5-XT) enables you to connect your interactive whiteboard to a computer up to 50' (15 m) away using a Cat 5, Cat 5e or Cat 6 cable (not included).

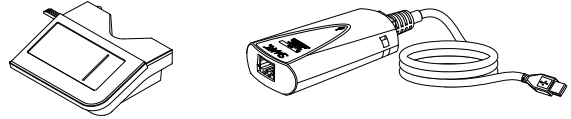

Optional accessories

You can add a variety of accessories to your interactive whiteboard to best meet your specific needs. Purchase these items from your authorized SMART reseller when you order your interactive whiteboard system or later.

For more information on accessories, go to smarttech.com/accessories.

Chapter 2

Installing your interactive whiteboard system

Choosing a location	7
Choosing a height	8
Securing your interactive whiteboard system	9
Locking the pen tray to your interactive whiteboard	9
Securing the projector to the boom	9
Routing the cables	9
Installing SMART software	10

Consult the SMART Board 880i5 interactive whiteboard system installation document included with your product for instructions on how to install your product.

IMPORTANT

Use the *SMART Board 880i5 and 885i5 interactive whiteboard system installation guide* (smarttech.com/kb/154546) or *SMART Board 880i5-SMP or 885i5-SMP interactive whiteboard system installation guide* (smarttech.com/kb/170130) to install your interactive whiteboard, projector and ECP.

This chapter provides additional considerations and details for installing your interactive whiteboard system.

Choosing a location

Choose a location for your interactive whiteboard system that's far from bright light sources, such as windows and strong overhead lighting. Bright light sources can cause distracting shadows on your interactive whiteboard and can reduce the contrast of the projected image.

Select a wall with a flat, regular surface and sufficient clearance to accommodate your interactive whiteboard system. Install the projector and your interactive whiteboard on the same flat surface. For

CHAPTER 2

Installing your interactive whiteboard system

best presentation alignment, mount your interactive whiteboard system in a location that's central to your audience's viewing direction.

For mobile or adjustable installation options, contact your authorized SMART reseller.

WARNING

- Refer to your interactive whiteboard system's specifications (available at smarttech.com/support) for its weight. Check your local building codes to ensure that your wall can support this weight, and use appropriate mounting hardware for your wall type.
- If you are installing the interactive whiteboard system on drywall, use all the included toggle bolts. If one of the bracket holes aligns with a wall stud, use appropriate hardware in that hole instead of a toggle bolt.
- When mounting the projector boom on a framed or hollow wall, attach both the mounting bracket and the safety tether to a stud to safely support the projector's weight. If you use only drywall anchors, the drywall can fail, resulting in possible personal injury, and damage to the product which may not be covered by your warranty.

If you're replacing a SMART Board 500 or 600 series interactive whiteboard with the SMART Board 800 series interactive whiteboard on drywall, you must remove the wall-mount bracket and mounting hardware, and then install all the mounting hardware and brackets supplied with your SMART Board 800 series interactive whiteboard instead.

To help ensure that your interactive whiteboard is mounted correctly, make sure the colors of the wall-mount hanger on the back of the interactive whiteboard and the wall-mount bracket are the same.

Choosing a height

SMART includes a mounting template with each interactive whiteboard system. If you lose this template, contact your authorized SMART reseller. Using this template ensures that you can do the following:

- Mount the projector at a safe height for head space clearance, while maintaining enough space for airflow and installation access above the unit.
- Position the projector at the correct height above your interactive whiteboard to align the projected image with the touch screen.

Dimensions on the template recommend a distance from the floor suitable for adults of average height. You should consider the general height of your user community when you choose a position for your interactive whiteboard.

CHAPTER 2

Installing your interactive whiteboard system

Securing your interactive whiteboard system

This section explains how to secure the different components of your interactive whiteboard system.

Locking the pen tray to your interactive whiteboard

To learn how to lock the pen tray to your interactive whiteboard, see the *SMART Board 800 series interactive whiteboard user's guide* (smarttech.com/kb/144817).

Securing the projector to the boom

To learn how to secure the SMART UF75 or SMART UF75w projector to the boom, see the included *SMART Board 880i5 and 885i5 interactive whiteboard system installation guide*

(smarttech.com/kb/154546) or *SMART Board 880i5-SMP or 885i5-SMP interactive whiteboard system installation guide* (smarttech.com/kb/170130).

Routing the cables

When connecting cables from your SMART UF75 projector to your interactive whiteboard system, make sure that all cables pass along the top of the interactive whiteboard wall-mounting bracket and then down the side of the interactive whiteboard.

When connecting cables from a SMART UF75w projector to the interactive whiteboard, make sure that all cables pass between the two interactive whiteboard wall-mounting brackets. Space your wall-mounting brackets 4" (10.2 cm) apart to provide full support for the weight of your interactive whiteboard.

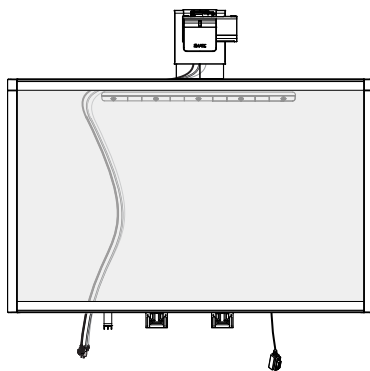

Cable routing for SMART Board 880 interactive whiteboards

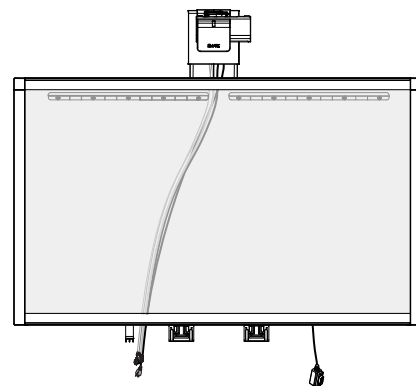

Cable routing for SMART Board 885 interactive whiteboards

CHAPTER 2

Installing your interactive whiteboard system



IMPORTANT

Do not connect the power cable to a power outlet until you have connected all the cables to the projector and ECP.

Installing SMART software

You must install SMART software on the computer connected to your interactive whiteboard system to access all of its features.

Download SMART software from smarttech.com/software. These pages list the minimum hardware requirements for each software version. If SMART software is already installed on your computer, take this opportunity to upgrade your software to ensure compatibility.

Chapter 3

Using your interactive whiteboard system

Using your projector.....	11
Using your remote control.....	11
Replacing the remote control battery.....	12
Using the remote control buttons.....	13
Adjusting projector settings.....	14
Focusing the image.....	21
Adjusting the image.....	22
Projector connection diagram.....	22
Using your interactive whiteboard.....	24
Using the Extended Control Panel (ECP).....	24
Using the RCA connector pod.....	26
Using the SMART GoWire cable.....	27

This chapter describes the basic operation of your interactive whiteboard system and explains how to set up your remote control, retrieve system information, access the projector's image adjustment options and integrate your interactive whiteboard system with peripheral devices.

Using your projector

This section explains how to use your projector and its included remote control.

Using your remote control

The projector remote control enables you to access on-screen projector menus and change projector settings.

CHAPTER 3

Using your interactive whiteboard system

Replacing the remote control battery

Follow this procedure to replace the remote control battery.

WARNING

- Reduce the risk associated with a leaking battery in the projector's remote control by following these practices:
 - Use only the specified type of coin-cell battery.
 - Orient the battery's positive (+) and negative (-) terminals according to the markings on the remote control.
 - Remove the battery when the remote control is unused for an extended period.
 - Do not heat, disassemble, short or recharge the battery, or expose it to fire or high temperatures.
 - Avoid eye and skin contact with the battery if it has a leak.
- Dispose of the exhausted battery and product components in accordance with applicable regulations.

To replace the remote control battery

1. Hold down the side release on the left side of the battery holder and pull the battery holder completely out of the remote control.

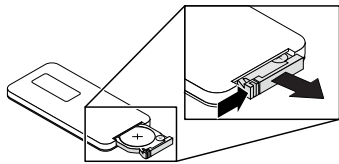

2. Remove the old battery from the battery holder and replace it with a CR2025 coin-cell battery.

IMPORTANT

Align the positive (+) and negative (-) signs on the battery terminals with the correct signs on the battery holder.

3. Insert the battery holder into the remote control.

CHAPTER 3

Using your interactive whiteboard system

Using the remote control buttons

The projector remote control enables you to access on-screen menus and change projector settings. Use the **Power**  button on the remote control or ECP to put the projector into Standby mode or to turn it on. You can also use the **Input** button on the remote control or ECP to switch sources on the projector.

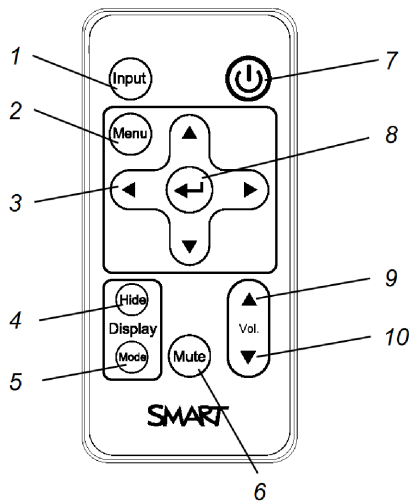

Number	Function	Description
1	Input	Select a video and audio input source.
2	Menu	Show or hide the projector menus.
3	◀ (Left), ▶ (Right), ▲ (Up) and ▼ (Down) arrows	Change the menu selections and adjustments.
4	Hide	Freeze, hide or display the image: <ul style="list-style-type: none">• Press once to freeze the image. For example, you can display a question on the screen while you check your e-mail.• Press again to hide the image, that is, to display a black screen.• Press again to return to the live image.
5	Mode	Select a display mode.
6	Mute	Mute audio amplification.
7	 (Power)	Turn on the projector or put it into Standby mode.
8	↵ (Enter)	Accept the selected mode or option.
9	▲ (Volume Up)	Increase audio amplification volume.
10	▼ (Volume Down)	Decrease audio amplification volume.

i NOTE

The **Mute**, **Volume Up** and **Volume Down** buttons work only if there is an audio source and speaker system connected to the projector for the currently selected input source.

Adjusting projector settings

The remote control's **Menu** button enables you to access the on-screen display to adjust the projector settings.

🔑 IMPORTANT

There are no projector menu options on the ECP. Keep your remote control in a safe place because the ECP is not a substitute for the remote control.

Setting	Use	Notes
 Image Adjustment menu		
Display Mode	Indicates the projector's display output (SMART Presentation , Bright Room , Dark Room , sRGB and User).	The default is SMART Presentation .
Brightness	Adjusts projector brightness from 0 to 100.	The default is 50.
Contrast	Adjusts the difference between the lightest and darkest parts of the image from 0 to 100.	The default is 50.
Frequency	Adjusts the display data frequency of the projected image from -5 to 5 to match the frequency of your computer's graphics card.	The default is 0. This setting applies to VGA inputs only.
Tracking	Synchronizes your projector's display timing with your computer's graphics card from 0 to 63.	This setting applies to VGA inputs only.
H-position	Moves the horizontal position of the source video left or right from 0 to 100 (relative to the projected image).	Don't adjust this setting unless you're advised to by SMART Support. Apply this setting only after you make all boom adjustments. This setting applies to VGA inputs only and is useful in situations where the source video is cut off.

CHAPTER 3

Using your interactive whiteboard system

Setting	Use	Notes
V-position	Moves the vertical position of the source video up or down from -5 to 5 (relative to the projected image).	Don't adjust this setting unless you're advised to by SMART Support. Apply this setting only after you make all boom adjustments. This setting applies to VGA inputs only and is useful in situations where the source video is cut off.
Saturation	Adjusts the projected image's color saturation from 0 to 100.	This setting applies to S-video and Composite video inputs only.
Sharpness	Adjusts the projected image's sharpness from 0 to 31.	This setting applies to S-video and Composite video inputs only.
Tint	Adjusts the image color balance of red and green from 0 to 100.	This setting applies to S-video and Composite video inputs only.
White Peaking	Adjusts the image color brightness from 0 to 10 while providing more vibrant white shades.	A value closer to 0 creates a natural image and a value closer to 10 enhances brightness.
Degamma	Adjusts the color performance of the display from 0 to 3.	
Color	Adjusts the Red, Green, Blue, Cyan, Magenta and Yellow colors on the projector from 0 to 100 to provide custom color and luminance output.	Each color has a default value of 100. Adjustments to the color settings register under the User mode.
 Audio menu		
Volume	Adjusts the projector's volume amplification from -20 to 20.	The default is 0.
Mute	Mutes the projector's audio output.	The default is off. If you mute the projector's audio output and then increase or decrease the volume, the volume is restored automatically. You can prevent this from happening by disabling the volume control.
Disable Volume Control	Disables the projector's volume control and the ECP's volume control knob.	
Closed Captioning	Turns closed captioning on or off for video sources that support closed captioning.	
Closed Captioning Language	Sets the closed captioning language to CC1 or CC2 .	Typically, CC1 displays U.S. English subtitles, while CC2 displays other regional languages, such as French or Spanish, depending on television channel or media setup.

CHAPTER 3

Using your interactive whiteboard system

Setting	Use	Notes
 Projector Functions menu		
3D On/Off	Turns the DLP Link technology 3D feature on or off.	The default is off.
3D Format	Displays the current 3D format (Interleaved or Under-over).	Interleaved breaks down the image frame for each eye, alternately displaying a line of visual information from each frame. Under-over concurrently displays horizontally stretched image frames for each eye, one above the other.
3D Invert Left-Right	Selects the 3D Invert setting (L-R or R-L).	L-R displays visual data for the left eye first. R-L displays visual data for the right eye first.
Auto Signal Detect	Enables or disables signal searching of input connectors.	The default is off. Select On to have the projector continuously switch inputs until it finds an active video source. Select Off to maintain signal detection in one input.
Lamp Reminder	Turns the lamp replacement reminder on or off.	This reminder appears 100 hours before the recommended lamp replacement.
Lamp Mode	Adjusts lamp brightness to Standard or Economy .	Standard displays a high-quality, bright image. Economy increases the lamp life by decreasing the brightness of the image.
Auto Power Off (minutes)	Sets the length of the auto power-off countdown timer between 1 and 240 minutes.	The default is 120 minutes. The timer begins to count down when the projector no longer receives a video signal. The timer finishes when the projector enters Standby mode. Select 0 to turn off the timer.
Zoom	Adjusts the zoom to the center of the image in or out from 0 to 30.	The default is 0. Zooming in cuts off the outer edges of the source video.
Projector ID	Sets the projector's unique ID number (from 0 to 99) within your organization's network.	You can refer to this number when using the network remote management feature (see <i>Remotely managing your system through a network interface</i> on page 61).

CHAPTER 3

Using your interactive whiteboard system

Setting	Use	Notes
Aspect Ratio	Adjusts the image output to Fill Screen , Match Input or 16:9 .	<p>The default is Fill Screen.</p> <p>Fill Screen produces an image that fills the entire screen by stretching and scaling the source video to match the projector's native resolution and aspect ratio.</p> <p>Match Input displays the source video in its native resolution and aspect ratio. As a result, unused space could appear along the top and bottom edges of the screen (letterbox format) or along the left and right edges of the screen (pillarbox format).</p> <p>16:9 displays the source video in 16:9 aspect ratio. As a result, unused space appears along the top and bottom edges of the screen. This is recommended for use with HDTV and DVD/Blu-ray discs enhanced for wide-screen televisions.</p> <p>See <i>Video format compatibility</i> on page 29 for descriptions of each mode.</p>
Startup Screen	Selects the type of startup screen (SMART , Capture User Startup Screen or Preview Startup Screen).	<p>This screen displays when the projector lamp is starting and a video source signal isn't displayed.</p> <p>SMART displays the default SMART logo on a blue background.</p> <p>Capture User Startup Screen closes the on-screen display menu and captures the entire projected image. The captured image is displayed the next time the on-screen display opens. (The capture can take up to one minute, depending on the complexity of the background graphic.)</p> <p>Preview Startup Screen enables you to preview the default or captured startup screen.</p>

CHAPTER 3

Using your interactive whiteboard system

Setting	Use	Notes
Set to Default?	Resets projector settings to their default values.	If you select Yes , all projector settings reset to their defaults, reversing any menu changes you made. This action is irreversible. Don't adjust this setting unless you want to reset all of the applied settings, or unless you're advised to by a SMART Support specialist.
USB1 Source	Enables touch for the selected video source (VGA-1 , VGA-2 , HDMI or Disabled) by associating the video source with the room computer USB receptacle (USB1) on the ECP.	The default is VGA-1 . When the user switches to the video source you select in this setting, the interactive whiteboard recognizes touch from the device connected to the room computer USB receptacle on the ECP. Selecting Disabled disables the room computer USB receptacle on the ECP.
USB2 Source	Enables touch for the selected video source (VGA-1 , VGA-2 , HDMI or Disabled) by associating the video source with the laptop USB receptacle (USB2) on the ECP.	The default is VGA-2 . When the user switches to the video source you select in this setting, the interactive whiteboard recognizes touch from the device connected to the laptop USB receptacle on the ECP. Selecting Disabled disables the laptop USB receptacle on the ECP.
Native DLP Resolution	Selects 16:10 or 16:9 .	The default is 16:10 , which is the correct setting for SMART Board 885 interactive whiteboards. This option is only available on SMART UF75w projectors with DDP firmware version 0.0.2.1 or later. When you select 16:10 , the projector's native resolution is 1280 × 800. When you select 16:9 , the projector's native resolution is 1280 × 720.
 Network menu		
Network and VGA Out	Activates the projector's VGA Out and RJ45 connector and network features.	
Status	Displays the current network status (Connected , Disconnected or Off).	The default is off.

CHAPTER 3

Using your interactive whiteboard system

Setting	Use	Notes
DHCP	Displays the status of the network's Dynamic Host Configuration Protocol (DHCP) as On or Off .	The default is on. On enables a DHCP server on the network to automatically assign an IP address to the projector. Off enables an administrator to assign an IP address manually.
Password Reminder	E-mails the network password to the predefined e-mail recipient.	See <i>Web page management</i> on page 61 to set up a destination e-mail address.
IP Address	Displays the projector's current IP address in values between 0.0.0.0 and 255.255.255.255.	To change the projector's IP address, use the RS-232 connector (see <i>Network controls</i> on page 80) or use a DHCP server to assign a dynamic IP address, and then set a static IP address using the network remote management feature (see <i>Remotely managing your system through a network interface</i> on page 61).
Subnet Mask	Displays the projector's subnet mask number in values between 0.0.0.0 and 255.255.255.255.	
Gateway	Displays the projector's default network gateway in values between 0.0.0.0 and 255.255.255.255.	
DNS	Displays the projector's primary domain name number in values between 0.0.0.0 and 255.255.255.255.	
MAC Address	Displays the projector's MAC address in xx-xx-xx-xx-xx-xx format.	
Group Name	Displays the projector's workgroup name as set by an administrator (maximum 12 characters).	You can set the projector's workgroup name using the remote management features (see <i>Remotely managing your system through a network interface</i> on page 61 and <i>Remotely managing your system through an RS-232 serial interface</i> on page 71).
Projector Name	Displays the projector's name as set by an administrator (maximum 12 characters).	You can set the projector's name using the remote management features (see <i>Remotely managing your system through a network interface</i> on page 61 and <i>Remotely managing your system through an RS-232 serial interface</i> on page 71).

CHAPTER 3

Using your interactive whiteboard system

Setting	Use	Notes
Location	Displays the projector's location as set by an administrator (maximum 16 characters).	You can set the projector's location using the remote management features (see <i>Remotely managing your system through a network interface</i> on page 61 and <i>Remotely managing your system through an RS-232 serial interface</i> on page 71).
Contact	Displays the contact name or number for projector support as set by an administrator (maximum 16 characters).	You can set the contact name or number using the remote management features (see <i>Remotely managing your system through a network interface</i> on page 61 and <i>Remotely managing your system through an RS-232 serial interface</i> on page 71).
 Language menu		
Language	Selects language preference.	Projector menu support is available in English (default), Chinese (Simplified), Chinese (Traditional), Czech, Danish, Dutch, Finnish, French, German, Greek, Italian, Japanese, Korean, Norwegian, Polish, Portuguese (Brazil), Portuguese (Portugal), Russian, Spanish and Swedish.
 Information menu		
Lamp Hours	Displays the current number of lamp usage hours from 0 to 4000 hours from when it was last reset.	Always reset the lamp hours after you replace a lamp, because lamp service reminders are based on the current hours of use. See <i>Resetting the lamp hours</i> on page 43 for details on the lamp hours reset procedure.
Input	Displays the currently displayed video input source (VGA-1 , VGA-2 , Composite , S-Video , HDMI or None).	
Resolution	Displays the projector's most recently detected video source signal resolution and refresh rate.	If there is no current video input source signal, this setting displays the last known source signal image resolution and refresh rate.
Firmware Version	Displays the projector's digital display processor (DDP) firmware version in x.x.x.x format.	

CHAPTER 3

Using your interactive whiteboard system

Setting	Use	Notes
MPU Version	Displays the projector microprocessor unit (MPU) firmware version in x.x.x.x format.	
Network Version	Displays the projector's network communications processor firmware version in x.x.x.x format.	If you haven't enabled the Network and VGA Out setting, this setting is unable to display the projector's network communications processor firmware version and displays 0.0.0.0 instead.
Model Number	Displays the projector's model number.	
Serial Number	Displays the projector's serial number.	

Focusing the image

Use the focus lever located on the projector lens to focus the projected image.

To focus the image

Move the focus lever up or down until the image is in focus.

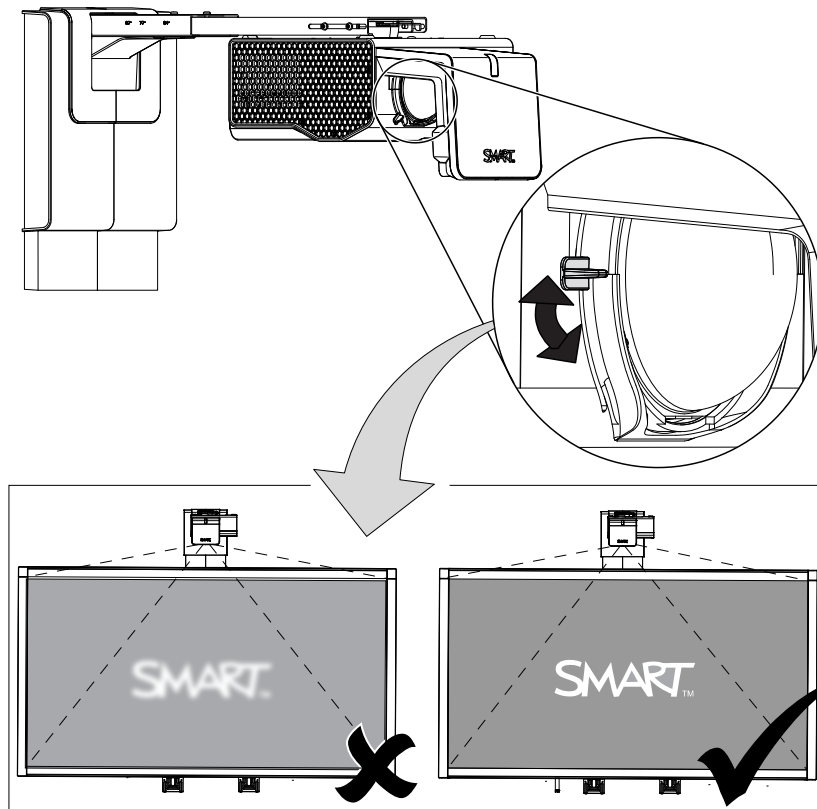

CHAPTER 3

Using your interactive whiteboard system

Adjusting the image

Refer to these notes when adjusting the projected image as described in the included *SMART Board 880i5 and 885i5 interactive whiteboard system installation guide* (smarttech.com/kb/154546) or *SMART Board 880i5-SMP or 885i5-SMP interactive whiteboard system installation guide* (smarttech.com/kb/170130).

- While adjusting the projected image size, shape and location, use the projector's default background so that you can see the full projected image clearly. Don't use other images, which might be cropped or scaled by the projector and could result in a misleading projected image size, shape and location.
- Use the mechanical adjustments described in the installation document to make all physical image adjustments. Don't use the projector's on-screen menu options during the projector alignment process.
- Be aware that as you tilt the projector up or lower its mounting boom to raise the image, the entire projected image increases or decreases in size, especially at the bottom of the projected image.
- When adjusting keystone (tilt), ensure that the top and bottom edges of the image are horizontal before you position the left and right edges of the image relative to your interactive whiteboard.
- When you move the projector forward or backward on the boom to make the image larger or smaller, you might need to tilt or turn the projector slightly to keep the image square. Loosen the lever slightly to aid in this adjustment.
- To fine-tune the image, you might need to repeat all steps described in the installation document in smaller increments.

Projector connection diagram

You can connect a variety of peripheral devices to your projector, including DVD/Blu-ray players, VCRs, document cameras, digital cameras and high-definition sources, as well as peripheral device outputs, such as a secondary projector or a flat-panel display and powered speakers.

i NOTE

You might need to purchase third-party adapters to connect certain peripheral devices.

CHAPTER 3

Using your interactive whiteboard system

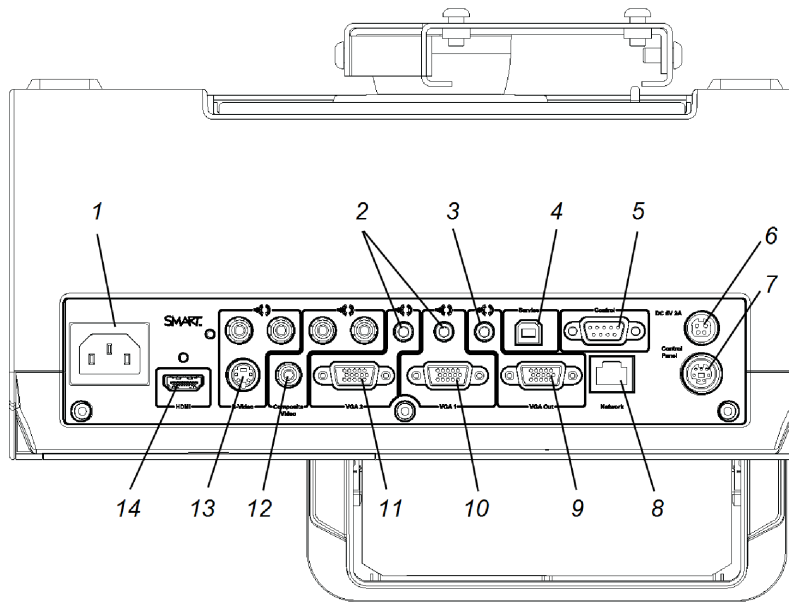

No.	Connector	Connect to:
1	Power	Mains power supply
2	3.5 mm phone jack audio input (×2)	Audio sources associated with primary and secondary computers
3	3.5 mm phone jack audio output	Speakers (not included)
4	USB B	Computer (for service access only)
5	DB9 RS-232F	ECP cable harness
6	4-pin power mini-DIN 5V/2A output	ECP cable harness
7	7-pin mini-DIN	ECP cable harness
8	RJ45	Network (for web page management and SNMP access)
9	DB15F RGB video output (VGA Out)	Secondary display (not included)
10	DB15F RGB video input (VGA 1)	Primary computer (not included)
11	DB15F RGB video input (VGA 2)	Secondary computer (not included) through VGA connection kit
12	RCA Composite video input (and left and right RCA audio input)	Video source (not included) through RCA connector pod
13	4-pin mini-DIN S-video input (and left and right RCA audio input)	Video source (not included)
14	HDMI input	High-definition video source (not included)

i NOTES

- To connect your interactive whiteboard, see the *SMART Board 880i5 and 885i5 interactive whiteboard system installation guide* (smarttech.com/kb/154546) or *SMART Board 880i5-SMP or 885i5-SMP interactive whiteboard system installation guide* (smarttech.com/kb/170130).
- To connect accessories to your interactive whiteboard, refer to the documents included with the accessories and consult the SMART Support website (smarttech.com/support) for additional information.

Using your interactive whiteboard

Refer to the *SMART Board 800 series interactive whiteboard user's guide* (smarttech.com/kb/144817) for more information on using your interactive whiteboard.

When you connect your SMART Board interactive whiteboard to a computer with SMART software, you can access the full capabilities of your interactive whiteboard.

For more information on this software, press the **Help** button on your interactive whiteboard pen tray.

For additional resources, go to smarttech.com, click the flag icon to the right of the SMART logo, and then select your country and language. In the Support section of this website, you'll find up-to-date, product-specific information, including setup instructions and specifications. The SMART Learning Space (learningspace.smarttech.com) also has free learning resources, hands-on lessons and information on how to get more training.

Using the Extended Control Panel (ECP)

The ECP gives you control of the basic operations of your interactive whiteboard system. Press the **Power**  button on the ECP or remote control to put the projector system into Standby mode or turn it on. Press the **Input** button on the ECP or remote control to switch sources on the projector.

👉 IMPORTANT



- There are no projector menu options on the ECP. Keep your remote control in a safe place because the ECP is not a substitute for the remote control.
- Do not disconnect cables from the ECP to connect peripheral devices because you could disconnect controls for your interactive whiteboard.

CHAPTER 3

Using your interactive whiteboard system

i NOTE

Low Power mode reduces your interactive whiteboard system's power consumption when it is in Standby mode.

To set the projector system to enter Low Power mode automatically whenever it enters Standby mode, hold down the **Power**  and **Input** buttons at the same time for five seconds. After five seconds, the **Power**  button blinks amber for two seconds to indicate that Low Power mode is enabled.

The following diagram and table describe the components of the ECP.

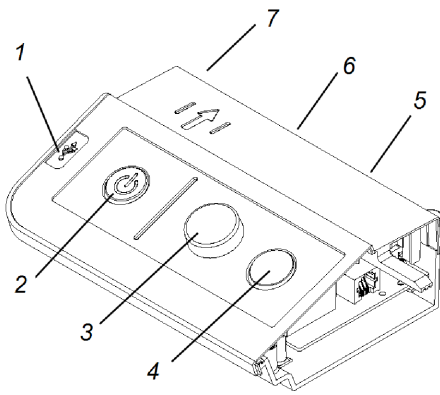

Number	Function
Left side	
1	USB A receptacle (for USB drives)
Front	
2	Power  button and status indicator light
3	Volume control
4	Input selection
Back	
5	Two mini USB B receptacles (connect to room computer and laptop)
6	11-pin connector (connects to ECP cable harness)
7	4-pin connector (for room control)

i NOTE

USB drives that you connect to this receptacle are only accessible to the room computer (the computer connected to the USB 1 receptacle).

CHAPTER 3

Using your interactive whiteboard system

i NOTE

Use an SBX8 series control cable (Part No. SB8-CTRL) to convert the 4-pin connector to a DB9 RS-232 connector for use with a third-party room control system. An SBX8 series control cable is included with SMART Board 800i5-SMP interactive whiteboard systems. Alternatively, you can purchase an SBX8 series control cable from your local SMART reseller.

💡 TIP

If your computer has an HDMI output, you can connect a USB cable from your computer to either of the USB B receptacles on the ECP and an HDMI cable from your computer to the HDMI connector on the projector. Associate the HDMI source with the appropriate USB receptacle (see *Adjusting projector settings* on page 14). Press the **Input** button on the ECP to switch to the HDMI input.

Using the RCA connector pod

The RCA connector pod is an optional accessory for the SMART Board 800i5 interactive whiteboard system. Purchase this item from your authorized SMART reseller.

The following diagram and table describe the components of the RCA connector pod.

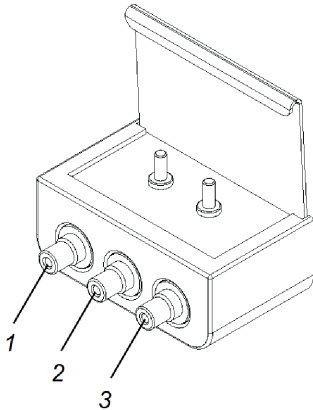

Number	Function
1	RCA composite video input jack (for peripheral devices such as a DVD/Blu-ray player)
2	RCA audio jack (right input)
3	RCA audio jack (left input)

Using the SMART GoWire cable

The SMART GoWire cable is a USB to USB connection that enables you to use SMART Meeting Pro software on computers where the application isn't installed.

NOTES

- A SMART GoWire cable is included with SMART Board 800i5-SMP interactive whiteboard systems.
- The SMART GoWire cable can only be used with Windows operating systems.

If you're using a computer that doesn't have the software installed, connect the computer to the interactive whiteboard system using the SMART GoWire cable.

The SMART Meeting Pro icon  appears in the notification area on your computer once you connect your SMART GoWire cable. Click the icon to access additional tools and to configure your hardware and software settings.

IMPORTANT

Ensure that Autoplay is enabled on your computer before you connect the auto-launch cable. Go to smarttech.com/support for more information.

For more information on SMART Meeting Pro software, search for the *SMART Meeting Pro software release notes* in smarttech.com/support.

Chapter 4

Integrating other devices

Video format compatibility.....	29
Native video format	29
Video format compatibility.....	30
SMART UF75 projector.....	30
SMART UF75w projector.....	31
HD and SD signal format compatibility.....	32
SMART UF75 projector.....	32
SMART UF75w projector.....	32
Video system signal compatibility.....	33
SMART UF75 projector.....	33
SMART UF75w projector.....	33
Connecting peripheral sources and outputs.....	34

This chapter provides information on integrating your SMART Board 800i5 interactive whiteboard system with peripheral devices.

Video format compatibility

Your projector has a native video format and various video format compatibility modes. You can change image appearances for certain formats and compatibilities.

Native video format

The following table lists the native VESA RGB video formats for the projector.

Projector	Resolution	Mode	Aspect ratio	Refresh rate (Hz)	Horizontal frequency (kHz)	Pixel clock (MHz)
SMART UF75	1024 × 768	XGA	4:3	60	48	63.5
SMART UF75w (16:10 aspect ratio mode)	1280 × 800	WXGA	16:10	60	48	83.5
SMART UF75w (16:9 aspect ratio mode)	1280 × 720	WXGA	16:9	60	48	83.5

CHAPTER 4

Integrating other devices

Video format compatibility

The following tables list the projectors' compatible VESA RGB video formats by resolution, which the projector adjusts automatically when you use the aspect ratio commands described in *Adjusting projector settings* on page 14.

SMART UF75 projector

Resolution	Mode	Aspect ratio	Refresh rate (Hz)	Match Input appearance
720 × 400	720×400_85	1.8:1	85.039	Letterbox
640 × 480	VGA 60	4:3	59.94	Full screen
640 × 480	VGA 72	4:3	72.809	Full screen
640 × 480	VGA 75	4:3	75	Full screen
640 × 480	VGA 85	4:3	85.008	Full screen
800 × 600	SVGA 56	4:3	56.25	Full screen
800 × 600	SVGA 60	4:3	60.317	Full screen
800 × 600	SVGA 72	4:3	72.188	Full screen
800 × 600	SVGA 75	4:3	75	Full screen
800 × 600	SVGA 85	4:3	85.061	Full screen
832 × 624	MAC 16"	4:3	74.55	Full screen
1024 × 768	XGA 60	4:3	60.004	Full screen
1024 × 768	XGA 70	4:3	70.069	Full screen
1024 × 768	XGA 75	4:3	75.029	Full screen
1024 × 768	XGA 85	4:3	84.997	Full screen
1024 × 768	MAC 19"	4:3	74.7	Full screen
1152 × 864	SXGA1 75	4:3	75	Full screen
1280 × 768	SXGA1 75	1.67:1	60	Letterbox
1280 × 800	WXGA	16:10	60	Letterbox
1280 × 800	WXGA	16:10	58.2	Letterbox
1280 × 960	Quad VGA 60	4:3	60	Full screen
1280 × 960	Quad VGA 85	4:3	85.002	Full screen
1280 × 1024	SXGA3 60	5:4	60.02	Letterbox
1280 × 1024	SXGA3 75	5:4	75.025	Letterbox
1280 × 1024	SXGA3 85	5:4	85.024	Letterbox
1400 × 1050	SXGA+	4:3	59.978	Full screen
1600 × 1200	UXGA	4:3	60	Full screen

CHAPTER 4

Integrating other devices

SMART UF75w projector

Resolution	Mode	Aspect ratio	Refresh rate (Hz)	Match Input appearance (16:10 aspect ratio mode)	Match Input appearance (16:9 aspect ratio mode)
720 × 400	720×400_85	9:5	85.039	Letterbox	Letterbox
640 × 480	VGA 60	4:3	59.94	Pillarbox	Pillarbox
800 × 600	VGA 72	4:3	72.809	Pillarbox	Pillarbox
800 × 600	VGA 75	4:3	75	Pillarbox	Pillarbox
800 × 600	VGA 85	4:3	85.008	Pillarbox	Pillarbox
800 × 600	SVGA 56	4:3	56.25	Pillarbox	Pillarbox
800 × 600	SVGA 60	4:3	60.317	Pillarbox	Pillarbox
800 × 600	SVGA 72	4:3	72.188	Pillarbox	Pillarbox
800 × 600	SVGA 75	4:3	75	Pillarbox	Pillarbox
800 × 600	SVGA 85	4:3	85.061	Pillarbox	Pillarbox
832 × 624	MAC 16"	4:3	74.55	Pillarbox	Pillarbox
1024 × 768	XGA 60	4:3	60.004	Pillarbox	Pillarbox
1024 × 768	XGA 70	4:3	70.069	Pillarbox	Pillarbox
1024 × 768	XGA 75	4:3	75.029	Pillarbox	Pillarbox
1024 × 768	XGA 85	4:3	84.997	Pillarbox	Pillarbox
1024 × 768	MAC 19"	4:3	74.7	Pillarbox	Pillarbox
1152 × 864	SXGA 75	4:3	75	Pillarbox	Pillarbox
1280 × 768	WXGA 60	1.67:1	60	Letterbox	Pillarbox
1280 × 960	Quad VGA 60	4:3	60	Pillarbox	Pillarbox
1280 × 960	Quad VGA 85	4:3	85.002	Pillarbox	Pillarbox
1280 × 960	SXGA3 60	5:4	60.02	Pillarbox	Pillarbox
1280 × 1024	SXGA3 75	5:4	75.025	Pillarbox	Pillarbox
1400 × 1050	SXGA3 85	5:4	85.024	Pillarbox	Pillarbox
1600 × 1200	SXGA+	4:3	59.978	Pillarbox	Pillarbox
1600 × 1200	UXGA_60	4:3	60	Pillarbox	Pillarbox

HD and SD signal format compatibility

The following tables list the projectors' high definition (HD) and standard definition (SD) format signal compatibility, which the projector adjusts automatically when you use the aspect ratio commands described in *Adjusting projector settings* on page 14.

SMART UF75 projector

Signal format	Aspect ratio	Horizontal frequency (kHz)	Vertical frequency (Hz)	Match Input appearance
480i (DVD player) (640 × 480)	4:3	15.73	59.94	Full screen
567i (DVD player) (720 × 576)	5:4	15.63	50	Letterbox
720p	16:9	44.96	59.94	Letterbox
720p	16:9	35	50	Letterbox
1080i	16:9	33.7	59.94	Letterbox
1080i	16:9	28.1	50	Letterbox

SMART UF75w projector

Signal format	Aspect ratio	Horizontal frequency (kHz)	Vertical frequency (Hz)	Match Input appearance (16:10 aspect ratio mode)	Match Input appearance (16:9 aspect ratio mode)
480i (525i)	4:3	15.73	59.94	Pillarbox	Pillarbox
480p (525p)	4:3	31.47	59.94	Pillarbox	Pillarbox
576i (625i)	5:4	15.63	50	Pillarbox	Pillarbox
576p (625p)	5:4	31.25	50	Pillarbox	Pillarbox
720p (750p)	16:9	45	59.94	Letterbox	Full screen
720p (750p)	16:9	37.5	50	Letterbox	Full screen
1080i (1125i)	16:9	33.75	59.94	Letterbox	Full screen
1080i (1125i)	16:9	28.13	50	Letterbox	Full screen
1080p (1125p)	16:9	67.5	59.94	Letterbox	Full screen
1080p (1125p)	16:9	56.25	50	Letterbox	Full screen

i NOTE

Your projector is HD Ready. Its native resolution supports a pixel-perfect display of 720p source content. However, because the projector compresses 1080i source content to fit its native resolution, it doesn't support a pixel-perfect display of 1080i source content.

CHAPTER 4

Integrating other devices

Video system signal compatibility

The following tables list the projectors' video system signal compatibility, particularly for signals delivered over S-Video and Composite video connectors, which the projector adjusts automatically when you use the aspect ratio commands described in *Adjusting projector settings* on page 14.

i NOTE

The *16:9* command delivers all video modes with black bands along the top and bottom edges of the screen. The *Match Input* command might deliver video modes with black bands along the top and bottom edges of the screen, depending on the input resolution.

SMART UF75 projector

Video mode	Aspect ratio	Horizontal frequency (kHz)	Vertical frequency (Hz)	Color signal (MHz)
NTSC	4:3	15.73	29.96	3.58
PAL	4:3	15.62	25	4.43
SECAM	4:3	15.62	25	4.25 (f _{ob}) 4.06 (f _{or})

SMART UF75w projector

Video mode	Aspect ratio	Horizontal frequency (kHz)	Vertical frequency (Hz)	Color signal (MHz)
NTSC	4:3	15.73	59.94	3.58
PAL	4:3	15.63	50	4.43
SECAM	4:3	15.63	50	4.25 and 4.41
PAL-M	4:3	15.73	59.94	3.58
PAL-N	4:3	15.63	50	3.58
PAL-60	4:3	15.73	59.94	4.43
NTSC 4.43	4:3	15.73	59.94	4.43

Connecting peripheral sources and outputs

Follow these instructions if you have a peripheral device to connect to your interactive whiteboard system.

i NOTES

- Measure the distance between the projector and the peripheral device you want to connect. Make sure each cable is long enough, has plenty of slack and can be placed safely in your room without presenting a trip hazard.
- Do not disconnect cables from the ECP to connect peripheral devices because you could disconnect controls for your interactive whiteboard.
- Don't connect SBA-L projection audio system speakers to the RCA connector pod. Connect these speakers to the projector connection panel using a dual-channel (left and right) RCA plug-to-3.5 mm phone connector (included with the speakers).
- The composite video connector and associated dual channel audio inputs on the projector and optional RCA connector pod are for input only. These RCA jacks don't provide an output signal.

■ To connect a laptop to a SMART Board 800i5 interactive whiteboard system

1. Connect a USB cable from the laptop computer to the ECP.
2. Connect a VGA cable from the laptop computer to the VGA connection kit.

OR

Connect an HDMI cable from the laptop computer to the projector.

3. Press the **Input** button on the ECP or remote control to switch input sources to the laptop computer.

■ To connect a laptop to a SMART Board 800i5-SMP interactive whiteboard system

1. Connect the laptop computer to the SMART GoWire cable, and then connect the SMART GoWire cable to the CAT 5 USB extender.

OR

Connect the laptop computer directly to the CAT 5 USB extender.

CHAPTER 4

Integrating other devices

2. Connect a VGA cable from the laptop computer to the VGA connection kit.

OR

Connect an HDMI cable from the laptop computer to the projector.

3. Press the **Input** button on the ECP or remote control to switch input sources to the laptop computer.

To connect a DVD/Blu-ray player or similar device

1. If you have speakers installed, turn the volume dial on the ECP all the way down to prevent buzzing or sparking.
2. Connect your peripheral device's input cables to the receptacles on the projector or to the optional RCA connector pod.
3. Press the **Input** button on the ECP or remote control to switch input sources to the peripheral device.
4. Restore the volume on the ECP's volume dial.

Chapter 5

Maintaining your interactive whiteboard system

Maintaining your interactive whiteboard.....	37
Cleaning the projector.....	37
Focusing and adjusting the projector image.....	38
Replacing the projector lamp.....	39
Removing and replacing the projector lamp module.....	39
Resetting the lamp hours.....	43

This chapter includes methods for properly cleaning and preventing damage to your SMART Board 800i5 interactive whiteboard system.

Maintaining your interactive whiteboard

For information on maintaining your interactive whiteboard, see the *SMART Board 800 series interactive whiteboard user's guide* (smarttech.com/kb/144817).

Cleaning the projector

WARNING

Cleaning a wall-mounted projector can result in a fall or injury. Use caution when climbing a ladder, and consider removing the projector from its wall-mounting bracket to clean it.

CAUTION

- Never touch the mirror with your hands or a brush, and do not scrub the surface of the mirror with the supplied cleaning cloth. Instead, use the supplied cleaning cloth to clean the mirror with a light touch, and do not put any cleaning solvents on the cloth or the mirror. Do not apply pressure to the projector lens or mirror.

CHAPTER 5

Maintaining your interactive whiteboard system

- Before you clean the projector, press the **Power**  button twice on the ECP or remote control to put the system in Standby mode, and then allow the lamp to cool for at least 30 minutes.
- Do not spray cleaners, solvents or compressed air directly on the projector. Do not use spray cleaners or solvents near any part of the projector because they can damage or stain the unit. Spraying the system could spread a chemical mist on some of the projector's components and lamp, resulting in damage and poor image quality.
- Do not allow liquids or commercial solvents of any kind to flow into the projector base or head.



IMPORTANT

- When cleaning the interactive whiteboard system:
 - Wipe the exterior of the projector with a lint-free cloth.
 - If necessary, use a soft cloth moistened with a mild detergent to clean the projector housing.
- Do not use abrasive cleaners, waxes or solvents.

When cleaning the projector's mirror:

- Use a bellows bulb or air blower bulb (commonly found in audio-visual supply stores) to blow off dust. Never touch the mirror with your bare hands or a brush.
- If wiping the mirror is unavoidable, wear protective gloves and gather the cleaning cloth into a ball. Gently run the cleaning cloth across the mirror like you would a feather duster. Don't apply any pressure to the lens or mirror.

When cleaning the projector's lens:

- Use a bellows bulb or air blower bulb (commonly found in audio-visual supply stores) to blow off dust. Never touch the lens with your bare hands or a brush.
- If wiping the lens is unavoidable, wear protective gloves and gather the cleaning cloth into a ball. Gently run the cleaning cloth across the lens from the center to the edge, using the cleaning cloth like you would a feather duster. Don't apply any pressure to the lens or mirror.

Focusing and adjusting the projector image

For information on focusing and adjusting the projector image, see *Focusing the image* on page 21 and *Adjusting the image* on page 22.

Replacing the projector lamp

This section provides detailed instructions for replacing the projector lamp module.

Removing and replacing the projector lamp module

Eventually the lamp will dim and a message will appear reminding you to replace it. Make sure you have a replacement lamp module before proceeding with the following instructions.



WARNING

- See smarttech.com/compliance for the projector's MSDS documents.
- Replace the lamp module when the projector displays its lamp life warning message. If you continue to use the projector after this message appears, the lamp can shatter or burst, scattering glass throughout the projector.
- If the lamp shatters or bursts, leave and then ventilate the area.

Next do the following:

- Avoid touching the glass fragments because they can cause injury.
 - Wash your hands thoroughly if you have come into contact with lamp debris.
 - Thoroughly clean the area around the projector, and discard any edible items placed in that area because they could be contaminated.
 - Call your authorized SMART reseller for instructions. Do not attempt to replace the lamp.
- Replacing the lamp module in a wall-mounted projector can result in a fall or injury. Use caution when climbing a ladder, and consider removing the projector from the wall-mounting bracket to replace the lamp module.
 - Uncovering the lamp while the projector is mounted on the wall-mounting bracket can lead to product damage or personal injury from falling pieces of glass if the lamp is broken.

CHAPTER 5

Maintaining your interactive whiteboard system

- When replacing the projector lamp module:
 - Put the projector into Standby mode and wait 30 minutes for the lamp to cool completely.
 - Do not remove any screws other than those specified in the lamp replacement instructions.
 - Wear protective eyewear while changing the lamp module. Failure to do so can cause injuries including loss of eyesight if the lamp shatters or bursts.
 - Use only replacement lamp modules approved by SMART Technologies. Contact your authorized SMART reseller for replacement parts.
 - Never replace the lamp module with a previously used lamp module.
 - Always handle the fragile lamp assembly with care to prevent premature lamp failure or exposure to mercury. Use gloves when touching the lamp module. Do not touch the lamp with your fingers.
 - Recycle or dispose of the lamp module as hazardous waste in accordance with local regulations.

You need a Phillips No. 2 screwdriver and a flat screwdriver to complete these procedures.

To remove the old lamp module

1. Press the **Power**  button twice on the remote control or the ECP to put the projector into Standby mode.
2. Wait at least 30 minutes for the projector to cool down.
3. Disconnect the power cable from the projector.

CHAPTER 5

Maintaining your interactive whiteboard system

4. Remove the lamp cover from the projector, and then put it in a safe place.

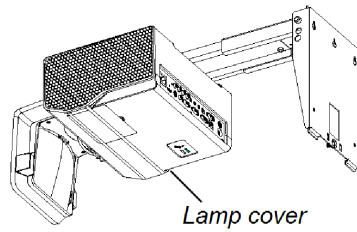

TIP

If the cover is difficult to remove, insert a flat screwdriver or small coin into the slot on the bottom of the lamp cover to gently pry the cover open.

5. Use the Phillips screwdriver to loosen the two captive screws from the bottom of the lamp module.

NOTE

Don't try to remove these screws. Captive screws can't be removed, but they must be loosened.

6. Use the handle on the bottom of the lamp module to slide it out and remove it from the projector.

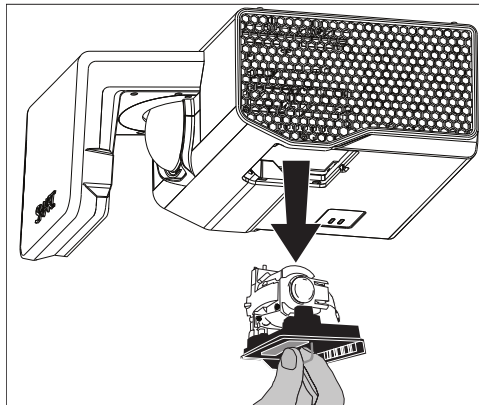

■ To put the new lamp module into the projector

1. Remove the new lamp module from its packaging.
2. Carefully place the lamp module into the projector using the handle on the top of the module. Hold the lamp module vertically and guide it into its slot. Gently press the power end of the lamp module against the projector to ensure the power plug makes contact with the projector's power receptacle.

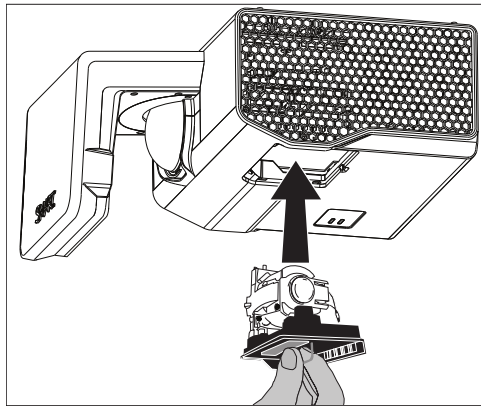

i NOTE

You should be able to place the lamp module into the projector easily without applying much force.

3. Use the Phillips screwdriver to secure the captive screws.

🔑 IMPORTANT

Do not over-tighten the screws.

4. Carefully replace the lamp cover.
5. Connect the power cable to the wall outlet.
6. Press the **Power** ⏻ button once on the remote control or ECP to confirm that the projector is operating and that the lamp module is correctly installed.
7. Put the old lamp module in a secure container, and handle it gently until you recycle it.

■ To finish the projector lamp module installation

1. Turn on the projector.
2. Adjust the projector image if necessary (see *Adjusting the image* on page 22).
3. Access the service menu to reset the lamp hours (see *Resetting the lamp hours* on next page).

4. Activate the projector's alert e-mails and lamp warnings if they've been deactivated (see *E-mail alerts* on page 68 and *Control panel* on page 62).

Resetting the lamp hours

After you replace the lamp module, you need to access the projector service menu and reset the lamp hours. To prevent accidental errors, only a system administrator should perform this procedure.

NOTE

Always reset the lamp hours after you replace the lamp, because lamp service reminders are based on the current hours of use.

To reset the lamp hours

1. Using the remote control, press the following buttons quickly to access the service menu:
Down, Up, Up, Left, Up.

CAUTION

Do not adjust any settings in the service menu other than those listed in this guide. Changing other settings can damage or affect the operation of your projector and may invalidate your warranty.

2. Scroll down to *Lamp Hour Reset*, and then press **OK**.

Both *Lamp Hour* values (Standard and Economy) reset to zero.

CAUTION

Do not reset the lamp hours unless you have just replaced the lamp module. Resetting the lamp hours on an old lamp can damage your projector as a result of lamp failure.

NOTE

You're unable to reset the Display Hour value because it's the running total of hours the projector has been in use.

3. Press the **Menu** button on the remote control.
The *SMART UF75 Settings* menu appears.
4. Select  to confirm that *Lamp Hour* is reset to zero.

Chapter 6

Troubleshooting your interactive whiteboard system

Before you start	46
Locating status lights	46
Locating serial numbers	46
Determining you interactive whiteboard system's status	48
Resolving interactive whiteboard issues	49
Resolving operation issues	49
Resolving connection issues	49
Resolving controller module issues	50
Resolving projector issues	50
Resolving projector errors	50
Your projector stops responding	51
The "Projector Overheated", "Fan Failure" or "Color Wheel Failure" message appears	51
The "Lamp Failure" message appears	52
The projector Power and Service lights are off	52
Resolving image issues	53
Loss of signal	53
Partial, scrolling or incorrectly displayed image	54
Unstable or flickering image	54
Frozen image	55
Your image doesn't fit the interactive whiteboard	55
The image from your connected laptop computer isn't projected	55
Unaligned projected image	55
Resolving audio issues	56
Resolving network communication issues	57
Resolving ECP issues	57
Accessing the service menu	57
Retrieving your password	58
Resetting the projector	58
Transporting your interactive whiteboard system	59

CHAPTER 6

Troubleshooting your interactive whiteboard system

This chapter provides basic troubleshooting information for your interactive whiteboard system.

For issues not covered in this chapter, consult the SMART Support website (smarttech.com/support) or contact your authorized SMART reseller (smarttech.com/where).

Before you start

Before you troubleshoot your interactive whiteboard system or contact your authorized SMART reseller or SMART Support for assistance, you need to do the following:

- Locate your interactive whiteboard system's status lights
- Locate your interactive whiteboard system's serial numbers

Locating status lights

Your interactive whiteboard system consists of several components, which have their own status lights:

- Your interactive whiteboard's Ready light is located on the pen tray.
- Your projector's Power (⏻) and Service (🔧) lights are located on the bottom of the projector.

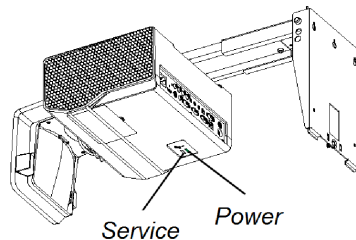

- The ECP's **Power** ⏻ button (see *Using the Extended Control Panel (ECP)* on page 24) also functions as a status light.

Locating serial numbers

The SMART Board 800 series interactive whiteboard serial number is located on the lower-right edge of your interactive whiteboard's frame. For more information, see the *SMART Board 800 series interactive whiteboard user's guide* (smarttech.com/kb/144817).

CHAPTER 6

Troubleshooting your interactive whiteboard system

The SMART UF75 or SMART UF75w projector serial number is located on the top of the projector.

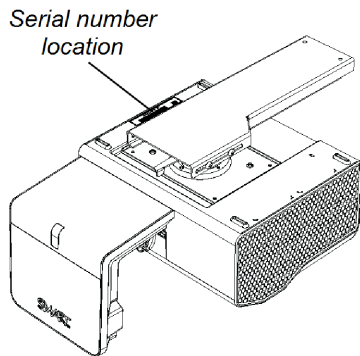

TIP

You can also access the projector's serial number through the on-screen menu. For more information, see *Adjusting projector settings* on page 14.



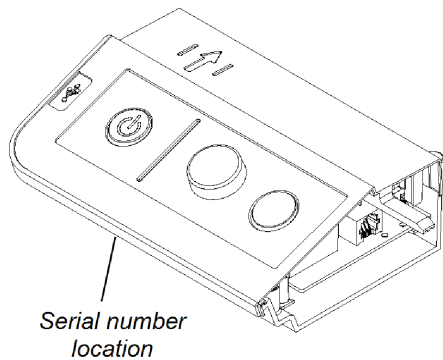

The ECP has its own serial number, which is different from the interactive whiteboard serial number. The ECP serial number is located on the bottom of the ECP.



For the locations of serial numbers on other components and accessories, see smarttech.com/support.





Determining you interactive whiteboard system's status

Use the following table to determine the status of your interactive whiteboard system:

 Projector Power light	 Projector Service light	 ECP light	 Ready light	Projected image	Touch and pen control	Status and related troubleshooting
Normal operating statuses						
Solid green	Off	Solid green	Solid green	Correct	Full control	The system is operating normally. If image or sound issues occur, see the remaining sections of this chapter for troubleshooting information.
Flashing green	Off	Flashing green	Off	None	None	The system is starting up.
Solid amber	Off	Solid amber	Off	None	None	The system is in Standby mode.
Flashing amber	Off	Flashing amber	Off	None	None	The system is entering Standby mode.
Solid green	Off	Solid green	Solid amber	N/A	None	The interactive whiteboard's controller module is starting up. If this process takes longer than 10 seconds, see <i>Resolving controller module issues</i> on page 50.
Solid green	Off	Solid green	Flashing amber	N/A	N/A	The interactive whiteboard's controller module is ready to receive a firmware update or is applying a firmware update. If the Ready light flashes amber but no firmware update appears on the screen, see <i>Resolving controller module issues</i> on page 50.
Error statuses						
Solid green	Off	Solid green	Solid green	Incorrect	Full control	There's an issue with the projected image. See <i>Resolving image issues</i> on page 53.
Solid green	Off	Solid green	Solid green	Correct	None	There's an issue with the interactive whiteboard. See <i>Resolving operation issues</i> on next page.
Solid green	Off	Solid green	Flashing green	Correct	Touch only	SMART Product Drivers isn't installed or running correctly on the connected computer.
Solid green	Off	Solid green	Off OR Solid red	N/A	None	There's an issue with the connections between the interactive whiteboard and the other components of the system. See <i>Resolving connection issues</i> on next page.
Solid green	Off	Off	Off OR Solid red	N/A	N/A	The ECP isn't receiving power. See <i>Resolving ECP issues</i> on page 57.

CHAPTER 6

Troubleshooting your interactive whiteboard system

 Projector Power light	 Projector Service light	 ECP light	 Ready light	Projected image	Touch and pen control	Status and related troubleshooting
Solid amber	Flashing red	N/A	N/A	None	N/A	There's an issue with the projector lamp. See <i>The "Lamp Failure" message appears</i> on page 52.
Off	Flashing red	Solid amber	Off	None	None	The projector's operating temperature has been exceeded. See <i>The "Projector Overheated", "Fan Failure" or "Color Wheel Failure" message appears</i> on page 51.
Off	Solid red	N/A	N/A	None	N/A	There's an issue with the projector's fan or color wheel. See <i>The "Projector Overheated", "Fan Failure" or "Color Wheel Failure" message appears</i> on page 51.
Off	Off	Off	Off	None	None	The projector power cable isn't properly connected. OR There's an issue with the mains power supply (for example, the circuit breaker is off).

Resolving interactive whiteboard issues

This section includes information on resolving issues with your interactive whiteboard.

For information not covered in this section, see the *SMART Board 800 series interactive whiteboard user's guide* (smarttech.com/kb/144817).

Resolving operation issues

To resolve operation issues, complete the following tasks:

- Confirm that the camera system cable is connected to the back of the pen tray.
- Perform the calibration procedure documented in the *SMART Board 800 series interactive whiteboard user's guide* (smarttech.com/kb/144817).
- If necessary, complete additional troubleshooting with the guidance of SMART Support using SMART Board Diagnostics.

Resolving connection issues

To resolve connection issues, complete the following tasks:

- Confirm that the ECP cable harness's 4-pin mini-DIN connector is properly connected to the **5V 2A** connector on the projector.

CHAPTER 6

Troubleshooting your interactive whiteboard system

- Confirm that the ECP cable harness's DB9M RS-232 connector is properly connected to the **Control** connector on the projector.
- Confirm that the USB cable, which is located on the underside of the pen tray, is properly connected from the interactive whiteboard to the ECP.
- Confirm that the USB cable is properly connected from a fully functional USB receptacle on the computer to the correct USB receptacle on the ECP.
- Confirm that the projector's on-screen menu option for the USB receptacle is set to the correct video source.
- If necessary, complete additional troubleshooting on any devices between the USB connection from the computer to the interactive whiteboard system, including any USB hubs and extension cables.

i NOTES

- If you're using the CAT 5 USB extender, see *Troubleshooting tips for the CAT 5 USB extender for SMART Board 800 series interactive whiteboards* (smarttech.com/kb/147499).
- Computers connected to the ECP override computers connected to the CAT 5 USB extender. If you connect two computers to the ECP, any computer connected to the CAT 5 USB extender doesn't have a data connection to the interactive whiteboard.

Resolving controller module issues

If the controller module takes longer than 10 seconds to start up, disconnect the interactive whiteboard's power cable, wait 10 seconds, and then reconnect it.

If the issue persists, update the firmware as documented in the *SMART Board 800 series interactive whiteboard user's guide* (smarttech.com/kb/144817).

If the Ready light indicates that a firmware update is in progress but no update is actually taking place, disconnect the interactive whiteboard's power cable, wait a few seconds, and then reconnect it.

Resolving projector issues

Resolving projector errors

System administrators can resolve the following projector errors on their own prior to contacting SMART Support. Performing initial troubleshooting on your projector will reduce the time of a support call.

CHAPTER 6

Troubleshooting your interactive whiteboard system

Your projector stops responding

If your projector stops responding, perform the following procedure.

■ To restart an unresponsive projector

1. Put the projector into Standby mode, and then wait 30 minutes for it to cool down.
2. Disconnect the power cable from the power outlet, and then wait at least 60 seconds.
3. Connect the power cable, and then turn on the projector.

The “Projector Overheated”, “Fan Failure” or “Color Wheel Failure” message appears

If the “Projector Overheated”, “Fan Failure” or “Color Wheel Failure” message appears and the projector stops projecting an image, one of the following issues is occurring:

- The projector is overheating internally because of blocked air vents or an internal temperature over 131°F (55°C).
- The temperature outside the projector is too high.
- One of the fans has failed.
- The projector has a color wheel issue.

■ To resolve the “Projector Overheated”, “Fan Failure” or “Color Wheel Failure” error

1. Put the projector into Standby mode, and then wait 30 minutes for it to cool down.
2. If your room is hot, lower the temperature if possible.
3. Ensure that nothing is blocking the projector’s air intake and exhaust.
4. Disconnect the power cable from the power outlet, and then wait at least 60 seconds.
5. Connect the power cable, and then turn on the projector.
6. Adjust the fan speed using the service menu.
7. If the previous steps don’t resolve the issue, put the projector into Standby mode, disconnect the power cable, and then contact your authorized SMART reseller.

CHAPTER 6

Troubleshooting your interactive whiteboard system

The “Lamp Failure” message appears

If the “Lamp Failure” message appears, one of the following issues is occurring:

- The lamp is overheating, likely due to blocked air vents.
- The lamp has reached the end of its life.
- The projector has an internal problem.

■ To resolve the “Lamp Failure” error

1. Restart the projector (see *Your projector stops responding* on previous page).
2. Check the remaining lamp hours using the on-screen menu (see *Adjusting projector settings* on page 14).

If the lamp has more than 2000 hours of use, it’s near the end of its lifespan.

3. Replace your lamp module as described in *Removing and replacing the projector lamp module* on page 39.
4. If replacing the lamp module doesn’t resolve the issue, put the projector into Standby mode, disconnect the power cable, and then contact your authorized SMART reseller.

The projector Power and Service lights are off

If the projector Power and Service lights are both off, one of the following issues is occurring:

- There was a power outage or a power surge.
- A circuit breaker or a safety switch was tripped.
- The projector isn’t connected to the power source.
- The projector has an internal problem.

■ To resolve the unlit projector Power and Service lights issue

1. Check the power source, and then make sure that all cables are connected.
2. Confirm that the projector is connected to an active power outlet.
3. Make sure the pins on the connectors aren’t broken or bent.
4. Connect the power cable, and then turn on the projector.
5. If the previous steps don’t resolve the issue, disconnect the power cable and then contact your authorized SMART reseller.

Resolving image issues

To resolve common image issues, complete the following tasks:

- Ensure the computer or other video source is on and set to display a resolution and refresh rate supported by the projector (see *Video format compatibility* on page 29).
- Ensure the video source is properly connected to the projector.
- Press the Input Select button on the remote control or ECP to switch to the correct video source.

If these tasks don't resolve the issue, refer to the following sections for additional troubleshooting information.

Loss of signal

If a video source signal is not detected, out of range of the projector's support video modes or the signal is being switched to a different device or input, the projector doesn't show a source signal and instead displays the SMART logo on a blue screen.



■ To resolve signal loss issues

1. Wait approximately 45 seconds for the image to synchronize. Some video signals require a longer synchronization period.
2. If the image doesn't synchronize, check the cable connections to the projector and the ECP.
3. Ensure that the image signal is compatible with the projector (see *Video format compatibility* on page 29).
4. If there are any extension cables, switch boxes, connection wall plates or other devices in the video connection from the computer to the projector, temporarily remove them to ensure they are not causing the video signal loss.
5. If your projector still doesn't show a source signal, contact your authorized SMART reseller.

Partial, scrolling or incorrectly displayed image

NOTES

- The following procedure applies to Windows XP operating systems on desktop computers only.
- This procedure may vary depending on your version of Windows operating system and your system preferences.

To resolve a partial, scrolling or incorrectly displayed image

1. Select **Start > Control Panel**.
2. Double-click **Display**.
The *Display Properties* window appears.
3. Click the **Settings** tab.
4. Verify that your display resolution setting is 1024 × 768 (SMART UF75 projector), 1280 × 800 (SMART UF75w projector in 16:10 aspect ratio mode) or 1280 × 720 (SMART UF75w projector in 16:9 aspect ratio mode).
5. Click **Advanced**, and then click the **Monitor** tab.
6. Verify that the screen refresh rate is 60 Hz.

Unstable or flickering image

If the projector's image is unstable or flickering, you could have different frequency or tracking settings on your input source than on your projector.

IMPORTANT

Write down your setting values before adjusting any of the settings in the following procedure.

To resolve your unstable or flickering image

1. Adjust the **Frequency**, **Tracking**, **H-position** and **V-position** settings in the on-screen menu. See *Adjusting projector settings* on page 14.
2. Check the display mode of your computer's graphics card. Make sure it matches one of the projector's compatible signal formats (see *Video format compatibility* on page 29). Refer to your computer's manual for more information.
3. Configure the display mode of your computer's graphics card to make it compatible with the projector. Refer to your computer's manual for more information.

4. Optionally, reset the projector as described in *Resetting the projector* on page 58 to adjust the frequency and tracking to their original values.



IMPORTANT

This action resets all values to their defaults.

Frozen image

If your projector has a frozen image, perform the following procedure.

To resolve a frozen image

1. Ensure that the Hide Display feature is off.
2. Press the **Hide** button on the projector's remote control to hide or show the display.
3. Ensure that your source device, such as your DVD player or computer, isn't malfunctioning.
4. Put the projector into Standby mode, and then wait 30 minutes for it to cool down.
5. Disconnect the power cable from the power outlet, and then wait at least 60 seconds.
6. Connect the power cable, and then turn on the projector.
7. If the previous steps don't resolve the issue, contact your authorized SMART reseller.

Your image doesn't fit the interactive whiteboard

If you're using a SMART UF75w projector with a wide screen interactive whiteboard, verify that you're using the correct aspect ratio mode for the interactive whiteboard:

Interactive whiteboard	Aspect ratio mode
SMART Board 885 interactive whiteboard	16:10

You can set the aspect ratio mode using the Native DLP Resolution setting in the Projector Functions menu (see *Adjusting projector settings* on page 14).

The image from your connected laptop computer isn't projected

Laptop computer settings can interfere with projector operations.

Some laptop computers deactivate their screens when you connect a secondary display device. Refer to your computer's manual for details on reactivating the computer's display screen.

Unaligned projected image

Alignment errors occur when the projected image isn't perpendicular to the screen. Alignment errors can occur when you mount your interactive whiteboard system on an uneven surface or a wall that has obstructions, or if you swivel the projector too far from the vertical center of your interactive whiteboard.

CHAPTER 6

Troubleshooting your interactive whiteboard system

Use the instructions in the included *SMART Board 880i5 or 885i5 interactive whiteboard system installation guide* (smarttech.com/kb/154546) or *SMART Board 880i5-SMP or 885i5-SMP interactive whiteboard system installation guide* (smarttech.com/kb/170130) to eliminate most image alignment issues.

The projector image can slip if the projector is moved often or installed in a location prone to vibration, such as next to a heavy door. Follow these precautions to help prevent the image from becoming misaligned:

- Make sure that the installation wall is plumb and square and doesn't move or vibrate excessively.
- Make sure that there are no obstructions behind the projector's wall-mounting bracket, and that the bracket is firmly secured to the wall according to the installation instructions.
- Adjust the projected image. See the included *SMART Board 880i5 and 885i5 interactive whiteboard system installation guide* (smarttech.com/kb/154546) or *SMART Board 880i5-SMP or 885i5-SMP interactive whiteboard system installation guide* (smarttech.com/kb/170130) and *Adjusting the image* on page 22.

Resolving audio issues

The projector doesn't have integrated speakers, but you can connect an audio system to the audio output connector in the projector's connection panel. If no sound is coming from your audio system, perform the following procedure.

To resolve audio issues

1. Ensure that the speakers' or audio system's cables are properly connected to the audio output plug on the projector's connection panel.
2. Press the **Mute** button on the projector's remote control, and if Audio Mute is on, turn it off.
3. Check the ECP's volume knob or use the projector's remote control to ensure that the volume isn't at the lowest setting.
4. Ensure that your speaker or audio system is on and that the volume is turned up.
5. Check that your source input, such as your computer or video device, isn't malfunctioning. Ensure that its audio output is on and that the volume isn't set to the lowest position.

NOTE

You must display the source input's video to play its audio through the connected speakers or audio system.

6. If the previous steps don't resolve the issue, contact your authorized SMART reseller.

Resolving network communication issues

If you don't have network access, perform the following procedure to troubleshoot your system.

■ To resolve network communication issues

1. Ensure that your network cable is properly connected to the RJ45 connection on the projector's connection panel.
2. Ensure that the LAN warning light on the projector is green. To activate the projector's network features, use the "vgaoutnetenable=on" RS-232 command (see *Projector programming commands* on page 73) or enable the **Network and VGA Out** setting (see *Adjusting projector settings* on page 14). The network features on the projector don't work until you complete one of these tasks.
3. Press the **Menu** button, and then select the **Network Settings** menu to check the IP address. See *Adjusting projector settings* on page 14 for a description of the IP address field. Enter this IP address into your browser or SNMP agent.
4. If you still don't have network access, contact your network administrator. If your administrator is unable to resolve the issue, contact your authorized SMART reseller.

Resolving ECP issues

If the ECP isn't receiving power, complete the following tasks:

- Confirm that the ECP cable harness's 11-pin connector is properly connected to the ECP.
- Confirm that the ECP cable harness's 7-pin min-DIN connector is properly connected to the ECP connector on the projector.

Accessing the service menu

▲ CAUTION

- To prevent tampering or unintentional changes, only system administrators should access the service menu. Do not share the service menu access code with casual users of your interactive whiteboard system.
- Do not adjust any settings in the service menu other than those listed in this guide. Changing other settings can damage or affect the operation of your projector and may invalidate your warranty.

Retrieving your password

If you forget the projector's password, you can retrieve it by accessing the projector service menu directly from the projector or from the password settings menu on your projector's web page (see *Password settings* on page 68).

■ To retrieve your password from the service menu

1. Using the remote control, press the following buttons quickly to access the service menu:
Down, Up, Up, Left, Up.
2. Scroll to *Password Get*, and then press **Enter** on the remote control.
The password appears on the screen.
3. Write down the password.
4. Scroll to *Exit*, and then press **Enter** on the remote control to exit the projector service menu.

Resetting the projector

At some point during troubleshooting, you might need to reset all projector settings.



IMPORTANT

This action is irreversible.

■ To reset all projector settings

1. Using the remote control, press the following buttons quickly to access the service menu:
Down, Up, Up, Left, Up.
2. Scroll to *Factory Reset*, and then press **Enter** on the remote control.
3. Scroll to *Exit*, and then press **Enter** on the remote control to exit the projector service menu.

Transporting your interactive whiteboard system

Save your original SMART Board interactive whiteboard packaging so that it's available if you need to transport your interactive whiteboard system. When required, repack it with all of the original packaging. This packaging was designed to provide optimal shock and vibration protection. If you no longer have your original packaging, purchase the same packaging directly from your authorized SMART reseller.

If you prefer to use your own packaging materials, make sure you adequately protect your unit. Make sure that the projector lens and mirror are protected against any physical contact or pressure which may damage the projector's optics. Ship your interactive whiteboard in an upright position to deter shippers from placing heavy objects on it.

Appendix A

Remotely managing your system through a network interface

Web page management	61
Accessing web page management	61
Home	62
Control panel	62
Control panel II	65
3D settings	65
USB Control settings	66
Network settings	66
E-mail alerts	68
Password settings	68
Simple Network Management Protocol (SNMP)	69

This appendix includes detailed instructions on how to remotely manage your SMART Board 800i5 interactive whiteboard system settings through a network interface.

Web page management

You can access advanced setup features via the projector's web page. This web page enables you to manage the projector from a remote location using any computer connected to your intranet.

NOTE

To access the web page, your browser must support JavaScript. Most commonly used browsers like Internet Explorer® and Firefox® support JavaScript.

Accessing web page management

Before you can access the web page, you must connect the network cable to your projector (see the *Projector connection diagram* on page 22) and enable the Network and VGA Out setting (see *Adjusting projector settings* on page 14). When you first connect your projector to a network, an IP address appears on the on-screen display.

APPENDIX A

Remotely managing your system through a network interface

NOTE

You can view the projector's IP address by accessing the projector's Network Settings menu page (see *Network settings* on page 66).

To use the management web page

1. Start your Internet browser.
2. Type the IP address in the address line field, and then press ENTER.
The *SMART UF75 Projector Settings* (or *SMART UF75w Projector Settings*) window appears.
3. Select the menu options in the left pane to access the settings on each page.
4. Modify settings using your computer's mouse and keyboard, and then click **Submit** or another action button next to each setting you change.

Home

The Home menu page displays basic projector information and enables you to select the on-screen display language.

NOTE

You can view basic projector information but you're unable to change it (with the exception of the on-screen display language) from the Home menu page.

Submenu setting	Description
Language	Displays language options
Projector Information	Displays current projector information

Control panel

This menu enables you to manage the projector audio and video status, alerts and appearances using an Internet browser.

Submenu setting	Description
Power	Turns the projector on or puts it into Standby mode. Select the Power ON or Power OFF button.
Restore All Projector Defaults	Returns projector settings to default values or refreshes the current settings. Select Submit or Refresh .

IMPORTANT

The **Submit** option is irreversible and resets all values.

APPENDIX A

Remotely managing your system through a network interface

Submenu setting	Description
Volume	Adjusts the projector's volume from -20 to 20.
Mute	Turns on or turns off the mute settings. Select On to mute the projector's sound and Off to turn off mute.
Volume Control	Enables volume control on the ECP. Select On to enable volume adjustment and select Off to disable volume adjustment if you prefer to use your audio system or speaker (not included) controls.
Closed Captioning	Turns on or turns off the closed captioning feature.
Language	Sets the closed captioning language to CC1 or CC2 . Typically, CC1 displays U.S. English subtitles, while CC2 displays other regional languages, such as French or Spanish, depending on television channel or media setup.
Display Mode	Adjusts the display output to SMART Presentation , Bright Room , Dark Room , sRGB and User modes so you can project images from various sources with consistent color performance: <ul style="list-style-type: none">• SMART Presentation is recommended for color fidelity.• Bright Room and Dark Room are recommended for locations with those conditions.• sRGB provides standardized accurate color.• User enables you to apply your own settings.
Brightness	Adjusts projector brightness from 0 to 100.
Contrast	Adjusts the difference between the lightest and darkest parts of the image from 0 to 100.
Frequency	Adjusts the display data frequency of the projected image from -5 to 5 to match the frequency of your computer's graphics card.
Tracking	Synchronizes your projector's display timing with your computer's graphics card from 0 to 31.
Sharpness	Adjusts the projected image's sharpness from 0 to 31.
White Peaking	Adjusts the image color brightness from 0 to 10 while providing more vibrant white shades. A value closer to 0 creates a natural image and a value closer to 10 enhances brightness.
Degamma	Adjusts the color performance of the display from 0 to 3.
Color	Adjusts the Red, Green, Blue, Cyan, Magenta and Yellow colors on the projector from 0 to 100 to provide custom color and luminance output. Each color has a default value of 100. Adjustments to the color settings register to the User mode.
Auto Signal Detect	Enables or disables signal searching of input connectors. <ul style="list-style-type: none">• Select On to have the projector continuously switch inputs until it finds an active video source.• Select Off to maintain signal detection in one input.
Lamp Reminder	Select On to show or Off to hide the lamp replacement reminder when it appears. This reminder appears 100 hours before the recommended lamp replacement.

APPENDIX A

Remotely managing your system through a network interface

Submenu setting	Description
Lamp Mode	Adjusts lamp brightness to Standard or Economy . Standard displays a high-quality, bright image. Economy increases the lamp life by decreasing the brightness of the image.
Auto Power Off	Sets the length of the auto power off countdown timer between 1 and 240 minutes. The timer begins to count down when the projector no longer receives a video signal. The timer finishes when the projector enters Standby mode. Select 0 to turn off the timer.
Zoom	Adjusts the zoom to the center of the image in or out from 0 to 30.
H-position (RGB input)	Moves the horizontal position of the source video left or right from 0 to 100 (relative to the projected image). i NOTE This is useful in situations where the source video is cut off.
V-position (RGB input)	Moves the vertical position of the source video up or down from -5 to 5 (relative to the projected image). i NOTE This is useful in situations where the source video is cut off.
Aspect Ratio	Adjusts the image output to Fill Screen , Match Input or 16:9 . <ul style="list-style-type: none">• Fill Screen produces an image that fills the entire screen by stretching and scaling.• Match Input matches the projector's aspect ratio to the input's aspect ratio. As a result, black bands might appear along the top and bottom edges of the screen horizontally (letterbox format) or along the left and right edges of the screen vertically (pillarbox format).• 16:9 changes the output to 16:9 by letterboxing the image, which is recommended for use with HDTV and DVDs enhanced for wide-screen television. i NOTE See <i>Video format compatibility</i> on page 29 for appearance descriptions in each mode.
Startup Screen	Sets the type of startup screen to SMART or User . The SMART screen is the default SMART logo on a blue background. The User screen uses the saved picture from the Capture User Startup Screen function.
Video Mute	Turns the video mute setting on or off. Select On to hide the display and Off to show it again.

APPENDIX A

Remotely managing your system through a network interface

Submenu setting	Description
High Speed Fan	Adjusts the speed of the projector's fan. Select High or Normal . i NOTE Use the High setting when the projector's temperature is high or the altitude is above 6000' (1800 m).
Projector Mode	Adjusts the projection mode to Front , Ceiling , Rear or Rear Ceiling . 🔑 IMPORTANT SMART recommends that you never change this setting from the Ceiling projection mode.
Source	Adjusts the input source to VGA-1 , VGA-2 , Composite , S-Video or HDMI .
VGA1	Assigns an alternative name to your VGA 1 input, which appears when you select the VGA 1 input.
VGA2	Assigns an alternative name to your VGA 2 input, which appears when you select the VGA 2 input.
S-Video	Assigns an alternative name to your S-video input, which appears when you select the S-video input.
Composite	Assigns an alternative name to your Composite video input, which appears when you select the Composite video input.
HDMI	Assigns an alternative name to your HDMI input, which appears when you select the HDMI input.
Emergency Alert	Turns the on-screen alert broadcast message on or off. When enabled, this message displays over the current projected image.
Alarm Message	Displays an on-screen emergency notification message (maximum 60 characters).

Control panel II

3D settings

This menu allows you to enable or disable 3D image display and set its format.

Submenu setting	Description
3D On/Off	Turns the 3D feature on or off.
3D Invert	Selects the 3D Invert setting (L-R or R-L). <ul style="list-style-type: none">• L-R displays visual data for the left eye first.• R-L displays visual data for the right eye first.
3D Format	Selects the 3D format (Interleaved or Under-over). <ul style="list-style-type: none">• Interleaved breaks down the image frame for each eye, alternately displaying a line of visual information from each frame.• Under-over concurrently displays horizontally stretched image frames for each eye, one above the other.

APPENDIX A

Remotely managing your system through a network interface

USB Control settings

This menu allows you to associate a video source with a USB receptacle on the ECP.

Submenu setting	Description
USB1 Source	Enables touch for the selected video source (VGA-1 , VGA-2 , HDMI or Disabled) by associating the video source with the room computer USB receptacle (USB1) on the ECP.
USB2 Source	Enables touch for the selected video source (VGA-1 , VGA-2 , HDMI or Disabled) by associating the video source with the laptop USB receptacle (USB2) on the ECP.

Network settings

This menu allows you to use or not use Dynamic Host Control Protocol (DHCP) and to set the network-related addresses and names when DHCP is not used.

Submenu setting	Description
DHCP	Determines if the projector's IP address and other network settings are dynamically assigned by a DHCP server or manually set. <ul style="list-style-type: none">• On allows the network's DHCP server to assign a dynamic IP address to the projector.• Off allows you to manually set the projector's IP address and other network settings.
IP Address	Displays or allows you to set the projector's IP address in values between 0.0.0.0 and 255.255.255.255.
Subnet Mask	Displays or allows you to set the projector's subnet mask number in values between 0.0.0.0 and 255.255.255.255.
Gateway	Displays or allows you to set the projector's default network gateway in values between 0.0.0.0 and 255.255.255.255.
DNS	Displays or allows you to set the projector's IP address for your network's primary domain name server in values between 0.0.0.0 and 255.255.255.255.
Group Name	Displays or allows you to set the projector's workgroup name (maximum 12 characters).
Projector Name	Displays or allows you to set the projector's name (maximum 12 characters).
Location	Displays or allows you to set the projector's location (maximum 16 characters).
Contact	Displays or allows you to set the contact name or number for projector support (maximum 16 characters).
SNMP	Turns the Simple Network Management Protocol (SNMP) agent on or off.

APPENDIX A

Remotely managing your system through a network interface

Submenu setting	Description
Read-Only Community	<p>Sets a password that is required for each SNMP get request to the device.</p> <p>i NOTE</p> <p>The default for Read-Only Community is public.</p>
Read/Write Community	<p>Sets a password that is required for each SNMP set request to the device.</p> <p>i NOTE</p> <p>The default for Read/Write Community is private.</p>
Trap Destination Address	<p>Displays or allows you to set the IP address of the network's SNMP TRAP manager in values between 0.0.0.0 and 255.255.255.255. The trap destination address is the IP address of the computer assigned to handle unsolicited data generated by SNMP TRAP events generated by the projector, such as power state changes, projector failure modes, a lamp needing to be replaced or other issues.</p>

E-mail alerts

This menu enables you to enter your preferred address for receiving e-mail alerts and adjust related settings.

Submenu setting	Description
E-mail Alert	Selects Enable to turn on or Disable to turn off the E-mail Alert function.
To	Displays or allows you to set the e-mail address of the e-mail alert recipient.
CC	Displays or allows you to set the e-mail address of the e-mail alert “copy to” recipient.
From	Displays or allows you to set the e-mail address of the user who sends the e-mail alert.
Subject	Displays or allows you to set the e-mail alert subject.
Outgoing SMTP server	Displays or allows you to set the Simple Mail Transfer Protocol (SMTP) server that you use on your network.
Username	Displays or allows you to set the SMTP server user name.
Password	Displays or allows you to set the SMTP server password.
Alert Condition	Sends e-mail alerts whenever Lamp Warning , Low Lamp Life , Temperature Warning and Fan Lock conditions occur. Select the settings you want, and then click Submit .

i NOTE

The projector sends an alert e-mail (SMART Alert) to your e-mail address. Click **E-mail Alert Test** to confirm that your e-mail address and SMTP server settings are correct by sending a test e-mail (SMART Alert-Test Mail).

If the settings are not correct, the e-mail alert messages aren't sent or received successfully and no warning or notification message are available to advise of this state.

Password settings

This menu provides a security function that allows an administrator to manage projector use and enable the Administrator Password function.

Submenu setting	Description
Password	When the password function is enabled, the administrator password is required to access Web Management. Select Disable to allow remote web management of the projector without requiring a password.

APPENDIX A

Remotely managing your system through a network interface

NOTES

- The first time you enable the password settings, the default password value is four numbers, for example, 1234.
- The maximum allowable password length is four numbers or letters.
- If you forget the projector password, refer to *Accessing the service menu* on page 57 to set the projector setting to factory defaults.

Simple Network Management Protocol (SNMP)

Your projector support a list of SNMP commands as described in the management information base (MIB) file. You can download this file by browsing to smarttech.com/software and clicking the MIB files link in the *Hardware* section for the SMART UF75 projector.

The SNMP agent in your projector supports SNMP version 1 or 2. Upload the MIB file to your SNMP management system application, and then use it as described in your application's user guide.

Appendix B

Remotely managing your system through an RS-232 serial interface

Connecting your room control system to the ECP.....	71
Serial interface settings.....	72
Projector programming commands.....	73
Projector power state controls.....	73
Command inventory.....	73
Value-based command methods.....	74
Absolute values and adjustment values.....	74
Video source specification values.....	75
Power state controls.....	75
Source selection controls.....	76
General source controls.....	76
Additional VGA source controls.....	78
Additional Composite video source controls.....	78
Audio controls.....	79
Network controls.....	80
System controls.....	81

This appendix includes detailed instructions on how to set up your computer or room control system to remotely manage your SMART Board 800i5 interactive whiteboard system settings through an RS-232 serial interface.

Connecting your room control system to the ECP

By connecting a computer or room control system to the 4-pin connector on the ECP, you can select video inputs, start up or shut down your interactive whiteboard system and request information such as projector lamp use, current settings and network addresses.

APPENDIX B

Remotely managing your system through an RS-232 serial interface

i NOTE

On projectors with the RS-232 connector labeled **Control 9v** (rather than **Control**), pin 1 functions as a +9V DC power source only for use with older model ECPs such as the ones shipped with SMART UF55 projectors.

Serial interface settings

The serial interface of the projector acts as a Data Communications Equipment (DCE) device and its settings can't be configured. You must configure your computer's serial communication program (such as Microsoft® HyperTerminal) or your room control system's serial communication settings with the following values:

Setting	Value
Data Rate	19.2 kbps
Data Bits	8
Parity	None
Stop Bits	1
Flow Control	None

i NOTES

- Asynchronous mode is disabled by default in the projector.
- All commands should be in ASCII format. Terminate all commands with a carriage return.
- All responses from the projector are terminated with a command prompt. Wait until you receive the command prompt indicating that the system is ready for another command before you proceed.
- The room control feature of the projector is always on.

■ To configure your computer's serial interface

1. Turn on your computer, and then start your serial communications program or terminal emulation program.
2. Connect your computer to the serial connection cable you previously connected to the ECP.

APPENDIX B

Remotely managing your system through an RS-232 serial interface

3. Configure your serial interface settings using the values from the table in the previous section, and then press ENTER.

An “invalid cmd= ? for help” message appears, and the > character appears as a command prompt on the following line.

i NOTE

If no message or an error message appears, your serial interface configuration isn't correct. Repeat step 3.

4. Type commands to configure your settings.

i NOTES

- To see a list of commands available in the current operating mode, type ? and then press ENTER.
- If you're using a terminal emulation program, turn on your program's local echo setting to see characters as you type them.

Projector programming commands

This section documents the projector programming commands.

Projector power state controls

Your projector responds to commands only at certain power states and times.

There are five projector power states:

- Powering (startup)
- On (operating)
- Cooling
- Confirm off
- Idle (Standby mode)

Command inventory

Your projector responds to the commands in the tables on the following pages. To see a list of valid commands in the projector's current power state, type ? and press ENTER.

APPENDIX B

Remotely managing your system through an RS-232 serial interface

IMPORTANT

When entering commands, ensure there is a 10 millisecond delay between characters for reliable operation.

NOTES

- Send a command only after the projector sends a command prompt.
- Commands aren't case sensitive. Type commands exactly as they appear in the left column of the tables, with the proper value or setting in the center column.
- Check your entries carefully before entering your commands.
- Press ENTER after typing each command.
- After the projector executes a command, it generates a response.
- To prevent buffer overrun, don't send another command until you receive the next command prompt.

Value-based command methods

Absolute values and adjustment values

You can use the command's target range to set an absolute value for a command or cause an adjustment to be made to the current value. To create an adjustment command, add a plus (+) or minus (-) symbol instead of the equal symbol (=) before the value change you want to enter. All absolute values you enter must be within the command target range, and all adjustment values must equal a number within the command target range.

See the following examples for adjusting projector brightness:

```
>get brightness
```

```
brightness=55
```

```
>set brightness=65
```

```
brightness=65
```

```
>set brightness+5
```

```
brightness=70
```

APPENDIX B

Remotely managing your system through an RS-232 serial interface

```
>set brightness-15  
brightness=55
```

Video source specification values

You can use the source input field described in *Source selection controls* on next page in a command to set an absolute value or adjustment value to a source other than the active source. You can do this while the selected source is inactive, but the source device must be connected or you will receive an invalid command response.

See the following examples, where both an HDMI connector and a VGA 1 input are connected:

```
>set input=hdmi  
input=hdmi
```

```
>set brightness vga1=65  
brightness vga1=65
```

```
>set brightness vga1-7  
brightness vga1=58
```

Power state controls

These commands put the projector in and out of Standby mode and request the projector's current power state. The projector's power state determines whether certain commands are available at that time. These settings are available even when the projector is in Standby mode.

Command	Response
on	powerstate=[field]
off	powerstate=[field]
off now	powerstate=[field]
get powerstate	powerstate=[field]

The following table describes the power state commands:

Command	Description
on	Turns on the projector.
off	Starts the shutdown process. A dialog box appears with the message, "Press Power Button to Turn off Projector." You must send a second Off command within 10 seconds to put the projector into Standby mode.
off now	Shuts down the projector immediately. You can't delay or cancel this command.
get powerstate	Indicates the projector's current power state.

APPENDIX B

Remotely managing your system through an RS-232 serial interface

The following table describes the power state fields:

Field	Description
Powering	The projector is turning on.
On	The projector is on.
Cooling	The projector is cooling.
Confirm off	Confirm off is a non-selectable power state that is returned during stage one of the two-button Off sequence.
Idle	The projector is off but still receiving power (Standby mode).

Source selection controls

These commands switch input sources. The source type determines which commands can be accepted.

Command	Response	Available in Standby mode
get input	input=[field]	Yes
set input=[field]	input=[field]	No

The following table describes the source selection commands:

Command	Description
get input	Returns the projector's current input.
set input=[field]	Sets the input to one of the selectable fields.

The following table describes the source selection response fields:

Field	Description
VGA1	Switches source to the VGA 1 input connector.
VGA2	Switches source to the VGA 2 input connector.
Composite	Switches source to the Composite video connector. If you installed your interactive whiteboard system according to the instructions, this is the relay from the ECP.
S-Video	Switches source to the S-Video input connector.
HDMI	Switches source to the HDMI input port.
None	A non-selectable value that appears when you enter a "get input" command while the projector is in Standby mode.

General source controls

The following source controls apply to all input sources. HDMI connector source controls are described in this section. These controls are unavailable when the projector is in Standby mode. You can specify custom color values for all inputs.

These commands inform you of the current source settings.

APPENDIX B

Remotely managing your system through an RS-232 serial interface

Command	Response
get displaymode	displaymode=[current display mode setting]
get brightness	brightness=[current brightness setting]
get contrast	contrast=[current contrast setting]
get whitepeaking	whitepeaking=[current whitepeaking setting]
get degamma	degamma=[current degamma setting]
get red	red=[current red color setting]
get green	green=[current green color setting]
get blue	blue=[current blue color setting]
get cyan	cyan=[current cyan color setting]
get magenta	magenta=[current magenta color setting]
get yellow	yellow=[current yellow color setting]
get videofreeze	videofreeze=[current video freeze setting]
get cc	cc=[current closed captioning language setting]

These commands control the appearance of your source. These settings are unavailable when the projector is in Standby mode or when the source is disconnected. See *Value-based command methods* on page 74 for setting absolute and adjustment commands.

Command	Command target range	Response
set displaymode [target]	=SMARTpresentation =brightroom =darkroom =sRGB =User	displaymode=[target]
set brightness [value]	=0 to =100	brightness=[value]
set contrast [value]	=0 to =100	contrast=[value]
set whitepeaking [value]	=0 to =10	whitepeaking=[value]
set degamma [value]	=0 to =3	degamma=[value]
set red [value]	=0 to =100	red=[value]
set green [value]	=0 to =100	green=[value]
set blue [value]	=0 to =100	blue=[value]
set cyan [value]	=0 to =100	cyan=[value]
set magenta [value]	=0 to =100	magenta=[value]
set yellow [value]	=0 to =100	yellow=[value]
set videofreeze [target]	=on =off	videofreeze=[target]
set cc [target]	=cc1 =cc2 =off	cc=[target]

APPENDIX B

Remotely managing your system through an RS-232 serial interface

i NOTE

Typically, **cc1** displays English (U.S.) subtitles, while **cc2** displays other regional languages, such as French or Spanish, depending on television channel or media setup.

Additional VGA source controls

Your VGA source supports all the general source controls described in *General source controls* on page 76, as well as the commands listed in this section. These settings are unavailable when the projector is in Standby mode or when the VGA sources are disconnected.

i NOTE

Some of these commands are invalid with HDMI input and Composite video sources, and will return the response “invalidcmd=[command]”.

These commands inform you of the current VGA source settings.

Command	Response
get frequency	frequency=[current frequency offset setting]
get tracking	tracking=[current tracking offset setting]
get saturation	saturation=[current saturation setting]
get tint	tint=[current tint setting]
get sharpness	sharpness=[current sharpness setting]

These commands control the appearance of your VGA source. These settings are unavailable when the projector is in Standby mode or when the VGA source is disconnected. See *Value-based command methods* on page 74 for setting absolute and adjustment commands.

Command	Command target range	Response
set frequency [value]	=-5 to =5	frequency=[value]
set tracking [value]	=0 to =31	tracking=[value]
set saturation [value]	=0 to =100	saturation=[value]
set tint [value]	=0 to =100	tint=[value]
set sharpness [value]	=0 to =31	sharpness=[value]

Additional Composite video source controls

Your Composite video source supports all the general source controls described on the previous page as well as the commands listed in this section. These settings are unavailable when the projector is in Standby mode or when the Composite video source is disconnected.

APPENDIX B

Remotely managing your system through an RS-232 serial interface

i NOTE

Some of these commands are invalid with HDMI input and VGA video sources, and will return the response “invalidcmd=[command]”.

These commands inform you of the current Composite video source settings.

Command	Response
get saturation	saturation=[current saturation setting]
get tint	tint=[current tint setting]
get sharpness	sharpness=[current sharpness setting]

These commands control the appearance of your Composite video source. See *Value-based command methods* on page 74 for setting absolute and adjustment commands.

Command	Command target range	Response
set saturation [value]	=0 to =100	saturation=[value]
set tint [value]	=0 to =100	tint=[value]
set sharpness [value]	=0 to =31	sharpness=[value]

Audio controls

These commands control your projector’s internal audio amplifier, which affects sound passed through the projector to your external audio system (not included). Audio output controls aren’t defined by the video source. These settings are unavailable when the projector is in Standby mode.

These commands inform you of the current audio output settings.

Command	Response
get volume	volume=[current volume setting]
get mute	mute=[current mute setting]
get volumecontrol	volumecontrol=[current volume control setting]

These commands control your projector’s audio amplifier settings. See *Value-based command methods* on page 74 for setting absolute and adjustment commands.

Command	Command target range	Response
set volume [value]	=-20 to =20	volume=[value]
set mute [target]	=on =off	mute=[target]
set volumecontrol [target]	=on =off	volumecontrol=[target]

APPENDIX B

Remotely managing your system through an RS-232 serial interface

Network controls

These commands control your projector's network status and settings. These settings are located in the OSD, and are available even when the projector is in Standby mode. You must locally set the network and VGA out commands to on for the network abilities to work.

These commands inform you of the current network settings.

Command	Response
get netstatus	netstatus=connected netstatus=disconnected netstatus=disabled
get dhcp	dhcp=[current DHCP status]
get ipaddr	ipaddr=[current IP address]
get subnetmask	subnetmask=[current subnet mask number]
get gateway	gateway=[current network gateway]
get primarydns	primarydns=[current primary domain server]
get macaddr	macaddr=[current MAC address]

These commands control your network settings.

Command	Command target range	Response
set dhcp [target]	=on =off	dhcp=[current]
set ipaddr [target]	=0.0.0.0 to =255.255.255.255	ipaddr=[current]
set subnetmask [target]	=0.0.0.0 to =255.255.255.255	subnetmask=[current]
set gateway [target]	=0.0.0.0 to =255.255.255.255	gateway=[current]
set primarydns [target]	=0.0.0.0 to =255.255.255.255	primarydns=[current]

APPENDIX B

Remotely managing your system through an RS-232 serial interface

System controls

These commands enable you to switch system settings and access system information.

These commands inform you of the current system settings. These commands are unavailable when the projector is in Standby mode.

Command	Response
get autosignal	autosignal=[current auto signal detection setting]
get lampreminder	lampreminder=[current lamp reminder setting]
get highbrightness	highbrightness=[current lamp brightness setting]
get autpoweroff	autpoweroff=[current auto power off setting]
get zoom	zoom=[current zoom setting]
get projectorid	projectorid=[current projector ID number]
get hposition	hposition=[current horizontal position offset setting]
get vposition	vposition=[current vertical position offset setting]
get aspectratio	aspectratio=[current projector aspect ratio]
get projectionmode	projectionmode=[current projection mode]
get startupscreen	startupscreen=[current startup screen setting]
get resolution	resolution=[current input resolution]
get language	language=[current language setting]
get groupname	groupname=[current projector group name]
get projectormame	projectormame=[current projector name]
get locationinfo	locationinfo=[current projector location]
get contactinfo	contactinfo=[current support contact information]
get modelnum	modelnum=[current model number]
get videomute	videomute=[current video mute setting]
get serialnum	serialnum=[serial number]
get 3denable	3denable=[current 3D feature setting]
get 3dinvert	3dinvert=[current 3D invert setting]
get 3dformat	3dformat=[current 3D format]
get emergencyalertmsg	emergencyalertmsg=[current emergency alert message]
get emergencyalert	emergencyalert=[current emergency alert setting]

APPENDIX B

Remotely managing your system through an RS-232 serial interface

These commands inform you of the current system settings. These commands are available even when the projector is in Standby mode.

Command	Response
get lamphrs	lamphrs=[current lamp hours of operation]
get syshrs	syshrs=[current projector hours of operation]
get fwverddp	fwverddp=[current projector firmware version]
get fwvnet	fwvnet=[current network firmware version]
get fwvermpu	fwvermpu=[current processor firmware version]
get fwverecp	fwverecp=[current ECP firmware version]
get vgaoutnetenable	vgaoutnetenable=[current]
get signaldetected	signaldetected=[true or false]
get usb1source	usb1source=[Video source associated with the USB 1 connector on the ECP]
get usb2source	usb2source=[Video source associated with the USB 2 connector on the ECP]

These commands control the current system settings. These commands are unavailable when the projector is in Standby mode. See *Value-based command methods* on page 74 for setting absolute and adjustment commands.

Command	Command target range	Response
set autosignal [target]	=on =off	autosignal=[target]
set lampreminder [target]	=on =off	lampreminder=[target]
set highbrightness [target]	=on =off	highbrightness=[target]
set autopoweroff [value]	=0 to =240	autopoweroff=[value]
set zoom [value]	=0 to =30	zoom=[value]
set projectorid [value]	=0 to =99	projectorid=[value]
set hposition [value]	=0 to =100	hposition=[value]
set vposition [value]	=-5 to =5	vposition=[value]
set aspectratio [target]	=fill =match =16:9	aspectratio=[target]
set projectionmode [target]	=front =ceiling =rear =rear ceiling	projectionmode=[target]

APPENDIX B

Remotely managing your system through an RS-232 serial interface

Command	Command target range	Response
set startupscreen [target]	=smart =usercapture =preview	startupscreen=[target]
set language [target]	=Chinese (Simplified) =Chinese (Traditional) =Czech =Danish =Dutch =English =Finnish =French =German =Greek =Italian =Japanese =Korean =Norwegian =Polish =Portuguese (Brazil) =Portuguese (Portugal) =Russian =Spanish =Swedish	language=[target]
set groupname [description]	Enter a descriptor no more than 12 characters long.	groupname=[description]
set projectormame [description]	Enter a descriptor no more than 12 characters long.	projectormame=[description]
set locationinfo [description]	Enter a descriptor no more than 16 characters long.	locationinfo=[description]
set contactinfo [description]	Enter a descriptor no more than 16 characters long.	contactinfo=[description]
set videomute [target]	=on =off	videomute=[target]
set 3denable [target]	=on =off	3denable=[target]
set 3dinvert [target]	=leftright =rightleft	3dinvert=[target]
set 3dformat [target]	=interleaved =overunder	3dformat=[target]

APPENDIX B

Remotely managing your system through an RS-232 serial interface

Command	Command target range	Response
set emergencyalertmsg [description]	Enter a descriptor no more than 60 characters long.	emergencyalertmsg=[description]
set emergencyalert [target]	=on =off	emergencyalert=[target]

These commands control the current system settings. These commands are available when the projector is in Standby mode and when it is on.

Command	Command target range	Response
set restoredefaults	[none]	restoredefaults=done
set lamphrs [target]	=0	lamphrs=0
set vgaoutnetenable [target]	=on =off	vgaoutnetenable=[target]
set usb1source [target]	=vga1 =vga2 =hdmi =disabled	usb1source=[target]
set usb2source [target]	=vga1 =vga2 =hdmi =disabled	usb1source=[target]

NOTE

The **Network and VGA Out** setting's features are off by default. Select **on** to activate these features.

Appendix C

Remote control code definitions

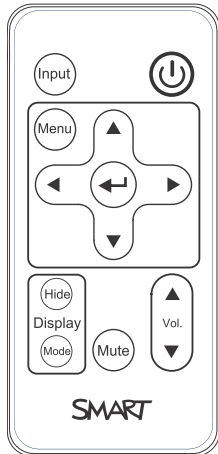

IR signal format: NEC1

Key	Repeat format	Vendor code		Key code	
		Byte 1	Byte 2	Byte 3	Byte 4
Input	F1	8B	CA	14	EB
Power (⏻)	F1	8B	CA	12	ED
Menu	F1	8B	CA	1B	E4
Up (▲)	F1	8B	CA	40	BF
Left (◀)	F1	8B	CA	42	BD
Enter (↵)	F1	8B	CA	13	EC
Right (▶)	F1	8B	CA	43	BC
Down (▼)	F1	8B	CA	41	BE
Hide	F1	8B	CA	15	EA
Volume up (▲)	F1	8B	CA	44	BB
Mode	F1	8B	CA	45	BA
Mute	F1	8B	CA	11	EE
Volume down (▼)	F1	8B	CA	46	B9

Appendix D

Hardware environmental compliance

SMART Technologies supports global efforts to ensure that electronic equipment is manufactured, sold and disposed of in a safe and environmentally friendly manner.

Waste Electrical and Electronic Equipment regulations (WEEE directive)

Waste Electrical and Electronic Equipment regulations apply to all electrical and electronic equipment sold within the European Union.

When you dispose of any electrical or electronic equipment, including SMART Technologies products, we strongly encourage you to properly recycle the electronic product when it has reached the end of its life. If you require further information, please contact your reseller or SMART Technologies for information on which recycling agency to contact.

Restriction of Certain Hazardous Substances (RoHS directive)

This product meets the requirements of the European Union's Restriction of Certain Hazardous Substances (RoHS) directive 2002/95/EC.

Consequently, this product also complies with other regulations that have arisen in various geographical areas, and that reference the European Union's RoHS directive.

Batteries

Batteries are regulated in many countries. Check with your reseller to find out how to recycle used batteries.

There are special regulations that must be met when shipping a product that has a lithium ion battery packaged with the product or shipping a lithium ion battery. When returning a SMART Technologies

APPENDIX D

Hardware environmental compliance

product which contains a lithium ion battery or returning a lithium ion battery, call SMART Technologies RMA for information on the special shipping regulations.

- 1.866.518.6791, Option 4 (U.S./Canada)
- 1.403.228.5940 (all other countries)

Packaging

Many countries have regulations restricting the use of certain heavy metals in product packaging. The packaging used by SMART Technologies to ship products complies with applicable packaging laws.

China's Electronic Information Products regulations

China regulates products that are classified as EIP (Electronic Information Products). SMART Technologies products fall under this classification and meet the requirements for China's EIP regulations.

For more information, see [smarttech.com/compliance](https://www.smarttech.com/compliance).

Index

3

- 3.5 mm audio connectors 23
- 3D support 65

A

- accessories
 - included 4
 - optional 6
- alarms 65
- aspect ratios 29-30, 32-33, 64
- audio
 - connections for 23
 - controlling volume of 25, 63, 79
 - muting 13, 79
 - resolving issues with 56

B

- batteries 12, 87
- Blu-ray 35

C

- cameras 34
- Chinese regulations 88
- closed captioning 63, 77
- composite video connections 33, 65, 76, 78
- connection diagrams
 - ECP 25
 - projector 22
- contact person 66

D

- DHCP 66, 80
- display modes 63
- DNS 66, 80
- document cameras 34
- drywall 8
- dust vii
- DVDs 35

E

- e-mail alerts 68
- ECP
 - about 4
 - lights and status of 57
 - using 24
- EIP regulations 88
- electrostatic discharge vii
- emergency alerts 65
- emissions vii
- environmental requirements vii
- eraser 5
- European Union regulations 87

F

- fans 51, 65
- flickering 54
- focus 21

G

- GoWire cable See SMART GoWire cable

INDEX

H

HD signal compatibility	32
HDMI connections	23, 65, 76
head space clearance	8
height	8
Help button	24
humidity	vii

I

image	
adjusting	22
focusing	21
resolving issues with	53
input selection	25, 65, 76
installation	
choosing a height	8
choosing a location	7
securing	9
interactive whiteboard	
about	2
indicators and controls of	49
maintaining	37
replacing an older model	8
using	24
IP address	66, 80

L

lamp module	
cleaning	37
replacing	39
resolving issues with	52
languages	63
laptop computers	
connecting	34
troubleshooting issues with	55
letterboxing	30, 32
light sources	7
lithium ion batteries	87
location	7, 66

Low Power mode	25
----------------	----

M

MAC address	80
MAC support	30
mounting template	8
mute control	13, 79

N

native video formats	29
network communication	23, 57, 66, 80

O

options	6
original packaging	59

P

packaging	88
passwords	58, 68
pen tray	
about	3
locking to the interactive whiteboard	9
pens	4
peripheral sources	34
pillarboxing	30, 32
power	23, 25, 62, 73, 75
projector	
about	3
adjusting settings for	14
adjusting the image of	22
cleaning	37
connection diagram for	22
displaying the name of	66
focusing the image of	21
installing	7
lights and status of	46
locating the serial number on	46
remotely managing	61, 71

INDEX

replacing the lamp of	39
routing cables from	9
securing to the boom	9
troubleshooting	50
using your remote control with	11
video format compatibility for	29

Q

quad VGA support	30
------------------	----

R

RCA connector pod	5
RCA jacks	23, 26
refresh rates	29-30
remote control	
about	4
code definitions for	85
installing the battery	12
using the buttons	13
RJ45 connector	23
RoHS directive	87
room control	25, 61, 71
RS-232 serial interface	23, 71

S

S-video connections	23, 33, 65, 76
SB8-CTRL room control adapter	26
SD signal compatibility	32
serial interface	See RS-232 serial interface
serial number	46
signal loss	53
SMART Board interactive whiteboard	See interactive whiteboard
SMART GoWire cable	5, 27
SMART Meeting Pro software (on SMART GoWire cable)	5, 27
SMART UF75 or UF75w projector	See projector
SMTP	68

SNMP	69
sound	See audio
startup screen	64
subnet mask	66, 80
SVGA support	30
SXGA support	30

T

temperatures, operating and storage	vii
transportation	59
trap destination address	67
troubleshooting	45

U

UF75 or UF75w projector	See projector
USB drives	25
USB receptacles	23, 25, 66
UXGA support	30

V

VGA connections	23, 65, 76, 78
VGA support	30
video	
connections for	23
format compatibility for	29
volume control	25, 79

W

warnings	iii
water and fluid resistance	vii
web page management	61
WEEE directive	87
whiteboard	See interactive whiteboard

X

XGA support	30
-------------	----

INDEX

Z

zoom

64

SMART Technologies

smarttech.com/support

smarttech.com/contactsupport