

Miniket Photo

VP - MS10(S/BL/R)
MS11(S/BL/R)
MS12(S/BL/R)
MS15(S/BL/R)

AF Auto Focus
CCD Charge Coupled Device
LCD Liquid Crystal Display

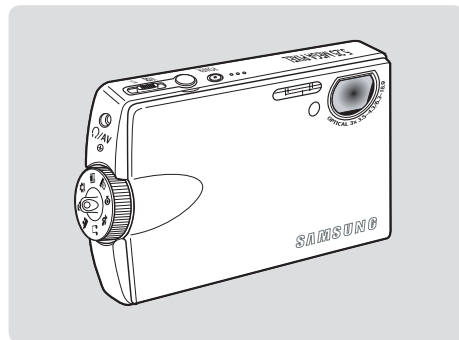

SAMSUNG

Owner's Instruction Book

Before operating the unit, please read this Instruction Book thoroughly, and retain it for future reference.

 This product meets the intent of Directive 89/336 CEE, 73/23 CEE, 93/68 CEE.

Use only approved battery packs.
Otherwise there is a danger of overheating, fire or explosion.
Samsung is not responsible for problems occurring due to using unapproved batteries.

Contents

<i>Notices and Safety Precautions</i>	8
Precautions when using the Miniket Photo	8
Notes Regarding COPYRIGHT	9
Notes Regarding Moisture Condensation	9
Notes Regarding the Miniket Photo	9
Notes Regarding the Battery Pack	10
Note Regarding the Lens	11
Notes Regarding the LCD Display	11
Precautions Regarding Service	11
Precautions Regarding Replacement Parts	11
<i>Getting to know your Miniket Photo</i>	12
Features	12
Accessories Supplied with the Miniket Photo	13
<i>Name of Each Part</i>	14
Rear & Left View	14
Front & Bottom View	15
LCD Display	16
OSD (On Screen Display in Photo Capture Mode/Photo View Mode)	16
OSD (On Screen Display in Movie Record Mode/Movie Play Mode)	17
OSD (On Screen Display in Music Mode)	18
OSD (On Screen Display in Voice Record / Voice Play / Settings Mode)	19
<i>How to Use the Battery Pack</i>	20
Battery Pack Installation / Ejection	20
Maintaining the Battery Pack	21
Charging the Battery Pack	24

Contents

<i>Getting Started</i>	25
Recording / Charging Indicator	25
Power Indicator	25
Using the Mode Dial.....	26
Using the DISPLAY Button.....	27
Using the MENU Button	27
Using the Shortcut Buttons	28
Using the Joystick	29
Structure of Folders and Files.....	30
Recording Time and Capacity	31
Using a mini SD card (Optional Accessory).....	32
Inserting / Ejecting a mini SD card (Optional Accessory)	33
Selecting the Memory Type.....	34
Before You Start Operating the Miniket Photo	35
<i>Setting the Miniket Photo</i>	36
Setting Memory	37
Selecting the Memory Type	37
Setting the File No. Function	38
Formatting the Memory.....	39
Viewing Memory Space	40
Adjusting the LCD Monitor	41
Adjusting the LCD Brightness.....	41
Setting Date / Time	42
Setting Date / Time	42
Setting Date Format.....	43
Setting Date / Time Display	44
Setting the System	45
Setting the NTSC/PAL	45
Setting the Beep Sound.....	46
Setting the Shutter Sound	47

Contents

Selecting Language	48
Setting the Mode Display	49
Setting the Auto Shut Off	50
Resetting the Miniket Photo	51
Photo Mode	52
Capturing	53
Capturing Images	53
Zooming In and Out	54
Viewing	55
Viewing Photo files on the LCD Monitor	55
Viewing Multiple Photo Files / Enlarging a Photo File	56
Cropping an Enlarged Photo File	57
Setting the Capturing Options	58
Using the Shortcut Buttons	58
Using the Scene Modes	60
Setting the Photo Size	61
Setting the Photo Quality	62
Setting the Metering Method	63
Setting the Self Timer	64
Setting the Multi Shot	65
Setting Digital Effects	66
Adjusting the Exposure – Exposure Compensation	67
Setting the ISO Speed (Sensitivity)	68
Setting the White Balance	69
Setting the Macro Mode	70
Setting the Flash	71
Setting the Sharpness	73
Setting the Focus Method	74
Setting the Anti-Shake Function (Image Stabilisation)	75
Setting the Digital Zoom	76
Setting the Imprint Option	77

Contents

Setting the Viewing Options	78
Using the Shortcut Buttons	78
Deleting Photo Files	82
Protecting Photo Files	83
Rotating a Photo File	84
Resizing Photos	85
Setting the Slideshow	86
Setting the DPOF (Digital Print Order Format) Function	87
Copying Photo Files	88
Movie Mode	89
Recording a Movie	90
Recording a Movie	90
Zooming In and Out	91
Playing a Movie	92
Playing a Movie on the LCD Monitor	92
Setting the Recording Options	93
Using the Shortcut Buttons	93
Setting the Program AE	95
Setting the White Balance	96
Setting the Digital Effects	97
Setting the Macro Mode	98
Setting the Movie Quality	99
Setting the Movie Size	100
Setting the Self Timer	101
Setting the Wind Cut	102
Setting the Viewing Options	103
Using the Shortcut Buttons	103
Deleting Movie Files	107
Protecting Movie Files	108
Setting the All Play	109
Copying Movie Files	110

Contents

Music Mode	111
Playing Music Files	112
Copying Music Files from a PC	112
Playing Music Files	113
Setting the Music Play Options	114
Using the Shortcut Buttons	114
Setting the Repeated Play	116
Setting the Equaliser	117
Deleting Music Files	118
Protecting Music Files	119
Voice Mode	120
Recording Voice Files	121
Recording Voice Files	121
Playing Voice Files	122
Playing Voice Files	122
Setting the Voice Play Options	123
Using the Shortcut Buttons	123
Setting the Repeated Play	125
Deleting Voice Files	126
Protecting Voice Files	127
Copying Voice Files	128
PC Cam mode	129
Using the PC Cam Function	130
Using the PC Cam Function	130
PictBridge mode	131
Printing with PictBridge	132
Printing with PictBridge	132
Storage Mode	133
Using as a Mass Storage Device	134
Using as a Mass Storage Device	134

Contents

Miscellaneous Information	135
Connecting to a PC	136
Supported USB Speed according to Operating System.....	136
Recommended System Requirements	136
Installing Software	137
Installing DV Media Pro 1.0	137
Installing DV Media Pro 1.0 / Video Studio	138
Connecting To Other Devices	139
Connecting to a PC Using USB Cable.....	139
Connecting to a TV Monitor.....	140
Connecting to a VCR.....	141
Printing Photos	142
Printing with DPOF	142
Cleaning and Maintenance	143
After using the Miniket photo	143
Cleaning the Body.....	144
Regarding the Battery.....	145
Using Abroad.....	146
Troubleshooting	147
Self-Diagnosis Display	147
Self-Diagnosis Display	147
Checklist.....	147
Using the Menu	149
Specifications	151
Index	153
Power Sources (United Kingdom Only)	155

Notices and Safety Precautions

Precautions when using the Miniket Photo

- ✦ Please note the following precautions for use:
 - ✦ Please keep this Miniket Photo in a safe place. The Miniket Photo contains a lens that can be damaged by shock. Keep out of reach of children.
-
- ✦ **Please note the following precautions for use:**
 - Do not place your Miniket Photo in a wet place. Moisture and water may cause the Miniket Photo to malfunction.
 - To avoid electric shock, do not touch your Miniket Photo or power cable with wet hands.
 - Do not use the flash close to someone else's eyes. The flash emits a strong light that may cause damage similar to direct sunlight on one's eyesight. Particular care should be observed if photographing infants, when the flash should be no less than 3 feet from your subject.
 - If the Miniket Photo is not working properly, please consult your nearest dealer or authorised SAMSUNG service centre. Disassembling the Miniket Photo by yourself may cause irrecoverable damage which will be difficult to repair.
 - Clean the Miniket Photo with a dry, soft cloth. Use a soft cloth moistened with a mild detergent solution for removing stains.
Do not use any type of solvent, especially benzene, as it may seriously damage the finish.
 - Keep your Miniket Photo away from rain and saltwater. After using, clean the Miniket Photo. Saltwater may cause the parts to corrode.
 - Using the earphone or headphone for an extended time can cause a serious damage to your hearing.
 - If you are exposed to a sound in higher than 85db for an extended time, you will be adversely affected on your hearing. The higher the sound is, the more seriously damaged your hearing is (an ordinary conversation is made in 50 to 60 db and the noise level on the road is approximately 80 db).
 - You are strongly advised to set the volume level to medium (the medium level is usually less than 2/3 of the maximum).
 - If you feel a ringing in the ear(s), lower the volume or stop using the earphone or headphone.
 - Do not use the earphone while you are driving a bicycle, automobile or motorcycle.
 - Otherwise it can cause a serious accident and, furthermore, it is prohibited by the law in some areas.
 - Using the earphone on the way, in particular, on the crosswalk can lead to a serious accident.
 - For your safety, make sure the earphone cable should not get in the way of your arm or other surrounding objects while you are taking exercise or a walk.

Notices and Safety Precautions

Notes Regarding COPYRIGHT

- ❖ Television programmes, movie video tapes, DVD titles, films and other programme materials may be copyrighted. Unauthorised recording of copyrighted materials may infringe on the rights of the copyright owners and is contrary to copyright laws.
- ❖ All the trade names and registered trademarks mentioned in this manual or other documentation provided with your Samsung product are trademarks or registered trademarks of their respective holders.

Notes Regarding Moisture Condensation

1. **A sudden rise in atmospheric temperature may cause condensation to form inside the Miniket Photo.**

For Example:

- ❖ Entering or leaving a heated place on a cold day might cause condensation inside the product.
- ❖ To prevent condensation, place the product in a carrying case or a plastic bag before exposing it to a sudden change of temperature.

Notes Regarding the Miniket Photo

1. **Do not leave the Miniket Photo exposed to high temperature (above 60°C or 140°F).**
For example, in a parked closed car in summer or exposed to direct sunlight.
2. **Do not let the Miniket Photo get wet.**
Keep the Miniket Photo away from rain, salt water, or any other form of moisture.
The Miniket Photo will be damaged if immersed in water or subjected to high levels of moisture.

Notices and Safety Precautions

Notes Regarding the Battery Pack

- ❖ It is recommended that you use the original Samsung Battery Pack that is available at the retailer where you purchased the Miniket Photo.
 - ❖ Make sure the Battery Pack is fully charged before starting to record.
 - ❖ To preserve battery power, keep the Miniket Photo turned off when you are not operating it.
 - ❖ If your Miniket Photo is left in STBY mode and the Battery Pack is inserted without being operated for more than 3 minutes, it will automatically turn itself off to protect against unnecessary battery discharge.
 - ❖ Make sure that the Battery Pack is inserted firmly in place.
 - ❖ The new Battery Pack provided with the product is not charged.
Before using the Battery Pack, you need to fully charge it.
 - ❖ Do not drop the Battery Pack. Dropping the Battery Pack may damage it.
 - ❖ Fully discharging a Lithium Ion battery damages the internal cells. The Battery Pack may be prone to leakage when fully discharged.
 - ❖ To avoid damage to the Battery Pack, make sure to remove the battery when no charge remains.
Clean the terminal to remove foreign substances before inserting the Battery Pack.
-
- * When the battery reaches the end of its life, please contact your local dealer.
Batteries must be disposed of as chemical waste.
 - * Be careful not to drop the Battery Pack when you release it from the Miniket Photo.

Notices and Safety Precautions

Note Regarding the Lens

- ✦ Do not film with the Miniket Photo's lens pointing directly at the sun. Direct sunlight can damage the CCD (Charge Coupled Device, the imaging sensor).

Notes Regarding the LCD Display

1. The LCD monitor has been manufactured using the high precision technology. However, there may be tiny dots (red, blue or green in colour) that appear on the LCD monitor. These dots are normal and do not affect the recorded picture in any way.
2. When you use the LCD monitor under direct sunlight or outdoors, it may be difficult to see the picture clearly.
3. Direct sunlight can damage the LCD monitor.

Precautions Regarding Service

- ✦ Do not attempt to service the Miniket Photo yourself.
- ✦ Opening or removing covers may expose you to dangerous voltage or other hazards.
- ✦ Refer all servicing to qualified service personnel.

Precautions Regarding Replacement Parts

- ✦ When replacement parts are required, be sure the service technician has used replacement parts specified by the manufacturer and with the same characteristics as the original part.
- ✦ Unauthorised substitutions may result in fire, electric shock or other hazards.

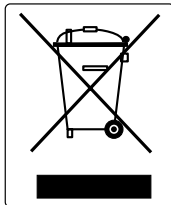

Correct Disposal of This Product (Waste Electrical & Electronic Equipment)

(Applicable in the European Union and other European countries with separate collection systems)

This marking shown on the product or its literature, indicates that it should not be disposed with other household wastes at the end of its working life. To prevent possible harm to the environment or human health from uncontrolled waste disposal, please separate this from other types of wastes and recycle it responsibly to promote the sustainable reuse of material resources. Household users should contact either the retailer where they purchased this product, or their local government office, for details of where and how they can take this item for environmentally safe recycling. Business users should contact their supplier and check the terms and conditions of the purchase contract. This product should not be mixed with other commercial wastes for disposal.

Getting to know your Miniket Photo

Features

- **High Resolution Digital Still Camera**
Employing 5Mega CCD Pixels with an available maximum resolution of 2592X1944. You can store images in internal memory or mini SD card.
- **MPEG4 Movie Recording**
You can record MPEG4 movie on the internal memory or mini SD card.
- **x 5 Digital Zoom (x 15 its original size)**
Allows the user to magnify an image up to x15 its original size.
- **Colour TFT LCD**
A high-resolution(150K) colour TFT LCD gives you clean, sharp images as well as the ability to review your recorded files immediately.
- **Anti-Shake Image Stabilisation**
With the Miniket Photo, you can minimize the effects of natural shaking movements when taking pictures of still objects in dark places.
- **Various Digital Effects**
The DSE (Digital Special Effects) allows you to give the film a special look by adding various special effects.
- **USB Interface for Data Transfer**
You can transfer still images and movie files or any other files to a PC using the USB interface.
- **PC Cam for multi-entertaining**
You can use the Miniket Photo as a PC Cam for video chatting and other PC Cam applications.
- **Voice Record / Playback with vast memory**
You can record voices and store it in the internal memory or mini SD card (optional accessory) and play back recorded voice clips.
- **Plus Advantage, Music**
With this Miniket Photo, you can play back Music files stored in the internal memory or mini SD card (optional accessory). Enjoy your favourite songs with the Music files with your Miniket Photo.
- **PictBridge/DPOF Function**
When you connect the Miniket Photo to a PictBridge-supported printer and DPOF (Digital Printing Order Format) function using a USB cable, you can print your stored pictures without a PC.
- **Multi OSD Language**
You can select the desired OSD language from OSD list.









Getting to know your Miniket Photo

Accessories Supplied with the Miniket Photo

- ✦ Make sure that the following basic accessories are supplied with your Miniket Photo.

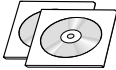
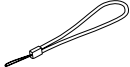
Basic Accessories

1. Lithium Ion Battery Pack
2. AC Power Adapter
3. Audio/Video Cable
4. USB Cable
5. Software CD
6. Hand Strap
7. Instruction Book/Quick Guide
8. Soft Case

1. Lithium Ion Battery Pack 	2. AC Power Adapter 	3. Audio/Video Cable 
4. USB Cable 	5. Software CD 	6. Hand Strap 
7. Instruction Book/Quick Guide 	8. Soft Case 	9. Earphones 

Optional Accessory

9. Earphones

[Notes]

- ✦ Parts and accessories are available at your local Samsung dealer and service centre.
- ✦ You can download programmes, the latest driver software, and CODECs from the Samsung Electronics webpage.

Name of Each Part

Rear & Left View

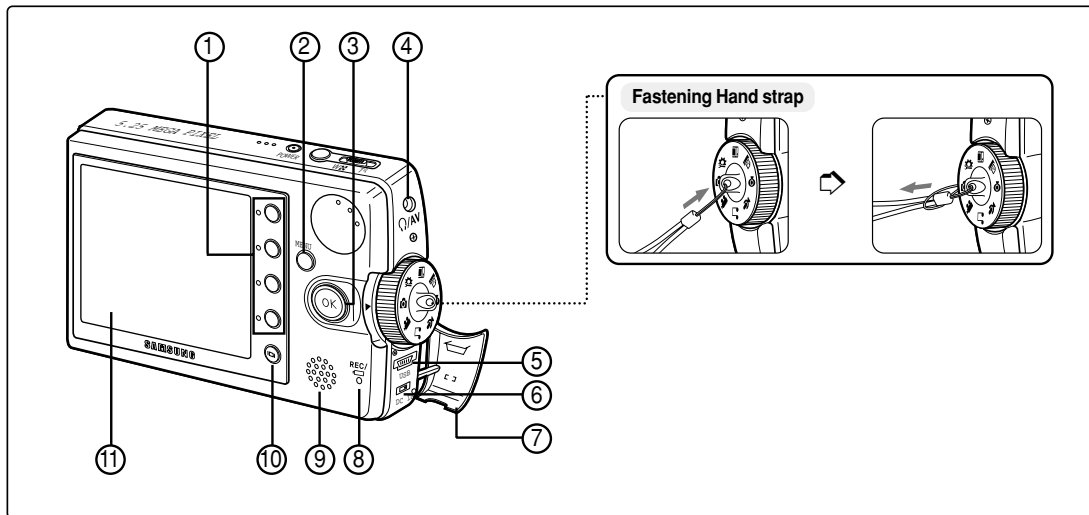

1. Shortcut Buttons
2. MENU button
3. Joystick (Up, Down, Left, Right, OK)
4. Earphones and AV jack
5. USB port
6. DC IN jack
7. Connector Cover
8. Recording / charging Indicator
9. Built-in Speaker
10. Display Button
11. LCD Monitor

Name of Each Part

Front & Bottom View

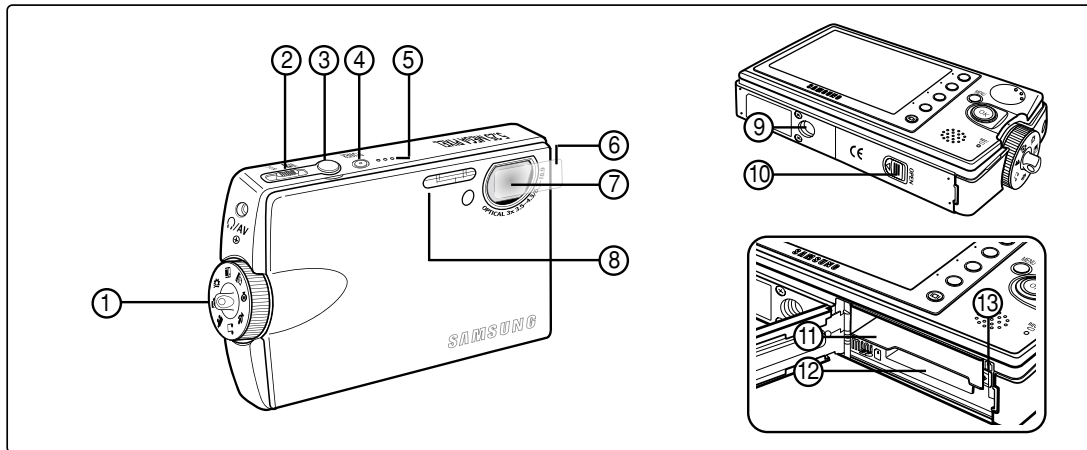

- | | |
|-------------------------|--|
| 1. Mode Dial | 8. Flash |
| 2. [W/T] Zoom Switch | 9. Tripod Receptacle |
| 3. Record / Stop Button | 10. OPEN Switch
(Battery / mini SD card Slot) |
| 4. Power Button | 11. Battery Slot |
| 5. Built-in Microphone | 12. Mini SD card slot |
| 6. Lens protection film | 13. Battery Lock Switch |
| 7. Lens | |

Usable mini SD card

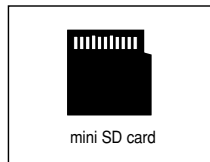

[Notes]

- ❖ There is a protecting film on the lens when the product is purchased. Please remove the protecting film before using it.
- ❖ A shock to the set may open the lens cover even when the power is turned off.
Turn the power on, and the lens cover will operate normally.

Name of Each Part : LCD Display

OSD (On Screen Display in Photo Capture Mode/Photo View Mode)

Photo Capture Mode

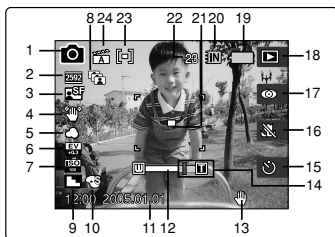

1. Mode Indicator
2. Image Size Indicator
3. Image Quality Indicator
4. Anti-Shake Indicator
5. White Balance Indicator
6. EV Indicator
7. ISO Speed Indicator
8. Multi Shot Indicator *
9. Sharpness Indicator
10. Digital Effect Indicator *
11. Date / Time Indicator
12. Optical Zoom Indicator
13. Shaking warning indicator
14. Digital Zoom Indicator
15. Self Timer (Shortcut Button) *
16. Macro (Shortcut Button)
17. Flash (Shortcut Button)
18. Record / Play (Shortcut Button)
19. Battery Life Indicator
20. Memory Type Indicator
21. Focus Indicator
22. Image Counter (recordable still image number)
23. Metering Mode Indicator
24. Scene Mode Indicator

Photo View Mode



1. Mode Indicator
2. Image Size Indicator
3. DPOF Indicator
4. Image Number
5. Delete (Shortcut Button)
6. Protection (Shortcut Button)
7. Slide (Shortcut Button)
8. Record / Play (Shortcut Button)
9. Battery Life
10. Memory Type Indicator
11. Image Counter (Current / Total)

Photo View Mode

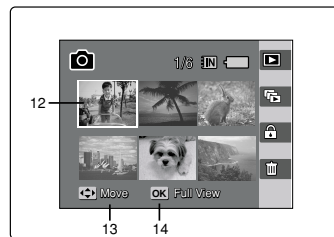

12. Current Selection
13. Move (Help Key)
14. Full View (Help Key)

[Notes]

- ✦ Functions not marked with * will be retained when the Miniket Photo is restarted after turning it off.
- ✦ The OSD indicators of this product shown above are based on model VP-MS10.
- ✦ The OSD indicators are based on when using the internal memory for storage.

Name of Each Part : LCD Display

OSD (On Screen Display in Movie Record Mode/Movie Play Mode)

Movie Record Mode

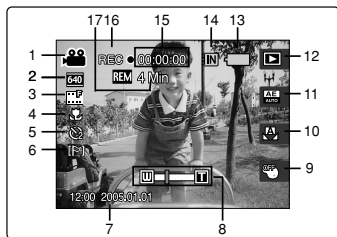

1. Mode Indicator
2. Image Size Indicator
3. Image Quality Indicator
4. Macro Indicator
5. Self Timer Indicator *
6. Windcut Indicator
7. Date / Time Indicator
8. Zoom In / Out Indicator
9. Digital Effect (Shortcut Button) *
10. White Balance (Shortcut Button)
11. Program AE (Shortcut Button)
12. Record / Play (Shortcut Button)
13. Battery Life Indicator
14. Memory Type Indicator
15. Counter (Elapsed Time)
16. Record / Stop Indicator
17. Remaining Time Indicator

Movie Play Mode

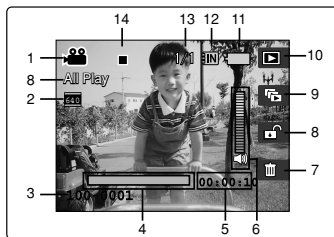

1. Mode Indicator
2. Image Size Indicator
3. Image Number
4. Playback Progress Bar
5. Counter (Elapsed Time)
6. Volume Indicator
7. Delete (Shortcut Button)
8. Protection (Shortcut Button)
9. All Play (Shortcut Button)
10. Record / Play (Shortcut Button)
11. Battery Life Indicator
12. Memory Type Indicator
13. Image Counter (Current / Total)
14. Stop / Play / Pause Indicator

[Note]

- ✦ Functions not marked with * will be retained when the Miniket Photo is restarted after turning it off.

Name of Each Part : LCD Display

OSD (On Screen Display in Music Mode)

Music Mode



1. File Property
2. Progress Bar
3. Counter (Elapsed Time / File Length)
4. Search (Help Key)
5. Play / Pause (Help Key)
6. Volume Control (Help Key)
7. Equalizer (Shortcut Button)
8. Volume Indicator

Music Mode



9. Mode Indicator
10. Current Folder Name
11. Title Name
12. Protection Indicator
13. Move (Help Key)
14. Folder (Help Key)
15. Play (Help Key)
16. Delete (Shortcut Button)
17. Hold (Shortcut Button)
18. Repeat (Shortcut Button)
19. File List Display (Shortcut Button)
20. Battery Life Indicator
21. Memory Type Indicator
22. File Number (Current / Total)

Name of Each Part : LCD Display

OSD (On Screen Display in Voice Record / Voice Play /Settings Mode)

Voice Record Mode

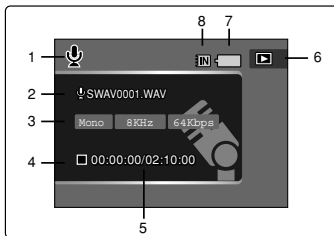

1. Mode Indicator
2. File Name
3. Current File Information
4. Standby / Record Indicator
5. Counter (Elapsed Time / Remaining Time)
6. Record / Play (Shortcut Button)
7. Battery Life Indicator
8. Memory Type Indicator

Voice Play Mode

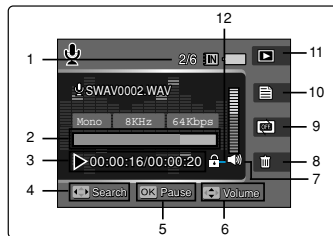

1. File Number (Current / Total)
2. Progress Bar
3. Counter (Elapsed Time / Remaining Time)
4. Search (Help Key)
5. Play / Pause (Help Key)
6. Volume Control (Help Key)
7. Volume Indicator
8. Delete (Shortcut Button)
9. Repeat (Shortcut Button)
10. File List Display (Shortcut Button)
11. Record / Play (Shortcut Button)
12. Protection Indicator

Settings Mode

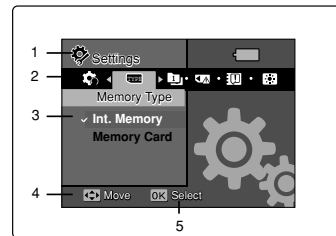

1. Mode Indicator
2. Menu Tab
3. Setup Items
4. Move (Help Key)
5. Select (Help Key)

How to Use the Battery Pack

Battery Pack Installation / Ejection

It is recommended to purchase one or more additional Battery Packs to allow continuous use of your Miniket Photo.

To insert the Battery Pack

1. Push the [OPEN] switch on the bottom side of the set in the direction of ① as shown in the diagram and open the lid. ②
2. Insert the Battery Pack into the battery slot until it softly clicks.
Make sure that the SAMSUNG logo is facing up while the set is placed as shown in the diagram.

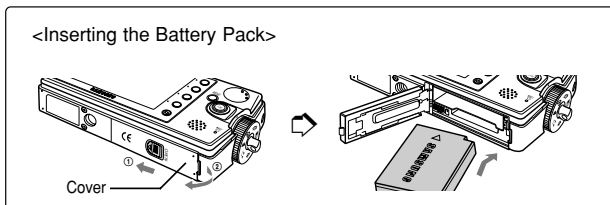

To eject the Battery Pack

1. Push the [Battery Lock Switch] in the direction as shown in the diagram to pop the Battery Pack out.
2. Pull the ejected Battery Pack out in the direction as shown in the diagram.

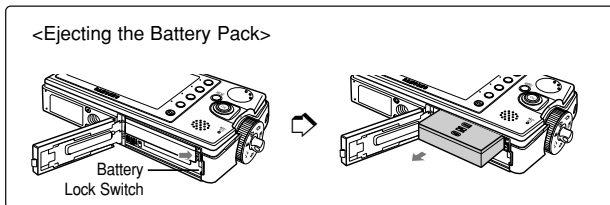

[Notes]

- ❖ Clean the terminals to remove any foreign substances before inserting the Battery Pack.
- ❖ If the Miniket Photo will not be in use for a while, remove the Battery Pack from the Miniket Photo.
- ❖ It is recommended to prepare fully charged additional Battery Packs for outdoor use.
- ❖ Additional Battery Packs are available at your local Samsung dealer and service centre.

[Warning]

- ❖ When you eject the Battery Pack from the Miniket Photo, hold the Battery Pack so as not to drop it.

How to Use the Battery Pack

Maintaining the Battery Pack

- ❖ The Battery Pack should only be recharged in an environment between 32°F(0°C) and 104°F(40°C).
- ❖ The life and capacity of the Battery Pack will be reduced if it is used in temperatures below 32°F(0°C) or left in temperatures above 104°F(40°C) for a long period.
- ❖ Do not put the Battery Pack near any heat sources (fire or flames, for example).
- ❖ Do not disassemble, process, press, or heat the Battery Pack.
- ❖ Do not allow the + and - terminals of the Battery Pack to be short-circuited. It may cause leakage, heat generation, fire, or overheating.
- ❖ If Miniket Photo fails to work when you turn on the power or the battery life indicator flickers, replace the Battery Pack.
- ❖ It is recommended to use original Battery Pack that is available at SAMSUNG service centre.

How to Use the Battery Pack

Using Time / Image Capacity According To Modes







Mode	Battery	SB-LH82 (820 mAh)		
Photo	Using Time	Approx. 85 minutes	Image Capacity	Approx. 230
	Conditions	<ul style="list-style-type: none"> ● Fully charged battery / Room temperature / 5M image size / Super Fine / Pictures captured at 20 sec interval / zoom in or out after each capturing ● Power off and on after each 8 captures / Default LCD brightness (14) ● 3 non-flash use / 1 flash use capturing 		
Movie	Continuous Recording Time	Approx. 80 minutes		
	Conditions	Fully charged battery / Room temperature Normal 320x240 Image Size No zooming		
Music	Continuous Playback time	Approx. 4 hours		
	Conditions	Fully charged battery / Room temperature LCD display turned off 44.1 KHz / 128 Kbps / 4MB / Default equaliser / Use earphones / Mid-level volume		
Voice	Continuous Playback Time	Approx. 4 hours		
	Conditions	Fully charged battery / Room temperature Mono / 64 Kbps / Use earphones / Mid-level volume		

- ❖ Figures shown above are measured under Samsung's test environment, and may differ from users and conditions.

How to Use the Battery Pack

Battery Level Display

The Battery Level Display shows the amount of battery power remaining in the Battery Pack.

Battery Level Indicator	State	Message
	Fully charged	-
	25 ~ 50% is used	-
	50 ~ 70% is used	-
	75 ~ 95% is used	-
	Over 95% is used The Miniket Photo will soon turn off. Change the Battery Pack as soon as possible.	-
	(flickers) The Miniket Photo will be forced to turn off soon.	"Low battery"

- ✦ It is recommended to fully charge the Battery Pack before use.



Charging time according to charging methods

Battery	Using AC Adapter	Using USB Charging
SB-LH82 (820 mAh)	Approx. 1 hr 40 min	Approx. 3 hr

- ✦ You may charge your Miniket Photo by connecting it to a PC with the USB cable.

How to Use the Battery Pack

Charging the Battery Pack

You can charge the Battery Pack using AC Power Adapter or USB cable.

1. Turn off the Miniket Photo by pressing the [POWER] button.

- ◆ Charging will begin only when the Miniket Photo is turned off (using AC Power Adapter or USB cable).

2. Insert the Battery Pack to the Miniket Photo.

3. Open the Connector Cover of the set.

4. Charge the Miniket Photo.

Connecting the AC Power Adapter

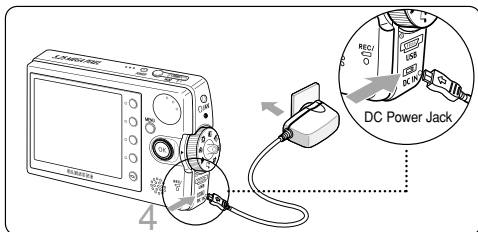

Connecting the USB Cable

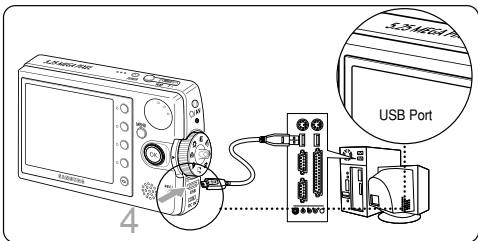

AC Power Adapter	Connect the AC Power Adapter with the Miniket Photo properly and plug the AC Power Adapter to the wall outlet.
USB Cable	Connect the USB Cable with the Miniket Photo properly and connect the other side to a USB port of a PC.

[Note]

- ✦ You may use the Miniket Photo powered by the AC Power Adapter indoors where available.

[Warning]

- ✦ It is recommended to fully charge the Battery Pack before use.
- ✦ You should only charge the battery in an environment between 32°F (0°C) and 104°F (40°C).
- ✦ If ambient temperature is too low when charging, it may take long to fully charge or may not fully charge the battery, which results the green indicator will not turn on.
- ✦ Before connecting the cable, make sure that you don't have any foreign substances between connectors.

Getting Started

Recording / Charging Indicator

The colour of the LED indicates the state of power or charging.

LED Colour	During Recording	During Charging
Red	Recording <Movie and Voice Mode>	-
Orange	-	Charging
Green	-	Fully Charged

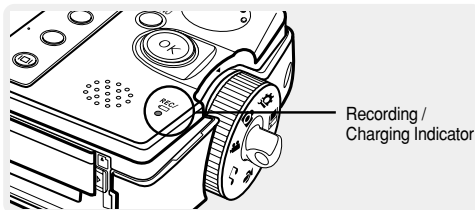

Power Indicator

LED Colour	Power
Blue	On

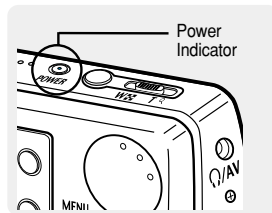

Getting Started

Using the Mode Dial

The Mode Dial is used to change the Miniket Photo mode. Available modes are Photo, Movie, Music, Voice, PC Cam, PictBridge, Storage, and Settings.

Setting the Mode

Turn the desired mode by turning the Mode Dial.

Within 1 ~ 2 seconds, the Miniket Photo switches to the designated mode.

Functions of Each Mode



Photo Mode

You can take / view photos.



PC Cam Mode

You can use the Miniket Photo as a PC Cam for video chatting and other PC Cam applications.



Movie Mode

You can record / play back video.



PictBridge Mode

When you connect the Miniket Photo to a PictBridge-supported printer with a USB cable, you can print your stored pictures without a PC.



Music Mode

You can play back music files (music).



Storage Mode

Connecting the Miniket Photo to a PC with a USB cable allows you to store various files in the Miniket Photo.



Voice Mode

You can record / play back voice clips.



Settings Mode

Using this mode, you can set / adjust settings regarding the LCD display, Date / Time, Reset, and Memory management.

Getting Started

Using the *DISPLAY* Button

1. If you press the [DISPLAY] button once, only Shortcut Button icons and focus indicator will appear on the screen.
2. If you press the [DISPLAY] button twice, only focus indicator will appear on the screen.
3. If you press the [DISPLAY] button 3 times, it switches to the initial (normal) display screen.

[Notes]

- ✦ Above description applies to the Photo and Movie mode.
- ✦ In Music and Voice modes, the [DISPLAY] button will not operate. The LCD screen goes off automatically after 30 seconds if there was no button operation. In that case, press any button to turn on the LCD monitor.

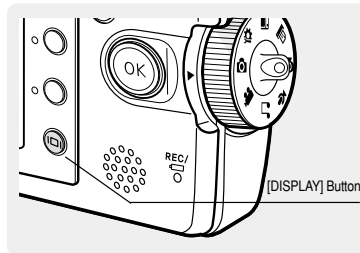

Using the *MENU* Button

1. Change the desired mode by setting the Mode Dial.
2. Press the [MENU] button.
3. Move the cursor by moving the joystick (up / down / left / right) to select desired menu item, and then press the joystick (OK) to confirm.
4. Press the [MENU] button to finish.

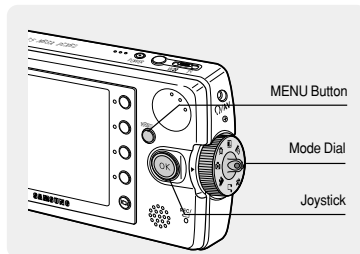

Getting Started

Using the Shortcut Buttons

For Photo, Movie, Music, Voice and PictBridge modes, icons that represent the most frequently accessed functions according to the selected mode are displayed on the LCD monitor to allow easier access. Using these buttons, you may directly access the functions.

1. Turn the Mode Dial to set the desired mode.
2. Press the [POWER] button to turn on the Miniket Photo.
3. On the LCD monitor, the function icon of shortcut button is displayed.

Press the shortcut button to access the function directly.

◆ In Photo Capture Mode, the icons of 4 shortcut buttons will be :

< [Movie] > < [Zoom] > < [Flash] > < [Power] >

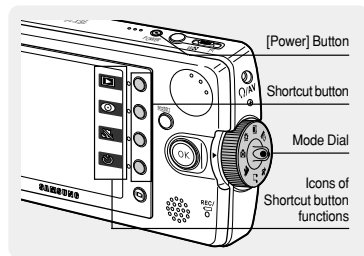





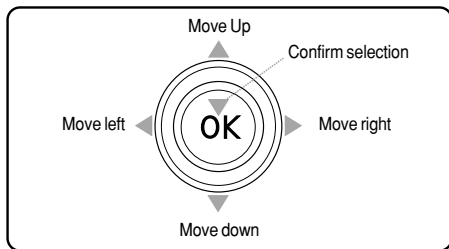
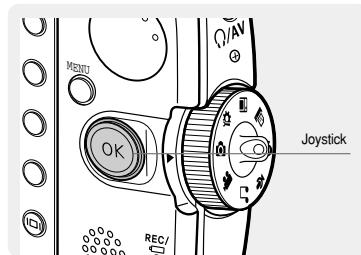

Getting Started

Using the Joystick

✦ The joystick is used to make a selection, move the cursor, select functions, and exit from the menu.

1. Move the cursor left / right by pressing the joystick.
2. Move the cursor up / down by pressing the joystick.
 - ◆ You can adjust the volume by moving the joystick (up / down) in *Movie / Music / Voice* playback modes.
3. Confirm your selection by pressing the joystick (OK).



	Menu Selection	While Playing Back
	Move Upwards	Increase Volume
	Move Downwards	Decrease Volume
	Move Left	-
	Move Right	-
	Confirm Selection	-

Getting Started

Structure of Folders and Files

The movie, photo, music, voice files and so forth files are stored in internal memory or mini SD card as below:

[Notes]

- ❖ Refer to page 32 for details on mini SD card.
- ❖ You can store general data files and folders in Miniket Photo.
- ❖ The maximum number of files you may store in DCIM is 99 where number of folders is 999.
- ❖ DCAM****.JPG: Photo files
- ❖ SMOV****.AVI: Movie files
- ❖ SWAV****.WAV: Voice files
- ❖ *****.MP3: Music files
- ❖ MISC: DPOF files are stored.
- ❖ Do not change the file or folder name except 'Free'.
- ❖ You can freely change the file or folder name under the 'Free'.
- ❖ Movie files that you have not made with this Miniket Photo may not play back on this Miniket Photo.
- ❖ <MUSIC1 ~ 4> folders are system folders created when manufacturing.
- ❖ Do not change or delete <MUSIC1 ~ 4> folders. Changing or deleting <MUSIC1 ~ 4> folder names will disable music playback.
- ❖ Only mp3 files are recognised under the system folder "MP3". Folders created under the system folder "MP3" other than <MUSIC1 ~ 4> cannot be recognised (Figure 1).
- ❖ User folders can be created under <MUSIC1 ~ 4> folders. MP3 files under a user created folder will be recognised and played back but the folder name will not be displayed on the LCD screen (Figure 2)
- ❖ Folders and files created by a user under a user folder will not be recognised (Figure 3).
- ❖ <MUSIC1 ~ 4> folders can contain up to 500 songs.

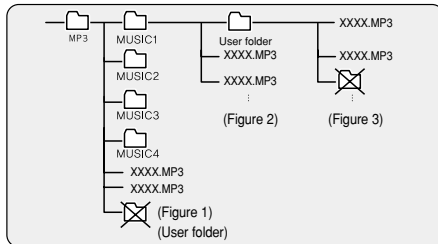
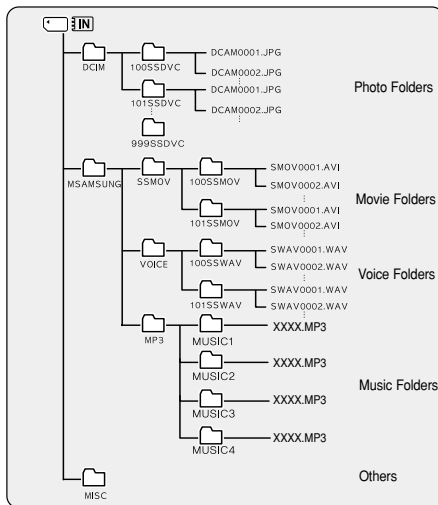









[Warning]

- ❖ Mini SD cards are made with precision technology. It is sensitive and vulnerable to electric shock, temperature and humidity, be cautious with handling the mini SD card to avoid losing data stored in it.
- ❖ Damaged data may not be recovered, and SAMSUNG is not responsible for lost data. Make sure to back up important files in PC separately.





Getting Started

Recording Time and Capacity

Photo Capacity

Image Size	Image Quality			
 5M	64M	Approx. 23	Approx. 51	Approx. 97
	128M	Approx. 47	Approx. 102	Approx. 195
	256M	Approx. 95	Approx. 204	Approx. 390
	512M	Approx. 190	Approx. 409	Approx. 780
 4M	64M	Approx. 30	Approx. 66	Approx. 128
	128M	Approx. 61	Approx. 132	Approx. 256
	256M	Approx. 122	Approx. 264	Approx. 512
	512M	Approx. 244	Approx. 528	Approx. 1024
 3M	64M	Approx. 37	Approx. 81	Approx. 157
	128M	Approx. 75	Approx. 163	Approx. 315
	256M	Approx. 151	Approx. 327	Approx. 630
	512M	Approx. 303	Approx. 655	Approx. 1260
 2M	64M	Approx. 60	Approx. 128	Approx. 227
	128M	Approx. 120	Approx. 256	Approx. 455
	256M	Approx. 240	Approx. 512	Approx. 910
	512M	Approx. 481	Approx. 1024	Approx. 1820
 1M	64M	Approx. 138	Approx. 292	Approx. 512
	128M	Approx. 273	Approx. 585	Approx. 1024
	256M	Approx. 546	Approx. 1170	Approx. 2048
	512M	Approx. 1092	Approx. 2340	Approx. 4096
 VGA	64M	Approx. 292	Approx. 512	Approx. 682
	128M	Approx. 585	Approx. 1024	Approx. 1365
	256M	Approx. 1170	Approx. 2048	Approx. 2730
	512M	Approx. 2340	Approx. 4096	Approx. 5461

Movie Recording Time

Image Size	Image Quality			
640 x 480 	64M	Approx. 2 min	Approx. 4 min	Approx. 8 min
	128M	Approx. 4 min	Approx. 8 min	Approx. 17 min
	256M	Approx. 8 min	Approx. 17 min	Approx. 34 min
	512M	Approx. 17 min	Approx. 34 min	Approx. 68 min
320 x 240 	64M	Approx. 4 min	Approx. 8 min	Approx. 17 min
	128M	Approx. 8 min	Approx. 17 min	Approx. 34 min
	256M	Approx. 17 min	Approx. 34 min	Approx. 68 min
	512M	Approx. 34 min	Approx. 68 min	Approx. 136 min

Voice Recording Time

64M	Approx. 138 min
128M	Approx. 273 min
256M	Approx. 546 min
512M	Approx. 1092 min

- ✦ Recording time based on the Miniket Photo set to mono / 64Kbps transfer rate.
- ✦ Voice recording time shown above is an estimation and is subject to recording conditions.

Music capacity

64M	Approx. 16 files
128M	Approx. 32 files
256M	Approx. 64 files
512M	Approx. 128 files

- ✦ Based on 128Kbps sampling / 4MB size.
- ✦ Capacity may vary depending on file size.

[Notes]

- ✦ Super Fine, Fine and Normal represent the compression ratio, and Super Fine has the highest image quality.
- ✦ 5M, 4M, 3M, 2M, 1M and VGA represent the image resolution, and 5M has the biggest image size.
- ✦ The recording time and the number of images shown above are approximation figures only when using the respective function.
- In actual use, using more than one function will reduce the capacity of each.
- ✦ Recording movie files on a mini SD card may have un-recordable fragment which may result shorter recording time / photo capacity.
- ✦ Recording time may vary depending on the compression ratio which results from the subject recorded.
- ✦ Movie file may not record / playback normally when using a mini SD card bigger than 1GB.

Getting Started

Using a mini SD card (Optional Accessory)

- ❖ Only mini SD cards are supported.
- ❖ Samsung is not responsible for data loss due to misuse.
- ❖ Turning the power off / ejecting the mini SD card during the memory operation such as formatting, deleting, recording, and playback may damage the data.
- ❖ You may modify the name of a file / folder stored in the mini SD card using a PC. Miniket Photo may not recognise modified files.
- ❖ It is recommended that you power off before inserting or ejecting the mini SD card to avoid losing data.
- ❖ It is not guaranteed that you may use a memory card formatted on other devices. Be sure to format your mini SD card using the Miniket Photo.
- ❖ Save important files separately on other media, such as floppy disk, hard disk, or CD.
- ❖ You have to format newly-purchased mini SD cards, mini SD cards with data on it that Miniket Photo cannot recognize or the cards that have data saved by other devices.
- ❖ A mini SD card has a certain life span. If you use it for a long time, you cannot record new data. In this case, you have to purchase a new mini SD card.
- ❖ A mini SD card is a precision electronic equipment. Do not bend it, drop it, or cause it to suffer a strong impact.
- ❖ Do not use or store in a place that has high temperature and humidity or dusty environment.
- ❖ Do not allow foreign substances on the mini SD card terminals. Use a soft dry cloth to clean the terminals if required.
- ❖ It is recommended to use a mini SD card case to avoid losing data from moving and static electricity.
- ❖ After a period of use, the mini SD card may get warm. This is normal, not a malfunction.
- ❖ Damaged data may not be recovered, and SAMSUNG is not responsible for the lost data. Make sure to back up important files separately on a PC.

Name of Each Part: mini SD card

- ❖ This Miniket Photo only supports the mini SD card.
- ❖ A mini SD card adapter is not supported by this Miniket Photo. The mini SD card adapter is used for other devices that supports only SD Card.
- ❖ A mini SD card adapter supports a mechanical write protection switch. Setting the switch prevents accidental erasure of files recorded on the mini SD card. To enable writing, move the switch up to the direction of terminals. To set write protection, move the switch down.

[Note]

- ❖ A mini SD card is an optional accessory.

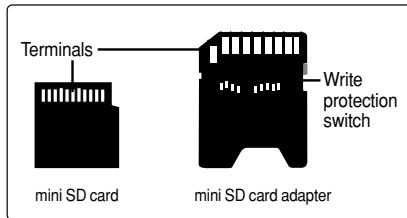

Getting Started

Inserting / Ejecting a mini SD card (Optional Accessory)

This product is equipped with an internal memory and the mini SD card is an optional accessory which is not provided with the package.

Inserting a mini SD card

1. Open Cover by sliding the [OPEN] switch on the bottom side.

- ◆ Slide the [OPEN] switch in the direction of (1) as shown in the diagram until it stops. Then open the lid.(2)

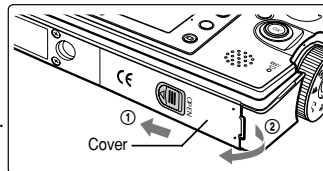

2. Insert a mini SD card into the slot until it softly clicks in the direction of the arrow shown in the diagram.

- ◆ The mini SD card terminals will face down while the LCD monitor faces up.

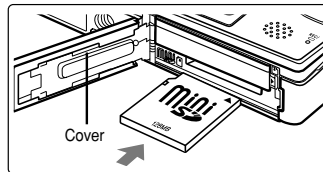

Ejecting a mini SD card

1. Slightly push the mini SD card inwards to pop it out.

2. Pull the mini SD card out of the slot and close the Cover.

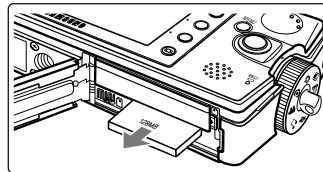

[Note]

- ✦ Make sure to format a mini SD card using the Miniket Photo.

Getting Started

Selecting the Memory Type

You can set the storage to the internal memory or mini SD card (Optional Accessory).
The OSD indicators are based on internal memory by default.

1. Press the [POWER] button to turn on the Miniket Photo.
2. Initially, the memory type is set to <Int. Memory> by default.
3. Insert a mini SD card into the slot (refer to page 33).
 - ◆ The message "Memory Card inserted. Change into the card?" appears on the screen.
4. Select the desired setting by moving the joystick left / right and press the joystick (OK).
 - ◆ Yes: Photo, movie, music and voice files will be stored in the inserted mini SD card.
 - ◆ No: Photo, movie, music and voice files will be stored in the internal memory.

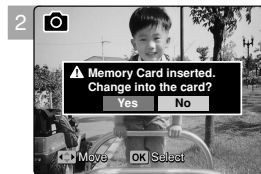

[Notes]

- ❖ If there is no mini SD card inserted, only the <Int. Memory> option will be available.
- ❖ When you insert the mini SD card in Setting Mode, the pop-up message will not display.
- ❖ Selected memory will be used for all modes.

Getting Started

Before You Start Operating the Miniket Photo

Before using the Miniket Photo, read this page thoroughly for easy operation. A mini SD card is an optional accessory and not included in the package.

1. **Insert the Battery Pack and insert a mini SD card into the mini SD card slot.** (Refer to page 33)
2. **Charge the Battery Pack by directly connecting the AC Power Adapter to the Miniket Photo.**
(Refer to page 24)
3. **Press the [POWER] button to turn on the Miniket Photo.**
4. **Select the desired mode by turning the [Mode Dial].**
5. **Press the [Record / Stop] button to take a picture, start recording movie / voice.**
 - ◆ To set focus, press the [Record / Stop] button halfway down.
6. **When finished, press the [POWER] button to turn the Miniket Photo off.**

How to set to Settings mode

1. Turn the Mode Dial to the *Settings* mode.

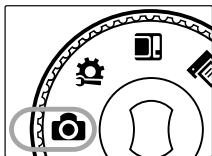

2. Press the [POWER] button to turn on the Miniket Photo.

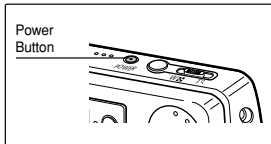

1

Setting the Miniket Photo

Setting Memory	37
Selecting the Memory Type	37
Setting the File No. Function	38
Formatting the Memory	39
Viewing Memory Space	40
Adjusting the LCD Monitor	41
Adjusting the LCD Brightness	41
Setting Date / Time	42
Setting Date / Time	42
Setting Date Format	43
Setting Date / Time Display	44
Setting the System	45
Setting the NTSC/PAL	45
Setting the Beep Sound	46
Setting the Shutter Sound	47
Selecting Language	48
Setting the Mode Display	49
Setting the Auto Shut Off	50
Resetting the Miniket Photo	51

Setting the Miniket Photo : Setting Memory

Selecting the Memory Type

You can set the storage to the internal memory or mini SD card (Optional Accessory).

1. Turn the Mode Dial to the **Settings** mode.
2. Press the [POWER] button to turn on the Miniket Photo.
3. Select <Memory Type> by moving the joystick left / right.
4. Select the desired option by moving the joystick up / down and then press the joystick (OK).
 - ◆ <Int. Memory>: Photo, movie, music and voice files are stored in the internal memory.
 - ◆ <Memory Card>: Photo, movie, music and voice files are stored in the external memory (mini SD card).
5. After you finish setting, turn the Mode Dial to the desired mode.

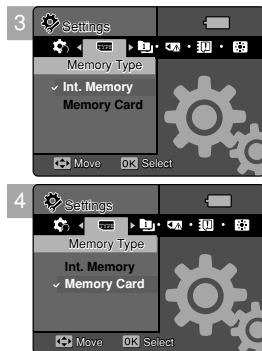

[Notes]

- ✦ If you insert a mini SD card when the Miniket Photo is on, the "pop-up message" will prompt you automatically to select the storage type except when in the Settings mode.
- ✦ If there is no mini SD card inserted, only the <Int. Memory> option will be available.
- ✦ System requires a small portion of memory space, actual storage capacity may differ from the printed memory capacity.
- ✦ The maximum recording time and image capacity is subject to change depending on the media used (refer to page 31).
- ✦ You can set this option in Photo, Movie, Music, Voice, and Settings modes using the MENU.

Setting the Miniket Photo : Setting Memory

Setting the File No. Function

You can set the file numbers so that they reset each time the mini SD card is formatted, or so that they count up continuously.

1. Turn the Mode Dial to the *Settings* mode.
2. Press the [POWER] button to turn on the Miniket Photo.
3. Select <File No.> by moving the joystick left / right.
4. Select the desired option by moving the joystick up / down and then press the joystick (OK).
 - ◆ <Reset>: When the storage memory is formatted, the file number goes back to its default value (100-0001).
 - ◆ <Series>: Numbering is continuous between the mini SD cards, so that the first file number assigned on a new mini SD card is 1 more than the last file number assigned on the previous mini SD card.
5. After you finish setting, turn the Mode Dial to the desired mode.

[Note]

- ✦ When you set <File No.> to <Series>, each file is assigned with a different number so as to avoid duplicating file names. It is convenient when you want to manage your files on a PC.

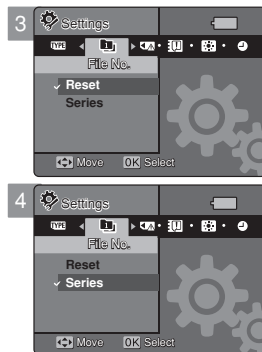

Setting the Miniket Photo : Setting Memory

Formatting the Memory

You can format the internal memory or the mini SD card to erase all files.

1. Turn the Mode Dial to the *Settings* mode.
2. Press the [POWER] button to turn on the Miniket Photo.
3. Select <Format> by moving the joystick left / right.
4. Select the desired option by moving the joystick up / down and then press the joystick (OK).
 - ◆ <Int. Memory>: Format the internal memory.
 - ◆ <Memory Card>: Format the external memory.

When the joystick (OK) is pressed, the message “All files will be deleted! Do you want to format?” appears. Select <Yes> or <No> by moving the joystick left / right and then press the joystick (OK).
5. After you finish formatting, turn the Mode Dial to the desired mode.

[Warning]

- ✦ Previous information can not be restored after formatting.

[Notes]

- ✦ There is no guarantee on the operation of a mini SD card which has not been formatted on the Miniket Photo. Make sure to format any mini SD card on the Miniket Photo.
- ✦ If there is no mini SD card inserted, only the <Int. Memory> option will be available.

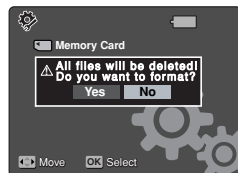
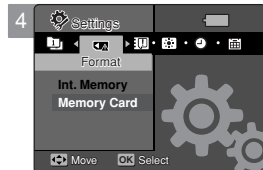
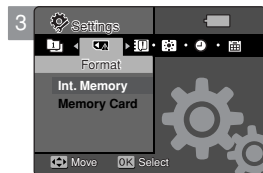

Setting the Miniket Photo : Setting Memory

Viewing Memory Space

You can check used memory space and total memory space of the Miniket Photo.

1. Turn the Mode Dial to the *Settings* mode.
2. Press the [POWER] button to turn on the Miniket Photo.
3. Select <Memory Space> by moving the joystick left / right.
4. The used memory space and total memory space are displayed.
5. After you finish viewing memory space, turn the Mode Dial to the desired mode.

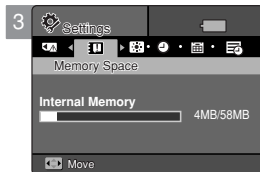

[Note]

- ✦ System requires a small portion of memory space, actual storage capacity may differ from the printed memory capacity.

Setting the Miniket Photo : Adjusting the LCD Monitor

Adjusting the LCD Brightness

You can adjust the brightness of the LCD monitor to compensate for ambient lighting conditions.

- 1 Turn the Mode Dial to the *Settings* mode.
- 2 Press the [POWER] button to turn on the Miniket Photo.
- 3 Select <LCD Brightness> by moving the joystick left / right.
- 4 Adjust the brightness by moving the joystick up / down then press the joystick(OK).
 - ◆ Moving the joystick up will brighten the screen whereas moving it down will darken the screen.
 - ◆ Brightness range: You can adjust the brightness between 00 ~ 31 steps.
5. After you finish adjusting, turn the Mode Dial to the desired mode.

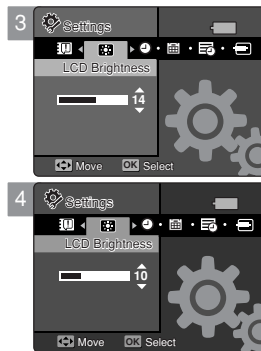

[Notes]

- ❖ A Brighter LCD screen setting consumes more battery power.
- ❖ Adjust the LCD brightness when the ambient lighting is too bright and the monitor is hard to see.
- ❖ LCD Brightness does not affect the brightness of images to be stored.

Setting the Miniket Photo : Setting Date / Time

Setting Date / Time

The built-in clock creates the time stamp. You can adjust the date/time using this menu.

1. Turn the Mode Dial to the *Settings* mode.
2. Press the [POWER] button to turn on the Miniket Photo.
3. Select <Date & Time Set> by moving the joystick left / right and then press the joystick (OK).
4. Set the desired value by moving the joystick up / down.
5. Move to the next item by moving the joystick left / right, and then set values by moving the joystick up / down.
 - ◆ Items are displayed in the order of the date format.
 - ◆ By default, it appears in the order of Year, Month, Date, Hour and Minute.
6. After setting the last item, press the Joystick(OK) to finish the setting.
7. After you finish setting, turn the Mode Dial to the desired mode.

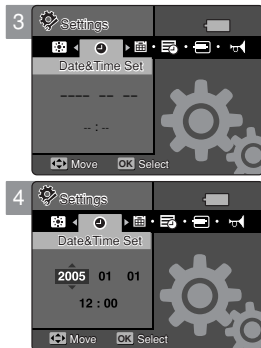

[Notes]

- ✦ You can display <Date & Time Set> on the LCD monitor by setting the <Date/Time> option other than to <Off>. Refer to page 44
- ✦ You can set the year up to 2037.

Setting the Miniket Photo : Setting Date / Time

Setting Date Format

You can select the date format to display.

1. Turn the Mode Dial to the *Settings* mode.
2. Press the [POWER] button to turn on the Miniket Photo.
3. Select <Date Format> by moving the joystick left / right.
4. Select the format by moving the joystick up / down, and then press the joystick (OK).
 - ◆ <YYYY/MM/DD>: The date is displayed in the order of Year / Month / Date.
 - ◆ <DD/MM/YYYY>: The date is displayed in the order of Date / Month / Year.
 - ◆ <MM/DD/YYYY>: The date is displayed in the order of Month / Date / Year.
5. After you finish setting, turn the Mode Dial to the desired mode.

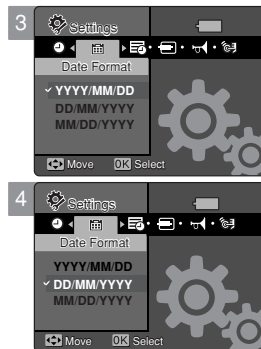

Setting the Miniket Photo : Setting Date / Time

Setting Date / Time Display

You can set to display date and time on the LCD monitor.

1. Turn the Mode Dial to the *Settings* mode.
2. Press the [POWER] button to turn on the Miniket Photo.
3. Select <Date/Time> by moving the joystick left / right.
4. Select the display option by moving the joystick up / down, and then press the joystick (OK).
 - ◆ <Off>: Date and Time are not displayed.
 - ◆ <Date>: The date is displayed.
 - ◆ <Time>: The time is displayed.
 - ◆ <Date & Time>: The date and time are displayed.
5. After you finish setting, turn the Mode Dial to the desired mode.
 - ◆ The selected Date/Time is displayed in Movie Record or Photo Capture mode.

[Note]

- ✦ Date and time information is displayed on the LCD screen in Photo capturing and Movie recording modes. In movie / photo playback modes, date and time information is not displayed on the LCD screen.

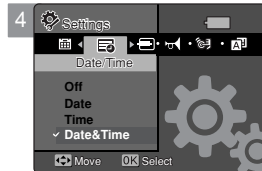
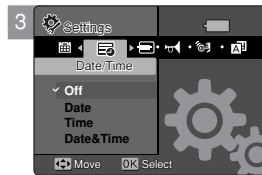

Setting the Miniket Photo : Setting the System

Setting the NTSC/PAL

You can set the Miniket Photo's output properly when playback on a TV .

1. Turn the Mode Dial to the *Settings* mode.
2. Press the [POWER] button to turn on the Miniket Photo.
3. Select <NTSC/PAL> by moving the joystick left / right.
4. Select the desired option by moving the joystick up / down and then press the joystick (OK).
 - ◆ <NTSC>: Sets to NTSC standard.
 - ◆ <PAL>: Sets to PAL standard.

Refer to page 146
5. After you finish setting, turn the Mode Dial to the desired mode.

[Warning]

- ✦ Recording and playback settings should be identical. NTSC recordings are properly played back in NTSC mode.
- ✦ If recording and playback settings are different, displayed video may not be perfect.
- ✦ When using a TV, be sure to set the same output setting. Playback on a TV is not available if the video format is different than that of Miniket Photo. For example, Miniket Photo is set to PAL and the TV video format is NTSC, then video playback on the TV is not available.

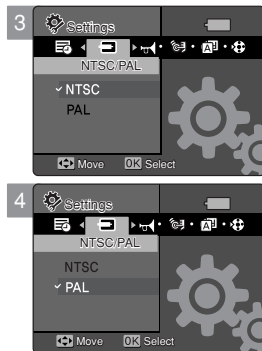

Setting the Miniket Photo : Setting the System

Setting the Beep Sound

You can set the beep sound to on/off. When on, a beep will sound every time a button is pressed.

1. Turn the Mode Dial to the *Settings* mode.
2. Press the [POWER] button to turn on the Miniket Photo.
3. Select <Beep Sound> by moving the joystick left / right.
4. Select the desired option by moving the joystick up / down and then press the joystick (OK).
 - ◆ <Off>: Turn the beep sound off.
 - ◆ <On>: Turn the beep sound on.
5. After you finish setting, turn the Mode Dial to the desired mode.

[Note]

- ✦ When the earphones or Audio / Video cable is connected to the Miniket Photo, the <Beep Sound> function will not operate.

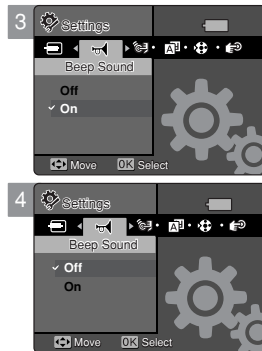

Setting the Miniket Photo : Setting the System

Setting the Shutter Sound

You can set the shutter sound to on / off.

1. Turn the Mode Dial to the *Settings* mode.
2. Press the [POWER] button to turn on the Miniket Photo.
3. Select <Shutter Sound> by moving the joystick left / right.
4. Select the desired option by moving the joystick up / down and then press the joystick (OK).
 - ◆ <Off>: Turn the shutter sound off.
 - ◆ <On>: Turn the shutter sound on.
5. After you finish setting, turn the Mode Dial to the desired mode.

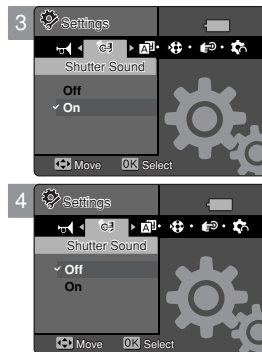

Setting the Miniket Photo : Setting the System

Selecting Language

You can select the desired language of the Miniket Photo.

1. Turn the Mode Dial to the *Settings* mode.
2. Press the [POWER] button to turn on the Miniket Photo.
3. Select <Language> by moving the joystick left / right.
4. Select the desired Language by moving the joystick up / down and then press the joystick (OK).
 - ◆ English / 한국어 / Español / Français / Português / Deutsch / Italiano / Nederlands / Polski / ΡῤῨῨÍĒĒ / 中文 / Magyar / % ∑ - / İĀ+*İḐ, İ† / Svenska
5. After you finish setting, turn the Mode Dial to the desired mode.

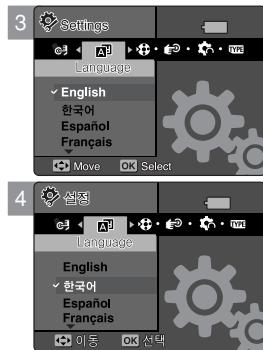

Setting the Miniket Photo : Setting the System

Setting the Mode Display

You can set to display the mode transition when you use the Mode Dial.

1. Turn the Mode Dial to the *Settings* mode.
2. Press the [POWER] button to turn on the Miniket Photo.
3. Select <Mode Display> by moving the joystick left / right.
4. Select the desired option by moving the joystick up / down and then press the joystick (OK).
 - ◆ <Off>: Turns the <Mode Display> off.
 - ◆ <On>: Turns the <Mode Display> on.
5. After you finish setting, turn the Mode Dial to the desired mode.

[Note]

- * Turning on the Miniket Photo when the Mode Dial is not set to the proper mode position, only the Samsung logo will appear. Turn the Mode Dial to a exact mode position.

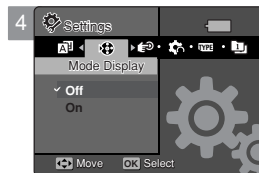
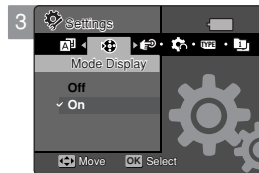
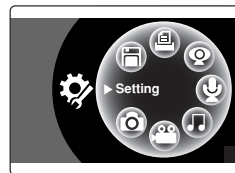

Setting the Miniket Photo : Setting the System

Setting the Auto Shut Off

To save battery power, you can set the Auto Shut Off function which turns off the Miniket Photo if there is no operation for a certain period of time.

1. Turn the Mode Dial to the *Settings* mode.
2. Press the [POWER] button to turn on the Miniket Photo.
3. Select <Auto Shut Off> by moving the joystick left / right.
4. Select the desired option by moving the joystick up / down and then press the joystick (OK).
 - ◆ <Off>: Cancel the Auto Shut Off function.
 - ◆ <3min>: Automatically turns off after 3 minutes.
 - ◆ <5min>: Automatically turns off after 5 minutes.
5. After you finish setting, turn the Mode Dial to the desired mode.

[Notes]

- ❖ The <Auto Shut Off> will not function when you connect the AC Power Adapter to the Miniket Photo.
The <Auto Shut Off> functions when the Battery Pack is the only power source.
- ❖ <Auto Shut Off> will only function when you set this function in Settings mode.
- ❖ Press the [POWER] button to revive the Miniket Photo.
- ❖ <Power Save LCD> will reduce the brightness of the LCD screen to save power.
- ❖ Press any key to revive the LCD screen when the <LCD Off> turned off the LCD screen.

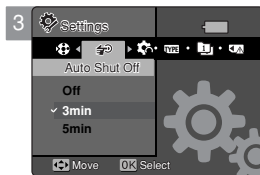

Setting the Miniket Photo : Setting the System

Resetting the Miniket Photo

You can reset the Miniket Photo to load default (factory) settings.

1. Turn the Mode Dial to the *Settings* mode.
2. Press the [POWER] button to turn on the Miniket Photo.
3. Select <Reset> by moving the joystick left / right.
4. Press the joystick (OK). Select an option by moving the joystick left / right and then press the joystick (OK).
 - ◆ <Yes>: Starts the reset function.
 - ◆ <No>: Cancel the reset function.

[Warning]

- ✦ If you reset the Miniket Photo, all functions you set are initialized to the default (factory) settings.

[Notes]

- ✦ User settings and date / time information are initialized when you reset.
- ✦ After resetting the Miniket Photo, set date / time (refer to page 42).

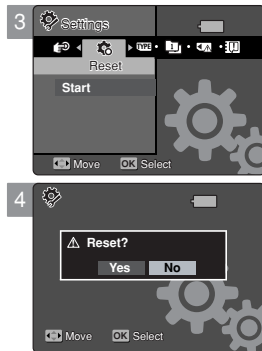

How to set to Photo mode

1. Turn the Mode Dial to *Photo* mode.

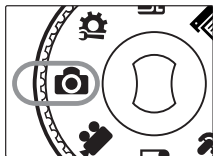

2. Press the [POWER] button to turn on the Miniket Photo.

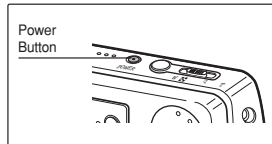

2 Photo Mode

Capturing	53
Capturing Images.....	53
Zooming In and Out	54
Viewing	55
Viewing Photo files on the LCD Monitor	55
Viewing Multiple Photo Files / Enlarging a Photo File	56
Cropping an Enlarged Photo File	57
Setting the Capturing Options	58
Using the Shortcut Buttons	58
Using the Scene Modes	60
Setting the Photo Size	61
Setting the Photo Quality	62
Setting the Metering Method	63
Setting the Self Timer	64
Setting the Multi Shot.....	65
Setting Digital Effects.....	66
Adjusting the Exposure – Exposure Compensation	67
Setting the ISO Speed (Sensitivity)	68
Setting the White Balance	69
Setting the Macro Mode	70
Setting the Flash	71
Setting the Sharpness	73
Setting the Focus Method.....	74
Setting the Anti-Shake Function (Image Stabilisation)	75
Setting the Digital Zoom	76
Setting the Imprint Option	77
Setting the Viewing Options	78
Using the Shortcut Buttons	78
Deleting Photo Files	82
Protecting Photo Files	83
Rotating a Photo File	84
Resizing Photos	85
Setting the Slideshow	86
Setting the DPOF (Digital Print Order Format) Function	87
Copying Photo Files.....	88

- ◆ Save important data / recordings separately on other media, to avoid accidental loss due to a system failure or other reasons.

Photo Mode : Capturing

Capturing Images

You can take still images as well as record video files.

1. Turn the Mode Dial to *Photo* mode.
2. Press the [POWER] button to turn on the Miniket Photo.
 - ◆ The Photo Capture screen appears.
3. Press the [Record / Stop] button halfway down to set the focus and exposure.
 - ◆ The focus indicator appears in green when the focus is set. If the focus indicator appears in red, try to set the focus again.
4. Fully press the [Record / Stop] button to take a picture.
5. After capturing, press the [POWER] button to turn off the Miniket Photo to prevent battery power consumption.



To Set the Focus

Press the
[Record/Stop]
button halfway
down.

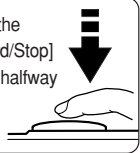

Fully press the
[Record/Stop]
button.

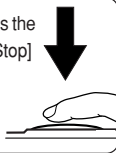

Pressing the button halfway down will set the focus, and fully pressing it down will release the shutter to record.

[Note]

- ✦ Shaking warning indicator will appear and blink when you press the [Record/Stop] button for a long time to set the focus in a dark place.

Photo Mode : Capturing

Zooming In and Out

Zooming allows you to change the size of the subject captured in a scene. You can take advantage of the 3x optical electro motion zoom lens.

1. Turn the Mode Dial to *Photo* mode.
2. Press the [POWER] button to turn on the Miniket Photo.

Zoom Out

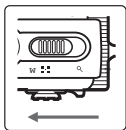

Move the [W/T] zoom switch to W (WIDE)

- The shot subject's size is reduced, and you can take a picture as if you were far away from the subject.
- On the zoom indicator in the LCD screen, the arrow moves to W.
- The smallest rate of zoom out is the default rate (original resolution of the subject).

Zoom In

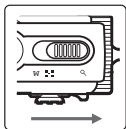

Move the [W/T] zoom switch to T (TELE).

- The subject is larger, and you can take a picture as if you were close to the subject.
- On the zoom indicator in the LCD screen, the arrow moves to T.
- The largest optical zoom ratio is 3x, which is the biggest among the basic zoom.

Zoom Out



Zoom In

[Notes]

- ✦ Frequent use of zooming may result in higher battery consumption.
- ✦ You can take advantage of 5x digital zoom as well as 3x optical zoom for a total of 15x zoom.
- ✦ Optical zoom preserves the image quality.

Photo Mode : Viewing

Viewing Photo Files on the LCD Monitor

It is handy and practical to view pictures using the LCD monitor almost anywhere such as in a car, indoors, or outdoors.

1. Turn the Mode Dial to *Photo mode*.
2. Press the [POWER] button to turn on the Miniket Photo.
3. Press the [Shortcut 1] button to switch to Photo View mode.
4. Move the joystick left / right to find the photo you want to view.
 - ◆ Each movement of the joystick goes to the previous / next photo.

[Notes]

- ✦ If there is no file stored to view, the message <No stored Photo!> appears.
- ✦ Moving the joystick right at the last photo will move to the first photo.
- ✦ Moving the joystick left at the first photo will move to the last photo.
- ✦ Moving the joystick left / right for more than 1 seconds will fast search.

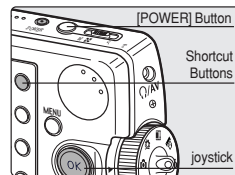

Photo Mode : Viewing

Viewing Multiple Photo Files / Enlarging a Photo File

Using the [W/T] zoom switch in Photo View mode, you can display multiple images on one LCD screen.

1. Turn the Mode Dial to *Photo* mode.
2. Press the [POWER] button to turn on the Miniket Photo.
3. Press the [Shortcut 1] button to switch to Photo View mode.

Displaying Multiple Photo Files (Zoom Out)

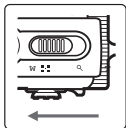

Move the [W/T] zoom switch to W (WIDE).

- The screen switches to multi-view.
 - The photo you were viewing in the single view previously is selected.
- Zooming out will not display multi-view if there was no stored photo.

Enlarging a Photo File (Zoom In)

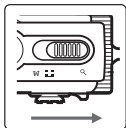

Move the [W/T] zoom switch to T (TELE).

- From the multi-view screen, it switches back to the single view screen. Move the [W/T] Zoom switch to T (TELE) again to enlarge the selected photo.

Zoom Out

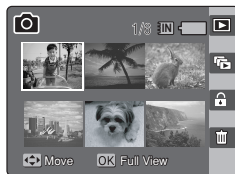

Zoom In



[Note]

- ✦ If there is no file stored to view, the message <No stored Photo!> appears.

Photo Mode : Viewing

Cropping an Enlarged Photo File

- ✦ You can enlarge and crop a photo.
- ✦ Using the [W/T] zoom switch in Photo View mode, you can display multiple images on one LCD screen.

1. Turn the Mode Dial to *Photo* mode.
2. Press the [POWER] button to turn on the Miniket Photo.
3. Press the [Shortcut 1] button to switch to Photo View mode.
4. Move the [W/T] zoom switch to T (TELE).
 - ◆ Selected photo is enlarged.
5. Move the joystick up / down / left / right to find the portion of the photo to crop.
6. Press the joystick (OK).
 - ◆ The message <Trim?> appears on the screen.
 - ◆ If there is not enough space to save the cropped image, a message <Memory Full!> is displayed.
7. Select an option by moving the joystick left / right and then press the joystick (OK).
 - ◆ <Yes>: Crops the image and saves it as a new file.
 - ◆ <No>: Cancels cropping.
8. If <Yes> is selected, cropped image is saved and displayed on the screen.

[Notes]

- ✦ You cannot crop an image smaller than 640 x 480 pixels (VGA size).
- ✦ The original photo is not overwritten by the cropped image. The cropped image is saved separately.
- ✦ The maximum magnification ratio differs depending on the image resolution:
5M – up to 3.86x, **4M** – up to 3.09x, **3M** – up to 2.67x
2M – up to 2.27x, **1M** – up to 1.60x
- ✦ If there is not enough space to save the cropped image, it cancels cropping automatically.
- ✦ You cannot crop a rotated image.
- ✦ You cannot crop a VGA image.
- ✦ Cropped image will have the same magnification ratio to the original.

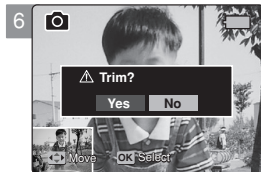

Photo Mode : Setting the Capturing Options

Using the Shortcut Buttons

Shortcut buttons are provided to allow users easy access to frequently used functions.

Switching to Photo View Mode

1. Turn the Mode Dial to *Photo* mode.
2. Press the [POWER] button to turn on the Miniket Photo.
3. Press the [Shortcut 1] button.
 - ◆ Each press of the [Shortcut 1] button toggles between the Photo capture / view modes.

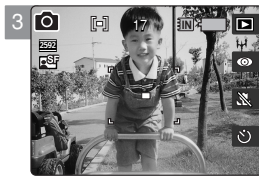

Setting the Flash

1. Turn the Mode Dial to *Photo* mode.
2. Press the [POWER] button to turn on the Miniket Photo.
3. Press the [Shortcut 2] button.
 - ◆ Each press of the [Shortcut 2] button cycles through the <@>-<< 4° >-< 4° >-< 4° >-< 4° > flash modes.

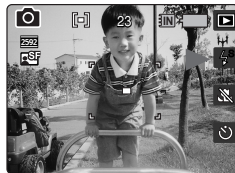

[Note]

- ✦ Regarding the flash use with the Scene modes, refer to page 72
- By default, the scene mode is set to <Manual>.

Photo Mode : Setting the Capturing Options

Using the Shortcut Buttons

Shortcut buttons are provided to allow users easy access to frequently used functions.



Setting the Macro

1. Turn the Mode Dial to *Photo* mode.
2. Press the [POWER] button to turn on the Miniket Photo.
3. Press the [Shortcut 3] button.
 - ◆ Each press of the [Shortcut 3] button cycles through <  > - <  > - <  >

[Notes]

- ✦ Regarding the Macro use with Scene modes, refer to page 72.
- ✦ By default, the scene mode is set to <Manual>.

Setting the Self Timer

1. Turn the Mode Dial to *Photo* mode.
2. Press the [POWER] button to turn on the Miniket Photo.
3. Press the [Shortcut 4] button.
 - ◆ Each press of the [Shortcut 4] button cycles through <  > - <  > - <  > (refer to page 64).

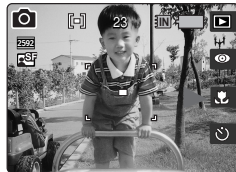

Photo Mode : Setting the Capturing Options

Using the Scene Modes

Scene Modes are preset automatic exposure modes based upon an internal computer program. It helps to set Miniket Photo, allowing users to have the best results under various conditions.

1. Turn the Mode Dial to *Photo* mode.
2. Press the [POWER] button to turn on the Miniket Photo.
3. Press the [MENU] button.
 - ◆ Menu screen appears.
4. Move the joystick left / right to select <Scene> Mode.
5. Select an option by moving the joystick up / down, and then press the joystick (OK).

Auto	For automatic balancing exposure and shutter speed for the best result	Close-up	For taking images of small subjects from a short distance, such as insects and flowers.
Manual	For manual exposure setting, turns off the Scene mode.	Sunset	For taking images of sunset.
Night	For taking images in evening time or under weak light source.	Dawn	For taking images of dawn.
Portrait	For focusing and emphasizing on the portrait while having out-focused background.	Backlight	For taking images of brighter subject when the background is more brighter than the subject.
Children	For taking images of fast moving children.	Fireworks	For taking images of fireworks and night view.
Landscape	For landscapes, balances and emphasizes green woods and blue sky.	Beach/Snow	For taking images when people or subjects are darker than the background because of reflected or strong light from sand or snow.

6. Press the [MENU] button to exit the menu.
 - ◆ An icon indicating the selected scene mode appears on the screen.
 - ◆ If <Manual> is selected, no icon will be displayed.

[Notes]

- ✦ Setting the Scene mode other than <Manual>, you may be limited to select <Metering>, <EV>, <ISO>, <White Balance>, <Macro>, <Flash>, and <Focus>.
- ✦ While the menu screen is displayed, pressing the [Record / Stop] button will exit the menu.

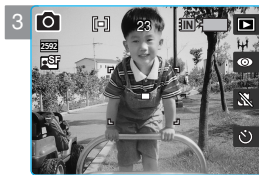

Photo Mode : Setting the Capturing Options

Setting the Photo Size

You can set the image resolution to meet your needs.

1. Turn the Mode Dial to *Photo* mode.
2. Press the [POWER] button to turn on the Miniket Photo.
3. Press the [MENU] button.
 - ◆ Menu screen appears.
4. Move the joystick left / right to select <Photo Size>.
5. Select an option by moving the joystick up / down, and then press the joystick (OK).
 - ◆ <5M> / <4M> / <3M> / <2M> / <1M> / VGA
6. Press the [MENU] button to exit the menu.
 - ◆ An icon indicating the selected size appears on the screen.

[Notes]

- ✦ Regarding detailed image capacity, refer to page 31.
- ✦ The photo capacity is an approximation and subject to recording conditions.
- ✦ For e-mail purposes, the <VGA> option is appropriate.
- ✦ While the menu screen is displayed, pressing the [Record / Stop] button will exit the menu.

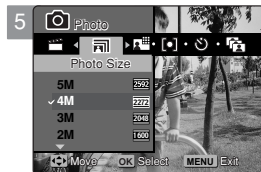

Photo Mode : Setting the Capturing Options

Setting the Photo Quality

You can set the image quality to meet your needs. Set the image quality before taking a picture.

1. Turn the Mode Dial to *Photo* mode.
2. Press the [POWER] button to turn on the Miniket Photo.
3. Press the [MENU] button.
 - ◆ Menu screen appears.
4. Move the joystick left / right to select <Photo Quality>.
5. Select an option by moving the joystick up / down, and then press the joystick (OK).
 - ◆ <Super Fine> / <Fine> / <Normal>
6. Press the [MENU] button to exit the menu.
 - ◆ An icon indicating the selected quality appears on the screen.

[Notes]

- ✦ Regarding detailed image capacity, refer to page 31.
- ✦ The photo capacity is an approximation and subject to recording conditions.
- ✦ While the menu screen is displayed, pressing the [Record / Stop] button will exit the menu.

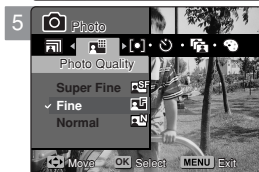
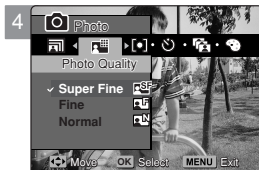

Photo Mode : Setting the Capturing Options

Setting the Metering Method

Metering controls the brightness and exposure of the picture taken. Select an appropriate metering method for the best results.

1. Turn the Mode Dial to *Photo* mode.
2. Press the [POWER] button to turn on the Miniket Photo.
3. Press the [MENU] button.
 - ◆ Menu screen appears.
4. Move the joystick left / right to select <Metering>.
5. Select an option by moving the joystick up / down, and then press the joystick (OK).

<Multi>	It splits the screen into many areas and adjusts the exposure accordingly based on the center screen and each area's brightness information.
<Center>	It meters only the area displayed in the square in the center of the LCD. You can select this when you want to accurately expose the subject regardless of background brightness.
<Spot>	It meters a very narrow area in the center. You can select this when the subject's surrounding area is very bright or there is a backlight, therefore you can meter the subject accurately.

6. Press the [MENU] button to exit the menu.
 - ◆ An icon indicating the selected Metering mode appears on the screen.

[Notes]

- ✦ Regarding metering with Scene modes, refer to page 72.
- ✦ While the menu screen is displayed, pressing the [Record / Stop] button will exit the menu.



Photo Mode : Setting the Capturing Options

Setting the Self Timer

Using this option, you can take a picture of yourself with delayed shooting.

1. Turn the Mode Dial to *Photo* mode.
2. Press the [POWER] button to turn on the Miniket Photo.
3. Press the [MENU] button.
 - ◆ Menu screen appears.
4. Move the joystick left / right to select <Self Timer>.
5. Select an option by moving the joystick up / down, and then press the joystick (OK).

Off	Cancels the Self Timer.
2 sec	Sets the delay interval to 2 seconds. Takes a photo 2 seconds after pressing the [Record/Stop]
10 sec	Sets the delay interval to 10 seconds. Takes a photo 10 seconds after pressing the [Record/Stop]

6. Press the [MENU] button to exit the menu.

[Notes]

- ✦ You can easily access this function by using the shortcut button (refer to page 59).
- ✦ It is recommended to use a tripod for best results on Self Timer pictures.
- ✦ Restarting the Miniket Photo will cancel the Self Timer setting.
- ✦ While the menu screen is displayed, pressing the [Record / Stop] button will exit the menu.

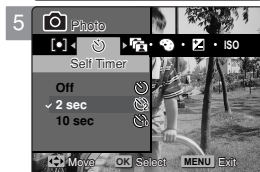

Photo Mode : Setting the Capturing Options

Setting the Multi Shot

You can take a series of pictures continuously with just one press of the shutter.

1. Turn the Mode Dial to *Photo* mode.
2. Press the [POWER] button to turn on the Miniket Photo.
3. Press the [MENU] button.
 - ◆ Menu screen appears.
4. Move the joystick left / right to select <Multi Shot>.
5. Select an option by moving the joystick up / down, and then press the joystick (OK).

Off	Disables Multi Shot and takes one photo at a time.
Normal	Enables Multi Shot and takes 3 photos in a row.
AEB	Enables Multi Shot and takes 3 photos in a row with exposure bracketing of -0.3 EV / 0 EV / +0.3 EV

6. Press the [MENU] button to exit the menu.
 - ◆ An icon indicating the selected Multi Shot mode appears on the screen.
 - ◆ If <Off> is selected, no icon will be displayed.

[Notes]

- ✦ When you set the Multi Shot enabled, you cannot use the flash.
- ✦ <Anti-Shake> is not available when you set the Multi Shot enabled.
- ✦ Restarting the Miniket Photo will cancel the Multi Shot setting.
- ✦ Regarding Multi Shot with Scene modes, refer to page 72.
- ✦ While the menu screen is displayed, pressing the [Record / Stop] button will exit the menu.

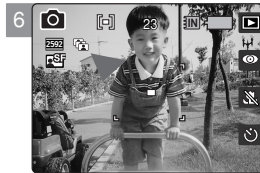

Photo Mode : Setting the Capturing Options

Setting Digital Effects

It supports various digital effects you can apply to your photos. Create a professional-looking photo with digital effects.

1. Turn the Mode Dial to *Photo* mode.
2. Press the [POWER] button to turn on the Miniket Photo.
3. Press the [MENU] button.
 - ◆ Menu screen appears.
4. Move the joystick left / right to select <Digital Effect>.
5. Select an option by moving the joystick up / down, and then press the joystick (OK).

Off	Cancel the <Digital Effect>.
Sepia	The picture is displayed in sepia colour similar to that of an old photograph.
Nega	Reverses the colours, creating the look of a negative.
BLK&WHT	Changes the images into black and white.

6. Press the [MENU] button to exit the menu.
 - ◆ The selected Digital Effect and icon appear on the screen.
 - ◆ If <Off> is selected, no icon will be displayed.

[Note]

- ✦ While the menu screen is displayed, pressing the [Record / Stop] button will exit the menu.



Photo Mode : Setting the Capturing Options

Adjusting the Exposure – Exposure Compensation

You can manually make exposure adjustments using EV Exposure Compensation which allows users to control the amount of light manually when the shutter-release button is released.

1. Turn the Mode Dial to *Photo* mode.
2. Press the [POWER] button to turn on the Miniket Photo.
3. Press the [MENU] button.
 - ◆ Menu screen appears.
4. Move the joystick left / right to select <EV>.
5. Select an option by moving the joystick up / down, and then press the joystick (OK).
 - ◆ -2.0 / -1.6 / -1.3 / -1.0 / -0.6 / -0.3 / 0 / +0.3 / +0.6 / +1.0 / +1.3 / +1.6 / +2.0
 - ◆ The screen brightness gets darker when the EV settings goes to a negative setting and gets brighter when it goes to a positive setting.
6. Press the [MENU] button to exit the menu.
 - ◆ An icon indicating the selected <EV> mode appears on the screen.
 - ◆ No icon will be displayed when it is set to <0>.

[Warning]

- ✦ Do not let the CCD be exposed to a strong light source for a long time. It may damage the CCD.

[Notes]

- ✦ Regarding EV setting in Scene modes, refer to page 72.
- ✦ While the menu screen is displayed, pressing the [Record / Stop] button will exit the menu.

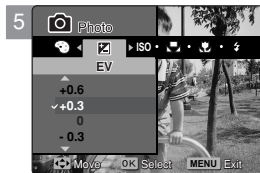

Photo Mode : Setting the Capturing Options

Setting the ISO Speed (Sensitivity)

ISO Speed is the rating of a film's sensitivity to light. Though Miniket Photo doesn't use film, they normally use the same rating system to describe the sensitivity of the Miniket's imaging sensor.

1. Turn the Mode Dial to *Photo* mode.
2. Press the [POWER] button to turn on the Miniket Photo.
3. Press the [MENU] button.
 - ◆ Menu screen appears.
4. Move the joystick left / right to select <ISO>.
5. Select an option by moving the joystick up / down, and then press the joystick (OK).

AUTO	Automatically sets the ISO according to the light brightness
100	The standard sensitivity rate, and therefore it is the usual shooting sensitivity rate.
200	When you use this in a dark place, you can increase the shutter speed, but it might come out grainy.
400	When you use this in a very dark place, you can greatly increase the shutter speed, but you may get a rough image due to severe graininess.

6. Press the [MENU] button to exit the menu.
 - ◆ An icon indicating the selected ISO Speed appears on the screen.
 - ◆ If <Auto> is selected, no icon will be displayed.

[Notes]

- ✦ The higher the ISO Speed number, the higher sensitivity to light. It results in brighter imaging under darker lighting.
- ✦ High ISO Speed setting may result in picture noise.
- ✦ Regarding ISO setting in Scene modes, refer to page 72.
- ✦ If <Anti-Shake> is set, ISO setting will be limited.
- ✦ While the menu screen is displayed, pressing the [Record / Stop] button will exit the menu.



Photo Mode : Setting the Capturing Options

Setting the White Balance

The White Balance allows calibration of the picture for accurate colour display in different lighting conditions. It is recommended to set the white balance prior to any recording.

1. Turn the Mode Dial to *Photo* mode.
2. Press the [POWER] button to turn on the Miniket Photo.
3. Press the [MENU] button.
 - ◆ Menu screen appears.
4. Move the joystick left / right to select <White Balance>.
5. Select an option by moving the joystick up / down, and then press the joystick (OK).

- ◆ To set the Custom WB, frame the white subject on the center. Press the joystick (OK) to set, or press the [MENU] button to cancel and exit to Menu screen. Photos captured after the Custom WB set will be affected by the setting.

AUTO	Automatically sets according to the shooting environment.
Daylight	Adjusts the colour according to daylight/indoor, outdoor light
Cloudy	You can select this when you cannot have daylight as a direct light, such as when it is partly-cloudy or cloudy.
Fluorescent H	Suitable in a halogen or 3-wavelength light environment.
Fluorescent L	Suitable for a fluorescent light environment.
Tungsten	Suitable for an incandescent light environment.
Custom WB	You can adjust the white balance as you wish based on the shooting environment.

6. Press the [MENU] button to exit the menu.
 - ◆ An icon indicating the selected white balance appears on the screen.
 - ◆ If <Auto> is selected, no icon will be displayed.

[Notes]

- ✦ In general outdoors picture taking, <Auto> setting will allow users to have best results.
- ✦ As the lighting condition changes, set the appropriate white balance before taking a picture.
- ✦ The subject used for <Custom WB> should be white. If not, the colour balance will not be natural.
- ✦ Regarding White Balance setting in Scene modes, refer to page 72.
- ✦ While the menu screen is displayed, pressing the [Record / Stop] button will exit the menu.

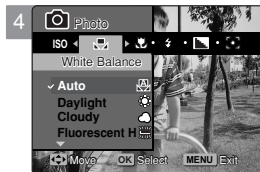

Photo Mode : Setting the Capturing Options

Setting the Macro Mode

Macro mode allows users to have a fine focused image of a close-up subject within 50 cm.

1. Turn the Mode Dial to *Photo* mode.
2. Press the [POWER] button to turn on the Miniket Photo.
3. Press the [MENU] button.
 - ◆ Menu screen appears.
4. Move the joystick left / right to select <Macro>.
5. Select an option by moving the joystick up / down, and then press the joystick (OK).

Macro Setting	Focus Range
<Off>	50 cm ~ ∞
<Macro>	W: 10 cm ~ ∞
	T: 30 cm ~ ∞
<Super Macro>	W: 1 cm ~ 5 cm

6. Press the [MENU] button to exit the menu.

[Notes]

- ◆ You can easily access this function by using the shortcut button (refer to page 59).
- ◆ Flash setting is not available when you set the Macro mode to <Super Macro>.
- ◆ Zooming is not available when you set the Macro mode to < Super Macro >.
- ◆ <Super Macro> is only available when the zoom is positioned to W end.
- ◆ When you use Macro mode and record a close-up subject, be careful not to shade your subject.
- ◆ As the distance gets closer, the focused area gets narrower.
- ◆ If the focus will not set, try to put more distance between you and the subject.
- ◆ It is recommended to use a tripod to avoid unstable picture taking and have best results.
- ◆ Regarding Macro setting in Scene modes, refer to page 72.
- ◆ While the menu screen is displayed, pressing the [Record / Stop] button will exit the menu.



Photo Mode : Setting the Capturing Options

Setting the Flash

Flash is very useful not only for brighter subjects at night, but also in daytime when there is not enough lighting on the subject, such as in a shadow, indoors, and in backlight situations.

1. Turn the Mode Dial to *Photo* mode.
2. Press the [POWER] button to turn on the Miniket Photo.
3. Press the [MENU] button.
 - ◆ Menu screen appears.
4. Move the joystick left / right to select <Flash>.
5. Select an option by moving the joystick up / down, and then press the joystick (OK).

Off	Flash will go off. Select this option when flash use is limited such as in a museum.
Auto	Flash will be set automatically according to lighting conditions.
Red-eye	Flash will be set automatically according to lighting conditions, with red-eye reduction.
Fill-in	Forces the flash to go on despite the lighting conditions.
Slow Sync.	To have a brighter subject and scene (backdrop), the Miniket Photo will first allow longer exposure and then throws the flash on the subject. It is recommended to use a tripod to avoid blurred images.

6. Press the [MENU] button to exit the menu.

[Notes]

- ✦ You can easily access this function by using the shortcut button (refer to page 58).
- ✦ Regarding Flash setting in Scene modes, refer to page 72.
- ✦ While the menu screen is displayed, pressing the [Record / Stop] button will exit the menu.
- ✦ When the flash is set, it fires twice (once for metering and once for capturing) to make the best result.



Photo Mode : Setting the Capturing Options

Supported Functions According to the Capturing Modes

It helps to set Miniket Photo according to each mode, allowing users to have the best results under various conditions.

Scene Modes												
[•]		O	O	O	O	O	O	O	O	O	O	O
		X	O	X	X	X	X	X	X	X	X	X
		X	O	X	X	X	X	X	X	X	X	X
	Off	O	O	O	O	O	O	O	O	O	O	O
		O	O	X	O	O	O	X	O	O	X	X
		O	O	X	O	O	O	X	O	O	X	O
	-0.3~-2.0EV	X	O	X	X	X	X	X	X	X	X	X
	0 EV	O	O	O	O	O	O	O	O	O	O	O
	0.3-2.0EV	X	O	X	X	X	X	X	X	X	X	X
ISO		O	O	O	O	O	O	O	O	O	O	O
		X	O	X	X	X	X	X	X	X	X	X
		X	O	X	X	X	X	X	X	X	X	X
		X	O	X	X	X	X	X	X	X	X	X
		O	O	O	O	O	O	O	O	O	O	O
		X	O	X	X	X	X	X	X	X	X	X
		X	O	X	X	X	X	X	X	X	X	X
		X	O	X	X	X	X	X	X	X	X	X
		X	O	X	X	X	X	X	X	X	X	X
		X	O	X	X	X	X	X	X	X	X	X
		X	O	X	X	X	X	X	X	X	X	X
		X	O	X	X	X	X	X	X	X	X	X
		O	O	O	O	O	O	O	O	O	O	O
		X	O	X	X	X	X	X	X	X	X	O
		O	O	X	O	O	X	X	X	X	X	X
		X	O	X	X	X	X	X	X	O	X	X
		X	O	O	X	X	X	X	X	X	X	X
		O	O	Pan	O	Pan	∞	O	∞	∞	Pan	Pan
[•]		X	O	X	X	X	X	X	X	X	X	X
		X	O	X	X	X	X	X	X	X	X	X
	OFF	O	O	O	O	O	O	O	O	O	O	O
		O	O	X	X	X	X	X	X	X	X	X

- ♦ Pan: Pan Focus that adjusts the focus to entire screen has focused. Focuses on the deepest DOF (Depth of Field) position which makes the both near and distant view are in focus.
- ♦ ∞: Infinite Focus that sets the focus to infinity. It sets the focus to a subject at far away which results parallel light reception to the lens. All subjects with a certain distance are in focus and it is useful for outdoor landscape images.

[Notes]

- ❖ Do not use flash in a place where flash use is limited, such as in a museum.
- ❖ Frequent use of flash consumes more battery power.
- ❖ You cannot use flash with <Multi Shot>.
- ❖ Effective flash range distance is less than 2 m (7 ft).

Photo Mode : Setting the Capturing Options

Setting the Sharpness

You can set the sharpness of the image to be captured. Set the image sharpness before taking a picture.

1. Turn the Mode Dial to *Photo* mode.
2. Press the [POWER] button to turn on the Miniket Photo.
3. Press the [MENU] button.
 - ◆ Menu screen appears.
4. Move the joystick left / right to select <Sharpness>.
5. Select an option by moving the joystick up / down, and then press the joystick (OK).

<Soft>	The image's edges display softly and you can select this when you want to edit it on the computer.
<Normal>	The image's edges display sharply, and you can select this when you want to print.
<Sharp>	As the image's edges are sharpened and emphasised, some noise might occur although it is seen clearly.

6. Press the [MENU] button to exit the menu.
 - ◆ An icon indicating the selected sharpness appears on the screen.
 - ◆ No icon will be displayed when it is set to <Normal>.

[Note]

- ✦ While the menu screen is displayed, pressing the [Record / Stop] button will exit the menu.



Photo Mode : Setting the Capturing Options

Setting the Focus Method

To have clear image of the subject, you need to set the focus on the subject. Select an appropriate focus method for the best results.

1. Turn the Mode Dial to *Photo* mode.
2. Press the [POWER] button to turn on the Miniket Photo.
3. Press the [MENU] button.
 - ◆ Menu screen appears.
4. Move the joystick left / right to select <Focus>.
5. Select an option by moving the joystick up / down, and then press the joystick (OK).

<Multi AF>	You can select this when the subjects are not located in the center of the screen, but you have to focus on numerous spots.
<Center AF>	You can select this when the subject is located in near to middle of the screen.
<Spot AF>	You can select this when the subject is located in the center of the screen exactly.

6. Press the [MENU] button to exit the menu.
 - ◆ An icon indicating the selected focusing mode appears on the screen.

[Notes]

- ✦ Regarding Focus Method setting in Scene modes, refer to page 72.
- ✦ While the menu screen is displayed, pressing the [Record / Stop] button will exit the menu.



Photo Mode : Setting the Capturing Options

Setting the Anti-Shake Function (Image Stabilisation)

With the Miniket Photo, you can reduce unstable images by minimizing the effects of natural shaking movements when taking pictures of still objects in dark places.

Anti-Shake provides a more stable picture when:

- ◆ Recording with zoom
- ◆ Recording with a slower shutter speed

1. Turn the Mode Dial to *Photo* mode.
2. Press the [POWER] button to turn on the Miniket Photo.
3. Press the [MENU] button.
 - ◆ Menu screen appears.
4. Move the joystick left / right to select <Anti-Shake>.
 - ◆ <Off>: Disables Anti-Shake function.
 - ◆ <On>: Enables Anti-Shake function.
6. Press the [MENU] button to exit the menu.
 - ◆ If <On> is selected, <  > icon appears on the screen.

Anti-Shake

When it is activated, one shutter release will take 3 contiguous pictures to produce one stabilised picture. The stabilisation range is up to 2% in all 4 directions (up / down / left / right). For example, a rectangle subject of 100mm width and height can be stabilised up to 2mm movement in vertical / horizontal direction.

The Method

When the Miniket Photo has shaking movement, specific subject's outlines from 3 contiguous captured images will be recognised and processed to concur and produces stabilised picture.

[Warning]

- ◆ Anti-Shake has no effect on a moving subject.
- ◆ Purposely moving the Miniket Photo or taking pictures in a moving vehicle will reduce the Anti-Shake's effect.
- ◆ It is recommended to use separate lighting and tripod (optional accessory) when the <Anti-Shake> is not enough to have clear result.

[Notes]

- ◆ Anti-Shake does not work for movie recording.
- ◆ You can reduce unstable images by minimizing the effects of natural shaking movements when taking pictures of still objects in dark places.
- ◆ <Multi Shot> mode will cancel the <Anti-Shake> setting.
- ◆ <Anti-Shake> setting is available when you set the Flash to off.
- ◆ When <Anti-Shake> is enabled, it takes about 5 seconds to process and save the image.
- ◆ Regarding <Anti-Shake> use with Scene modes, refer to page 72.
- ◆ While the menu screen is displayed, pressing the [Record / Stop] button will exit the menu.

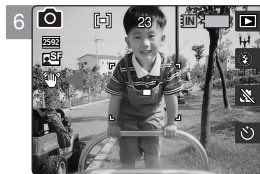

Photo Mode : Setting the Capturing Options

Setting the Digital Zoom

As well as the 3x optical zoom, this Miniket Photo supports 5x digital zoom which produces a total of 15x zoom. Exceeding the optical zoom limit will automatically apply digital zooming when available. The quality may deteriorate when using the digital zoom.

1. Turn the Mode Dial to *Photo* mode.
2. Press the [POWER] button to turn on the Miniket Photo.
3. Press the [MENU] button.
 - ◆ Menu screen appears.
4. Move the joystick left / right to select <Digital Zoom>.
5. Select an option by moving the joystick up / down, and then press the joystick (OK).
 - ◆ <Off>: Disables digital zoom. Only optical zoom 3x will be supported for zooming
 - ◆ <On>: Enables digital zoom. Attempts to zoom in more than 5x will automatically apply digital zooming (up to 15x).
6. Press the [MENU] button to exit the menu.
 - ◆ When using the digital zoom switch, an indicator appears on the screen.

[Notes]

- ✦ While the menu screen is displayed, pressing the [Record / Stop] button will exit the menu.

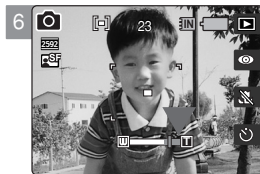

Photo Mode : Setting the Capturing Options

Setting the Imprint Option

You can imprint Date & Time on pictures taken. To place the date / time information on your picture, set this option.

1. Turn the Mode Dial to *Photo* mode.
2. Press the [POWER] button to turn on the Miniket Photo.
3. Press the [MENU] button.
 - ◆ Menu screen appears.
4. Move the joystick left / right to select <Imprint>.
5. Select an option by moving the joystick up / down, and then press the joystick (OK).
 - ◆ <Off>: Cancels imprinting.
 - ◆ <Date>: Imprints Date only.
 - ◆ <Date & Time>: Imprints Date and Time.
6. Press the [MENU] button to exit the menu.
 - ◆ After taking a picture, you can check the imprinted date/ time information in Photo View mode.

[Notes]

- ✦ Before setting the <Imprint> Option, set the current date and time (refer to page 42).
- ✦ Imprinting will print the date (and time) information directly onto the picture, and it will not be erased.
- ✦ When you print a Date / Time imprinted photos, date / time imprint part may be cropped out according to the printer used.

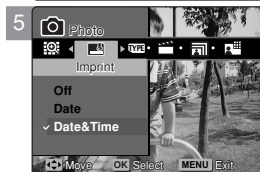
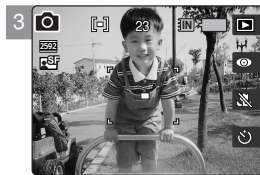

Photo Mode : Setting the Viewing Options

Using the Shortcut Buttons

Switching to Photo Capture Mode

1. Turn the Mode Dial to *Photo* mode.
2. Press the [POWER] button to turn on the Miniket Photo.
3. Press the [Shortcut 1] button in Photo Capture mode.
 - ◆ Switches to Photo view mode.
4. Press the [Shortcut 1] button again.
 - Moves to the Photo Capture mode.

Viewing a Slideshow



1. Turn the Mode Dial to *Photo* mode.
2. Press the [POWER] button to turn on the Miniket Photo.
3. Press the [Shortcut 1] button in Photo Capture mode.
 - ◆ Switches to Photo view mode.
4. Press the [Shortcut 2] button.
5. The Slideshow begins.
 - ◆ Refer to page 86 for further details on Slideshow.
6. Press the joystick (OK) to stop the Slideshow.



Photo Mode : Setting the Viewing Options

Using the Shortcut Buttons

Protecting Photo files

1. Turn the Mode Dial to *Photo* mode.
2. Press the [POWER] button to turn on the Miniket Photo.
3. Press the [Shortcut 1] button in Photo Capture mode.
 - ◆ Switches to Photo view mode.
4. Press the [Shortcut 3] button.
 - ◆ Each press of the [Shortcut 3] button will toggle between Locked () and Unlocked ().
5. Selected photo will be 'Protected'.



Deleting Photo files

1. Turn the Mode Dial to *Photo* mode.
2. Press the [POWER] button to turn on the Miniket Photo.
3. Press the [Shortcut 1] button in Photo Capture mode.
 - ◆ Switches to Photo view mode.
4. Press the [Shortcut 4] button.
5. Select an option by moving the joystick up / down and then press the joystick (OK).
 - ◆ <Delete>: Deletes the selected photo.
 - ◆ <Cancel>: Cancels delete.
 - ◆ Refer to page 82 for further details.



Photo Mode : Setting the Viewing Options

Using the Shortcut Buttons

Protecting Photo files in Multi-View

- Turn the Mode Dial to *Photo* mode.
- Press the [POWER] button to turn on the Miniket Photo.
- Press the [Shortcut 1] button.
 - Switches to Photo view mode.
- Move the zoom switch to W (WIDE).
 - The screen switches to multi-view.
 - The photo you were viewing in the single view is selected.
- Press the [Shortcut 3] button and then select an option by moving the joystick up / down and then press the joystick (OK).
 - <Select>: Selected photo files will be protected.
 - <All>: All photo files will be protected. A message "Protect All?" appears. Select an option by moving the joystick left / right.
 - <Cancel>: Cancels protection.
- If <Select> was selected, select photo files to protect by moving the joystick left / right / up / down and press the joystick (OK).
 - Multiple photo files can be selected using the joystick (OK).
<  > indicator appears on the protected photos.
- Press the [Shortcut 3] button again.
 - The message "Confirm?" appears. Select <Yes> or <No> by moving the joystick left / right and then press the joystick (OK) to confirm.
- The selected file is protected from erasure.

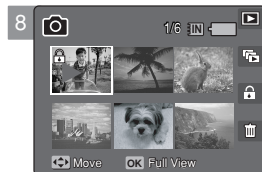
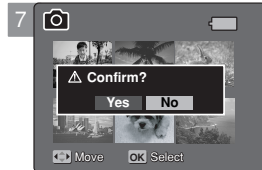
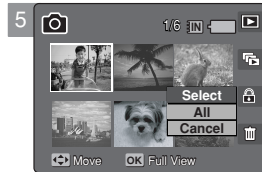
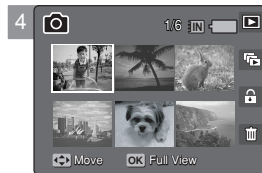

Photo Mode : Setting the Viewing Options

Using the Shortcut Buttons

Deleting Photo files in Multi-View

- Turn the Mode Dial to *Photo* mode.
- Press the [POWER] button to turn on the Miniket Photo.
- Press the [Shortcut 1] button.
 - Switches to Photo view mode.
- Move the [W/T] zoom switch to W (WIDE).
 - The screen switches to multi-view.
 - The photo you were viewing in the single view is selected.
- Press the [Shortcut 4] button and then select an option by moving the joystick up / down and then press the joystick (OK).
 - <Select>: Selected photo files will be deleted.
 - <All>: All photo files will be deleted. A message <Delete All?> appears. Select an option by moving the joystick left / right.
 - <Cancel>: Cancels deletion.
- If <Select> was selected, select photo files to delete by moving the joystick left / right / up / down and press the joystick (OK).
 - Multiple photo files can be selected using the joystick (OK). <☒ > icon appears on the selected files.
- Press the [Shortcut 4] button.
 - The message "Delete?" appears. Select <Yes> or <No> by moving the joystick left / right and then press the joystick (OK) to confirm.
- Selected photo file are deleted.
Refer to page 82 for further details.

[Note]

- ✦ Protected files will not be deleted.

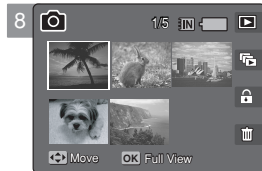
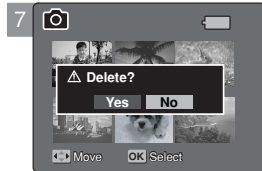
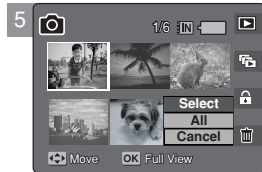
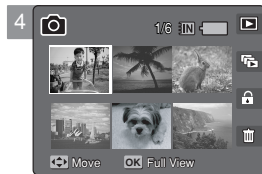



Photo Mode : Setting the Viewing Options

Deleting Photo Files

You can delete saved photo files.

1. Turn the Mode Dial to *Photo* mode.
2. Press the [POWER] button to turn on the Miniket Photo.
3. Press the [Shortcut 1] button to switch to Photo View mode.
4. Press the [MENU] button.
 - ◆ Menu screen appears.
5. Move the joystick left / right to select <Delete>.
6. Select an option by moving the joystick up / down and then press the joystick (OK).
 - ◆ <Select>: Multi-view screen appears and you can select photo files to delete.
 - ◆ <All>: All photo files will be deleted.
If <All> is selected, the message "Delete All?" appears. Select <Yes> or <No> by moving the joystick left / right and then press the joystick (OK) to confirm.
7. If <Select> is selected, Multi-view screen appears. Select photo files to delete by moving the joystick left / right / up / down and press the joystick (OK).
 - ◆ Multiple photo files can be selected using the joystick (OK). An icon () indicating the selected file to be deleted appears.
8. Press the [Shortcut 4] button.
 - ◆ The message "Delete?" appears. Select <Yes> or <No> by moving the joystick left / right and then press the joystick (OK) to confirm.
9. Press the [MENU] button to exit the menu.

[Notes]

- ✦ You can easily access this function by using the shortcut button (refer to page 79).
- ✦ Protected files will not be deleted.
- ✦ While the menu screen is displayed, pressing the [Record / Stop] button will exit the menu.

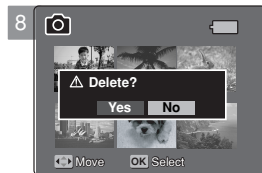
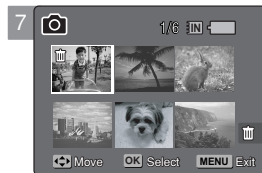
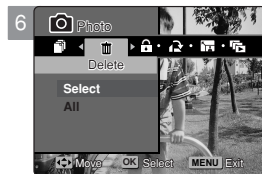



Photo Mode : Setting the Viewing Options

Protecting Photo Files

You can protect saved important photo files from accidental erasure. Protected files will not be deleted unless you release the protection or format the memory.

1. Turn the Mode Dial to *Photo* mode.
2. Press the [POWER] button to turn on the Miniket Photo.
3. Press the [Shortcut 1] button to switch to Photo View mode.
4. Press the [MENU] button.
 - ◆ Menu screen appears.
5. Move the joystick left / right to select <Protect>.
6. Select an option by moving the joystick up / down and then press the joystick (OK).
 - ◆ <Select>: Multi-view screen appears and you can select photo files to protect.
 - ◆ <All>: All photo files will be protected.
If <All> is selected, the message “Protect All?” appears. Select the desired option by moving the joystick left / right and then press the joystick (OK) to confirm.
7. If <Select> is selected, Multi-view screen appears. Select photo files to protect by moving the joystick left / right / up / down and press the joystick (OK).
 - ◆ Multiple photo files can be selected using the joystick (OK). An icon () indicating selected file is to be protected appears.
8. Press the [Shortcut 3] button.
 - ◆ The message “Confirm?” appears. Select <Yes> or <No> by moving the joystick left / right and then press the joystick (OK) to confirm.
9. Press the [MENU] button to exit the menu.
 - ◆ An icon () indicating selected file is protected appears.

[Notes]

- ✦ You can easily access this function by using the shortcut button (refer to page 79).
- ✦ While the menu screen is displayed, pressing the [Record / Stop] button will exit the menu.

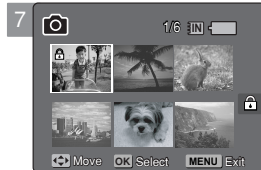

Photo Mode : Setting the Viewing Options

Rotating a Photo File

You can rotate a saved photo.

1. Turn the Mode Dial to *Photo* mode.
2. Press the [POWER] button to turn on the Miniket Photo.
3. Press the [Shortcut 1] button to switch to Photo View mode.
4. Move the joystick left / right to select a photo file to rotate.
5. Press the [MENU] button.
 - ◆ Menu screen appears.
6. Move the joystick left / right to select <Rotate>.
7. Select an option by moving the joystick up / down and then press the joystick (OK).
 - ◆ <Right(90°)>: Rotates the photo clockwise by 90°.
 - ◆ <Left(90°)>: Rotates the photo counterclockwise by 90°.
 - ◆ <Updown(180°)>: Flips the image up and down (Rotates 180°).
8. Press the [MENU] button to exit the menu.

[Notes]

- ✦ Rotated images having a portrait ratio will have black margins on both the left / right corners of the LCD when it is displayed.
- ✦ Rotating will not affect the image quality or resolution.
- ✦ Rotated images may not appear as rotated on a PC.
- ✦ You cannot crop a rotated image.
- ✦ While the menu screen is displayed, pressing the [Record / Stop] button will exit the menu.

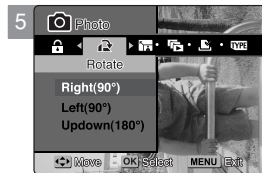

Photo Mode : Setting the Viewing Options

Resizing Photos

You can resize a saved photo to be smaller than original. Making a bigger image file is not supported.

1. Turn the Mode Dial to *Photo* mode.
2. Press the [POWER] button to turn on the Miniket Photo.
3. Press the [Shortcut 1] button to switch to Photo View mode.
4. Move the joystick left / right to select a photo file to resize.
5. Press the [MENU] button.
 - ◆ Menu screen appears.
6. Move the joystick left / right to select <Resize>.
7. Select an option by moving the joystick up / down and then press the joystick (OK).
 - ◆ <4M>/ <3M>/ <2M>/ <1M>/ VGA
 - ◆ You can only resize a saved photo to be smaller than the original.
8. Press the [MENU] button to exit the menu.

[Notes]

- ✦ Only JPEG files can be resized.
- ✦ Photos of VGA size cannot be resized.
- ✦ Resized photos are saved separately. The original photo will not be deleted.
- ✦ Rotated photos cannot be resized.
- ✦ If there is not enough space to save the resized photo, the message "Memory Full!" will appear and the resizing will be canceled.
- ✦ While the menu screen is displayed, pressing the [Record / Stop] button will exit the menu.

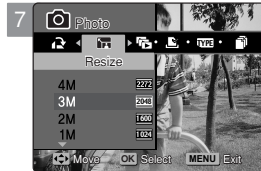
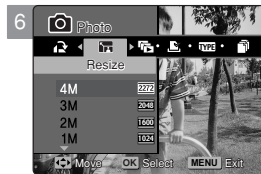

Photo Mode : Setting the Viewing Options

Setting the Slideshow

You can set a slideshow, and also set the interval and repetition options for the slideshow.

1. Turn the Mode Dial to *Photo* mode.
2. Press the [POWER] button to turn on the Miniket Photo.
3. Press the [Shortcut 1] button to switch to Photo View mode.
4. Press the [MENU] button.
 - ◆ Menu screen appears.
5. Move the joystick left / right to select <Slide>.
6. Select <Interval> by moving the joystick up / down and then press the joystick (OK) or move joystick right.
7. Set the interval by moving the joystick up / down and then press the joystick (OK).
 - ◆ Interval range: 1 ~ 10 seconds.
8. Select <Repeat> by moving the joystick up / down and then press the joystick (OK) or move joystick right.
9. Set the repeat option by moving the joystick up / down and then press the joystick (OK).
 - ◆ <Off>: Sets not to repeat the slideshow.
 - ◆ <On>: Sets to repeat the slideshow.
10. Select <Start> by moving the joystick up / down and then press the joystick (OK).
 - ◆ Slideshow starts. To stop the slideshow, press the joystick (OK).

[Notes]

- + You can easily access this function by using the shortcut button (refer to page 78).
- + The interval between photos may vary depending on the size of the photo.
- + Slideshow starts from the current photo displayed.
- + Slideshow cannot start from a damaged photo file. Slideshow will skip the damaged photo during the Slideshow.
- + While the menu screen is displayed, pressing the [Record / Stop] button will exit the menu.



Photo Mode : Setting the Viewing Options

Setting the DPOF (Digital Print Order Format) Function

You can automatically print a photo file recorded with a printer that supports DPOF. Setting the DPOF is only available mini SD card.

1. Turn the Mode Dial to *Photo* mode.
2. Press the [POWER] button to turn on the Miniket Photo.
3. Press the [Shortcut 1] button to switch to Photo View mode.
4. Press the [MENU] button.
 - ◆ Menu screen appears.
5. Move the joystick left / right to select <DPOF>.
6. Select an option by moving the joystick up / down and then press the joystick (OK).
 - ◆ <Select>: Multi-view screen appears and you can select photo files to set DPOF printing.
 - ◆ <All>: All photo files will be marked with DPOF printing.
If <All> is selected, the message "DPOF All?" appears. Select the desired option by moving the joystick left / right and then press the joystick (OK) to confirm.
7. If <Select> is selected, Multi-view screen appears. Select the photo files to set by moving the joystick left / right / up / down.
8. Set the number of prints by using the [Shortcut 3] and [Shortcut 4] buttons.
 - ◆ Move to another photo by moving the joystick left / right and repeat the steps to set DPOF.
9. The message "Confirm?" appears when you press the joystick (OK).
 - ◆ Select <Yes> or <No> by moving the joystick left / right and then press the joystick (OK) to confirm.
10. Press the [MENU] button to exit the menu.
 - ◆ <Print> icon is displayed on the photos with DPOF setup.

[Notes]

- ✦ Please refer to the product instructions for further details on DPOF printer use.
- ✦ Using a printer that supports DPOF allows users to directly print photos stored in a mini SD card without a PC.
- ✦ While the menu screen is displayed, pressing the [Record / Stop] button will exit the menu.

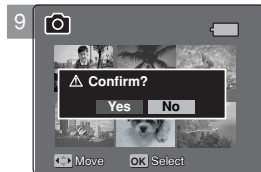
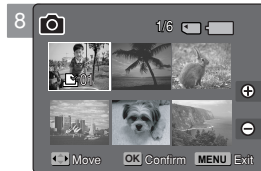
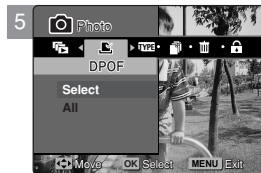

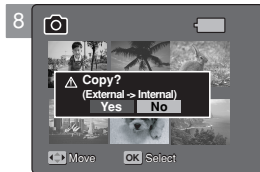
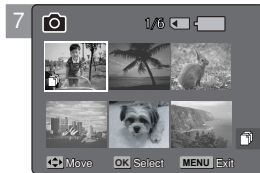

Photo Mode : Setting the Viewing Options

Copying Photo Files

You can copy saved photo files from the internal memory on to a mini SD card and vice-versa.

1. Turn the Mode Dial to *Photo* mode.
2. Press the [POWER] button to turn on the Miniket Photo.
3. Press the [Shortcut 1] button to switch to Photo View mode.
4. Press the [MENU] button.
 - ◆ Menu screen appears.
5. Move the joystick left / right to select <Copy (to)>.
6. Select an option by moving the joystick up / down and then press the joystick (OK).
 - ◆ <Select>: Multi-view screen appears and you can select photo files to copy.
 - ◆ <All>: All photo files will be copied.
If <All> is selected, the message “Copy All?” appears. Select <Yes> or <No> by moving the joystick left / right and then press the joystick (OK) to confirm.
7. If <Select> is selected, Multi-view screen appears. Select photo files to copy by moving the joystick left / right / up / down and press the joystick (OK).
 - ◆ Multiple photo files can be selected using the joystick (OK). An icon () indicating the selected file to be copied appears.
8. Press the [Shortcut 4] button.
 - ◆ The message “Copy?” appears. Select <Yes> or <No> by moving the joystick left / right and then press the joystick (OK) to confirm.
9. Press the [MENU] button to exit the menu.



[Notes]

- ✦ It copies from the currently-used memory to another. If the internal memory was used, it copies to a mini SD card.
- ✦ When <File No.> is set, file numbering will start from the next to the last file.
- ✦ While the menu screen is displayed, pressing the [Record / Stop] button will exit the menu.

How to set to Movie mode

1. Turn the Mode Dial to *Movie* mode.



2. Press the [POWER] button to turn on the Miniket Photo.

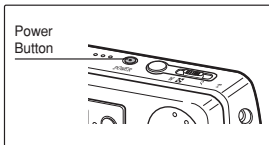

3 Movie Mode

Recording a Movie	90
Recording a Movie	90
Zooming In and Out	91
Playing a Movie	92
Playing a Movie on the LCD Monitor	92
Setting the Recording Options	93
Using the Shortcut Buttons	93
Setting the Program AE	95
Setting the White Balance	96
Setting the Digital Effects	97
Setting the Macro Mode	98
Setting the Movie Quality	99
Setting the Movie Size	100
Setting the Self Timer	101
Setting the Wind Cut	102
Setting the Viewing Options	103
Using the Shortcut Buttons	103
Deleting Movie Files	107
Protecting Movie Files	108
Setting the All Play	109
Copying Movie Files	110

- ◆ Save important data / recordings separately on other media, to avoid accidental loss due to a system failure or other reasons.

Movie Mode : Recording a Movie

Recording a Movie

You can record video and store it in memory.

1. Turn the Mode Dial to *Movie* mode.
2. Press the [POWER] button to turn on the Miniket Photo.
 - ◆ The Movie Record screen appears.
3. Press the [Record / Stop] button.
 - ◆ It starts to record.
4. To stop recording, press the [Record / Stop] button again.
 - ◆ It stops recording, and stands by.
5. After recording, press the [POWER] button to turn off the Miniket Photo to prevent battery power consumption.



Reading the Counter

- ◆ The timestamp will be recorded along with the movie to support users with a faster search.
- ◆ 00:00:16: Elapsed Recording Time
REM 4 Min: Remaining Recording Time

[Notes]

- ✦ To adjust the brightness of LCD screen, set the <LCD Brightness> in Settings mode (refer to page 41).
- ✦ After recording, turn off the Miniket Photo to conserve battery power.
- ✦ The brightness of the LCD monitor will not affect the brightness of the recordings.

Movie Mode : Recording a Movie

Zooming In and Out

Zooming allows you to change the size of the subject captured in a scene. You can take advantage of the 3x optical electro motion zoom lens.

Before You Start

1. Turn the Mode Dial to *Movie* mode.
2. Press the [POWER] button to turn on the Miniket Photo.
The Movie Record screen appears.

Zoom Out

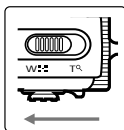

Move the [W/T] zoom switch to W (WIDE).

- The shot subject's size is reduced, and you can record movies as if you were far away from the subject.
- On the zoom indicator in the LCD screen, the arrow moves to W.
- The smallest rate of zoom out is the default rate (original resolution of the subject).

Zoom In

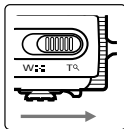

Move the [W/T] zoom switch to T (TELE).

- The subject is larger, and you can record movies as if you were close to the subject.
- On the zoom indicator the arrow moves to T.
- The largest optical zoom is 3x, which is the biggest among the basic zoom.

[Notes]

- ✦ 3x electro-optical zoom is equipped and the focus remains at the point fixed initially when starting the recording.
- ✦ Optical zoom preserves image quality.
- ✦ Movie recording with zoom use may record zooming noise.

Zoom Out



Zoom In

Movie Mode : Playing a Movie

Playing a Movie on the LCD Monitor

It is handy and practical to view movie files using the LCD monitor almost anywhere such as in a car, indoors, or outdoors.

1. Turn the Mode Dial to *Movie* mode.
2. Press the [POWER] button to turn on the Miniket Photo.
 - ◆ The Movie Record screen appears.
3. Press the [Shortcut 1] button.
 - ◆ Switches to Movie play mode.
4. Move the joystick left / right to select a movie file and then press the joystick (OK).
 - ◆ Selected movie file plays on the LCD monitor.
 - ◆ To pause playback, press the joystick (OK).
 - ◆ To stop playback, press and hold the joystick (OK) for a while.
5. To adjust volume, move the joystick up / down.
 - ◆ The volume indicator appears and disappears after a few seconds.

[Notes]

- ✦ If there is no file stored to view, the message <No stored Movie!> appears.
- ✦ When the earphones or Audio / Video cable is connected to the Miniket Photo, the built-in speaker will automatically turn off.
- ✦ As for photo viewing, you can also select and play the movie file in a multi-view display.



Movie Mode : Setting the Recording Options

Using the Shortcut Buttons

Shortcut buttons are provided to allow users easy access to frequently-used functions.

Switching to Movie Play Mode

1. Turn the Mode Dial to *Movie* mode.
2. Press the [POWER] button to turn on the Miniket Photo.
3. Press the [Shortcut 1] button.
 - ◆ Each press of the [Shortcut 1] button toggles between the Movie Record / Play modes.



Setting the Program AE

1. Turn the Mode Dial to *Movie* mode.
2. Press the [POWER] button to turn on the Miniket Photo.
3. Press the [Shortcut 2] button.
 - ◆ Each press of the [Shortcut 2] button cycles through Program AE modes.



Movie Mode : Setting the Recording Options

Using the Shortcut Buttons

Shortcut buttons are provided to allow users easy access to frequently used functions.

Setting the White Balance

1. Turn the Mode Dial to *Movie* mode.
2. Press the [POWER] button to turn on the Miniket Photo.
3. Press the [Shortcut 3] button.
 - ◆ Each press of the [Shortcut 3] button cycles through the > > > > > > > > flash modes

Setting the Digital Effect

1. Turn the Mode Dial to *Movie* mode.
2. Press the [POWER] button to turn on the Miniket Photo.
3. Press the [Shortcut 4] button.
 - ◆ Each press of the [Shortcut 4] button cycles through the > > > > > Digital Effects.



Movie Mode : Setting the Recording Options

Setting the Program AE

Program AE modes are preset automatic exposure modes based upon an internal computer programme. It allows you to adjust the aperture setting to suit different conditions.

1. Turn the Mode Dial to *Movie* mode.
2. Press the [POWER] button to turn on the Miniket Photo.
 - ◆ The Movie Record screen appears.
3. Press the [MENU] button.
4. Move the joystick left / right to select <Program AE>.
5. Select an option by moving the joystick up / down and then press the joystick (OK).

Auto	Balances exposure and shutter speed to get the best results automatically.
Sports	For recording fast-moving objects. It is suitable for sporting events and recording the outside from inside of a vehicle.
Spotlight	Compensates for a subject that appears too bright under strong direct light such as a spotlight. It is suitable for recording conditions such as concerts and school performances.
Beach/Snow	When the light is very strong, such as on a beach or in the snow.

6. Press the [MENU] button to exit the menu.

[Notes]

- ✦ You can easily access this function by using the shortcut button (refer to page 93).
- ✦ <Macro> setting is limited when you are using Program AE (refer to page 102).
- ✦ Regarding <White Balance>, <Macro>, <Focus> and <Wind Cut> use with <Program AE>, refer to page 102.
- ✦ While the menu screen is displayed, pressing the [Record / Stop] button will exit the menu.



Movie Mode : Setting the Recording Options

Setting the White Balance

The White Balance is used to preserve natural colours under different lighting conditions. It is recommended to set the white balance prior to any recording.

1. Turn the Mode Dial to *Movie* mode.
2. Press the [POWER] button to turn on the Miniket Photo.
 - ◆ The Movie Record screen appears.
3. Press the [MENU] button.
 - ◆ Menu screen appears.
4. Move the joystick left / right to select <White Balance>.
5. Move the joystick up / down to select an option, and then press the joystick (OK).

Auto	Automatically sets according to the shooting environment.
Daylight	Adjusts the colour according to daylight/indoor, outdoor light
Cloudy	You can select this when you cannot have daylight as a direct light, such as when it is partly-cloudy or cloudy.
Fluorescent H	Suitable in a halogen or 3-wavelength light environment.
Fluorescent L	Suitable for a fluorescent light environment.
Tungsten	Suitable for an incandescent light environment.

6. Press the [MENU] button to exit the menu.

[Notes]

- ✦ You can easily access this function by using the shortcut button (refer to page 94).
- ✦ In general outdoors recording, <Auto> setting will allow users to achieve the best results.
- ✦ As the lighting conditions change, set the appropriate white balance before recording.
- ✦ Regarding <White Balance> use with <Program AE>, refer to page 102.
- ✦ While the menu screen is displayed, pressing the [Record / Stop] button will exit the menu.



Movie Mode : Setting the Recording Options

Setting the Digital Effects

It supports various digital effects you can apply to your movie. Create a professional-looking movie with digital effects.

1. Turn the Mode Dial to *Movie* mode.
2. Press the [POWER] button to turn on the Miniket Photo.
 - ◆ The Movie Record screen appears.
3. Press the [MENU] button.
4. Move the joystick left / right to select <Digital Effect>.
5. Select an option by moving the joystick up / down, and then press the joystick (OK).

Off	Cancel the <Digital Effect>. Takes movie in normal mode.
Sepia	The picture is displayed in sepia colour--similar to that of an old photograph.
Nega	Reverses the colours, creating the look of a negative.
BLK&WHT	Changes the images into black and white.

6. Press the [MENU] button to exit the menu.

[Notes]

- + You can easily access this function by using the shortcut button (refer to page 94).
- + While the menu screen is displayed, pressing the [Record / Stop] button will exit the menu.



Movie Mode : Setting the Recording Options

Setting the Macro Mode

Macro mode allows users to have fine focused image of a close-up subject within 50 cm. <Macro> setting is available only when you set <Program AE> to <Auto>.

1. Turn the Mode Dial to *Movie* mode.
2. Press the [POWER] button to turn on the Miniket Photo.
 - ◆ The Movie Record screen appears.
3. Press the [MENU] button.
4. Move the joystick left / right to select <Macro>.
- 5 Select an option by moving the joystick up / down and then press the joystick (OK).

Macro Setting	Focus Range
<Off>	50 cm ~ ∞
<Macro>	W: 10 cm ~ ∞ T: 30 cm ~ ∞

6. Press the [MENU] button to exit the menu.

[Notes]

- ◆ When you use Macro mode and record a close-up subject, be careful not to shade your subject.
- ◆ As the distance gets closer, the focused area gets narrower.
- ◆ If the focus will not set, try to put more distance between you and the subject.
- ◆ It is recommended to use a tripod to avoid unstable movie recording and have best results.
- ◆ Regarding <Macro> use with <Program AE>, refer to page 102.
- ◆ While the menu screen is displayed, pressing the [Record / Stop] button will exit the menu.



Movie Mode : Setting the Recording Options

Setting the Movie Quality

You can set the quality for movie files.

1. Turn the Mode Dial to *Movie* mode.
2. Press the [POWER] button to turn on the Miniket Photo.
 - ◆ The Movie Record screen appears.
3. Press the [MENU] button.
4. Move the joystick left / right to select <Movie Quality>.
5. Select an option by moving the joystick up / down and then press the joystick (OK).
 - ◆ Available options are: <Super Fine> / <Fine> / <Normal>
6. Press the [MENU] button to exit the menu.
 - ◆ An icon indicating the selected Movie Quality appears on the screen.

[Notes]

- ✦ Regarding detailed image capacity, refer to page 31.
- ✦ While the menu screen is displayed, pressing the [Record / Stop] button will exit the menu.
- ✦ In NTSC setting, Super Fine and Fine quality will record at 30fps while Normal at 15fps. In PAL setting, Super Fine and Fine will record at 25fps while Normal at 12.5fps.

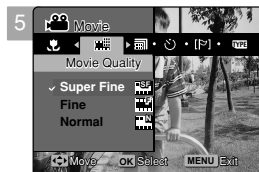
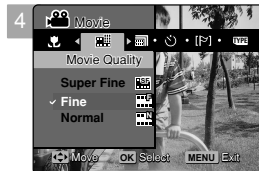

Movie Mode : Setting the Recording Options

Setting the Movie Size

1. Turn the Mode Dial to *Movie* mode.
2. Press the [POWER] button to turn on the Miniket Photo.
 - ◆ The Movie Record screen appears.
3. Press the [MENU] button.
4. Move the joystick left / right to select <Movie Size>.
5. Select an option by moving the joystick up / down and then press the joystick (OK).
 - ◆ Available options are: <640x480> / <320x240>
6. Press the [MENU] button to exit the menu.
 - ◆ An icon indicating the selected Movie Size appears on the screen.

[Notes]

- ✦ Regarding detailed image capacity, refer to page 31.
- ✦ Higher resolution requires more memory space, which results in shorter maximum recording time.
- ✦ While the menu screen is displayed, pressing the [Record / Stop] button will exit the menu.



Movie Mode : Setting the Recording Options

Setting the Self Timer

Using this option, you can record movies of yourself with delayed shooting.

1. Turn the Mode Dial to *Movie* mode.
2. Press the [POWER] button to turn on the Miniket Photo.
 - ◆ The Movie Record screen appears.
3. Press the [MENU] button.
4. Move the joystick left / right to select <Self Timer>.
5. Select an option by moving the joystick up / down, and then press the joystick (OK).

Off	Cancels the Self Timer.
2 sec	Sets the delay interval to 2 seconds. Records a movie 2 seconds after pressing the [Record/Stop]
10 sec	Sets the delay interval to 10 seconds. Records a movie 10 seconds after pressing the [Record/Stop]

6. Press the [MENU] button to exit the menu.
 - ◆ An icon indicating the selected Self Timer mode appears on the screen.
 - ◆ If <Off> is selected, no icon will be displayed.

[Notes]

- ✦ It is recommended to use a tripod for the best results for Self Timer recordings.
- ✦ While the menu screen is displayed, pressing the [Record / Stop] button will exit the menu.
- ✦ Restarting the Miniket Photo will cancel the Self Timer setting.

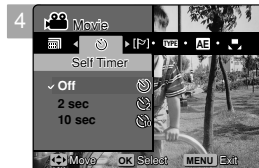

Movie Mode : Setting the Recording Options

Setting the Wind Cut

Use the Wind Cut function when recording in windy places such as the beach or near buildings. The Wind Cut function minimizes wind noise or other noise while recording.

1. Turn the Mode Dial to *Movie* mode.
2. Press the [POWER] button to turn on the Miniket Photo.
3. Press the [MENU] button.
4. Move the joystick left / right to select <Wind Cut>.
5. Select an option by moving the joystick up / down, and then press the joystick (OK).
 - ◆ <Off>: Sets off Wind Cut and no icon appears.
 - ◆ <On>: Sets on Wind Cut to reduce wind noise for sound recording.
6. Press the [MENU] button to exit the menu.
 - ◆ If <On> is selected, < [F] > icon appears on the screen.
 - ◆ If <Off> is selected, no icon will be displayed.

Functions Availability

Functions are supported according to Program AE modes to help users to have best results.

Program AE	[AF]	[B]	[S]	[SN]	
White Balance	[WB]	○	○	○	○
	[WB]	○	○	○	○
	[WB]	○	○	○	○
	[WB]	○	○	○	○
	[WB]	○	○	○	○
Macro	[WB]	○	○	○	○
	[WB]	○	X	X	X
Focus	Multi	○	Pan	○	Pan
Wind Cut	Off	○	○	○	○
	[F]	○	○	○	○

- ◆ <Focus> does not appear in the menu; it is set to <Multi AF> by default. In <Sports> and <Beach / Snow>, it is set to <Pan Focus>.
- ◆ Pan: Pan Focus that adjusts the focus to entire screen has focused. Focuses on the deepest DOF (Depth of Field) position which makes the both near and distant view are in focus.

[Notes]

- + When Wind Cut is enabled, a bit of low-frequency band (bass) sound will be reduced along with the wind noise. It is a normal result, not a malfunction.
- + Regarding <Wind Cut> use with <Program AE>, refer to the availability table.
- + While the menu screen is displayed, pressing the [Record / Stop] button will exit the menu.



Movie Mode : Setting the Viewing Options

Using the Shortcut Buttons

Shortcut buttons are provided to allow users easy access to frequently-used functions.

Switching to Movie Record Mode

1. Turn the Mode Dial to *Movie* mode.
2. Press the [POWER] button to turn on the Miniket Photo.
3. Press the [Shortcut 1] button.
 - ◆ It switches to Movie play mode.
4. Press the [Shortcut 1] button again.
 - ◆ Each press of the [Shortcut 1] button toggles between the Movie record / play modes.

Viewing the All Play

1. Turn the Mode Dial to *Movie* mode.
2. Press the [POWER] button to turn on the Miniket Photo.
3. Press the [Shortcut 1] button.
 - ◆ It switches to Movie play mode.
4. Press the [Shortcut 2] button.
5. **The All Play begins.** (Refer to page 109)
 - ◆ To stop playback, press the joystick (OK).





Movie Mode : Setting the Viewing Options

Using the Shortcut Buttons

Shortcut buttons are provided to allow users easy access to frequently-used functions.

Protecting a Movie File

1. Turn the Mode Dial to *Movie* mode.
2. Press the [POWER] button to turn on the Miniket Photo.
3. Press the [Shortcut 1] button.
 - ◆ It switches to Movie play mode.
4. Press the [Shortcut 3] button.
 - ◆ Each press of the [Shortcut 3] button toggles between Unlocked () and Locked ().
5. The selected movie file is protected from an accidental erasure.
(Refer to page 108)

Deleting a Movie File

1. Turn the Mode Dial to *Movie* mode.
2. Press the [POWER] button to turn on the Miniket Photo.
3. Press the [Shortcut 1] button.
 - ◆ It switches to Movie play mode.
4. Press the [Shortcut 4] button.
5. Select an option by moving the joystick up / down button, and then press the joystick (OK).
 - ◆ <Delete>: Deletes the selected movie file.
 - ◆ <Cancel>: Cancels the deletion.
6. Deletes the selected movie file. (Refer to page 107)



Movie Mode : Setting the Viewing Options

Using the Shortcut Buttons

Protecting Movie files in Multi-View

- Turn the Mode Dial to *Movie* mode.
- Press the [POWER] button to turn on the Miniket Photo.
- Press the [Shortcut 1] button.
 - It switches to the Movie play mode.
- Move the [W/T] zoom switch to W (WIDE).
 - The screen switches to multi-view.
 - The movie you were viewing in the single view is selected.
- Press the [Shortcut 3] button and then select an option by moving the joystick up / down and then press the joystick (OK).
 - <Select>: Selected files will be protected.
 - <All>: The message <Protect All?> appears. Select the desired option by moving the joystick left / right and then press the joystick [OK] to confirm.
 - <Cancel>: Cancels protection.
- If <Select> was selected, select movie files to protect by moving the joystick left / right / up / down and press the joystick (OK).
 - Multiple movie files can be be selected using the joystick (OK). <🔒> indicator appears on the protected files. Pressing the joystick (OK) again will make the Lock <🔒> indicator disappear.
- Press the [Shortcut 3] button.
 - The message "Confirm?" appears. Select the desired item by moving the joystick left / right and then press the joystick (OK) to confirm.
- Selected movies are protected from an accidental erasure.

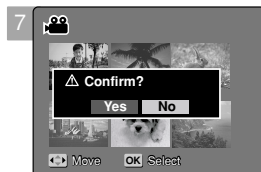
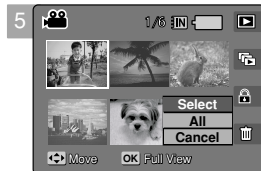
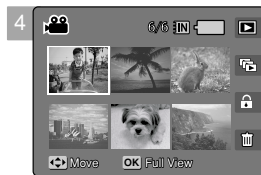

Movie Mode : Setting the Viewing Options

Using the Shortcut Buttons

Deleting Movie files in Multi-View

1. Turn the Mode Dial to *Movie* mode.
2. Press the [POWER] button to turn on the Miniket Photo.
 - ◆ The Movie Record screen appears.
3. Press the [Shortcut 1] button.
 - ◆ Switches to Movie play mode.
4. Move the [W/T] zoom switch to W (WIDE).
 - ◆ The screen switches to multi-view.
 - ◆ The movie you were viewing in the single view is selected.
5. Press the [Shortcut 4] button and then select an option by moving the joystick up / down and then press the joystick (OK).
 - ◆ <Select>: Selected movie files will be deleted.
 - ◆ <All>: The message <Delete All?> appears. Select <Yes> or <No> by moving the joystick left / right and then press the joystick (OK) to confirm.
 - ◆ <Cancel>: Cancels deletion.
6. If <Select> was selected, select movie files to delete by moving the joystick left / right / up / down and press the joystick (OK).
 - ◆ Multiple movie files can be selected using the joystick (OK). < 1/6 > indicator appears on the selected files.
7. Press the [Shortcut 4] button.
 - ◆ The message <Delete?> appears. Select the desired option by moving the joystick left / right and then press the joystick (OK) to confirm.
8. Selected movies are deleted.

[Note]

- ◆ Protected files will not be deleted.

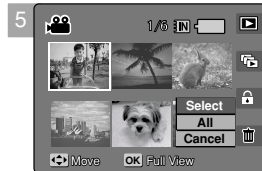
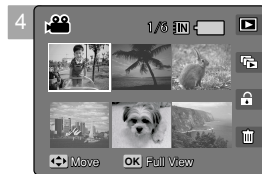

Movie Mode : Setting the Viewing Options

Deleting Movie Files

You can delete saved movie files.

1. Turn the Mode Dial to *Movie* mode.
2. Press the [POWER] button to turn on the Miniket Photo.
3. Press the [Shortcut 1] button.
 - ◆ Switches to Movie play mode.
4. Press the [MENU] button.
 - ◆ Menu screen appears.
5. Move the joystick left / right to select <Delete>.
6. Select an option by moving the joystick up / down and then press the joystick (OK).
 - ◆ <Select>: Multi-view screen appears and you can select movie files to delete.
 - ◆ <All>: All files will be deleted.
If <All> is selected, the message "Delete All?" appears. Select <Yes> or <No> by moving the joystick left / right and then press the joystick (OK) to confirm.
7. If <Select> is selected, Multi-view screen appears. Select files to delete by moving the joystick left / right / up / down and press the joystick (OK).
 - ◆ Multiple movie files can be selected using the joystick (OK). <🗑> indicator appears on the selected files.
8. Press the [Shortcut 4] button.
 - ◆ The message "Delete?" appears. Select the desired item by moving the joystick left / right and then press the joystick (OK) to confirm.
9. Press the [MENU] button to exit the menu.

[Notes]

- ✦ You can easily access this function by using the shortcut button (refer to page 104).
- ✦ Protected files will not be deleted.
- ✦ While the menu screen is displayed, pressing the [Record / Stop] button will exit the menu.

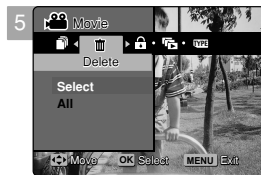

Movie Mode : Setting the Viewing Options

Protecting Movie Files

You can protect saved important movie files from accidental deletion. Protected files will not be deleted unless you release the protection or format the memory.

1. Turn the Mode Dial to *Movie* mode.
2. Press the [POWER] button to turn on the Miniket Photo.
3. Press the [Shortcut 1] button.
 - ◆ Switches to Movie play mode.
4. Press the [MENU] button.
5. Move the joystick left / right to select <Protect>.
6. Select an option by by moving the joystick up / down and then press the joystick (OK).
 - ◆ <Select>: Multi-view screen appears and you can select movie files to protect.
 - ◆ <All>: All files will be protected.
If <All> is selected, the message "Protect All?" appears. Select the desired item by moving the joystick left / right and then press the joystick (OK) to confirm.
7. If <Select> is selected, Multi-view screen appears. Select files to protect by moving the joystick left / right / up / down and press the joystick (OK).
 - ◆ Multiple movie files can be selected using the joystick (OK). <  > indicator appears on the selected files.
8. Press the [Shortcut 3] button.
 - ◆ The message "Confirm?" appears. Select the desired item by moving the joystick left / right and then press the joystick (OK) to confirm.
9. Press the [MENU] button to exit the menu.

[Notes]

- + You can easily access this function by using the shortcut button (refer to page 104).
- + While the menu screen is displayed, pressing the [Record / Stop] button will exit the menu.

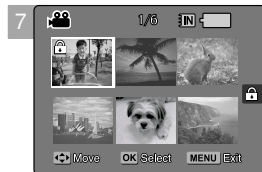

Movie Mode : Setting the Viewing Options

Setting the All Play

You can set All Play and also set the repeat option for All Play.

1. Turn the Mode Dial to *Movie* mode.
2. Press the [POWER] button to turn on the Miniket Photo.
3. Press the [Shortcut 1] button.
 - ◆ Switches to Movie play mode.
4. Press the [MENU] button.
 - ◆ Menu screen appears.
5. Move the joystick left / right to select <All Play>.
6. Select <Repeat> by moving the joystick up / down and then press the joystick (OK) or move joystick right.
 - ◆ Set the repeat option by moving the joystick up / down and then press the joystick (OK).
 - ◆ <Off>: Sets not to repeat the All Play.
 - ◆ <On>: Sets to repeat the All Play.
7. Select <Start> by moving the joystick up / down and then press the joystick (OK).
 - ◆ All Play starts.
 - ◆ To stop the All Play, press the joystick (OK).

[Notes]

- ✦ You can easily access this function by using the shortcut button (refer to page 103).
- ✦ All Play starts from the current movie selected.
- ✦ All play cannot start from a damaged file. All Play will skip the damaged file during the All Play.
- ✦ While the menu screen is displayed, pressing the [Record / Stop] button will exit the menu.

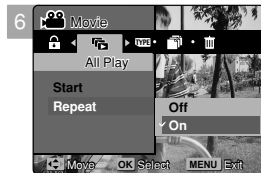

Movie Mode : Setting the Viewing Options

Copying Movie Files

You can copy saved files from the internal memory to the mini SD card and vice versa.

1. Turn the Mode Dial to *Movie* mode.
2. Press the [POWER] button to turn on the Miniket Photo.
3. Press the [Shortcut 1] button.
 - ◆ Switches to Movie play mode.
4. Press the [MENU] button.
5. Move the joystick left / right to select <Copy (to)>.
6. Select an option by moving the joystick up / down and then press the joystick (OK).
 - ◆ <Select>: Multi-view screen appears and you can select files to copy.
 - ◆ <All>: All files will be copied.
If <All> is selected, the message "Copy All?" appears. Select <Yes> or <No> by moving the joystick left / right and then press the joystick (OK) to confirm.
7. If <Select> is selected, Multi-view screen appears. Select files to copy by moving the joystick left / right / up / down and press the joystick (OK).
 - ◆ Multiple movie files can be selected using the joystick (OK). < 1/6 > indicator appears on the selected files.
8. Press the [Shortcut 4] button.
 - ◆ The message "Copy?" appears. Select the desired item by moving the joystick left / right and then press the joystick (OK) to confirm.
9. Press the [MENU] button to exit the menu.

[Notes]

- ✦ It copies from the currently-used memory to another.
- ✦ When <File No.> is set, file numbering will start from the next to the last file.
- ✦ While the menu screen is displayed, pressing the [Record / Stop] button will exit the menu.

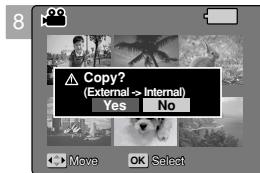

4 Music Mode

How to set to Music mode

1. Turn the Mode Dial to *Music* mode.

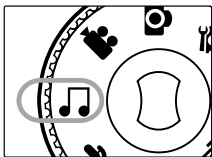

2. Press the [POWER] button to turn on the Miniket Photo.

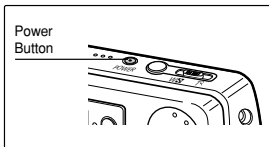

Playing Music Files	112
Copying Music Files from a PC	112
Playing Music Files	113
Setting the Music Play Options	114
Using the Shortcut Buttons	114
Setting the Repeated Play	116
Setting the Equaliser	117
Deleting Music Files	118
Protecting Music Files	119

- ◆ Save important data / recordings separately on other media, to avoid accidental loss due to a system failure or other reasons.

Music Mode : Playing Music Files

Copying Music Files from a PC

You can copy music files from a PC while connected to the PC with a USB cable.

1. Turn the Mode Dial to **Music mode**.
2. Press the [POWER] button to turn on the Miniket photo.
3. Connect the Miniket Photo to the PC using the USB cable provided.
 - ◆ A - Connect the USB cable to the Miniket photo.
 - ◆ B - Connect the other end of the USB cable to the PC.
4. Set the desired memory type on the PC.
 - ◆ Windows XP: Dialog windows may pop up overlapped. You can select desired memory type. Internal memory is displayed <Miniket> and mini SD card is displayed <Removable Disk>.
 - ◆ Other than Windows XP: It appears to have two instances of "Removable Disk". If it displays D and E drives as removable disks, D is the mini SD Card and E is the internal memory.
5. **'Paste' copied music files into the desired folder among <MUSIC1>, <MUSIC2>, <MUSIC3>, and <MUSIC4> under the <MP3>.**
 - ◆ Up to 500 files can be stored in each folder.

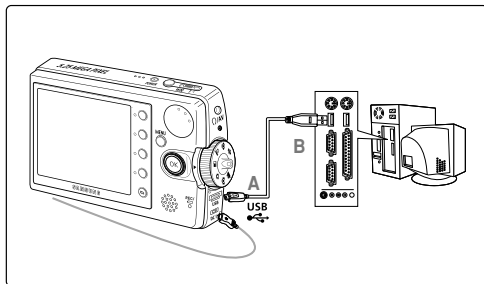

[Warning]

- ✦ Copying and redistributing of MP3 files may violate the copyright law.
- ✦ You cannot create a new folder on your Miniket Photo set.
- ✦ <MUSIC1> ~ <MUSIC4> are system folders. When the folders are renamed, it may not be recognised by the system and will not play back music files under renamed folders.
- ✦ Folders created on a PC will not appear on the set.

[Notes]

- ✦ Regarding Music file capacity according to memory capacity, refer to page 31.
- ✦ The music played back will begin with the first music file that is stored in the top folder (MUSIC1).
- ✦ It is recommended to use an AC Power Adapter during the file transfer to avoid unintended power outage.
- ✦ Pop up dialogs will appear differently whether the memory has files or not.

Music Mode : Playing Music Files

Playing Music Files

You can play back stored music files.

1. Turn the Mode Dial to **Music** mode.
2. Press the [POWER] button to turn on the Miniket Photo.
3. The last file played back is displayed.
 - ◆ If there is no music file stored, the message "No stored Music!" appears.
4. Select a music file to play by moving the joystick left / right, and then press the joystick (OK).
5. The selected music file is played back.
 - ◆ To pause playback, press the joystick (OK).
 - ◆ To stop playback, press and hold the joystick (OK).
 - ◆ To search backward / forward during playback, hold down the joystick left or right for a while.
 - ◆ Holding the joystick left / right for more than 1 second while stopped will skip to the previous / next file rapidly.
 - ◆ To adjust volume, move joystick up / down.
Volume indicator appears and disappears after few seconds.



[Notes]

- ✦ If a broken file name is displayed, try renaming it on a PC.
- ✦ When the earphones or Audio/Video cable is connected to the Miniket Photo, the built-in speaker will turn off automatically.
- ✦ Miniket Photo only supports MP3 file format.
- ✦ Damaged or non-standard MP3 files may not be displayed properly or failed to play back.
- ✦ Playback will fail to start if the first file is damaged.
- ✦ The title may not be displayed if the language is not supported or in Chinese.
- ✦ MP3 files with VBR setting will appear as VBR on the LCD monitor and its play time and recording time may differ from the displayed diagram.
- ✦ Miniket Photo does not support copy function in Music mode.
- ✦ If a title of a track is too long, it may appear cropped on the LCD screen.
- ✦ Supported bitrates for a music file is 8Kbps ~ 320Kbps and VBR.

How to Connect Earphones

Connect your earphones as shown in the diagram.



Music Mode : Setting the Music Play Options

Using the Shortcut Buttons

Shortcut buttons are provided to allow users easy access to frequently-used functions.

Viewing the Playlist

1. Turn the Mode Dial to *Music* mode.
2. Press the [POWER] button to turn on the Miniket Photo.
3. Press the [Shortcut 1] button.
 - ◆ It moves to the playlist view.
4. Select a music file by moving the joystick up / down, and then press the joystick (OK) or move the joystick right.
 - ◆ The selected music file is played back.
 - ◆ On the playlist screen, move the joystick left to select folders (MUSIC1 / MUSIC2 / MUSIC3 / MUSIC4).

Setting the Repeat Option

1. Turn the Mode Dial to *Music* mode.
2. Press the [POWER] button to turn on the Miniket Photo.
3. Press the [Shortcut 2] button.
 - ◆ Each press of the [Shortcut 2] button cycles through repeat modes.



Music Mode : Setting the Music Play Options

Using the Shortcut Buttons

Shortcut buttons are provided to allow users easy access to frequently used functions.

Setting to Hold

1. Turn the Mode Dial to *Music* mode.
2. Press the [POWER] button to turn on the Miniket Photo.
3. Press and hold the [Shortcut 3] button.
 - ◆ Each press of the [Shortcut 3] button toggles between (⊖) and (⊕).
4. When it is set to hold (⊕), button functions are locked except Mode Dial.
 - ◆ It helps so as not to disturb listening.

Setting the Equaliser

1. Turn the Mode Dial to *Music* mode.
2. Press the [POWER] button to turn on the Miniket Photo.
3. Press the [Shortcut 4] button.
 - ◆ Each press of the [Shortcut 4] button cycles through Equaliser modes.



Music Mode : Setting the Music Play Options

Setting the Repeated Play

You can repeat a selected music file or group of music files.

1. Turn the Mode Dial to *Music* mode.
2. Press the [POWER] button to turn on the Miniket Photo.
3. Press the [MENU] button on the stop mode.
4. Move the joystick left / right to select <Repeat>.
5. Select an option by moving the joystick up / down and then press the joystick (OK).
 - ◆ <Off>: No repeat, plays each title once in the order from the selected music.
 - ◆ <One>: One selected music file will play repeatedly.
 - ◆ <Group>: The selected group of music files will play repeatedly.
 - ◆ <All>: All music files will play through in order and start again from the beginning.
 - ◆ <Shuffle>: All music files will play in random order once.
6. Press the [MENU] button to exit the menu.

[Notes]

- ✦ You can easily access this function by using the shortcut button (refer to page 114).
- ✦ When the earphones or Audio / Video cable is connected to the Miniket Photo, the built-in speaker will not operate.
- ✦ MENU button is not operable when music playback is paused.



Music Mode : Setting the Music Play Options

Setting the Equalizer

1. Turn the Mode Dial to *Music* mode.
2. Press the [POWER] button to turn on the Miniket Photo.
3. Press the [MENU] button on the stop mode.
4. Move the joystick left / right to select <Equalizer>.
5. Select an option by moving the joystick up / down and then press the joystick (OK).
 - ◆ <Normal> / <Pop> / <Jazz> / <Classic>
6. Press the [MENU] button to exit the menu.

[Note]

- ✦ You can easily access this function by using the shortcut button (refer to page 115).
- ✦ MENU button is not operable when music playback is paused.

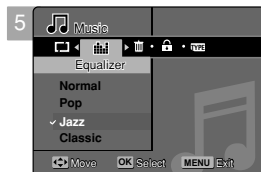

Music Mode : Setting the Music Play Options

Deleting Music Files

You can delete stored music files.

1. Turn the Mode Dial to *Music* mode.
2. Press the [POWER] button to turn on the Miniket Photo.
3. Press the [MENU] button on the stop mode.
4. Move the joystick left / right to select <Delete>.
5. Select an option by moving the joystick up / down button and then press the joystick (OK).
 - ◆ <Select>: The Playlist appears and you can select files to delete.
 - ◆ <All>: All music files will be deleted.
If <All> is selected, the message “Delete All?” appears. Select <Yes> or <No> by moving the joystick left / right and then press the joystick (OK) to confirm.
6. If <Select> was selected, select files to delete by moving the joystick up / down and press the joystick (OK).
 - ◆ Multiple Music files can be selected using the joystick (OK). <🗑️> indicator appears on the selected files.
7. Press the [Shortcut 4] button.
 - ◆ The message “Delete?” appears. Select <Yes> or <No> by moving the joystick left / right and then press the joystick (OK) to confirm.
8. Selected music files are deleted.
 - ◆ Press the [MENU] button to exit the menu.

[Notes]

- ✦ Deleting MP3 files in a user folder on the Miniket Photo will not delete the user folder. Delete the user folder on a PC.
- ✦ MENU button is not operable when music playback is paused.
- ✦ Protected files will not be deleted.

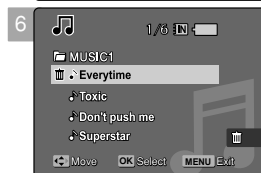

Music Mode : Setting the Music Play Options

Protecting Music Files

You can protect saved important music files from accidental deletion. Protected files will not be deleted unless you release the protection or format the memory.

1. Turn the Mode Dial to *Music* mode.
2. Press the [POWER] button to turn on the Miniket Photo.
3. Press the [MENU] button on the stop mode.
4. Move the joystick left / right to select <Protect>.
5. Select an option by moving the joystick up / down and then press the joystick (OK).
 - ◆ <Select>: The Playlist appears and you can select files to protect.
 - ◆ <All>: All files will be protected.
If <All> is selected, the message “Protect All?” appears. Select the desired option by moving the joystick left / right and then press the joystick (OK) to confirm.
6. If <Select> was selected, select files to protect by moving the joystick up / down and press the joystick (OK).
 - ◆ Multiple music files can be selected using the joystick (OK). <🔒 > indicator appears on the selected files.
7. Press the [Shortcut 3] button.
 - ◆ The message “Confirm?” appears. Select <Yes> or <No> by moving the joystick left / right and then press the joystick (OK) to confirm.
8. Selected music files are protected from an accidental erasure.
 - ◆ Press the [MENU] button to exit the menu.

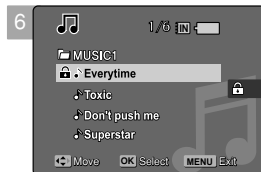

How to set to Voice mode

1. Turn the Mode Dial to *Voice* mode.

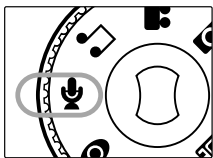

2. Press the [POWER] button to turn on the Miniket Photo.

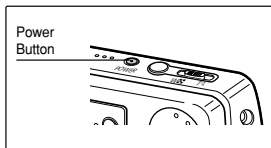

5 Voice Mode

Recording Voice Files	121
Recording Voice Files.....	121
Playing Voice Files	122
Playing Voice Files	122
Setting the Voice Play Options	123
Using the Shortcut Buttons.....	123
Setting the Repeated Play.....	125
Deleting Voice Files.....	126
Protecting Voice Files.....	127
Copying Voice Files	128

- ◆ Save important data / recordings separately on other media, to avoid accidental loss due to a system failure or other reasons.

Voice Mode : Recording Voice Files

Recording Voice Files

The built-in microphone allows users to record voices without any additional devices.

1. Turn the Mode Dial to *Voice* mode.
2. Press the [POWER] button.
 - ◆ The Voice Record screen appears.
3. Press the [Record / Stop] button to start recording.
 - ◆ <●> icon appears on the screen and starts recording.
4. To stop recording, press the [Record / Stop] button again.



[Notes]

- ✦ Recorded voice files are saved in the list automatically.
- ✦ During voice recording or in the voice recording mode, the menu is not accessed.
- ✦ Optimal distance for sound recording is 40cm.
- ✦ During voice recording, if the Mode Dial is changed and the recording will stop.

Voice Mode : Playing Voice Files

Playing Voice Files

You can play back recorded voice files using the built-in speaker or the earphones.

1. Turn the Mode Dial to *Voice* mode.
2. Press the [POWER] button.
3. Press the [Shortcut 1] button.
 - ◆ The Voice Play screen appears.
 - ◆ The last file recorded is displayed.
 - ◆ If there is no voice file stored, the message "No Stored voice!" appears.
4. Select a voice file to play by moving the joystick left / right button, and then press the joystick (OK).
 - ◆ To pause playing back, press the joystick (OK).
 - ◆ To stop playback, press and hold the joystick (OK).
 - ◆ To search backward / forward during play, hold down the joystick left / right for a while.
5. The selected voice file is played back.
6. To adjust the volume, move the joystick up / down.
 - ◆ Volume indicator appears and disappears after few seconds.

[Note]

- ✦ When the earphones or Audio/Video cable is connected to the Miniket Photo, the built-in speaker will not operate.



Voice Mode : Setting the Voice Play Options

Using the Shortcut Buttons

Shortcut buttons are provided to allow users easy access to frequently used functions.

Switching to Voice Record Mode

1. Turn the Mode Dial to *Voice* mode.
2. Press the [POWER] button to turn on the Miniket Photo.
3. Press the [Shortcut 1] button.
 - ◆ The Voice Play screen appears.
4. Press the [Shortcut 1] button again.
 - ◆ Each press of the [Shortcut 1] toggles between voice record and play modes.

Viewing the Voice File List

1. Turn the Mode Dial to *Voice* mode.
2. Press the [POWER] button to turn on the Miniket Photo.
3. Press the [Shortcut 1] button.
 - ◆ The Voice Play screen appears.
4. Press the [Shortcut 2] button.
 - ◆ Stored voice files are listed.
5. Select a voice file to play by moving the joystick up / down and then press the joystick (OK) or move the joystick right.
 - ◆ The selected voice file plays.

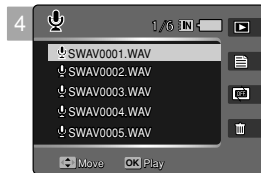

Voice Mode : Setting the Voice Play Options

Using the Shortcut Buttons

Shortcut buttons are provided to allow users easy access to frequently used functions.

Setting the Repeat Option

1. Turn the Mode Dial to *Voice* mode.
2. Press the [POWER] button to turn on the Miniket Photo.
3. Press the [Shortcut 1] button.
 - ◆ The Voice Play screen appears.
4. Press the [Shortcut 3] button.
 - ◆ Each press of the [Shortcut 3] button cycles through <Repeat><Repeat><Repeat><Repeat><Repeat>.

Deleting Voice Files

1. Turn the Mode Dial to *Voice* mode.
2. Press the [POWER] button to turn on the Miniket Photo.
3. Press the [Shortcut 1] button.
 - ◆ The Voice Play screen appears.
4. Press the [Shortcut 4] button.
 - ◆ <Delete>: Deletes the selected file.
 - ◆ <Cancel>: Cancels the deletion.



Voice Mode : Setting the Voice Play Options

Setting the Repeated Play

You can repeat a selected file or all the voice files.

1. Turn the Mode Dial to *Voice* mode.
2. Press the [POWER] button to turn on the Miniket Photo.
3. Press the [Shortcut 1] button.
 - ◆ The Voice Play screen appears.
4. Press the [MENU] button.
5. Move the joystick left / right to select <Repeat>.
6. Select an option by moving the joystick up / down and then press the joystick (OK).
 - ◆ <Off>: No repeat, selected file will play once.
 - ◆ <One>: One selected file will play repeatedly.
 - ◆ <All>: All voice files will play repeatedly.
 - ◆ <Shuffle>: All files will play in random order once.
7. Press the [MENU] button to exit the menu.
 - ◆ An icon indicating the selected repeat mode appears on the screen.

[Notes]

- ✦ You can easily access this function by using the shortcut button (refer to page 124).
- ✦ When the earphones or Audio/Video cable is connected to the Miniket Photo, the built-in speaker will not operate.
- ✦ You can access the menu only when the recorded voice file playback is stopped.



Voice Mode : Setting the Voice Play Options

Deleting Voice Files

You can delete stored voice files.

1. Turn the Mode Dial to *Voice* mode.
2. Press the [POWER] button to turn on the Miniket Photo.
3. Press the [Shortcut 1] button.
 - ◆ The Voice Play screen appears.
4. Press the [MENU] button.
 - ◆ Menu screen appears.
5. Move the joystick left / right to select <Delete>.
6. Select an option by moving the joystick up / down and then press the joystick (OK).
 - ◆ <Select>: The voice file list appears and you can select files to delete.
 - ◆ <All>: All files will be deleted.
If <All> is selected, the message “Delete All?” appears. Select a desired option by moving the joystick left / right and then press the joystick (OK) to confirm.
7. If <Select> was selected and playlist appears, select files by moving the joystick up / down and press the joystick (OK).
 - ◆ Multiple voice files can be selected using the joystick (OK). < > indicator appears on the selected files.
8. Press the [Shortcut 4] button.
 - ◆ The message “Delete?” appears. Select <Yes> or <No> by moving the joystick left / right and then press the joystick (OK) to confirm.
9. Press the [MENU] button to exit the menu.

[Notes]

- ✦ You can easily access this function by using the shortcut button (refer to page 124).
- ✦ After deleting a file, the last file of the current folder is selected.
- ✦ You can access the menu only when the recorded voice file playback is stopped.

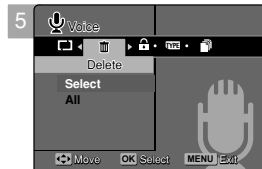

Voice Mode : Setting the Voice Play Options

Protecting Voice Files

You can protect saved important voice files from accidental erasure. Protected files will not be deleted unless you release the protection or format the memory.

1. Turn the Mode Dial to *Voice* mode.
2. Press the [POWER] button to turn on the Miniket Photo.
3. Press the [Shortcut 1] button.
 - ◆ The Voice Play screen appears.
4. Press the [MENU] button.
 - ◆ Menu screen appears.
5. Move the joystick left / right to select <Protect>.
6. Select an option by moving the joystick up / down button and then press the joystick (OK).
 - ◆ <Select>: The voice file list appears and you can select files to protect.
 - ◆ <All>: All files will be protected.

If <All> is selected, the message "Protect All?" appears. Select a desired option by moving the joystick left / right and then press the joystick (OK) to confirm.
7. If <Select> was selected and playlist appears, select files to protect by moving the joystick up / down and press the joystick (OK).
 - ◆ Multiple voice files can be selected using the joystick (OK). <A> indicator appears on the selected files.
8. Press the [Shortcut 3] button.
 - ◆ The message "Confirm?" appears. Select <Yes> or <No> by moving the joystick left / right and then press the joystick (OK) to confirm.
9. Press the [MENU] button to exit the menu.
 - ◆ An icon (A) indicating the protected file appears on the screen.

[Note]

- ✦ You can access the menu only when the recorded voice file playback is stopped.

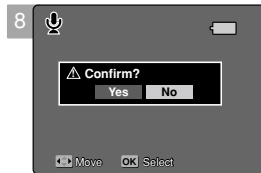

Voice Mode : Setting the Voice Play Options

Copying Voice Files

You can copy saved files from the internal memory to an mini SD card and vice-versa.

1. Turn the Mode Dial to *Voice* mode.
2. Press the [POWER] button to turn on the Miniket Photo.
3. Press the [Shortcut 1] button.
 - ◆ The Voice Play screen appears.
4. Press the [MENU] button.
 - ◆ Menu screen appears.
5. Move the joystick left / right to select <Copy (to)>.
6. Select an option by moving the joystick up / down and then press the joystick (OK).
 - ◆ <Select>: Voice file list appears and you can select files to copy.
 - ◆ <All>: All files will be copied.
If <All> is selected, the message "Copy All?" appears. Select <Yes> or <No> by moving the joystick left / right and then press the joystick (OK) to confirm.
7. If <Select> is selected, playlist appears. Select files to copy by moving the joystick up / down and press the joystick (OK).
 - ◆ An icon () indicating selected file is to be copied appears.
8. Press the [Shortcut 4] button.
 - ◆ The message "Copy?" appears. Select <Yes> or <No> by moving the joystick left / right and then press the joystick (OK) to confirm.
9. Press the [MENU] button to exit the menu.

[Notes]

- ✦ It copies from the currently-used memory to another.
- ✦ When <File No.> is set, file numbering will start from the next to the last file.

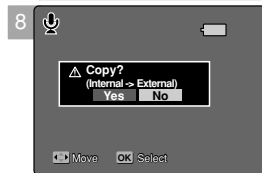

How to set to PC Cam mode

1. Turn the Mode Dial to *PC Cam* mode.

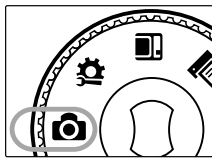

2. Press the [POWER] button to turn on the Miniket Photo.

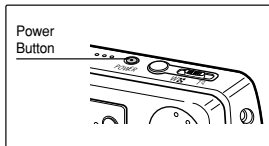

6 PC Cam mode

Using the PC Cam Function	130
Using the PC Cam Function.....	130

PC Cam Mode: Using the PC Cam Function

Using the PC Cam Function

The Miniket Photo can be used as a PC Camera for programmes such as Windows Messenger.

1. Connect the Miniket Photo to the PC with the provided USB cable as shown in the figure.
2. Turn on your PC.
3. Turn the Mode Dial to PC Cam mode.
4. Press the [POWER] button to turn on the Miniket Photo. Run a video chatting application such as Windows Messenger and enjoy the video utilisation.
 - ◆ Various applications take advantage of the PC Cam function. Refer to respective product documentation for further details.
5. When finished, disconnect the cable.

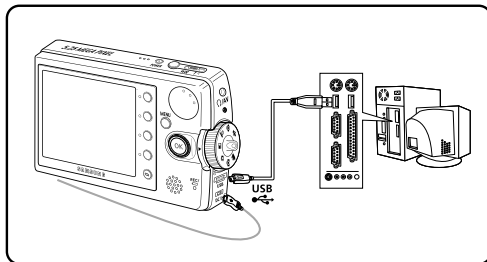

[Warning]

- ✦ The product does not support audio transfer. Please use separate microphone for audio transfer.

[Notes]

- ✦ You must install the DV Driver (refer to page 137).
- ✦ When the USB Port connection changed, it may require DV Driver re-installation.
- ✦ It is recommended to use an AC Power Adapter during data transfer to avoid unintended power outages.
- ✦ Microsoft Windows 98 SE or later operating systems support the PC Cam function.
- ✦ Supports USB 2.0.

7 PictBridge mode

How to set to PictBridge mode

1. Turn the Mode Dial to *PictBridge* mode.

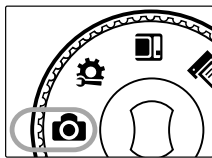

2. Press the [POWER] button to turn on the Miniket Photo.

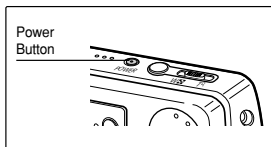

Printing with PictBridge	132
Printing with PictBridge.....	132

PictBridge Mode: Printing with PictBridge

Printing with PictBridge

With the provided USB cable and a PictBridge-supporting printer, you can print your photo images directly without connecting to a PC.

1. Connect the Miniket Photo and the PictBridge supporting printer with a USB cable.
2. Turn on the printer.
3. Turn the Mode Dial to Pictbridge mode.
4. Press the [POWER] button to turn on the Miniket Photo.
 - ◆ If the USB connection is not made, the message "Connect USB Cable!" appears.
5. Press the [Shortcut 2] button to set the date / time imprint option.
 - ◆ Each press of the [Shortcut 2] button cycles through Off>-Date -Time -Date & Time.
6. [Shortcut 3] button will increase the number of copies, while the [Shortcut 4] button will decrease the number of copies.
 - ◆ Range of possibilities: 1 ~ 99
 - ◆ Pressing the [Shortcut 3] button on 99 will set to 1.
 - ◆ Pressing the [Shortcut 4] button on 1 will set to 99.
7. Press the [Shortcut 1] button to begin printing.
 - ◆ To cancel printing, press the [Shortcut 1] button again.
8. When finished, disconnect the USB cable.

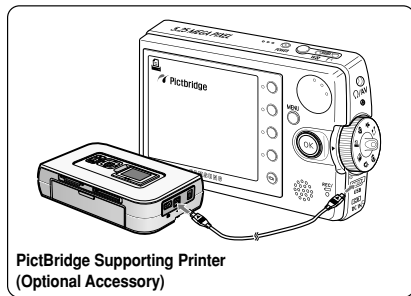

[Warning]

- ✦ This function works only with printers that support PictBridge.

[Notes]

- ✦ Number of copies and imprint options can be set in the menu. Press the [MENU] button to access the function.
- ✦ For printing information, refer to the User's manual of the printer.
- ✦ Depending on the printer, printing failure may occur. In this case, download JPEG files directly to the PC and print them.
- ✦ Depending on the printer, date and time imprint option may not be supported. In this case, date and time menu will not be displayed.

How to set to Storage mode

1. Turn the Mode Dial to *Storage mode*.

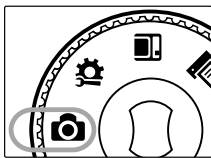

2. Press the [POWER] button to turn on the Miniket Photo.

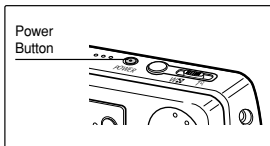

8 Storage Mode

Using as a Mass Storage Device	134
Using as a Mass Storage Device	134

- ◆ Save important data / recordings separately on other media, to avoid accidental loss due to a system failure or other reasons.

Storage Mode: Using as a Mass Storage Device

Using as a Mass Storage Device

You can use your Miniket Photo as a mass storage device.

1. Connect the Miniket Photo to the PC with the provided USB cable as shown in the diagram.
2. Turn on your PC.
3. Turn the Mode Dial to *Storage mode*.
4. Press the [POWER] button to turn on the Miniket Photo.
5. Select the memory to use the removable disk.
 - ◆ Windows XP: Dialog windows may pop up overlapped. You can select desired memory type. Internal memory is displayed <Miniket> and mini SD card is displayed <Removable Disk>.
 - ◆ Other than Windows XP: It appears to have two instances of "Removable Disk". If it displays D and E drives as removable disks, D is the mini SD card and E is the internal memory.
6. After copying to desired files on PC, you can copy to memory (Internal memory or mini SD card).
 - ◆ In Windows XP
 Internal Memory: <Miniket> - <MISC>
 External Memory (mini SD card): <Removable Disk> - <MISC>
7. When finished, disconnect the USB cable.

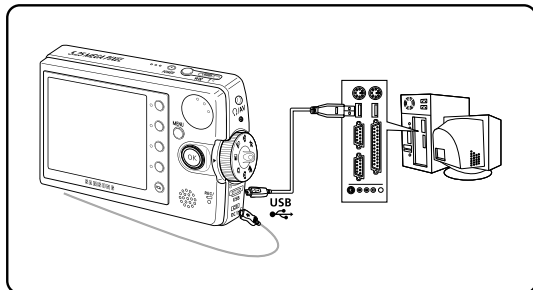

[Warning]

- ✦ You cannot create a new folder on your Miniket Photo set.
- ✦ If you create a new folder using a PC, it will not appear on the set.

[Notes]

- ✦ Disconnecting the USB cable while the data transfer will stop the data transfer and might damage the data stored.
- ✦ Multiple USB devices connected to a PC or using USB hubs may cause communication / installation errors with the Miniket Photo.
- ✦ Pop up dialogs will appear differently whether the memory has files or not.

9

Miscellaneous Information

Connecting to a PC	136
Supported USB Speed according to Operating System	136
Recommended System Requirements	136
Installing Software	137
Installing DV Media Pro 1.0.....	137
Installing DV Media Pro 1.0 / Video Studio	138
Connecting To Other Devices	139
Connecting to a PC Using USB Cable	139
Connecting to a TV Monitor	140
Connecting to a VCR.....	141
Printing Photos	142
Printing with DPOF	142
Cleaning and Maintenance	143
After using the Miniket photo.....	143
Cleaning the Body	144
Regarding the Battery.....	145
Using Abroad	146

Miscellaneous Information : Connecting to a PC

Supported USB Speed according to Operating System

The USB driver supports High Speed USB 2.0 communication only under the Microsoft(Windows) and Apple(Mac OS X), operating systems.

- ✦ Windows 98SE/ME: Full Speed USB
- ✦ Windows 2000 SP4: High Speed USB only with the Service Pack 4 or higher installed
- ✦ Windows XP: High Speed USB only with the Service Pack1 Installed
- ✦ Mac OS X: High Speed USB on 10.3 or higher

Recommended System Requirements

	Windows Environment		Macintosh Environment	
	Minimum	Recommended	Minimum	Recommended
CPU	Pentium III / 800MHz	Pentium IV / 2GHz	G3 / 500MHz	G4 Processor
OS	Windows 98SE/ME	Windows 2000 SP4/XP	Mac OS 10.2	Mac OS 10.3
Memory	256MB	512MB or above	128MB	512MB or above
Free space on the hard disk	1.2 GB or above	2GB or above	1 GB or above	2GB or above
Display Resolution	1024 x 768 dots 24bit colour	1024x768 dots 24-bit colour	800x600 dots 16-bit colour	1024x768 dots 24-bit colour
USB	USB 1.1	USB 2.0 High Speed	USB 1.1	USB 2.0 High Speed

[Notes]

- ✦ Movie playback or movie editing may be difficult on a slower-than-recommended PC. .
- ✦ Multiple USB devices connected to a PC or using USB hubs may cause communication / installation errors with the Miniket Photo.
- ✦ Disconnecting the USB cable during the data transfer will stop the communication and may damage data stored in the memory.

Miscellaneous Information : Installing Software

Installing DV Media Pro 1.0

You need to install DV Media Pro 1.0 to play back recorded movie files or the transferred data from Miniket Photo with the USB cable on your PC.

Before your start!

- ◆ Turn on your PC. Exit all other applications running.
- ◆ Insert the provided CD into the CD-ROM drive.

The setup screen appears automatically soon after the CD was inserted. If the setup screen does not appear, click on the "Start" on the bottom left corner and select "Run" to display a dialog. Type "D:\autorun.exe" and then press ENTER, if your CD-ROM drive is mapped to "D:Drive".

Installing Driver - DV Driver and DirectX 9.0

- ◆ DV Driver is a software driver that is required to support establishing connection to a PC. (If it is not installed, some functions will not be supported.)

1. Click on "DV Driver" on the Setup screen.

- ◆ Driver software required is installed automatically. Following drivers will be installed:
 - USB Removable disk driver (Windows 98 SE only)
 - USB PC-CAMERA driver

2. Click on <Confirm> to finish driver installation.

- ◆ Windows 98 SE users need to restart the PC.

3. If the "DirectX 9.0" is not installed, it is installed automatically after setting "DV Driver".

- ◆ After installing DirectX 9.0, PC needs to restart.
- ◆ If DirectX 9.0 is installed already, there is no need to restart of PC.

Application Installation - Video Codec

- ◆ **Click on "Video Codec" on the Setup screen.**

Video Codec is required to play movie files recorded by Miniket Photo on a PC.

Miscellaneous Information : Installing Software

Installing DV Media Pro 1.0 / Video Studio

Application Installation – Photo Express

1. Click “Photo Express” on the Setup screen.

- ◆ It is a photo editing tool that allows users to edit images.

Application Installation – Quick Time

1. Click “Quick Time” on the Setup screen.

- ◆ QuickTime is Apple's technology for handling movie, sound, animation, graphics, text, music, and even 360-degree virtual reality (VR) scenes.

Setting up the Video Studio

After inserting the CD, the setup screen displays automatically. Follow the instruction to start installation.

It is a video editing tool that allows users to edit movie files.

[Notes]

- ✦ For photo editing, use Photo Express.
- ✦ For movie playback on a PC, it is required to install software in this order : DV Driver - DirectX 9.0 - Video Codec
- ✦ For movie editing, use the Video Studio.
- ✦ For PC Cam use, it is required to install the DV Driver.
- ✦ Compatibility warning pop-up message may appear depending on PC manufacturers. Click on “Continue” to proceed following instructions.
- ✦ You have to install “DV Driver”, “Video Codec” and “DirectX 9.0” to run DV Media Pro 1.0 properly.

Miscellaneous Information : Connecting To Other Devices

Connecting to a PC Using USB Cable

Connect to a PC with the provided USB cable. You can view your files on your PC.

Connecting to a PC – Playing Files

1. **Connect the Miniket Photo to the PC with the provided USB cable as shown in the diagram.**
2. **Turn the Mode Dial to desired mode.**
3. **Press the [POWER] button to turn on the Miniket Photo.**
4. **Set the desired memory type on the PC.**
 - ◆ Windows XP: Dialog windows may pop up overlapped. You can select desired memory type. Internal memory is displayed <Miniket> and mini SD card is displayed <Removable Disk>.
 - ◆ Other than Windows XP: It appears to have two instances of "Removable Disk". If it displays D and E drives as removable disks, D is the mini SD card and E is the internal memory.
5. **Copy the file to your PC.**
It is recommended to copy the file onto the PC and playback on the PC for better performance.
6. **Double-click on the copied file name.**
It starts to play back.

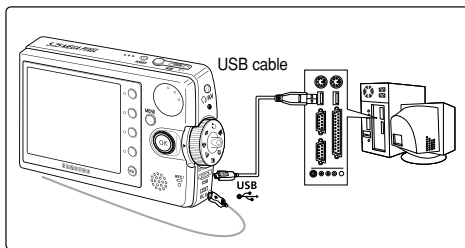

Disconnecting from a PC

1. **Click on the "Safely remove hardware" tray icon on the bottom right side of the desktop.**
Select the device and click on the "Stop" button.
2. **When the message saying that it is safe to remove the hardware appears, unplug the cable from the PC.**

[Warning]

- ❖ When data communication is disrupted due to static electricity, magnetic field or other reason, restart the programme or try to disconnect / connect the communication cable (USB Cable) again.
- ❖ In Windows XP, be informed that dialog windows may pop up overlapped.

[Notes]

- ❖ Multiple USB devices connected to a PC or using USB hubs may cause communication / installation errors with the Miniket Photo.
- ❖ Pop up dialogs will appear differently whether the memory has files or not.
- ❖ Refer to page 136 for PC recommendations on USB use. Some PCs meeting the requirements may not support proper USB operation due to various reasons. Please refer to the product documentation of the PC for further details.
- ❖ If you disconnect the USB cable from the PC or the Miniket Photo during the data transfer, the data transfer will stop and the data may be damaged.
- ❖ The Miniket Photo may operate abnormally in the recommended system environment depending on the assembling of PC. For example, the video file is played abnormally.

Miscellaneous Information : Connecting To Other Devices

Connecting to a TV Monitor

You can connect your Miniket Photo directly to a TV set. Set the appropriate video output when viewing movie on the TV (refer to page 45). Insert the Battery Pack.

1. **Connect the provided Audio/Video cable to the [Earphones and AV jack] of the Miniket Photo.**
2. **Connect the other end of the cable to the TV set by matching the colours of the terminals.**
3. **Turn on the TV and set the <Source> to the external input source you connected the cable.**
 - ◆ <Source> may be represented as <Line In>, <Input>, <AV Input>, etc. depending on the manufacturer.
4. **Turn the Mode Dial to *Movie* mode.**
 - ◆ Movie Record mode is displayed on the TV screen.
5. **Press the [Shortcut 1] button to switch to Movie Play mode.**
 - ◆ Select a movie file to play.
6. **Move the joystick left / right to select a movie and then press the joystick (OK).**
 - ◆ It begins playback.
 - ◆ To pause playback, press the joystick (OK).
 - ◆ To stop playback, hold down the joystick (OK).

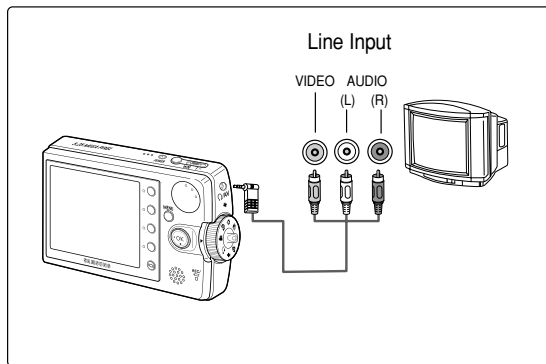

[Notes]

- ✦ You can play back photo files as well as movie files.
- ✦ When connected to other devices with the Audio/Video cable, no screen is displayed on the LCD monitor.
- ✦ AV equipments other than TV may not properly receive AV signal.
- ✦ When you connect your Miniket Photo with a TV, icons may appear cut out on the TV screen.

Miscellaneous Information : Connecting To Other Devices

Connecting to a VCR

You can connect your Miniket Photo to a TV set through a VCR.

1. Connect the provided Audio/Video Cable to the [Earphones and AV jack] of the Miniket Photo.
2. Connect the other end of the cable to the VCR set by matching the colours of the terminals.
3. Connect the Audio/Video Cable from TV Input to Video Output.
4. Turn on the TV and set the <Source> to the external input source.
5. Turn on the VCR and set the <Source> to the external input source where you connected the Miniket Photo.

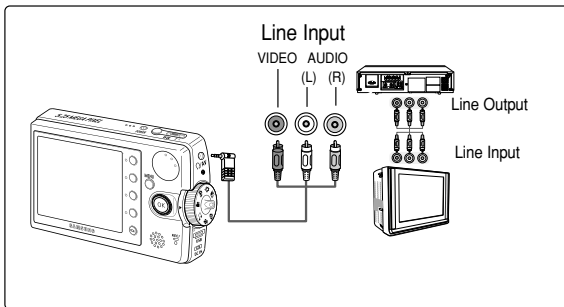

[Notes]

- ✦ You can play back photo files as well as the movie files.
- ✦ When connected to other devices with the Audio/Video cable, no screen is displayed on the LCD monitor.

Miscellaneous Information : Printing Photos

Printing with DPOF

DPOF (Digital Printing Order Format) defines the print information for each photo on the mini SD card. You can easily make prints using a DPOF-compatible printer or order copies from commercial digital image developers.

Printing DPOF files in the mini SD card

1. Set the DPOF information for the photo you want to print. (Refer to page 87)
2. Insert a mini SD card into the DPOF- supporting printer.
3. Follow the steps of the printer to print out photos.

[Notes]

- ✦ For further details about printing photos, refer to the user's manual of the printer.
- ✦ Printing may not be performed depending on types of printers.
In this case, download JPEG files directly to the PC and print them.

Miscellaneous Information : Cleaning and Maintenance

After using the Miniket Photo

- ✦ **For the safekeeping of the Miniket Photo, follow these steps.**
 - ✓ Turn the Miniket Photo off.
 - ✓ Remove the battery pack (refer to page 20).
 - ✓ Remove the mini SD card (refer to page 33).
- ✦ **To prevent any damage to the LCD monitor, do not apply excessive force to its moving parts.**
- ✦ **Do not drop or in any way shock the Miniket Photo.**
- ✦ **For prolonged use of the Miniket Photo, avoid using it in places subject to excessive humidity or dust.**
- ✦ **Do not leave the Miniket Photo in places subject to:**
 - ✓ Excessive humidity, steam, soot, or dust.
 - ✓ Excessive shock or vibration.
 - ✓ Extremely high (over 50°C or 122°F) or extremely low (under 0°C or 32°F) temperatures.
 - ✓ Strong electromagnetic fields.
 - ✓ Direct sunlight or in a closed car on a hot day.
- ✦ **For the safe use of the battery pack, follow these guidelines:**
 - ✓ To conserve battery power, be sure to turn off the Miniket Photo when not in use.
 - ✓ Battery consumption may vary depending on the condition of use. Recording with many starts and stops, frequent zooming, and recording in low temperatures will shorten actual recording times.
 - ✓ Dispose of used battery packs promptly. Do not dispose of Battery Packs by burning them.
 - ✓ The battery pack will become warm during charging and use. This is not a malfunction.
 - ✓ The battery pack has a limited service life. If the period of use becomes noticeably shorter with a normal charge, the battery pack is at the end of its service life. Replace it with a new battery pack.
- ✦ **For the safe use of the mini SD card, follow these guidelines:**
 - ✓ The mini SD card should be stored away from heaters and other heat sources. Avoid storing mini SD cards under direct sunlight and avoid electromagnetic fields.
 - ✓ Do not power off any devices while transferring data, as this may destroy the data.
 - ✓ Back up your image data often to a hard disk or other permanent storage media.
 - ✓ Format the mini SD card periodically.
 - ✓ When formatting the mini SD card, format in the Miniket Photo.

Miscellaneous Information : Cleaning and Maintenance

Cleaning the Body

✦ **To Clean the Exterior of the Miniket Photo**

- ✓ To clean the exterior, use a soft dry cloth. Wipe the body gently.
Do not apply excessive force when cleaning, gently rub the surface.
- ✓ The LCD monitor surface should not be pressed. Use a soft dry cloth to clean the surface.
- ✓ To clean the lens, use an optional air blower to blow out dirt and other small objects. Do not wipe the lens with a cloth or your fingers. If necessary, use lens cleaning paper.
- ✓ Do not use thinner, alcohol, or benzene for cleaning. Otherwise, the finish may be damaged.
- ✓ Cleaning should be done only after the battery pack has been removed, and other power sources have been disconnected.

[Note]

- ✦ If the lens looks dimmer, turn off the Miniket Photo and leave it for about 1 hour.

Miscellaneous Information : Cleaning and Maintenance

Regarding the Battery

- Battery Pack performance decreases when the surrounding temperature is 10°C (50°F) or below, and shortens the battery life. In that case, do one of the following so that the durability of the battery life can be extended for a longer period of time.
 - Put the battery pack in a pocket to warm it up, and insert it in your Miniket Photo immediately prior to use.
- Be sure to turn the [Power] button off when not recording or playing back. The battery power is also consumed in standby, playback, and pause modes.
- Have your battery packs ready for two to three times the expected recording time, and make trial recordings before make the actual recording.
- Do not expose the battery pack to water. The battery pack is not water resistant.
- Keep the battery out of reach of children. If it is swallowed, seek medical assistance immediately.
- Wipe the battery with a clean dry cloth to ensure proper contact.
- Do not pick up the battery using metal tools as this may cause a short circuit.
- Do not short the battery or dispose of the battery in fire. Do not disassemble the battery. The battery could explode or catch fire.
- Use only recommended batteries and accessories. Use of batteries not expressly recommended for this equipment may cause an explosion or leakage, resulting in fire, injury, or damage to the surroundings.
- Insert the battery according to the instructions. Improperly installed batteries can cause damage to the Miniket Photo.
- When you do not use the Miniket Photo for a long time, remove the battery pack. Otherwise, the battery may leak. To avoid damage to the product, be sure to remove the battery when no charge remains.

Miscellaneous Information : Cleaning and Maintenance

Using Abroad

- ✦ Each country or region has its own electric system and TV standards (NTSC / PAL)
- ✦ Before using the Miniket Photo abroad, check the following items:

Power Sources

- ✦ You can use the Miniket Photo in any country or area with the supplied AC Power Adapter where the power input range is 100V - 240V, 50/60Hz.
- ✦ Use a commercially available AC plug adapter if necessary, depending on the design of the local wall outlets.

TV Standards

- ✦ You can view your movie files using the built-in LCD monitor. However, to view your recordings on a television set or to copy it to a video cassette recorder (VCR), the television set or the VCR must comply with the TV standard and have the appropriate Audio / Video ports. You can set the TV standard of the Miniket Photo for its video output.

PAL-Compatible Countries / Regions

Australia, Austria, Belgium, Bulgaria, China, CIS, Czech Republic, Denmark, Egypt, Finland, France, Germany, Greece, Great Britain, Holland, Hong Kong, Hungary, India, Iran, Iraq, Kuwait, Libya, Malaysia, Mauritius, Norway, Romania, Saudi Arabia, Singapore, Slovak Republic, Spain, Sweden, Switzerland, Syria, Thailand, Tunisia, etc.

NTSC-Compatible Countries / Regions

Bahamas, Canada, Central America, Japan, Mexico, Philippines, Korea, Taiwan, United States of America, etc.

Troubleshooting : Self-Diagnosis Display

Self-Diagnosis Display

Display	Informs that...	Action
Memory Full!	Not enough free space for saving files.	Check the space of internal memory or the external memory.
Paper Error!	The paper is not inserted or set improperly.	Check the paper in the printer. If there is no paper, insert paper.
Print Error!	Paper jam or other printing error occurred.	Check the printer message. Refer to the printer manual for details.
Ink Error!	Ink is low.	Replace ink or toner.
Connect USB Cable!	USB cable is not connected or set improperly.	Check the USB connection. Disconnect and try to connect again.
Low Battery!	Battery Power is low.	Charge the Battery Pack or connect the AC Power Adapter.
Card Error	The mini SD card is not inserted or damaged.	Replace the mini SD card.
Not formatted!	The mini SD card is not formatted.	Format the mini SD card or replace with a formatted one.
Write Error!	Failed to write a file.	Check the memory space or format of the mini SD card.
Read Error!	Failed to read a file.	Delete the damaged / corrupted file.
Protect!	The file is protected.	To delete a protected file, unlock the protection prior to deletion.

Checklist

- ✦ Before contacting service personnel, please read and check following table. If the problem continues, contact your nearest Samsung dealer or authorised service centre / personnel.

Symptom	Possible Causes	Measure
No Power is supplied.	The power is not connected properly. The battery is dead. The battery is too cold.	Connect the AC Power Adapter properly, page 24 Replace with a new Battery Pack. Warm up the battery or move it to a warmer place.
Date / Time is wrong Focus does not adjust automatically	The Date / Time is not set. Focus mode is set to manual. Recording was done in a too-dark place. Lens is covered with condensation.	Set the Date / Time, pages 42 Set the focus mode to <Auto>. Use a strobe or light the place. Clear the lens and check the focus.
The mini SD card will not load properly.	The mini SD card is inserted improperly. Foreign substances are in the memory slot.	Insert the mini SD card properly, page 33. Clear the memory slot.
Colour balance of the picture is not natural.	White balance setting is not suitable for the recording situation.	Set proper white balance, page 69.
Digital zoom does not work.	The digital effect is set enabled.	Turn off the Digital Effects, page 66.
Files stored in the mini SD card can not be deleted.	Mini SD card is protected. The file is protected.	Release the mini SD card protection tab. Unlock the protection of the file, page 84.

Troubleshooting : Self-Diagnosis Display

Symptom	Possible Causes	Measure
Images on the LCD monitor appear dark.	Ambient light is too bright. Ambient temperature is too low.	Adjust the LCD brightness, page 41. Low temperature may produce a dark LCD screen. It is normal, not a malfunction.
Play, rewind, and fast forward do not work.	Photo Mode is selected.	Select Movie Mode and press the [Shortcut 1] button.
Mini SD card cannot play back (Photo Mode)	Movie Mode is selected.	Select Photo Mode and press the [Shortcut 1] button.
No picture is taken when [Record / Stop] button is fully pressed.	Not enough free memory space. Mini SD card was formatted using another device.	Empty the mini SD card to make free memory space. Format the mini SD card.
Built-in flash will not go off	Flash mode is set to Off Movie Mode is selected.	Select different flash mode, page 71. Flash will not work in Movie Mode.
Cannot record a movie	Photo Mode is selected.	Select Movie Mode.
LCD monitor turns off automatically.	To save power consumption, the LCD monitor and the Miniket photo goes down if there is no button operation for a certain period of time (depending on the operation mode), which is not a malfunction.	Pressing any button will turn the Miniket Photo back on. Pressing the button once again will operate its original function.
Maximum recording time and photo capacity is different than the specifications.	Recording / lighting conditions may affect the size of the recordings.	It is normal, not a malfunction.
Audio and Video does not play back.	Damaged data file.	Static electricity and strong magnetic fields may damage the data stored in the mini SD card. Be careful with handling the mini SD card. Damaged data cannot be recovered.
No audio plays when viewing photos.	Photo viewing does not support audio.	It is normal, not a malfunction.
Movie plays with mosaic and / or block-shaped noise.	Subject is moving fast. By the nature of MPEG4 playback.	It is normal. It is not malfunction. When you play back the movie on a PC, it plays back properly.
Data copied from a PC will not play.	Data file does not comply with the supported file format.	Non-supported file formats will not play. It is normal, not a malfunction.
MPEG4 movie taken will not play on a PC	Required driver / application software are not properly installed.	Install the required driver / application software, including the CODEC from the provided CD, page 137.
Music files will not play on the Miniket Photo	Data file does not comply with a supported file format.	The encoding format of the music file may not comply with a supported file format. Check the music file.
Audio / Video will not play when connected to a TV / VCR.	Cable connection was done improperly. The <Source> of the TV is set improperly.	Check the cable connections, page 140. Set the <source> to external input on the TV. Set the mode to Movie play by pressing the [Shortcut1] button, page 140.
OSD will not appear on the TV monitor.	Mode is set to Recording mode. TV set may not support on screen text display depending on manufacturer.	Set the mode to Movie Play, page 139. It is normal, not a malfunction.
Image looks blurry.	Focus is not set properly and the image looks blurry.	Check the lens is clean and no fingerprints or other foreign substances are contaminating the surface.

Using the Menu

Movie

1. Record

Program AE

Auto
Sports
Spotlight
Beach/Snow

White Balance

Auto
Daylight
Cloudy
Fluorescent H
Fluorescent L
Tungsten

Digital Effect

Off
Sepia
Nega
BLK&WHT

Macro

Off
Macro

Movie Quality

Super Fine
Fine
Normal

Movie Size

640x480
320x240

Self Timer

Off
2 sec
10 sec

Wind Cut

Off
On

Memory Type

Int. Memory
Memory Card

2. Play

Delete

Select
All

Protect

Select
All

All Play

Start
Repeat

Memory Type

Int. Memory
Memory Card

Copy (to)

Select
All

Music

1. Play

Repeat

Off
One
Group
All
Shuffle

Equalizer

Normal
Pop
Jazz
Classic

Delete

Select
All

Protect

Select
All

Memory Type

Int. Memory
Memory Card

Voice

1. Record

2. Play

Repeat

Off
One
All
Shuffle

Delete

Select
All

Protect

Select
All

Memory Type

Int. Memory
Memory Card

Copy (to)

Select
All

Specifications

Model Name	VP - MS10(S/BL/R)/ MS11(S/BL/R)/ MS12(S/BL/R)/ MS15(S/BL/R)
The System	
Movie	MPEG4 AVI Format
Photo	JPEG (DPOF, Exif 2.2)
Music	Stereo Playback (Earphones)
Voice	Wave file record / play (8KHz Sampling, 16bit, Mono)
Storage Media	Internal flash memory / mini SD card
LCD Panel	2.5" Trans reflective, 150K pixels
Internal Memory Capacity	VP - MS10 : 64MB/ MS11 : 128MB/ MS12 : 256MB/ MS15 : 512MB
Camera	
Imaging Sensor	1/2.5 inch CCD, 5.25 Mega-pixel (Total Pixel)
Zoom Ratio	X3 (Optical) / X5 (Digital)
Focal Length	f=6.3 ~ 18.9mm, F3.5 (W) ~ 4.3 (T)
Shutter Speed	8 ~ 1/2000 sec
Metering Method	Multi / Center / Spot
Electric Exposure Compensation	±2.0 V (0.3EV Step)
ISO	Auto, 100, 200, 400
White Balance	Auto, Daylight, Cloudy, Fluorescent H, Fluorescent L, Tungsten, Custom WB
Self Timer	2 seconds, 10 seconds
Multi Shot	3 continuous pictures, AEB (Automatic Exposure Bracketing)
Macro	Super Macro: 1 ~ 5 cm Macro: 10 ~ 50 cm
Scene Modes	Manual, Auto, Night, Portrait, Children, Landscape, Close-up, Sunset, Dawn, Backlight, Fireworks, Beach / Snow
Photo Size	2592X1944, 2272X1704, 2048X1536, 1600X1200, 1024X768, 640X480
Flash	Auto, Red-eye, Fill-in, Slow Sync.
Focus Method	Multi, Center, Spot

Specifications

Connectors		
USB		USB-Mini B type (USB 2.0 High Speed)
DC Power In Connector		Proprietary 3 pins connector
Common Connectors	Earphones	Ø3.5 Stereo
	AV Input / Output	Video: 1.0Vp _p , 75Ω, Audio: -7.5dBm 47KΩ
General		
Operating Temperature		0°C (32°F) ~ 40° (104°F)
Operating Humidity		10% ~ 80%
Power Source		3.7V (Li-Ion Battery Pack), 4.8V (AC Power Adapter)
Dimensions (WxHxD)		95mm x 56 mm x 19 mm (excluding extrusions)
Weight		143g (Including Battery Pack)
Built-in Microphone		Omni-directional Stereo condenser microphone
AC Power Adapter		
Input Voltage		AC 100 ~ 240V, 50 / 60 Hz
Output Voltage		DC 4.8V, 1.0 A
Operating Temperature		0°C (32°F) ~ 40° (104°F)
Operating Humidity		10% ~ 80%
Dimensions		70 mm x 30 mm x 42 mm
Weight		89.5g

The product design and specifications are subject to change without notice for better performance and quality.

Index

- A -

AC Power Adapter	13, 24
Auto Shut off	50
Anti-Shake	75

- B -

Battery Pack	20
Beep Sound	46

- C -

Charging the Battery	24
Capturing	53
Copy (to).....	88, 110, 128
Cleaning and Maintenance.....	143~146

- D -

Date&Time Set.....	42~44
Digital Effect	66, 97
Digital Zoom	76
DPOF	87, 142
DV Media Pro 1.0	137, 138

- E -

Earphones	13
EV	67
Exposure	67

- F -

File No.	38
Formatting	39
Focus.....	74

- H -

Hand Strap	13
------------------	----

- I -

ISO Sensitivity.....	68
Internal Memory	37

- J -

Joystick.....	29
---------------	----

- L -

Language	48
Lithium Ion Battery Pack.....	13

- M -

Mini SD card.....	32
Metering.....	63
Macro.....	70
Mode Dial	26
Movie.....	89

Index**- N -**

NTSC146

- P -

PC Cam130

PictBridge132

Protection83,108,119

Play55,92,113,122

PAL146

- Q -

Quality62,99

- R -

Resetting51

Record121

- S -

Shutter Sound47

Sepia66,97

Self Timer64,101

Slideshow86

Shortcut Button28

Safety Instructions8~11

Self Diagnosis Display147,148

- T -

Troubleshooting147, 148

- U -

USB139

- V -

Voice Record121

- W -

Wind Cut102

- Z -

Zooming In and Out54, 91

Power Sources (United Kingdom Only)

The plug used on this product is a unitary transformer plug and is designed specifically for this Miniket Photo it must never be replaced or removed with any other type of plug.



UNITED KINGDOM



REPUBLIC OF IRELAND

This Samsung product is warranted for the period of twelve (12) months from the original date of purchase, against defective materials and workmanship. In the event that warranty service is required, you should return the product to the retailer from whom it was purchased.

However, Samsung Authorised Dealers and Authorised Service Centres in other EC Countries will comply with the warranty on the terms issued to purchasers in the country concerned. In case of difficulty, details of our Authorised Service Centres are available from:

Samsung Electronics U.K. Ltd.

Unit C, Stafford Park 12

Telford, Shropshire

TF3 3BJ

The United Kingdom

Tel: 0870 242 0303, Fax: 01952 297617

www.samsung.com/uk

■ WARRANTY CONDITIONS

1. The warranty is only valid if, when warranty service is required, the warranty card is fully and properly completed and is presented with the original invoice or sales slip or confirmation, and the serial number on the product has not been defaced.
2. Samsung's obligations are limited to the repair or, at its discretion, replacement of the product or the defective part.
3. Warranty repairs must be carried out by Authorised Samsung Dealers or Authorised Service Centres. No reimbursement will be made for repairs carried out by non Samsung Dealers and, any such repair work and damage to the products caused by such repair work will not be covered by this warranty.
4. This product is not considered to be defective in materials nor workmanship by reason that it requires adaptation in order to conform to national or local technical or safety standards in force in any Country other than the one for which the product was originally designed and manufactured. This warranty will not cover, and no reimbursement will be made for such adaptation nor any damage which may result.
5. This warranty covers none of the following:
 - a) Periodic check ups, maintenance and repair or replacement of parts due to normal wear and tear.
 - b) Cost relating to transport, removal or installation of the product.
 - c) Misuse, including the failure to use this product for its normal purposes or incorrect installation.
 - d) Damage caused by Lightning, Water, Fire, Acts of God, War, Public Disturbances, incorrect mains voltage, improper ventilation or any other cause beyond the control of Samsung.
6. This warranty is valid for any person who legally acquired possession of the product during the warranty period.
7. The consumers statutory rights in any applicable national legislation whether against the retailer arising from the purchase contract or otherwise are not affected by this warranty. Unless there is national legislation to the contrary, the rights under this warranty are the consumers sole rights and Samsung, its subsidiaries and distributors shall not be liable for indirect or consequential loss or any damage to records, compact discs, videos or audio taper or any other related equipment or material.

SAMSUNG ELECTRONICS (U.K.) LTD.



ΕΛΛΑΣ (GREECE)

Αγαπητέ πελάτη,

Σας ευχαριστούμε για την εμπιστοσύνη που δείξατε στην **SAMSUNG** με την αγορά αυτής της συσκευής.

Το προϊόν αυτό της **SAMSUNG** είναι εγγυημένο για περίοδο δώδεκα (12) μηνών από την ημερομηνία αγοράς του για ανταλλακτικά και εργατικά. Στην περίπτωση που θα χρειαστεί επισκευή, το προϊόν αυτό της **SAMSUNG** θα πρέπει να σταλεί ή να μεταφερθεί στο εξουσιοδοτημένο **service**, με έξοδα του αγοραστή.

Εξουσιοδοτημένοι αντιπρόσωποι και εξουσιοδοτημένα κέντρα **service** σε άλλες Ευρωπαϊκές χώρες, θα αποδεχθούν τους όρους της εγγύησης.

Πληροφορίες για τα εξουσιοδοτημένα κέντρα **service** στην Ελλάδα, μπορείτε να πάρετε από την

FOURLIS TRADE A.E.B.E.

Λ. Κρουσιρίου 112

145 68 Κρουσέρι, Αττικής

Τηλ. 210.629.3100

■ Όροι της εγγύησης

1. Η εγγύηση ισχύει εάν και μόνο εάν το προϊόν χρειάζεται **service** και η κάρτα εγγύησης έχει πλήρως συμπληρωθεί και σφραγισθεί από το κατάστημα αγοράς. Επίσης πρέπει να προσκομισθεί και το τιμολόγιο ή η απόδειξη λιανικής πώλησης, πάνω στην οποία ο σειριακός αριθμός του προϊόντος πρέπει να είναι ευκρινής.
2. Η υποχρέωση της **SAMSUNG** αφορά μόνο την επισκευή του προϊόντος

3. Η επισκευή του προϊόντος πρέπει να ανατίθεται μόνο σε εξουσιοδοτημένα κέντρα **service** ή εξουσιοδοτημένους αντιπροσώπους της **SAMSUNG**. Καμία αποζημίωση δεν θα γίνει αποδεκτή για επισκευή που έχει γίνει από μη εξουσιοδοτημένο από την **SAMSUNG** συνεργείο.

4. Το προϊόν αυτό δεν θα θεωρηθεί ελαττωματικό στα υλικά ή στην εργασία επισκευής εάν θα πρέπει να προσαρμοστεί, μετατραπεί ή ρυθμιστεί ώστε να συμμορφωθεί με τις τοπικές τεχνικές προδιαγραφές ή προδιαγραφές που ισχύουν σε χώρα άλλη από αυτή για την οποία προοριζόταν ή κατασκευάστηκε.

Η εγγύηση αυτή δεν καλύπτει αποζημιώσεις για:

- * Κεφαλές βίντεο και κασетоφώνων
- * Κεφαλές βιντεοκάμερας
- * Γεννητήρες ακτινών **laser** στα **CD, DVD**
- * Τηλεχειριστήρια
- * Λυχνίες φούρνων μικροκυμάτων
- * Προσαρμογές, μετατροπές ή ρυθμίσεις, ανεξάρτητα αν είναι επιτυχής ή ανεπιτυχής, ούτε οποιαδήποτε ζημία προέρχεται εξ αυτού...

5. Η εγγύηση αυτή δεν καλύπτει καμία από τις παρακάτω περιπτώσεις:

- * Περιοδικούς ελέγχους, συντήρηση και επισκευή ή αντικατάσταση μερών που οφείλονται σε φυσιολογική φθορά
- * Τα έξοδα και τους κινδύνους μεταφοράς που σχετίζονται με την εγγύηση αυτού του προϊόντος
- * Ζημία σε αυτό το προϊόν που προέρχεται από:
 - A. Κατάχρηση ή και κακή χρήση, συμπεριλαμβανομένης αλλά και μη περιορισμένης σε:
Μη χρήση αυτού του προϊόντος για τους σκοπούς που φυσιολογικά προορίζεται ή σύμφωνα με τις οδηγίες χρήσεως για την σωστή χρήση και συντήρηση αυτού του προϊόντος
Την εγκατάσταση και χρήση του προϊόντος με τρόπους που αντίκεινται στις τεχνικές προδιαγραφές ασφαλείας που ισχύουν κατά την χρήση του προϊόντος
 - B. Επισκευή που έγινε από μη εξουσιοδοτημένα συνεργεία **service**
 - Γ. Ατυχήματα, θεομηνίες ή οποιαδήποτε αιτία πέρα του ελέγχου της **SAMSUNG**, συμπεριλαμβανομένων αλλά μη περιορισμένων των κεραυνών, του νερού, της φωτιάς, των δημοσίων αναταραχών, του κακού αερισμού κλπ.

Δ. Η εγγύηση αυτή δεν επηρεάζει τα δικαιώματα του καταναλωτή που προβλέπονται από την εφαρμοστέα εθνική νομοθεσία που ισχύει, ούτε τα δικαιώματα των καταναλωτών εναντίον των λιανοπωλητών που απορρέουν από την σύμβαση πώλησης.

Ε. Σε περίπτωση που δεν υπάρχει εθνική νομοθεσία αυτή η εγγύηση θα είναι η μοναδική και αποκλειστική κάλυψη του καταναλωτή για κάθε ζημιά.

FOURLIS TRADE A.E.B.E.

ENGLISH**Contact SAMSUNG WORLD WIDE**

If you have any questions or comments relating to Samsung products, please contact the SAMSUNG customer care centre.

Region Country	Customer	Care Center	Web Site
North America	CANADA	1-800-SAMSUNG (726-7864)	www.samsung.com/ca
	MEXICO	01-800-SAMSUNG (726-7864)	www.samsung.com/mx
	U.S.A	1-800-SAMSUNG (726-7864)	www.samsung.com
Latin America	ARGENTINE	0800-333-3733	www.samsung.com/ar
	BRAZIL	0800-124-421	www.samsung.com/br
	CHILE	800-726-7864(SAMSUNG)	www.samsung.com/cl
	COSTA RICA	0-800-507-7267	www.samsung.com/latin
	ECUADOR	1-800-10-7267	www.samsung.com/latin
	EL SALVADOR	800-6225	www.samsung.com/latin
	GUATEMALA	1-800-299-0013	www.samsung.com/latin
	JAMAICA	1-800-234-7267	www.samsung.com/latin
	PANAMA	800-7267	www.samsung.com/latin
	PUERTO RICO	1-800-682-3180	www.samsung.com/latin
	REP. DOMINICA	1-800-751-2676	www.samsung.com/latin
	TRINIDAD & TOBAGO	1-800-7267-864	www.samsung.com/latin
	VENEZUELA	1-800-100-5303	www.samsung.com/latin
Europe	BELGIUM	02 201 2418	www.samsung.com/be
	CZECH REPUBLIC	844 000 844	www.samsung.com/cz
	DENMARK	38 322 887	www.samsung.com/dk
	FINLAND	09 693 79 554	www.samsung.com/fi
	FRANCE	08 25 08 65 65 (0,15 /Min)	www.samsung.com/fr
	GERMANY	01805 - 121213 (0,12/Min)	www.samsung.de
	HUNGARY	06 40 985 985	www.samsung.com/hu
	ITALIA	199 153 153	www.samsung.com/it
	LUXEMBURG	02 261 03 710	www.samsung.lu
	NETHERLANDS	0900 20 200 88 (0.10/Min)	www.samsung.com/nl
	NORWAY	231 627 22	www.samsung.com/no
	POLAND	0 801 801 881	www.samsung.com/pl
	PORTUGAL	80 8 200 128	www.samsung.com/pt
	SLOVAKIA	0850 123 989	www.samsung.com/sk
	SPAIN	902 10 11 30	www.samsung.com/es
	SWEDEN	08 585 367 87	www.samsung.com/se
	U.K	0870 242 0303	www.samsung.com/uk
	CIS	RUSSIA	8-800-200-0400
UKRAINE		8-800-502-0000	www.samsung.com/ur
Asia Pacific	AUSTRALIA	1300 362 603	www.samsung.com/au
	CHINA	800-810-5858, 010- 6475 1880	www.samsung.com.cn
	HONG KONG	2862 6001	www.samsung.com/hk
	INDIA	3030 8282 1600 1100 11	www.samsung.com/in
	INDONESIA	0800-112-8888	www.samsung.com/id
	JAPAN	0120-327-527	www.samsung.com/jp
	MALAYSIA	1800-88-9999	www.samsung.com/my
	PHILIPPINES	1800-10-SAMSUNG (7267864)	www.samsung.com/ph
	SINGAPORE	1800-SAMSUNG (7267864)	www.samsung.com/sq
	THAILAND	1800-29-3232 02-689-3232	www.samsung.com/th
Middle East & Africa	TAIWAN	0800-329-999	www.samsung.com/tw
	VIETNAM	1 800 588 889	www.samsung.com/vn
	SOUTH AFRICA	0860 7267864 (SAMSUNG)	www.samsung.com/za
	U.A.E	800SAMSUNG (7267864)	www.samsung.com/nea

THE MINIKET PHOTO IS MANUFACTURED BY:



RoHS compliant

Our product complies with "The Restriction Of the use of certain Hazardous Substances in electrical and electronic equipment", and we do not use the 6 hazardous materials- Cadmium(Cd), Lead (Pb), Mercury (Hg), Hexavalent Chromium (Cr⁶⁺), Poly Brominated Biphenyls (PBBs), Poly Brominated Diphenyl Ethers (PBDEs)- in our products.

AD68-00934J