

# DETAILS

---

**Sirius-S50** PERSONAL SATELLITE RADIO + CAR KIT

---

**SIRIUS**   
SATELLITE RADIO

## **Congratulations on the purchase of your new Sirius S50**

The Sirius S50<sup>®</sup> allows you to capture and store up to 50 hours of SIRIUS Satellite Radio content, or a mix of SIRIUS<sup>®</sup> programming and MP3/WMA files, for portable entertainment. When attached to a home dock, vehicle dock, or executive docking station, the Sirius S50 provides easy access to live broadcasts and saved content, and captures and stores both scheduled and unscheduled SIRIUS programming. This feature allows you to listen to the unique programming provided by SIRIUS which you have saved, in locations where you would ordinarily be unable to receive adequate satellite reception.

When the Sirius S50 is docked and powered on, it gathers content in a variety of ways for listening on the go including My SIRIUS Channels, My Sirius Songs, scheduled recordings, and My Playlists.

The My Sirius Studio PC software which is included allows you to supplement the SIRIUS broadcast content with your own MP3/WMA library when attached to a PC through a USB connection. The PC application also allows for channel and image updates automatically when connected to the SIRIUS website.

The vehicle and home dock utilize a rotary Media Dial for quick and easy navigation. You can turn the Media Dial to find your favorite SIRIUS channel, tilt the Media Dial to pause, rewind, fast-forward, or save a favorite song or show.

Voice-assisted navigation informs you what channel you've selected, eliminating the need for you to take their eyes off the road while driving. The Sirius S50 also includes many other features, such as 30 channel presets; a jump button for one-touch tuning to traffic and weather reports or to a favorite SIRIUS channel; a sports ticker that flashes personalized sports scores; and a game alert feature which prompts you when your favorite NFL<sup>®</sup>, NHL<sup>®</sup>, NBA<sup>®</sup>, or other sports teams are playing on SIRIUS.



# Table of Contents

<b>TABLE OF CONTENTS.</b>	<b>2</b>
<b>WARNING AND SAFETY INFORMATION.</b>	<b>4</b>
FCC Warning.	4
FCC Compliance	4
Canadian Compliance	5
General Precautions	5
<b>END USER LICENSE AGREEMENT</b>	<b>7</b>
<b>PREFACE</b>	<b>11</b>
Copyrighted Broadcast Material	11
Copyrights & Trademarks	11
<b>PACKAGE CONTENTS.</b>	<b>12</b>
<b>CONTROLS</b>	<b>14</b>
Sirius S50 Reference Guide.	14
Remote Control Reference Guide.	19
Display Screen Information	21
Using the Media Dial	22
Audio Navigation	23
<b>GETTING STARTED</b>	<b>24</b>
Installing the Car Dock	24
Installing the Antenna	32
Connecting the Cigarette Lighter Adapter	34
Battery Installation, Charging, and Disposal.	35
Docking and Un-Docking the Media Player	38
Turning the Sirius S50 On and Off	39
Selecting an FM Frequency	40
Subscribing to the SIRIUS Service	40
Connecting the Media Player to a Computer	41
Using the Media Player with the Wearable Clip	42
<b>OPERATION</b>	<b>43</b>
Learning the Features	43

Listening Environments	43
Navigating Menus and Lists	44
Listening to Live Broadcasts	46
Channel Presets	47
Pausing a Live Broadcast	49
Saving Songs and Shows	52
Listening to Saved Songs, Shows, and MP3s	56
Saving Songs or Shows with a Scheduled Recording.	61
Game Alert.	64
Sports Ticker	66
Parental Controls	67
Hide Channels	70
FM Transmitter	71
Back/Jump Feature	73
Sleep Timer	75
Auto Shutdown	76
Auto Dimming	77
<b>SETUP MENU</b>	<b>78</b>
Setup Menu Navigation.	78
Audio Settings	79
Content Management	80
Device Settings	81
Display Settings.	85
Jump Settings	87
Parental Controls	87
Shut-Down Device.	88
Sport Settings	88
Time Settings.	89
<b>MY SIRIUS STUDIO SOFTWARE INSTALLATION</b>	<b>90</b>
<b>TROUBLESHOOTING</b>	<b>100</b>
<b>OPTIONAL ACCESSORIES.</b>	<b>102</b>
<b>SPECIFICATIONS.</b>	<b>104</b>
<b>WARRANTY</b>	<b>105</b>
<b>SIRIUS ID</b>	<b>106</b>
<b>INDEX.</b>	<b>107</b>

# Warning and Safety Information

## FCC Warning

This equipment may generate or use radio frequency energy. Changes or modifications to this equipment may cause harmful interference unless the modifications are expressly approved in this owners guide. The user could lose the authority to operate this equipment if an unauthorized change or modification is made.

## FCC Compliance

This equipment has been tested and found to comply with Part 15 of the FCC Rules. These rules are designed to provide reasonable protection against harmful interference. This equipment may cause harmful interference to radio communications if it is not installed and used in accordance with these instructions. However, there is no guarantee that interference will not occur in a particular installation. If this equipment does cause harmful interference to radio reception, which can be determined by turning the equipment off and on, the user is encouraged to try to correct the interference by one of more of the following measures:

- Reorient or relocate the receiving antenna.
- Increase the separation between the other equipment and the Receiver.
- Connect the other equipment to a different circuit from that to which the Receiver is connected.
- Consult the dealer or an experienced radio technician for help.

## Canadian Compliance

This Class B digital apparatus complies with Canadian ICES-003.

Cet appareil numérique de la classe B est conforme à la norme NMB-003 du Canada.

## General Precautions

### Liquid Crystal Precautions

If the LCD screen on the Sirius S50 is damaged, do not to touch the liquid crystal fluid. If any of the following situations happen, take the action indicated:

1. If the liquid crystal fluid comes in contact with your skin, wipe the skin area with a cloth and then wash the skin thoroughly with soap and running water.
2. If the liquid crystal fluid gets into your eye, flush the eye with clean water for at least 15 minutes. Seek medical care.
3. If the liquid crystal fluid is ingested, flush your mouth thoroughly with water. Drink large quantities of water and induce vomiting. Seek medical care.

### Safety Precautions

Be sure to observe the following warnings. Failure to follow these safety instructions and warnings may result in a serious accident.

- Do not operate the Sirius S50 in a way that might divert your attention from driving safely. As a driver, you alone are responsible for safely operating your vehicle in accordance with traffic safety laws at all times.
- Be sure the unit is installed as described in the installation instructions in this guide. When installing the unit using a Home Kit or Executive Kit, follow the installation instructions included with those kits.
- To avoid short circuits, do not open the unit, and never put or leave any metallic objects (coins, tools, etc.) inside the unit.
- If the unit emits smoke or unusual odors, turn the power off immediately, and disconnect the unit from any power source.

- Do not drop the unit or subject it to strong shocks.
- If the unit doesn't seem to be working properly, turn the unit off, remove the battery from the unit, wait 10 seconds, replace the battery and then turn it on again.

### My Sirius Studio Software

The My Sirius Studio Software CD included with the Sirius S50 will allow you to connect your Sirius S50 to your PC running the Windows® XP or Windows 2000 operating system. It is important that only this software be used to transfer and manage information on your Sirius S50 to ensure that the operating system software essential to the operation of the Sirius S50 is not removed or damaged. Should this essential software be removed or damaged, the Sirius S50 will no longer function.

The software also provides for upgrading features and functionality as they become available from SIRIUS. Be sure to periodically connect the Sirius S50 to your PC to load the latest updates. Refer to the user manual included on the software CD for further information on installing and using the software.

The My Sirius Studio software should be installed *before* connecting the Sirius S50 to your computer.

### Cigarette Lighter Adapter

Do not use any other power adapter for the Sirius S50, or connect it directly to the vehicle's power. Doing so will damage the unit.

The vehicle dock operates on 5v DC, 1.5A. Using anything other than the supplied cigarette lighter adapter to power the vehicle dock will void the warranty.

### Operating Temperature

The Sirius S50 is designed to operate between -5° to +40° C (23° to 104° F). Avoid leaving the unit in a vehicle or elsewhere where the temperature may fall outside this range. Extreme temperatures or extreme temperature fluctuations can degrade the performance of the LCD display screen, and possibly damage it.

### Cleaning and Maintenance

If the Sirius S50 becomes dirty, turn the power off and wipe it clean with the provided microfiber cleaning pouch. Do not use hard cloths, paint thinner, alcohol, or other volatile solvents to clean. These may cause damage to the unit.

# End User License Agreement

## SIRIUS SATELLITE RADIO INC. END USER LICENSE AGREEMENT (EULA)

This End User License Agreement (this "EULA") sets forth the agreement between you and Sirius Satellite Radio Inc. ("Sirius") for the use of the software in S Series Sirius satellite radio receivers (the "Receiver Software"), the My Sirius Studio computer software (the "Computer Software") and, together with the Receiver Software, the "Software") and their use with S Series Sirius satellite radio receiver and accessories (the "Receiver") and Sirius' satellite radio service (the "Sirius Service").

In addition, for your use of the Sirius Service, you agree to be bound by the "Terms & Conditions of Service" set forth at: <http://www.sirius.com/serviceterms> (the "Terms and Conditions").

YOU ACKNOWLEDGE AND AGREE THAT YOU HAVE READ AND UNDERSTAND THIS EULA. BY USING THE RECEIVER AND THE RECEIVER SOFTWARE, CLICKING ON THE "ACCEPT" BUTTON TO INSTALL THE COMPUTER SOFTWARE, AND/OR INSTALLING, COPYING OR OTHERWISE USING THE COMPUTER SOFTWARE, YOU AGREE TO BE BOUND BY THE TERMS OF THIS EULA. IF YOU DO NOT AGREE TO THE TERMS OF THIS EULA, CLICK ON THE "CANCEL" BUTTON IF YOU ARE INSTALLING THE COMPUTER SOFTWARE SO THAT IT IS NOT INSTALLED, AND DO NOT USE THE RECEIVER.

1. GRANT OF LICENSE. Sirius hereby grants to you a non-exclusive, limited, license to use the Software and any related documentation (the "Documentation"). You may: (a) use the Receiver Software (including the PPI Software (as defined below) in object code form only as fully integrated into the Receiver in order to operate the Receiver for its usual purpose, (b) use the Computer Software simultaneously on up to three computers and (c) copy the Computer Software for back-up and archival purposes; provided that any copy must contain all of the original Software's proprietary notices. Sirius and its suppliers, including without limitation, Microsoft Corporation ("Microsoft") and PortalPlayer, Inc. ("PortalPlayer), and their respective suppliers, retain all rights not expressly granted herein, including without limitation, all world-wide patent, copyright, trademark, trade secret and other proprietary rights associated with the Software. You agree that Sirius' suppliers (including Microsoft and PortalPlayer) are third party beneficiaries of this EULA and may enforce your performance of its terms.

2. LICENSE RESTRICTIONS. (a) You must be at least 18 years old to assume the obligations set forth in this EULA. Minors may use the Software and the Documentation only if a parent or legal guardian assumes the obligations set forth in this EULA and thereby assumes full responsibility for the minor's use of the Software and the Documentation.

(b) You may not: (i) permit other individuals to use the Computer Software; (ii) modify, translate, reverse engineer, decompile, extract source code from, disassemble (except to the extent that this restriction is expressly prohibited by law), reproduce, or create derivative works based upon the Software or the Documentation; (iii) copy the Software or the Documentation (except as permitted by Section 1(c)); (iv) rent, lease, publicly display, transfer, or otherwise transfer rights to the Software or the Documentation and/or (v) remove any proprietary notices or labels on the Software or the Documentation. Any violations of this Section 2(b) will immediately terminate your license to the Software and the Documentation.

(c) You may use the Software and the Documentation only in a manner that complies with all applicable laws in the jurisdictions in which you use the Software and the Documentation, including without limitation, applicable restrictions concerning copyright and other intellectual property rights.

(d) You may use the Software only for your private, non-commercial use. You may not use the Software in any way to provide, or as part of, any commercial service or application. Copies of content files, including without limitation songs and other audio recordings, which are stored and/or transferred using the Software, and which are protected by the copyright laws or related laws of any jurisdiction, are for your own personal use only and you may not publicly perform them or distribute them to third parties.

(e) By storing content on the Receiver, you are making a digital copy. You may not use the Receiver or the Software in an attempt to, or in conjunction with, any device, program or service designed to circumvent technological measures employed to control access to, or the rights in, a content file or other work protected by the copyright laws of any jurisdiction.

(f) The Software embodies a serial copying management system required by the laws of the United States. You may not circum-

vent or attempt to circumvent this system by any means.

(g) You shall not export or re-export the Software or the Receiver without the appropriate U.S. or foreign government licenses.

(h) The PPI Software (as defined below) is "commercial computer software" and any accompanying documentation is "commercial computer software documentation". Use, duplication or disclosure of the PPI Software and/or documentation by an agency or instrumentality of the U.S. government is subject to the terms of this EULA pursuant to FAR 12.212 or DFARS 227.7202, and their successors, as applicable.

(i) Supply of the Receiver and the Software does not convey a license nor imply any right to distribute content created with this product in revenue-generating broadcast systems (terrestrial, satellite, cable and/or other distribution channels), streaming applications (via Internet, intranets and/or other networks), other content distribution systems (pay-audio or audio-on-demand applications and the like) or on physical media (compact discs, digital versatile discs, semiconductor chips, hard drives, memory cards and the like). An independent license for such use is required. For details, please visit <http://mp3licensing.com>."

**3. AUTOMATIC COMMUNICATIONS FEATURES; USE OF INFORMATION.** (a) The Computer Software includes functionality that may automatically communicate information to Sirius or the Internet as part of its normal operation. These communications features may be enabled by default. You may opt out of these communications by changing the settings in preferences menu of the Computer Software. An initial list of the communications features is listed below. The communications features may be changed by any updates of the Computer Software that you install. By installing and/or using the Computer Software and any related updates, you agree to permit the installation and use of the communications features. You are responsible for any telecommunication or other connectivity charges incurred through use of the Computer Software.

(i) Once you install the Computer Software and connect the Receiver, the Computer Software may provide Sirius with user information, including electronic identification number of the Receiver (the "ESN").

(ii) The Computer Software may provide Sirius with the following information from time to time: the channels of the Sirius Service that you listen to on the Receiver and the amount of time which you listen, the content that you store on the Receiver, and the channels of the Sirius Service that you have set as presets on the Sirius Receiver.

(b) Sirius may match the ESN and other information it receives to personally identifiable information provided by you as part of your subscription to the Sirius Service. Sirius may use the information it receives to keep statistics on the aggregated anonymous use of the Software and/or the Sirius Service and to provide you with additional content. You may opt out of receiving any additional content by changing the settings in preferences menu of the Computer Software.

**4. DIGITAL RIGHTS MANAGEMENT.** (a) The Software uses the Microsoft digital rights management technology for Windows Media ("WM-DRM") to protect the integrity of Sirius and third party content ("Secure Content") so that the intellectual property, including without limitation, the copyright, in such content is not misappropriated. Portions of the WM DRM software (the "WM-DRM Software") use WM-DRM to transfer or play Secure Content. If the WM-DRM Software's security has been compromised, owners of Secure Content ("Secure Content Owners") may request that Microsoft revoke the WM-DRM Software's right to copy, display, transfer, and/or play Secure Content. Revocation does not alter the WM-DRM Software's ability to play unprotected content. A list of revoked WM-DRM Software is sent to your computer whenever you download a license for Secure Content from the Internet. Microsoft may, in conjunction with such license, also download revocation lists onto your computer on behalf of Secure Content Owners. Secure Content Owners may also require you to upgrade some of the WM-DRM components distributed with the WM-DRM software ("WM-DRM Upgrades") before accessing their content. When you attempt to play such content, WM-DRM Software built by Microsoft may notify you that a WM-DRM Upgrade is required and then ask for your consent before the WM-DRM Upgrade is downloaded. WM-DRM Software used by third parties may do the same. You agree that Microsoft and other third parties may upgrade the WM-DRM Software without notice to you. If you decline an upgrade, you will not be able to access content that requires the WM-DRM Upgrade; provided that, you will still be able to access unprotected content and Secure Content that does not require the upgrade.

(b) You may not take any action to circumvent or defeat the security or content usage rules provided or enforced by the WM-DRM Software. Sirius is not responsible for the operation of the WM-DRM Software in any way, including without limitation, revocation of the WM-DRM Software's right to copy, display, transfer, and/or play Secure Content. Sirius is not responsible for any communications to or from any Secure Content Owner, or for the collection or use of information by any Secure Content Owner.

**5. OWNERSHIP.** All title, ownership, rights, and intellectual property rights in and to the Software and the Documentation shall remain in the property of Sirius and its licensors. The Receiver Software contains software owned by PortalPlayer and/or its suppliers (the "PPI Software"). The PPI software includes MPEG Layer-3 audio coding technology licensed from Fraunhofer IIS and Thomson. The Software also includes Microsoft Windows Media Technology. The Software is protected by the copyright laws of the United States and international copyright treaties.

**6. WARRANTIES.** (a) Sirius warrants that for a period of 90 days from the date of your acquisition the Software if operated as

directed, will substantially achieve the functionality described in the Documentation and will be free from defects in material and workmanship. This warranty shall immediately terminate if the Software is used on or in conjunction with hardware or software other than the unmodified version of Receiver which the Software was designed to be used as described in the Documentation, any modifications are made to the Software during the warranty period, if the media is subjected to accident abuse or improper use, and/or the terms of this EULA are breached. Sirius does not warrant that use of the Software will be uninterrupted or that the operation of the Software will be error-free or secure. Depending on manufacturer and model of your Receiver, you may or may not be entitled to upgrades of the Receiver Software. Please check your Receiver owner's manual for further information.

(b) SIRIUS LICENSES THE SOFTWARE TO YOU "AS IS", AND TO THE MAXIMUM EXTENT PERMITTED BY APPLICABLE LAW SIRIUS AND ITS SUPPLIERS (INCLUDING MICROSOFT AND PORTALPLAYER) HEREBY DISCLAIM ALL OTHER WARRANTIES EITHER EXPRESS OR IMPLIED, INCLUDING WITHOUT LIMITATION IMPLIED WARRANTIES OF MERCHANTABILITY AND FITNESS FOR A PARTICULAR PURPOSE WITH REGARD TO THE SOFTWARE AND THE DOCUMENTATION. THIS LIMITED WARRANTY GIVES YOU SPECIFIC LEGAL RIGHTS; YOU MAY HAVE OTHER RIGHTS THAT VARY FROM STATE/JURISDICTION TO STATE/JURISDICTION.

(c) Sirius' sole liability for a breach of its warranties shall be in Sirius' sole discretion: (i) to replace your defective media, (ii) to advise you how to achieve substantially the same functionality with the Software as described in the Documentation through a procedure different from that set forth in the Documentation and/or (iii) if the above remedies are impracticable, to refund the license fee, if any, you paid for the Software. Repaired, corrected or replaced copies of the Software and the Documentation shall be covered by the same limited warranty for the period remaining under the warranty that covered the original copy of the Software or if longer for 30 days after the date Sirius either provided you with the repaired or replaced copy of the Software or advised you as to how to operate the Software so as to achieve the functionality described in the Documentation, whichever is applicable. Sirius will be obligated to honor its obligations in this Section 6(c) only if you inform Sirius of the problem with the Software during the applicable warranty period and provide evidence of the date you acquired the Software.

**7. INDEMNIFICATION.** (a) You shall defend, indemnify and harmless Sirius, its officers, directors and employees, from and against any losses, damages, fines and expenses, including without limitation, attorneys' fees and expenses, arising out of or relating to any claims that you have: (i) viewed, downloaded, encoded, compressed, copied or transmitted any in connection with the Software in violation of another party's rights or in violation of any law, or (ii) violated any terms of this EULA and/or the Terms and Conditions.

(b) If you are importing the Software from the United States, you shall defend, indemnify and hold harmless Sirius from and against any import and export duties or other claims arising from such importation.

**8. LIMITATION OF LIABILITY.** NEITHER SIRIUS NOR ITS SUPPLIERS (INCLUDING MICROSOFT AND PORTALPLAYER) IS RESPONSIBLE FOR ANY SPECIAL, INCIDENTAL, OR CONSEQUENTIAL DAMAGES OR LOSSES RELATING TO THE USE AND/OR PURCHASE OF THE SOFTWARE, THE DOCUMENTATION, THE RECEIVER AND/OR THE SIRIUS SERVICE, INCLUDING WITHOUT LIMITATION, COMPUTER FAILURE AND/OR MALFUNCTION, WHETHER BASED ON NEGLIGENCE OR OTHERWISE, AND WHETHER OR NOT SIRIUS OR SUCH SUPPLIER (INCLUDING MICROSOFT AND PORTALPLAYER) HAS BEEN ADVISED OF THE POSSIBILITY THEREOF. SIRIUS TOTAL LIABILITY TO YOU AND ANY OTHER PERSONS USING THE RECEIVER, THE SOFTWARE AND/OR THE DOCUMENTATION, REGARDLESS OF THE CAUSE, WILL IN NO EVENT EXCEED THE AMOUNTS THAT YOU HAVE PAID TO SIRIUS FOR THE RECEIVER, THE SOFTWARE AND THE DOCUMENTATION. THIS ALLOCATION OF RISK AND THE DISCLAIMER OF WARRANTIES IS REFLECTED IN SIRIUS' PRICES AND IS A FUNDAMENTAL ELEMENT OF SIRIUS AGREEMENT TO PROVIDE YOU WITH THE SOFTWARE AND THE DOCUMENTATION. YOU MAY HAVE GREATER RIGHTS THAN DESCRIBED ABOVE UNDER YOUR STATE'S LAWS.

**9. TERMINATION.** (a) This EULA will automatically terminate without notice if you fail to comply with any of its terms

(b) This EULA may also terminate without notice to you in the event Sirius' or any of its suppliers (including without limitation Microsoft and PortalPlayer) licenses for technology incorporated into the Software terminates.

(c) You may terminate this EULA at any time by providing Sirius with written notice of termination to: Sirius Satellite Radio Inc., 1221 Avenue of the Americas, 36th Floor, New York, New York 10020, Attention: My Sirius Studio Software Termination.

(d) Upon any termination of this EULA, you shall immediately discontinue use of the Software and shall within three days return to Sirius, or certify destruction of, all full or partial copies of the Software, documentation and related materials provided by Sirius. Your obligation to pay accrued charges and fees shall survive any termination of this License Agreement.

(e) Except for the license granted in paragraph 1, the terms of this EULA shall survive termination under this paragraph 10.

**10. RESOLVING DISPUTES.** In order to expedite and control the cost of disputes, you agree that any legal equitable claim (a "Claim") relating to the Software, the Documentation and/or this EULA, will be resolved as follows:

(a) Informal Resolution. You and Sirius will first try to resolve any Claim informally. Accordingly, neither you nor Sirius may start a formal proceeding (except for Claims described in Section 10(d)) for at least 60 days after one of us notifies the other of a Claim

in writing. To initiate a Claim, you must send notice by U.S. mail to: Sirius Satellite Radio Inc., 1221 Avenue of the Americas, 36th Floor, New York, New York 10020, Attention: General Counsel. If Sirius initiates a Claim, notice will be sent to your address on file with Sirius.

(b) Formal Resolution. Except as provided in Section 10(d), if you and Sirius cannot resolve a Claim informally, any Claim either of you or Sirius asserts will be resolved only by binding arbitration. The arbitration will be conducted under the Commercial Arbitration Rules of the American Arbitration Association (the "AAA Rules") that are in effect at the time the arbitration is initiated and under the rules set forth in this EULA. If there is a conflict between the AAA Rules and this EULA, this EULA will govern. **ARBITRATION MEANS THAT YOU WAIVE YOUR RIGHT TO A JURY TRIAL.** If you initiate an arbitration, you agree to pay a fee of \$125 or, if less and you notify Sirius in writing, the amount that you would pay to initiate a lawsuit against Sirius in the appropriate court of your state. Sirius agrees to pay any additional fee or deposit required by the American Arbitration Association in excess of your filing fee. Sirius also agrees to pay the costs of the arbitration proceeding up to a maximum of one-half day (four hours) of hearings. Other fees, such as attorney's fees, expenses, travel to the arbitration and the costs of a proceeding that goes beyond one-half day, will be paid in accordance with the AAA Rules. The arbitration will be held at a location within 100 miles of your residence unless you and Sirius both agree to another location. To start the arbitration, you or Sirius must do the following things:

(i) Write a demand for arbitration. The demand must include a description of the Claim and the amount of damages sought to be recovered;

(ii) Send three copies of the demand for arbitration plus the appropriate filing fee to: American Arbitration Association, 601 Pennsylvania Avenue, N.W., Suite 700, Washington, D.C. 20004; and

(iii) Send one copy of the demand for arbitration by U.S. mail to Sirius Satellite Radio Inc., 1221 Avenue of the Americas, 36th Floor, New York, New York 10020, Attention: General Counsel, or to your address on file with Sirius (if Sirius starts the arbitration).

(c) Binding Effect. In the arbitration proceeding, the arbitrator must follow applicable law, and any award may be challenged if the arbitrator fails to do so. The arbitrators shall not have the power, jurisdiction or authority to waive, amend and/or modify any of the terms or provisions of this EULA. The arbitrators shall enforce this EULA in accordance with its terms and provisions.

Otherwise, the arbitrator's decision is final and binding on all parties and may be enforced in any federal or state court that has jurisdiction. A court may sever any portion of this Section 9 that it finds to be unenforceable.

(d) Exceptions. Notwithstanding the foregoing, any: (i) dispute over the validity of intellectual property rights or Sirius licenses to operate its business; (ii) Claim based on Section 2(a) above; and (iii) dispute involving a violation of the Communications Act of 1934, 47 U.S.C. §605, or the Electronic Communications Privacy Act, 18 U.S.C. §§2510-2521, may be decided only by a court of competent jurisdiction.

11. MISCELLANEOUS. (a) Notice. Notices to you will be deemed given when deposited in the mail or when sent by email.

Notices may be included in statements or other communications to you. Sirius may also provide notice to you by telephone, which will be deemed given when a message is left with you, someone answering the telephone at your residence or on an answering machine or voice mail system at your phone number on record with Sirius. Your notices to Sirius will be deemed given when Sirius receives them 1221 Avenue of the Americas, 36th Floor, New York, New York 10020, Attention: General Counsel.

(b) Applicable Law. The interpretation and enforcement of this EULA shall be governed by the internal laws of the State of New York. This EULA is subject to modification if required by such laws. Notwithstanding the foregoing, Section 10 shall be governed by the Federal Arbitration Act. You agree that the United Nations Convention on Contracts for the International Sale of Goods is specifically excluded from application to this EULA.

(c) Assignment. Except as set forth in this paragraph 11(c), you may not assign your rights and/or obligations under this EULA to any third party. If you sell or otherwise transfer the Receiver as a whole, you may transfer the Receiver Software as fully integrated into the Receiver; provided that you also supply this EULA to the purchaser or recipient of the Receiver, at which time all of your rights under this EULA will immediately cease. Sirius may assign its rights and/or obligations under this EULA to any third party without notice for any purpose, including without limitation, in the event of an acquisition, corporate reorganization, merger or sale of substantially all of Sirius' assets to another entity. You hereby consent to such assignment.

(d) No Waiver. No failure or delay on the part of Sirius or its suppliers (including Microsoft and PortalPlayer) in exercising any right, power or privilege hereunder and no course of dealing by Sirius or its suppliers (including Microsoft and PortalPlayer) shall operate as a waiver of any right, power or privilege hereunder.

(e) Other. This EULA constitutes the entire agreement between you and Sirius relating to your use of the Software and the Documentation. No salesperson or other representative is authorized to change it for you. If any provision is declared by a competent authority to be invalid, that provision will be deleted or modified to the extent necessary, and the rest of this EULA will remain enforceable.

## Preface

## Copyrighted Broadcast Material

Several features of the Sirius S50 enable you to record and store broadcast content for playback. Broadcast content is subject to copyright laws, and distribution of copyrighted material is prohibited by law without the express permission of the copyright holder. To prevent unlawful distribution of copyrighted material, the Sirius S50 prevents you from electronically copying stored (recorded) songs or shows to another device.

## Copyrights & Trademarks

© 2005 SIRIUS Satellite Radio Inc. All Rights Reserved.

® "SIRIUS", My Sirius Studio, S Series and related marks, the SIRIUS dog logo, channel names and logos are trademarks of SIRIUS Satellite Radio Inc. "NFL" and the NFL Shield logo, and the NFL Sunday Drive name and logo are registered trademarks of the National Football League. "NHL" and the NHL Shield are registered trademarks of the National Hockey League. "NBA" and the NBA silhouette logo are registered trademarks of NBA Properties Inc. Microsoft, Windows, and Windows Media Player are registered trademarks of Microsoft Corporation. All other trademarks, service marks, sports team names, album art, and logos are the property of their respective owners. All Rights Reserved.

™ PortalPlayer and the PortalPlayer logo are trademarks owned by PortalPlayer, Inc.

# Package Contents

The following items are included with your purchase of the Sirius S50:

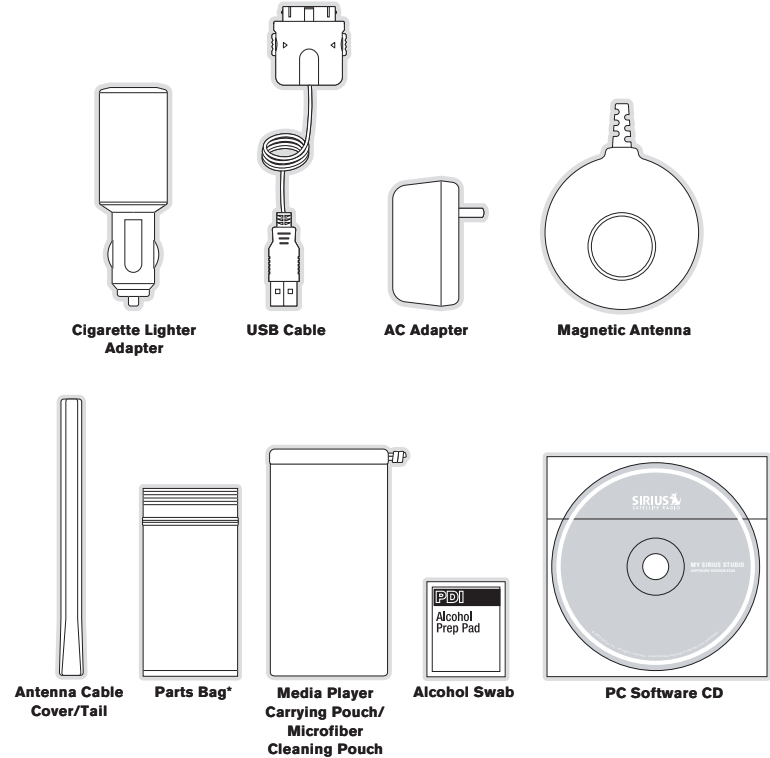
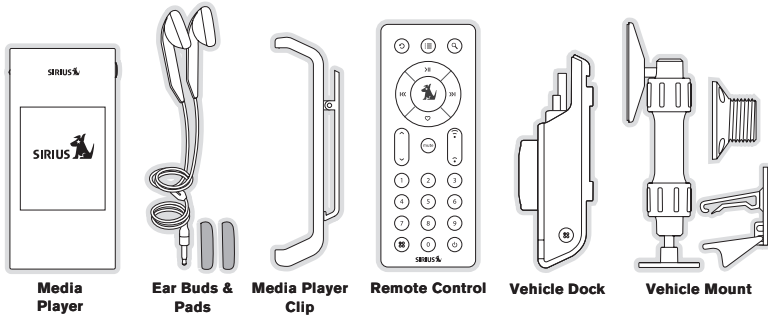

\*The parts bag contains mounting screws and an alcohol swab.



# Controls

## Sirius S50 Reference Guide

Figure 1 identifies the buttons, controls, and connectors of the Sirius S50.

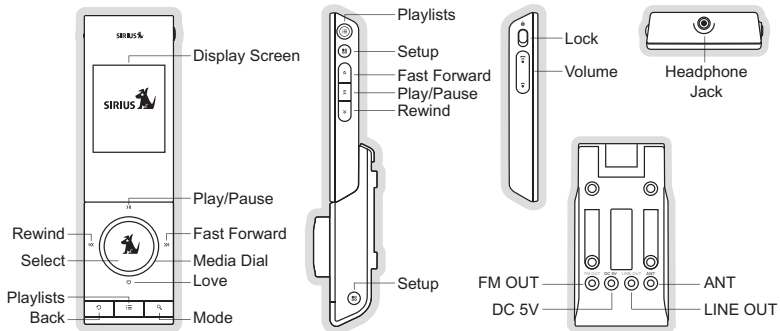











Figure 1

The following tables describe the functions of the buttons, controls, and connectors on the vehicle dock and the media player.







Vehicle Dock Button Descriptions			
Button	Action	Live Environment Description	Playback Environment Description
 <b>Play/Pause</b>	Press	Pauses a live broadcast or resumes playing a broadcast	Plays or pauses the current song or show
	Hold	If paused, returns to live broadcast If in a channel list, plays the highlighted channel	No Action
 <b>Rewind</b>	Press	Rewinds a broadcast to previous song or show	Rewinds to the previous song or show
	Hold	Rewinds through a broadcast	Rewinds through song or show
 <b>Fast-Forward</b>	Press	Fast-Forwards the replay buffer to the next song or show	Fast-Forwards to the next song or show
	Hold	Fast-Forwards through the replay buffer	Fast-Forwards through song or show
 <b>Love</b>	Press		If listening to My Sirius Channels, No Action
	Hold	Saves song or show Cancels currently active recording	If listening to My Sirius Songs or My Sirius Shows, displays prompt to delete the song or show
 <b>Media Dial</b>	Turn	If listening to live broadcast, tunes next channel If in a list, menu, or prompt, scrolls to next or previous item	If listening to playlist, no action If in a list, menu, or prompt, scrolls to next or previous item

Vehicle Dock Button Descriptions <i>Continued</i>			
Button	Action	Live Environment Description	Playback Environment Description
 <b>Select</b>	Press	Selects highlighted items in lists, menus, or prompts	
	Hold	Allows you to Add/Move/Remove a preset	No Action
 <b>Playlists</b>	Press	Allows you to browse the playlists	Goes to the most recent playlist menu screen and highlights the currently selected song or show If browsing playlists, moves up one level in the playlist menu structure
	Hold	No Action	No Action
 <b>Back</b>	Press	If listening, returns to previous channel or playlist If in a list at the top level, exits and returns back to previous content If in a list not at the top level, moves up one level in the list structure	
	Hold	Jumps to programmed traffic/weather or other channel If a jump is pending, cancels jump If in a list or in Setup, exits the list or Setup	
 <b>Mode</b>	Press	First push allows you to browse live channels according to the current tuning mode Second push cycles browse mode between Channel, Genre, and Presets	
	Hold	Cycles between channel name/artist/title when in browse mode	No Action

Vehicle Dock Button Descriptions <i>Continued</i>			
Button	Action	Live Environment Description	Playback Environment Description
 <b>Setup</b>	Press	Displays the <i>Setup</i> menu If in the <i>Setup</i> menus, moves up one level in the menu structure	
	Hold	First push and hold displays the frequency of the currently selected FM preset for 10 seconds Second and subsequent push within 10 seconds cycles through the FM presets	

Vehicle Dock Connector Descriptions	
Connector	Description
<b>FM OUT</b>	FM output connection. This connection may be used to connect to the optional FM Relay Switch which connects to the vehicle's FM radio antenna input.
<b>DC 5V</b>	Connection for the Cigarette Lighter Adapter.
<b>LINE OUT</b>	Audio output for connection to the vehicle's audio system. An audio cable (not supplied) is required to utilize this connection.
<b>ANT</b>	Connection for the Magnetic Antenna.

Media Player Button Descriptions		
Button	Action	Description
 <b>Playlists</b>	Press	Displays the Playlists
	Hold	Turns the Sirius S50 on and off

Media Player Button Descriptions <i>Continued</i>		
Button	Action	Description
 <b>Setup</b>	Press	Displays the <i>Setup</i> menu If in the <i>Setup</i> menus, moves up one level in the menu structure
	Hold	No Action.
 <b>Rewind</b>	Press	If listening, rewinds to the previous song or show If in a menu, scrolls down
	Hold	If listening, rewinds through song or show If in a menu, scrolls down until the button is released
 <b>Play/Pause</b>	Press	Plays or pauses a song or show Selects highlighted items in lists, menus, or prompts
	Hold	When listening to playlists, displays Save or Delete prompt When listening to My Sirius Channels, allows you to Love songs
 <b>Fast-Forward</b>	Press	If Listening, Fast-Forwards to the next song or show If in a menu, scrolls up
	Hold	Fast-Forwards through song or show If in a menu, scrolls up until the button is released
 <b>Volume</b>	Press	Increases or decreases the volume
 <b>Lock</b>	On	Slide Up – Locks all other buttons on the media player
	Off	Slide Down – Unlocks all buttons on the media player

## Remote Control Reference Guide

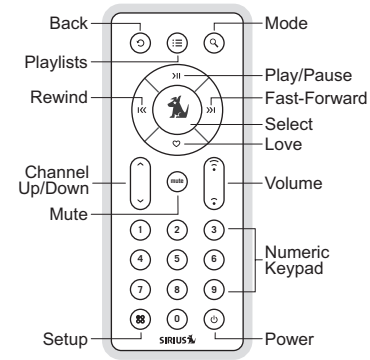

Figure 1 identifies the buttons of the remote control.



**Figure 1**

The following table describes the functions of the buttons of the remote control. Note that only the buttons unique to the remote control are described. Please refer to the vehicle dock button descriptions for descriptions of the other buttons.

Remote Control Button Descriptions		
Button	Action	Description
 <b>Power</b>	Press	Turns the Sirius S50 on/off
	Hold	Turns the Sirius S50 on/off

Remote Control Button Descriptions <i>Continued</i>		
Button	Action	Description
<b>0 - 9</b>	Press	Directly selects the channel indicated by the numbers which were pressed
<b>Mute</b>	Press	Mutes (or un-mutes) the audio
 <b>Volume</b>	Press	Increases or decreases the volume
 <b>Channel Up/Down</b>	Press	Tunes the next or previous channel When in a list, menu, or prompt, scrolls up and down

## Display Screen Information

The display screen of the Sirius S50 provides information about the operation of the Sirius S50, such as the currently tuned channel, song or show being played, mode, status, recording, and other information. Figure 1 identifies the display screen information when listening to a live broadcast and when playing back saved content.

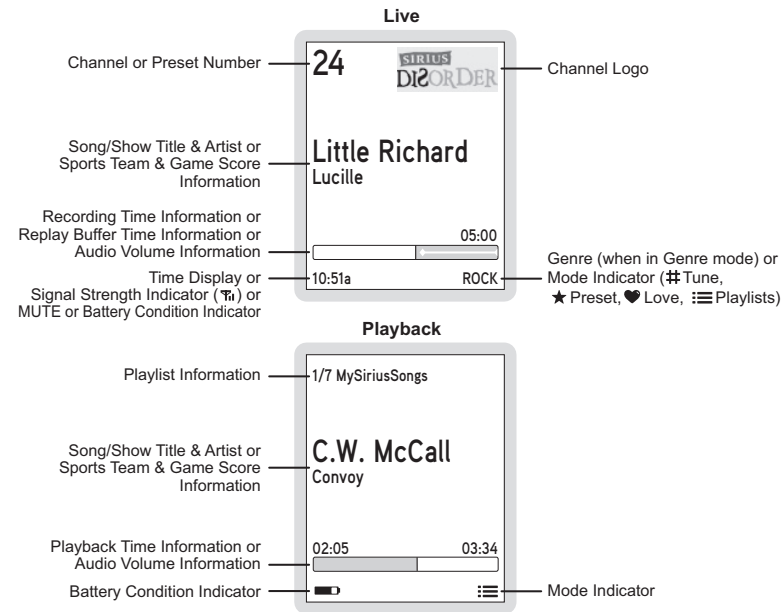









Figure 1

## Using the Media Dial

The  Media Dial is a unique multifunction control which can be turned and pressed to accomplish many functions of the Sirius S50. Turning the  Media Dial clockwise or counter-clockwise which will scroll channels, genres, presets, menus and lists. Pressing the  Media Dial in the center (on the SIRIUS dog logo) provides the 'Select' function for choosing channels, genres, presets, prompts, menu or list items.

The  Media Dial also provides for selecting four other functions when pressed at the north, south, east, or west positions as shown in Figure 1 ( Play/Pause,  Love,  Fast-Forward, and  Rewind).

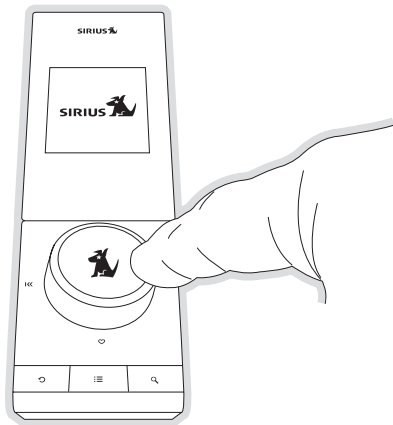



Figure 1

## Audio Navigation

The Sirius S50 features Audio Navigation which provides voice announcements when buttons are pressed or the  Media Dial is turned, announcing the various modes or the channel tuned. Audio prompts are also provided for navigating certain other functions such as channel presets.

Audio Navigation may be turned off using  Setup. Refer to the **Audio Nav On/Off** section on page 79.

# Getting Started

SIRIUS suggests professional installation of this product in your vehicle. Professional installation provides an experienced technician to install this product in your vehicle, advice for selecting a suitable mounting location, installation of the antenna, and routing all the necessary wires and cables. If the FM reception within your vehicle proves to be poor, an installer will have the necessary accessories to install an optional FM relay switch, or an audio cable to connect the audio output of the Sirius S50 directly to your vehicle's audio system. Ask your SIRIUS retailer if they provide professional installation services, or can recommend a professional installation service.

## Installing the Car Dock

When installing the dock in your vehicle, choose a location in your vehicle where the unit will not block your vision, interfere with the vehicle controls, or obstruct the air bag. The location should be easily accessible and provide good visibility of the display, and should not be located where it will be in direct sunlight which will affect the visibility of the display screen.

The mounting accessories necessary to install the dock in a vehicle are provided. Figures 1 & 2 show several examples of the Sirius S50 mounted in a vehicle: **A** is the console front mount method using the adhesive mount, **B** is the console side mount method using the adhesive mount, and **C** is the vent mount method using the vent mount clip.

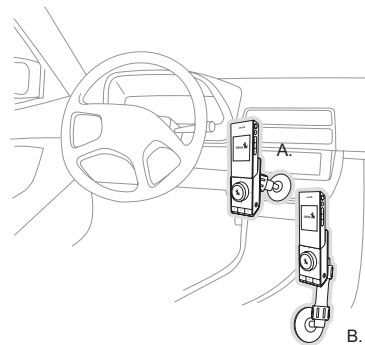

Figure 1

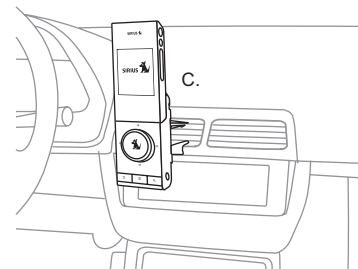

Figure 2

Depending upon the mounting location you select in your vehicle, console front mount, console side mount, or vent mount, the mount should be assembled as described in the following three sections. Each type of mount should only be installed as depicted, i.e., the console side mount method should only be used when installing to the side of the console, etc.

### Console Front Mount Method (A)

To mount the car dock using the console front mount method, assemble the mount as follows, as shown in Figure 3:

1. Attach the adhesive foot to the mounting bracket, placing a collar in the bracket before screwing the foot to the arm. The side of the collar with the hole should face the foot.
2. Attach the car dock to the mounting bracket using the provided screws.
3. Before adhering the mount to the side of the console, be sure to select your mounting position carefully because once the mount has been adhered to a surface, it will not be possible to remove it and adhere it again.
4. Clean the selected mounting surface area in the vehicle with the alcohol swab.
5. Unscrew the adhesive foot from the mount. Peel the protective material off the adhesive on the foot and press the foot firmly against the vehicle surface.
6. The adhesive mount should then be allowed to adhere for a minimum of 2-4 hours before use. Best adhesion occurs after 24 hours. When the adhesive foot has achieved sufficient adhesion, reattach the remainder of the mount to the foot.

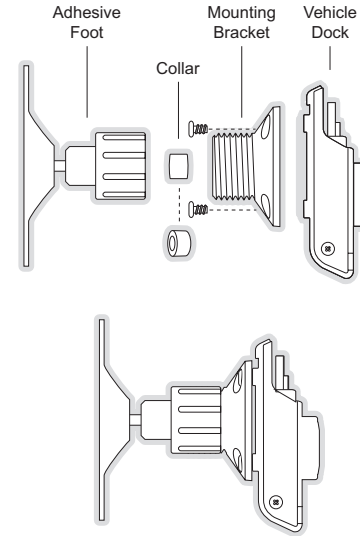

Figure 3

### Console Side Mount Method (B)

To mount the car dock using the console side mount method, assemble the mount as follows, as shown in Figure 4:

1. Attach the adhesive foot to the extension arm, placing a collar in the arm before screwing the foot to the arm. The side of the collar with the hole should face the foot.
2. Attaching the mounting bracket to the extension arm, placing a collar into the arm before screwing the bracket to the arm. The side of the collar with the hole should face the bracket.
3. Attach the car dock to the mounting bracket using the provided screws.
4. Before adhering the mount to the side of the console, be sure to select your mounting position carefully because once the mount has been adhered to a surface, it will not be possible to remove it and adhere it again.
5. Clean the selected mounting surface area in the vehicle with the alcohol swab.
6. Unscrew the adhesive foot from the mount. Peel the protective material off the adhesive on the foot and press the foot firmly against the vehicle surface.
7. The adhesive mount should then be allowed to adhere for a minimum of 2-4 hours before use. Best adhesion occurs after 24 hours. When the adhesive foot has achieved sufficient adhesion, reattach the remainder of the mount to the foot.

Note that the console side mount method should **not** be used for mounting to the dashboard of the vehicle.

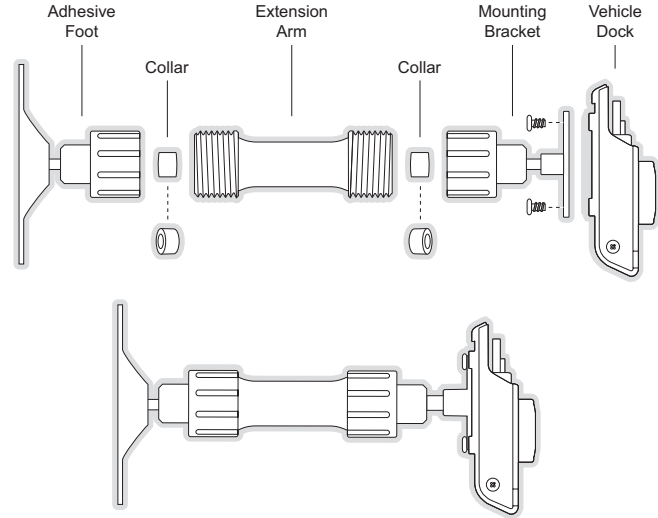

Figure 4



### Vent Mount Method (C)

When assembling the vent clip, note that the lower arm may be attached in two different positions. You should assemble the vent clip in the configuration that works best in your particular vehicle. Figure 5 illustrates both possible configurations of the vent clip.

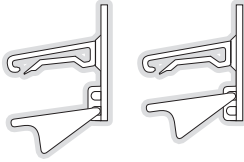

Figure 5

To mount the car dock using the vent mount method, assemble the mount as follows, as shown in Figure 6:

1. Attach the vent clip to mounting bracket 1 using the hex screws and nuts provided.
2. Attach mounting bracket 2 to mounting bracket 1, placing a collar into bracket 1 before screwing bracket 2 to bracket 1. The side of the collar with the hole should face mounting bracket 2.
3. Attach the car dock to mounting bracket 2 using the provided screws.
4. Slide the vent clip portion of the mount into a vent in your vehicle, insuring that one of the vent louvers slides between the upper and lower portions of the two clip arms, and hooks the rear of the louver.

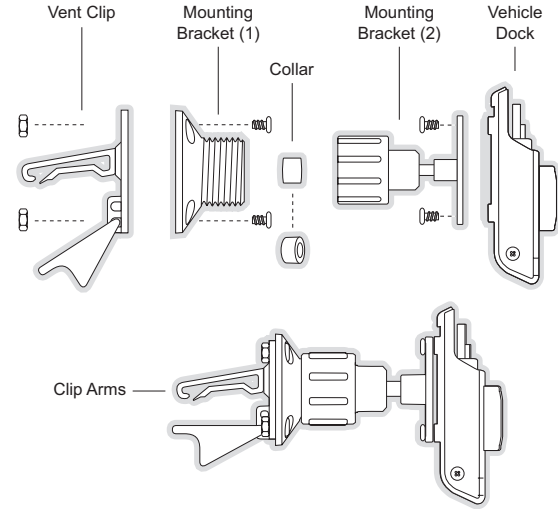

Figure 6

## Installing the Antenna

The optimum mounting location for the magnetic antenna is on the roof of the vehicle, with a minimum unobstructed area of 12 inches by 12 inches, and exactly 6½ inches from the rear roof edge of the vehicle (the length of the rubber antenna cable cover/tail). It is important to avoid any obstructions that will block the SIRIUS signal, obstructions such as a roof rack, a sunroof, roof mounted cargo containers, or other antennas. For convertible vehicles, the antenna should be installed on the trunk lid.

For best performance, it is recommended that the antenna be installed with the rubber antenna cable cover/tail. This rubber antenna cable cover/tail provides two benefits: first, it positions the antenna the recommended distance from the rear window, rear door/hatch, or trunk edge to give the antenna the best view of the sky. Secondly, it conceals and protects the exposed antenna cable. The rubber antenna cable cover/tail has adhesive strips that hold it securely in place.

The following illustrations show the recommended mounting locations of the antenna for several types of vehicles. (Figure 1) Follow these recommendations for best performance from the antenna.

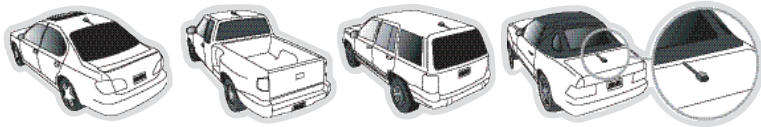

Figure 1

**Sedan/Coupe.** Mount the antenna along the rear center-line of the vehicle roof, located at the rear of the roof near the rear window.

**Pickup Truck.** Mount the antenna along the rear center-line of the cab roof, located at the rear of the roof near the rear window.

**SUV/Mini-Van.** Mount the antenna along the rear center-line of the vehicle roof, located at the rear of the roof near the rear door/hatch.

**Convertible.** Mount the antenna along the center-line of the trunk lid, with the rubber antenna cable cover/tail directed toward the rear window.

When you have selected a suitable mounting location, clean the area where the antenna and rubber antenna cable cover/tail will be mounted with the supplied alcohol swab.

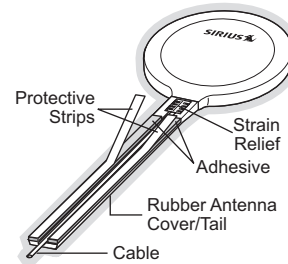

Figure 2

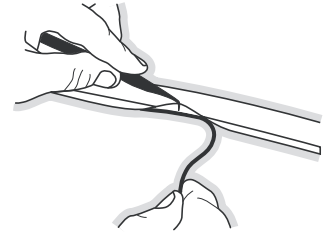

Figure 3

Connect the rubber antenna cable cover/tail to the antenna cable, making sure that the strain-relief on the antenna sits into the rubber antenna cable cover/tail groove. (Figure 2) Route the antenna cable through the wire channel in the rubber antenna cable cover/tail. Do not remove the protective strips yet.

Temporarily position the antenna and rubber antenna cable cover/tail in the selected mounting area and route the cable from the antenna to the vehicle's interior by tucking it underneath the rubber molding around rear window, as shown in Figure 3.

Route the cable from the lowest point of the rear window into the trunk. Take advantage of any existing cable channels or wiring conduits. For SUVs, mini-vans and 5-door vehicles, bring the cable into the vehicle under the rubber molding for the tailgate, and continue under the interior trim.

From the trunk, or rear of the vehicle, route the cable around the passenger compartment and to the front of the vehicle, to the receiver. Take care not pull the cable across sharp edges that could damage it, and keep it away from areas where it might entangle feet. Coil any

excess antenna cable in a location where it can be hidden.

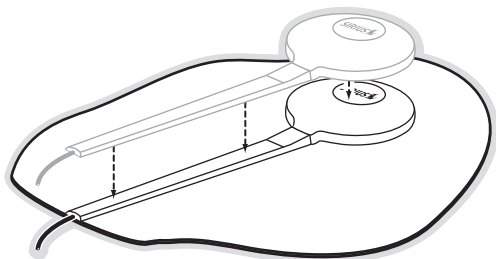

Figure 4

Once the antenna cable is routed through the vehicle, and you are satisfied with the cable routing, peel the protective material from the adhesive strips and press the rubber antenna cable cover/tail firmly into place on the vehicle. Double check that the location of the antenna and rubber antenna cable cover/tail are correct, and continue to press firmly down on rubber antenna cable cover/tail for another 30 seconds. (Figure 4) At room temperature (68 degrees), maximum adhesion usually occurs within 72 hours. During this period, avoid car washes and other contact with the antenna and rubber antenna cable cover/tail.

## Connecting the Cigarette Lighter Adapter

Connect the provided cigarette lighter adapter to the DC 5V connection at the rear of the vehicle dock. (Refer to Figure 1 on page 14 for the location of this connector.)

Do not use any other power adapter for the Sirius S50, or connect it directly to the vehicle's power. Doing so will damage the Sirius S50. Using anything other than the supplied cigarette lighter adapter to power the vehicle dock will void the warranty.

## Battery Installation, Charging, and Disposal

The SIRIUS S50 is provided with a battery which, when fully charged, will provide approximately 6 hours of listening time when listening to SIRIUS content, and will vary when listening to your audio files depending upon the encoding technique of the audio files. As batteries age, the amount of listening time diminishes and replacement (or spare) batteries are available from your SIRIUS product distributor.

The amount of listening time the battery provides is also dependent upon several factors which may be adjusted to maximize the time between charging. Decreasing the length of time the backlight of the display screen remains on will prolong battery life, as well as adjusting the brightness of the display screen to a dimmer setting. Both of these adjustments are made through the **Setup** menu. Refer to the **Brightness** section on page 85 and the **Backlight** section on page 86 for instructions on changing these settings.

### Media Player Battery Installation

To install the battery in the media player, grasp the media player in your hand as shown in Figure 1, positioning your thumb just above the head of the SIRIUS dog logo. Then press your thumb down gently on the battery cover and slide your thumb to the right to open the battery compartment. Lift and remove the cover, and remove the battery from the compartment. Discard the plastic protective material from underneath the battery, and place the battery back into the compartment. Slide the battery cover back into place.

The battery provided with the Sirius S50 is fully charged at the factory, but may require additional charging time to top off the charge.

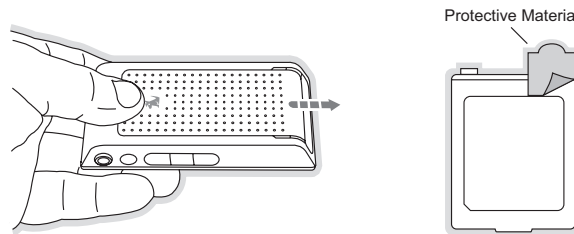

Figure 1

### Remote Control Battery Installation

To install the remote control battery, turn the remote control over and locate the battery drawer on the bottom edge. Open the battery drawer by holding the latch tab to the right and sliding the drawer out as shown in Figure 2. Place the battery in drawer with the + side of the battery facing up and slide the drawer back into the remote control.

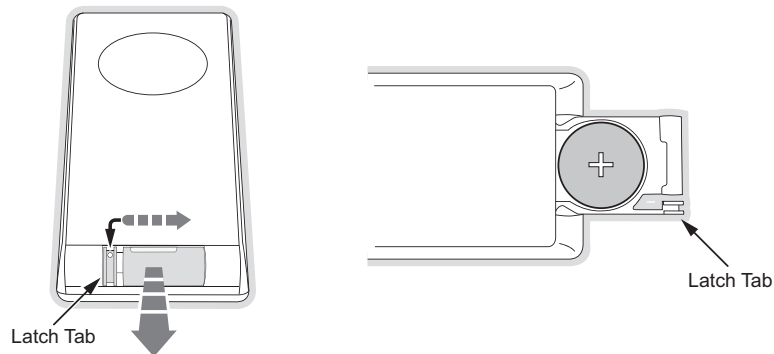

Figure 2

### Battery Charging

The battery in the Sirius S50 is shipped charged, however, it may need additional charging to obtain the maximum charge. The time necessary to charge the battery when it is fully discharged is approximately 1 to 4 hours, depending upon how it is being charged: vehicle dock, AC adapter, or computer.

The battery may be charged in several ways:

**In the vehicle dock.** The battery will be charged when the media player is in the vehicle dock and the vehicle is on.

**Using the AC adapter.** The AC adapter may be used to charge the battery when the media player is not in the dock. To use the AC adapter, connect one end of the USB cable to the AC adapter and the other end to the media player, as shown in Figure 3.

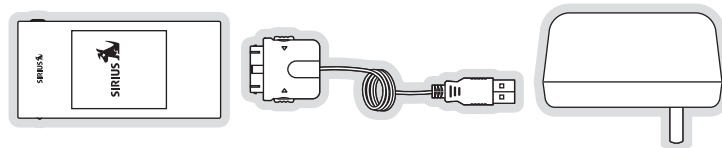

Figure 3

**When connected to a computer.** The battery will also be charged when the media player is connected to a computer using the USB cable while the computer is turned on. To connect the media player to a computer, connect one end of the USB cable to the media player and the other end to an available USB port on the computer, as shown in Figure 4.

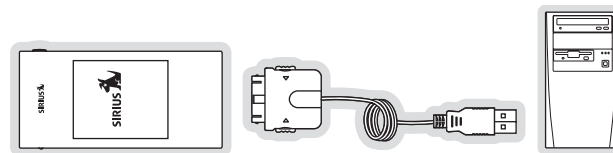

Figure 4

### Battery Disposal

When disposing of batteries, do so in accordance with the local waste disposal regulations. Generally, batteries should not be disposed of in household waste, but should instead be recycled.

## Docking and Un-Docking the Media Player

Care should be taken when docking the media player to align the media player with the dock before seating the media player. There are two posts on the dock which correspond to mounting holes in the media player, as shown in Figure 1. To dock the media player, align the posts with the mounting holes, grasp and hold the dock with your free hand, and press the media player down until it is fully seated in the dock.

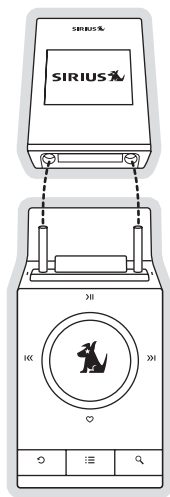





Figure 1

When removing the media player from the dock, the dock should be firmly grasped in one hand (to minimize any pulling or twisting of the mount) while pulling the media player up with your other hand.

## Turning the Sirius S50 On and Off

To turn on the Sirius S50 when in a dock, press and hold the  Playlist button on the media player. To turn it on with the remote control, press the  Power button.

To turn on the media player, press and hold the  Playlists button. Note that the  Lock button must be in the unlocked position for the media player buttons to function. (Figure 1)

Note that you should not leave the Sirius S50 turned on in your vehicle when the vehicle is not running. Doing so may result in the vehicle's battery becoming discharged.

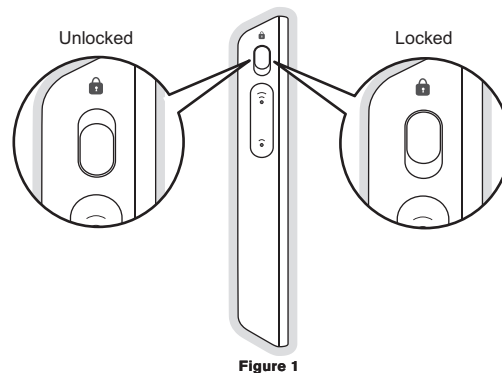







Figure 1

To turn off the Sirius S50 when in a dock, press and hold the  Playlists button on the side of the media player, or press the  Setup button on the dock and select the *Shut-Down Device* menu option. It may also be turned off by pressing the  Power button on the remote control. To turn off the media player, press and hold the  Playlists button, or press the  Setup button and select the *Shut-Down Device* menu option.

## Selecting an FM Frequency

To listen to the audio from the Sirius S50, you will need to tune the FM radio in your vehicle and the FM transmitter in the Sirius S50 to the same FM frequency. The FM transmitter in the Sirius S50 defaults to 88.1 MHz, so you can begin by tuning your vehicle's FM radio to 88.1 MHz. If there is an FM station broadcasting on that frequency, you will have to search for a different FM frequency to use, and then change the FM frequency that the Sirius S50 will use to transmit.

The FM transmitter frequency of the Sirius S50 may be changed using the **⌘** Setup menu. Details for changing the FM frequency are found in the **FM Transmitter** section on page 71.

## Subscribing to the SIRIUS Service

Before you can listen to the SIRIUS service, you need to subscribe to the SIRIUS Satellite Radio service. Do the following:

1. Be sure that the Sirius S50 is correctly installed, is in the vehicle dock, and that the antenna is oriented to receive the SIRIUS signal.
2. Turn on the Sirius S50. After the startup sequence, it will update the SIRIUS channel line-up. Wait until the channel updates have completed before pressing any buttons.
3. Once the channels have been updated, the display will change to "Call 1-888-539-SIRIUS to Subscribe" and will tune to channel 184. You will not be able to listen to other channels until you activate your SIRIUS subscription.
4. Use the **0** Media Dial to tune to channel 0 to display the Sirius S50's unique 12-digit SIRIUS ID Number (SID). (Figure 1) You can also tune to channel 0 by using the remote control: Press the 0 (zero) button and then the **⌘** Select button. The SID number is also available on the Sirius S50's packaging, and may also be accessed by pressing the **⌘** Setup button and selecting *Device Settings* → *Sirius ID*. Write the SID number down in the space provided near the end of this guide.
5. Have your credit card handy and contact SIRIUS on the Internet at:  
<https://activate.siriusradio.com/>  
and follow the prompts to activate your subscription. You can also call SIRIUS toll-free at: 1-888-539-SIRIUS (1-888-539-7474).

6. When you have successfully subscribed to the SIRIUS service, and the Sirius S50 has been updated with your subscription information, an alert will be displayed. To continue, press the **⌘** Select button.

You are now ready to begin enjoying SIRIUS Satellite Radio's digital entertainment, and can tune to other channels!

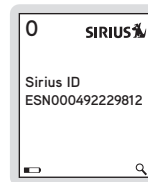

Figure 1

## Connecting the Media Player to a Computer

To connect the media player to a computer, connect one end of the USB cable to the media player and the other end to an available USB port on the computer, as shown in Figure 1. Note that the My Sirius Software should be installed before connecting the media player to your computer.

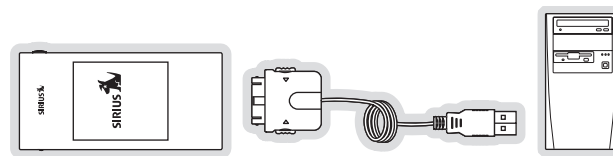

Figure 1

## Using the Media Player with the Wearable Clip

The wearable clip provides a secure way of carrying the media player. It may be clipped to a belt, pocket, or strap, etc. To attach the wearable clip to the media player, place the bottom of the media player into the bottom of the clip as shown in Figure 1, and press the top of the player into the clip until it snaps into place.

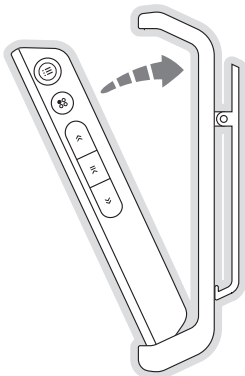





Figure 1

## Operation

### Learning the Features

The best way to learn and explore the many exciting features of the Sirius S50 is by trying it. Experience for yourself how the Sirius S50 will enhance your SIRIUS satellite radio listening pleasure! Press the buttons, turn the  Media Dial, change the settings. Find out what that  Love does, and see how easy the Sirius S50 is to use. If you change any settings you can easily reset the unit by accessing the *Reset Defaults* feature in the  Setup menu. So go ahead, take the Sirius S50 out for drive.

### Listening Environments

The Sirius S50 functions in two distinct listening environments, **Live** and **Playback**.

#### Live

In the Live environment, the Sirius S50 plays the SIRIUS channels, as they are being broadcast. To use the Live mode, the Sirius S50 must be in a dock which is connected to the antenna. The live environment allows you to browse and select the SIRIUS channels, and find information about the songs, artists, sports, news, weather, traffic, or other entertainment being broadcast. You can also save songs and shows for later playback.

While in the live environment, the broadcast to which you are listening is put into a replay buffer temporarily, up to the most recent 30-60 minutes (depending upon the content of the broadcast). At any time you may rewind to repeat something you just heard or you may press  Play/Pause to pause the live broadcast. You may resume listening to the broadcast at any time, beginning from the point where the broadcast was paused, or you can fast-forward or rewind through the replay buffer, pause the replay buffer again, or return to the live broadcast. The replay buffer is retained until the memory becomes full. When memory becomes full, the

oldest part of the replay buffer is deleted to make room for the new material so that the live broadcast can continue to be added to the replay buffer. The replay buffer is discarded when either the Sirius S50 is turned off or tuned to another channel or a playlist.

### Playback

In the playback environment, you can playback songs or shows which you have saved from live broadcasts using Love or scheduled recordings, content saved in My Sirius Channels, or songs which you have downloaded to the Sirius S50 from your PC using the My Sirius Studio software. Any combination of songs, sports, talk shows, news broadcasts, talk entertainment, etc., can be browsed in several playlists which are automatically created when songs or shows are recorded or downloaded. Songs or shows in the playlists can be played while in the dock, or taken along with you for playback when using the media player. Playlists are retained even when the Sirius S50 is turned off.

## Navigating Menus and Lists

The menu and list structures in the Sirius S50 are navigated by turning the Media Dial to scroll through a menu or list to highlight your choice, and then pressing the Select button to select the choice. When using the media player, menus and lists are navigated by pressing the Fast-Forward and Rewind buttons, and then pressing the Play/Pause button to select the choice.

Let's say you have saved the show *The Dawn and Drew Show* and now you want to listen to it. Following the concept of turning the Media Dial to highlight a choice and pressing the Select button, refer to Figure 1 (following) for an example of navigating to the show:

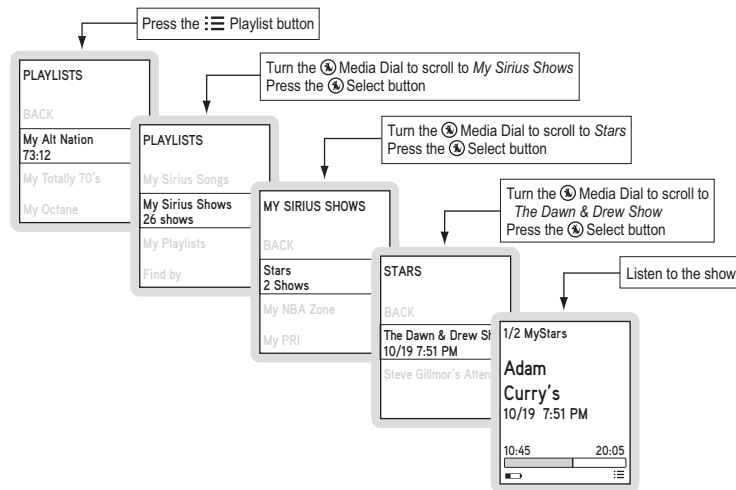

Figure 1

In this guide, menu or list structures like the previous example are shown as:

Playlist button → My Sirius Shows → Stars → The Dawn & Drew Show → Listen.

At the end of some menus or lists is the **BACK** menu item which may be selected to return back to the previous menu or list. To return to live mode from the playlist mode, press the Mode button to enter the tune, genre, or preset mode and select a channel.



## Listening to Live Broadcasts

When you are using your Sirius S50 in the live environment, there are several ways to locate and tune to the broadcast channels: by channel, by genre, and by preset. When initially turned on, the Sirius S50 is in the channel mode.

### Tuning by Channel

1. Press the Mode button and stop at the channel mode.
2. Use the Media Dial to choose to a channel. (Figure 1)
3. Press the Select button to tune to the highlighted channel.

### Tuning by Genre

1. Press the Mode button and stop at the genre mode.
2. Use the Media Dial to choose a genre. (Figure 2)
3. Press the Select button to select a genre.
4. Use the Media Dial to choose to a channel.
5. Press the Select button to tune to the highlighted channel.

### Tuning by Preset

1. Press the Mode button and stop at the preset mode.
2. Use the Media Dial to choose a preset. (Figure 3)
3. Press the Select button to tune to the highlighted preset channel.

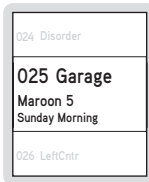

Figure 1

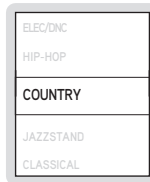

Figure 2

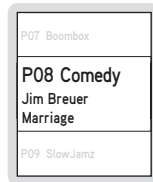

Figure 3

### Notes:

To listen to a live broadcast, the S50 must be in a dock.

## Channel Presets

The Sirius S50 can store up to 30 of your favorite channels in the preset list for fast tuning to your favorite channels.

### Adding Channel Presets

1. To add the channel to which you are listening as a preset, press and hold the Select button. (Figure 1)
2. To save the channel in the next available preset press the Select button. (Figure 2)
3. To save the channel to a different preset number, choose the desired preset number using the Media Dial to choose a preset and press the Select button.
4. If a preset already exists for the preset you have selected, select whether to replace the existing preset or insert the new preset. (Figure 3)

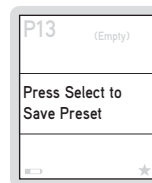

Figure 1



Figure 2



Figure 3

### Notes:

Channel presets can only be added while listening to a live broadcast.

## Removing or Moving Channel Presets

1. While listening to the channel, press and hold the **Select** button.
2. Select whether to remove or move the preset. (Figure 4)
3. If *Remove* was chosen, the preset is removed from the presets list. (Figure 5)
4. If *Move* was chosen, use the **Media Dial** to choose a new location and press the **Select** button.
  - (a) If the selected preset location is empty, the preset will then be moved to the new location.
  - (b) If the selected preset location is already used, select whether to replace the existing preset with the one being moved, or to insert the preset which will bump all the following presets back. (Figure 6)

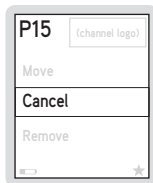

Figure 4

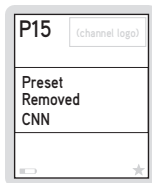

Figure 5



Figure 6

## Pausing a Live Broadcast

If you are unable to continue listening to a live broadcast but do not want to miss the broadcast, you can pause the channel for 30 to 60 minutes depending upon the content. When paused, the broadcast is put into a replay buffer.

### Pausing a Live Broadcast

1. Press **Play/Pause** to pause a live broadcast.
2. The audio will mute and a time bar will be shown near the bottom of the display screen indicating the memory capacity and how much of the replay buffer is filled with the broadcast. (Figure 1)

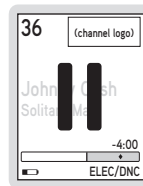

Figure 1

### Notes:

When a broadcast has been paused, the time bar will fill from the right (live broadcast) to the left, and the time display indicates how much of the broadcast is in the replay buffer. The **◆** indicator within the time bar indicates your current listening position in the replay buffer.

When the currently paused time is at the limit of the replay buffer capacity, play of the broadcast will automatically resume. The live broadcast will continue to be added to the replay buffer, overwriting the oldest portion of the broadcast in the replay buffer.

### Playing a Paused Broadcast

Press >|| Play/Pause to begin playing a paused broadcast from the point at which it was paused. (Figures 2 & 3)

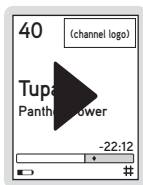

Figure 2

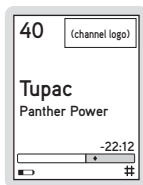

Figure 3

#### Notes:

Pressing and holding >|| Play/Pause jumps to the live broadcast.

Tuning a different channel or playback of a playlist will discard the replay buffer.

### Fast-Forwarding and Rewinding Through a Paused Broadcast

1. Pressing >>> Fast-Forward and <<< Rewind navigates through the replay buffer, either by time or by segments.
2. As you fast-forward or rewind, the ♦ indicator in the time bar will move to show your current playback position relative to the live broadcast. (Figures 4 & 5)

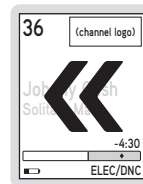

Figure 4

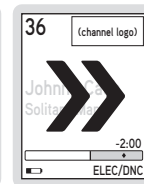



Figure 5

#### Notes:

Pressing and releasing >>> Fast-Forward and <<< Rewind moves forwards or backwards to the start of the next or previous segment and play immediately begins. (Segments are the beginning of songs or shows.) If the beginning of the replay buffer is reached playback immediately begins. If the end of the replay buffer is reached the live broadcast resumes.

Pressing and holding >>> Fast-Forward and <<< Rewind for one second moves forward or backwards in 10 second intervals, which increases to 30 and then 60 second intervals the longer the button remains pressed. Play begins immediately when the button is released or the beginning of the replay buffer is reached. If the end of the replay buffer is reached, the live broadcast resumes.

## Saving Songs and Shows

Songs and shows can be saved by using  Love while listening to a live broadcast. The Sirius S50 will hold approximately 50 hours of SIRIUS content, saved using  Love and scheduled recordings, and includes the content automatically saved in My Sirius Channels.

As much as half of the total memory storage space (512MB) is available for MP3 or WMA files downloaded from your computer. Downloading files will reduce the amount of storage space available for SIRIUS content, however, storage space is always reserved for SIRIUS content. The encoding technique of your downloaded files will also affect the amount of files you can store, as higher quality audio formats consume greater storage space. Current memory usage may be checked by accessing *Content Management* from the  Setup menu. Refer to the **Memory Usage** section on page 81 for instructions.

### Saving a Song

1. Press  Love to begin saving the song.
2. While the song is being saved the love icon will be displayed briefly, and the heart icon in the lower right corner will be displayed until the song is saved. (Figure 1)
3. When the song is complete, it is saved in My Sirius Songs. Refer to the **Listening to Saved Songs, Shows, and MP3s** section on page 56 for information on playing back the song.

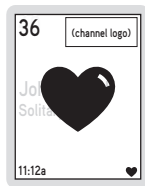

Figure 1

### Notes:

If you have tuned to a channel that is in the middle of playing a song that you want to save, you will only be able to save the song from the point at which you tuned to the channel. You

will be prompted to save or not to save the partial song.

When recording a song, it will be recorded exactly as it was broadcast.

If you attempt to tune away before the song is complete, you will be prompted to confirm that you wish to stop recording, and if you want to save or discard the partial recording. In some instances, songs are protected and cannot be saved. When this occurs, an alert will be displayed and the song will not be saved.











If you attempt to save a song, and the memory is full, a *Memory is Full* prompt will be displayed. If there are at least 10 songs in My Sirius Songs which can be deleted, Figure 2 is displayed with the following choices:

- **Don't Save.** The current song or show you are attempting to save will not be saved.
- **Make Room and Save.** The 10 songs which are least played are deleted, and the current song is saved.



Figure 2

### Saving a Show

1. Press and hold  Love to begin saving the show. The heart icon will be displayed briefly and a time bar will indicate the amount of time available for recording. (Figure 3) You will be prompted to press  Love to set the record start. (Figure 4)
2. You may use  Fast Forward and  Rewind to modify the starting point of the recording before pressing  Love. (Figure 5)
3. Press  Love to set the starting point.
4. You will be prompted to press  Love to set the end of the recording. (Figure 6) You may use  Fast Forward and  Rewind to modify the ending point of the recording before  pressing Love.
5. Press  Love to set the ending point.
6. The recording time is now set. (Figure 7) When the show completes recording, it is saved in My Sirius Shows. Refer to the *Listening to Saved Songs, Shows, and MP3s* section on page 56 for information on playing back the show.

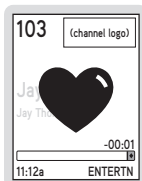

Figure 3



Figure 4

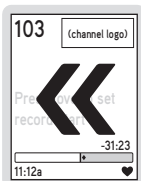

Figure 5

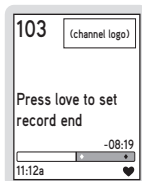

Figure 6

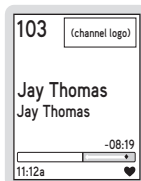



Figure 7

### Notes:

Recordings made using  Love are limited to a maximum of 1 hour each.

You may only rewind the starting point for approximately 30 to 60 minutes (depending upon the content of the show), or to the point at which the channel was tuned.

If you attempt to tune to another channel before the recording is complete, you will be prompted to confirm that you wish to stop recording, and if you wish to save the partial recording.

In some instances, shows are protected and cannot be saved. When this occurs, an alert will be displayed and the show will not be saved.

If you attempt to save a show, and the memory is full, a *Memory is Full* prompt will be displayed. Refer to the notes in the previous section on page 52 for information concerning the *Memory is Full* prompt.

### Downloading Audio Files

In addition to saving songs and shows from the live broadcast, you can also download MP3 and WMA format audio files using the My Sirius Studio software included with the Sirius S50. Refer to the manual on the software CD for more information and instructions on how to download and manage audio files.

## Listening to Saved Songs, Shows, and MP3s

The playback environment allows you to listen to songs, shows, and MP3s which has been saved in the Sirius S50. In addition, you can also listen to songs and/or comedy from your three most listened to music or comedy channels which the Sirius S50 has automatically saved for you.

In the playback environment, the playlists are arranged into several categories: My Sirius Channels, My Sirius Songs, My Sirius Shows, and My Playlists.

- **My Sirius Channels.** My Sirius Channels consists of three playlists which are automatically created and contain songs or comedy from the three music and/or comedy channels to which you listen the most. Content from these channels are stored in playlists named after the channel names, for example, My Octane, My Bluegrass, My Hip-Hop Nation, etc.
- **My Sirius Songs.** This playlist contains individual songs which you have saved from music broadcast channels and from My Sirius Channels, except if they have been saved using the scheduled recording feature. (All songs saved using the scheduled recording feature are saved in the My Sirius Shows.) Songs and sets are automatically grouped by genres within My Sirius Songs for easy browsing.
- **My Sirius Shows.** This playlist contains shows, news, sports, etc., and scheduled recordings which you have saved from broadcast channels. They are automatically grouped by sub-categories within My Sirius Shows which are named after the channel from which they are saved, such as My NPR Now, My Talk Left, My Maxim, etc. Sports games are saved in sub-categories named My NBA Zone, My NHL Zone, etc.
- **My Playlists.** This playlist contains audio files (MP3 and WMA format) which you have downloaded from your PC using the My Sirius Studio software. You may design this category in any way you wish, using the software application.

While listening, you may use **>>>** Fast-Forward, **⏮** Rewind, and **>||** Play/Pause to navigate through the song or show. The following table describes their actions:

	Press and Release	Press and Hold
Fast-Forward/ Rewind	Begins playing the next/previous song/show in the playlist	Fast-Forwards/Rewinds the song/show currently playing
Play/Pause	Pauses or plays the song/show currently selected	When in the dock, pauses or plays the song/show currently selected

### Playing Songs from My Sirius Songs

1. Press the **≡** Playlists button.
2. Select *My Sirius Songs* → Select a genre (or *Shuffle* or *All Songs*) → Select a song (or *Shuffle*). (Figure 1)

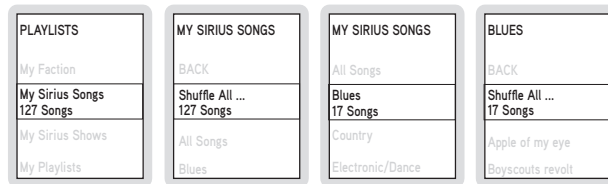

Figure 1

### Notes:

Press and hold **>||** Play/Pause to shuffle the playlist currently highlighted, or press **>>>** Play/Pause to begin playing with the song currently highlighted.

### Playing Shows from My Sirius Shows

1. Press the ☰ Playlists button.
2. Select *My Sirius Shows* → Select a channel playlist → Select a show. (Figure 2)

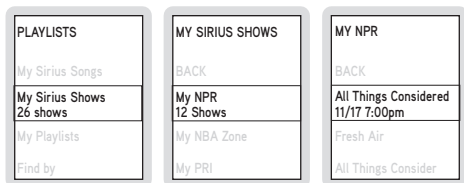

Figure 2

### Playing Songs from the My Sirius Channels Playlists

1. Press the ☰ Playlists button.
2. Select a My Sirius Channels playlist. (Figure 3)



Figure 3

### Playing Audio Files from My Playlists

1. Press the ☰ Playlists button.
2. Select *My Playlists* → Select a Playlist → Select an audio file (or *Shuffle*). (Figure 4)

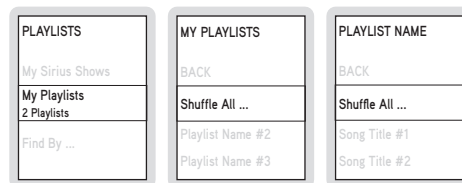

Figure 4

### Finding Songs, Shows, and Audio Files in Playlists

You can find songs, shows, and audio files (except in My Sirius Channels) by using the *Find by ...* playlist menu option. Find by... will create lists of the artists, song titles, show names, and genres found within the playlists.

1. Press the ☰ Playlists button.
2. Select *Find by ...* → Select *Artist*, *Song Title*, *Show Name*, or *Genre* → (Figure 5)
  - Artist: Select an artist → Select a song (or *Shuffle*).
  - Song Title: Select a song (or *Shuffle*).
  - Show Name: Select a show (or *Shuffle*).
  - Genre: Select a genre → Select a song (or *Shuffle*).

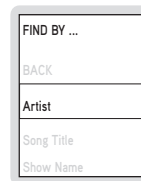

Figure 5

## Deleting Songs or Shows from My Sirius Songs, My Sirius Shows, and My Playlists

Songs and shows are deleted using the *Delete Content* menu option from the *Content Management* menu in **88** Setup to delete content.

1. Press **⏪** Setup button.
2. Select *Content Management* → *Delete Content* → Select the playlist from which to delete content (Figure 6) →  
→ When *My Sirius Songs* is selected (Figure 7), the following delete options are displayed:
  - By Least Played.** Songs are listed in order by least played to most played.
  - By Artist.** Songs are listed alphabetically by artist.
  - By Title.** Songs are listed alphabetically by title.
  - Delete All.** Deletes all songs in the playlist.
- When *My Sirius Shows* is selected (Figure 8), the following delete options are displayed:
  - By Most Played.** Shows are listed in order by most played to least played.
  - By Date.** Shows are listed chronologically from the oldest recording date to the newest recording date.
  - By Channel.** Shows are listed in ascending order by channel number.
  - Delete All.** Deletes all shows in the playlist.
- When *My MP3/WMA* is selected, the following delete options are displayed:
  - Audio files are listed and may be individually selected and deleted.
  - Delete All.** Deletes all audio files in the playlist.

You can delete songs or shows by selecting them in the various lists. Repeat this process until you have completed deleting songs and shows.

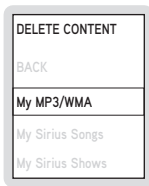

Figure 6

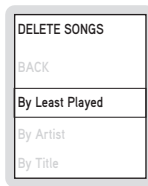

Figure 7

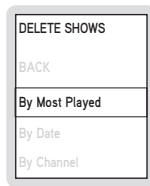

Figure 8

## Saving Songs or Shows with a Scheduled Recording

A scheduled recording is a recording session that you program to begin at a future time and day to record a live broadcast.

### Schedule, Edit, or Delete a Program for Scheduled Recordings

1. Press the **88** Setup button.
2. Select *Content Management* → *Schedule Recordings* →
  - If you are creating a new program: Select *New Program*. (Figure 1)
  - If you are editing an existing program: Select the program you wish to edit → Select *Edit Program*. (Figure 2)
  - If you are deleting an existing program: Select the program you wish to delete → Select *Delete Program*. (Figure 2) The program will be deleted and you will be returned to the *Schedule Recordings* screen. (Figure 1)
3. The *New Program* screen will be displayed (Figure 3). Use the **⏪** Media Dial to change an entry, and press the **⏩** Select button to set the entry and move to the next entry. To return to a previous entry use the **⏪** Back button. Refer to the table following for an explanation of each entry.
4. When you have pressed the **⏩** Select button at the last entry, the new program will be saved. If it conflicts with an existing scheduled recording, you will be prompted to keep the new program and replace the conflicting one, or delete the new program. (Figure 4)

New Program Entry Field Descriptions	
<b>Channel</b>	This entry specifies the SIRIUS channel you wish to record. The default entry is the current channel.
<b>Date</b>	This entry specifies the date the scheduled recording should begin. The default entry is the current date.
<b>Time</b>	This entry specifies the time of day the scheduled recording should begin. The default entry is the current time.
<b>Duration</b>	This entry specifies the length of time to record. The default entry is one hour.



### New Program Entry Field Descriptions *Continued*

#### Frequency

This entry specifies how often the scheduled recording should take place. The default entry is Once. Options for frequency are:

- **Once.** The scheduled recording will take place only one time on the specified date and time, and will not repeat.
- **Daily.** The scheduled recording will take place daily, beginning on the date specified and continuing every day of the week at specified time.
- **M–F.** The scheduled recording will take place every Monday, Tuesday, Wednesday, Thursday, and Friday at the specified time. Saturday and Sunday are not included in the schedule.
- **Weekly.** The scheduled recording will take place once a week beginning on the day of the week specified by the date, at the specified time.

Scheduled recordings are automatically performed without any intervention, however, the Sirius S50 must be docked, connected to a power source, connected to the antenna and receiving a good signal.

If the Sirius S50 is turned off at the time of a scheduled recording, it will wake up and perform the recording session only if it has external power from the home dock. Scheduled recordings will only occur in the vehicle dock if the Sirius S50 is on at the time of the recording.

If you are using the Sirius S50 at the time a scheduled recording is set to begin, you will receive a prompt to either *Go* and perform the scheduled recording, or to *Ignore* and not perform the scheduled recording. If you do not respond to the prompt, the scheduled recording will be performed. (Figure 5)

If you attempt to tune away before a recording session is complete, you will be prompted to confirm that you wish to stop recording. You will have the choice to save the recording up to the point where it was interrupted, or to discard it.

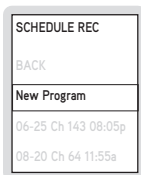

Figure 1

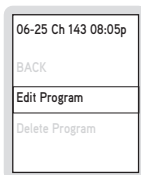

Figure 2

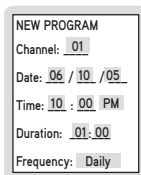

Figure 3

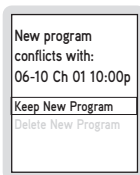

Figure 4

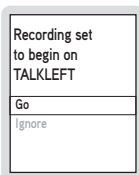

Figure 5

#### Notes:

Scheduled recordings are limited to a maximum of 20, with a maximum of 2 hours per each recording session. If you attempt to schedule more than 20 recordings, you will be prompted to delete an existing scheduled recording or to discard the new recording schedule. All recordings are saved to My Sirius Shows.

## Game Alert

You can program the Sirius S50 to remember your favorite sports teams. The Sirius S50 will then automatically alert you when any of your favorite sports teams are playing in a game.

### Adding and Removing Favorite Teams for Game Alerts

1. Press the **Setup** button.
2. Select *Sport Settings* → *Favorite Teams* → Select the sports league or college for the team you want to add/remove (Figure 1) →  
→ To add teams for game alerts: Select an individual team (or select *All...*). (Figure 2)  
Selected teams will appear in the list with a ★ star beside the team name. (Figure 3)  
→ To remove teams: Select the team you want to remove. The ★ star beside the team name will be removed indicating it is no longer selected for game alerts.
3. You may continue selecting or removing teams from other sports leagues by using the **Back** button to navigate back in the menu structure.
4. When complete, scroll to the end of the list and select *BACK*, or press the **Back** button.

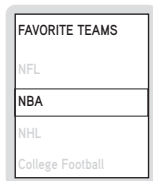

Figure 1

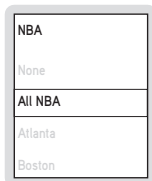

Figure 2

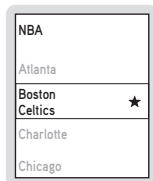

Figure 3

### Notes:

There is no limit on the number of teams you can select for game alerts.

The Sirius S50 must be docked and the dock connected to the antenna in order for the game alert feature to work.

When the Sirius S50 is turned on, a check is done to see if any of your favorite sports teams are playing. An alert will be displayed if a match is found, and selecting **Go** at the prompt will tune to the game. (Figure 4)

If one of your favorite sports teams begins playing a game while you are listening to other content you will receive an alert. (Figure 4) Pressing the **Select** button will tune to the game.

Whenever any of your favorite sports teams are playing, you can check **My Game Zone** in the genre list to see a listing of all the games scores. (Figure 5) Use the **Media Dial** to scroll through the current scores of all the teams. Selecting a game from the list will tune to the channel where the game is being broadcast.

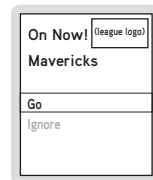

Figure 4

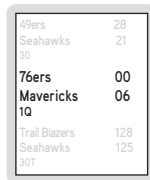

Figure 5

## Sports Ticker

When you are listening to the Sirius S50, you can have a sports ticker displayed which will show the scores of all your favorite teams which are currently playing. (Figure 1) While the sports ticker is displayed, one line of the song/show title is also displayed.

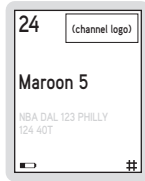

Figure 1

### Notes:

The Sirius S50 must be docked and the dock connected to the antenna in order for the sports ticker feature to work.

The sports ticker is not displayed if you are listening to a playlist.

## Parental Controls

The parental controls feature sets a password for access to specific channels or playlists. Locked channels and playlists are visible when browsing lists, and display a lock icon next to the name.

When you attempt to access a locked channel or playlist, you will be prompted to enter your password before you can proceed. (Figure 1)



Figure 1

### Enabling or Disabling Locks

1. Press the **⌘** Setup button.
2. Select *Parental Controls* → *Locks Enabled* or *Locks Disabled/Enabled*. (Figure 2)
3. (a) If the locks are enabled, you will be prompted to enter your password. Use **⏩** Fast-Forward and **⏮** Rewind to enter each digit of the password and press the **⏹** Select button. (Figure 3)  
(b) When you are enabling locks, you will be prompted to create a password. Use **⏩** Fast-Forward and **⏮** Rewind to enter each digit (0–9) of the password and press the **⏹** Select button. (Figure 3)  
You will be then be prompted to confirm the password you just entered. (Figure 4)
4. When you have entered the password, the locks will be enabled or disabled according to your choice.

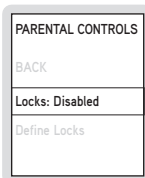

Figure 2

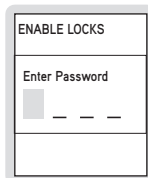

Figure 3

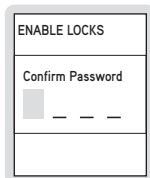

Figure 4

### Notes:

The lock feature requires you to set a password. Once a password has been set, it is important to remember your password as it cannot be reset or erased by using the *Reset Defaults* feature of the Sirius S50 except by entering the password. This prevents circumvention of the lock. If you have forgotten your password, call SIRIUS Customer Service for assistance.

### Locking and Unlocking Channels and Playlists

In order for the lock settings to be enforced, you must have set the locks to be enabled (previous section).

1. Press the **⌘** Setup button.
2. Select *Parental Controls* → *Define Locks*. (Figure 5)
3. You will be prompted to enter your password. Use **⏩** Fast-Forward and **⏮** Rewind to enter each digit of the password and press the **⏹** Select button. (Figure 3)
4. Select either *Lock Channels* or *Lock Playlists*. (Figure 6)
5. Select a channel or playlist to lock/unlock. (Figures 7 & 8) If you are locking a channel or playlist, a **🔒** lock icon will be displayed beside the locked channel or playlist. The **🔒** lock icon is removed if you have unlocked a channel or playlist. When unlocking channels, *Clear All Locks* may be selected to unlock all locked channels.
6. You may continue locking or unlocking channels and playlists until you have finished. Use the **⏪** Back button to exit the *Lock Channels* or *Lock Playlists* menu.

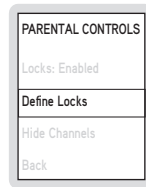

Figure 5

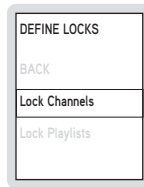

Figure 6

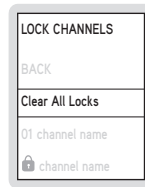

Figure 7

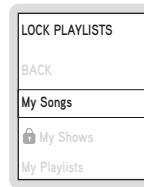

Figure 8

### Notes:

When you tune away from a locked channel or playlist, the channel or playlist will become locked again.

Locking a channel that is also a My Sirius Channel will not automatically lock the corresponding playlist. You must also lock the My Sirius Channel playlist.

## Hide Channels

The hide feature allows you to designate channels to not be displayed when browsing channel lists.

### Hiding or Showing Channels

1. Press the **Setup** button.
2. Select *Parental Controls* → *Hide Channels*. (Figure 1)
3. Select a channel to hide or show, or select *Show All* to show all hidden channels. Hidden channels will have the  hidden icon next to them. (Figure 2)
4. You may continue hiding or showing channels until you have finished. Use the **Back** button to exit the *Hide Channels* menu.

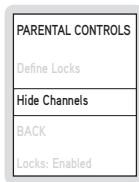

Figure 1

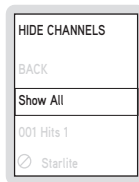

Figure 2

### Notes:

The hide feature differs from the lock feature in that a locked channel will be displayed while browsing a list (but is password protected), while a hidden channel will never appear in a list. Hidden channels are not locked, but can only be tuned by directly entering the channel number using the numeric keypad on the remote control.

## FM Transmitter

When docked in the vehicle docking station, the Sirius S50 can transmit on an FM frequency which may be received by an FM radio, such as the FM radio in your home or vehicle.

Three FM frequencies may be chosen as FM presets allowing you to quickly change the FM broadcast frequency.

### Changing an FM Preset

1. Press the **Setup** button.
2. Select *Device Settings* → *FM Frequencies* → and the FM preset you wish to change. (Figure 1)
3. Use the **Media Dial** to choose a new FM frequency. (Figure 2)
4. Press the **Select** button to set the new FM frequency.

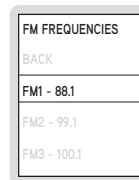

Figure 1

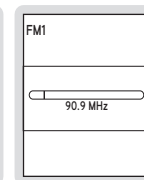

Figure 2

### Notes:

When selecting a frequency for a preset, if you scroll all the way to the left the preset is set to *None*.

### Selecting an FM Preset

1. Press and hold the **⌘** Setup button. The current FM preset frequency is displayed and highlighted. (Figure 3)
2. To tune to the next FM preset, press the **⌘** Setup button again within 10 seconds.

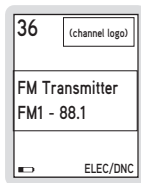

Figure 3

### Back/Jump Feature

The **↶** Back button has two main functions: To jump to a pre-programmed traffic/weather channel (or other channel), or to return back to a previous channel, song, show, menu, or list. The back or jump function is controlled by whether the button is pressed and released, or pressed and held. Both functions are described in the following table:

	Press and Release	Press and Hold
<b>Listening Live or Playback</b>	Returns to the previous content	When listening live, jumps to programmed channel: Traffic/Weather report or other channel
<b>Browsing a Menu or List</b>	Returns to previous menu or list	If in a list or in the Setup Menu, exits the list or Setup Menu

### Programming the Jump Feature

1. Press the **⌘** Setup button and select *Jump Settings*. (Figure 1)
2. To program the **↶** Back button for traffic/weather, select *Traffic/Weather* → and the city closest to your location. (Figures 2 & 3)
3. To program the **↶** Back button to a regular channel, select *JumpSet* → and the desired channel. (Figures 4 & 5)

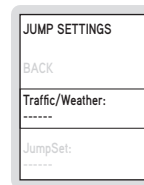

Figure 1

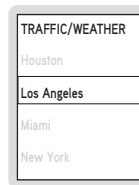

Figure 2

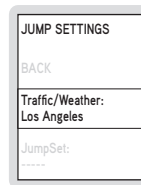

Figure 3

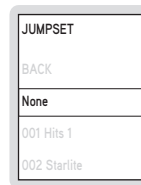

Figure 4

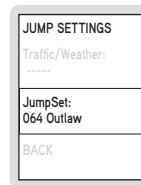

Figure 5

### Notes:

Your local traffic/weather report will be played within 4 minutes of when the **↶** Back button

is pressed. While a jump is pending, the  jump icon is displayed in the lower right corner of the display screen.

A pending jump can be cancelled by pressing the  Back button.

## Sleep Timer

The sleep timer feature will turn the Sirius S50 off after 15, 30, 45, or 60 minutes. The sleep timer function differs from the auto shutdown feature in that you may change channels, or any other activity, without interrupting the sleep timer.

### Setting the Sleep Timer

1. Press the  Setup button.
2. Select *Time Settings* → *Sleep Timer: Off* → Select an amount of time. (Figure 1)

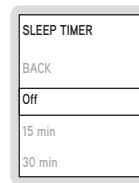

**Figure 1**

### Notes:

The Sirius S50 must be in a dock for this feature to work.

When you set a sleep time, it will only occur once. You will have to choose a new sleep time each time you use the sleep time feature.

If you are recording any songs or shows when the sleep time has been reached, the recording will be terminated when the Sirius S50 turns itself off.

## Auto Shutdown

The auto shutdown feature turns the Sirius S50 off after one hour of inactivity. This feature is only available when in the vehicle dock. Enabling this feature while using the Sirius S50 in your vehicle prevents accidental battery drainage by turning it off if you forget to do so.

### Enabling Auto Shutdown

1. Press the **⌘** Setup button.
2. Select *Time Settings* → *Auto Shutdown*.

### Notes:

If there have been no buttons pressed for one hour, the Sirius S50 will automatically turn itself off. If any buttons are pressed during the one hour shutdown period, the auto shutdown timer will be reset to one hour.

After 59 minutes of inactivity, a prompt will be displayed to cancel the auto shutdown. Pressing the **Ⓢ** Select button at the prompt will reset the auto shutdown timer to one hour.

## Auto Dimming

The auto dimming feature will automatically dim the display screen of the Sirius S50 when the ambient light becomes dark. This is useful if using the Sirius S50 at night in a vehicle.

### Enabling or Disabling Auto Dimming

1. Press the **⌘** Setup button.
2. Select *Display Settings* → *Auto-Dim: Off/On*. (Figure 1)
3. The Auto-Dim menu option toggles to turn Auto-Dim on or off.

### Adjusting the Auto Dimming Brightness

1. Press the **⌘** Setup button.
2. Select *Display Settings* → *Auto-Dim Brightness*. (Figure 2)
3. Turn the **Ⓢ** Media Dial to select the brightness level. (Figure 3)
4. Press the **Ⓢ** Select button to set the new brightness level.

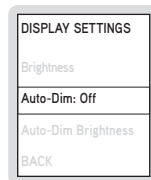

Figure 1

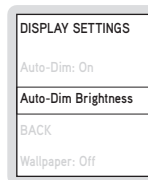

Figure 2

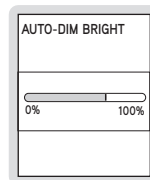

Figure 3

### Notes:

The Sirius S50 must be in a vehicle dock for the auto dimming feature to function.



# Setup Menu

## Setup Menu Navigation

When the Sirius S50 is docked, the *Setup Menu* is accessed by pressing the **⌘** Setup button on the vehicle dock. (Figure 1) Options in the setup menu are selected by highlighting the menu option using the **⌚** Media Dial and pressing the **⌚** Select button. To return to a previous menu, choose the *BACK* menu option or press the **⏪** Back button. To exit Setup, press and hold the **⏪** Back button.

When the Sirius S50 is being used as a media player, the *Setup Menu* is accessed by pressing the **⌘** Setup button on the media player. (Figure 2) Options in the setup menu are selected by highlighting the menu option using **⏭** Fast-Forward and **⏮** Rewind and pressing **⏸** Play/Pause. To return to a previous menu, choose the *BACK* menu option if available, or press the **⌘** Setup button.

Not all menu options described in this section are available from the media player. To indicate which menu options are available on the media player, each applicable section or sub-section will have an **👂** earbud icon indicating that the menu option is available on the media player. Each option in the setup menus is described in the following sub-sections, in the order in which they appear when the Sirius S50 is docked.

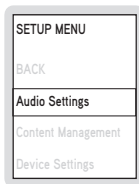

Figure 1

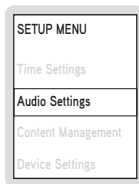

Figure 2

## Audio Settings

The *Audio Settings* menu option provides for enabling or disabling the verbal audio navigation cues, system sounds, and startup sounds, and for changing the audio output level.

### Audio Nav On/Off **👂**

Audio navigation cues are the audible voice cues which are heard when using the Sirius S50. To enable or disable the audio navigation cues, select the *Audio Nav On/Off* menu option from the *Audio Settings* menu to toggle the On/Off setting.

### System Sounds On/Off **👂**

System sounds are the beeps and other sounds which are heard when using the Sirius S50. To enable or disable the system sounds, select the *System Sounds On/Off* menu option from the *Audio Settings* menu to toggle the On/Off setting.

### Startup Sounds On/Off **👂**

Startup sounds are the sounds which are heard when the Sirius S50 is turned on. To enable or disable the system startup sounds, select the *Startup Sounds On/Off* menu option from the *Audio Settings* menu to toggle the On/Off setting.

### Audio Level

The audio level menu option changes the audio output level of the Sirius S50. To change the audio level, select the *Audio Level* menu option from the *Audio Settings* menu. Turn the **⌚** Media Dial to increase or decrease the audio level and press the **⌚** Select button to set the audio level. (Figure 1)

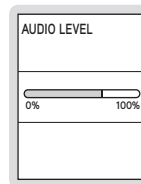

Figure 1

## Content Management

The *Content Management* menu option provides for scheduling recordings, deleting saved songs and shows from playlists, for clearing My Sirius Channels, and for checking the amount of the Sirius S50's memory currently being used.

### Schedule Recordings

Details for scheduling recordings is found in the *Saving Songs or Shows with a Scheduled Recording* section on page 61.

### Delete Content

The *Delete Content* menu option provides for deleting songs and shows from My Sirius Songs, My Sirius Shows, and My MP3/WMA (My Playlists). Details for deleting content is found in the *Deleting Songs or Shows from My Sirius Songs, My Sirius Shows, and My Playlists* on page 60.

### My Sirius Channels

The *My Sirius Channels* menu option clears all songs from a favorite channel in My Sirius Channels. If you discontinue listening to a particular channel, and want the Sirius S50 to begin saving content from another channel, select the *My Sirius Channels* menu option from the *Content Management* menu and select a favorite channel to clear. (Figure 1) Select *Yes* at the prompt to clear the channel. (Figure 2) You may also clear all My Sirius Channels by selecting the *Clear All Channels* menu option.

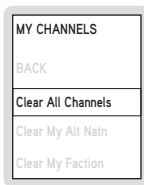

Figure 1

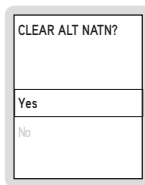

Figure 2

### Memory Usage

To check the amount of memory currently being used, select the *Memory Usage* menu option from the *Content Management* menu. The memory usage screen displays the percentage of memory currently being used. The My Sirius Channels are not included in the memory usage total. (Figure 3)

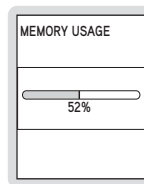

Figure 3

## Device Settings

The *Device Settings* menu option provides for turning the FM transmitter On/Off, choosing the FM preset frequencies, for displaying the antenna aiming signal strength screen, for displaying the Sirius ID (SID), and for displaying device information about the Sirius S50.

### FM Transmit On/Off

The *FM Transmit On/Off* menu option provides for turning the Sirius S50's FM transmitter On or Off. To enable or disable the FM transmitter, select the *FM Transmit On/Off* menu option from the *Device Settings* menu to toggle the On/Off setting.

### FM Frequencies

Three FM frequencies may be chosen as presets for quickly tuning the Sirius S50's FM transmitter by pressing and holding the  Setup button. Details for setting the FM presets are found in the *FM Transmitter* section on page 71.

### Battery Level

To check the battery level, select the *Battery Level* menu option from the *Device Settings* menu. The battery level screen displays the percentage of battery power remaining. (Figure 1)

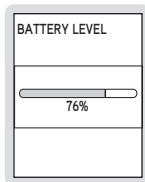

Figure 1

### Antenna Aiming

The antenna aiming display shows the strength of the SIRIUS signal being received by the Sirius S50. This is useful when installing and orienting the antenna for optimal reception of satellite signal. To display the antenna aiming information, select the *Antenna Aiming* menu option from the *Device Settings* menu.

The SATELLITE portion of the *Antenna Aiming* display screen shows the strength of the signal being received from the satellite, while the TERRESTRIAL portion of the display screen shows the strength of the signal being received from terrestrial based transmitters, if available. (Figure 2)

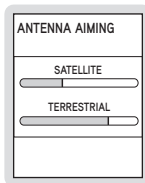

Figure 2

### Device Info

The *Device Info* menu option displays information about the model number and software and hardware version numbers of the Sirius S50. To display the device information, select the *Device Info* menu option from the *Device Settings* menu. (Figure 3)

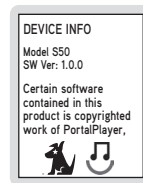

Figure 3

### Sirius ID

The Sirius ID (SID) is the unique identification number assigned to your Sirius S50. This number is used when subscribing to the Sirius Satellite Radio service. To display the SID, select the *Sirius ID* menu option from the *Device Settings* menu. (Figure 4) It is recommended that you record the SID number in the space provided near the end of this guide.

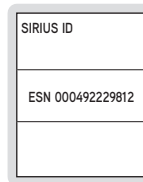

Figure 4

### Reset Defaults

The reset defaults feature sets most parameters and features of the Sirius S50 back to the defaults as manufactured from the factory. The following parameters or features are reset:

- All presets are erased
- The Sirius S50 is set to the normal tuning mode

- Wallpaper is on
- Display brightness is set to 80%
- Auto-Dim is set to off
- FM transmitter is set to on
- FM Frequency of the FM presets are set to 88.1, None, None
- Hidden channels are added back
- Favorite teams for game alerts erased
- Game alert is set to off
- Sports ticker is set to off
- Clock is set to Eastern time zone
- Clock is set to daylight savings time observed
- Auto shutdown is set to off
- Jump is set to none
- Audio navigation cues are set to on
- Startup sound is set to on
- System sounds are set to on
- Scheduled recordings are erased
- Channels locked with parental controls are unlocked
- Parental controls password is cleared

To perform a reset of the factory defaults, select the *Reset Defaults* menu option from the *Setup Menu*. At the prompt, select *Yes* to perform a factory default reset or *No* to cancel. (Figure 5) If you have set a parental control password you will be prompted to enter the password before you can proceed with the reset. Once you have performed the reset, turn the Sirius S50 off and on to allow the settings to take effect.

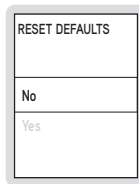

Figure 5



## Display Settings

The *Display Settings* menu option provides for turning wallpaper On/Off, for adjusting the brightness of the display screen, for adjusting the backlight of the media player, for enabling or disabling the auto-dim feature, and for setting the auto-dim brightness.

### Wallpaper On/Off

The *Wallpaper On/Off* menu option provides for turning the wallpaper displayed in the background of the screen On or Off. To enable or disable the wallpaper, select the *Wallpaper On/Off* menu option from the *Display Settings* menu to toggle the On/Off setting.

### Brightness

The brightness feature increases or decreases the brightness of the display screen. To set the brightness, select the *Brightness* menu option from the *Display Settings* menu. Turn the  Media Dial to adjust the brightness and press the  Select button to set the brightness. (Figure 1)

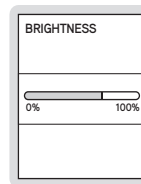

Figure 1

### Backlight (Media Player Only)

The backlight feature sets the amount of time the backlight remains on after no buttons have been pressed on the media player. The time may be set to 5, 15, 30, or 60 seconds, or *Always On* if you want the backlight to always remain on. To set the backlight, select the *Backlight* menu option from the *Display Settings* menu when using the media player. Use **>>>** Fast-Forward and **<<<** Rewind to highlight your choice and press **>||** Play/Pause to set the backlight. (Figures 2 & 3)

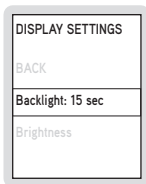

Figure 2

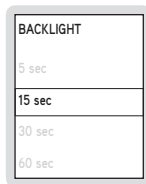

Figure 3

### Auto-Dim Off/On

The *Auto-Dim Off/On* feature turns the automatic dimming feature of the display screen in low light conditions On or Off. Details for setting auto-dim On or Off is found in the *Auto Dimming* section on page 77.

### Auto-Dim Brightness

The *Auto-Dim Brightness* menu option sets the brightness of the display screen when it is dimmed. Details for setting the auto-dim brightness is found in the *Auto Dimming* section on page 77.

## Jump Settings

The Jump Settings menu option provides for setting the jump function of the **<** Back button.

### Traffic/Weather

Details for setting the jump feature to a traffic/weather channel is found in the *Jump/Back Feature* section on page 73.

### Jumpset

Details for setting the jump feature to a channel is found in the *Jump/Back Feature* section on page 73.

## Parental Controls

The *Parental Controls* menu provides for locking channels and playlists, and for hiding channels.

### Locks Disabled/Enabled

The *Locks Enabled/Locks Disabled* menu option provides for enabling or disabling the channel and playlist locks. Details for enabling or disabling locks are found in the *Parental Controls* section on page 67.

### Define Locks

The *Set Locks* menu option provides for locking (or unlocking) channels and playlists. Details for setting locks are found in the *Parental Controls* section on page 67.

### Hide Channels

The *Hide Channels* menu option provides for hiding specific channels from channel lists, or showing channels which had previously hidden. Details for hiding/showing channels are found in the *Hide Channels* section on page 70.

## Shut-Down Device 🖱️

This option is used to turn off the Sirius S50. Select the *Shut-Down Device* menu option to turn the Sirius S50 off.

## Sport Settings

The *Sports Settings* menu option provides for choosing your favorite teams for game alerts, and also for enabling or disabling the Game Alert and Sport Ticker features.

### Favorite Teams

Details for adding favorite teams for game alerts is found in the **Game Alert** section on page 64.

### Game Alert On/Off

To enable or disable the game alert feature, select the *Game Alert On/Off* menu option in the *Sport Settings* menu to toggle the On/Off setting.

### Sport Ticker On/Off

To enable or disable the sport ticker feature, select the *Sport Ticker On/Off* menu option in the *Sport Settings* menu to toggle the On/Off setting.

## Time Settings 🖱️

The Time Settings menu option provides access to features having to do with time functions: the timezone, daylight savings time, auto shutdown, and the sleep timer. When docked, the clock in the Sirius S50 is automatically set by the satellite signal to an accurate time, and does not need to be adjusted.

### Timezone

The *Timezone* menu option provides for selecting the time zone to be used for your locale. To set the time zone, select the *Timezone* menu option from the *Time Settings* menu and select the time zone for your local area. (Figure 1)

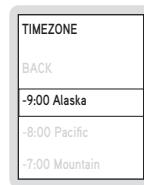

Figure 1

### DST Observed/Not Observed

The Daylight Savings Time option enables or disables the daylight savings time adjustment. To enable or disable the daylight savings time function, select the *DST Observed* (or *DST Not Observed*) menu option from the *Time Settings* menu to toggle the observed/not observed setting.

### Auto Shutdown 🖱️

The auto shutdown feature turns the Sirius S50 off after one hour of inactivity. Details for setting the auto shutdown are found in the **Auto Shutdown** section on page 76.

### Sleep Timer 🖱️

Sleep timer turns the Sirius S50 off after a specified period of time 15, 30, 45, or 60 minutes. Details for setting the sleep timer are found in the **Sleep Timer** section on page 75.

# My Sirius Studio Software Installation

The My Sirius Studio software included with your Sirius S50 allows you to connect your Sirius S50 to your PC. The software requires your computer to be using the Microsoft Windows XP or Windows 2000 operating system.

**Important:** The software must be installed *before* connecting the Sirius S50 to your computer.

The following list provides a few highlights of the capabilities of the software:

- Create playlists and download songs to the playlists.
- Streaming of SIRIUS music channels over the internet.
- Check for updates to the operating system software and download them to Sirius S50, and re-install deleted operating system files.

The following procedure will guide you through the installation of the My Sirius Studio software. If your computer does not already have Microsoft Windows Media Player® version 10 or Microsoft .NET Framework 1.1 installed, this software will also be installed during the installation process.

To install the My Sirius Studio software:

1. Place the My Sirius Studio software CD into your computer's CD-ROM drive to start the software installation.



2. If the installation does not begin automatically, double click the *SiriusStudioSetup* icon to begin the installation.



3. At the *Welcome* screen, click the *Next* button.

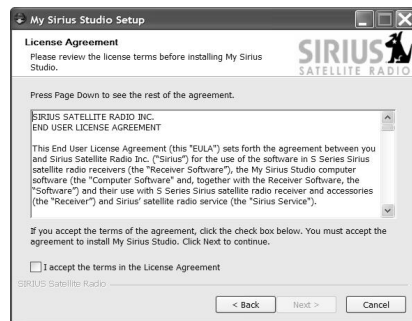

4. At the *License Agreement* screen, click the checkbox 'I accept the terms of the License Agreement' if you accept the terms of the license agreement and click the *Next* button.



5. At the *Choose Components* screen, click the *Next* button.



7. At the *Choose Start Menu Folder* screen, click the *Install* button to select the default Start Menu folder.



6. At the *Choose Install Location* screen, click the *Next* button to accept the default installation directory.





8. Wait while the installation progresses.

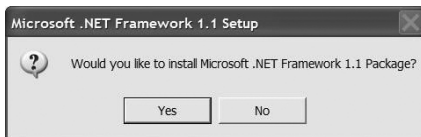

9. If the Microsoft .NET Framework software needs to be installed, the installation will begin, otherwise continue to the next step. At the *Microsoft .NET Framework Setup* screen, click the *Yes* button to install the software. If you agree, choose to accept the license agreement and complete the installation.



10. At the PortalPlayer™ *Welcome* screen, click the *Next* button. (The PortalPlayer Service Provider is a driver that ensures proper communication between the S50 and your PC.)



11. At the *License Agreement* screen, click *Yes* if you accept the license agreement.

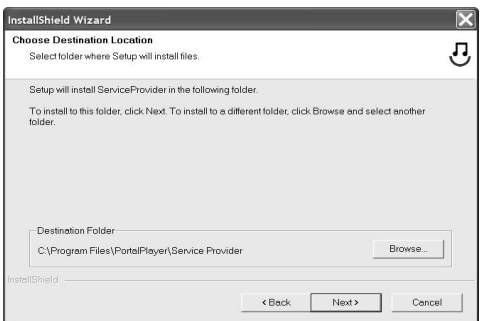

12. At the *Choose Destination Location* screen, click the *Next* button to accept the default installation directory.



13. Wait while the *Setup Status* screen is displayed for the installation to complete.



14. When the PortalPlayer software installation is complete, click the *Finish* button.



15. If Windows Media Player needs to be installed, the installation will begin next, otherwise continue to the next step.  
Complete the Windows Media Player installation before continuing the My Sirius Studio software installation. If you agree, choose to accept the license agreement, and accept the default selections presented with each installation screen.



16. When the My Sirius Studio software installation is complete, at the *My Sirius Studio Setup* screen click *Finish* to reboot your computer and finalize the installation of the software.

When the computer has rebooted, the My Sirius Studio software will be ready to use. Please refer to the user manual included on the software CD for instructions on using the software.

# Troubleshooting

Symptom	Solution
Sirius S50 does not power on	Check the battery to be sure it is installed correctly. Charge the battery. Check that the media player is properly seated in the dock. Check the cigarette lighter adapter to be sure it's seated in the cigarette lighter, and connected to the vehicle dock.
Sirius S50 displays <i>No Antenna</i>	The satellite antenna is not connected to the vehicle dock. Check the satellite antenna connection to the dock. Check that the media player is properly seated in the dock.
Sirius S50 displays: <i>No Signal</i>	No satellite signal is being received. Check that the media player is properly seated in the dock. Check for obstacles over or around the satellite antenna. Change the vehicle location to eliminate nearby obstacles (bridges, overpasses, etc.).
Audio static or loss of clarity	The FM frequency contains static. Locate a quiet FM frequency on your vehicle radio and set the FM transmitter frequency of the Sirius S50 to match. If using the Line Out audio connector, check the cable connections.

Troubleshooting <i>Continued</i>	
Symptom	Solution
No sound	<b><i>When in the vehicle dock:</i></b> Check if the FM radio is set to the wrong frequency. Tune the vehicle FM radio and the Sirius S50 to the same FM frequency. Check if the FM transmitter in the Sirius S50 is turned off. Turn the FM transmitter on. If using the Line Out audio connector, check the cable connections. <b><i>When using the media player:</i></b> Check that the ear buds are plugged into the headphone jack securely.
The Sirius S50 will not start up	The operating system files on the Sirius S50 have been deleted. Connect the Sirius S50 to your PC using the USB cable, and use the My Sirius Studio software to download new operating system files. Follow the software instructions included on the software CD.
The Sirius S50 does not respond to the Media Dial or the buttons	Remove the media player from the dock, remove the battery from the media player, wait 10 seconds, replace the battery and turn it back on.

# Optional Accessories

The following optional installation kits and replacement items are available for purchase from your SIRIUS retailer:

## Home Kit

The home dock provides full Sirius S50 functionality through your home stereo system and quick syncing with your PC. The home kit includes a home docking cradle, a USB cable, audio cables, an AC power adapter, and a windowsill antenna.

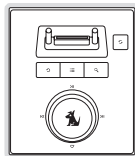

## Executive System

The executive system provides full Sirius S50 functionality in a sleek boombox style. It includes an AC power adapter and a windowsill antenna.

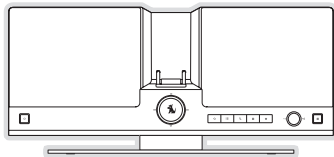

## Car Kit

Additional car docks will allow you to enjoy your Sirius S50 in other vehicles which you own. The kit includes a car dock, mounting kit, cigarette lighter adapter, and magnetic antenna.



## Battery

Replacement (or spare) battery for the Sirius S50.

## Earbuds

Replacement ear buds for the media player.

## Media Player Armband

Armband for the media player.

# Specifications

Satellite Frequencies	2322.293/2330.207 MHz
Terrestrial Frequencies	2326.250 MHz
Power Requirements	5 Volts, 1.5A Negative Ground, DC
Operation Temperature	-5° to +40° C (23° to 104° F)
Headphone Output	18mW Left + 18mW Right @ 16 ohms
Signal-to-noise (S/N)	.90dB (MP3)
Receiver Dimensions (Height x Width x Depth)	9.65 cm x 4.8 cm x 1.7 cm (3.8" x 1.89" x .67")
Media Player Weight	183g (5.9oz.)
Memory Capacity	1 GB
Antenna Type	Low Profile Magnetic
Antenna Cable Length	21' (single micro-cable)
Connector Type	SMB (right-angle)
Audio Interface	1/8" / 3.5 mm Stereo Jack
Remote Control Dimensions (Height x Width x Depth)	10.5 cm x 4.5 cm x 1 cm (4.13" x 1.77" x .39")
Remote Control Battery Requirements	CR2025

# Warranty

## 12 Month Warranty

SIRIUS Satellite Radio Inc. (the "Company") warrants to the original retail purchaser of this product that should this product or any part thereof, under normal use and conditions, be proven defective in material or workmanship within 12 months from the date of original purchase, such defect(s) will be repaired or replaced with new or reconditioned product (at the Company's option) without charge for parts and repair labor. To obtain repair or replacement within the terms of this Warranty, the product is to be delivered with proof of warranty coverage (e.g. dated bill of sale), specification of defect(s), transportation prepaid, to the location shown below under WARRANTY RETURN.

This Warranty does not extend to the elimination of externally generated static or noise, to correction of antenna problems, to costs incurred for installation, removal or reinstallation of the product, or to damage to tapes, compact discs, speakers, accessories, or vehicle electrical systems.

This Warranty does not apply to any product or part thereof which, in the opinion of the Company, has suffered or been damaged through alteration, improper installation, mishandling, misuse, neglect, accident, or by removal or defacement of the factory serial number/bar code label(s). THE EXTENT OF THE COMPANY'S LIABILITY UNDER THIS WARRANTY IS LIMITED TO THE REPAIR OR REPLACEMENT PROVIDED ABOVE AND, IN NO EVENT, SHALL THE COMPANY'S LIABILITY EXCEED THE PURCHASE PRICE PAID BY PURCHASER FOR THE PRODUCT.

This Warranty is in lieu of all other express warranties or liabilities. ANY IMPLIED WARRANTIES, INCLUDING ANY IMPLIED WARRANTY OF MERCHANTABILITY, SHALL BE LIMITED TO THE DURATION OF THIS WRITTEN WARRANTY. ANY ACTION FOR BREACH OF ANY WARRANTY HEREUNDER INCLUDING ANY IMPLIED WARRANTY OF MERCHANTABILITY MUST BE BROUGHT WITHIN A PERIOD OF 48 MONTHS FROM DATE OF ORIGINAL PURCHASE. IN NO CASE SHALL THE COMPANY BE LIABLE FOR ANY CONSEQUENTIAL OR INCIDENTAL DAMAGES FOR BREACH OF THIS OR ANY OTHER WARRANTY, EXPRESS OR IMPLIED, WHATSOEVER. No person or representative is authorized to assume for the Company any liability other than expressed herein in connection with the sale of this product. Some states do not allow limitations on how long an implied warranty lasts or the exclusion or limitation of incidental or consequential damage so the above limitations or exclusions may not apply to you. This Warranty gives you specific legal rights and you may also have other rights which vary from state to state.

**WARRANTY RETURN:** To obtain repair or replacement within the terms of this Warranty, please return product to an authorized retailer or call Customer Service at 1-800-869-5364; proof of purchase and description of defect are required. Products to be returned to an approved warranty station must be shipped freight prepaid.

# SIRIUS ID

Write down the SIRIUS ID (SID) of your Sirius S50 in the space provided below.

SID: \_\_\_\_\_

# Index

<b>A</b>	
Antenna Aiming . . . . .	82
Audio Level, Adjusting . . . . .	79
Audio Navigation	
Introduction. . . . .	23
Turning On/Off . . . . .	79
Auto Dimming	
Adjusting the Auto Dimming Brightness . . . . .	77
Enabling or Disabling Auto Dimming . . . . .	77
Auto Shutdown, Enabling . . . . .	76
<b>B</b>	
Back Button	
Back Button Function . . . . .	16, 73
Jump Feature . . . . .	73
Backlight, Adjusting (Media Player Only) . . . . .	86
Battery	
Charging, Media Player. . . . .	36
Disposal . . . . .	37
Installation, Media Player . . . . .	35
Installation, Remote Control . . . . .	36
Brightness, Adjusting . . . . .	85
Broadcasts, Pausing/Playing	
Fast-Forwarding and Rewinding a Paused Broadcast . . . . .	51
Pausing a Live Broadcast . . . . .	49
Playing a Paused Broadcast . . . . .	50
Broadcasts, Tuning	
Tuning by Channel . . . . .	46
Tuning by Genre . . . . .	46
Tuning by Preset . . . . .	46
<b>C</b>	
Channel Presets	
Channel Presets, Adding . . . . .	47
Channel Presets, Moving . . . . .	48
Channel Presets, Removing . . . . .	48
Channel Up/Down Button Function . . . . .	20
Cigarette Lighter Adapter . . . . .	6, 34
Cleaning and Maintenance . . . . .	6
Computer, Connecting to . . . . .	41
Connectors, Vehicle Dock . . . . .	17
Copyrighted Broadcast Material . . . . .	11
Customer/Product Service . . . . .	110
<b>D</b>	
Daylight Savings Time, Enabling/Disabling . . . . .	89
Deleting Songs or Shows	
Deleting Audio Files from My Playlists . . . . .	60
Deleting Shows from My Sirius Shows . . . . .	60
Deleting Songs from My Sirius Channels	
My Sirius Channels Setup Menu	
Option . . . . .	80
Deleting Songs from My Sirius Songs . . . . .	60
Device Information, Sirius S50 . . . . .	83
Display Screen Information . . . . .	21
Docking and Un-Docking the Media Player . . . . .	38
Downloading Audio Files . . . . .	55
<b>E</b>	
End User License Agreement (EULA) . . . . .	7
Error Messages . . . . . <i>See also</i> Troubleshooting	
No Antenna. . . . .	100

No Signal. . . . .	100
<b>F</b>	
Factory Defaults (Reset Defaults) . . . . .	83
Fast-Forward	
Fast-Forward Function	
Media Player . . . . .	18
Vehicle Dock & Remote . . . . .	15
How to Operate Fast-Forward . . . . .	22
Finding Songs and Shows in Playlists. . . . .	59
FM Transmitter	
Changing an FM Preset . . . . .	71
Selecting an FM Frequency . . . . .	40
Selecting an FM Preset. . . . .	72
Turning the FM Transmitter On/Off. . . . .	81
<b>G</b>	
Game Alert	
Adding/Removing Favorite Teams . . . . .	64
Turning Game Alerts On/Off . . . . .	88
<b>H</b>	
Hiding/Showing Channels . . . . .	70
<b>I</b>	
Installation	
Antenna, Installing . . . . .	32
Battery, Installing	
Media Player . . . . .	35
Remote . . . . .	36
Car Dock, Installing. . . . .	24
Cigarette Lighter Adapter, Connecting. . . . .	34
Computer, Connecting to Media Player . . . . .	41
Professional Installation . . . . .	24
Selecting an FM Frequency . . . . .	40
Subscribing to the SIRIUS Service. . . . .	40
Wearable Clip, Using. . . . .	42
Introduction to Sirius S50 . . . . .	1
<b>J</b>	
Jump Feature, Programming . . . . .	73

<b>L</b>	
Listening Environments	
Live . . . . .	43
Playback . . . . .	44
Lock Button, Media Player. . . . .	18, 39
Locks . . . . .	See Parental Controls
Love . . . . .	See also Saving Content
How to Operate Love. . . . .	22
Love Function . . . . .	15
<b>M</b>	
Media Dial	
How to Operate the Media Dial . . . . .	22
Media Dial Function . . . . .	15
Memory Usage. . . . .	52, 81
Mode Button Function . . . . .	16
Mute Button Function, Remote . . . . .	20
My Playlists . . . . .	56
Deleting Audio Files . . . . .	60
Playing Audio Files . . . . .	59
My Sirius Channels . . . . .	56
Deleting Songs. . . . .	80
Playing Songs . . . . .	58
My Sirius Shows . . . . .	56
Deleting Shows. . . . .	60
Playing Shows . . . . .	58
Saving Shows . . . . .	54
My Sirius Songs . . . . .	56
Deleting Songs. . . . .	60
Playing Songs . . . . .	57
Saving Songs. . . . .	52
My Sirius Studio Software. . . . .	See Software
<b>N</b>	
Navigating Menus and Lists . . . . .	44
<b>O</b>	
Optional Accessories . . . . .	102

<b>P</b>	
Package Contents . . . . .	12
Parental Controls	
Enabling or Disabling Locks . . . . .	68
Locking and Unlocking Channels. . . . .	69
Locking and Unlocking Playlists . . . . .	69
Parental Controls. . . . .	67
Password . . . . .	See Parental Controls
Play/Pause	
How to Operate Play/Pause . . . . .	22
Play/Pause Function	
Media Player . . . . .	18
Vehicle Dock & Remote . . . . .	15
Playlists	
Finding Songs and Shows in Playlists . . . . .	59
Navigating Playlists. . . . .	44
Playlists Button Function	
Media Player . . . . .	17
Vehicle Dock & Remote . . . . .	16
Power Button Function, Remote. . . . .	19
Presets. . . . .	See Channel Presets
<b>R</b>	
Recording . . . . .	See Scheduled Recordings;
See Saving Content	
Reference Guides	
Remote Control Reference Guide . . . . .	19
Remote Control Button Descriptions . . . . .	19
Sirius S50 Reference Guide, Buttons and	
Controls . . . . .	14
Media Player Button Descriptions . . . . .	17
Vehicle Dock Button Descriptions . . . . .	15
Rewind	
How to Operate Rewind . . . . .	22
Rewind Function	
Media Player . . . . .	18
Vehicle Dock & Remote . . . . .	15

<b>S</b>	
Safety Precautions	

General Safety Precautions . . . . .	5
Liquid Crystal Precautions . . . . .	5
Saving Content	
Saving a Show . . . . .	54
Saving a Song . . . . .	52
Saving Songs or Shows with a Scheduled	
Recording . . . . .	61
Scheduled Recordings	
Deleting a Program. . . . .	61
Editing a Program . . . . .	61
Scheduling a Program . . . . .	61
Select Button	
How to Operate the Select Button. . . . .	22
Select Button Function. . . . .	16
Setup Button Function. . . . .	See also Setup Menu
Media Player . . . . .	18
Vehicle Dock . . . . .	17
Setup Menu	
Audio Settings . . . . .	79
Audio Level . . . . .	79
Audio Nav On/Off . . . . .	79
Startup Sounds On/Off . . . . .	79
System Sounds On/Off . . . . .	79
Content Management . . . . .	80
Delete Content . . . . .	80
Memory Usage . . . . .	81
My Sirius Channels. . . . .	80
Schedule Recordings . . . . .	80
Device Settings. . . . .	81
Antenna Aiming . . . . .	82
Device Info . . . . .	83
FM Frequencies . . . . .	81
FM Transmit On/Off . . . . .	81
SIRIUS ID . . . . .	83
Display Settings . . . . .	85
Auto-Dim Brightness . . . . .	86
Auto-Dim Off/On. . . . .	86
Backlight (Media Player Only). . . . .	86
Brightness . . . . .	85



Wallpaper On/Off . . . . .	85	Sports . . . . .	<i>See also</i> Game Alert
Jump Settings . . . . .	87	Game Alert Feature. . . . .	64
Jumpset . . . . .	87	Sports Ticker Feature . . . . .	66
Traffic/Weather . . . . .	87	Sport Ticker, Turning On/Off . . . . .	88
Parental Controls. . . . .	87	Startup Sounds, Turning On/Off. . . . .	79
Define Locks . . . . .	87	Subscribing to the SIRIUS Service . . . . .	40
Hide Channels. . . . .	87	System Sounds, Turning On/Off. . . . .	79
Locks Disabled/Enabled . . . . .	87	<b>T</b>	
Reset Defaults . . . . .	83	Temperature, Operating . . . . .	6
Shut-Down Device . . . . .	88	Timezone, Setting . . . . .	89
Sport Settings . . . . .	88	Troubleshooting . . . . .	100
Favorite Teams . . . . .	88	Turning the Sirius S50 On and Off . . . . .	39
Game Alerts On/Off . . . . .	88	<b>V</b>	
Sport Ticker On/Off . . . . .	88	Volume Control . . . . .	18
Time Settings. . . . .	89	<b>W</b>	
Auto Shutdown . . . . .	89	Wallpaper, Turning On/Off . . . . .	85
Sleep Timer. . . . .	89	Warnings	
Timezone. . . . .	89	Canadian Compliance . . . . .	5
Setup Menu Navigation . . . . .	78	Cigarette Lighter Adapter . . . . .	6
SIRIUS ID . . . . .	83	FCC Compliance . . . . .	4
Record of the Sirius S50 SIRIUS ID . . . . .	106	FCC Warning. . . . .	4
Sleep Timer, Setting. . . . .	75	Warranty. . . . .	105
Software, My Sirius Studio		Wearable Clip, Using . . . . .	42
My Sirius Studio Software . . . . .	6		
My Sirius Studio Software Installation . . . . .	90		
Specifications . . . . .	104		



**SIRIUS Customer Service:** 1-888-539-7474  
**Sirius S50 Product Support:** 1-800-869-5364  
 customercare@sirius-radio.com

**SIRIUS Satellite Radio Inc.**  
 1221 Avenue of the Americas  
 New York, NY 10020  
 1-888-539-7474  
<http://www.sirius.com>



# USER MANUAL

---

**Sirius-S50** PERSONAL SATELLITE RADIO + CAR KIT

---