

SERVICE MANUAL

KING SERIES

ASH-09AK, ASH-13AK



1 Summary and features



09/13 Outdoor unit:



Model	Remarks
ASH-09AK ASH-13AK	1Ph 220~240V 50Hz R410a

2 Technical specifications

Model	ASH-09AK		ASH-13AK	
Function	COOLING	HEATING	COOLING	HEATING
Rated Voltage	220-240V		220-240V	
Rated Frequency	50Hz		50Hz	
Total Capacity (W/Btu/h)	2650 /9050	2850/ 9730	3516/12000	4015/13700
Power Input (W)	820	785	1080	1104
Rated Input (W)	1110	1150	1500	1500
Rated Current (A)	5.69	5.9	7.6	7.6
Air Flow Volume (m3/h) (H/ML)**	500		580	
Dehumidifying Volume (l/h)	1		1	
EER / C.O.P (W/W)	3.21/3.61		3.26/3.64	
Energy Class	A		A	
Indoor unit	Model of Indoor Unit	ASH-09AK		ASH-13AK
	Fan Motor Speed (r/min) (H/ML)	Cool:ing 1160/1065/959/861 Heating: 1160/1067/960/860		Cool:ing 1120/1010/890/760 Heating: 1120/1010/900/780
	Output of Fan Motor (w)			9
	Input of Heater (w)	/		/
	Fan Motor Capacitor (uF)	1		1
	Fan Motor RLA(A)	0.263		0.254
	Fan Type-Piece	Cross flow fan – 1		Cross flow fan – 1
	Diameter-Length (mm)	97		φ99*644
	Evaporator	Aluminum fin-copper tube		Aluminum fin-copper tube
	Pipe Diameter (mm)	7		7
	Row-Fin Gap(mm)	2-1.6		2-1.5
	Coil length (l) x height (H) x coil width (L)	576X142X145		656 x 25.4 x 304.8
	Swing Motor Model	MP28EC		MP24AA
	Output of Swing Motor (W)	2		1.5
	Fuse (A)	3.15		PCB 3.15A
	Sound Pressure Level dB (A) (H/ML)	40/38/36/34		41/39/36/32
	Sound Power Level dB (A) (H/ML)***	50/48/46/44		51/49/46/42
	Dimension (W/H/D) (mm)	740 x 250 x 180		805 x 280 x 215
	Dimension of Package(W/H/D)(mm)	790 x 320 x 264		860 x 355 x 280
	Net Weight /Gross Weight (kg)	8/10		9/12

Outdoor unit	Model of Outdoor Unit		ASH-09AK	ASH-13AK
	Compressor Manufacturer/trademark		HIGHLY	Gree
	Compressor Model		ASG102CV-B7AT	QXA-133uB030
	Compressor Type		Rotary	Rotary
	L.R.A. (A)		18A	32
	Compressor RLA(A)		4.05	5.1
	Compressor Power Input(W)		875	1160
	Overload Protector		KA-172-LYGN914	B250-150-141E
	Throttling Method		Capillary	
	Starting Method		Capacitor	
	Working Temp Range (°C)		-5~43	-15~46
	Condenser		Aluminum fin-copper tube	
	Pipe Diameter (mm)		7	7
	Rows-Fin Gap(mm)		1-1.6	2-1.4
	Coil length(l) x height(H) x coil width(L)		608X495X205	731X495X25.4
	Fan Motor Speed (rpm) (H/ML)		830	850
	Output of Fan Motor (W)		30W	30
	Fan Motor RLA(A)		0.345	0.35
	Fan Motor Capacitor (uF)		2	2
	Air Flow Volume of Outdoor Unit		1400	1700
	Fan Type-Piece		Axial fan -1	Axial fan -1
	Fan Diameter (mm)		400	400
	Defrosting Method		Auto defrost	Auto defrost
	Climate Type		T1	T1
	Isolation		I	I
	Moisture Protection		IP24	IP24
	Permissible Excessive Operating Pressure for the Discharge Side(MPa)		3	3.8
	Permissible Excessive Operating Pressure for the Suction Side(MPa)		1	1.2
Sound Pressure Level dB (A) (H/ML)		52	52	
Sound Power Level dB (A) (H/ML)		62	62	
Dimension (W/H/D) (mm)		848X540X320	848X540X320	
Dimension of Package (L/W/H)(mm)		878X590X360	878X590X360	
Net Weight/Gross Weight (kg)		35/40	40/44	
Refrigerant Charge (kg)		R410A/0.75	R410A/1.10	
Connecti on Pipe	Length (m)		5	5
	Gas additional charge(g/m)		25	25
	Outer Diameter	Liquid Pipe (mm)	Φ6(1/4")	Φ6(1/4")
		Gas Pipe (mm)	Φ9.52(3/8")	Φ12(1/2")
	Max Distance	Height (m)	10	10
Length (m)		15	15	

The above data is subject to change without notice. Please refer to the nameplate of the unit.

3 Part name

Indoor unit

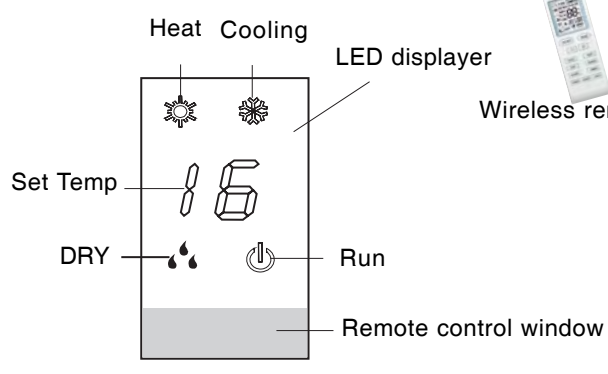
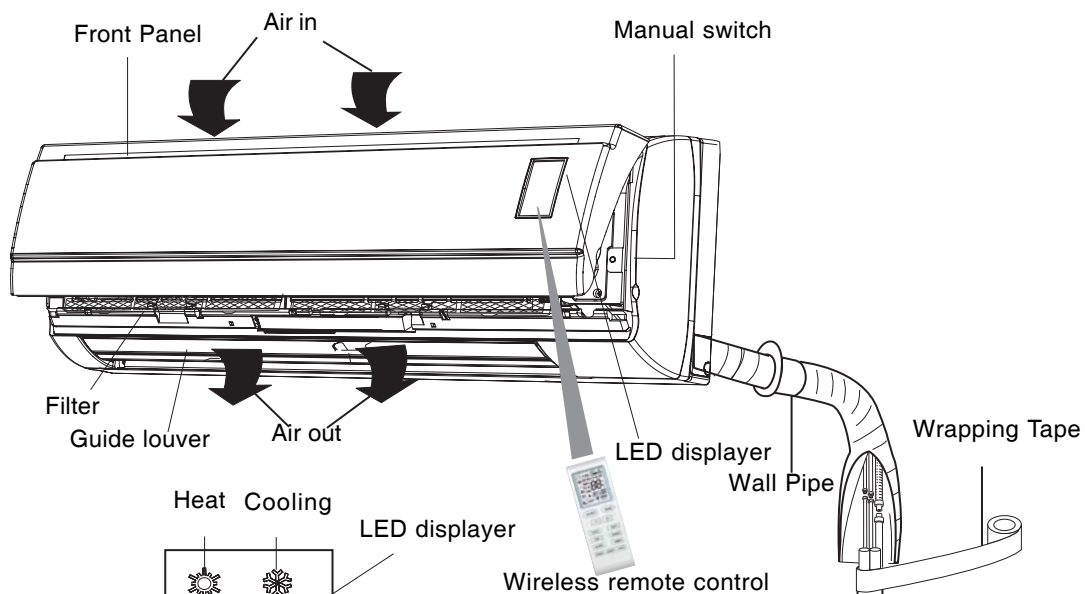

Outdoor unit

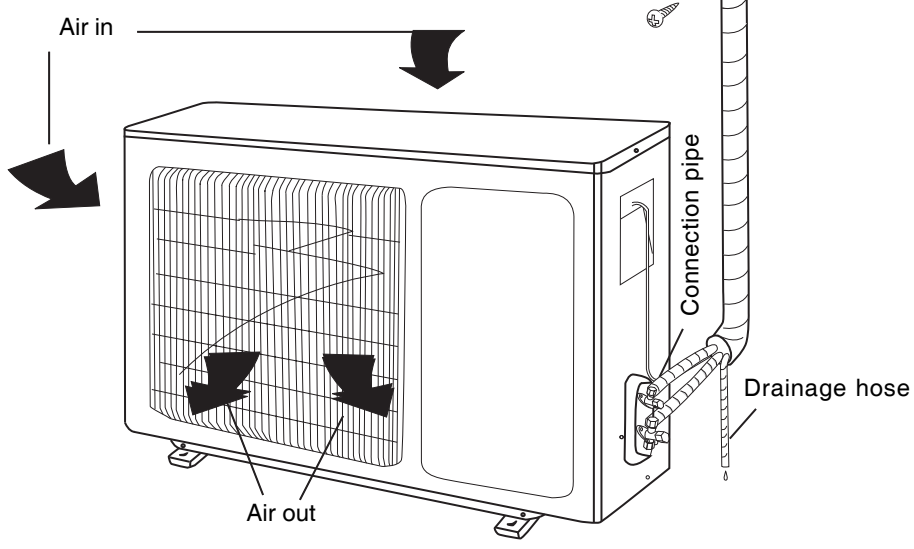

4 Outline and installation dimension

4.1 Outline and installation dimensions of indoor unit

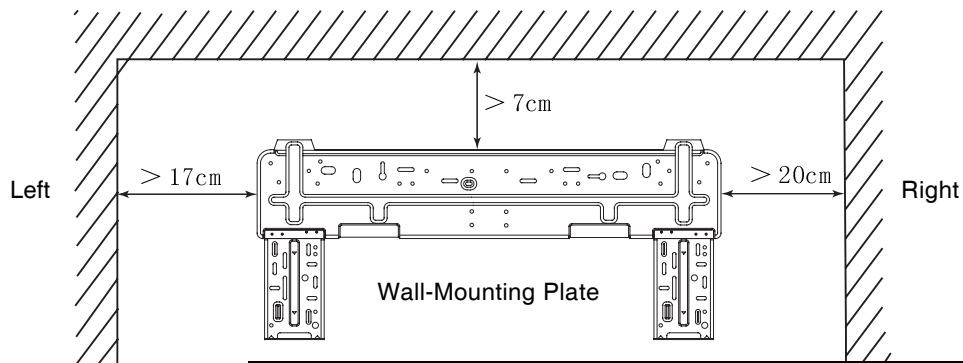
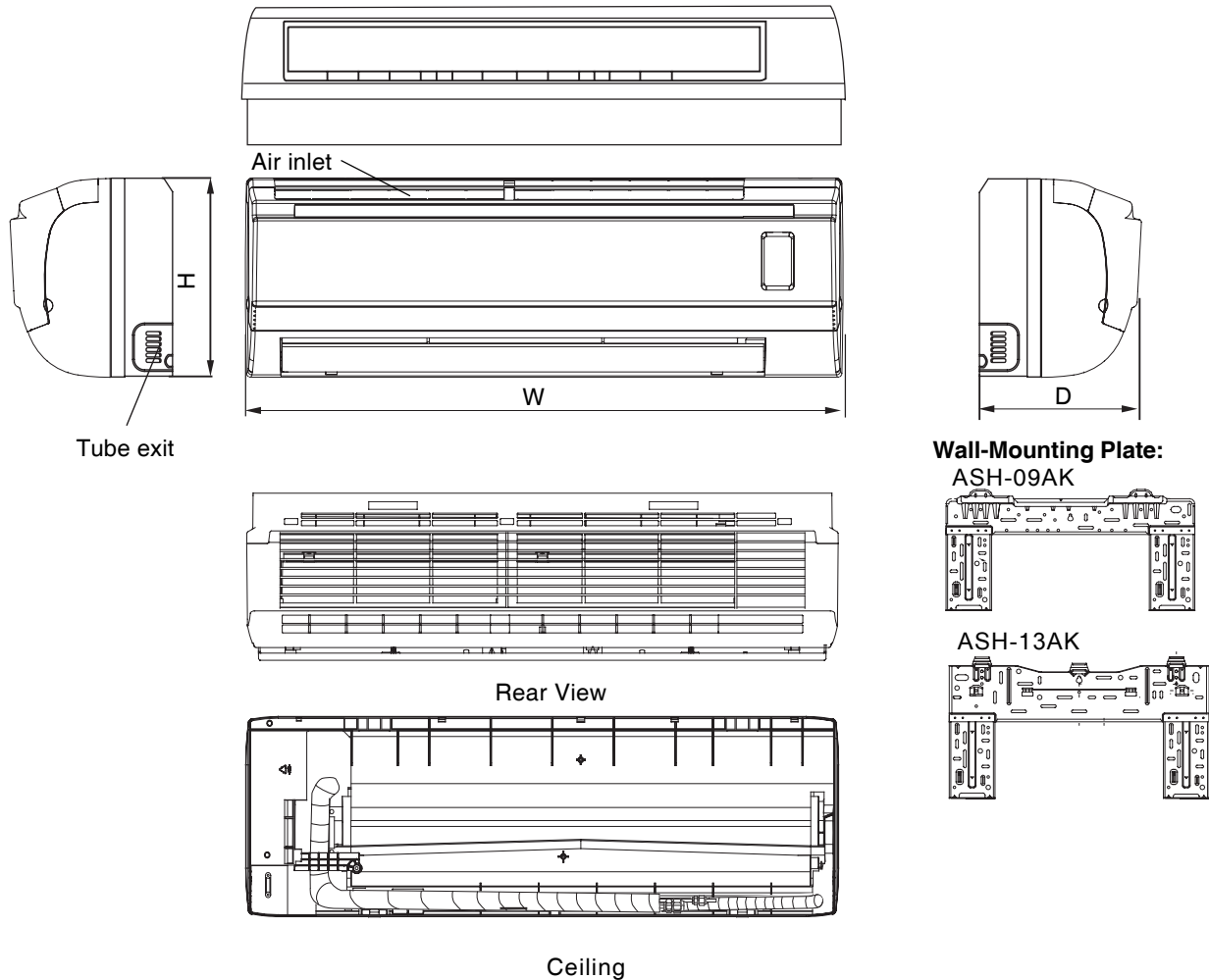

Model	W(mm)	H(mm)	D(mm)
ASH-09AK	740	250	180
ASH-13AK	805	280	215

4. 2 Outline and installation dimensions of outdoor unit

ASH-09AK, ASH-13AK

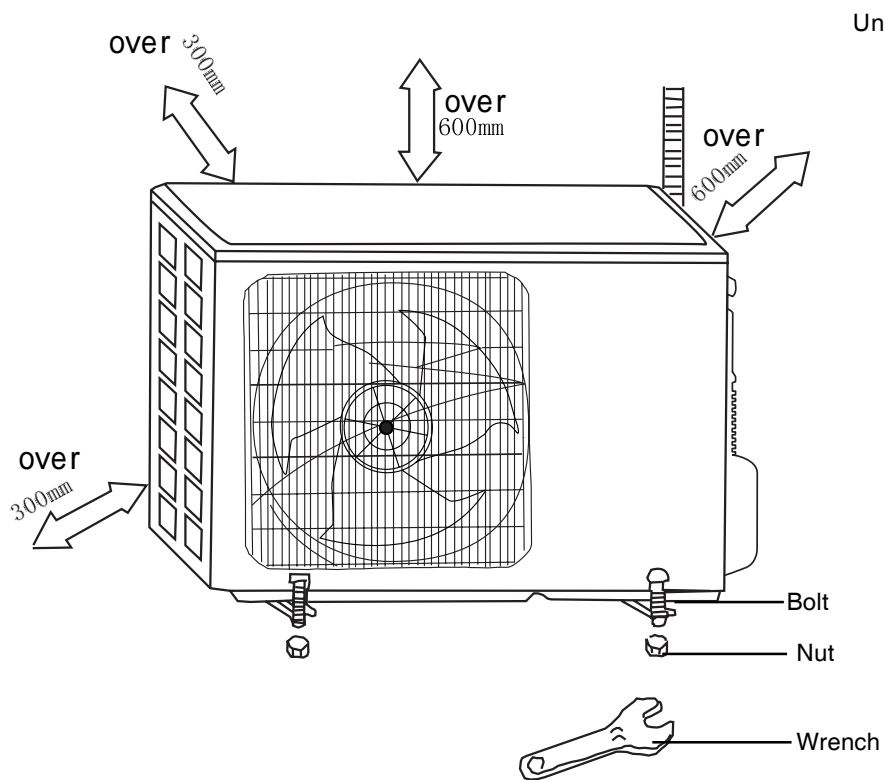
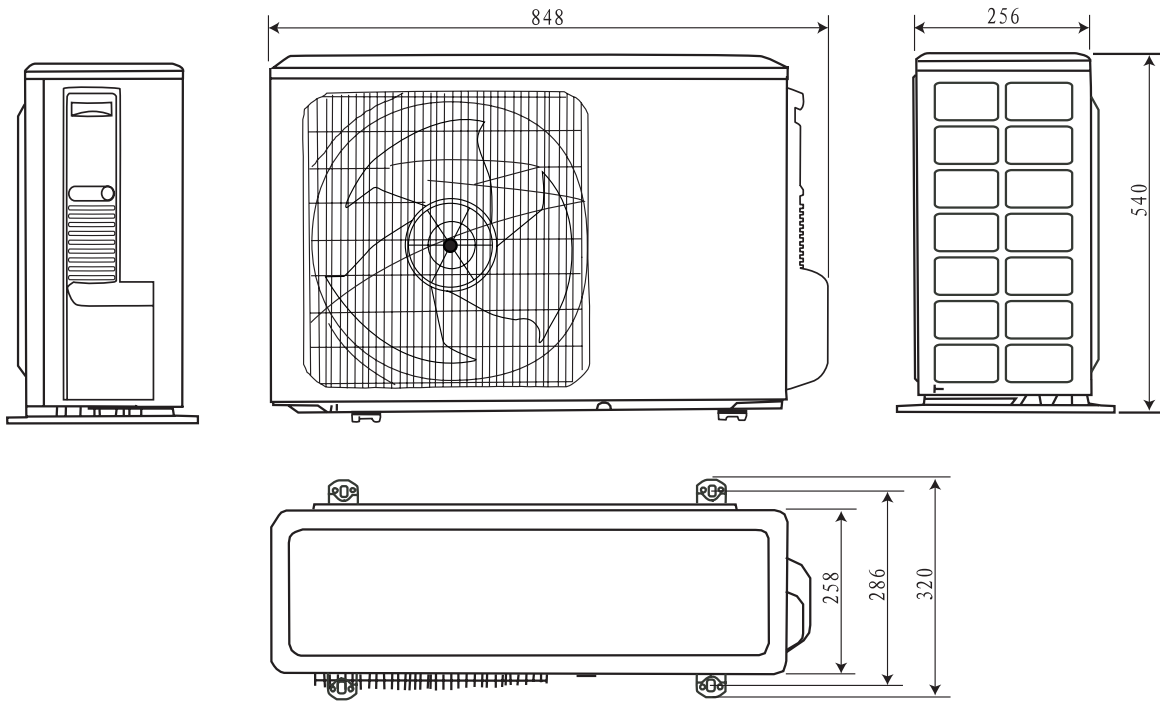

5 Electrical circuit diagram

ASH-09AK

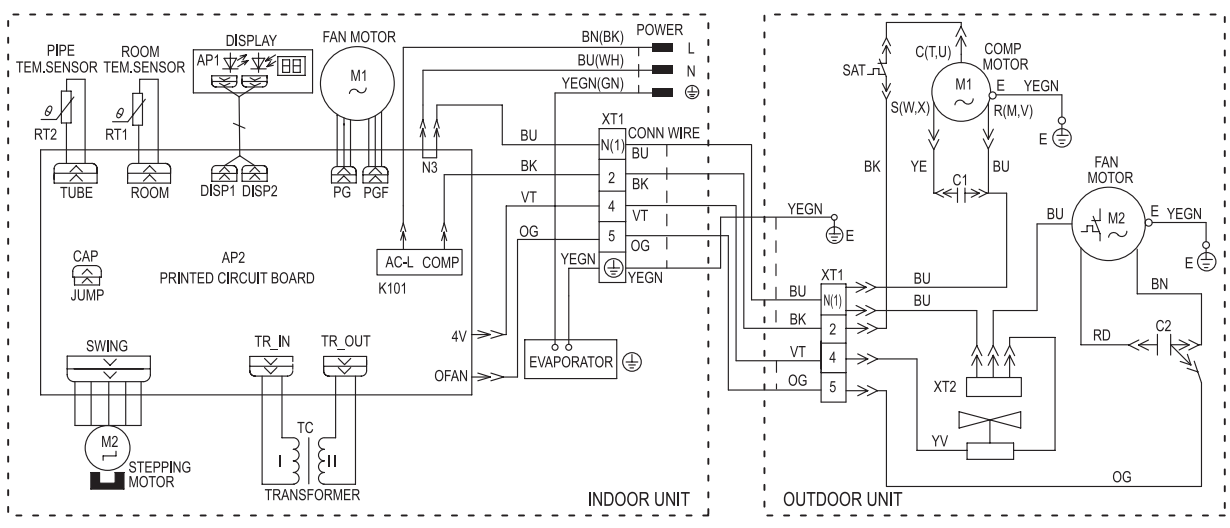

ASH-13AK

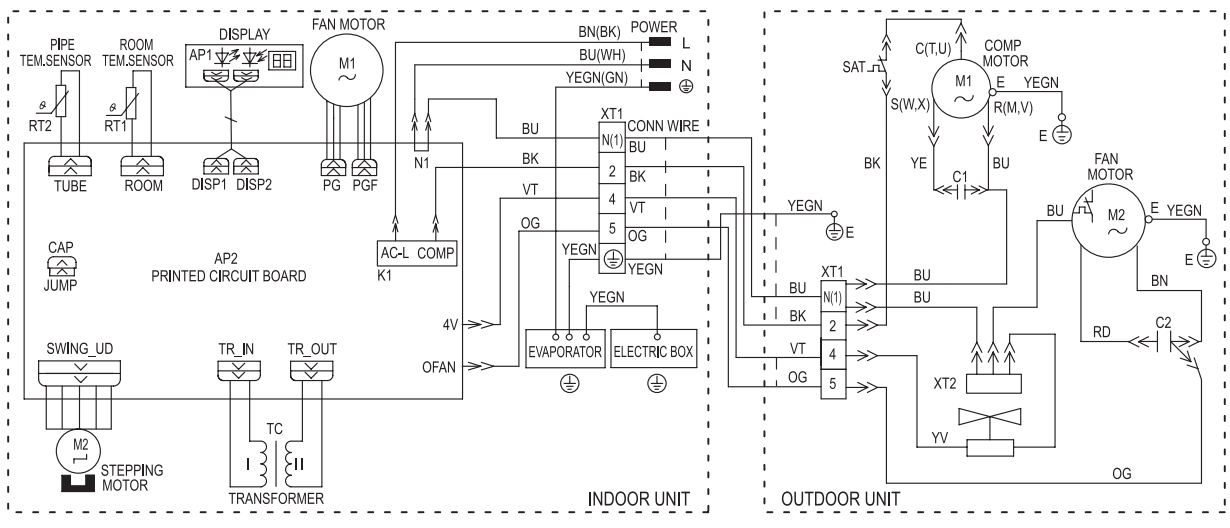

6

Manual of functions of remote controller and operation method

6.1 Manual 1 of functions of remote controller

6.1.1 Temperature parameter

- ◆ The room setting temperature (T_{preset})
- ◆ The room ambient temperature (T_{amb})

6.1.2 Basic Functions

Once energized, the compressor should in no way be restarted unless after 3-minute time interval at least. For the first energization, the compressor will be started without 3-minute lag. The compressor, once started, will not be stopped within 6 minutes with the change of room temperature.

6.1.2.1 Cooling Mode

6.1.2.1.1 Cooling Conditions and Process

When $T_{\text{amb}} \geq T_{\text{preset}} + 1^\circ\text{C}$, the unit will run under cooling mode, in which case the compressor and outdoor fan will start and the indoor fan will run at setting speed.

When $T_{\text{amb}} \leq T_{\text{preset}} - 1^\circ\text{C}$, the compressor and the outdoor fan will stop, the indoor fan will run at setting speed.

When $T_{\text{preset}} - 1^\circ\text{C} < T_{\text{amb}} < T_{\text{preset}} + 1^\circ\text{C}$, the unit will maintain its original operating status.

- Under this mode, the switchover valve will not be powered on, and the setting temperature range is $16 \sim 30^\circ\text{C}$.

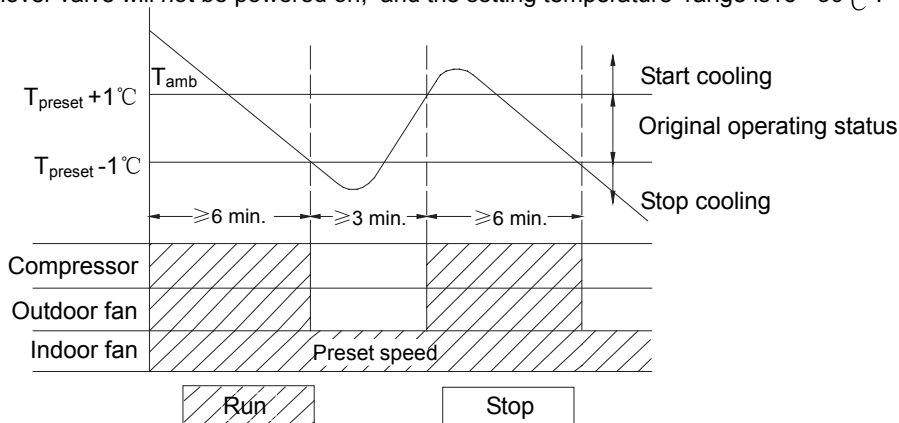

6.1.2.1.3 Protection

◆ Antifreeze Protection

If it is detected that the system is under antifreeze protection, the compressor and outdoor fan will be stopped, and the indoor fan will run at setting speed. When antifreeze protection is released and the compressor has stopped for 3 minutes, the unit will resume its original operating status.

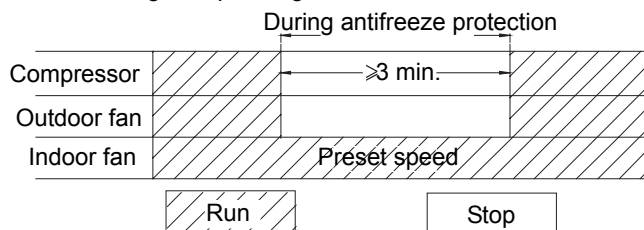

6.1.2.2 DRY Modes

6.1.2.2.1 The conditions and process of DRY

When $T_{\text{amb}} > T_{\text{preset}} + 2^\circ\text{C}$, the unit will run under DRY cooling mode, in which case the compressor and outdoor fan will be started and the indoor fan will run at low speed.

When $T_{\text{preset}} - 2^\circ\text{C} \leq T_{\text{amb}} \leq T_{\text{preset}} + 2^\circ\text{C}$, the unit will run under DRY mode, in which case the indoor fan will keep run at low speed, the compressor and the outdoor fan will be stopped after 6 minutes. After 4 minutes, the compressor and the outdoor fan will be restarted. The dehumidifying process is so repeated in cycle.

When $T_{\text{amb}} < T_{\text{preset}} - 2^\circ\text{C}$, the compressor and outdoor fan will be stopped, the indoor fan will run at low speed.

- Under this mode, the switchover valve will not be powered on, and the setting temperature range is $16 \sim 30^\circ\text{C}$.

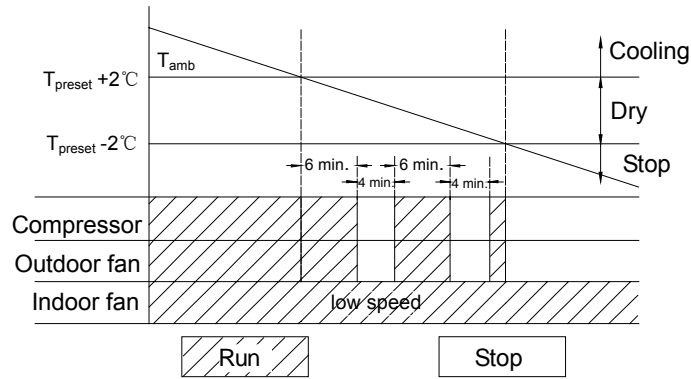

6.1.2.2.3 Protection

◆ Antifreeze Protection

Upon meeting the cooling condition, if it is detected that the system is under antifreeze protection, the compressor and outdoor fan will be stopped, and the indoor fan will run at low speed. When antifreeze protection is released and the compressor has stopped for 3 minutes, the complete unit will resume its original operating status.

Upon meeting the dehumidify condition, if it is detected that the system is under antifreeze protection, the compressor and outdoor fan will be stopped, and the indoor fan will run at low speed. When antifreeze protection is released and the compressor has stopped for 4 minutes, the complete unit will resume its original operating status.

6.1.2.3 HEAT Mode (there is no this mode for cooling only unit)

6.1.2.3.1 The conditions and process of heating

When $T_{amb} \leq T_{set} + 2^{\circ}\text{C}$, the system enters heating running, in this case, the reversal valve, compressor, outer fan enter simultaneously running. The indoor fan will delay at most for 2min to run.

When $T_{amb} \geq T_{set} + 4^{\circ}\text{C}$, the compressor and outdoor fan will stop, but the reversal valve is still with power on, the indoor unit will run at setting fan speed for 60s then will stop.

When $T_{set} + 2^{\circ}\text{C} < T_{amb} < T_{set} + 4^{\circ}\text{C}$, the unit will maintain its original operating status.

➤ Under this mode, the switchover valve will be powered on, and the setting temperature range is $16 \sim 30^{\circ}\text{C}$.

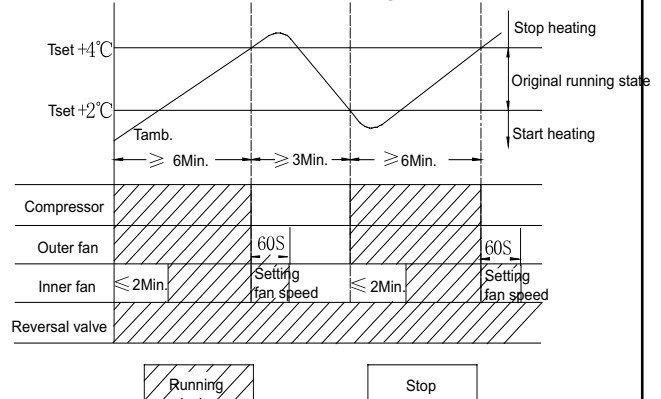

6.1.2.3.3 Conditions and processes of defrost

This unit adopt intelligent defrosting, it can defrost according to the frosting conditions, dual 8 display H1

6.1.2.3.4 Protection

◆ High Temp. Protection

If it is detected that the evaporator tube temperature is too high, the outdoor fan will be stopped. When the tube temperature resumes to normal, the outdoor fan will be restarted.

◆ **Noise Silencing Protection:** If the unit is stopped by pressing ON/OFF, the reversal valve will be stopped after 2-minute lag; or 2 minutes will be delayed upon mode switching.

6.1.2.4 Fan mode

Under FAN mode, only the indoor fan runs at setting speed. The RUN indicator will be bright. Double 8 module indicator will display the setting temperature. When stand by, the power indicator is bright but the unit does not run.

6.1.2.5 Auto Mode

Under this mode, the system will automatically select its run mode (cool, dehumidify, heat or fan) with the change of ambient temperature. For protection function, same as under cooling and heating mode.

3. Other controls

1. Memory function

Memory contents: Mode, up and down swing, Light, Setting temp., Setting fan speed, Ordinary setting Fahrenheit/Centigrade, after powered off, and powered on, it will run at the memory contents.

If no timer setting function in last remote control order, the system will memorize the last remote control order, the system will memorize the last remote control order and work with last remote control setting.

In the last remote control order, there is ordinary timer function, if power off happen beffore the timer arrived, the system will memorize the last remote control timer function, and will recalculate.

If there is timer function in last remote control order, but timer has arrive, system will run at timer on or timer off and power off, after repowered on, the system will run at the mode before power off.

(2) Timer function

1. Ordinary Timer setting:

Timer on: Under unit off, the timer on function could be set up, if timer on has arrived, controller will run at setting mode, the timer interval is 0.5hr, setting range is 0.5-24hrs.

Timer off: Under unit off, the timer off function could be set up, if timer off has arrived, controller will run at setting mode, the timer interval is 0.5hr, setting range is 0.5-24hrs.

② Timer setting for hour:

Timer on: if system is running, to set timer on, the system will continue to run, if unit is off to set up timer on, when timer on has arrived, the system will run at pressetting mode.

Timer off: If system is off to set up the timer off, when to set up timer off, the unit will stand by, when unit is on, to set up timer off, when the timer off arrived, the system will stop to work.

Timer setting change:

When system is in Timer status, can set up timer on and timer off by wireless remote control, to reset up Timer also, the system will run at last setting status.

When system is running, at the same time to set up Timer on and Timer off, the system will keep the present setting status, when time arrived, system will stop to work.

When system stop, at the same time to set up Timer on and Timer off, the system will stop, untile the timer arrived, the system will start to work.

Hereafter, when timer of timer on in every day arrived, it will run the presetting modes, after timer off arrived, the system will stop.

(3) Auto button

After powered on, press this button, it will run at Auto mode, when repressed, the unit will turns off.

(4) Buzzer

The controller is powered on and detect the signal received, the buzzer will beep.

(5) Sleep function

Under cooling or dehumidifying mode, the preset temperature will automatically rise by 1°C, ine hour after setting of sleep program and rise by 1°C after 2hours.

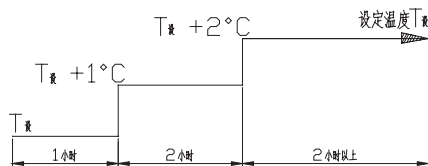

Under heating mode, the preset temperature will automatically decrease by 1°C one hour after setting of sleep program and decrease by another 1°C after 2hours.

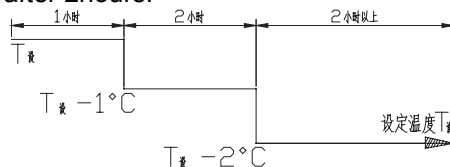

(6) Turbo function

The turbo function is available in Cool and Heat modes.

(7) Dry function

Dry function is available in Cool and Dehumidifying modes.

(8) Auto fan speed control

In this mode, indoor fan can run with Hig, Mid, Low speeds.

(9) Up and down swing control

After powered on, the lower swing motor will firstly rotate the guide louver to position 0, close up the air outlet vent; After unit turned on, if to set up swing function, when indoor fan stop running, the guide louver will stop at current position, inner fan motor is running, guide louver will resume to swing. From Cool, Dry, Fan modes to Heat mode, the guide louver will be opened at D position, when turn on swing will run at (A-D); from Heat mode to Cool, Dry, Fan mode, the fan louver will turn to B position, if turn on the swing, it will run at (A-C).

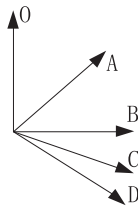

(10) Displayer

① Running figure and mode figure display

After powered on, the figure will be displayed, then only Power/running indicator turn on. When using remote controller to open the unit, it will turn on, at the same time to display current setting running modes.

② Dual 8 display

When the unit is turned on, after powered on, the nixie tube will display the setting temp.(setting range is 16-30℃). Under Auto mode, cooling and fan will display 25℃, heating will display 20℃, cooling only control display 25℃.

③ LCD Display

When cooling and dehumidifying, the Cool and indicator will turn on, when heating, the Heat and Run indicator will turn on, when in fan mode, the indicator will turn on.

(11) PG motor lock protection

When turn on the fan motor, if motor continuously run for a while and the running speed is very slow, in order to prevent motor automatically self-protection, it will stop running and display lock; If currently turns unit on, that dual 8 will display lock error code H6; If current is unit off, will not display the block error information.

6. 2 Manual 2 of functions of remote controller

This manual is applicable to 18K, 24K models, the centigrade is used for the following function manual, if there will be the Fahrenheit degree, that will be $TF = TCX1.8 + 32$.

1. Temperature parameter

◆ The room setting temperature (T_{preset})

◆ The room ambient temperature (T_{amb})

2 Basic Functions

Once energized, the compressor should in no way be restarted unless after 3-minute time interval at least for the first energization, the compressor will be started without 3-minute lag. The compressor, once started, will not be stopped within 6 minutes with the charge of room temperature.

(1) Cooling Mode

① Cooling Conditions and Process

When $T_{\text{amb}} \geq T_{\text{preset}} + 1^{\circ}\text{C}$, the unit will run under cooling mode, in which case the compressor and outdoor fan will start and the indoor fan will run at setting speed.

When $T_{\text{amb}} \leq T_{\text{preset}} - 1^{\circ}\text{C}$, the compressor and the outdoor fan will stop, the indoor fan will run at setting speed.

When $T_{\text{preset}} - 1^{\circ}\text{C} < T_{\text{amb}} < T_{\text{preset}} + 1^{\circ}\text{C}$, the unit will maintain its original operating status.

➤ Under this mode, the four-way valve will not be powered on and the setting temperature range is $16\text{--}30^{\circ}\text{C}$.
The displayer displays running signal, cooling signal and setting temperature.

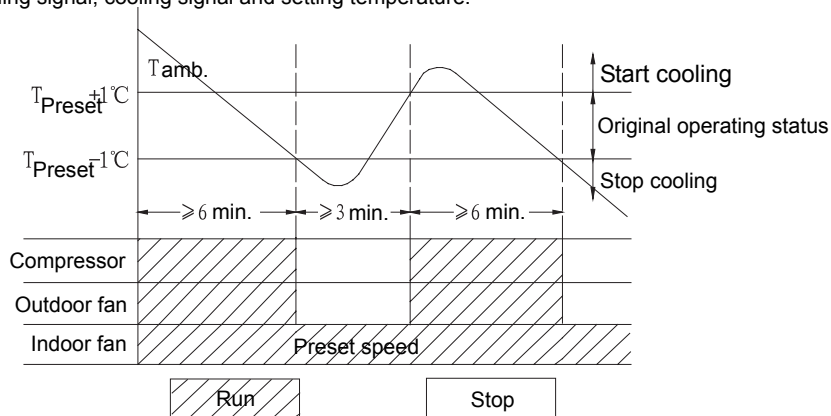

② Protection

◆ Antifreeze Protection

If it is detected that the system is under antifreeze protection, the compressor and outdoor fan will be stopped, and the indoor fan will run at setting speed. When antifreeze protection is released and the compressor has stopped for 3 minutes, the unit will resume its original operating status.

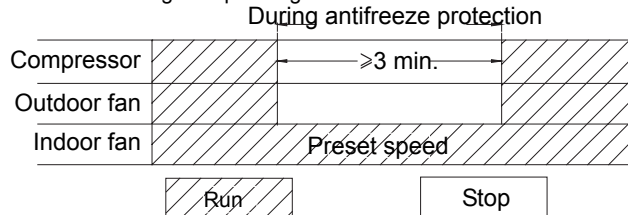

③ Over current protection

If it is detected that the system amperage exceeds the specified value (about 22 A), the main unit will enter into the status that only the fan is running. After 3 minutes and overcurrent protection is released, the main unit will resume its original operating status. If it is 6 times continuously detected overcurrent protection (if the compressor has run over 6 mins continuously, the times of protection will be cleared), the main unit will be stopped on standby, the nixietube will display error code "E5", power indicator will blink and it is need to restart the unit by the wireless remote control.

(2) DRY Modes

① DRY Modes

When $T_{amb} > T_{preset} + 2^{\circ}C$, the unit will run under DRY cooling mode, in which case the compressor and outdoor fan will be started and the indoor fan will run at low speed.

When $T_{preset} - 2^{\circ}C \leq T_{amb} \leq T_{preset} + 2^{\circ}C$, the unit will run under Dry mode, in which case the indoor fan will keep run at low speed, the compressor and outdoor fan will be stopped after 6mins. After 4 minutes, the compressor and outdoor fan will be restarted. The dehumidifying process is so repeated in cycle.

When $T_{amb} < T_{preset} - 2^{\circ}C$, the compressor and outdoor fan will be stopped, the indoor fan will run at low speed.

➤ Under this mode, the switchover valve will not be powered on and the setting temperature range is 16-30 °C.

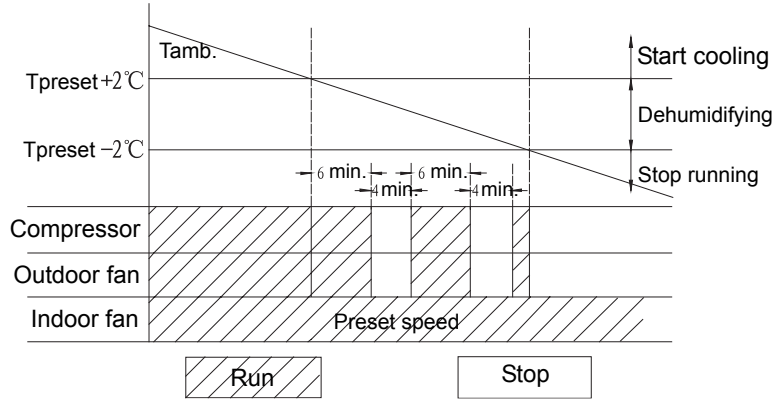

② Protection

◆ Antifreeze Protection

Under dehumidifying and cooling mode, if it is detected that the system is under antifreeze protection, the compressor and outdoor fan will be stopped, and the indoor fan will run at low speed. When antifreeze protection is released and the compressor has stopped for 3 minutes, the complete unit will resume its original operating status.

Upon meeting "run 6 mins and stop 4 mins" dehumidify condition, if it is detected that the system is under antifreeze protection, the compressor and outdoor fan will be stopped, and the indoor fan will run at low speed. When antifreeze protection is released and the compressor has stopped for 4 minutes, the complete unit will resume its original operating status.

③ Other protection status.

The other protections are the same with that under Cool mode.

(3) HEAT Mode (there is no this mode for cooling only unit)

① The conditions and process of heating

When $T_{amb} \leq T_{set} + 2^{\circ}C$, the system enters heating running, in this case, the reversal valve, compressor, outdoor fan enter simultaneously running. The indoor fan will delay at most for 2min to run.

When $T_{amb} \geq T_{set} + 4^{\circ}C$, the compressor and outdoor fan will stop, but the reversal valve is still with power on, the indoor unit will run at setting fan speed for 60s then will stop.

When $T_{set} + 2^{\circ}C < T_{amb} < T_{set} + 4^{\circ}C$, the unit will maintain its original operating status.

➤ Under this mode, the switchover valve will be powered on and the setting temperature range is 16-30 °C.

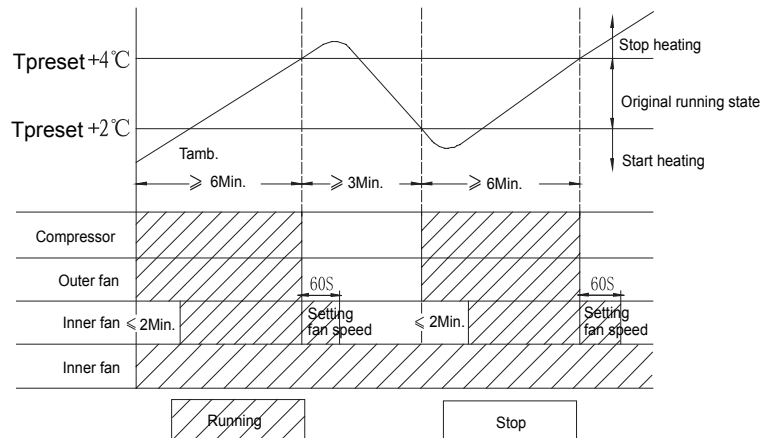

② Conditions and processes of defrost

This unit adopt intelligent defrosting, it can defrost according to the frosting conditions, dual 8 display H1

③ Protection

◆ Anti-high temperature protection

If it is detected that the evaporator tube temperature is too high, the outdoor fan will be stopped. When the tube temperature resumes to normal, the outdoor fan will be restarted.

◆ Noise Silencing Protection

If the unit is stopped by pressing ON/OFF, the reversal valve will be stopped after 2-minute lag; or 2 minutes will be delayed upon mode switching.

④ Over current protection

The overcurrent protection is the same with the over current protection under cool mode.

(4) Fan mode

Under FAN mode, only the indoor fan runs at setting speed. The RUN indicator will be bright. Double 8 module indicator will display the setting temperature. When stand by, the power indicator is bright but the unit does not run.

(5) Auto Mode

Under this mode, the system will automatically select its run mode (cool, dehumidify, heat or fan) with the change of ambient temperature. For protection function, same as under cooling and heating mode.

3 Other controls

(1) Timer function

① Ordinary Timer setting:

timer on: Under unit off, the timer on function could be set up, if timer on has arrived, controller will run at setting mode, the timer interval is 0.5hr, setting range is 0.5-24hrs.

Timer off: Under unit off, the timer off function could be set up, if timer off has arrived, controller will run at setting mode, the timer interval is 0.5hr, setting range is 0.5-24hrs.

② Timer setting for hour:

Timer on: if system is running, to set timer on, the system will continue to run, if unit is off to set up timer on, When timer on has arrived, the system will run at pressetting mode.

Timer off: If system is off to set up the timer off, when to set up timer off, the unit will stand by, when unit is on, to set up timer off, when the timer off arrived, the system will stop to work.

Timer setting change:

When system is in Timer status, can set up timer on and timer off by wireless remote control, to reset up Timer also, the system will run at last setting status.

When system is running, at the same time to set up Timer on and Timer off, the system will keep the present setting status, when time arrived, system will stop to work.

When system stop, at the same time to set up Timer on and Timer off, the system will stop, until the timer arrived, the system will start to work.

Hereafter, when timer of timer on in every day arrived, it will run the presetting modes, after timer off arrived, the system will stop.

(2) Auto button

After powered on, press this button, it will run at Auto mode, when repressed, the unit will turns off.

(3) Buzzer

The controller is powered on and detect the signal received, the buzzer will beep.

(4) Sleep function

Under cooling or dehumidifying mode, the preset temperature will automatically rise by 1°C, one hour after setting of sleep program and rise by 1°C after 2hours.

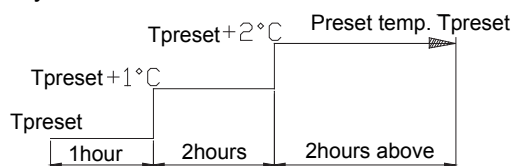

Under heating mode, the preset temperature will automatically decrease by 1°C one hour after setting of sleep program and decrease by another 1°C after 2hours.

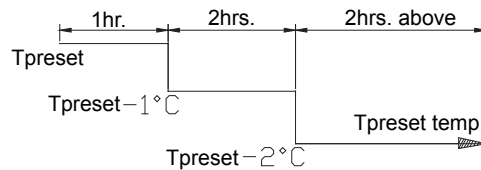

(5) Turbo function

The turbo function is available in Cool and Heat modes.

(6) Dry function

Dry function is available in Cool and Dehumidifying modes.

(7) Auto fan speed control

In this mode, indoor fan can run with Hig, Mid, Low speeds.

(8) Up and down swing control

After powered on, the lower swing motor will firstly rotate the guide louver to position 0, close up the air outlet vent; After unit turned on, if to set up swing function, when indoor fan stop running, the guide louver will stop at current position, inner fan motor is running, guide louver will resume to swing. From Cool, Dry, Fan modes to Heat mode, the guide louver will be opened at D position, when turn on swing will run at (A-D); from Heat mode to Cool, Dry, Fan mode, the fan louver will turn to B position, if turn on the swing, it will run at (A-C). When unit is turned off, the guide louver will turn to position 0, the swing is only available after preset the swing function, and indoor unit is running.

Note: When to set up at position L to B, A to C, B to D, the guide louver will swing between position W to D.

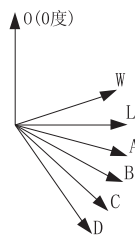

(9) Displayer

① Running figure and mode figure display

After powered on, the figure will be displayed, then only Power/running indicator turn on. When using remote controller to open the unit, it will turn on, at the same time to display current setting running modes.

② Dual 8 display

When the unit is turned on, after powered on, the nixie tube will display the setting temp.(setting range is 16-30°C).

When the preset temperature display signal has been received, the nixie tube will display the preset temperature;

If the display ambient temperature signal has been received, the nixie tube will display the current indoor ambient temperature, if to set up others by remote controller that the display will maintain its status. At displaying ambient temperature, the unit received the remote control signal, it will display 5s preset temperature then turn to ambient temperature display. The ambient temperature sensor malfunction will display F1; Indoor tube sensor will display F2, wire jumper cap protection displays C5.

(10) PG motor lock protection

When turn on the fan motor, if motor continuously run for a while and the running speed is very slow, in order to prevent motor automatically self-protection, it will stop running and display lock; If currently turns unit on, that dual 8 will display lock error code H6; If current is unit off, will not display the block error information.

(11) Power-off Memory

Memory contents: Mode, UP/DOWN Swing, light, Set temp, Set fan speed.

After de-energized, and re-energized, the unit will start to run with the memory function automatically. The system, if the last remote control signal do not set timer function, will memorize the last remote control signal and run according to it. If the last remote control signal has set timer function, the system is de-energized before the set time,when re-energized, the system will memorize the timer function, the set time will recalculate. If the last remote control signal has set timer function and the system is de-energized after the set time, when re-energized, the system will memorize the running status before de-energized.

7 Dissassembly Procedures

7.1 (09) Disassembly procedures for indoor unit

Operating Procedures / Photos

1. Disassemble the front panel, filter

Push the rotating shaft of front panel outside to put it out from the groove, screw off one screw on the display guard board, then take down the displayer connection wire, can take down the front panel.

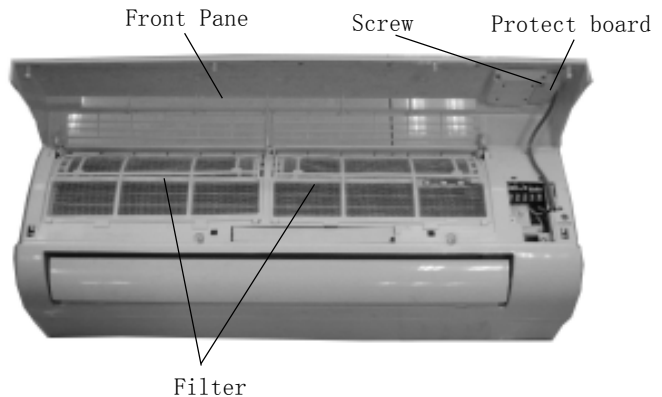

2. Disassemble the guide louver

Bend the guide louver so that the movable lock of guide louver is released to remove the guide louver.

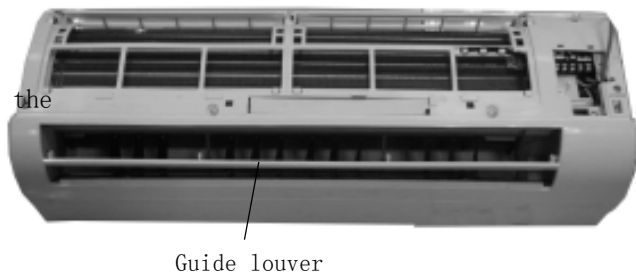

3. Disassemble the front case

Open the 2 screw covers at the front case and screw off 4 screws. Pull out the movable latch at the front case with hand, disassemble the front case.

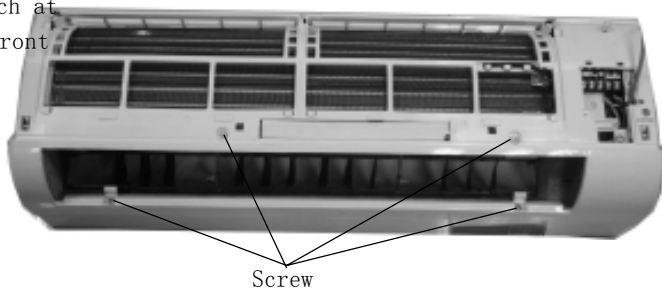

Operating Procedures / Photos

4. Disassemble the electric cover

Screw off the screw, then press the clasps in by till they loose, then lift up wards the electric cover.

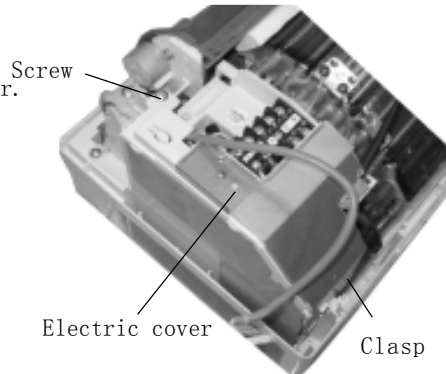

5. Disassemble the electric box

Screw off the grounding wire of the evaporator, remove the temperature sensor for the pipe, put out the connection lines for the step motor and the indoor motor. Screw off the screw fixing the electric box. Remove the electric box.

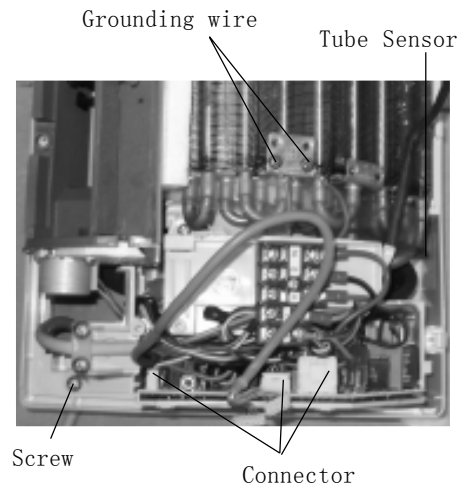

5. Disassemble water tray

Loosen the clasps at both sides of water tray sub-assy then lift them up, can take out of the water tray sub-assy.

Note: Because the water tray is connected with the water drainage pipe, so when take it out should pay more attention, avoid to hurt the fin of evaporator.

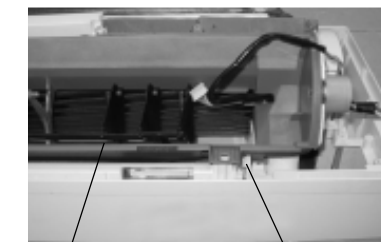
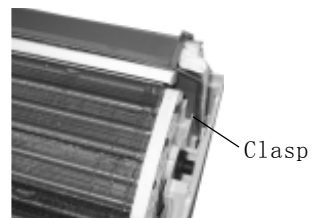

Water tray Clasp

Operating Procedures / Photos

6. Disassembling the evaporator

Screw off one screw which fix the connection pipe clamp.
Take off the connection pipe clamp.



CAUTION:

When repair, Carefully take out the evaporator and pay attention to protect the connecting pipe.

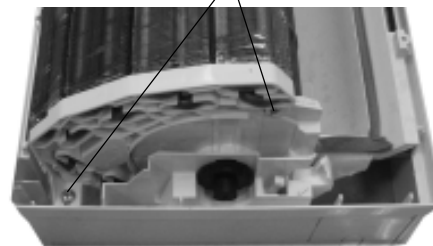
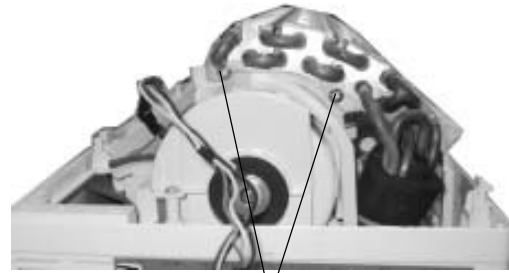

7. Disassembling motor and cross flow fan

Screw off 4 screws fixing the motor cover and then take the motor cover out.

Screw off the holding screw at the left shaft sleeve of the cross flow fan, pull out the motor, and remove the cross flow fan.

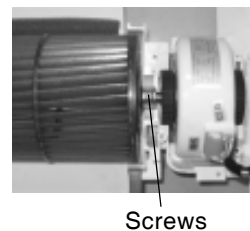
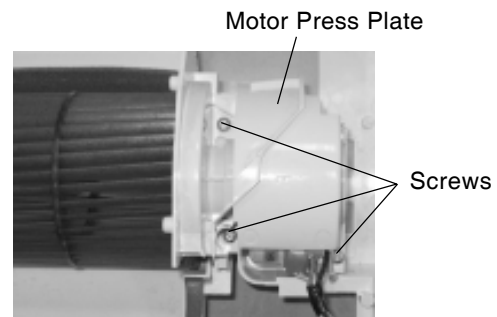

7.2 (12) Disassembly procedures for indoor unit

Operating Procedures / Photos

1. Disassemble the front panel, filter

Open the front panel, Push the filter upwards to unloose the clasp, and then pull out the two filters. Screw off one screw on the displayer box, take down the guard board then disconnect the displayer connection wire, can take down the front panel.

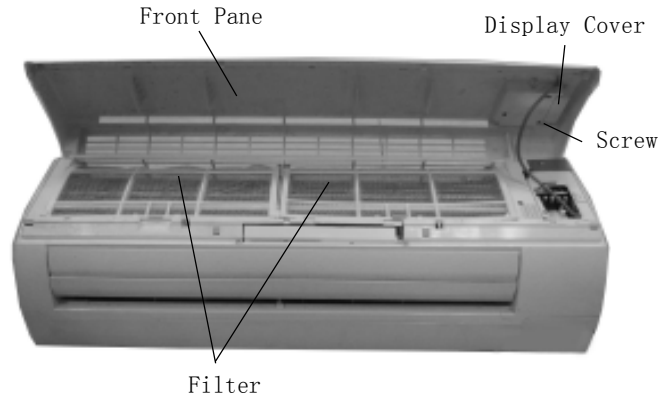

2. Disassemble the guide louver

Bend the guide louver so that the movable lock of guide louver is released to remove the guide louver.

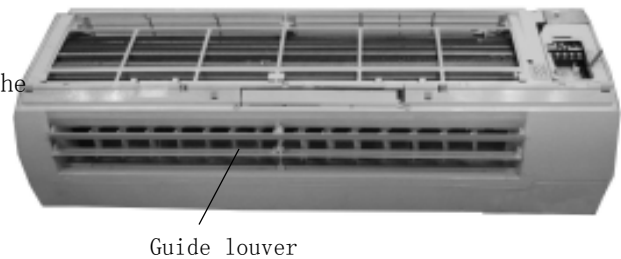

3. Disassemble the front case

Open the 2 screw covers at the front case and screw off 4 screws. Pull out the movable latch at the front case with hand and then pull it backwards to disassemble the front case.

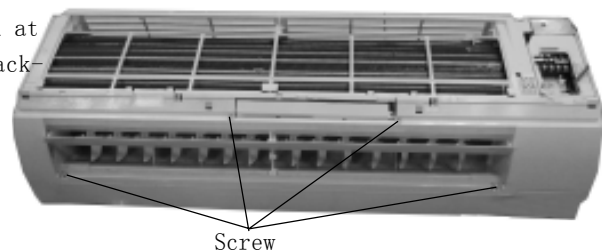

Operating Procedures / Photos

4. Disassemble the electric cover

Press the clasps in by till they loose, then lift up wards the electric cover.

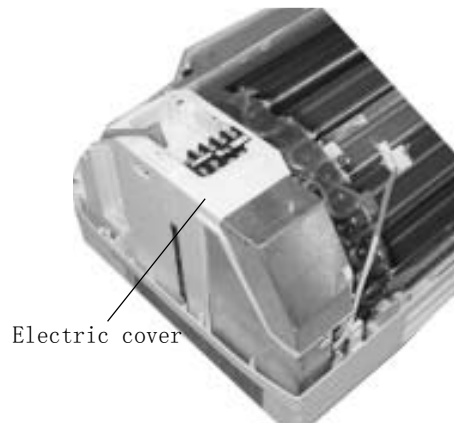

5. Disassemble the electric box

Screw off the grounding wire of the evaporator, remove the tube sensor and temp sensor support, put out the connection lines for the step motor and the indoor motor. Screw off the screws fixing the electric box. Remove the electric box.

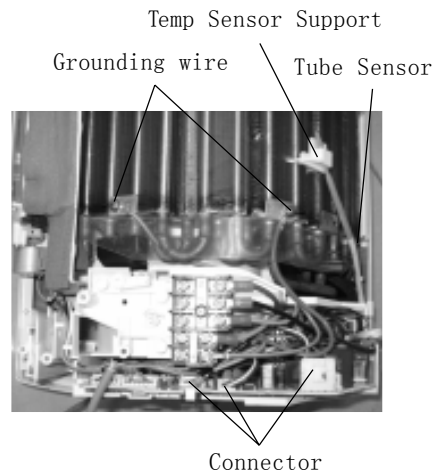

5. Disassemble water tray

Loosen up the clasp at the front of and the rear of water tray sub-assy and lift them up, can take out the water tray sub-assy.

Note: Due to the water tray is connected with the water drainage pipe, please pay more attention do not to damage the fin on evaporator.

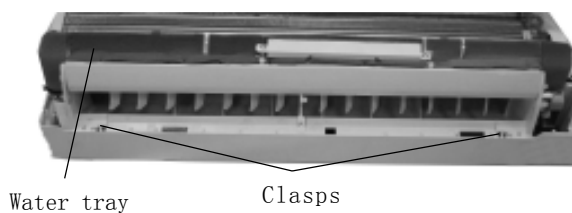
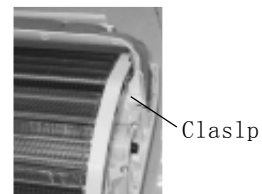

Operating Procedures / Photos

6. Disassembling the evaporator

Screw off 4 screws fixing the left and right side of the evaporator, then elevate left side the evaporator to remove it backward.

CAUTION:

When repair, Carefully take out the evaporator and pay attention to protect the connecting pipe.

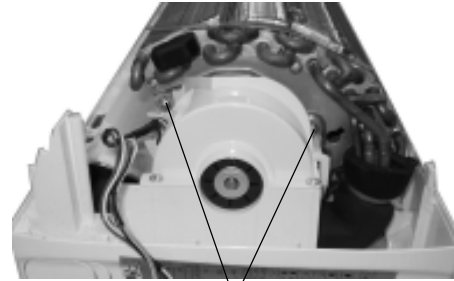

Screws

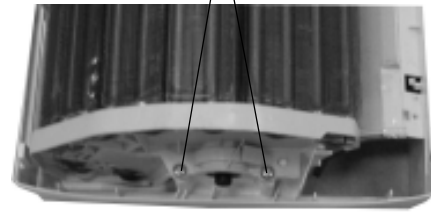

7. Disassembling motor and cross flow fan

Screw off 4 screws fixing the motor cover and then take the motor cover out.

Screw off the holding screw at the left shaft sleeve of the cross flow fan, pull out the motor, and remove the cross flow fan.

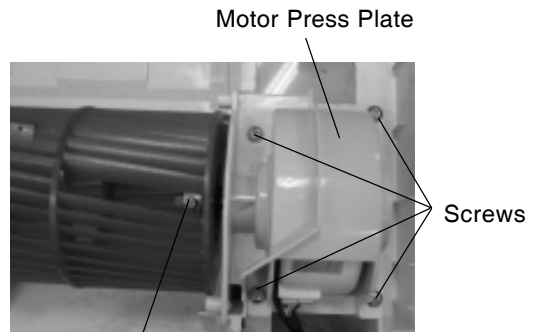

Motor Press Plate

Screws

Screws

7. 4 (Conventional 09) Disassembly procedures for indoor unit

Operating Procedures / Photos

1. Disassemble the front panel, filter

Push the rotating shaft of front panel outwards to unloose the clasp, and then pull out the front panel. Screw off the screws of the electric box cover, and take down the electric box cover.

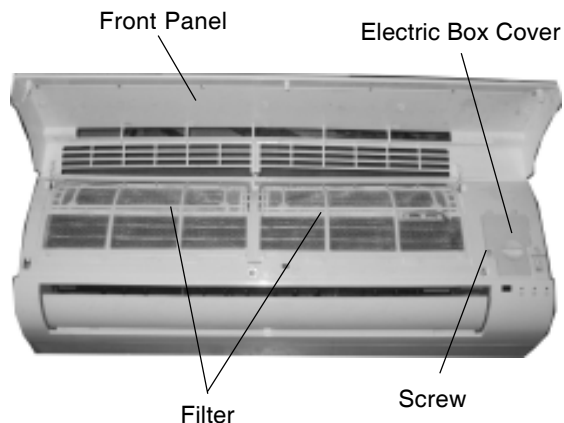

2. Disassemble the guide louver

Bend the guide louver so that the movable lock of guide louver is released to remove the guide louver.

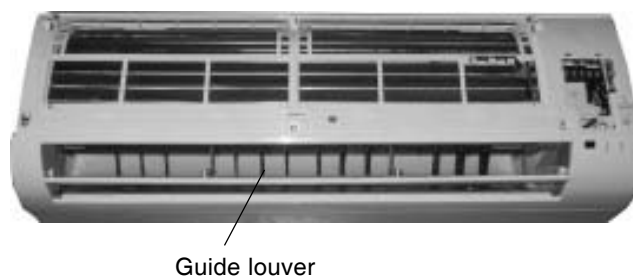

3. Disassemble the front case

Open the 2 screw covers at the front case and screw off 4 screws. Pull out the movable latch at the front case with hand and then pull it backwards to disassemble the front case.

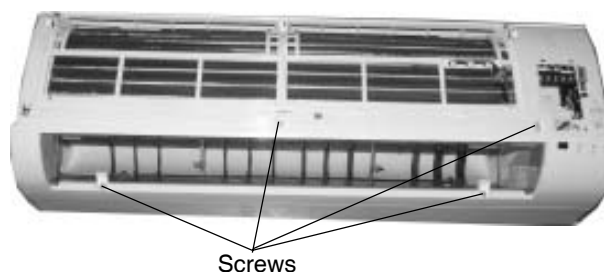

Operating Procedures / Photos

4. Disassemble the electric box cover

Screw off the screw, then press the clasps in by till they loose, then lift up wards the electric cover and the light board.

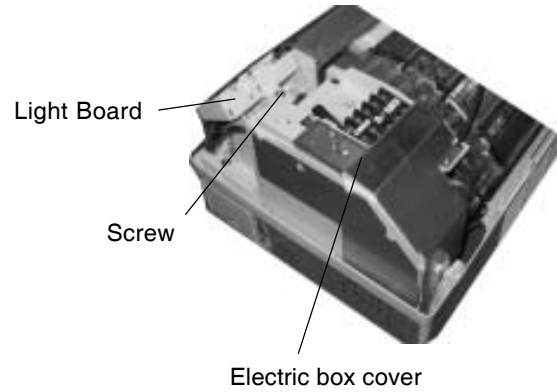

5. Disassemble water tray

Loosen up the clasp at the front of and the rear of water tray sub-assy and lift them up, can take out the water tray sub-assy.

Note: Due to the water tray is connected with the water drainage pipe, please pay more attention do not to damage the fin on evaporator.

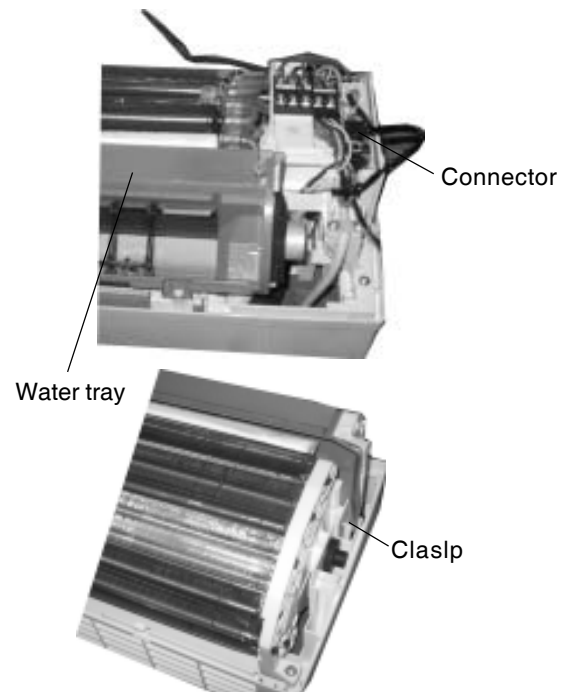

6. Disassemble the electric box

Loosen the grounding wire of the evaporator, remove the temperature sensor for the pipe, put out the connection lines for the indoor motor. Screw off the screws fixing the electric box. Remove the electric box.

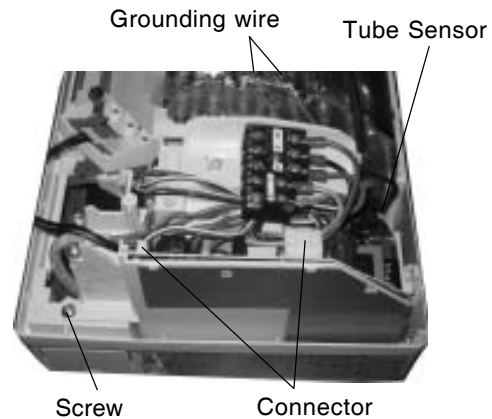

Operating Procedures / Photos

7. Disassembling the evaporator

Screw off 1 pc screw fixing the connecting pipe clamp, take down the connecting pipe clamp.



CAUTION:

When repair, Carefully take out the evaporator and pay attention to protect the connecting pipe.

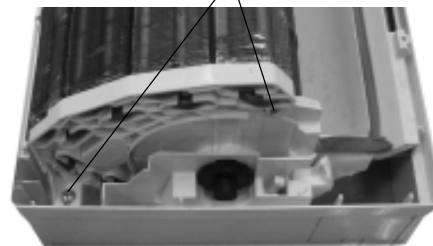
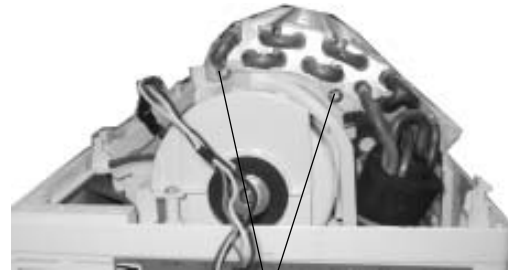

8. Disassembling motor and cross flow fan

Screw off 4 screws fixing the motor cover and then take the motor cover out.

Screw off the holding screw at the left shaft sleeve of the cross flow fan, pull out the motor, and remove the cross flow fan.

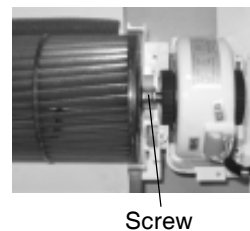
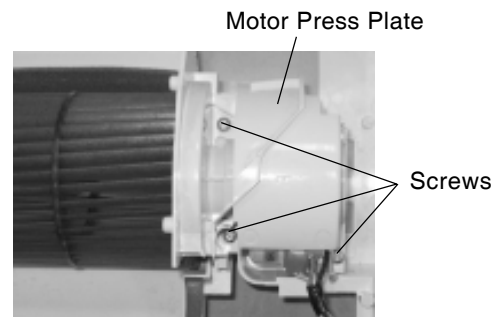

7.5 (Conventional 12) Disassembly procedures for indoor unit

Operating Procedures / Photos

1. Disassemble the front panel, filter

Push the rotating shaft of front panel outwardly, to make it out of the groove, then can take down the front panel.

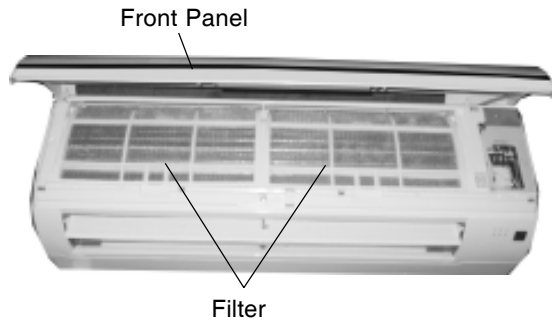

2. Disassemble the guide louver

Bend the guide louver so that the movable lock of guide louver is released to remove the guide louver.

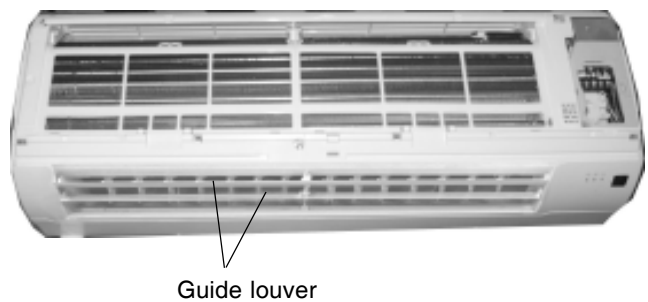

3. Disassemble the front case

Open the 2 screw covers at the front case and screw off 1 screws. Pull out the movable latch at the front case with hand and then pull it backwards to disassemble the front case.

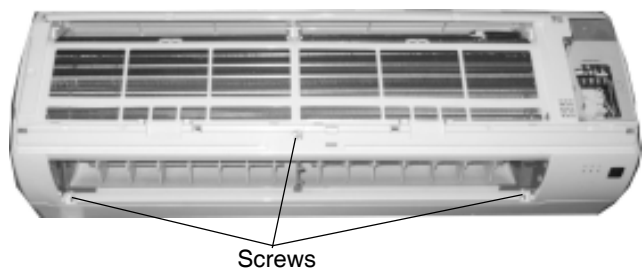

Operating Procedures / Photos

4. Disassemble the Light Board and electric cover

Screw off 1pc screw of light board, then can take down the light board.

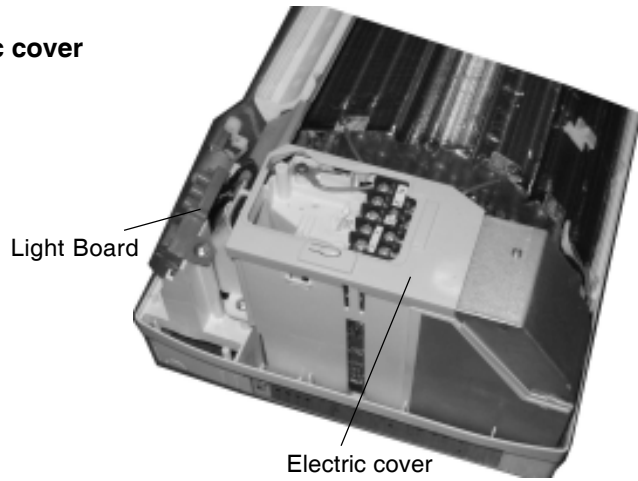

5. Disassemble the electric box

Loosen the grounding wire of the evaporator, remove the tube sensor and temp sensor support, put out the connection lines for the step motor and the indoor motor. Screw off the screws fixing the electric box. Remove the electric box.

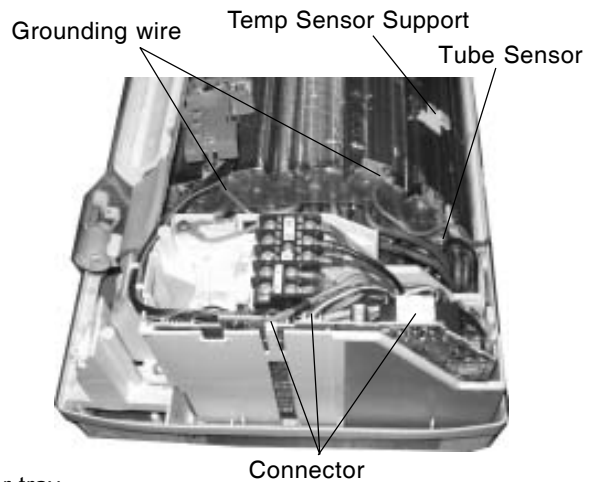

6. Disassemble water tray

Unloosen the clasps of front and rear sides of water tray, then lift them up, then can take down the water-tray sub-assy, and pay more attention do not hurt the fin on evaporator.

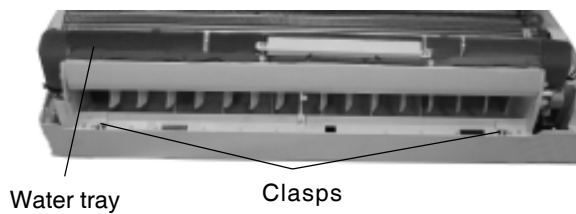
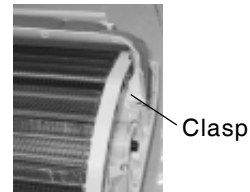

Operating Procedures / Photos

7. Disassembling the evaporator

Screw off 4 screws fixing the left and right side of the evaporator, then elevate left side the evaporator to remove it backward.

CAUTION:

When repair, Carefully take out the evaporator and pay attention to protect the connecting pipe.

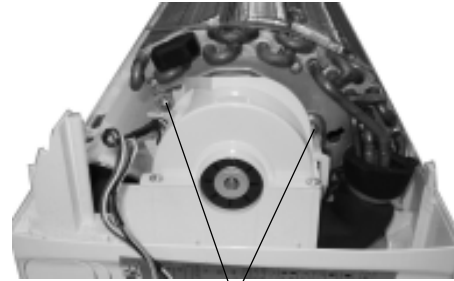

Screws

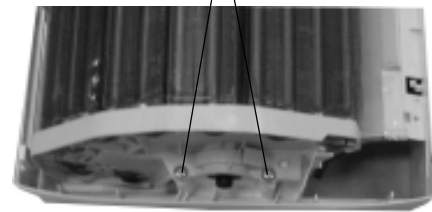

8. Disassembling motor and cross flow fan

Screw off 4 screws fixing the motor cover and then take the motor cover out.

Screw off the holding screw at the left shaft sleeve of the cross flow fan, pull out the motor, and remove the cross flow fan.

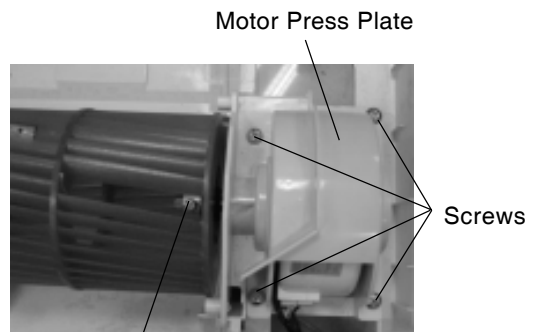

Motor Press Plate

Screws

Screw

Operating Procedures / Photos

1. Disassemble Big Handle

Unscrew the screw fixing the big handle, and then remove it downwards to take it out.

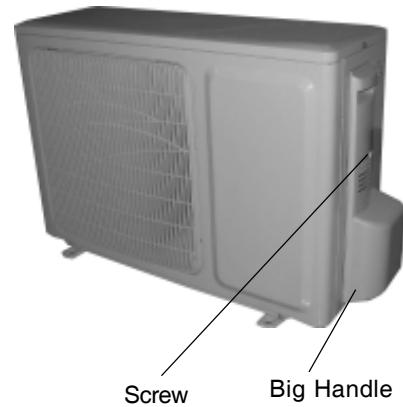

2. Disassemble Top Cover

Unscrew the 2 screws fixing left side of top cover and the 1 screw fixing the right side to remove the top cover.

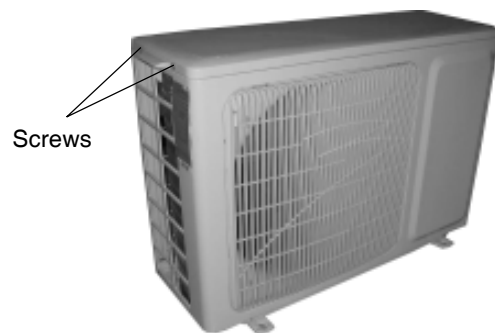

3. Disassemble Rear Grill

Unscrew the 4 screws fixing the rear grill to remove it.

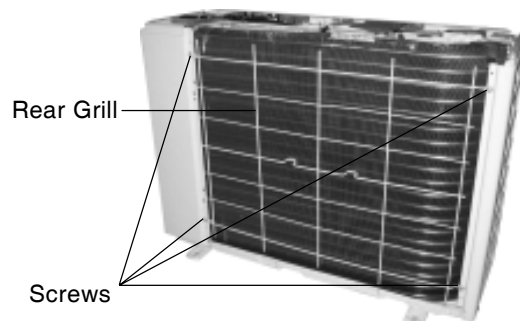

Operating Procedures / Photos

4. Disassemble Front Panel

Unscrew the 5 screws fixing the panel and dextrorotate the front panel to pull it out from groove.

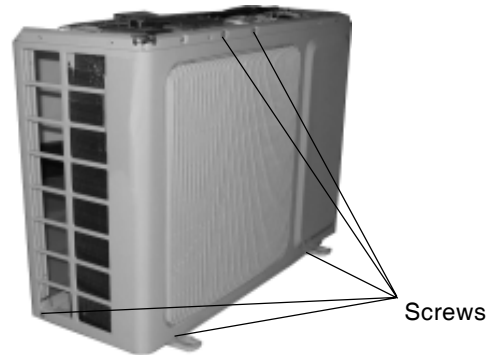

5. Disassemble Right Side Plate

Unscrew the 2 screws fixing electric box, and then unscrew the 5 screws fixing the right side plate to remove it.

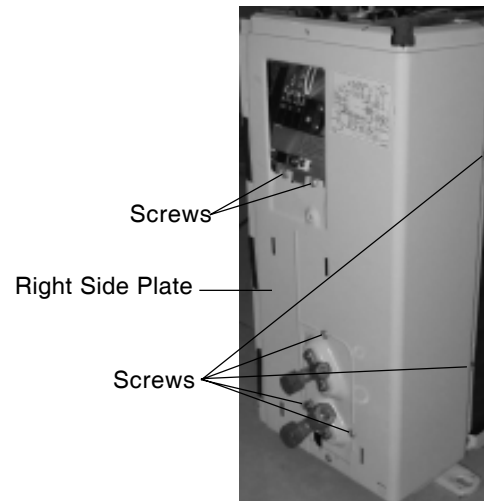

6. Disassemble Electric Box

Unscrew the screws fixing the electric box, and then pull out the inset block of lead-out wire of compressor and fan motor to take out the electric box.

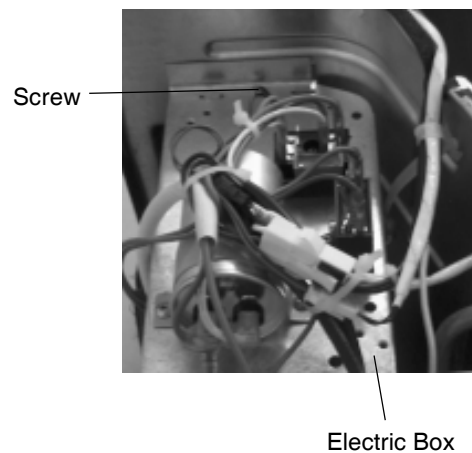

Operating Procedures / Photos

7. Disassemble Axial Flow Fan

Loosen the fastening nut fixing the axial flow fan with a spanner, and then take out the nut, spring gasket and flap gasket in turn.

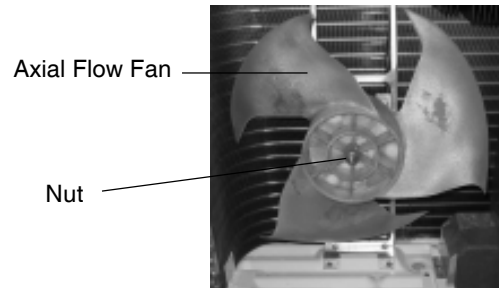

8. Disassemble Motor and Motor Support

Unscrew the 4 screws fixing the motor to take out the motor, and then unscrew the 2 screws fixing the motor support to take it out.

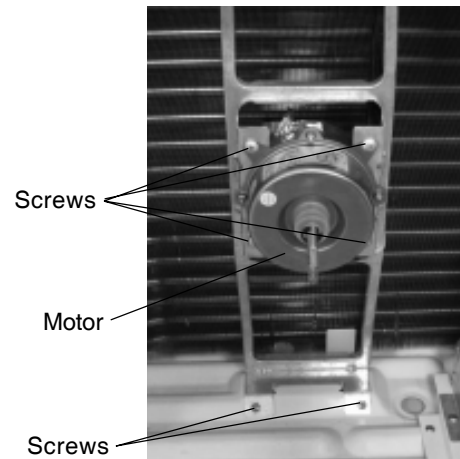

9. Disassemble Four-way Valve

Unscrew the fastening nut of the four-way valve coil and remove the coil. Wrap the four-way valve with wet cotton and unsolder the 4 weld spots connecting the four-way valve to take it out. (Note: Refrigerant should be discharged firstly.)

Welding process should be as quick as possible and keep wrapping cotton wet all the time. Be sure not to burn out the lead-out wire of compressor.

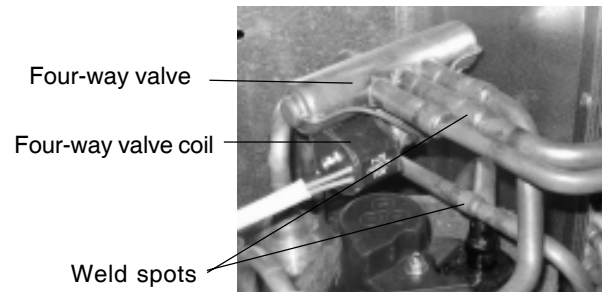

Operating Procedures / Photos

10. Disassemble Capillary

Respectively unsolder the weld spots of main capillary and auxiliary capillary to take off the capillary.

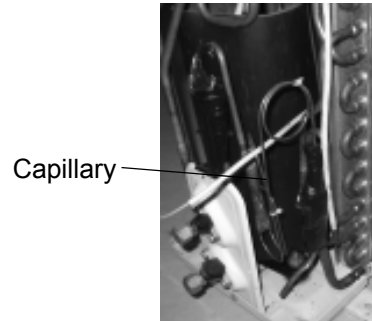

11. Disassemble Gas and Liquid Valves

Unscrew the two bolts fixing gas valve and liquid valve. Unsolder weld spots between gas valve and air-return pipe to remove the gas valve.

Unscrew the two bolts fixing liquid valve. Unsolder weld spots between liquid valve and capillary to remove the liquid valve.

(Note: During unsoldering, wrap the valves with wet cloth to avoid damage for high temperature.)

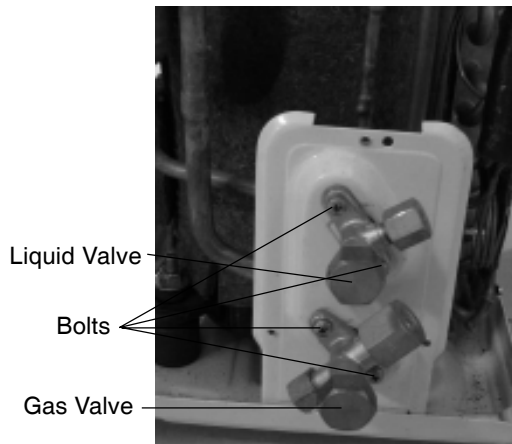

12. Disassemble Compressor

Unscrew the three foot-nuts at the foot of the compressor. Unsolder the suction and the discharge pipes of the compressor, and then carefully remove the pipes to take out the compressor.

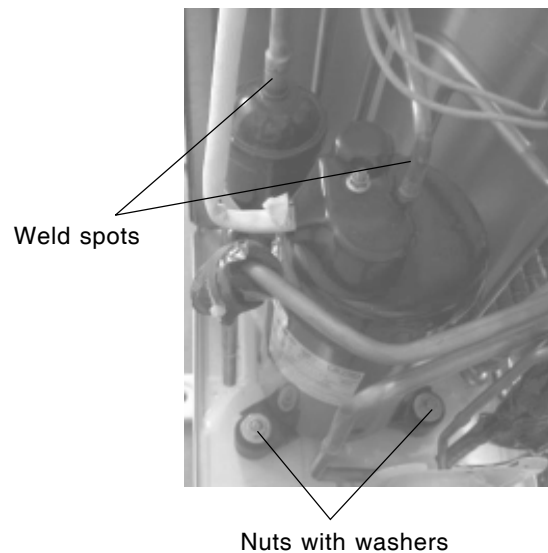

9 Failure and analysis

Note: When replacing the controller, make sure insert the wire jumper into the new controller, otherwise, the running indicator off 3s, blink 15 times, (the dual eight will display C5) but cannot turn on the unit.

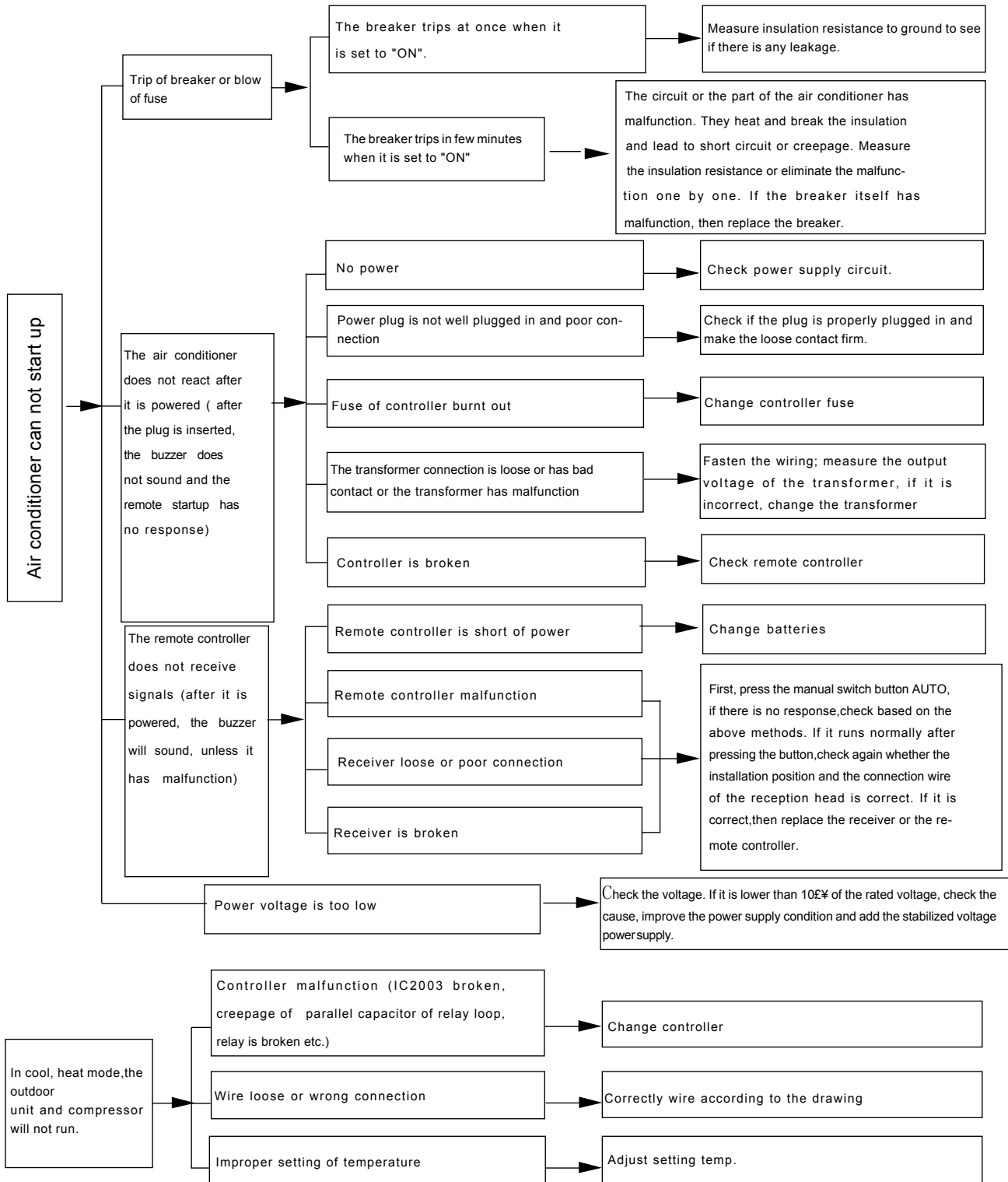

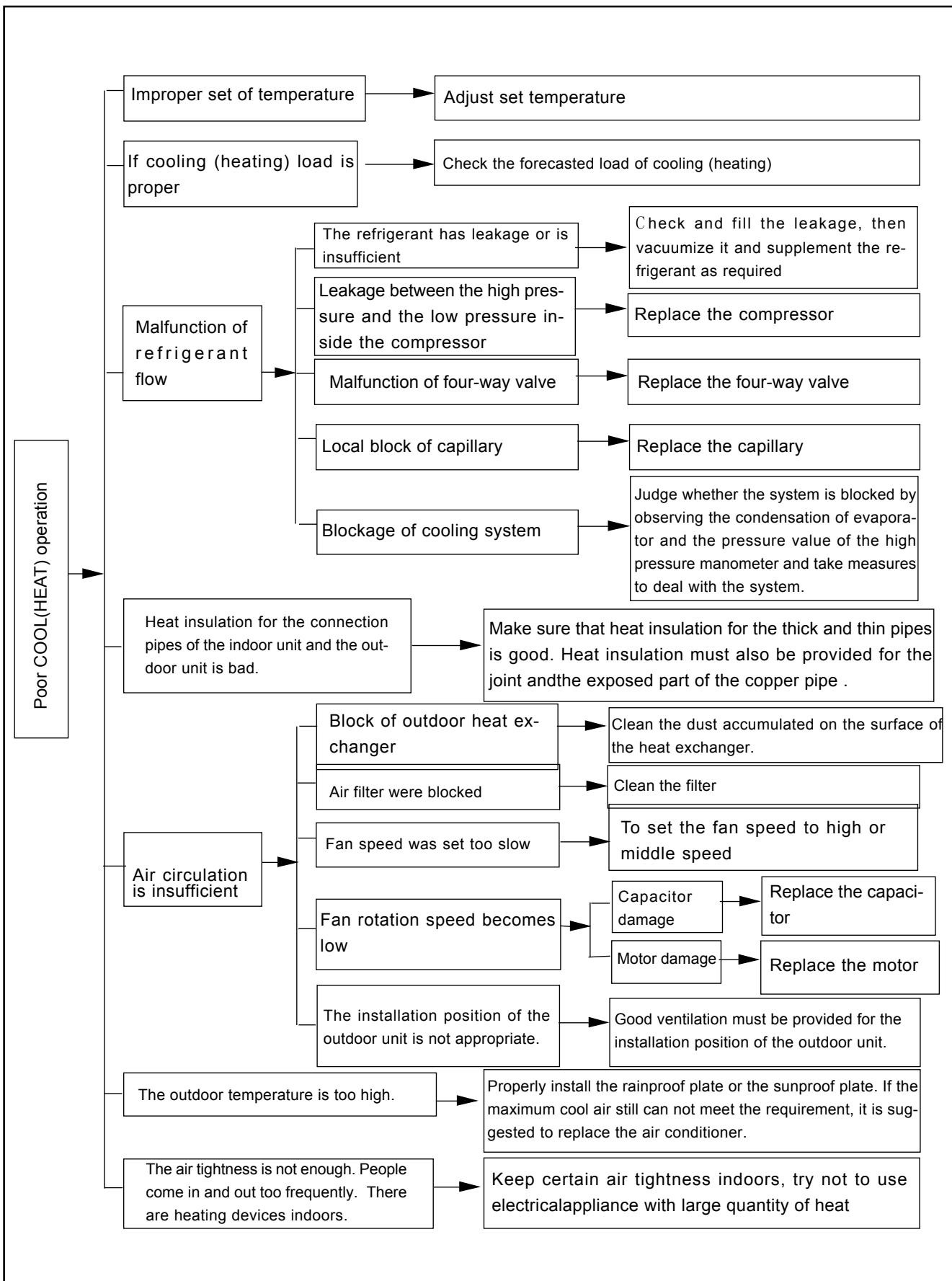

Poor COOL(HEAT) operation

Improper set of temperature

Adjust set temperature

If cooling (heating) load is proper

Check the forecasted load of cooling (heating)

Malfunction of refrigerant flow

The refrigerant has leakage or is insufficient

Check and fill the leakage, then vacuumize it and supplement the refrigerant as required

Leakage between the high pressure and the low pressure inside the compressor

Replace the compressor

Malfunction of four-way valve

Replace the four-way valve

Local block of capillary

Replace the capillary

Blockage of cooling system

Judge whether the system is blocked by observing the condensation of evaporator and the pressure value of the high pressure manometer and take measures to deal with the system.

Heat insulation for the connection pipes of the indoor unit and the outdoor unit is bad.

Make sure that heat insulation for the thick and thin pipes is good. Heat insulation must also be provided for the joint and the exposed part of the copper pipe .

Air circulation is insufficient

Block of outdoor heat exchanger

Clean the dust accumulated on the surface of the heat exchanger.

Air filter were blocked

Clean the filter

Fan speed was set too slow

To set the fan speed to high or middle speed

Fan rotation speed becomes low

Capacitor damage

Replace the capacitor

Motor damage

Replace the motor

The installation position of the outdoor unit is not appropriate.

Good ventilation must be provided for the installation position of the outdoor unit.

The outdoor temperature is too high.

Properly install the rainproof plate or the sunproof plate. If the maximum cool air still can not meet the requirement, it is suggested to replace the air conditioner.

The air tightness is not enough. People come in and out too frequently. There are heating devices indoors.

Keep certain air tightness indoors, try not to use electrical appliance with large quantity of heat

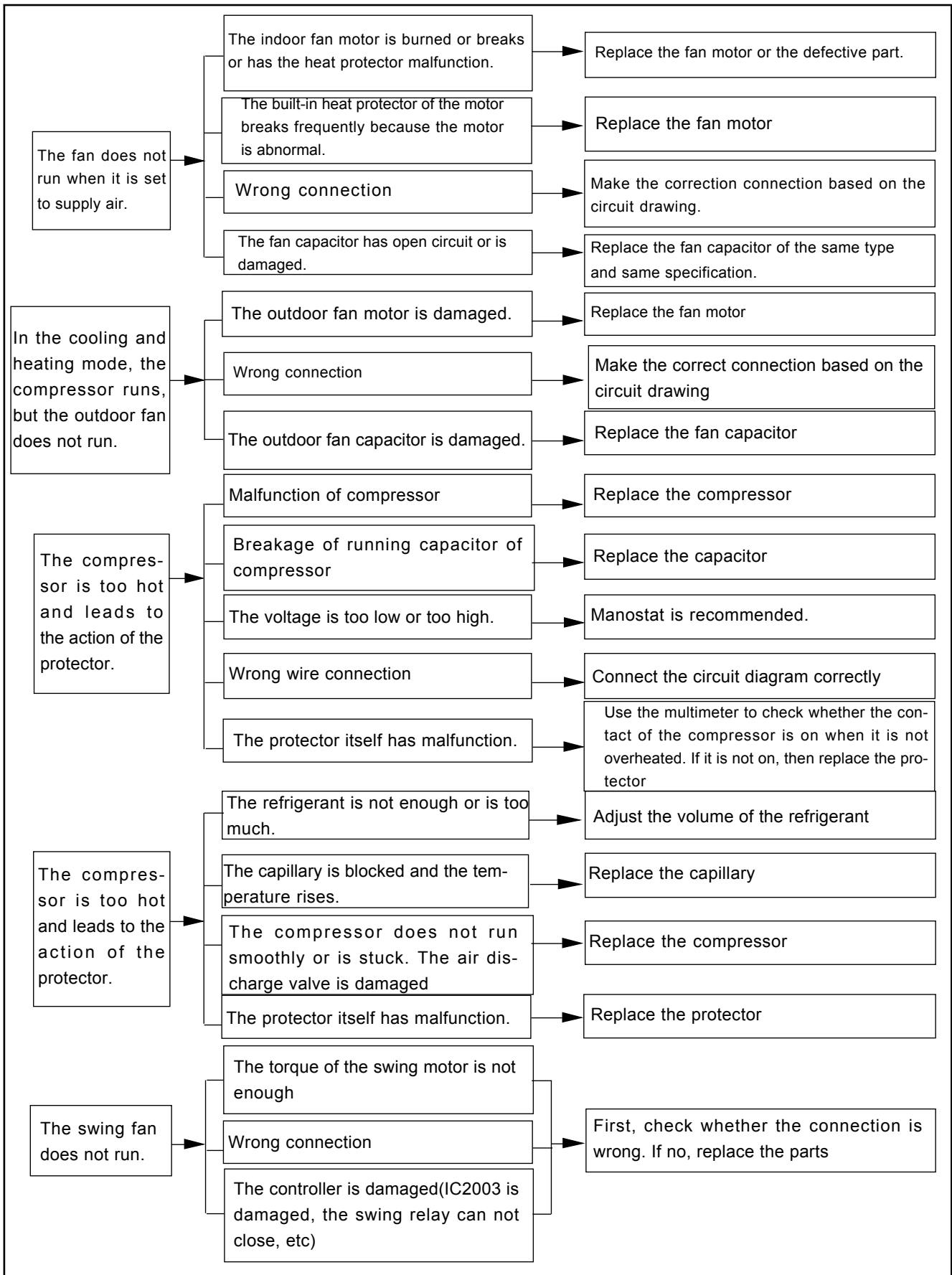

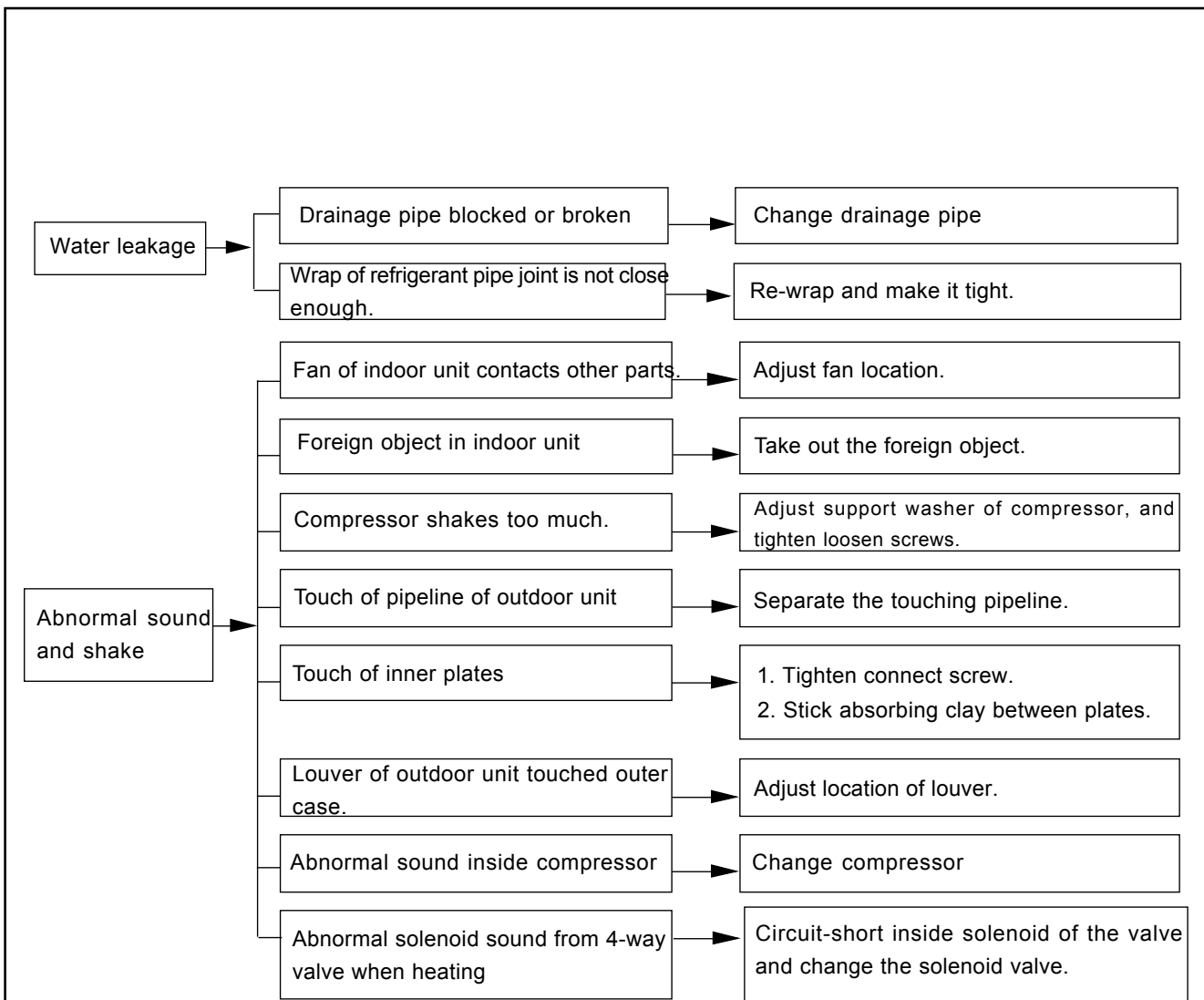

There are no heating malfunctions in the above for the cooling only unit.

PG motor locked protection H6:

Probable reasons:

1. Air vents were blocked which may cause the fan speed is too slow;
2. Fan blade locked;
3. Motor locked;
4. Fan motor capacitor damaged;
5. Motor damaged (orders, winding, open circuit or shortcircuit are not normal, when testing the winding, pls distinguish whether the motor body cause temperature is too high so that bring on the thermal protector starts up)
6. IC board damaged (during normally running, there are voltage at both capacity input and output)
7. Mainboard damaged.
8. Motor thermal protection.

Disposal methods:

1. Remove the obstruction;
2. Reassembling;
3. Replace motor;
4. Replace capacitor;
5. Replace motor;
6. Replace circuit board;
7. Replace mainboard;

8. Under the normal circumstances, the motor will not act, but in other circumstances, such as evaporator is very dirty, too much dust attached on the fan blade that will cause the motor overload running, so that during the operation, frequent thermal protection will happen, so it is need to be cleaned or replaced.

PARTS GUIDE

KING SERIES

ASH-09AK, ASH-13AK



Contents

04.....	ASH-09AK Indoor unit
06.....	ASH-13AK Indoor unit
08.....	ASH-09AK Outdoor unit
10.....	ASH-13AK Outdoor unit

Explosive view and spare parts list of indoor unit

ASH-09AK

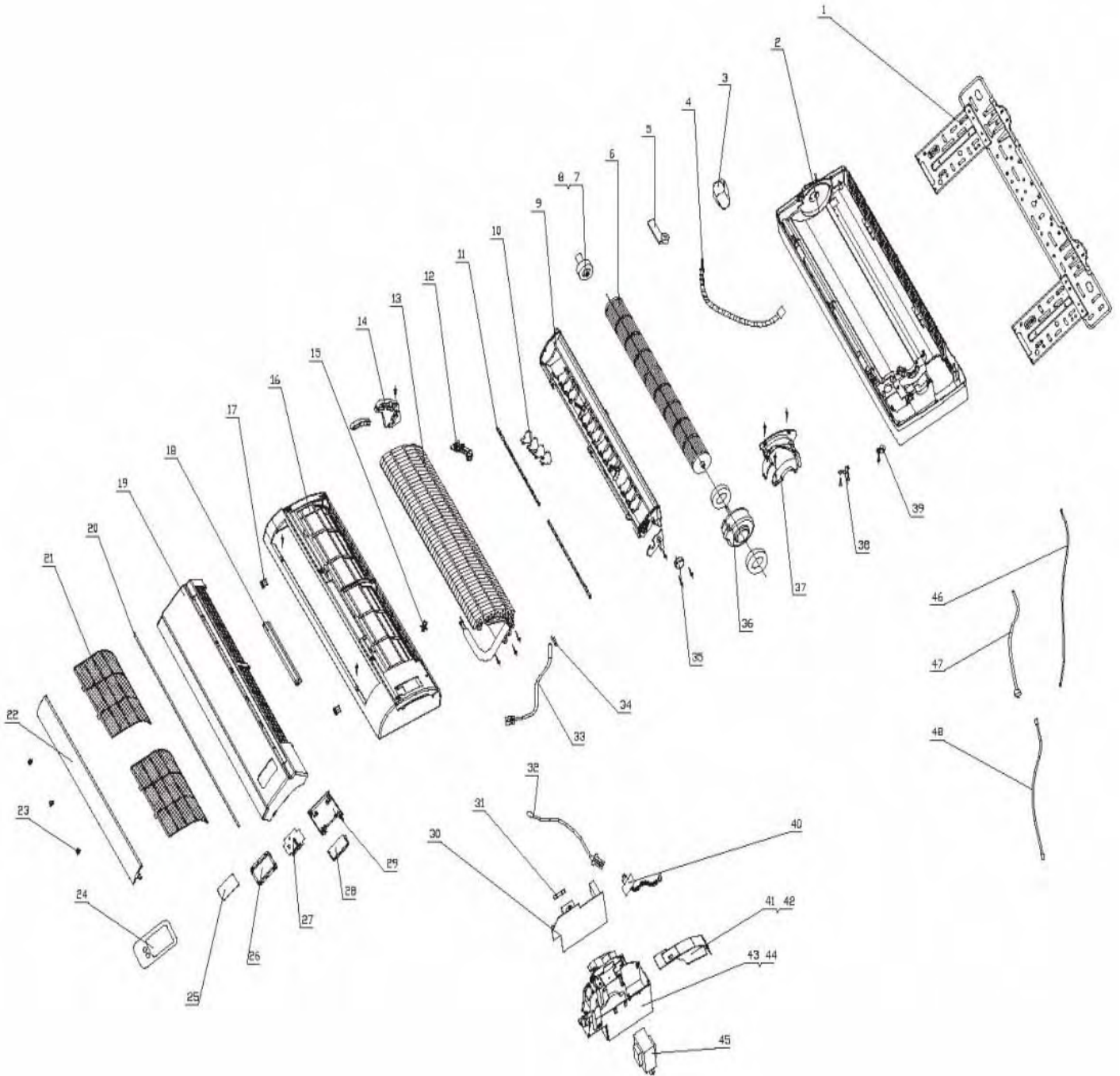

No.	Description	Part Code	Updated		Qty	Price Rank
			Part code	Date		
ASH-09AK Indoor Unit						
1	Wall-Mounting Frame	01252220			1	
2	Rear Case	222020572			1	
3	Evaporator Pipe Cover	06122001			1	
4	Drainage Pipe	05230014			1	
5	Pipe Clamp	24242004			1	
6	Cross Flow Fan	10352001			1	
7	Fan Bearing	/			1	
8	Ring of Bearing	76512203			1	
9	Water Tray	2018205201			1	
10	Swing Louver	10512079			12	
11	Swing link	10582052			1	
12	Manual Lever	10582027			2	
13	Evaporator Assy	010021276			1	
14	Evaporator Support	24212058			1	
15	Cable clamp	71010002			1	
16	Front Case	2000298601S			1	
17	Screw Cover	242520042			2	
18	Decorating board	20192041			1	
19	Front Panel	200025781			1	
20	Border of front lid	20192042			1	
21	Filter	11122002			2	
22	Guide Louver	105120782			1	
23	Guide Louver Bearing	10542011			3	
24	Remote Controller	30510041			1	
25	Magic mirror	68014004			1	
26	Decorating ring	20192028			1	
27	Display board	30540016			1	
28	Protect board	26112102			1	
29	Cover plate	22242056			1	
30	Main PCB	30135070			1	
31	Fuse 3.15A 250VAC	46010014			1	
32	Room Sensor	390001912			1	
33	Tube Sensor	390000591			1	
34	Sensor insert	42020063			1	
35	Stepping Motor MP28EA	15212002			1	
36	Motor FN20E-PG	150120761			1	
37	Motor Clamp	26112080			1	
38	Wire Clip	26112082			1	
39	Wire Clamp	26112121			1	
40	Receiver Board (5bit)	42010262			1	
41	Electric Box Cover	20112015			1	
42	Cover of shielding case	01592054			1	
43	Electric Box	20112017			1	
44	Shielding case	01592008			1	
45	Transformer 41X26.5E	43110231			1	
46	Connecting Cable	40020536			1	
47	Power Cord	400220111			1	
48	Connecting Cable	40020540			1	

The data are subject to change without notice.

Explosive view and spare parts list of indoor unit

ASH-13AK

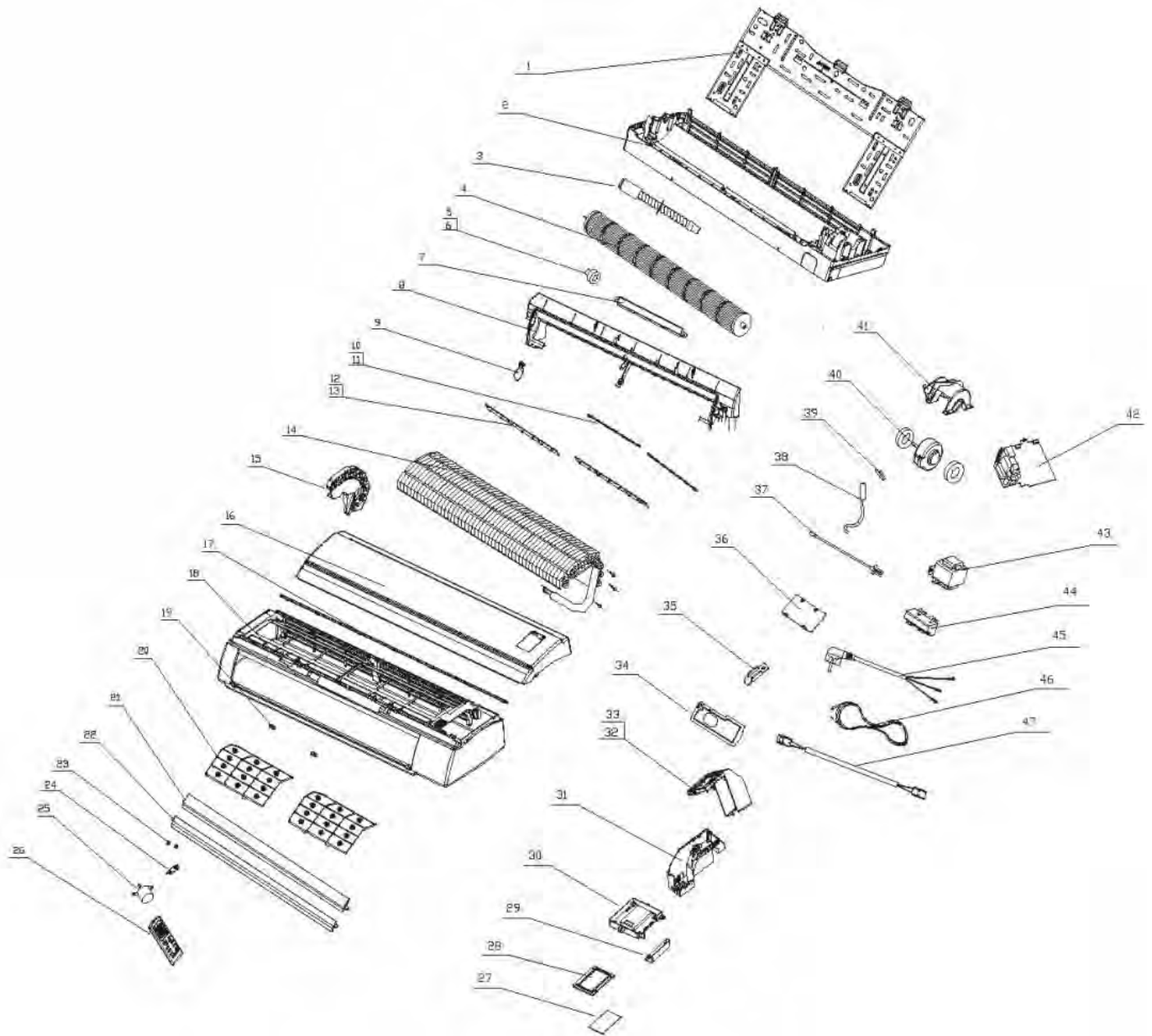

No.	Description	Part Code	Updated		Qty	Price Rank
			Part code	Date		
ASH-13AK Indoor Unit						
1	Wall-Mounting Frame	0125221701			1	
2	Rear Case	22202451			1	
3	Drainage Pipe	05230014			1	
4	Cross Flow Fan	10352012			1	
5	Fan Bearing	76512210			1	
6	Ring of Bearing	76512206			1	
7	Decoration Plate	20192023			1	
8	Water Tray	201824263			1	
9	Swing Louver	10512110			14	
10	Left Linkage Lever	10582045			1	
11	Right Linkage Lever	10582017			1	
12	Left Louver Support	/			1	
13	Right Louver Support	/			1	
14	Evaporator Assy	010022152			1	
15	Left Evaporator Support	24212023			1	
16	Front Panel	20002580			1	
17	Border of front lid	20192044			1	
18	Front Case	20012022			1	
19	Screw Cover	242520053			2	
20	Filter Assy	11120019			2	
21	Guide Louver	261120393			1	
22	Lower Guide Louver	261120403			1	
23	Mid Bearing	10542001			2	
24	Left Bearing	10542002			1	
25	Motor MP24AA	15212108			1	
26	Remote Controller YB1FA	30510041			1	
27	Magic mirror	68012046			1	
28	Decoration Frame	20192031			1	
29	Display Cover	22244060			1	
30	Display	30540010			1	
31	Electric Box	20102378			1	
32	Electric Box Cover	2010237901S			1	
33	Shielding Box Sub-assy	01592053			1	
34	Covering Plate	22242073			1	
35	Wire Clamp	71010002			1	
36	Rear Pipe Cover	26112035			1	
37	Room Sensor	390000451			1	
38	Tube Sensor	390000591			1	
39	Sensor Insert	42020063			1	
40	Motor FN9D-PG	15012072			1	
41	Right Support of Evaporator	24212024			1	
42	Main PCB	30135054			1	
43	Transformer	43110236			1	
44	Terminal board (5bit)	42010262			1	
45	Power Cord	400220112			1	
46	Connecting Cable	400205401			1	
47	Signal Cable	40020536			1	

The data are subject to change without notice.

Explosive view and spare parts list of outdoor unit

ASH-09AK

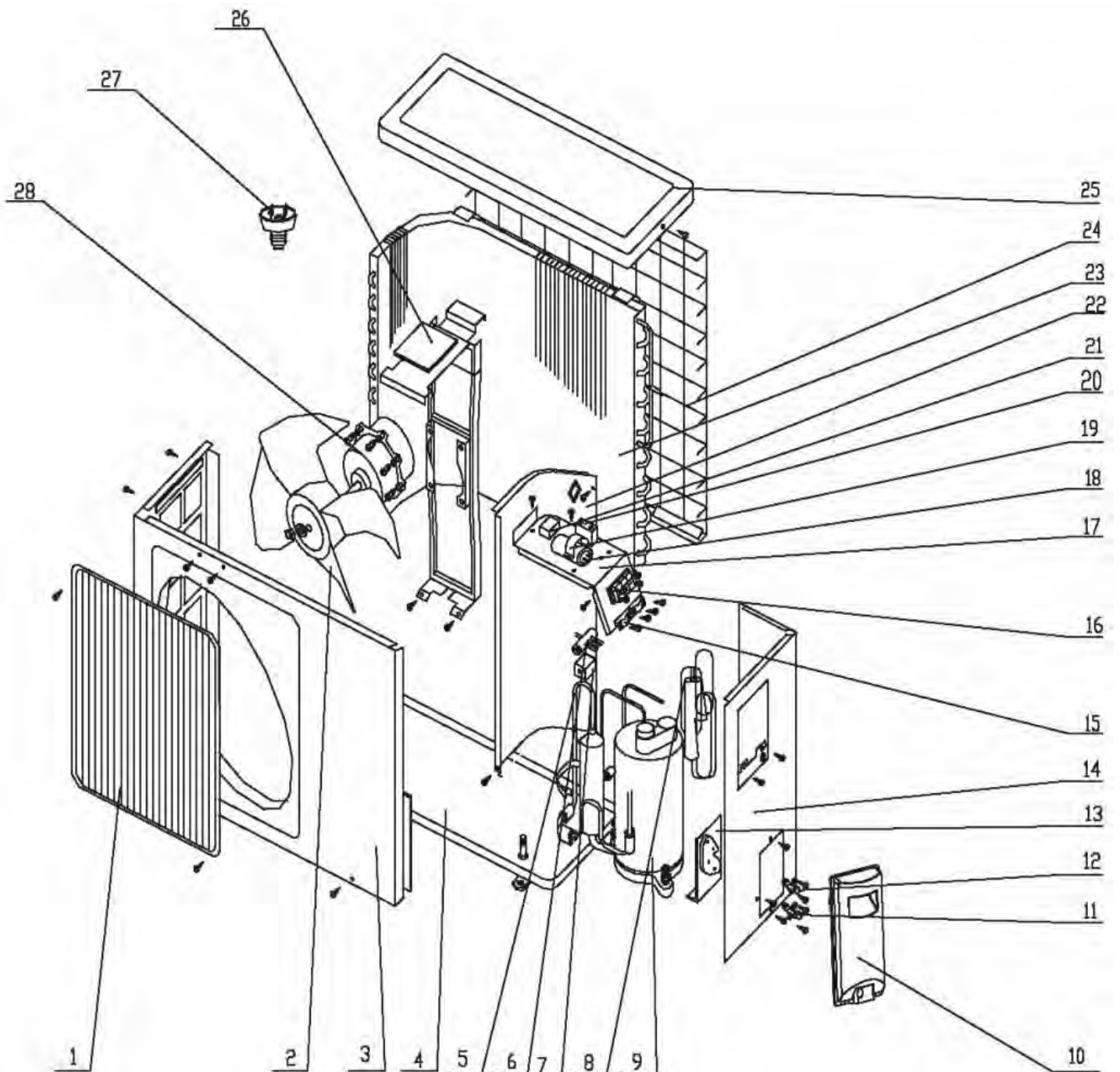

No.	Description	Part Code	Updated		Qty	Price Rank
			Part code	Date		
ASH-09AK - Outdoor Unit						
1	Front Grill	22413431			1	
2	Axial Flow Fan	10333004			1	
3	Front Plate	01533012			1	
4	Metal Base	01203622P			1	
5	4-way rever -sing valve compon	03023792			1	
6	4-way valve	43000402			1	
7	4-way valve coil	43000400			1	
8	Capillary Assy	030036883			1	
9	Compressor ASG102CV-B7AT	00100423			1	
10	Handle	26233433			1	
11	Valve	07100005			1	
12	Valve	07100003			1	
13	Valve Support	01713041			1	
14	Right Side Plate	01302004			1	
15	Wire Clamp	71010103			1	
16	Terminal Board (four bit)	42010265			1	
17	Electric Plate	01403861			1	
18	Comp Capacitor	33010743			1	
19	Capacitor Clamp	02143401			1	
20	Fan Capacitor	33010025			1	
21	Terminal Board (1bit)	42011147			1	
22	Isolation Sheet Assy	01233417			1	
23	Condenser Assy	0110395701			1	
24	Rear Grill	11123205			1	
25	Top Cover	01253443			1	
26	Motor Support	01703053			1	
27	Drainage Connector	06123401			1	
28	Motor FW30K	150130671			1	

The data are subject to change without notice.

Explosive view and spare parts list of outdoor unit

ASH-13AK

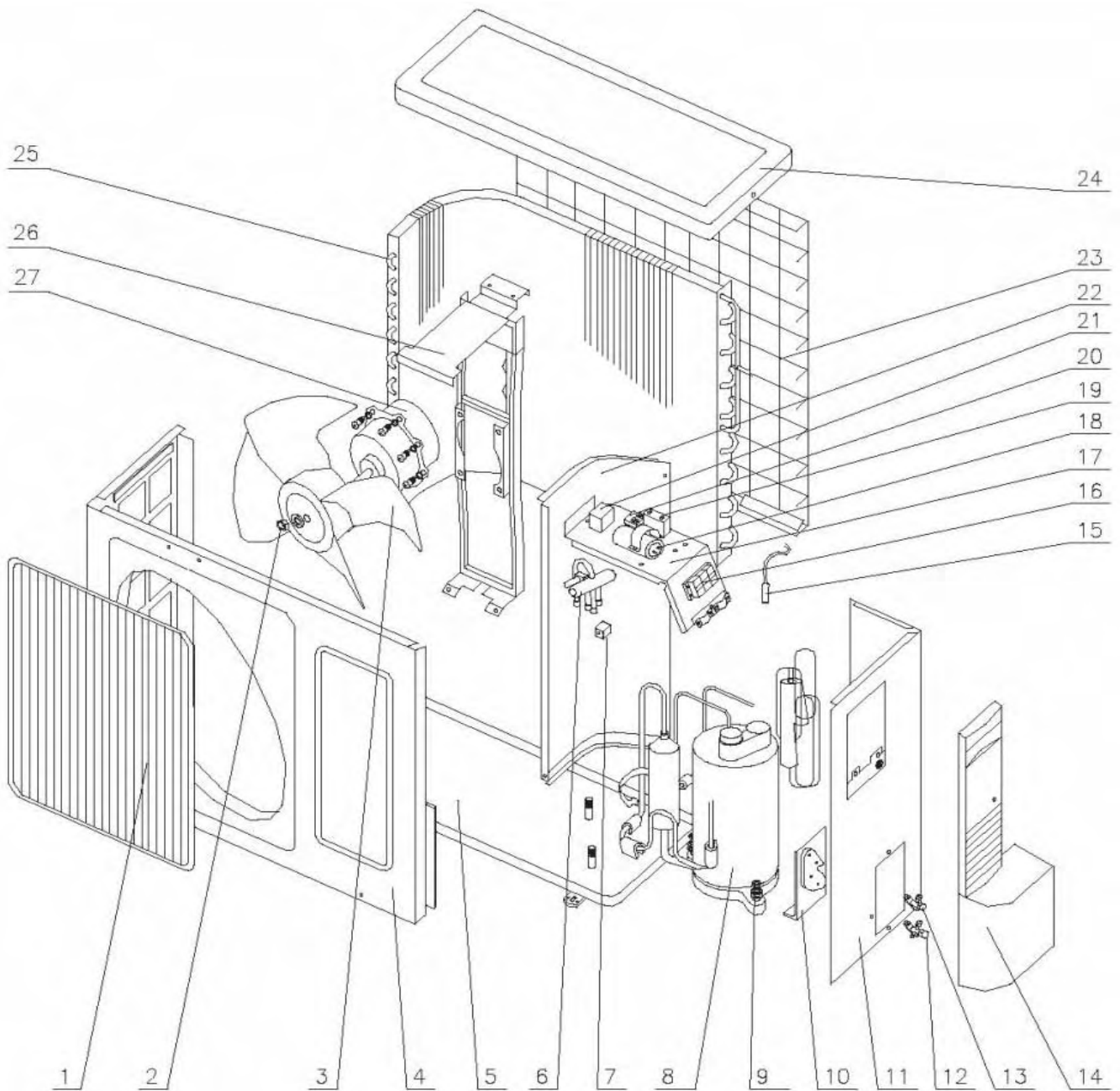

No.	Description	Part Code	Updated		Qty	Price Rank
			Part code	Date		
ASH-13AK - Outdoor Unit						
1	Front Grill	22413431			1	
2	Nut M6	70310131			1	
3	Axial Flow Fan	10333004			1	
4	Front Plate	01533012			1	
5	Metal Base	012032292			1	
6	4-way Valve	430004032			1	
7	4-way Valve Coil	43000400			1	
8	Compressor QXA-133uB030	00120223			1	
	Overload Protector	built in			1	
	Compressor Gasket	自			3	
9	Nut with Washer M8	70310011			3	
10	Valve Support	01713041			1	
11	Right Side Plate	0130304801			1	
12	Valve 1/4"	07100003			1	
13	Valve 1/2"	07100006			1	
14	Handle	26233433			1	
15	Tube Sensor	None			/	
16	Terminal Board	42010265			1	
17	Electric Plate Assy	01403117			1	
18	Capacitor	33000018			1	
19	Capacitor	33010025			1	
20	Terminal Board (1)	42011147			1	
21	AC Contactor	None			/	
22	Isolation Sheet	01233417			1	
23	Rear Grill	11123205			1	
24	Top cover plate	01253443			1	
25	Condenser Assy	0110348412			1	
26	Motor Support	01703020			1	
27	Motor FW25K	15013067			1	

The data are subject to change without notice.