

Simplicity®

OPERATOR'S MANUAL FOR SYSTEM 9000 LOADER

**Product Number 1690157 — Loader — 1690158 — 48" Material Bucket
FOR 4040, 4041, POW'R MAX & SYSTEM 9020 TRACTORS**

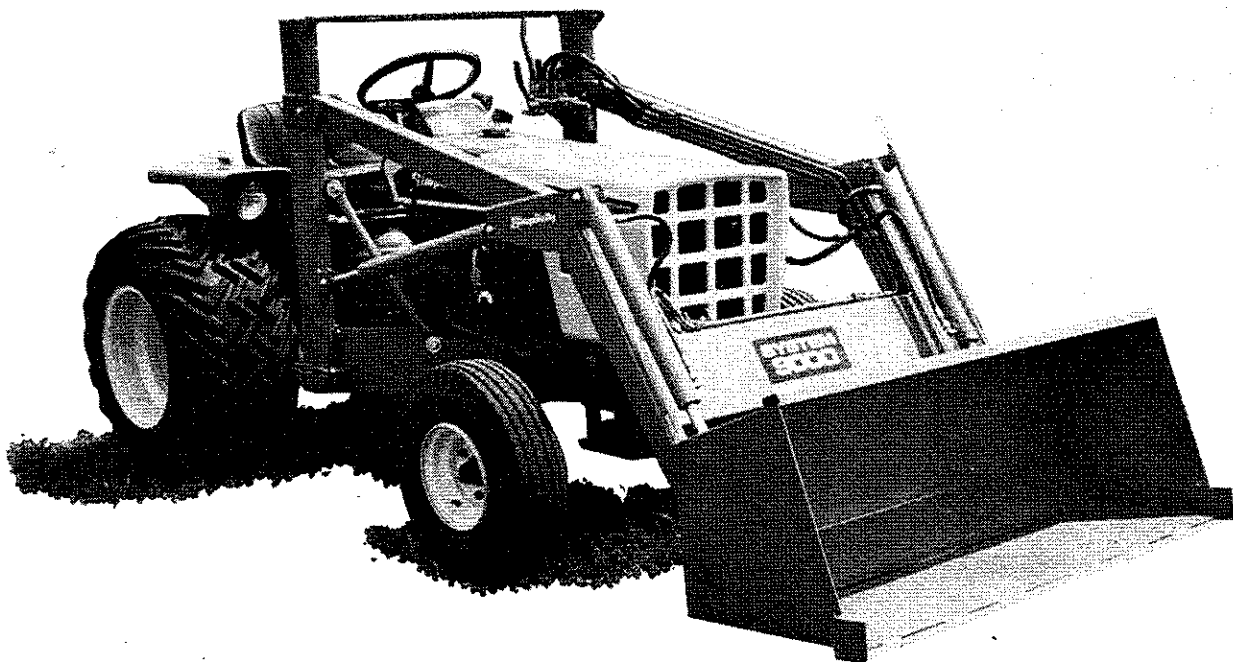

**MANUFACTURED BY ARK MANUFACTURING CO., INC.
P. O. BOX 327 • STERLING, KANSAS 67579 • (316)278-3641**

TP - 1380

DEALERS PRE-DELIVERY CHECK LIST

SYSTEM 9000 LOADER

OWNERS NAME _____

LOADER SERIAL NO. _____

ADDRESS _____

DELIVERY DATE _____

PHONE _____

The following Pre-Delivery Service has been completed by your Simplicity Dealer. It is his responsibility to perform each item on the Pre-Delivery Check List.

- Tractor Hydraulic oil level checked (oil added if necessary.)
Refer to Hydraulic System Oil Level section of this manual.
- High capacity front tires are required. Calcium chloride and water filled high flotation or agricultural rear tires plus two sets of rear wheel weights or counter weight is recommended for proper operation. Inflate the front tires to the manufacturers recommended inflation pressure.
- Lubricate all grease fittings.

EXPLAIN THE FUNCTION, SAFE OPERATION AND ADJUSTMENTS OF THE ITEMS LISTED BELOW TO THE CUSTOMER:

- | | |
|--|---|
| <input type="checkbox"/> Tractor wheel tread - tire inflation pressure | <input type="checkbox"/> Operators Safety Precautions |
| <input type="checkbox"/> Tractor hydraulic system - controls | <input type="checkbox"/> Hydraulic system oil level |
| <input type="checkbox"/> Loader removal | <input type="checkbox"/> Buckets and blades |
| <input type="checkbox"/> Loader Installation | <input type="checkbox"/> Lubrication |
| | <input type="checkbox"/> Storage |

YOUR LOADER HAS BEEN SET UP, ADJUSTED AND SERVICED BY YOUR DEALER PRIOR TO ITS DELIVERY TO YOU.

DEALERS SIGNATURE _____



BE CAREFUL

1. KEEP ALL SHIELDS IN PLACE.
2. STOP MACHINE TO ADJUST AND OIL.
3. WHEN MECHANISM BECOMES CLOGGED, DISENGAGE POWER BEFORE CLEANING.
4. KEEP HANDS, FEET AND CLOTHING AWAY FROM POWER-DRIVEN PARTS.
5. KEEP OFF IMPLEMENT UNLESS SEAT OR PLATFORM IS PROVIDED.
6. KEEP OTHERS OFF.

BE A SAFE OPERATOR

AVOID ACCIDENTS

Most accidents, whether they occur in industry, on the farm, at home, or on the highway, are caused by the failure of some individual to follow simple and fundamental safety rules or precautions. For this reason most accidents can be prevented by recognizing the real cause and doing something about it before the accident occurs.

Regardless of the care used in the design and construction of any type of equipment, there are many conditions that can not be completely safe guarded against without interfering with reasonable accessibility and efficient operation.

A CAREFUL OPERATOR IS THE BEST INSURANCE AGAINST AN ACCIDENT.

THE COMPLETE OBSERVANCE OF ONE SIMPLE RULE WOULD PREVENT MANY THOUSAND SERIOUS INJURIES EACH YEAR. THAT RULE IS:

NEVER ATTEMPT TO CLEAN, OIL, OR ADJUST A MACHINE WHILE IT IS IN MOTION!

TABLE OF CONTENTS

| | Page(s) |
|---|---------|
| Customer Information | |
| Hydraulic Adapter Description and Locator | 11 |
| Hydraulic Hose Locator | 11 |
| Installation Instructions | 8-11 |
| Operation of Loader | 10-11 |
| Parts List | 6-7 |
| Pre-Delivery Record | 2 |
| Safety Precautions | 3, 5 |
| Service Parts and Warranty Claims | 4 |
| Specifications | 5 |
| Dealer Information | |
| Pre-Delivery Record | 2 |



**ATTENTION! BECOME ALERT!
YOUR SAFETY IS INVOLVED!**



This symbol is used to call your attention to safety precautions that should be followed by the operator to avoid accidents. When you see this emblem – Heed Its Warning.

LIMITED WARRANTY

It is hereby expressly warranted by **ARK Manufacturing Co., Inc., (ARK)** that all **ARK** products sold by Simplicity Manufacturing Company (Simplicity) are free of defects in workmanship and material at time of shipment from **ARK's** factory. **ARK** will repair or replace, without charge, any part which under normal use and service fails to conform to this warranty, provided that such parts shall be returned to **ARK's** authorized dealer, transportation charges prepaid, within 12 months from the date of delivery of such new product to the first user.

Parts installed by an authorized dealer, including parts furnished under this warranty, are warranted to be free from defects in workmanship and material for 90 days from the date of installation of such parts or to the expiration of the original warranty, whichever is later. **ARK** will repair or replace, without charge, any part not conforming to this warranty. Services performed and parts obtained free of charge under the terms of this warranty must be obtained at any authorized Simplicity Dealer.

This warranty is not made by **ARK** nor shall it be imposed upon **ARK** with respect to (1) new products which have been subject to operations in excess of recommended capacities, misuse, negligence, or accident, or have been altered or repaired in any manner not authorized by **ARK**, or damage or malfunction due to failure to provide reasonable and necessary maintenance; or, (2) components manufactured by other manufacturers that are warranted by their respective manufacturers except that **ARK** agrees to make available to the first user whatever warranty benefits may be made available to **ARK** by such manufacturer, which includes hydraulic pumps, control valves, hoses, cylinders and drive belts.

ARK's liability arising out of this express warranty shall be limited exclusively to repair or replacing parts under the conditions as aforesaid, and **ARK** shall in no event be liable for consequential damages arising out of any breach of this express warranty. Any implied warranty of merchantability or implied warranty of fitness for a particular purpose relating to **ARK's** products which arises under state law is hereby expressly limited in duration to twelve (12) months from the date of delivery of a new **ARK** product to the first user. Any exclusion or limitation of warranties or liability contained herein which is prohibited by any applicable law or regulation shall be void and of no effect.

All service parts, orders and Warranty Claims should be sent directly to **ARK Manufacturing Co., Inc., P. O. Box 327, Sterling, Kansas 67579.** Simplicity's standard warranty form and authorized warranty labor rates will be honored by **ARK Manufacturing Co., Inc.**

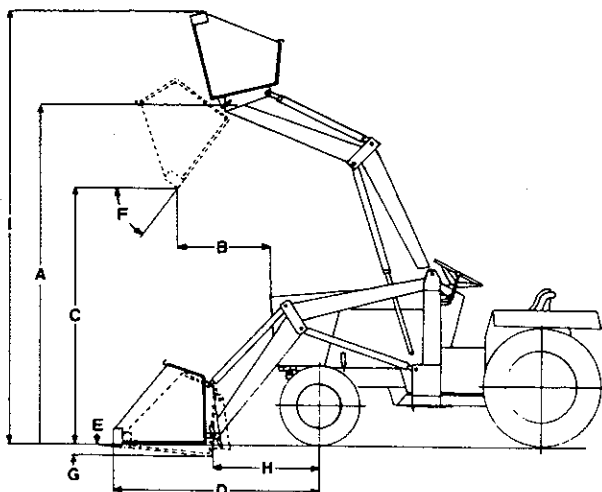

SPECIFICATIONS for SYSTEM 9000 LOADER

| | | |
|---|---------------------------------------|----------------|
| A | Height to Bucket Hinge Pin (MAX) | 86½ Inches |
| B | Reach @ Maximum Height, Bucket Dumped | 23½ Inches |
| C | Clearance, Bucket Dumped | 69 Inches |
| D | Reach Bucket on Ground | 51½ Inches |
| E | Bucket Rollback | 8 Degrees |
| F | Maximum Dumping Angle | 43 Degrees |
| G | Digging Depth | 3¾ Inches |
| H | Reach from Axle to Bucket Hinge Pin | 30 Inches |
| I | Overall Maximum Height Raised | 107½ Inches |
| | Lift Capacity | 650 Pounds |
| | Hydraulic System | 1250 PSI |
| | 48" Material Bucket Capacity | 6.7 Cubic Feet |

Specifications subject to change without notice.



SAFETY PRECAUTIONS



1. Loader may affect the stability of the tractor.
2. Never raise the bucket to extreme height on steep inclines.
3. Do not pivot or turn the tractor sharply at high speed when the bucket is over 20' from the ground.
4. In transport, carry loaded bucket low and accelerate tractor with care.
5. Do not raise the bucket to full height under low clearance barns, sheds, etc.
6. Watch out that bucket does not interfere with low hung power lines, etc.
7. Use care on turns due to the extra length which increases the turning radius needed.
8. When raising the bucket to extreme height with a load in it, tilt the bucket so that the load will not spill on the operator.
9. Keep the tractor on solid footing. Loose fill, rocks, holes, etc., do not permit safe operation.
10. Do not try to load the bucket at high speed or full tractor power.
11. Do not leave the loader in a raised position. The only time the bucket should be raised is when a load is being dumped.
12. High capacity front tires are required. Calcium chloride and water filled high flotation or agricultural rear tires plus two sets of rear wheel weights or counter weight is recommended for proper operation.
13. Do not operate loader unless hydraulic pump is running.
14. Before servicing or adjusting the loader,
 - (A) Lower working unit to the ground,
 - (B) Disengage power and shut off engine, and
 - (B) Relieve hydraulic pressure before disconnecting oil line.
15. It is recommended that the tightness of all bolts be checked frequently for proper operation of loader.

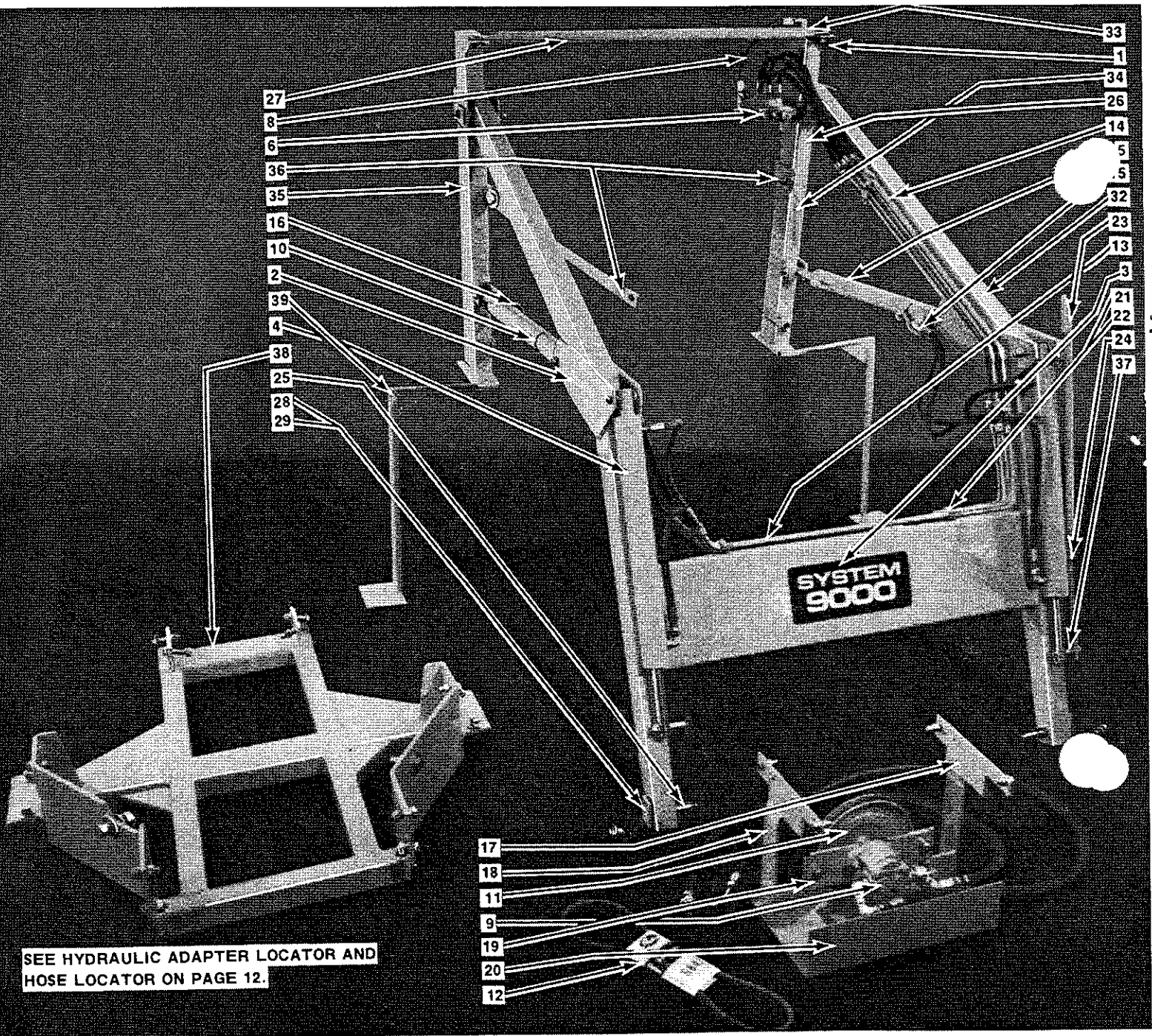

BOLTS REQUIRED

| NO REQ. | SIZE | | |
|------------|----------------------------------|----|----------------------------------|
| 1 | 3/16" x 2" Cotter Pins | 14 | 3/8" Lock Washers |
| 1 | 1/4" x 1/2" Stove Bolts | 9 | 3/8" Flat Washers |
| 2 | 1/4" x 2" Grade 2 Cap Screws | 1 | 1/2" x 1" Grade 2 Cap Screws |
| 2 | 1/4" Plain Nuts | 50 | 1/2" x 1 1/2" Grade 5 Cap Screws |
| 2 | 1/4" Lock Washers | 4 | 1/2" x 2 1/4" Grade 5 Cap Screws |
| 2 | 5/16" x 1" Grade 5 Cap Screws | 14 | 1/2" Plain Nuts |
| 2 | 5/16" Plain Nuts | 15 | 1/2" Lock Washers |
| 2 | 5/16" Lock Washers | 15 | 1/2" Flat Washers |
| 2 | 5/16" Flat Washers | 1 | 1/2" x 2" Grade 2 Cap Screw |
| 4 | 3/8" x 3/4" Grade 5 Cap Screws | 6 | 1/2" x 2 1/2" Clevis Pins |
| 5 | 3/8" x 1" Grade 5 Cap Screws | 2 | 1/2" x 3" Clevis Pins |
| 5 | 3/8" x 1 1/4" Grade 5 Cap Screws | 2 | 5/8" x 1 1/2" Grade 5 Cap Screws |
| 1 | 3/8" x 2" All Thread Grade 2 | 2 | 5/8" x 2 1/4" Grade 5 Cap Screws |
| 12 | 3/8" Plain Nuts | 4 | 5/8" Plain Nuts |
| | | 4 | 5/8" Lock Washers |
| | | 8 | 5/8" Flat Washers |
| | | 8 | #3 Hairpins |

**PARTS LIST
FOR
SYSTEM 9000 LOADER**

| ITEM NO. | NO. REQ. | PART NAME | PART NO. |
|----------|----------|-----------------------------|----------------------|
| 1. | 1 | Caution Decal | 20001 |
| 2. | 2 | Simplicity Decals | 20014 |
| 3. | 1 | System 9000 Decal | 20020 |
| 4. | 2 | Tilt Cylinders | 21005 |
| 5. | 2 | Lift Cylinders | 21006 |
| 6. | 1 | Control Valve | 22001 |
| 7. | 2 | Handle Linkage | 22003 - Not shown |
| 8. | 2 | Valve Handles | 22020 |
| 9. | 1 | Pump | 23001.1 |
| 10. | 2 | Hose Clamps | 23042 |
| 11. | 1 | Pulley | 23091 |
| 12. | 1 | Gates V-Belt 6842 | 23092 |
| 13. | 4 | Hydraulic Lines | 23705 |
| 14. | 4 | Hydraulic Lines | 230915 |
| 15. | 1 | Cylinder Hydraulic Line | 23709-L |
| 16. | 1 | Cylinder Hydraulic Line | 23709-R |
| 17. | 1 | Left Pump Mounting Bracket | 230924-L |
| 18. | 1 | Right Pump Mounting Bracket | 230924-R |
| 19. | 1 | Pump Mounting Plate | 230928 |
| 20. | 1 | Pump Guard | 230930 |
| 21. | 3 | Hydraulic Line Brackets | 24027 |
| 22. | 3 | Hydraulic Line Brackets | 24028 |
| 23. | 1 | Bucket Guide Tube | 24036 |
| 24. | 1 | Bucket Guide Rod | 24039 |
| 25. | 4 | Grease Fittings | 24043 |
| 26. | 3 | Foam Cushions | 24044-Not Shown |
| 27. | 1 | Stabilizer Bar | 24052 |
| 28. | 4 | Lift Frame Pins | 24053 |
| 29. | 4 | Lift Frame Pin Bushings | 24055 |
| 30. | 1 | Hose Bracket | 24056 - See Figure 4 |
| 31. | 1 | Hose Bracket Bushing | 24057 - See Figure 4 |
| 32. | 1 | Lift Frame Assembly | 24906 |
| 33. | 1 | Breather Cap | 25009 |
| 34. | 1 | Left Upright Assembly | 250932-L |
| 35. | 1 | Right Upright Assembly | 250932-R |
| 36. | 2 | Upright Braces | 260913 |
| 37. | 1 | Spacer Bushing | 27059 |
| 38. | 1 | Under Frame | 270950 |
| 39. | 2 | Dismount Stands | 28510 |

INSTALLATION

Your new loader has been assembled at the factory as far as it is possible to be assembled so that you will have a minimum of installation; however, these instructions should be read carefully before starting and thereafter followed step by step.

Make sure that the loader is in front of the tractor so that at the proper time the tractor can be driven into the lift frame assembly for final installation. You should make sure that ample working area is around your tractor so that you will not be cramped for working space.

It is suggested that you first remove all the shipping carton from around the loader so that all parts can be readily seen. Where reference is made to left or right side, this is determined by sitting on the tractor seat.

You should have the following tools at hand:

- 2 - 1/2" Open End or Box End Wrench
- 2 - 9/16" Open End or Box End Wrench
- 1 - 11/16" Open End or Box End Wrench
- 1 - 5/8" Open End or Box End Wrench
- 2 - 3/4" Open End or Box End Wrench
- 2 - 15/16" Open End or Box End Wrench
- 1 - 5/32" Allen Wrench
- 1 - Medium Size Crescent Wrench
- 1 - Standard Screw Driver
- A set of Socket Wrenches if available.

At this time unpack and lay aside all assemblies except the under frame and lift frame.

BUCKET INSTALLATION

Remove the shipping clamps from the lift frame and leave lift frame in position on pallet. Next, remove the bucket from its shipping container and locate the mounting brackets over the front mounting bushings on the front of the lift frame. At this time the mounting brackets on the bucket should be resting on the pallet as in Figure 1.

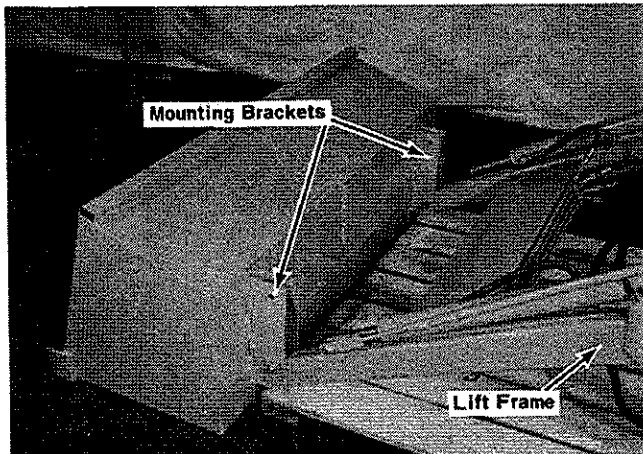

FIGURE 1

Insert lift frame pins and lock in place with bushing, 3/8" x 3/4" bolt, FW and LW. At this time connect the tilt cylinders and bucket guide assembly to the top holes in the bucket mounting bracket.

UPRIGHT INSTALLATION

Next install the Left and Right Uprights P/N 250932 L & R to the lift frame and install lift frame pins and lock into place with bushing, 3/8" x 3/4" bolt, flat washer (FW) & lockwasher (LW). Attach the two lift cylinders to the uprights with the pins provided, and then install the Stabilizer Bar P/N 24052 with two (2) 3/8" x 1" bolts, LW, FW & nuts. Remove the Under Frame P/N 270950 from the pallet and then insert a dismount stand into each bushing on the front edge of each upright base with the base of the dismount stands towards the front. Then lift the whole assembly up until the unit is resting on the stands, Figure 2, and then remove the pallet from the area.

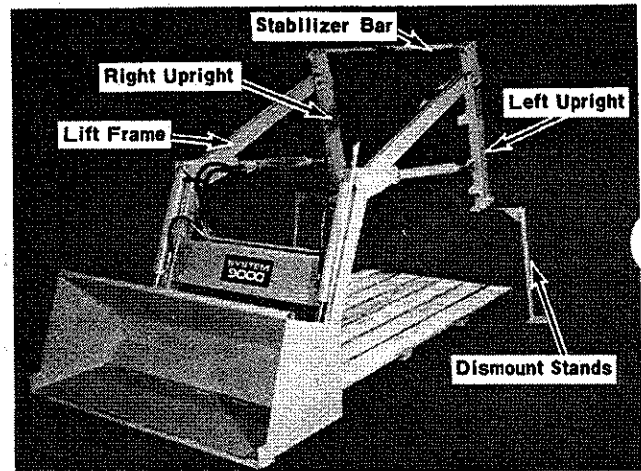

FIGURE 2

PUMP MOUNTING INSTALLATION

At this time raise tractor hood and disconnect the two (2) springs holding the battery cover down. Remove one (1) 5/16" x 1/2" bolt holding ground wires on the right side. Remove one (1) 3/8" x 5/8" bolt holding hydraulic line bracket on left side. Now, remove the pump guard from the pump assembly and also remove the nuts, bolts and lock washers located on the top of each pump mounting bracket. With the hood still in the raised position, place the pump assembly up to the tractor as shown in Figure 3.

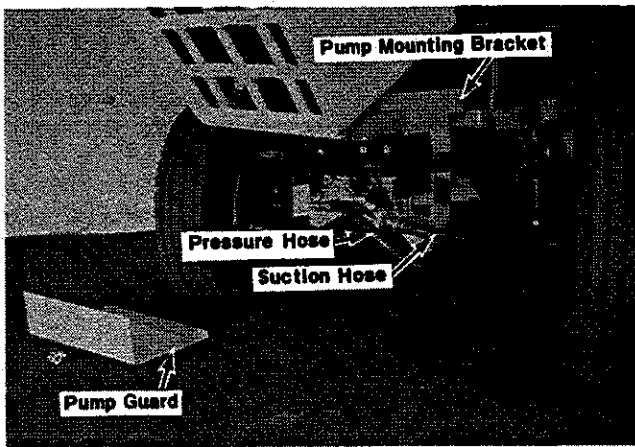

FIGURE 3

Once in place insert bolts and install lock washers and nuts previously removed from the pump assembly and tighten securely. Re-install the ground wires and springs holding the battery cover. Loosen the 3/8" x 2" belt tightener bolt so that the pump mounting plate will have freedom of movement up and down and then from the top install the V-belt, P/N 23092 over the tractor P.T.O. pulley and then install V-belt on the pump pulley. Figure 4.

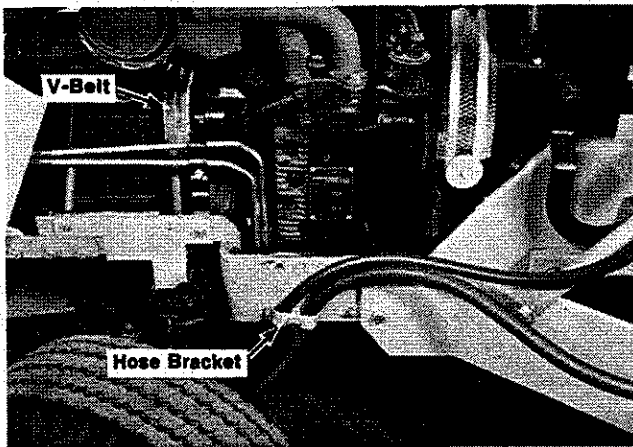

FIGURE 4

Alignment of pump pulley with P.T.O. pulley can be obtained by loosening the set screws on pump pulley and sliding to desired position on the pump shaft. Be careful to leave clearance between the pulley and the pump housing. Tighten set screws and then tighten the belt with the belt tightener screw. **Do not over-tighten. Do not install pump guard at this time.**

UNDER FRAME INSTALLATION

The under frame, P/N 270950, for this heavy duty loader is the most difficult part to install for one person, however, it can be done. First, remove the lower brackets to which the three point hitch is mounted. Then remove all bolts, LW, FW & nuts from under frame and position the under frame under the tractor so that from the rear of the tractor you can lay on your back and lift the frame into position by getting your arm and elbow directly under to support while installing on either side

in the rear slotted hole, one (1) 1/2" x 2 1/4" bolt, LW & FW. Give bolt three or four turns so that it will stay. Next, install one (1) 1/2" x 2 1/4" bolt, LW & FW on the other side and at the same time reinstall on this side the three point hitch bracket previously removed, but do not install the other bracket at this time. Give this bolt three or four turns. At this time the under frame will appear as shown in Figure 5 and Figure 6.

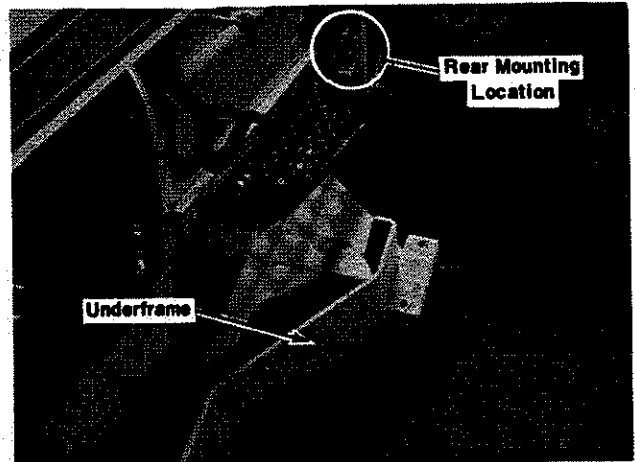

FIGURE 5

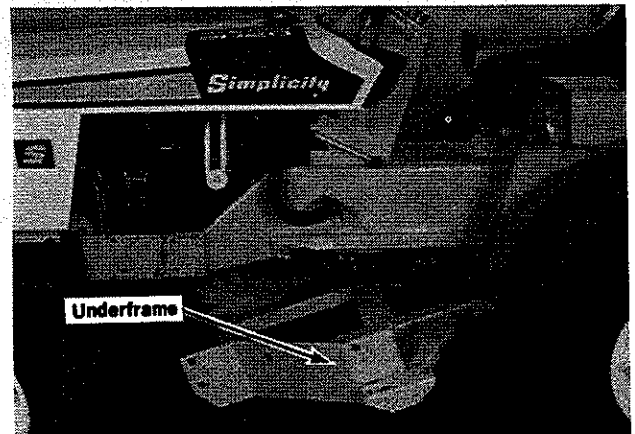

FIGURE 6

Next, turn wheels to the extreme right position and move to left or right side of tractor. Raise the front of the under frame to its full position and install the 1/2" x 1 1/2" bolt, LW & FW on both sides. (Note: Due to paint on both the tractor and under frame this may be a tight fit.) Next, reinstall the other three point hitch bracket and the remaining bolts, LW & FW in the rear of the under frame. When under frame installation is complete it will appear as in Figure 7.

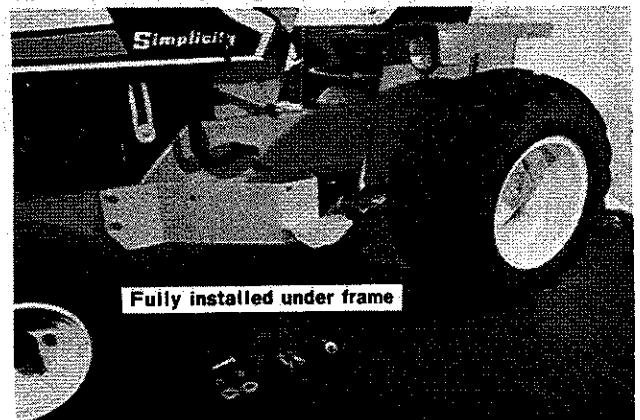

FIGURE 7

(Note: If two persons are available it is easier to start the under frame installation from the front end with one person on each side of the tractor.)
Tighten all bolts securely at this time.

LIFT FRAME INSTALLATION

With the under frame securely installed drive the tractor into the lift frame assembly as it stands on the dismount stands until the uprights are over the mounting pads on the under frame. Stop tractor and shut off engine. Figure 8.

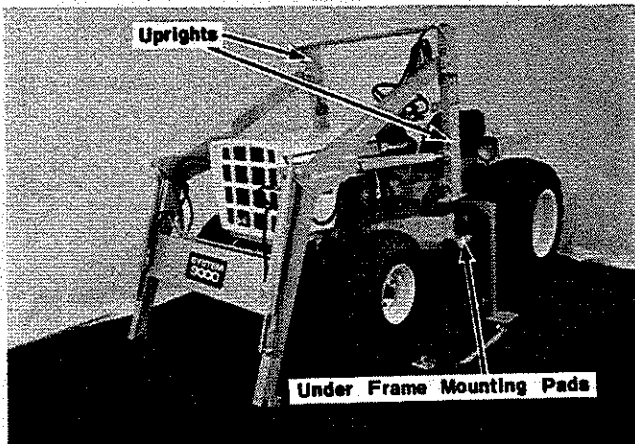

FIGURE 8

Remove the right dismount stand. Loader will stand with just the left dismount stand in place; however, lift frame will move slightly to the right side when stand is removed. Then from left side, remove left dismount stand and lower to the mounting pads on the loader frame. Install all of the bolts, washers, lock washers and nuts removed from the under frame; however, make sure that they are left loose until instructed to tighten. Figure 9.

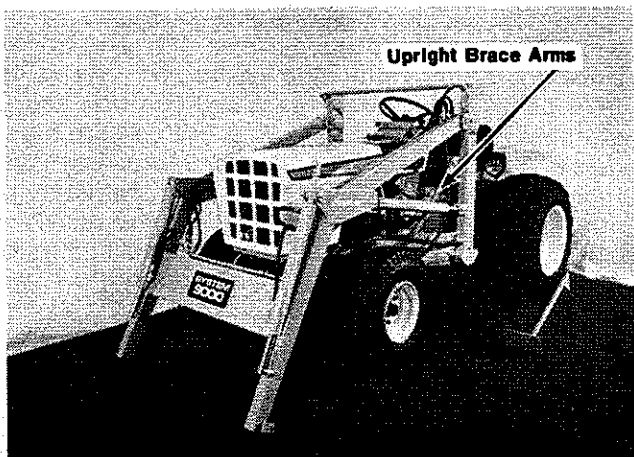

FIGURE 9

Install the Upright Braces P/N 260913 as shown in Figure 9 to the uprights and under frame with bolts, flat washers, lock washers, and nuts provided.

At this time go over entire loader and tighten all bolts securely.

After tightening, pass the suction and pressure hoses connected to the valve and reservoir under

the front axle and connect to the pump as shown in Figure 3. At this time make sure all fittings on the pump are tight and positioned as shown in Figure 3. Tighten the hose connections at the pump.

Install Hose Bracket and Bushing P/N 24056 a. P/N 24057 as shown in Figure 4 with one (1) 1/2" x 2" bolt and LW.

Check all hydraulic hose for tightness and then connect the four hoses from the control valve to the hydraulic lines on the side of the lift frame. These four hoses are preinstalled in ports A-B-C-D on the control valve. Match the port letter to the tag on each line bearing the same letter. Tighten securely.

At this time lubricate the four lift frame pins with grease until you see the grease ooze out, and then fill the hydraulic oil reservoir located in the left upright with three (3) quarts of type A hydraulic oil, then start engine. Engage P.T.O. clutch and operate lift and tilt cylinders to start filling the lines. Shut down engine and add 2 1/2-3 quarts of oil, then re-start and operate all cylinders through their full range. After several operations, lower the loader to the ground and tilt the bucket back as far as it will go, then shut the engine off. Check oil level by loosening the stove bolt located on the reservoir on the rear of the reservoir five (5) inches down from the top. If oil seeps out the system is full; if not add oil until it seeps out the fluid level check. Check pin lubrication and hydraulic fluid level once a day when loader is in operation or before use if left unused for a period of time.

After all hoses have been checked and the unit has been operated several cycles, then shut down and check for oil leaks at all connections and thereafter install the Pump Guard P/N 230930. Figure 10.

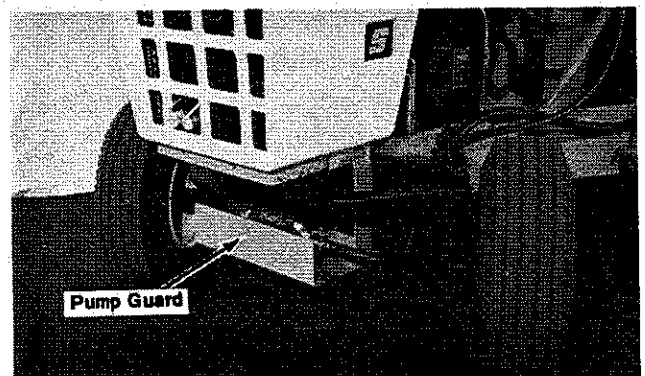

FIGURE 10

OPERATION

The tractor front electric clutch must be switched on before the loader will operate, and should be turned off when starting the engine and when loader is not in use.

Bucket height is regulated by the L.H. or outside valve lever. To raise the loader bucket, pull back

on the L.H. lever. To lower the bucket, push the L.H. lever forward.

To dump the bucket, push the R.H. or inside valve lever forward. To return the bucket to normal position, pull R.H. lever back.

The hydraulic control valve is equipped with a float position in the left hand spool. To use the float, push L.H. lever all the way forward until spool locks in the detent. This may be used for lowering the bucket to the ground.

Your loader is also equipped with a bucket position indicator located on the left hand tilt cylinder. When the guide rod is level with the stationary indicator, the bucket is level on a smooth surface.

When loading the bucket, approach the material with the tractor in low range. Speed may be increased while moving load to be dumped.

CAUTION! Exercise extreme care when operating the loader at high speeds.

REMOVAL OF LOADER

The dismount stands should be stored in some convenient place until ready to remove loader from tractor.

Remove hose bracket and bushing from tractor frame and then remove the pump guard and pump mounting plate with pump and pulley attached so that V-belt may be removed. Lay these parts out to the left side of the tractor beyond front tires as in Figure 11.

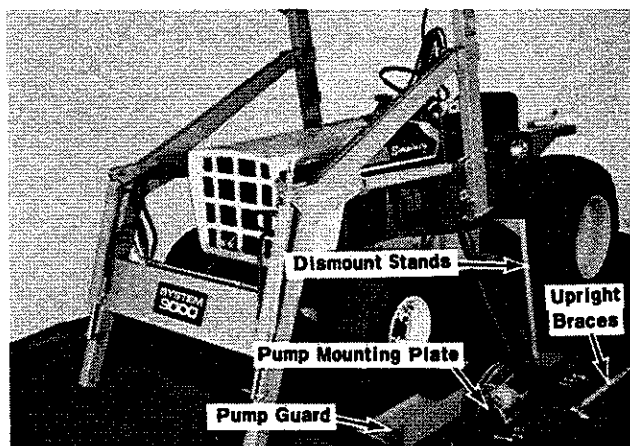

FIGURE 11

Then remove upright braces from each side and lay aside. Next, remove all bolts holding uprights to under frame and place dismount stands in place with bases to the rear. Raise loader until resting on dismount stands. Back tractor out of loader assembly and thereafter remove the remaining parts.

CAUTION! When leaving loader assembly for any length of time it is recommended that uprights be lowered to ground.

HYDRAULIC ADAPTER DESCRIPTION AND LOCATOR

| P/N | DESCRIPTION | WHERE USED |
|--------|---|--|
| 23904 | Male Pipe to Female Swivel 45° | Inlet side of pump |
| 23905 | Male SAE with O'Ring to Female Swivel 45° | Inlet side of pump |
| 23907 | Male SAE with O'Ring to Male JIC 90° | Valve and outlet side of pump |
| 23908 | Tee, Male JIC | Connector for hydraulic lines |
| 23910 | Male Pipe to Male JIC 90° | Hydraulic cylinders and left upright cap |
| 23911 | Female Swivel to Male JIC 90° | Outlet side of pump |
| 230923 | Male SAE with O'Ring to Male JIC Straight Adapter | Outlet side of valve |

HYDRAULIC HOSE LOCATOR

| P/N | WHERE USED |
|-------|--|
| 23826 | Valve Ports B and D - to Lines |
| 23831 | Right Tilt Cylinder - Rear Hose |
| 23835 | Left Tilt Cylinder - Rear Hose |
| 23837 | Left Tilt Cylinder - Front Hose |
| 23838 | Right Tilt Cylinder - Front Hose |
| 23839 | Right Lift Cylinder - Front Hose |
| 23865 | Valve Ports A and C - to Lines |
| 23867 | Left Lift Cylinder - Front Hose |
| 23871 | Left Lift Cylinder - Rear Hose |
| 23889 | Return Hose from Valve to Reservoir |
| 23890 | Right Lift Cylinder - Rear Hose |
| 23891 | Pressure Hose Connected to Pump from Valve |
| 23892 | Suction Hose Connected to Pump and Reservoir |

Faint, illegible text at the top left of the page.

Faint, illegible text at the top right of the page.

Large block of faint, illegible text in the middle left section.

Large block of faint, illegible text in the middle right section.

Block of faint, illegible text in the lower middle left section.

Block of faint, illegible text in the lower middle right section.

Large block of faint, illegible text in the bottom left section.

Large block of faint, illegible text in the bottom right section.

