

SIERRA

REVERSE OSMOSIS DRINKING WATER SYSTEM

Owner's Manual &
Installation Guide



41840 McAlby Court, Suite A, Murrieta, CA 92562
800.451.9343 . Email: sierra@nimbuswater.com

A**OWNERS MANUAL
About This System**

Congratulations on your purchase of the Nimbus Sierra reverse osmosis base unit. When properly maintained, this unit will provide you with years of trouble-free service. The next sections contain important information on proper care and maintenance. Please take a few minutes to read through this information.

B**OWNERS MANUAL
Maintenance Schedule**

The Nimbus Sierra reverse osmosis base unit must be serviced on a regular basis to maintain efficiency and to safeguard water quality. Each unit is equipped with a pre-filter, a membrane filter, and a post-filter. These cartridges work together to remove potential contaminants from your tap water and must be replaced at regular intervals. The chart below gives a general replacement timetable. For more accurate membrane filter replacement intervals, the system should be tested for TDS by an authorized Nimbus dealer. Instructions for cartridge replacement can be found in Section 10 of the Installation Guide.

Any significant change in performance of the system should be investigated promptly to avoid secondary damage or deterioration to other parts of the system.

Component	Interval	Indications For Service
Pre-Filter (Green cap)	6-12 months	Unit takes longer than 3 hours to fill a completely drained tank.
Post-Filter (Blue cap)	6-12 months	Odors, including a chlorine odor, in the product water.
Membrane Filter (White cap)	12 months	Significant increase in the level of total dissolved solids (TDS) in the product water (as determined by a conductivity meter).
Tank	12 months	No indications. Tank should be sanitized to reduce bacterial growth.

C**MAINTENANCE
Replacements**

Replacement part numbers are indicated on the side of each filter cartridge. The table below lists cartridge replacement part numbers as well as part numbers for the other parts you may need to maintain your unit. To order replacements, please call 800-451-9343 to be directed to an authorized Nimbus dealer.

This reverse osmosis system contains a replaceable treatment component, critical for the effective reduction of total dissolved solids. Product water should be tested periodically to verify that the system is performing properly. Please contact your Nimbus dealer for testing and service.

This reverse osmosis system contains a replaceable component critical to the efficiency of the system. Replacement of the reverse osmosis component should be with one of identical specifications, as defined by the manufacturer, to assure the same efficiency and contaminant reduction performance.

Use of non-Sierra replacement parts will invalidate the warranty as set forth in Section F of this Owner's Manual.

Description	Part No.
A Pre-Filter, Sediment/GAC Carbon Pre-Filter, Sediment only	104381 104380
B Post Filter, GAC	104382
C Membrane Filter	104583
Misc Premium Tank Assembly, 2-gallon Standard Tank Assembly, 2-gallon Faucet, Airgap Tank Shut-Off Valve Automatic Shut-Off Valve Cartridge Retainer Clip Drain Saddle Assembly Feed valve	104213 104946 100493 102564 105938 104393 100552 104503

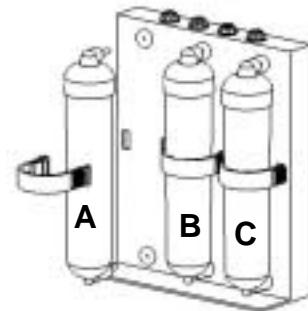

D

OWNER'S MANUAL Performance Sheet

System Performance

Daily production rate	42.8 L/d (11.3 gpd)
Efficiency Rating(1)	8.8%
Recovery Rating (2)	18%

Feed Water Requirements

Feed water(3)	Potable water
Feed pressure	275 kPa, (40psi) to 552kPa (80psi)
Feed temperature	1°C (33°F) to 38°C (100°F)
Total dissolved solids	2,000 mg/L maximum
Chlorine	1.0 mg/L max.

(1)Efficiency rating means the percentage of the influent water to the system that is available to the user as reverse osmosis treated water under operating conditions that approximate typical daily usage.

(2)Recovery rating means the percentage of the influent water to the membrane portion of the system that is available to the user as reverse osmosis treated water when the system is operated without a storage tank or when the storage tank is bypassed.

(3)Do not use with water that is microbiologically unsafe or of unknown quality without adequate disinfection before or after the system. Systems certified for cyst reduction may be used on disinfected water that may contain filterable cysts. The feed water must also be free of potential membrane foulants such as Iron, Hydrogen Sulfide and manganese.

System Tested and Certified by NSF International against NSF/ANSI Standard 58 for the reduction of the contaminants listed below. The concentration of the indicated substances in water entering the system was reduced to a concentration less than or equal to the permissible limit for water leaving the system, as specified in NSF/ANSI 58.



This system has been tested for the treatment of water containing pentavalent arsenic (also known as As(V), As(+5), or arsenate) at concentrations of 0.30 mg/L or less. This system reduces pentavalent arsenic, but may not remove other forms of arsenic. This system is to be used on water supplies containing a detectable free chlorine residual at the system inlet or on water supplies that have been demonstrated to contain only pentavalent arsenic. Treatment with chloramine (combined chlorine) is not sufficient to ensure complete conversion of trivalent arsenic to pentavalent arsenic. Please see the Arsenic Facts section of the Performance Data sheet for further information.

Testing was performed under standard laboratory conditions, actual performance may vary.

Substance	Influent Challenge Concentration (mg/L)	Average Percent Reduction	Maximum Permissible Product Water Concentration (mg/L)
Arsenic (pentavalent)	0.30+10%	98.2	0.025
Barium	10.0+10%	>99.9	2.0
Cadmium	0.03+10%	94.8	0.005
Chromium (hexavalent)	0.3+10%	87.5	0.1
Chromium (trivalent)	0.3+10%	96.8	0.1
Copper	3.0+10%	99.2	1.3
Fluoride	8.0+10%	96.7	1.5
Lead	0.15+10%	98.6	0.010
Selenium	0.10+10%	97.6	0.05
Radium 226/228	25pCiL+10%	80.0	5 pCiL
Total Dissolved Solids	750+10%	96.4	187
Turbidity	11+10% NTU	99.1	0.5
Cysts	80,000 3-4u/mL	99.99	7 # /mL

Arsenic (abbreviated AS) is a naturally occurring contaminate found in many ground waters. Arsenic is water that has no color, taste or odor. It must be measured by a lab test. Public water utilities must have their water tested for arsenic. You can get the results from your own water utility. If you have your own well, you can have the water tested. The local health department or the state environmental health agency can provide a list of certified labs. The cost is typically \$15 to \$30. Information about arsenic in water can be found on the internet at the US Environmental Protection Agency website: www.epa.gov/safewater/arsenic.html.

There are two forms of arsenic: pentavalent arsenic (also called As(V), As(+5), and arsenate) and trivalent arsenic (also called As(III), As(+3), and arsenite). In well water, arsenic may be pentavalent, trivalent, or a combination of both. Special sampling procedures are needed for a lab to determine what type and how much of each type of arsenic is in the water. Check with the labs in your area to see if they can provide this type of service.

Reverse Osmosis (RO) water treatment systems do not remove trivalent arsenic from water very well. RO systems are very effective at removing pentavalent arsenic. A free chlorine residual will rapidly convert trivalent arsenic to pentavalent arsenic. Other water treatment chemicals such as ozone and potassium permanganate will also change trivalent arsenic to pentavalent arsenic. A combined chlorine residual (also called chloramine) may not convert all the trivalent arsenic. If you get your water from a public water utility, contact the utility to find out if free chlorine or combined chlorine is used in the water system.

The Nimbus Sierra system is designed to remove pentavalent arsenic. It will not convert trivalent arsenic to pentavalent arsenic. The system was tested in a lab. Under those conditions, the system reduced 0.30 mg/L (ppm) pentavalent arsenic to 0.010 mg/L (ppm) (the USEPA standard for drinking water) or less. The performance of the system may be different at your installation. Have the treated water tested for arsenic to check if the system is working properly.

The RO component of the Nimbus Sierra system must be replaced yearly to ensure the system will continue to remove pentavalent arsenic. The component identification and location where you can purchase this component are listed in this installation manual.

F**OWNER'S MANUAL
System Warranty**

The Sierra Limited Warranty extends to the original purchaser of the system. This warranty covers all parts and factory labor needed to repair any Manufacturer-supplied item that proves to be defective in material, workmanship or factory preparation. The above-mentioned warranty applies for the first full calendar year from date of purchase. These defective items are subject to the following exclusions: membranes, filters, O-rings, and all other parts or components that require regular replacement as a result of ordinary usage.

Disclaimers This Warranty applies only if the system is installed and used in compliance with the instructions enclosed with the system.

The Warranty does not cover any non-standard Sierra parts. This Warranty does not cover the costs of repairs or adjustments to the unit that may be needed because of the use of improper parts, equipment or materials. This Warranty does not cover repairs required due to use of non-standard Sierra parts, unauthorized alterations of the unit, or failure of a unit caused by such alterations or by unauthorized repairs.

The Warranty does not cover malfunctions of the unit due to tampering, misuse, alteration, lack of regular maintenance, misapplication, fouling due to hydrogen sulfide or iron, scaling from excessive hardness, or excessive membrane hydrolysis due to chlorine levels in excess of 1.0 mg/L. In addition, damage to the unit due to fire, accident, negligence, act of God, or events beyond the control of the Manufacturer are not covered by this warranty.

Incidental and Consequential Damages The Manufacturer does not assume responsibility for payment of incidental and consequential damages as a result of the failure of this unit to comply with express or implied warranties, such as lost time, inconvenience, damage to personal property, loss of revenue, commercial losses, postage, travel, telephone expenditures, or other losses of this nature. Some states do not allow the exclusion or limitation of incidental or consequential damages, so this exclusion may not apply to you.

Owner's Warranty Responsibilities Under the provisions of the Warranty, the owner is expected to schedule maintenance, as described in this Manual. Neglect, improper maintenance, abuse, or unapproved modifications may invalidate the Warranty. Should your unit develop a defect or otherwise fail to perform in accordance with this warranty, you should contact the dealer from whom the product was originally purchased.

Implied Warranties The implied at-law warranties of merchantability and fitness for a particular purpose shall terminate on the date one year after the date of purchase. Note: some states do not allow limitations on how long an implied warranty lasts, so the above limitations may not apply to you.

Other Rights This Warranty gives you specific legal rights and you may also have other rights which vary from state to state.

G**IMPORTANT
System Information**

Immediately after installation, please fill out the form below and retain for future reference.

Model: _____

Serial No: _____

Install Date: _____

Sold by: _____

Installed By: _____

Service Center
Phone Number: _____

1

INSTALLATION Before You Begin

The following instructions outline a typical water treatment system installation. Consult local plumbing codes and building regulations as they may pose different or additional requirements for the installation. The installer is responsible for ensuring that the installation is in compliance with all applicable state and local regulations.

This system has been designed for installation by a licensed professional such as a contractor or plumber. Proper completion of this installation will require basic familiarity with standard sink plumbing and proper use of common hand and power tools. Improperly installed systems could result in water damage due to leaks or flooding.

Do not use with water that is microbiologically unsafe or of unknown quality without adequate disinfection before or after the system.

Typical Installation Diagram

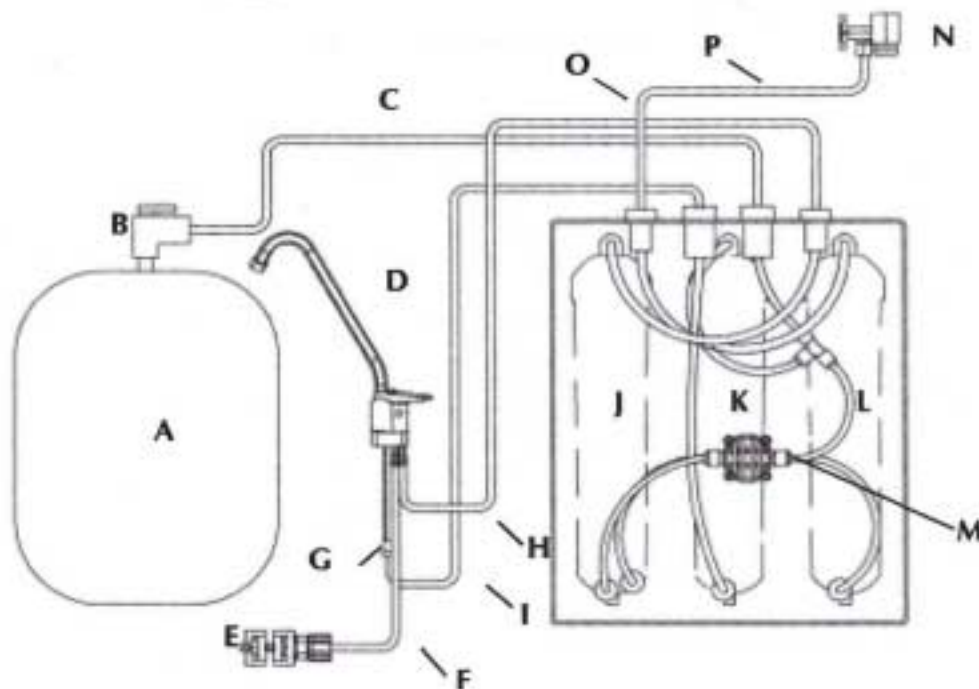

- | | |
|-------------------------------|-------------------------------------|
| A. Product water storage tank | I. Product water tubing (3/8" blue) |
| B. Tank shut-off valve | J. Reverse osmosis membrane filter |
| C. Tank tubing (3/8" white) | K. Carbon post-filter |
| D. Air-gap faucet | L. Pre-filter |
| E. Drain connection assembly | M. Automatic shut-off valve |
| F. Drain tubing (3/8" white) | N. Inlet fitting with elbow |
| G. Quick-connect fitting | O. Feed water tubing (1/4" green) |
| H. Drain tubing (1/4" yellow) | P. Feed water shut-off |

2

INSTALLATION Parts

Sierra Manifold Unit

- A. Pre-filter
- B. Carbon post-filter
- C. Reverse osmosis membrane filter
- D. Cartridge Retainer clips (3)
- E. Drain saddle unit
- F. Feed water connection assembly
(shown with shut-off valve attached)

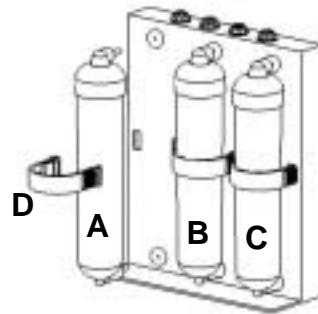

Parts Kit (not shown)

- 1/4" plastic tubing insert
- 1/4" plastic ferrule
- Date of Installation labels (3)
- Feed valve warning tag
- Feed shut-off warning label
- Self tapping mounting screws (2)
- Flat rubber washer
- Gray rubber cone

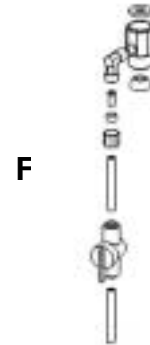

Faucet Kit (not shown)

Tubing(notshown)

- 6' white 3/8" tubing
- 4' blue 3/8" tubing
- 4' green 1/4" tubing
- 4' yellow 1/4" tubing

The feed water connection assembly supplied with the Sierra system includes components which represent the most common under-sink plumbing connections currently in use within the United States. If these components do not match the type of connections installed at your location, contact a local hardware or plumbing supplier to obtain the correct fittings.

3

INSTALLATION Feed Connection

1. Locate and turn off the angle stop valve on the cold water line feeding the sink where the Sierra unit is to be installed. This valve will usually be located under the sink on the pipe coming out of the wall.

Hint: Be sure to make this connection on the COLD water feed, not the HOT water feed. If you are not sure which line is the cold water line, open the hot water tap on the sink until hot water flows from the faucet. The hot water line under the sink can then be identified by touch.

2. When the angle stop valve is closed, relieve pressure in the line by opening the cold water tap on the sink.

3. It may be possible to install the feed adapter fitting at either the angle stop valve or at the faucet inlet connector depending on the size and type of fittings at your location. The angle stop valve is preferable because of its easier accessibility. Both options are given in Fig 1.

Option A - To install the feed adapter at the faucet connector disconnect the cold water feed line where it connects to the faucet inlet connector. This will usually require an open end wrench, pliers, or long reach faucet wrench. Proceed to step 4.

Option B - To install the feed adapter at the angle stop valve, disconnect the feed line at the angle stop valve. This will usually require a wrench or pliers. With this end of the water line free, proceed to step 4.

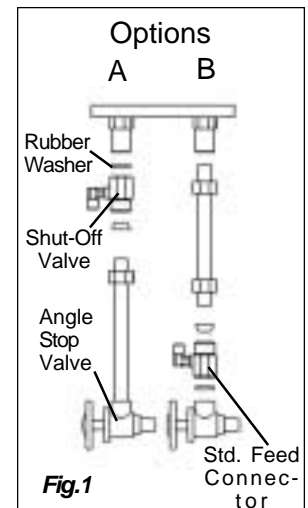

4. Take the 1/4" feed connector valve from the parts kit and install it into the brass feed connector adapter (Option B shown in Fig. 1). Use a crescent wrench or open-end wrench to tighten the valve into the adapter (Option B shown in Fig. 1). If the feed adapter is to be installed at the faucet inlet connector (Option A shown in Fig. 1) it may be necessary to install the feed connector valve after step 5 due to limited space.

5. Using the flat and cone washers as necessary, install the feed adapter into the faucet inlet connector or angle stop valve as chosen above. Then reconnect the cold water feed line to the open end of the feed adapter. Tighten all connections securely.

6. Using the green 1/4" tubing, install the compression nut, plastic ferrule, and plastic tube insert. Secure the tubing into the feed connector valve. Tighten the tubing retaining nut securely. See Fig.2.

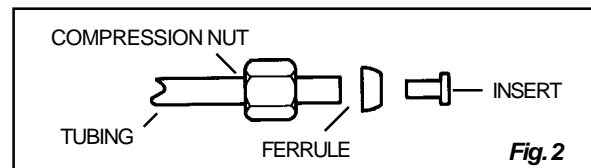

7. Obtain the small feed valve warning tag from the parts bag and attach it by its wire ties to the feed valve.

4

INSTALLATION Drain Connection

Note: The drain saddle assembly must be installed before the 'P' trap. Do not install the drain saddle assembly between the 'P' trap and the wall.

1. Position drain saddle assembly (Fig. 3) on drain pipe under sink between the P trap and the sink connection.

2. Orient the drain saddle so that the connector opening points in the general direction of the planned location for the R.O. dispensing faucet.

3. Screw the connector nut onto the drain saddle threaded connector loosely (Fig. 4). Using the connector opening in the side of the drain saddle as a guide, drill a 3/8" hole through the wall of the drain pipe.

4. Remove drain saddle assembly. Place the adhesive foam pad over the 3/8" hole in the drain pipe. Replace the assembly onto the drain pipe, aligning the hole in the drain with the hole in the drain assembly.

5. Tighten the saddle bolts evenly on both sides until the saddle grips the pipe snugly - do not overtighten. (Fig.4)

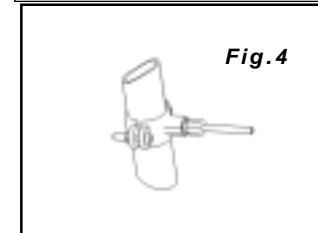
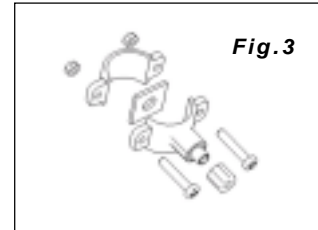

5

INSTALLATION Drilling The Sink

In addition to common hand tools, the following tools are required for drilling through the most common sink materials:

1/4" masonry drill bit
1 1/4" hole saw
7/8" chassis punch

1 1/4" porcelain cutter
Hole saw adapter
Center punch

Hint: Special care should be taken when drilling the faucet hole. A clean hole can be cut in a short period of time, but any attempt to rush the process will result in chips and scratching. On some sinks there may be ridges on the underside of the sink. You must avoid these ridges or other obstructions to insure an adequate flat surface for installation of the faucet nut and washer.

When performing installations that call for locating the faucet on the counter instead of the sink, ensure that adequate space is available underneath to accommodate the faucet subassembly.

Formica or Wooden Counter

1. Drill a 1 1/4" hole with hole saw or flat (spade) wood bit.
2. Clean off sawdust.

5

INSTALLATION Drilling The Sink

(continued)

2. Clean off sawdust.

Enamel, Porcelain-Over-Steel, or Cast Iron Sink

1. With drill motor place 1/4" masonry drill bit at selected location. Before starting rotation, firmly apply downward pressure until a slight crunching sound is heard. This will fracture a small area of the enamel/porcelain and prevent the bit from "walking".

2. Drill the 1/4" pilot hole.

3. With the pilot hole as a guide, use a 1 1/4" porcelain cutter to cut through the porcelain/enamel only. Stop the drill once the metal is exposed.

4. Once again using the pilot hole as a guide, use the 1 1/4" hole saw to cut through the metal. (The hole saw is slightly smaller than the porcelain cutter so the teeth of the saw will not chip the enamel/porcelain).
CAUTION - DO NOT BOTTOM OUT THE DRILL ON CERAMIC SURFACE.

5. Clean off the sink and wipe the area clean. Be sure all metal chips are removed as they can stain porcelain very quickly.

Tile Sink or Counter

1. Follow procedures 1-3 under Enamel, Porcelain, Cast Iron Sink procedures.

2. With the gentle use of the center punch and hammer, break up the ceramic disk to the extent necessary to remove it. Remove the ceramic disk.

3. Use the 1 1/4" hole saw or wood drill to continue the hole through the wooden support. Clear away the debris.

Stainless Steel Sink

1. Use a center punch and hammer to mark the sink surface for drilling.

2. Drill a starter hole with a 1/8" high speed drill bit.

3. Enlarge the starter hole with a 7/16" high speed drill bit.

4. Make a 1 1/4" faucet hole with the chassis punch by placing the male cutter of the chassis punch under the 7/16" pilot hole, insert driving bolt through female die and pilot hole into the male die. Tighten driving bolt to cut the faucet hole.

5. Use a round file to clean up any rough edges. Clean up any filings, ensuring that none get into the sink drain or disposal.

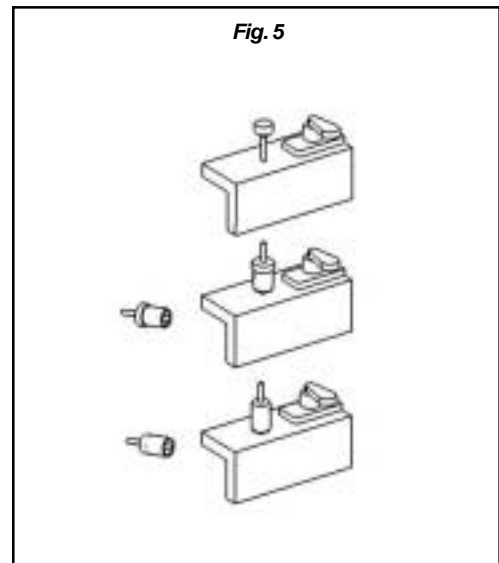

6

INSTALLATION Push Handle Faucet

For easier installation, attach all tubing prior to mounting the faucet.

1. Insert polished faucet base (refer to figure H page 5) onto base of faucet.
2. Install the 1/4" yellow drain tubing onto the 1/4" barb fitting. This tube must be of sufficient length to reach the yellow manifold drain connection.
3. Insert the white 3/8" tubing onto the larger 3/8" barbed fitting, being sure you have enough tubing to reach the drain saddle.
4. Slip the 1/4" and 3/8" tubing through opening in polished faucet base (Item #1). Slide white plastic spacer (Item #2) open-end-up onto the threaded faucet stem (Fig 6)
5. Thread the 3/8" washer (Item #3) and mounting lock nut (Item #4) onto the threaded stem. (Fig 6)
6. Thread faucet quick-connect adapter (Item #5) on to threads of faucet stem. NOTE: This connection should be hand-tightened only. Push one end of 3/8" blue tubing into 3/8" connection.
7. Insert tubing and faucet assembly down through the sink hole.
8. Position the faucet to the desired handle orientation. Slip the slotted washer between the white plastic spacer and the sink. Securely hand tighten the mounting nut.

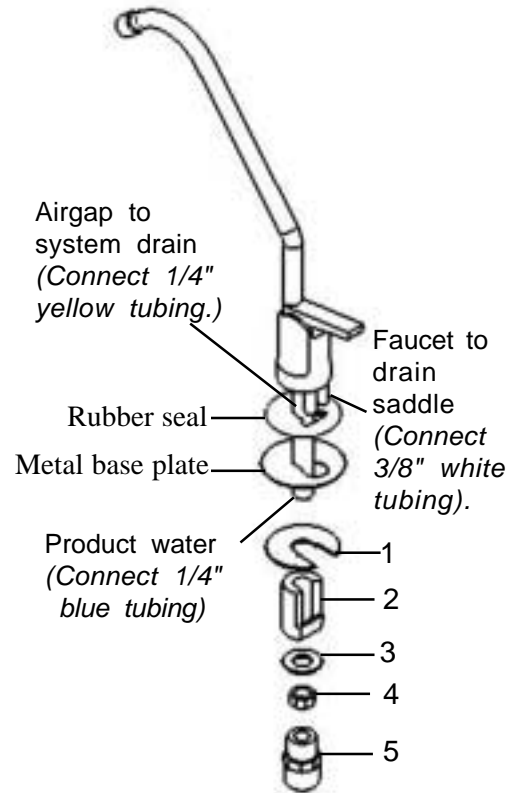

Fig. 6

Hint: The airgap tubing connection is located under the faucet handle. By orienting the air-gap from the underside of the sink, your faucet handle should be correctly oriented.

9. Connect the white 3/8" tubing to the drain saddle assembly using the drain connector nut supplied. This tubing should follow as direct a path as possible; long runs, looping or deep sags will restrict normal brine flow to the drain. Save the unused portion of the tubing for the installation of the storage tank.
10. Apply a small amount of silicone-based lubricant to the O-rings located at the base of the spout. Firmly insert spout assembly into the top hole of faucet body (approximately 1/4"). You may swivel the faucet left or right.

7

INSTALLATION The Manifold Unit

Determine the most practical under-the-sink location for placement of the Sierra manifold unit and the companion reservoir tank. Ensure that the specific location allows adequate access to the manifold unit for cartridge replacement and to the tank for tank- valve operation.

1. Place the manifold and tank in the selected locations. If desired, the #6 self tapping screws may be used to secure the manifold unit in position by means of the top rear and bottom lip mounting holes.
2. Take the unused portion of the 3/8" white tubing and insert one end firmly into the 3/8" (largest) connector on the top of the manifold unit.
3. Extend the 3/8" white tubing from the manifold unit to the tank valve. Leave enough slack in the tubing to allow the unit to be removed from the installed location for servicing. Cut off the excess and insert the 3/8" tube into the quick-connect tank valve fitting until it is fully engaged.
4. Extend the 1/4" yellow tubing from the faucet unit to the manifold. Leave enough slack in the tubing to allow the unit to be removed from the installed location for servicing. Cut off the excess and firmly insert the tubing into the corresponding yellow drain connection located on the manifold.
5. Extend the 3/8" blue tubing from the faucet unit to the manifold. Leave enough slack in the tubing to allow the unit to be removed from the installed location for servicing. Cut off the excess and firmly insert the tubing into the corresponding blue product water connection located on the manifold.
6. Extend the green tubing from the feed connector valve to the manifold. Leave enough slack in the tubing to allow the unit to be removed from the installed location for servicing. Cut off the excess and firmly insert the tubing into the corresponding green feed connection located on the manifold.
7. Obtain the Shutoff Warning label and affix it to the manifold unit so that it is directly visible. The Sierra system is now connected and ready for initial test and preparation.

TUBING HINTS: Use a sharp knife or tubing cutter to cut the tubing squarely, being sure to remove all burrs. Then insert the tubing firmly until it stops. To remove the tubing, push against the collet while pulling on the tubing.

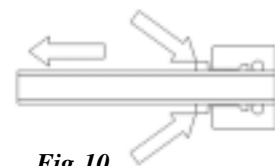
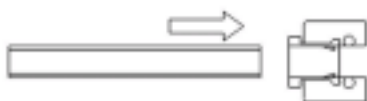
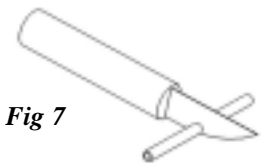

Fig 8

Fig 9

Fig 10

System Activation and Inspection

1. Check all tubing connections to ensure they are firmly seated. **CHECK TO SEE THAT THE CARTRIDGE RETAINER CLIPS ARE PROPERLY ENGAGED.** The retainer clips must in place during long term, unattended operation of the system. Failure to keep the retaining clips in place could result in accidental leaks and flooding.
2. Open the dispensing faucet at the sink. Close the tank shut-off valve.
3. Open the feed water valve to the system. Observe all tubing and connections for several minutes to detect any leaks. In approximately 5 minutes, (assuming normal feed water pressure) the dispensing faucet should begin dripping. Allow the faucet to run for up to 15 minutes, then close the faucet.
4. Place a pan or other temporary water basin near the drain 'P' trap. Loosen the connector nut holding the 3/8" tube in the drain saddle connector. Pull the tube out of the connector and use the pan to catch any water that may spill. Brine water should be flowing from the tube. Reconnect the tube to the drain saddle and hand-tighten the connector nut.
5. Open the tank shut-off valve.

Initial Flushing Procedure

1. Before the system can be used for drinking water production it must be adequately flushed. Each reservoir tank is dosed with a small amount of powdered sanitizer before shipment, typically a chlorinating agent, in order to ensure tank internal cleanliness. Also, the carbon filter cartridge will release a small amount of carbon fines during the first tankful of flow. This flushing procedure will allow any sanitizer or carbon fines to pass from the system.
2. Initial tank filling will take approximately two and one half hours (based on average feed pressure). When the tank is full, the water pressure will have risen to the point where the automatic shut-off valve inside the manifold unit will stop the feed flow through the system. Actuation of the automatic shut-off valve can be determined by either checking for a lack of brine flow to the drain saddle, or by listening very closely near the dispensing faucet for absence of water flow sound though the air gap. When the tank has filled for the first time, it should be left undisturbed for at least 8 hours to ensure proper sanitization.
3. After 8 hours has elapsed, open the dispensing faucet fully and allow the product water to run out to drain at maximum flow. The initial discharge will be dark with the bulk of the carbon particle wash out. There may also be the scent of chlorinated water from the sanitizing agent. When the flow has diminished to a fast drip or small stream, close the dispensing faucet.
4. Fill and flush the tank at least three times prior to use. If necessary, repeat until the chlorination scent has disappeared. It is important that the flush be done at maximum flow (e.g. the tank must be full) to assist in rapid wash out. After this flushing procedure the system is ready for normal use.

9

INSTALLATION CheckList

1. Sierra unit and tank are located where they will not be subject to physical impacts or rough contact by heavy objects.
2. Feed water pressure to the unit is no less than 40 psi and no greater than 80 PSI.
3. Ensure the plastic retainer clips are fully engaged. The slide locks must snap into place in the slots. If the clip does not snap easily into place through the slots it means the cartridge is not fully inserted into the connectors. Press top or bottom of cartridge to engage connectors until it snaps into place properly.
4. All tubing connections, especially push-in quick connections, are fully inserted.
5. Tubing connected between the faucet and the drain saddle fitting (the fitting attached to the sink drain pipe) runs "downhill" to the drain. There should be no loops or places where water would not flow out to the drain.
6. Feed and tank valves are open.
7. Within one to two hours after initial application of water pressure, check again for leaks especially at the tank, faucet tubing and connectors. These parts will not see full pressure until approximately 2 hours after the system is activated.
8. Flush three tankfuls of product water to drain. If a chlorine scent persists, repeat flushing procedure in Section 8.

Refer to Section B in the Owner's Manual portion of this guide for a suggested replacement schedule.

Cartridge Replacement

1. Close the feed water shut-off valve.
2. Close the tank shut-off valve.
3. Open the R/O dispensing faucet.
4. Pull the manifold unit from the installed location.
5. Remove the retaining clip at the front of the unit. Pull the cartridge off the manifold evenly at top and bottom. Dispose of used cartridge.
6. Install the new cartridge, rocking gently from side to side as necessary until the cartridge tubes are properly engaged in the manifold connectors. Install the retaining clip, ensuring the slide locks snap into place in the slots. If the clip does not snap easily into place through the slots it means the cartridge is not fully inserted into the connectors. Press top or bottom of cartridge to engage connectors until it snaps into place properly.
7. Turn on feed water shut-off valve.
8. Turn on tank shut-off valve. Observe system for any leaks, especially at newly replaced cartridge.
9. Close dispensing faucet after water stops running.
10. If replaced cartridge was a post carbon or a membrane filter, the system should be flushed at least once as described above under Section 9.

Tank Sanitizing

Tank sanitizing should be done every twelve months as part of the regular system maintenance program through an authorized Sierra dealer. This procedure will take approximately 30 minutes. As a safety precaution, always wear protective eyegear, mix chemicals in a well-ventilated area, and avoid breathing the fumes.

1. Measure 3¼ ounces Oxine Concentrate for each gallon of tank capacity. Pour into a plastic container.
2. Add 10 grams of Bio-Cide Activator Crystals. Let stand for five minutes to activate solution.
3. Pour activated solution into tank. Fill tank completely with potable water. Bleed air from lines. Let stand for 10 minutes.
4. Drain tank and lines. Flush thoroughly using potable water.



©Nimbus Water Systems 2007 PN103257