

WL Trip Unit, MODBUS Communication and Electronic Accessories Application Guide



powerful ideas
RELIABLE SOLUTIONS

WL Low Voltage Power
Circuit Breaker
ANSI / UL1066 & UL 489



SIEMENS

Global network of innovation

Communication-capable Circuit Breakers

WL Circuit Breaker

Technological Leader Among Circuit Breakers: WL Communication

Connection Diagram

- 1 Breaker Data Adapter (BDA)
- 2 Browser-capable input and output device (e.g. notebook)
- 3 WL Circuit Breaker
- 4 COM16 MODBUS module or COM 15 PROFIBUS module
- 5 Breaker Status Sensor (BSS)
- 6 Electronic Trip Unit
- 7 Metering function PLUS
- 8 Zone Selective Interlocking (ZSI) module
- 9 Digital output module with relay or optocoupler outputs
- 10 Digital output module with relay or optocoupler outputs, remotely configurable
- 11 Analog output module
- 12 Digital input module
- 13 WinPM.Net on PC
- 14 PLC (e.g. SIMATIC S7)
- 15 BDA Plus

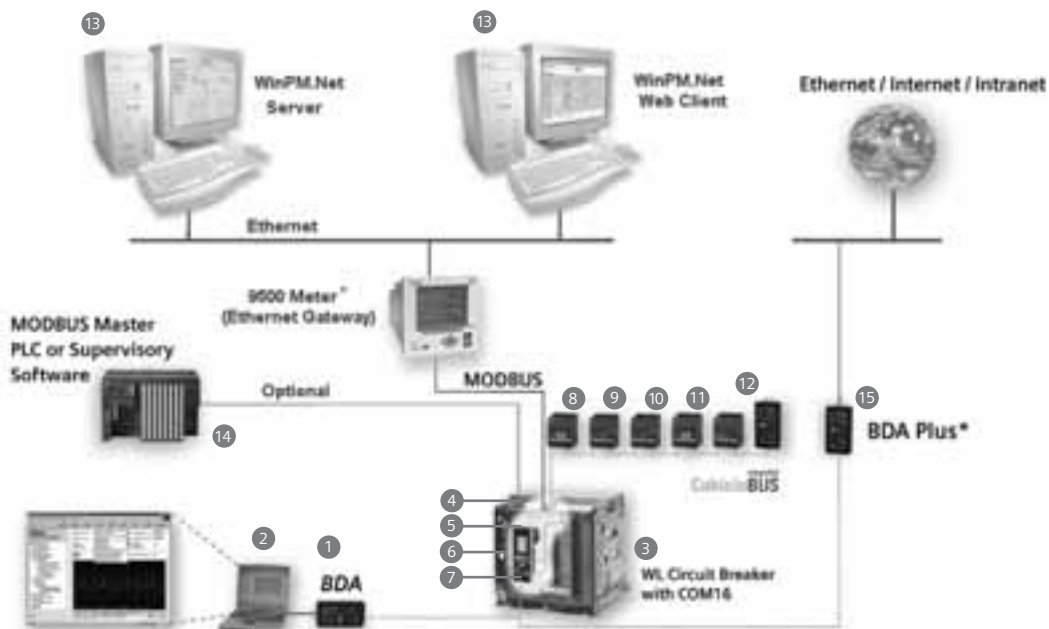

* The Siemens BDA Plus or meters, 9330, 9350, 95/9600 can be used as a gateway to enable Ethernet communication to the WL Circuit Breaker.

The 9500 meter can also be used as a central display unit for multiple WL breakers with metering capability.

Communication-capable Circuit Breaker

Introduction and Overview

WL Circuit Breaker

MODBUS Profile for WL Circuit Breaker

Breaker Data Adapter (BDA)
Breaker Data Adapter *Plus* (BDA *Plus*)

1

2

3

4



Communication-capable Circuit Breakers

WL Circuit Breaker

Safety Guidelines

This manual contains notices which you should observe to ensure your own personal safety, as well as to protect the product and connected equipment. These notices are highlighted in the manual by a warning triangle and are marked as follows according to the level of danger. This equipment contains hazardous voltages. Death, serious personal injury or property damage can result if safety instructions are not followed. Only qualified personnel should work on or around this equipment after becoming thoroughly familiar with all warnings, safety notices, and maintenance procedures contained herein. The successful and safe operation of this equipment is dependent upon proper handling, installation, operation and maintenance.

Danger

For the purpose of this manual and product labels, DANGER indicates an imminently hazardous situation which, if not avoided, will result in death or serious injury.

Warning

For the purpose of this manual and product labels, WARNING indicates a potentially hazardous situation which, if not avoided, could result in death or serious injury.

Caution

For the purpose of this manual and product labels, CAUTION indicates a potentially hazardous situation which, if not avoided, may result in minor or moderate injury.

Attention

Draws your attention to particularly important information on the product, handling the product or to a particular part of the documentation.

Qualified Personnel

For the purpose of this manual and product labels, a qualified person is one who is familiar with the installation, construction and operation of the equipment, and the hazards involved. In addition, he or she has the following qualifications:

- (a) Is trained and authorized to energize, de-energize, clear, ground and tag circuits and equipment in accordance with established safety practices.
- (b) Is trained in the proper care and use of protective equipment, such as rubber gloves, hard hat, safety glasses or face shield, flash clothing, etc., in accordance with established safety practices.
- (c) Is trained in rendering first aid.

Correct Usage

Note the following:



Warning

This device and its components may only be used for the applications described in the catalog or the technical descriptions, and only in connection with devices or components from other manufacturers which have been approved or recommended by Siemens.

This product can only function correctly and safely if it is transported, stored, set up, and installed correctly, and operated and maintained as recommended.

Registered Trademarks

WinPM.Net is a registered trademark of Siemens Energy & Automation. MODBUS® is a registered trademark of MODICON. Some other designations used in these documents are also brands; the owner's rights may be violated if they are used by third parties for their own purposes. Excel and Explorer are registered trademarks of Microsoft Corporation. Java is a registered trademark of Sun Microsystems. Netscape is a registered trademark of AOL Time Warner.

Introduction and Overview

1

Content of the Manual

Overview of the Bus Systems

Communicating with the Circuit Breaker

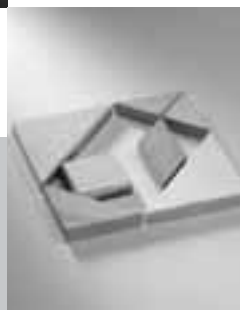

General

This manual is aimed at those who want to find out more about the different applications of communications-capable circuit breakers in power distribution systems.

It contains a detailed guide to commissioning, operating, diagnosing and maintaining the new communications-capable WL Circuit Breaker.

Content of the Manual

Chapter 1 contains a short introduction to communications in power distribution systems, and provides an overview of the benefits and applications of communications-capable circuit breakers. The chapter concludes with a short description of the most important communication bus systems.

Chapter 2 contains a general description of the WL Circuit Breaker. It includes information on configuration data and provides commissioning instructions.

Chapter 3 explains how the circuit breakers are integrated in a power management system and describes the supported function codes, register maps and exception codes.

WL is the first circuit breaker that can be configured, diagnosed and maintained remotely without the use of field bus systems and higher-level operator control and monitoring systems. These procedures are carried out using the breaker data adapter (BDA), a state-of-the-art Internet-capable configuration device for circuit breakers, which is described in Chapter 4.

Introduction

The demand for communications-capable systems, data transparency and flexibility in industrial automation systems is growing all the time. Bus systems and intelligent switchgear are vital to ensure that industrial power systems can meet these demands, since industrial production and building management are now inconceivable without communications technology.

The evermore-stringent requirements placed on the electrical and mechanical aspects of circuit breakers, the growing need for flexibility and efficiency, and increasing cost pressure and automation have contributed to the recent major innovations in circuit breaker technology. In power distribution systems, the WL Circuit Breaker uses industry-standard bus systems to transmit key information for warnings, commissioning and load shedding to a central control room. The wide range of applications ensure that these circuit breakers are more than just simple switching and protective devices.

Point-to-point communication, as well as data entry, transmission, analysis and visualization are only possible if the automation and low-voltage switchgear technology components can be easily integrated in a communication solution to leverage the full range of functions available.

In this way, status information, alarms, trip information and setpoints (e.g. overcurrent, phase unbalance, overvoltage) increase transparency in power distribution systems, enabling these situations to be dealt with quickly. A communication host can send short text messages to the cell phones of maintenance personnel. Prompt analysis of this data enables targeted intervention in the process and helps reduce system down time.

Information for preventive maintenance (e.g. the number of operating cycles or hours) enables timely personnel and material scheduling, which increases system availability and helps prevent sensitive system components from being damaged.

Communication helps provide rapid and targeted information on the location and cause of power failures. The cause of the fault can be determined by recording the phase currents (e.g. trip as a result of a short-circuit of 2317 A in phase L2 on 08/27/2002 at 14:27). This information can be used to quickly rectify the fault and reduces downtime for quicker recovery.

Measuring and communicating power, power factor and energy allows an even greater number of applications. The availability of power consumption data on a targeted basis for business analysis enables power profiles to be created and costs to be clearly assigned. In this way, energy costs can be allocated and optimized by balancing the peak loads.

WL Circuit Breakers—Modular and Intelligent

Thousands of options with just a few components: That's the WL. A new generation of circuit breakers – from 200A to 5000A – with a modular design to support every conceivable application in power distribution systems – cost effective and flexible, its communication functionality enables it to be integrated in system solutions.

Cost Saving

Whatever the configuration, the WL Circuit Breaker does the job where it matters. Advantages include simple retrofitting and a compact design benefiting everyone who uses WL Circuit Breakers, whether in planning, business, or whether they develop or operate switchgear systems.

Easy Planning

The WL Circuit Breaker and EasyTCC together provide a convenient software package for coordinating multiple circuit breakers.

System Solutions

By integrating WL Circuit Breakers in a higher-level communication system, they can be configured via MODBUS, Ethernet or the Internet; an integrated power management system allows you to optimize power distribution across the board.

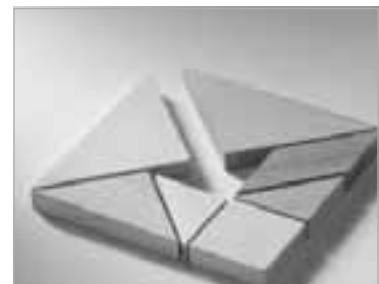

Graphic 1-1

Saving costs increases productivity.

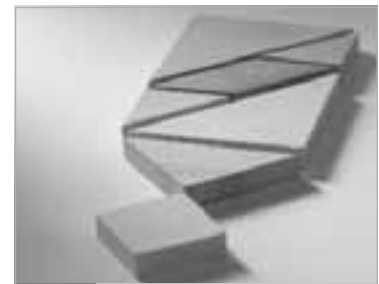

Graphic 1-2

Simplified planning every step of the way.

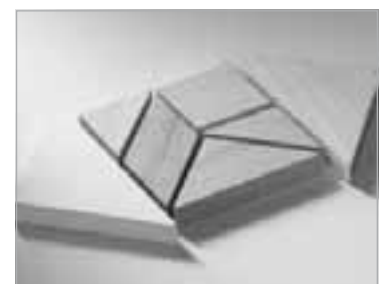

Graphic 1-3

System solutions - Supports energy management through advanced metering and communications.

Communication Bus Systems

Communication bus systems are used to connect distribution devices with varying levels of intelligence. With their different structures and mechanisms, certain bus systems are designed for highly specific applications, while others are better suited for more open applications. The following section describes the most important bus systems used in automation and power distribution systems.

MODBUS

MODBUS is an open, serial communications protocol based on a master-slave architecture. Since it is very easy to implement on any kind of serial interface, it can be used in a wide range of applications. MODBUS comprises a master and several slaves, whereby communication is controlled exclusively by the master. MODBUS features two basic communication mechanisms:

- Question/answer (polling): The master sends an inquiry to a station and waits for a response.
- Broadcast: The master sends a command to all the network stations, which execute the command without confirmation.

The messages enable process data (input/output data) to be written to and read from the slaves either individually or in groups.

The data can either be transmitted in ASCII or as a package in RTU format. MODBUS can be used over a wide range of transmission media, normally, on an RS 485 physical bus, a twisted, shielded two-wire cable with terminating resistors.

The MODBUS protocol was originally developed for networking control systems, and is often used for connecting input/output modules to a central PLC. Due to the low transmission rate of 38.4 kBaud max., MODBUS is particularly recommended for applications with a low number of stations or low response time requirements.

Communication Structure of the WL Circuit Breakers

The following diagram:

- Provides an overview of the different communication options available with WL Circuit Breakers and their modules.
- Illustrates the high level of system flexibility, enabling new and innovative ideas to be implemented.

Starting at the lowest level with simple configuration of the circuit breakers, to the field level with a PLC and WinPM.Net software tool, to a connection to the Intranet/Internet, the potential for saving on power costs by means of intelligent power management is achievable.

The individual circuit breakers and their modules are described in the following chapters.

Connection Diagram

- 1 Breaker Data Adapter (BDA)
- 2 Browser-capable input and output device (e.g. notebook)
- 3 WL Circuit Breaker
- 4 COM16 MODBUS module or COM 15 PROFIBUS module
- 5 Breaker Status Sensor (BSS)
- 6 Electronic Trip Unit
- 7 Metering function PLUS
- 8 Zone Selective Interlocking (ZSI) module
- 9 Digital output module with relay or optocoupler outputs
- 10 Digital output module with relay or optocoupler outputs, remotely configurable
- 11 Analog output module
- 12 Digital input module
- 13 WinPM.Net on PC
- 14 PLC (e.g. SIMATIC S7)
- 15 BDA Plus

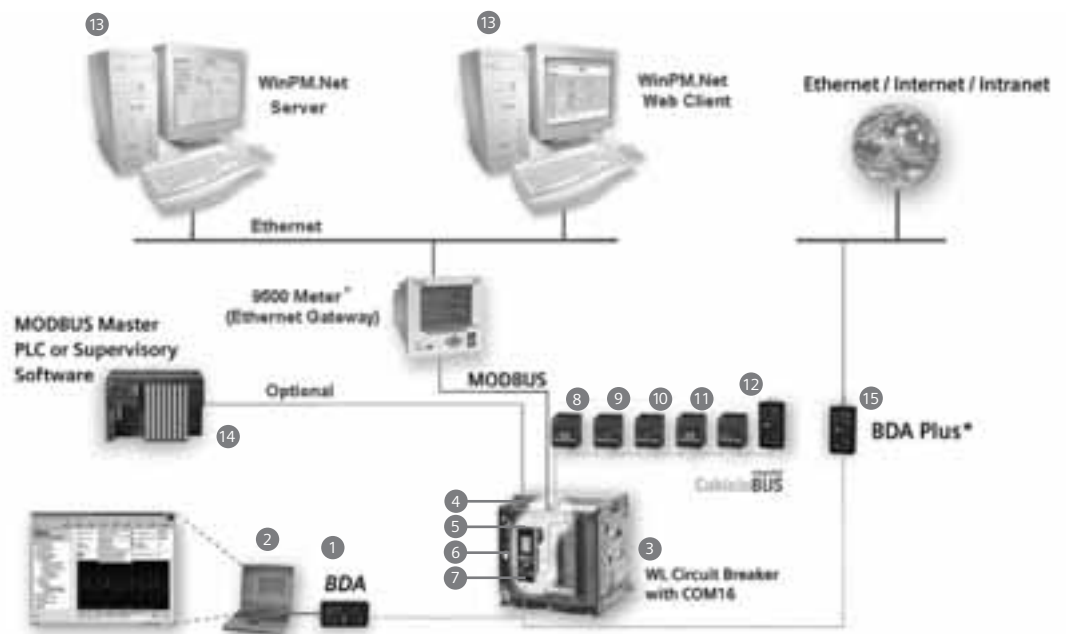

* The Siemens BDA Plus or meters, 9330, 9350, 95/9600 can be used as a gateway to enable Ethernet communication to the WL Circuit Breaker.

The 9500 meter can also be used as a central display unit for multiple WL breakers with metering capability.

Ethernet

The Industrial Ethernet is a high-performance network that conforms to IEE 802.3 (ETHERNET). The highly successful 10Mbit/s technology, which has been used for over a decade, and the new 100Mbit/s technology (Fast Ethernet to IEEE 802.3u) in conjunction with Switching Full Duplex and Autosensing enable the required network performance to be adapted to different requirements. The appropriate data rates are selected as required because complete compatibility enables the technology to be implemented on a step-by-step basis.

Used in 80% of networks, Ethernet is currently the best of its kind in LAN environments.

Ethernet does not function according to a master-slave principle. All the stations have equal priority on the bus, which means that any station can be the sender or receiver. A sender can only send on the bus if no other station is sending at that time. This is due to the fact that the stations are always "listening in" to find out whether any messages are being sent to them or any senders are currently active. If a sender has started sending, it checks that the message it has sent is not corrupt. If the message is not changed, the send operation continues.

If the sender detects that its data is corrupt, another sender must have already started sending data. In this case, both senders abort their respective send operations.

After a random time has elapsed, the sender restarts the send operation. This is known as CSMA/CD and, as a "random" access procedure, does not guarantee a response within a certain time frame. This largely depends on the bus load, which means that real-time applications cannot yet be implemented with Ethernet.

WL Circuit Breaker

2

Short description of WL Circuit Breaker

The **Cubicle**BUS

Communication Function of the Trip Units

The COM16 MODBUS Module

Metering and Metering *Plus*

Description of Important Functions/Parameters
for Communication

External **Cubicle**BUS Modules

External Power Consumption of a WL Circuit Breaker
with **Cubicle**BUS



Communication-capable Circuit Breakers

WL Circuit Breaker

Introduction and Overview

The demands regarding communications capability, data transparency, flexibility and integration in power distribution systems are increasing all the time. The WL Circuit Breaker is a modular circuit breaker that fulfills the requirements of the future today.

Brief Description of the WL Circuit Breaker

Circuit breakers today are no longer simply devices for protecting plants, transformers, generators and motors. Many users now require a complete overview of the plant from a central control room and round-the-clock access to all available information. Modern power distribution systems are characterized by the methods used to network circuit breakers—both with each other and other components. The circuit breakers in the

WL Circuit Breaker family have a lot to offer: It is possible to carry out analysis and maintenance procedures remotely via the Internet. Operating staff can be given immediate access to information on system status and alarms. This is not just a vision of the future, but reality. The WL Circuit Breaker covers the entire range from 200A to 5000A. The devices are available with different interrupting ratings, allowing short-circuit currents of up to

200kA to be interrupted reliably. WL Circuit Breakers can be adapted to different system conditions, which means that a rating plug can be used to adapt each circuit breaker to the appropriate rated current. This ensures that optimum protection is provided, even if changes have been made in the system. The modules (reference Graphic 2-1) can be replaced without the need for the transformer to be changed.

Note: Installation instructions related to the communication modules described in this section can be found in the individual instruction sheets and/or Section 9 of the Operator's Manual

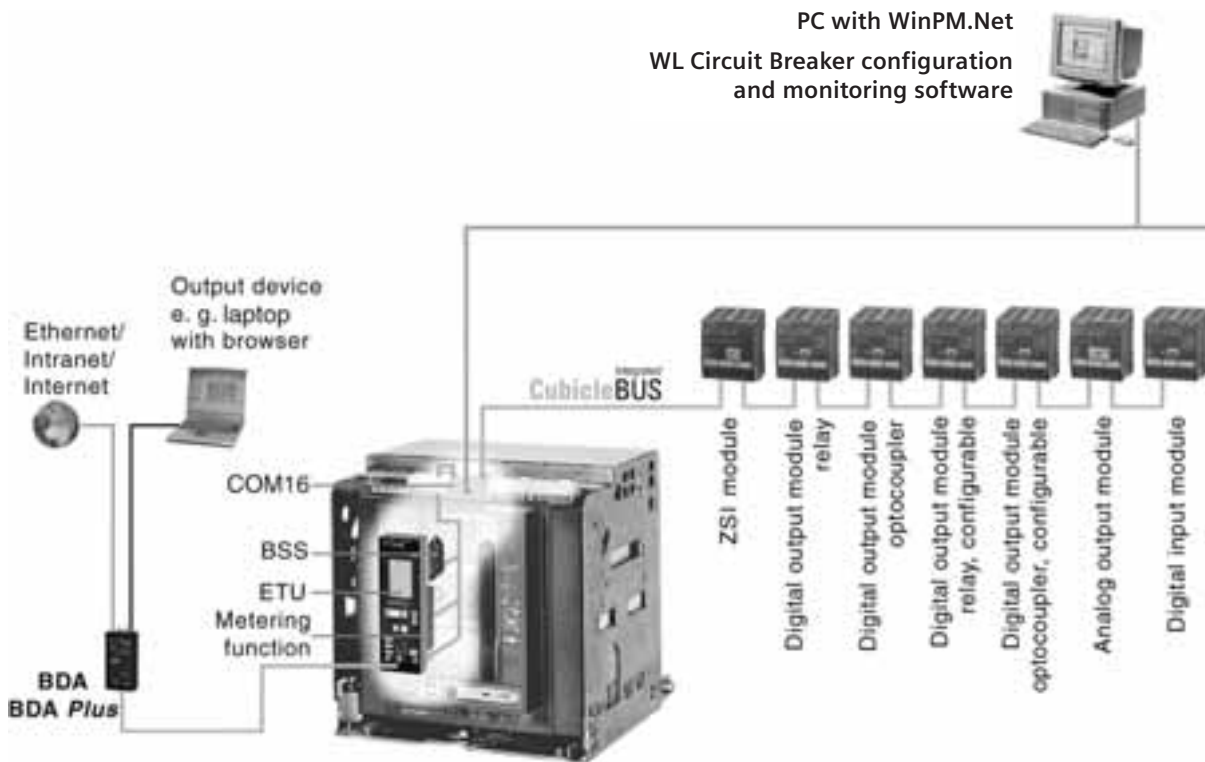

Graphic 2-1 The system architecture of the WL Circuit Breaker with **CubicleBUS** enables simultaneous communication via MODBUS and BDA with a laptop or Ethernet/Intranet/Internet.

The ability to change between two different parameter sets is also possible. This function is particularly useful in the event of a power failure when an automatic transfer is made from utility to generator power, a process which can involve changing many of the trip unit parameters.

A wide range of lock-out systems are available to improve reliability during critical processes. All accessories, such as shunt trips, motor operators and communication components, can be installed quickly and easily; this is made easier because the accessories are identical across the entire product line. The commitment to reducing the overall number of parts results in fewer spares to be ordered and lower inventory costs.

The heart of each circuit breaker is the electronic trip unit (ETU). Several versions are available to adapt the protective, metering, and alarm functions to the system requirements: from simple overload and short-circuit protection to trip units that can be configured remotely and which feature a wide range of metering and alarm functions.

All circuit breakers with ETU745, ETU748, ETU755 and ETU776 trip units are communications capable, and allow additional components to be internally networked via the **CubicleBUS**.

The circuit breaker is connected to MODBUS via the RS485 interface on the COM16 module.

The breaker data adapter (BDA) (see Chapter 4) also supports higher-level networking/communication (Intranet/Internet).

The **CubicleBUS**

The **CubicleBUS**, which connects all the intelligent components within the WL Circuit Breaker and enables additional external components to be connected quickly and reliably, forms the backbone of the modular architecture of the WL. The **CubicleBUS** is already integrated in and connected to all assembled circuit breakers with the ETU745, ETU748, ETU755, and ETU776 trip units.

The high level of system modularity enables communication functions (e.g. metering function) to be retrofitted at any time. A WL Circuit Breaker that is not communications capable can be upgraded (e.g. by exchanging ETU725 for ETU745 with **CubicleBUS**) quickly and easily on site. All **CubicleBUS** modules can access the existing data of the circuit breaker directly, thereby ensuring rapid access to information and speedy responses to events.

By connecting additional, external modules to the **CubicleBUS**, cost-effective solutions for communicating data from other devices in the cubicle can be implemented.

Communications Capability of the Electronic Trip Units (ETUs)

The electronic trip units ETU745, ETU748, ETU755, and ETU776 are all communications capable. The **CubicleBUS** is connected to the circuit breaker terminals X8.1(-) to X8.4(+)

Different versions of communications-capable trip units are available.

The front of the ETU745 has rotary switches for setting protective parameters. These can be read via the communication device. The ETU745 can also be installed with a four-line display for the measured values.

The ETU755 does not have rotary switches or a display. The protective parameters can only be changed via communications. This trip unit with remote-only parameter setting is for special application demands.

The ETU776 features a graphical display with a clearly structured, key-driven menu. This not only enables operators to display measured values, status information, and maintenance information, but also to read all the existing parameters and make password-protected changes.

Communication-capable Circuit Breakers

WL Circuit Breaker

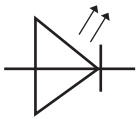
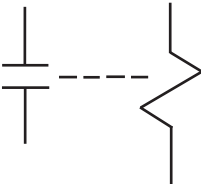
Basic Functions	ETU725	ETU727	ETU745
Parameter sets			
Selectable between parameter set A and B	–	–	–
LCD			
LCD, alphanumeric (4-line)	–	–	o
LCD, graphic	–	–	–
Communication			
CubicleBUS integrated	–	–	✓
Communication capability via MODBUS or PROFIBUS	–	–	✓
Metering function			
Metering function capability with Metering Function PLUS	–	–	✓
Display by LED			
 Trip unit active	✓	✓	✓
Alarm	✓	✓	✓
ETU error	✓	✓	✓
L trip	✓	✓	✓
S trip	✓	✓	✓
I trip	✓	✓	✓
N trip	–	✓	✓
G trip	–	✓	✓ (only with ground fault module)
G alarm	–	–	✓ (only with ground fault module)
Tripped by extended protection or protective relay function	–	–	✓
Communication	–	–	✓
Signal contacts with external CubicleBUS modules (Opto or relay)			
 Overcurrent warning	–	–	✓
Load shedding ON/OFF	–	–	✓
Early signal of long-time trip (200 ms)	–	–	✓
Temperature alarm	–	–	✓
Phase unbalance	–	–	✓
Instantaneous trip	–	–	✓
Short-time trip	–	–	✓
Long-time trip	–	–	✓
Neutral conductor trip	–	–	✓
Ground fault protection trip	–	–	✓ (only with ground fault module)
Ground fault alarm	–	–	✓ (only with ground fault module)
Auxiliary relay	–	–	✓
ETU error	–	–	✓

Step for Settings via Communications or ETU Key Pad

from ... to	step	from ... to	step
0 ... 1	0.1	1000 ... 1600	50
1 ... 100	1	1600 ... 10000	100
100 ... 500	5	10000 ... max	1000
500 ... 1000	10		

Setting range of the I_g

	Frame Size II	Frame Size III
A	100 A	400 A
B	300 A	600 A
C	600 A	800 A
D	900 A	1000 A
E	1200 A	1200 A

- ✓ available
- not available
- o optional

Communication-capable Circuit Breakers

WL Circuit Breaker

Functional overview of the trip unit system

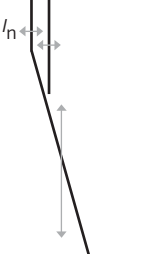
Basic Functions		ETU748	ETU755	ETU776
	Long-time overcurrent protection Function can be switched ON/OFF Setting range $I_R = I_n \times \dots$	✓ – 0.4, 0.45, 0.5, 0.55, 0.6, 0.65, 0.7, 0.8, 0.9, 1	✓ – 0.4 ... 1 (step: 1A)	✓ – 0.4 ... 1 (step: 1A)
	L Switch-selectable overload protection (I^2t or $A t$ dependent function) Setting range of time delay class t_R at I^2t (seconds) Setting range of time delay t_R at $A t$ (seconds) Thermal memory Phase loss sensitivity	✓ 2, 3.5, 5.5, 8, 10, 14, 17, 21, 25, 30 1, 2, 3, 4, 5 ✓ (via slide switch)	✓ (via communications) 2 ... 30 (step: 0.1s) 1 ... 5 (step: 0.1s) ✓ (on/off via communications)	✓ 2 ... 30 (step: 0.1s) 1 ... 5 (step: 0.1s) ✓ (on/off via key pad or communications)
	N Neutral protection Function can be switched ON/OFF N-conductor setting range $I_N = I_n \times \dots$	– – 0.5, 1, OFF	✓ ✓ (via communications) 0.5, 1, OFF	✓ ✓ (via key pad or communications) 0.5 ... 2, OFF
	S Short-time delayed overcurrent protection Function can be switched ON/OFF Setting range $I_{sd} = I_n \times \dots$ Setting range of time delay t_{sd} , fixed (seconds) Switch-selectable short-time delay short-circuit protection (I^2t dependent function) Setting range of time delay t_{sd} at I^2t (seconds) Zone Selective Interlocking (ZSI) function	✓ – 1.25, 1.5, 2, 2.5, 3, 4, 6, 8, 10, 12 M, 0.1, 0.2, 0.3, 0.4 ✓ (via rotary switch) 0.1, 0.2, 0.3, 0.4 per CubicleBUS module	✓ ✓ (via communications) 1.25 ... 0.8 x $I_{CW} = \max$ (step: 10A) M, 0.08 ... 0.4, OFF (step: 0.001s) ✓ (via communications) 0.1 ... 0.4 (step: 0.001s) per CubicleBUS module	✓ ✓ (via key pad or communications) 1.25 ... 0.8 x $I_{CW} = \max$ (step: 10A) M, 0.08 ... 0.4, OFF (step: 0.001s) ✓ (via key pad or communications) 0.1 ... 0.4 (step: 0.001s) per CubicleBUS module
	I Instantaneous overcurrent protection Function can be switched ON/OFF, Extended Instantaneous Protection is enabled when OFF Setting range $I_i = I_n \times \dots$	✓ – – $I_i = I_{CW} = EIP$ ^① o (field installable module)	✓ – – $I_i = I_{CW} = EIP$ ^① o (field installable module)	✓ – – $I_i = I_{CW} = EIP$ ^① o (field installable module)
	G Ground fault protection ^② Trip and alarm function Detection of the ground fault current by residual summing method Detection of the ground fault current by direct sensing method Setting range of the I_g for trip Setting range of the I_g for alarm Setting range of the time delay t_g (seconds) Switch-selectable ground fault protection (I^2t / I fixed) Setting range time delay t_g at I^2t ZSI ground function	✓ ✓ ✓ A, B, C, D, E A, B, C, D, E 0.1, 0.2, 0.3, 0.4, 0.5 ✓ 0.1, 0.2, 0.3, 0.4, 0.5 per CubicleBUS module	✓ ✓ ✓ A ... E (step: 1A) A ... E (step: 1A)- 0.1 ... 0.5 (step: 0.001s) ✓ 0.1 ... 0.5 (step: 0.001s) per CubicleBUS module	✓ ✓ ✓ A ... E (step: 1A) A ... E (step: 1A) 0.1 ... 0.5 (step: 0.001s) ✓ 0.1 ... 0.5 (step: 0.001s) per CubicleBUS module

① Extended Instantaneous Protection (EIP) allows the WL breaker to be applied at the withstand rating of the breaker with minus 0% tolerance; that means no instantaneous override whatsoever. EIP further enables the circuit breaker to be applied up to the full instantaneous rating of the breaker on systems where the available fault current exceeds the withstand rating.

② Ground Fault Module cannot be removed after installation.

✓ available
– not available
o optional

Notes:

M = Indicates phase loss sensitivity is enabled. LT pickup reduced 80% when phase unbalance > 50%. ST delay = 20ms

Communications = Setting the parameters of the trip unit via the Breaker Data Adapter, MODBUS, or PROFIBUS

Key pad = Direct input at the trip unit

Communication-capable Circuit Breakers

WL Circuit Breaker

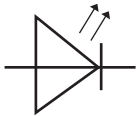
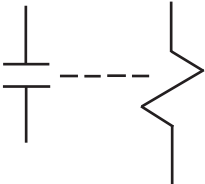
Basic Functions		ETU748	ETU755	ETU776
Parameter sets				
	Selectable between parameter set A and B	–	✓	✓
LCD				
	LCD, alphanumeric (4-line)	o	–	–
	LCD, graphic	–	–	✓
Communication				
	CubicleBUS integrated	✓	✓	✓
	Communication capability via MODBUS or PROFIBUS	✓	✓	✓
Metering function				
	Metering function capability with Metering Function PLUS	✓	✓	✓
Display by LED				
	Trip unit active	✓	✓	✓
	Alarm	✓	✓	✓
	ETU error	✓	–	✓
	L trip	✓	✓	✓
	S trip	✓	✓	✓
	I trip	–	✓	✓
	N trip	✓	✓	✓
	G trip	✓ (only with ground fault module)	✓ (only with ground fault module)	✓ (only with ground fault module)
	G alarm	✓ (only with ground fault module)	✓ (only with ground fault module)	✓ (only with ground fault module)
	Tripped by extended protection or protective relay function	✓	✓	✓
Communication	✓	✓	✓	
Signal contacts with external CubicleBUS modules (Opto or relay)				
	Overcurrent warning	✓	✓	✓
	Load shedding ON/OFF	✓	✓	✓
	Early signal of long-time trip (200 ms)	✓	✓	✓
	Temperature alarm	✓	✓	✓
	Phase unbalance	✓	✓	✓
	Instantaneous trip	✓	✓	✓
	Short-time trip	✓	✓	✓
	Long-time trip	✓	✓	✓
	Neutral conductor trip	✓	✓	✓
	Ground fault protection trip	✓ (only with ground fault module)	✓ (only with ground fault module)	✓ (only with ground fault module)
	Ground fault alarm	✓ (only with ground fault module)	✓ (only with ground fault module)	✓ (only with ground fault module)
	Auxiliary relay	✓	✓	✓
	ETU error	✓	✓	✓

✓ available
 – not available
 o optional

Communication-capable Circuit Breakers

WL Circuit Breaker

Data Availability on the CubicleBUS

All modules connected to the **CubicleBUS** can request data from other modules via the bus and generate data themselves that can be read by other modules.

Each data point in the comprehensive WL Circuit Breaker data dictionary can only be generated by a single module—the data source. If this data source (module) exists, the data points assigned to it also exist.

This information is described and communicated in the property bytes.

If a data source (module) does not exist, the data point does not exist either.

Again, the relevant property byte contains this information.

The following table provides an overview of the internal **CubicleBUS** modules and the data point groups (collection of several data points) assigned to them.

See Chapter 3 Register List for a detailed description of the individual data points.

Data point group Data points with the same source	CubicleBUS Modules			
	ETU745, 748, 755 or 776	BSS	COM16	Metering Function <i>Plus</i>
Protection parameter set A	✓			
Protection parameter set B (N/A for ETU745 or 748)	✓			
Extended protection parameters				✓
Parameter for setpoints				✓
MODBUS communication parameters			✓	
Parameters for metering settings				✓
Device identification data	✓		✓	
Circuit breaker position specifications			✓	
Status info. (circuit breaker open/closed, storage spring, etc.)		✓		
Alarms	✓			
Trip log	✓			✓
Setpoint messages				✓
Maintenance information	✓		✓	
Circuit breaker temperature		✓		
Temperature in the cubicle			✓	
3-phase currents	✓			
Current in neutral, ground-fault current; equip. spec.	✓			
3-phase voltage				✓
Power KW, KVAR, KVA				✓
Power factor				✓
Frequency, total harm. distortion, form factor, crest factor				✓
Harmonic analysis				✓
Waveform buffer				✓
Event log			✓	
System time			✓	

Table 2-2 The table shows which data points from the data dictionary are generated by which **CubicleBUS** module, enabling you to quickly find out which modules are required for which system.

The MODBUS COM16 Module and the BSS

The COM16 module enables the WL Circuit Breaker to exchange data via MODBUS to supervisory systems and MODBUS masters. The COM16 module retrieves some of the key data on the status of the circuit breaker (circuit breaker open/closed, closing spring charged, ready-to-close, etc.) via the **CubicleBUS** from the BSS (breaker status sensor). Both modules are, therefore, offered together as a MODBUS communication package.

MODBUS Module COM16

The COM16 module for the WL enables the circuit breaker to be connected to any MODBUS master network. This makes it easy to add WL and a COM16 to existing MODBUS networks.

If required, control/write access to the circuit breaker can be locked using hardware and software to prevent any switching operations

taking place via MODBUS (manual or automatic operation) or parameters from being changed.

All key events are assigned a time stamp from the integrated clock to enable operators to keep track of alarms. This device clock can be synchronized with the clock in the automation system.

A temperature sensor integrated in the COM16 module measures the temperature surrounding the breaker in the switchgear cubicle.

Three integrated microswitches located in the COM16 module are used to detect the position of the circuit breaker (connect, test, disconnect and not present) and communicate via MODBUS. The circuit breaker can be remotely operated only in the test or connect position.

Pin Configuration

The COM16 module is connected to the auxiliary conductor plug-in system at X7.

The electrical connections to the circuit breaker and the **CubicleBUS** connection to the internal **CubicleBUS** modules (ETU, BSS, metering function, etc.) are defined in Section 9 of the Operator's Manual and the individual instruction sheets.

Interposing relays must be used if the opening and closing solenoids are designed for voltages other than 24V DC.

Terminals X9.1 and X9.2 must be used if the second shunt trip rather than the first shunt trip is used to open the circuit breaker via communication.

The unassigned user output can be used as required and must be connected in the same way as a coupling device (see Graphic 2-4). It can be used, for example, to reset the trip indicator if the remote reset option has been installed. As with Open and Close, only voltages of up to 24V DC are permitted (note the polarity); coupling devices must be used for higher voltages.

The communications line is connected to the 9-pin interface on the front of the COM16 module. The **CubicleBUS** connection for a RJ45 plug is located at the rear and is used to connect the external **CubicleBUS** modules. If no external **CubicleBUS** module is connected, the terminating resistor supplied must be used as an RJ45 plug.

The unassigned user input can be connected using a contact element with the 24V DC from pin 1 to transmit the status of the contact element.

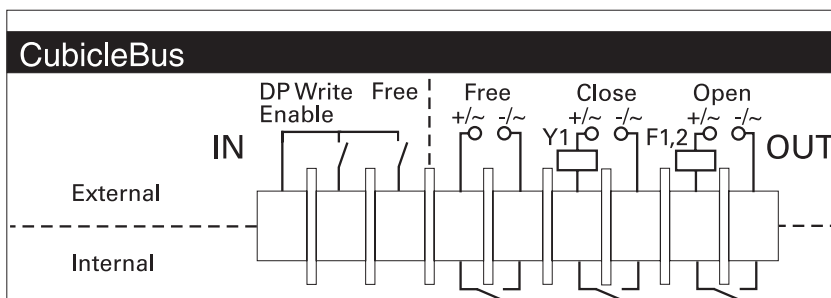

Graphic 2-2 The text on the COM16 module shows the external pin configuration for connecting the closing solenoid and the shunt trips, as well as the MODBUS write protection function and the unassigned input/output.

Communication-capable Circuit Breakers

WL Circuit Breaker

MODBUS Write Protection (DPWriteEnable)

Write access via communications can be blocked either temporarily or permanently.

The COM16 module features a hardware input for this purpose. Pin 1 provides the 24V DC supply, which can be connected to pin 2.

If this input is not bridged, write access and control is disabled.

The following actions are blocked if the input of the write-protect function has not been enabled:

- Breaker open/close
- Reset the last trip
- Change the protective parameters
- Change the parameters for the extended protection function (metering function)
- Change the communication parameters
- Settings of the metering options
- Reset maintenance information (counters)
- Force the digital outputs from WinPM.Net

The following control functions are available even if the write protection function has not been enabled:

- Change and set the trigger functions for the waveform buffer
- Read the content of the waveform buffer
- Change the setpoint parameters
- Set/change the system time
- Change the free texts (comments, system IDs)
- Reset the min./max. values
- Change the unassigned user output

MODBUS Installation Guideline

The COM16 must be assembled and connected as described in the WL Operating Instructions. Of particular importance is the requirement to ground the shield of the MODBUS cable.

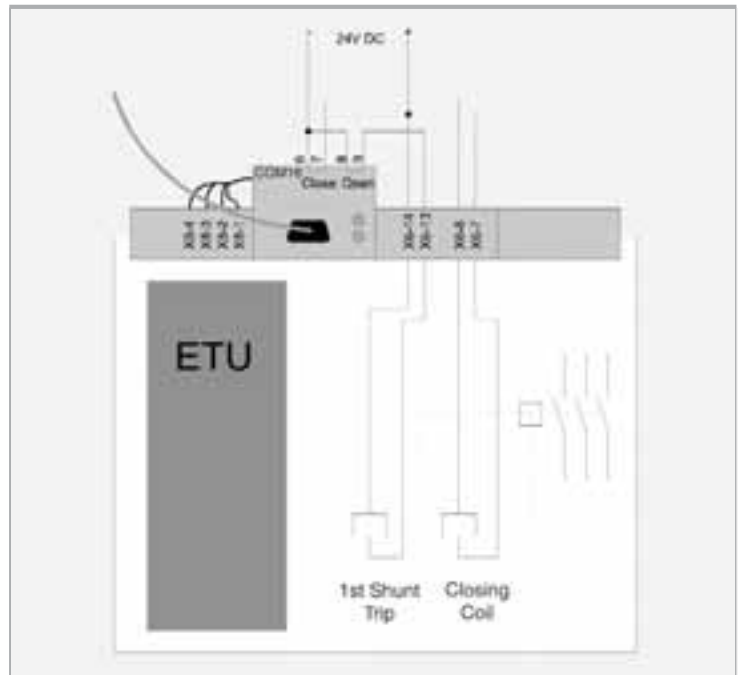

Graphic 2-3

This diagram illustrates how to wire the COM16 module if MODBUS is to be used to switch the device open and closed. This diagram only applies to 24V DC control voltage.

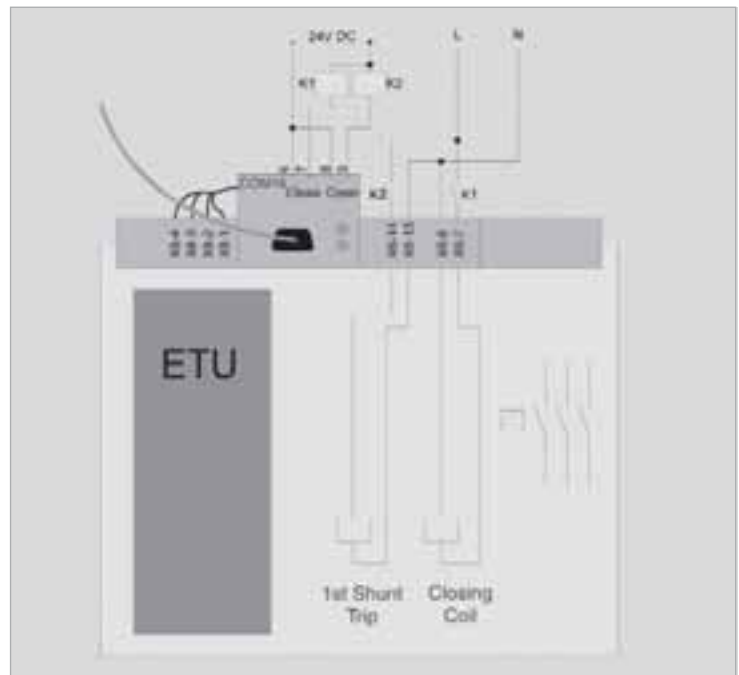

Graphic 2-4

Interposing relays are required if a control voltage different than 24V DC is used. If the 1st shunt trip is not used to switch off the device, use terminals X9.1 and X9.2 to utilize the 2nd shunt trip.

Communication-capable Circuit Breakers

WL Circuit Breaker

The write-protect function ensures that all the required information can be transmitted, but prevents any changes to the status of the circuit breaker. Changes can then only be made locally.

Why does the write protection function permit certain actions?

All actions that are not blocked are for remote analysis only and do not have any effect on the current status.

Data Exchange via the COM16 Module

When the COM16 module is configured to exchange data, it is important to note that it is shipped as standard with MODBUS address 126. This can be changed during system configuration (e.g. with the BDA, WinPM.Net, WL Config software or ETU776 display).

The COM16 module has two LEDs (MODBUS and **CubicleBUS**) for diagnostic purposes. These indicate the operating status of the communication line and the **CubicleBUS** networks.

Two LEDs are used to determine whether a **CubicleBUS** module in the circuit breaker is operational. First, the "COMM" LED on the trip unit must be green, that is, the trip unit has recognized at least one other **CubicleBUS** module. At a minimum, this would only be the Metering Function *PLUS* if the **CubicleBUS** was then interrupted. Second, the **CubicleBUS** LED on the COM16 module must be taken into account. If this is lit with a steady green light, a connection exists from the COM16 module to at least the metering function *Plus* module.

If both LEDs are green (steady light for **CubicleBUS** on the COM16 module and COMM on the trip unit), communication is fully established between the trip unit and the COM16 module.

Data is exchanged according to the following principle: an up-to-date copy of all WL Circuit Breaker data (apart from the waveform buffer) is always stored in the COM16 module. A response to a data query from the COM16 module to the supervisory system can, be typically transmitted in just a few milliseconds. Write data from the supervisory system is forwarded to the appropriate addressee on the **CubicleBUS**.

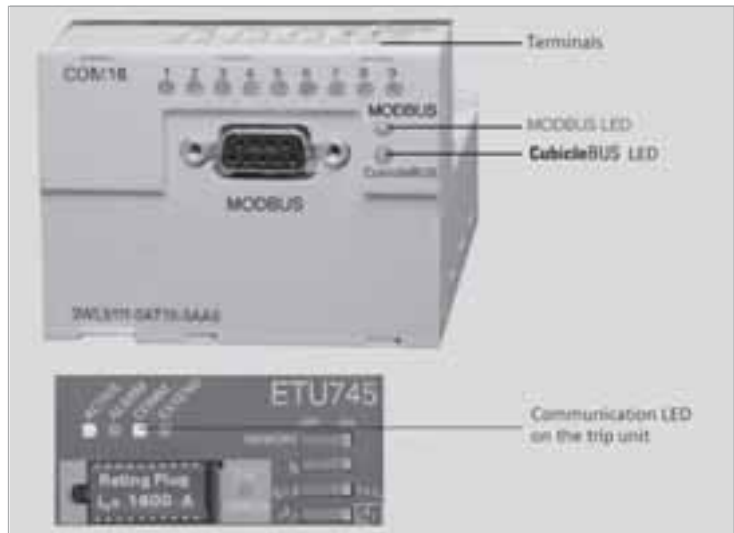

Figure 2-1

Front view of the MODBUS module for the WL Circuit Breaker with the MODBUS connection and the two LEDs. The figure below shows a section of the ETU745 and its LEDs for displaying status.



Graphic 2-2

Rear view of the COM16 module. The RJ45 connection for the external **CubicleBUS** modules can be clearly seen here. If no external **CubicleBUS** module is connected, the bus must be terminated with the terminating resistor.

Meaning	Position and text on the cable
CubicleBUS -	X7.1
CubicleBUS +	X7.2
24V DC +	X7.3
24V DC ground	X7.4

Table 2-3 The 4 black cables from the COM16 module must be connected to terminal strip X7, which is used to connect the COM16 module to the modules on the **CubicleBUS** in the circuit breaker.

Communication-capable Circuit Breakers

WL Circuit Breaker



MODBUS LED	Meaning
Off 	No voltage on the COM16 module
Red 	Bus error Communication not possible No communication with class 1 master
Green 	MODBUS communication OK Cyclic data transmission with class 1 master

Table 2-4 The MODBUS LED provides information on the state of MODBUS communication in the COM16 module.





CubicleBUS LED	Meaning
Off 	No CubicleBUS modules found
Red 	CubicleBUS error
Green flashing 	CubicleBUS module found, but no metering function Plus or trip unit
Steady green light 	CubicleBUS module found and connection with the metering function Plus and/or trip unit

Table 2-5 The CubicleBUS LED provides information on the state of CubicleBUS communication in the COM16 module.

Position	Rear microswitch (S46)	Middle microswitch (S47)	Front microswitch (S48)
Connect position	1	0	0
Test position	0	1	0
Disconnect position	0	0	1
Circuit breaker fully withdrawn	0	0	0

Table 2-6 The COM16 module has 3 microswitches for determining the position of the circuit breaker in the guide frame. Depending on which switch is actuated, the position described above is communicated via the comm. system (1=contact closed, 0=contact open).

Three microswitches located in the COM16 module can determine the position of a drawout circuit breaker in the guide frame, which is then communicated via the COM16 module. The positions are defined in Table 2-6. When the position of the circuit breaker has changed, the microswitch that has been actuated is opened before the next microswitch is actuated. No microswitches are actuated if the breaker is between two of the three positions. The previous state is communicated until a new position is reached when the circuit breaker is moved (see Table 2-6).

There is no way of determining the direction in which the circuit breaker is being moved once the "disconnect position" microswitch has been opened.

When the circuit breaker is initially racked in, the next microswitch to be actuated is the "test position." The COM16 module communicates "circuit breaker not present" until the "test position" key is actuated. The new event message is delayed by 10 seconds to ensure that the breaker is firmly seated.

When the circuit breaker is fully withdrawn, no further microswitches are actuated. "Circuit breaker fully withdrawn" is communicated immediately.

The sequence described above provides hysteresis for communicating contact position and avoids intermittent contact positions from being communicated.

With UL 489 fixed-mounted circuit breakers, a heel plate is screwed to the COM16 module to transmit operating position.

The COM16 module features a built-in temperature sensor, which is installed outside the circuit breaker, and measures the temperature surrounding the breaker.

It also contains a clock that provides a time stamp for all events, such as minimum and maximum measured values, as well as warnings and trips.

Breaker Status Sensor (BSS)

BSS stands for "breaker status sensor." All microswitches that contain information on the state of the circuit breaker are either installed directly to the BSS or connected to it. The BSS makes this digital information available on the **CubicleBUS**.

If the status of the circuit breaker in the switchgear is to be displayed or read via communications, the BSS module and the appropriate signaling switch must be installed (if they are not already). The circuit breaker must be installed with an electronic trip unit of type ETU745 or higher.

The BSS can also be field installed.

The BSS indicates the following information:

- Closing spring (charged/discharged)
- Position of the main contacts (open/closed)
- Ready-to-close signal
- Bell Alarm switch on the trip unit (connected to the red mechanical trip indicator)
- Signaling switch on the first shunt trip
- Signaling switch on the second shunt trip

The BSS is included when you order the communications option with the assembled circuit breaker.

If a BSS is required without communication (e.g. for operating the BDA), it can be ordered separately.

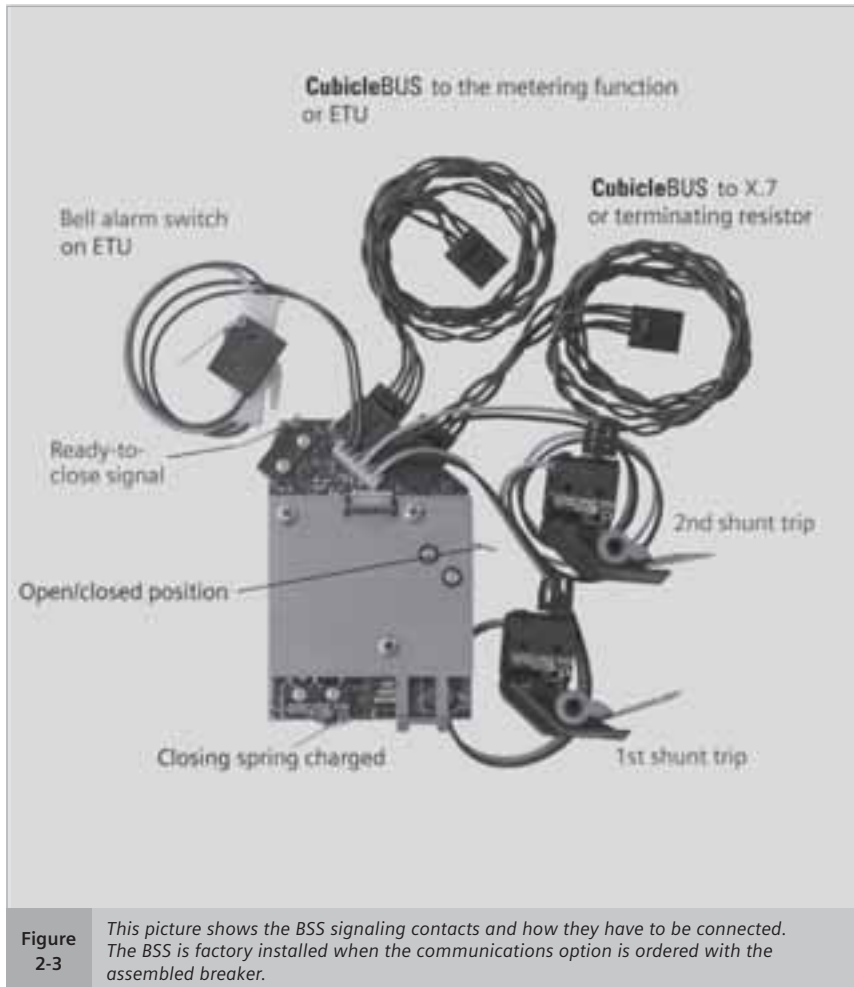

Figure 2-3 This picture shows the BSS signaling contacts and how they have to be connected. The BSS is factory installed when the communications option is ordered with the assembled breaker.

Communication-capable Circuit Breakers

WL Circuit Breaker

Metering Function *Plus*

The integrated metering function can be used with all trip units with a **CubicleBUS** connection. It not only extends the range of protection functions of the trip unit but also provides additional warnings and diagnostic options. With its comprehensive range of measured values, the integrated WL Circuit Breaker metering function is an excellent alternative to external multi-function metering devices.

General

In addition to the current values supplied by the trip unit, the metering function provides the measured values in the power distribution system required for Power Management (voltage, power, etc.). With its extended protection function (e.g. undervoltage), the metering function also provides further options for monitoring and protecting the power distribution system.

The option of generating warnings if setpoints are exceeded, speeds up response to system alerts. As a result, the metering function can significantly increase system up-time.

The metering function module is installed on the back of the trip unit (ETU), as shown in Fig. 2-4. The trip unit and metering function module exchange all current data via a high-speed synchronous interface. The metering function module provides all the connected modules (e.g. the COM16 module or BDA) with the parameters for the protective relay functions, the setpoints, measured value settings, and the measured values via the **CubicleBUS**, so that they can be processed further. Using the two **CubicleBUS** connections, the metering function module is connected to the trip unit and either the BSS or directly to X7.

The metering function can be implemented in all circuit breakers with ETU745, ETU755, ETU748 and ETU776. If the Metering Function PLUS module is ordered with the assembled circuit breaker, it will already be installed and ready for operation. The metering function can be retrofitted at any time if the circuit breaker is equipped with one of the trip units listed above. It is simply screwed onto the trip unit and the **CubicleBUS** lines are snapped in.

Note: If installed by the customer, the metering function is not calibrated with the trip unit; therefore, the accuracy of the specifications in Table 2-7 cannot be guaranteed.

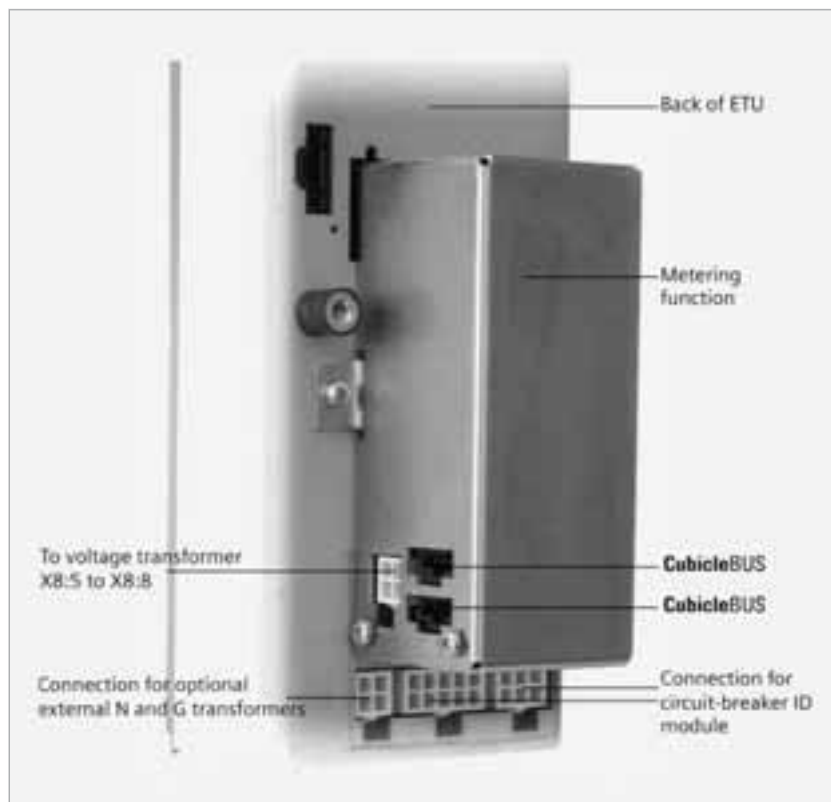

Figure 2-4

The Metering Function Plus is located on the back of the trip unit. When ordered as part of an assembled breaker catalog number, it is already installed and ready for operation.

Metering Function Plus

The Metering Function Plus module extends the range of metering functions to include harmonic and waveform analysis.

Harmonic analysis

The Metering Function Plus module senses the current and voltage, saves the measured values, and carries out a fast Fourier transformation. The result is the distribution of the harmonics (in %) up to the 29th harmonic. The calculated values are made available via the **CubicleBUS** and can be displayed in WinPM.Net and the BDA (see Chapters 3 and 4). They can also be saved as an Excel-compatible *.csv file for subsequent diagnosis. On the ETU776 trip unit, the measured and calculated values can also be displayed.

The harmonic analysis enables not only the quality of the network to be analyzed and logged but also provides settable alarm levels.

Waveform buffer

The Metering Function Plus module features two independent waveform buffers (A and B). Each one has 8 channels, one each for currents I_a , I_b , I_c , I_N , and I_g , and voltages V_a , V_b , and V_c . Each channel is sensed with a frequency of 1,649 kHz and the values are "pushed" through a shift register (length: 1 second). The process of pushing data through the shift register can be aborted by a configurable trigger event. Trigger events include trips, warnings and setpoint alarms so that the voltage waveform, for example, can be recorded in the event of undervoltage tripping.

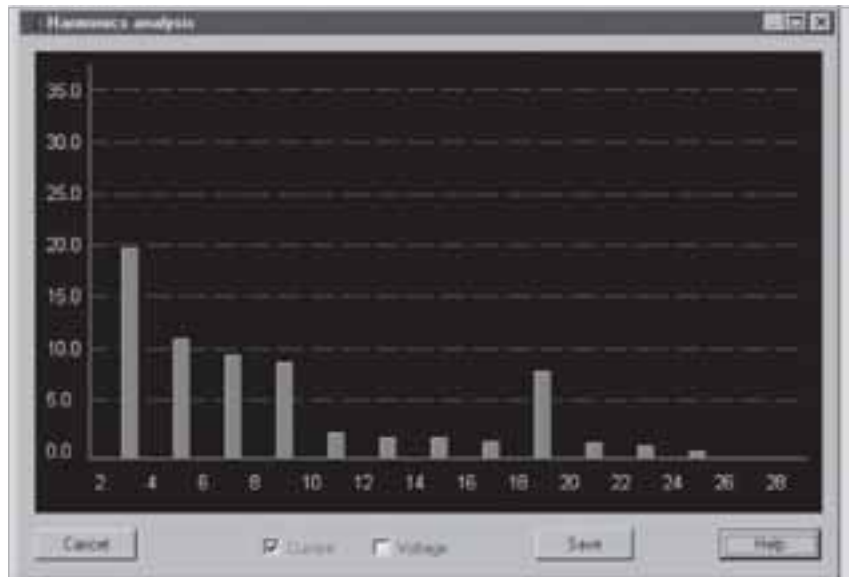

Figure 2-5 The Metering Function Plus analyzes the harmonics. This screenshot from the WinPM.Net system shows how the analysis results are displayed.

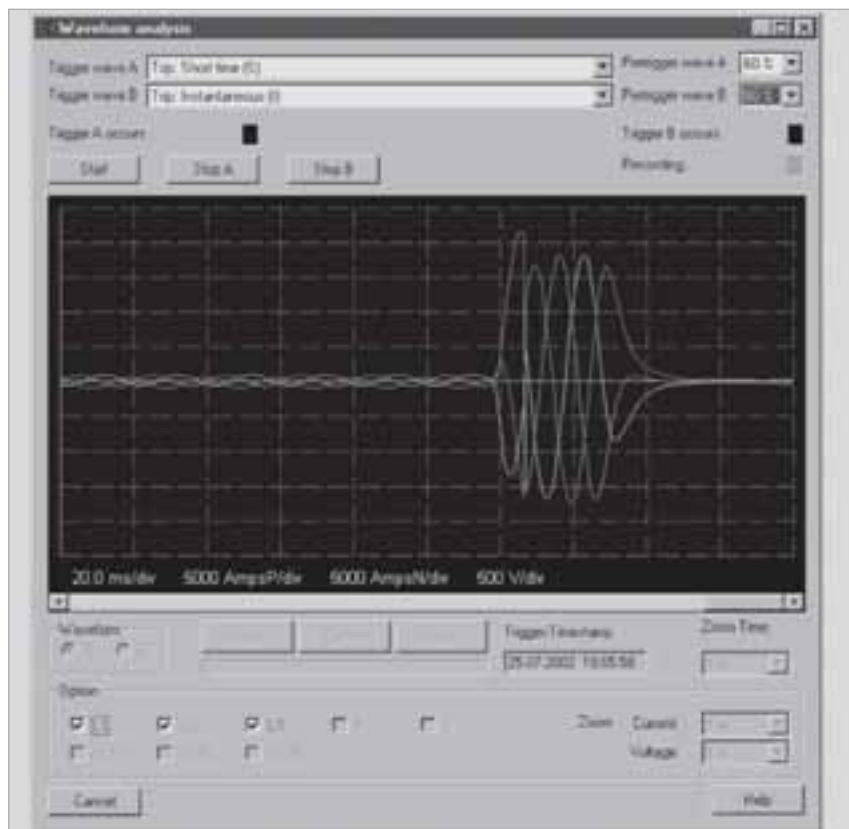

Figure 2-6 Metering Function PLUS can record the current waveform. This can be displayed and exported using WinPM.Net. A value of trip current is shown here.

Communication-capable Circuit Breakers

WL Circuit Breaker

The trigger event can be set individually for each waveform buffer. The point at which the trigger event is to take place in the waveform buffer can also be defined. This setting can be used to set the ratio of the pre-event history to the post-event history. If the pre-trigger event history is to be analyzed, the position can be set to 80%. When the event occurs, 0.8 seconds of pre-event history and 0.2 seconds of post-event history are available in the waveform buffer, and an existing COM16 module adds a time stamp to the trigger event.

Each waveform buffer stops independently, depending on the trigger event and can be activated again once the analysis is complete.

A large amount of data (approx. 25 kByte for each waveform) can be downloaded and analyzed using WinPM.Net, the BDA and the ETU776 display. Depending on the option, a range of zoom options and export functions are available.

Voltage Transformers

For isolation reasons, a voltage transformer is used in conjunction with the Metering Function Plus module. This prevents voltage signals of up to 1kV from reaching the ETU directly via the auxiliary secondary connections.

The metering module ("Metering Function Plus") can be set to expect 3W or 4W (LL/LG) connections and will adjust the amplitude and phase of the signal as necessary.

Three VTs must be used at all times.

All three VTs should be rated for the nominal system L-L voltage (e.g. 480V) and may have either 100V, 110V or 120V secondary voltages.

The following ratios and suggested and equivalent VTs can be used:

- 240:120 = 2:1
(ITI Part # 460-240 or 468-240)
- 480:120 = 4:1
(ITI Part # 460-480 or 468-480)

600:120 = 5:1
(ITI Part # 460-600 or 468-600)

VT Accuracy

Each Metering Module presents a purely resistive (unity power factor) load to the transformer. Assuming no other devices connected to the VT, a ITI type 486 VT can safely feed 10 metering modules and still maintain 0.6% accuracy assuming the wiring from the VT to the individual metering modules is twisted pair and kept to a minimum length.

This data applies to ambient temperatures from 30°C to 50°C and a primary voltage from 80% to 120% V_n .

Maximum distance from voltage transformer

The maximum distance between the metering function and the voltage transformer depends on the cable size and the desired accuracy class.

For a 14AWG cable, the maximum distance should not exceed 50 m for class 0.5 and 100 m for class 3. In areas with high EMC exposure, shielded cable should be used.

Parameters for the settings of the metering function

The trip unit settings which must be made are:

- 1) VT Primary Voltage (240V, 480V, 600V)
- 2) VT Secondary Voltage (100V, 110V, 120V)
- 3) VT Connection (Wye / LG, Delta / LL)

The following tools and functions are available if the parameters have to be changed:

- WinPM.Net
- WL Config
- BDA/BDA Plus
- ETU776 display

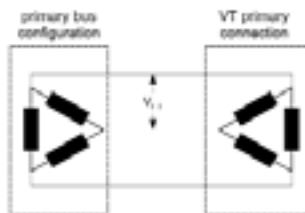

Metering VT Settings:
Delta/Wye : Delta
VT Primary: 480 (for example)
VT Secondary: 120 (for example)

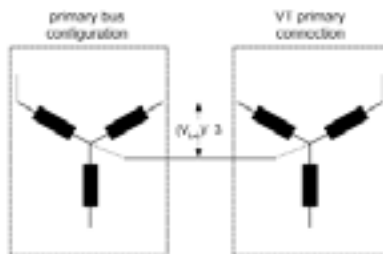
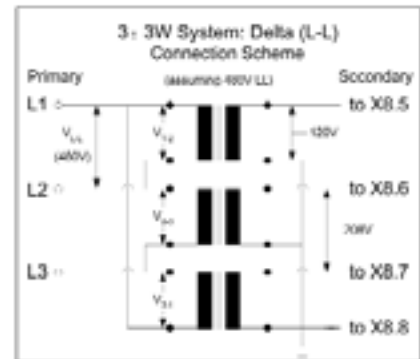

Metering VT Settings:
Delta/Wye : Delta
VT Primary: 480 (for example)
VT Secondary: 120 (for example)

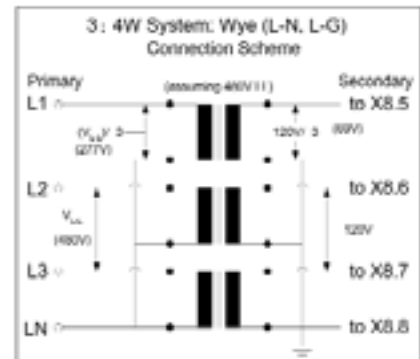

Note: Required primary and secondary overcurrent protection (fusing) not shown for clarity.

Communication-capable Circuit Breakers

WL Circuit Breaker

The metering function provides the following measured values for communication system:		
Measured value	Value range	Accuracy (with direct order: circuit breaker + trip unit + met. function or met. function Plus) ¹
Currents I_a, I_b, I_c, I_N	30 ... 8000A	± 1%
Ground-fault current I_g (measure with external G transformer)	100 ... 1200A	± 5%
Line-to-line voltages V_{ab}, V_{bc}, V_{ca}	80 ... 120% V_n	± 1%
Line-to-neutral voltages V_{an}, V_{bn}, V_{cn}	80 ... 120% V_n	± 1%
Average value of phase-to-phase voltages V_{LLAVG}	80 ... 120% V_n	± 1%
Apparent power kVA per phase	13 ... 8000kVA	± 2%
Total apparent power kVA	13 ... 24000kVA	± 2%
Active power kW per phase	-8000 ... 8000kW	± 3% (power factor > 0.6)
Total active power kW_{total}	-24000 ... 24000kVA	± 3% (power factor > 0.6)
Reactive power kvar	-6400 ... 6400kvar	± 4% (power factor > 0.6)
Total reactive power kvar	-20000 ... 20000kvar	± 4% (power factor > 0.6)
Power factor per phase	-0.6 ... 1 ... 0.6	± 0.04
Power factor total	-0.6 ... 1 ... 0.6	± 0.04
Demand of currents I_a, I_b, I_c	30 ... 8000A	± 1%
Average demand of 3-phase current	30 ... 8000A	± 1%
Demand kWD per phase	13 ... 8000kW	± 3% (power factor > 0.6)
kW demand 3-phase active power kWD total	13 ... 8000kW	± 3% (power factor > 0.6)
kVA demand kVA total	13 ... 8000kVA	± 2%
kVAR demand kVAR per phase	13 ... 8000kVA	± 2%
kVAR demand total	-24000 ... 24000kvar	± 4% (power factor > 0.6)
kWhr imported	1 ... 10000MWh	± 2%
kWhr exported	1 ... 10000MWh	± 2%
kVARh imported	1 ... 10000Mvarh	± 4%
kVARh exported	1 ... 10000Mvarh	± 4%
Frequency	15 ... 440 Hz	± 0.1 Hz
Total harmonic distortions for current and voltage	2 ... 100%	± 3% from the meas. range up to the 29th harmonic
Phase unbalance for current and voltage	2 ... 150%	± 1%

Table 2-7 The metering function provides a minimum and maximum measured value for each measured value specified above. If the metering function is retrofitted by the customer, the accuracy of the values specified cannot be ensured, since it will not have been calibrated with the trip unit.

1. Accuracy is specified as follows: ± (x%) from the upper limit of effective range + 2 LSD (Least Significant Digit) as shipped from the factory

Measurement conditions:

Frequency	$f = 60 \text{ Hz}$	Power supply	UL Listed 24V DC class 2
Power factor	$\cos\phi = 1$	Warm-up period	2 hours
Waveform	Total harmonic distortions ≤ 5%; symmetrical load	Relative air humidity	Up to 90%
Ambient temperature	$35^\circ\text{C} \pm 5^\circ\text{C}$		

Metering range:

Current	$0.2 \dots 1.2 I_{nmax}$
Voltage	$0.8 \dots 1.2 V_{nmax}$

Communication-capable Circuit Breakers

WL Circuit Breaker

The extended protective relay functions of the metering function can monitor the following criteria and initiate a trip if values are exceeded.

Protective Relay Function	ANSI Device Number	Setting range	Possible delay
Current unbalance	46	5 ... 50%	0 ...15 s
Total harmonic distortion - current	81THDC	5 ... 50%	5 ...15 s
Voltage unbalance	47	5 ... 50%	0 ...15 s
Undervoltage	27	100 ... 1100V	0 ...15 s
Overvoltage	59	200 ... 1200V	0 ...15 s
Total harmonic distortion - voltage	81THDV	5 ... 50%	5 ...15 s
Direction of phase rotation	47N	-	-
Active power in normal direction	32	13 ... 4000kW	0 ...15 s
Active power in reverse direction	32R	13 ... 4000kW	0 ...15 s
Under frequency	81U	40 ... 70 Hz	0 ...15 s
Over frequency	81O	40 ... 70 Hz	0 ...15 s

Table 2-8 Additional trip criteria can be set using the extended protective relay functions. A delay time can be set to prevent transient events from causing nuisance trips: the circuit breaker will not trip unless the condition is present for longer than the delay time.

The metering function supplies the following Alarm Setpoint Functions:

Alarm Function	Setting range	Possible delay
Over current	30 ... 10000A	0 ... 255 s
Over current - ground fault	30 ... 10000A	0 ... 255 s
Over current - N-conductor	30 ... 10000A	0 ... 255 s
Phase unbalance - current	5 ... 50%	0 ... 255 s
Demand - current	30 ... 10000A	0 ... 255 s
Total harmonic distortion - current	5 ... 50%	5 ... 255 s
Undervoltage	15 ... 1200V	0 ... 255 s
Overvoltage	200 ... 1200V	0 ... 255 s
Phase unbalance - voltage	5 ... 50%	0 ... 255 s
Total harmonic distortion - voltage	5 ... 50%	5 ... 255 s
Crest factor	1 ... 3,000	0 ... 255 s
Form factor	1 ... 3,000	0 ... 255 s
Active power in normal direction	13 ... 10000kW	0 ... 255 s
Active power in reverse direction	13 ... 10000kW	0 ... 255 s
Leading power factor	0 ... -0.99	0 ... 255 s
Lagging power factor	0 ... 0.99	0 ... 255 s
Demand - active power	-10000 ... 10000kW	0 ... 255 s
Apparent power	13 ... 10000kVA	0 ... 255 s
Reactive power in normal direction	13 ... 10000kvar	0 ... 255 s
Reactive power in reverse direction	13 ... 10000kvar	0 ... 255 s
Demand - apparent power	13 ... 10000kVA	0 ... 255 s
Demand - reactive power	13 ... 10000kvar	0 ... 255 s
Underfrequency	40 ... 70 Hz	0 ... 255 s
Overfrequency	40 ... 70 Hz	0 ... 255 s

Table 2-9 Alarm and setpoint functions allow events to be generated when system conditions deviate from their nominal values. The generation of the events can be delayed to prevent transient conditions from "chattering". These alarms are communicated via **CubicleBUS** and can cause output contacts to close in the configurable output module and can freeze the waveform buffer in the metering function. Alarms are communicated to the COM16/15 where they can be transmitted to the master.

Important functions/parameters for communications

Thanks to their modular construction and numerous I/O modules, WL Circuit Breakers offer flexible system solutions. These solutions include load management, alarms and additional tripping conditions via the extended protective functions. Although the utilization of these functions is also possible without the use of communications, their benefits can be fully utilized when used in communication applications.

Load Management

A circuit breaker with ETU745 or higher, offers two current setpoint values for local load management, the upper setpoint being that of load shedding, the lower setpoint being that of load restore.

Note: These setpoints will not effect the circuit breaker tripping function. If the current exceeds the set load shedding value in one phase, a load shedding warning will be generated. A load restore will only be generated when this value drops below the setpoint in all three phases. The warning messages are directly displayed by the BDA. However, they are also stored in the event log where they are labeled with a time stamp.

Note: The event log is only available with the COM16.

The respective process for the load restore threshold is reversed if all three phases fall short of the setpoint, and a load shed warning will be generated. If only one of the three currents exceeds the setpoint, a load restore event will not be generated.

In order to avoid load shedding on the basis of short-time current peaks and valleys, they can be delayed by a delay time t_x which can be set to between 1 s and 15 s.

The load management parameters can be found in the parameter tree of the BDA.

The load shedding/load restore signals are available as outputs of the digital output module, which are provided with a rotary selection switch.

Extended Protective Function

The extended protective function of the metering modules adds additional tripping functions. The options listed in table 2-8 can be used as additional monitoring functions.

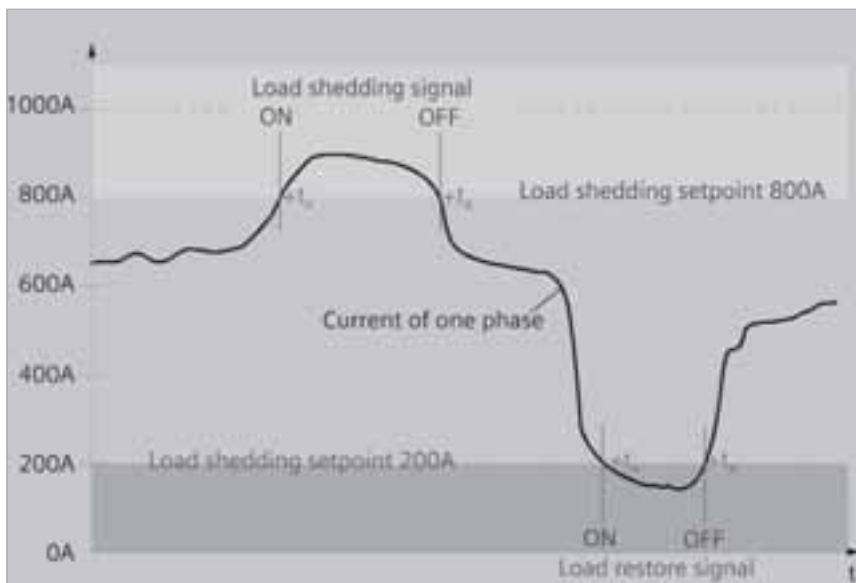

Figure 2-8 Load shedding and restore are explained in this graphic. It's based on the assumption of a WL Circuit Breaker with an overload setpoint of 1000 A.

Communication-capable Circuit Breakers

WL Circuit Breaker

Setpoints

In addition to the load management option (load shedding/load restore), the metering modules offer an option for an automatic monitoring of operating data and the generation of an alarm.

Two setpoints can be defined (e.g. for overvoltage). With the lower setpoint, an alarm can be generated via the setpoint value (e.g. > 410V), whereas, with a voltage increase, a tripping event (e.g. > 430V) can be generated.

Minimum for Communicated Currents

In order to avoid the detection, display and communication of very low currents generated by system noise, even with the circuit breaker in the disconnect position, the "Minimum for Communicated Currents" parameter offers the option of setting all detected current values smaller than this parameter to zero. The factory setting is 50A. This means that all values smaller than 50A are displayed as "0" on the display, interpreted as "0" for internal calculations (power) and also transmitted as "0" via the communications. If this parameter is changed to "0", this function is deactivated and all detected current measuring values will be directly used.

The parameter can be found in the parameter tree of the BDA.

Normal Positive Power Flow Direction

The current direction of the energy "flow" and the question, "How much energy has, up to now, flowed in both directions?" is of particular interest for tie breaker applications. For a determination, it is important to define a "normal direction". This direction can either be "from top to bottom" or "from bottom to top".

The measured real power is either assigned to a positive polarity (in normal direction) or a negative polarity (opposite normal direction). In contrast, the measured currents are always assigned a positive polarity.

With energy, the transmitted energy values are incorporated in two counters, real energy and real energy opposite to normal direction. The two energy counters are not assigned a polarity.

Event and Trip Log

All events (except for tripping events) are labeled with a time stamp and an ON (+) or OFF (-) indication and entered in the event log.

The event log has a depth of 10 events and works like a FiFo memory (first in, first out), i.e. the oldest event is deleted from the event log upon the occurrence of a new event.

The trip log is similar to the event log, however, only the last 5 trips are recorded with a time stamp and entered in the trip log.

Note: The event and the trip log are only available with the COM16 module.

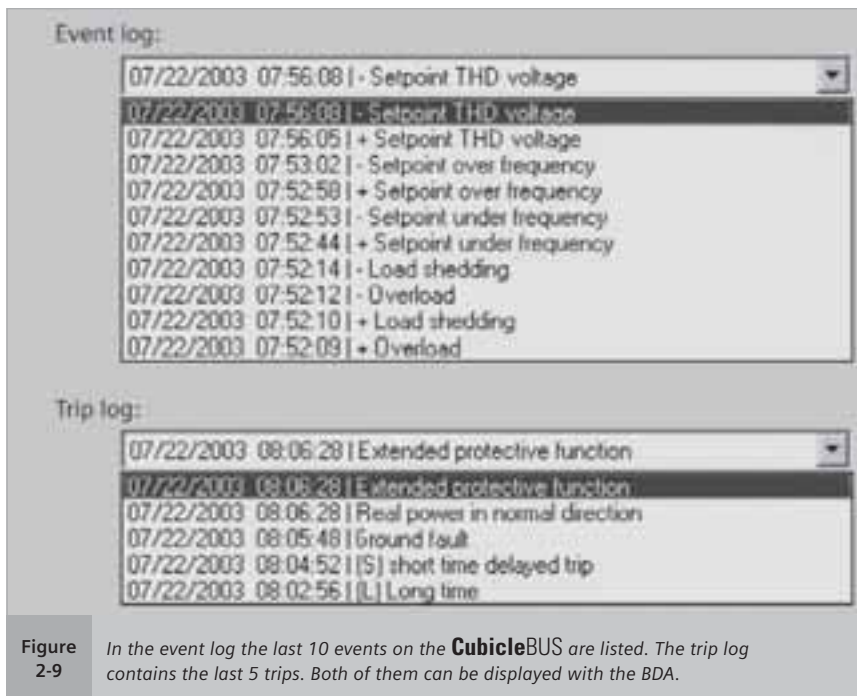

Figure 2-9 In the event log the last 10 events on the **CubicleBUS** are listed. The trip log contains the last 5 trips. Both of them can be displayed with the BDA.

External CubicleBUS Modules

By connecting additional, external modules to the **CubicleBUS**, breaker status information can be displayed and data read from the switchgear to the system. This enables cost-effective solutions to be implemented for automating other devices in the switchgear.

General

External **CubicleBUS** modules enable the WL Circuit Breaker to communicate with secondary devices in the switchgear. They can be used, for example, to activate analog displays, transmit circuit breaker status and cause of trip, and read additional control signals. One module is also available for zone-selective interlocking.

Five different **CubicleBUS** modules can output data from the **CubicleBUS** system (four digital output modules and one analog output module). A digital input module can transmit data from the switchgear to the MODBUS master, and a ZSI module enables zone selective interlocking among the circuit breakers.

Rotary Switches

With the exception of the configurable output module, all external **CubicleBUS** modules are configured using rotary switches.

The arrow on the rotary switch points to the function that is currently active. With certain modules (e.g. digital output modules), the group selection (e.g. "1st Module" left; highlighted) and then any other settings (e.g. time delay) must be taken into account. More information on this is provided with the individual module instruction sheets and the WL Instruction Manual.

Installation

The external **CubicleBUS** modules can be installed onto a standard 35mm DIN rail on the panel. The cable for connecting the first module to the circuit breaker must be no longer than 2 m.

Prefabricated cables, which can be ordered separately in different lengths, must be used to connect the **CubicleBUS** modules to each other and to the circuit breaker. These cables enable the various components to communicate and supply the **CubicleBUS** modules with 24V DC.

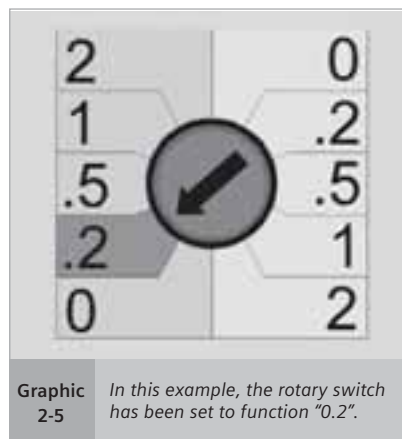

Graphic 2-5 In this example, the rotary switch has been set to function "0.2".

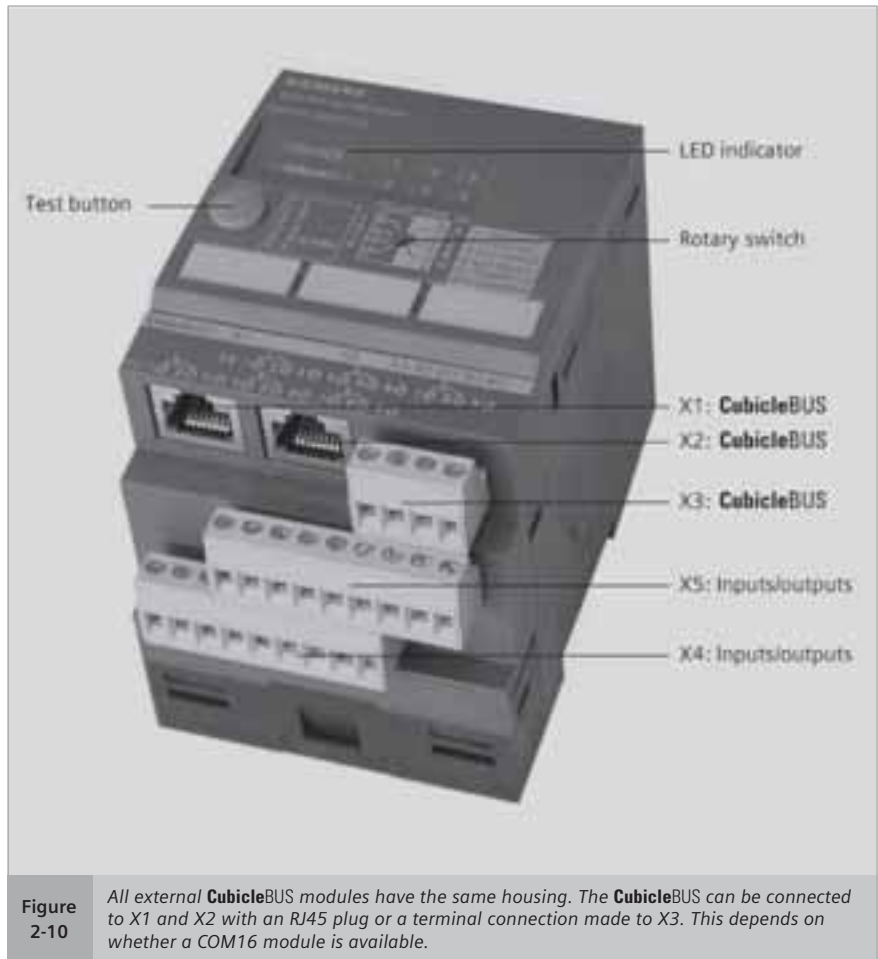

Figure 2-10 All external **CubicleBUS** modules have the same housing. The **CubicleBUS** can be connected to X1 and X2 with an RJ45 plug or a terminal connection made to X3. This depends on whether a COM16 module is available.

Communication-capable Circuit Breakers

WL Circuit Breaker

Power Supply

The **CubicleBUS** must be supplied with a UL Listed 24V DC class 2 power supply across its entire length. Reference pages 2/33 and 2/34 of this manual for details pertaining to the requirements of this power supply. Terminals X8.3 and X8.4 or the 4-pin plug for the external **CubicleBUS** modules (X3) are available for this purpose. As previously mentioned, the 24V is conducted via the **CubicleBUS** cables.

The power required for the 24V DC supply depends on the **CubicleBUS** configuration. The technical data for the external **CubicleBUS** modules is provided later in this chapter.

The control system (of the **CubicleBUS**) must be connected to a fused power supply (class 2), since the system voltage drops to an unspecified value in the event of a short-circuit.

Attention: Connecting and disconnecting **CubicleBUS** modules when energized is not recommended and can cause erroneous inputs or outputs to be generated.

Maximum CubicleBUS Configuration

The **CubicleBUS** can comprise up to 13 modules:

- Electronic Trip Unit (ETU)
- Metering Function Plus
- Breaker Status Sensor (BSS)
- COM16
- BDA or BDA Plus
- ZSI module
- Digital output module with switch position to the left (1st module)
- Digital output module with switch position to the right (2nd module)
- Digital configurable output module
- Digital input module with switch position to the left
- Digital input module with switch position to the right
- Analog output module with switch position to the left (1st module)
- Analog output module with switch position to the right (2nd module)

In practice, however, not all of the modules may be required.

CubicleBUS Installation Guidelines

- Total length of the **CubicleBUS** cables: max. 10 m
- Prefabricated cables must be used to connect the **CubicleBUS** modules.
- The last module on the line must be terminated with a 120 Ω terminating resistor (supplied with each module).
- The cables must always be connected from module to module. Star connection is not permitted.
- The power supply must be provided by a UL Listed 24V DC class 2 power supply with standard-tolerance and the properties described on page 2/33 and 2/34.

Pin Configuration of the X3 on the **CubicleBUS** Module

X3.1	24V DC common
X3.2	CubicleBUS Communications line -
X3.3	CubicleBUS Communications line +
X3.4	24V DC +

Table 2-10 At X3, the **CubicleBUS** can be supplied with 24V DC.

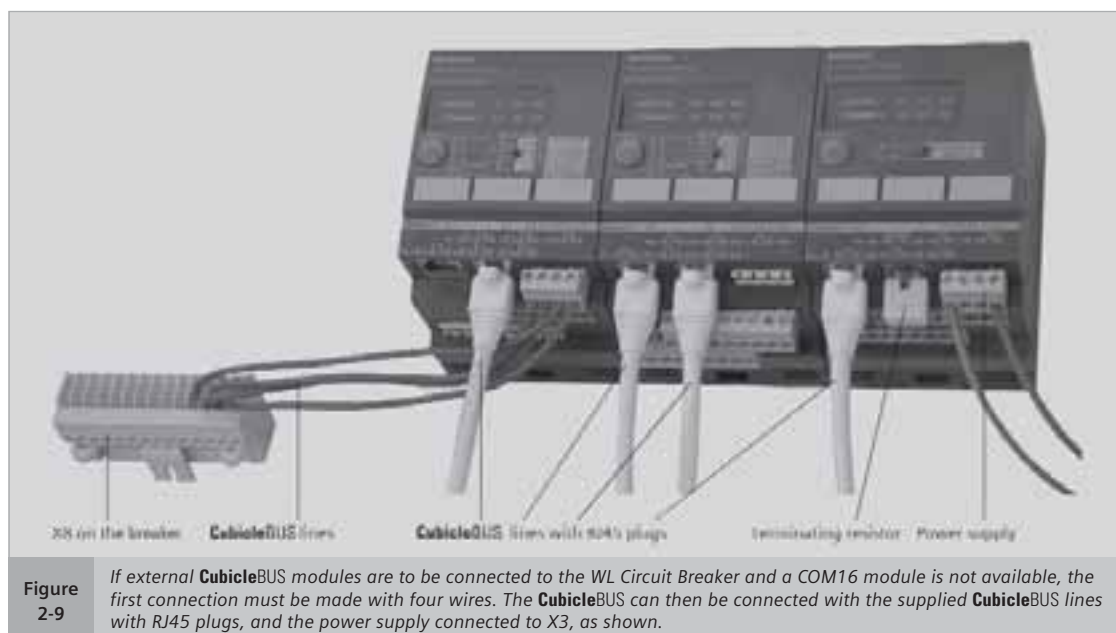

Figure 2-9

If external **CubicleBUS** modules are to be connected to the WL Circuit Breaker and a COM16 module is not available, the first connection must be made with four wires. The **CubicleBUS** can then be connected with the supplied **CubicleBUS** lines with RJ45 plugs, and the power supply connected to X3, as shown.

Communication-capable Circuit Breakers

WL Circuit Breaker

- The ZSI module must be the first external module to be connected, if used.
- If the BDA is connected to the front interface of the trip unit, the cable must be no longer than 0.5 m.

LED Display

The LEDs on the external **CubicleBUS** modules enable straightforward module diagnosis and testing. As explained in Tables 2-11 to 2-13, the internal status and the communications connection can be diagnosed to ensure that they have been wired correctly.

DEVICE LED		Meaning
Red	●	Internal error in the CubicleBUS module
Yellow	●	CubicleBUS module in test mode
Green	●	Module in operation

Table 2-11 The *DEVICE LED* indicates the state of the external **CubicleBUS** module.

CubicleBUS LED		Meaning
Green	●	Connection exists to a different module
Off	●	No other CubicleBUS module detected

Table 2-12 The **CubicleBUS** LEDs on the external **CubicleBUS** modules indicate whether communication is taking place with other modules. This enables straightforward diagnosis.

All other LEDs		Meaning
Yellow	●	On the input module, this indicates an ON signal at the corresponding input. With digital output modules, the output is active when the contact closed. With analog output modules, a yellow LED indicates that the full-scale deflection value has been exceeded by 20%.
Off	●	The LED is off if none of the above-mentioned conditions are present

Table 2-13 The LEDs indicate whether the outputs are set or the inputs are supplied with 24V DC and have been activated.

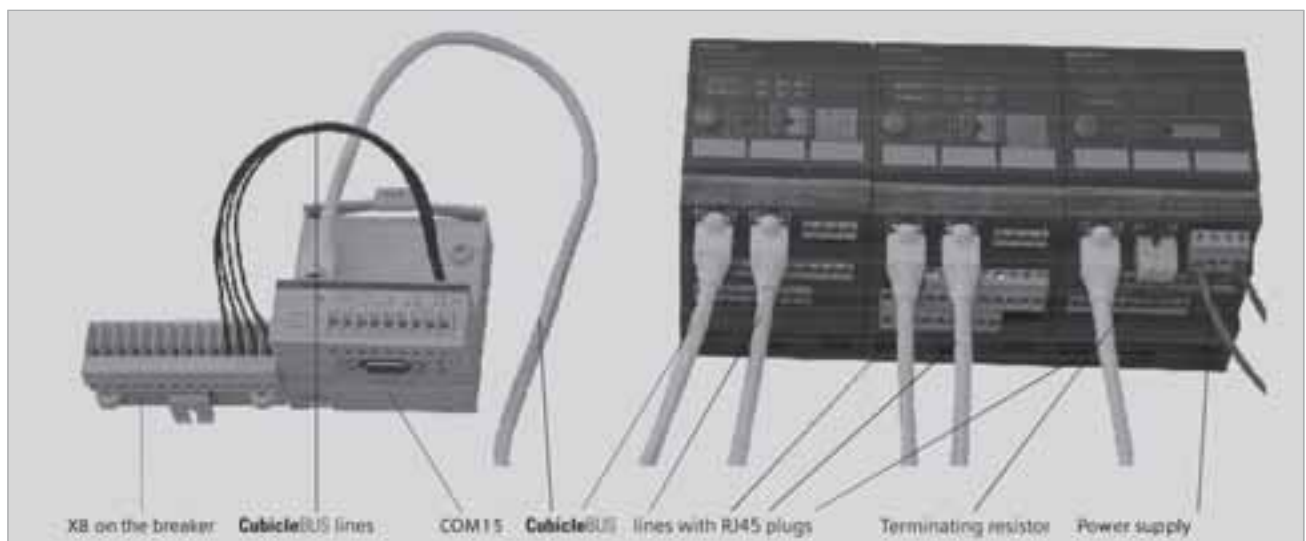

Figure 2-11

If a COM16 module is available, the external **CubicleBUS** modules can be integrated in the system by connecting them to the **CubicleBUS** cables supplied. The end of the **CubicleBUS** must be installed with a terminating resistor. The power supply unit can simply be connected via the X3 interface.

Communication-capable Circuit Breakers

WL Circuit Breaker

Testing the Digital Input and Output Modules

The test should be performed prior to any commissioning work to determine whether the circuit breaker and its components function properly.

The test mode can be used to check that the **CubicleBUS** modules function properly. A distinction must be made between the individual modules.

Pressing the "Test" key on the **CubicleBUS** module starts the test mode, and all the inputs, outputs, and associated LEDs are deactivated. The DEVICE LED changes from green to yellow.

Pressing the "Test" key several times in quick succession then switches the corresponding input or output ON and OFF alternately.

With the input module, the input signals are also transmitted via the **CubicleBUS** and via the COM16 if connected.

With the digital output modules, the associated outputs are also switched, thereby enabling the system to be checked.

The test mode of the analog output module and the ZSI module is described in the chapter on the appropriate module.

The inputs on the input module, outputs on the output module, the ZSI input, and the ZSI output can be "forced" via the BDA and WinPM.Net communication system. The test mode can be activated via the communication system and the inputs and outputs overwritten for test purposes.

The system exits the test mode automatically after 30 seconds if the test key is not actuated or no changes have been made via the communication system.

The test scenarios for the analog output module and ZSI are explained in the respective sections.

Checking the inputs and outputs on the digital input/output modules

Normal operation		Normal operating condition of the input/output module. The inputs/outputs are either ON or OFF depending on the wiring or communications.
After a pause of more than 2 s, press the "Test" key.		The module switches to the test mode, as indicated by the yellow DEVICE LED.
After a pause of more than 2 s, press the "Test" key.		Pressing once selects input or output 1, as indicated by the green LED 1. The output can then be switched on or off, and the ON or OFF signal of the input can be transmitted by pressing the "Test" key quickly (1 s).
After a pause of more than 2 s, press the "Test" key.		Input or output 2 selected. As with 1, the output can be switched by pressing the key quickly. With relay modules, you will be able to hear a click.
After a pause of more than 2 s, press the "Test" key.		Input or output 3 selected. With input modules, the presence of 24V DC at the corresponding input is simulated and transmitted via the CubicleBUS .
After a pause of more than 2 s, press the "Test" key.		Input or output 4 selected. The selected input or output can be tested by quickly pressing the "Test" key.
After a pause of more than 2 s, press the "Test" key.		Input or output 5 selected. The selected input or output can be tested by quickly pressing the "Test" key.
After a pause of more than 2 s, press the "Test" key.		Input or output 6 selected. The selected input or output can be tested by quickly pressing the "Test" key.
After a pause of more than 2 s, press the "Test" key.		Overall LED test. If the "Test" key is not pressed within 30 seconds, the system exits test mode.
After a pause of more than 2 s, press the "Test" key.		The test procedure can now start from the beginning.

Table 2-14 The table shows the test procedure for checking the digital inputs and outputs on the **CubicleBUS**. If the "Test" key is not pressed within 30 seconds, the system exits test mode automatically.

Digital Input Module

Functional description

The digital input module enables up to six additional binary signals (24V DC) to be connected. Signals, such as the status of the breaker, the status of the switchgear cabinet door, or a signal indicating that a predefined temperature has been exceeded, can be transmitted directly and processed at the field bus level.

A total of 6 inputs are available in the "BUS Input" Switch position. Six inputs are also available if the rotary switch is in the "Parameter Switch" position, although the first input causes the active parameter set to change. If the connected ETU does not have two parameter set capability (e.g. ETU745 or ETU748), this input can also be used without any restrictions.

Functional description for changing parameter sets

Trip units ETU755 and ETU776 have two different parameter sets for the protection function. This function is particularly useful in the event of a power failure when an automatic transfer is made from utility to generator, a process which may require that all the protective functions change.

The MODBUS communication system, the BDA, the ETU776 display, or the digital input module can be used to switch between the two parameter sets.

For this purpose, the first module input is used in the "Parameter Switch" position on the rotary switch. If a "1" signal is detected (LED on input 1 is yellow), the switchover to parameter set B is communicated to the trip unit. If the input signal switches back to "0", the switchover to parameter set A is communicated, and the LED on input 1 is de-energized.

Since the **CubicleBUS** is event controlled, trip unit ETU755 or ETU776 switches over to the other parameter set when a switchover request is issued via the **CubicleBUS**.

This means that if a switchover is made to parameter set B via the BDA, for example, even though the input on the digital input module is set to "0" (parameter set A), the active parameter set in the trip unit switches to parameter set B. A switchover event to parameter set A is not initiated on the **CubicleBUS** until the input on the digital input module is set first to "1" and then back to "0".

A maximum of two digital input modules can be operated simultaneously on one WL Circuit Breaker: one as a module with the "BUS Input" position and the other as "Parameter Switch" mode.



Figure 2-13 The position of the rotary switch determines the operating mode.

Technical data for the digital input module

Operating voltage min./max.	19.2V / 28.8V
Operating current min./max.	29mA / 43mA
No. of channels per digital input module	6
Min. voltage value for detecting a "1" signal	>16V
Current per input for a "1" signal	7.5mA
Max. voltage value for detecting a "0" signal	<1V
Current input per input for a "0" signal	0mA
Max. no. of digital input modules per breaker	2
Power min./max.	0.72W / 0.94W
Dimensions W/H/D	70 mm/86mm/95 mm
Weight	0.223 kg
Operating temperature range	-20°C / 60°C

Table 2-15 This table provides accurate technical data for the digital input module on the **CubicleBUS**.

Communication-capable Circuit Breakers

WL Circuit Breaker

Digital Output Module with Rotary Switch

The digital output module can be used to output six events. These events can be warnings or trips and can be used for external annunciation or control. A circuit breaker trip can be wired to an Alarm Horn or Stack Light.

The load shedding and load restoring signals can enable a load to be switched ON or OFF automatically depending on the load.

The digital output module is available in two versions. The "optocoupler" version features solid state outputs. The current carrying capacity of this output is 150mA, and the nominal voltage is 24V DC. Only DC voltage can be switched. The "relay" version, uses a relay contact with a maximum load of 12A. Voltages of up 250V AC/DC are possible. The relay contacts are isolated.

The module is configured using a rotary switch, which not only selects one of the two output module versions, but also sets the appropriate delay time.

Selector switch position to the left

If the rotary switch is positioned to the left, outputs 1 through 6 are assigned the following events:

- Output 1: Long-time trip (L)
- Output 2: Short-time trip (S)
- Output 3: Instantaneous trip (I)
- Output 4: Ground fault trip (G)
- Output 5: Ground fault alarm signal
- Output 6: Trip as a result of overload in the neutral conductor (N)

Selector switch position to the right

If the rotary switch is positioned to the right, the 6 outputs are automatically assigned the following functions:

- Output 1: Leading overload trip signal (delay time 0s)
- Output 2: Trip unit error (ETU)
- Output 3: Load shedding
- Output 4: Load restoring
- Output 5: Temperature alarm
- Output 6: Current phase unbalance

Delay time

The rotary switch can also be used to set an additional delay time. Available times are 0, 0.2 s, 0.5 s, 1 s, and 2 s. These can be used, for example, to suppress events that only last a short time and not output them until they have been present for a long period (e.g. phase unbalance).

Irrespective of the delay time that has been set, the signal for the leading overload trip, which can be used to switch off and protect connected frequency converters, is always instantaneous.

A maximum of two digital output modules with rotary switches can be operated simultaneously on one WL Circuit Breaker, otherwise erroneous outputs may occur. They must be configured opposite each other. One in the operating mode with the switch position to the left and one with the switch position to the right.

The LEDs display the current state of the 6 outputs. If the LED is OFF, the corresponding output is OFF. If the LED is yellow, the output is ON.

Technical data for the digital output module with a rotary selection switch

Operating voltage min./max.	19.2V / 28.8V
Operating current min./max. optocoupler	29mA / 63mA
Operating current min./max. relay	29mA / 250mA
No. of isolated channels per digital output module	6
Max. current rating for optocoupler output with 24V DC	100mA
Max. current rating for relay output with 24V DC / 250 V AC / 250V DC	5A / 5A / 0.25A
Max. no. of digital output modules on one CubicleBUS	2
Power loss min./max.	0.74W / 5.4W
Dimensions W/H/D	70mm / 86mm / 95mm
Weight (optocoupler/relay)	0.223 kg / 0.321 kg
Temperature range	-20°C / 60°C

Table 2-16 This table provides accurate technical data for the digital output module with rotary switch on the **CubicleBUS**.



Figure 2-14 Switch positioned to left / right selects events in dark-gray / light-gray fields.

Configurable Digital Output Module

The configurable digital output module also has six outputs. Like the digital output module with the rotary switch, it is available with optocoupler and relay outputs.

Unlike the modules with the rotary switch, however, the outputs are assigned using a software tool rather than a selector switch. WinPM.Net, WL Config or the BDA can be used as configuration software. The outputs can be assigned the events in the table opposite using drop-down fields.

The first three module outputs can be assigned up to six events. All of these events operate in parallel. This triggers, for example, a type of group signal when the circuit breaker is either impending trip mode or a phase unbalance warning is present.

The last three outputs can only be assigned one of the events directly.

Configuration events include status signals, warnings, tripped indication, over/under setpoint status, waveform buffer triggers and the active parameter set.

The module outputs can be set remotely using communications.

These events are available for the digital, configurable output module (part 1)

Status	Circuit breaker closed
	Circuit breaker open
	Storage spring charged
	Ready-to-close
	Group warning
	Group trip
	MODBUS write protection active
	MODBUS communication OK
Alarms	Overload
	Overload in N-conductor
	Load shedding
	Load restoring
	Ground fault alarm
	Overtemperature
	ETU error
	Phase unbalance - current
Trips	Long-time (L)
	Short-time (S)
	Instantaneous short-circuit (I)
	Ground fault (G)
	Overload in neutral conductor
	Phase unbalance - current
	Phase unbalance - voltage
	Under frequency
	Over frequency
	Undervoltage
	Overtvoltage
	Active power in normal direction
	Active power in reverse direction
	Total harmonic distortion - current
	Total harmonic distortion - voltage
	Reversal of phase rotation direction
MODBUS output bits	MODBUS bit 1
	MODBUS bit 2
	MODBUS bit 3
	MODBUS bit 4
	MODBUS bit 5
	MODBUS bit 6
	Parameter set A active
	Parameter set B active

Table 2-17 The events in this table (part 1) and the following table (part 2) are available on the CubicleBUS. These can be output via the configurable digital output module.

Communication-capable Circuit Breakers

WL Circuit Breaker

The status can be read via the input module, which means that a motor could be switched ON or OFF via the configurable digital output module.

Many other applications are also possible.

Unlike the digital output module with the rotary switch, a time delay cannot be added to the event. A setpoint can be output with a delay via the configurable digital output module, for example, if the setpoint itself is already delayed.

Like the digital output module with the rotary switch, this module also indicates the status of the outputs via the associated LEDs.

Attention: Do not power off the configurable output module within 15 seconds of changing the configuration via BDA or WinPM.Net. This could result in a red DEVICE LED and all outputs will be deactivated indicating that the device is incompletely configured.



Figure 2-15 The outputs can only be configured using appropriate software.

These events are available for the digital, configurable output module (part 2)

Setpoints	Over current
	Over current in neutral conductor
	Over current - ground fault
	Phase unbalance - current
	Phase unbalance - voltage
	Demand - current
	Undervoltage
	Overvoltage
	Total harmonic distortion - current
	Total harmonic distortion - voltage
	Crest factor
	Form factor
	Under frequency
	Over frequency
	Active power in normal direction
	Active power in reverse direction
	Apparent power
	Reactive power in normal direction
	Reactive power in reverse direction
	Power factor leading
Power factor lagging	
Demand - active power	
Demand - reactive power	
Demand - apparent power	
Trigger event	Waveform buffer A
	Waveform buffer B

Table 2-18 Part 2 of the table shows all the events on the CubicleBUS that can be output via the digital configurable output module. Configuration is carried out using WinPM.Net, WL Config or the BDA.

Technical data for the digital configurable output module

Operating voltage min./max.	19.2V / 28.8V
Operating current min./max. (excluding relay)	29mA / 39mA
Operating current min./max. relay	29mA / 250mA
No. of channels per digital output module	6
Max. current rating for optocoupler output with 24V	100mA
Max. current rating for for six relay outputs with 24V DC/250V AC/250V DC	5A / 5A / 0.25A
Max current rating for one relay output with 24V DC	2.7A
Max. no. of digital configurable output modules on one WL Circuit Breaker	1
Power loss min./max.	0.74W / 5.4W
Dimensions W/H/D	70mm / 86mm / 95mm
Weight (optocoupler/relay)	0.223 kg / 0.321 kg
Operating temperature range	-20°C / 60°C

Table 2-19 This table provides technical data for the digital configurable output module on the CubicleBUS.

Analog Output Module

The analog output module can be used to output the most important measured values sent via the **CubicleBUS** to analog indicators (e.g. analog meters) in the switchgear cubicle door. Each analog output module has four channels for this purpose. The signals are available at two physical interfaces: a 4 ... 20mA and a 0 ... 10V interface.

The measured values are available as 0 ... 10V via the X4 connector on the **CubicleBUS** module (the 4 ... 20mA interface is available at X5). Both outputs are always active at the same time, and can be used simultaneously.

The measured values, which are output via the four channels, are selected using a rotary switch. The available outputs are current, voltage, power, frequency and power factor. Up to two analog output modules can be operated on one **CubicleBUS**. The selection panel on the rotary switch is divided vertically. If the switch is set to a value on the left, the module is automatically addressed as module 1.

If a second module exists, it must be set to a value on the right. This is the only way that two analog output modules can operate simultaneously.

All types of analog instruments with an internal resistance of more than 20kΩ (for the voltage output) and between 50Ω and 250Ω (as a current output) can be used as an indicator.

The LEDs for the channels are yellow if the current value exceeds the full-scale deflection by 20% (with V, I and P), power factor is greater than 0.8, or the frequency greater than 45Hz.

Switch position "I"

In switch position "I", the measured current values are output linearly:

A01: Current in phase A

A02: Current in phase B

A03: Current in phase C

A04: Current in the neutral conductor

Since the circuit breaker can be

designed for different rated currents, the full-scale value must be scaled automatically and the maximum output value of the analog output module interpreted. The value of the rating plug is used for this purpose.

The maximum value is calculated by multiplying the value of the rating plug by 1.2 and then rounding the result up to the nearest 100.

Example: With a rating plug of 1600A, the full-scale value of the analog panel meter must be 2000A (1600 x 1.2 = 1920 -> 2000A). In other words, 0V/4mA = 0A, 10V/20mA = 2000A.

Switch position "U"

When the rotary switch is in switch position "U", the following voltages are applied to the four analog outputs:

A01: Phase-to-phase voltage V_{ab}

A02: Phase-to-phase voltage V_{bc}

A03: Phase-to-phase voltage V_{ca}

A04: Phase voltage V_N

In most cases, the phase-to-phase voltage is output to the switchgear cubicle doors. This is why the first three channels are assigned these measured values. If the voltage is required between a phase and the neutral conductor, this is available via output A04.

The full-scale deflection for the analog panel meter is calculated by multiplying the rated voltage of the network (primary voltage of the voltage transformer) by 1.1 and then rounding the result up to the nearest 50.

Example: If the rated voltage of the network is 480V, the full-scale value is 550V (480V x 1.1 = 528V -> 550V).

Switch position "P"

If the rotary switch is set to position "P", the power measured values are output via the four channels:

A01: Active power phase kW_a

A02: Active power phase kW_b

A03: Active power phase kW_c

A04: Total apparent power kVA_{TOT}

The full-scale deflection of the active power in each phase is calculated by multiplying the value of the rating plug by the rated voltage of the network. The full-scale deflection value is then classified in a value range, as shown in the table below.

Before the full-scale deflection can be determined from the table, the calculated value must be multiplied by 3 for the total apparent power and the total active power (position f).

Example: $I_R = 1600A$, rated voltage = 480V; -> full-scale deflection = 1,000,000 W

Switch position "f"

Since it can generally be assumed that the frequency will be the same across the three phases in all the networks, switch position "f" is used to provide a general overview by outputting the most important measured values (with the exception of the current values). In conjunction with another module in position "I", all the most important measured values can be displayed in this way.

Power value ranges [W/WA]

From	To	Full Scale Deflection
0	50,000	50,000
50,000	100,000	100,000
100,000	200,000	200,000
200,000	300,000	300,000
300,000	500,000	500,000
500,000	1,000,000	1,000,000
1,000,000	2,000,000	2,000,000
2,000,000	3,000,000	3,000,000
3,000,000	5,000,000	5,000,000
5,000,000	10,000,000	10,000,000
10,000,000	20,000,000	20,000,000
20,000,000	∞	30,000,000

Table 2-20 After multiplication, the full-scale deflection of the power is sorted into ranges.

Communication-capable Circuit Breakers

WL Circuit Breaker

A01: Network frequency

A02: Average value of the phase-to-phase voltages

A03: Total active power

A04: Average value of the power factors

The scale for displaying the frequency must range from 45Hz to 65Hz. This enables the standard frequencies in countries where IEC and UL standards apply to be displayed.

Example: 45Hz = 0 V/4mA and 65Hz = 10V/20mA.

The scalings of the other measured values can be read in the appropriate switch positions.

Switch position "cosφ"

The following measured values are output in switch position "cosΦ":

A01: Power factor cosφL1

A02: Power factor cosφL2

A03: Power factor cosφL3

A04: Phase unbalance - current (%)

The power factors are displayed from 0.7 (leading) (= 0V/4mA) through 1 (= 5V/12mA) to 0.7 (lagging) (= 10 V/20mA). The phase unbalance of the three currents is displayed from 0% (0V/4mA) to 50% (10V/20mA).

Note: Ensure that the polarity is correct during connection.



Figure 2-16

The analog channels are selected using the Rotary Switch.

The test mode is started by pressing the "TEST" key and indicated by the yellow DEVICE LED. Although the measured values continue to be updated in the test mode, they are not output at their respective channels.

- The test mode is started by pressing the "TEST" key.
- Pressing the "TEST" key again selects output 1, which is indicated by LED A01. The test signal is output. For currents, voltages, and power rating values, this is equivalent to the full-scale value, with cosφ 1 and with a frequency of 55Hz.
- Pressing the key again selects output 2, which is indicated by LED A02. This automatically deletes the value at output 1 and sets the value at output 2.

- By repeating the above steps, the output and scaling of all four outputs can be checked one after the other.
- Selecting output A04 and pressing the "TEST" key activates all four LEDs, but does not activate an output. Pressing the key again selects output 1 again.
- If the "TEST" key is not pressed within 30 seconds after an output has been selected, the system exits the test mode automatically and returns to the standard operating mode. The values, which are constantly updated in the background, are then updated at the outputs again.

Technical data for the analog output module

Operating voltage min./max.	19.2V / 28.8V
Operating current min./max.	63mA / 150mA
Min. resistance connected to voltage output	20kΩ
Resistance range for connection to current output - min./max.	20Ω / 250Ω
Max. no. of analog output modules on one WL Circuit Breaker	2
Power loss min./max.	0.74W / 5.4W
Dimensions W/H/D	70mm / 86mm / 95mm
Weight	0.223 kg
Temperature range	-20°C / 60°C

Table 2-21 This table provides technical data for the analog output module on the CubicleBUS.

ZSI Module

To use the ZSI function with the WL Circuit Breaker, the external **CubicleBUS** ZSI module must be implemented.

The zone selective interlocking (ZSI) module provides the complete range of selectivity with the short delay time of $t_{ZSI} = 50$ ms, irrespective of the number of levels and the location of the short-circuit in the distribution system. Its benefits become even more apparent, the higher the number of levels in large systems and the longer the resulting delay times.

By shortening the time, the ZSI module significantly reduces stress and damage in the event of a short-circuit in the switchgear.

Operating principle

If the ZSI module is used in a distribution system comprising several levels, each circuit breaker affected by a short-circuit interrogates the circuit breaker directly downstream, to ascertain whether the short-circuit also occurred in the next level below:

- If the short-circuit did occur in the downstream level, the upstream circuit breaker delays tripping to ensure that the circuit breaker directly upstream of the short-circuit has enough time to interrupt the short-circuit.
- If the circuit breakers in the downstream level do not report a short-circuit, the short-circuit occurred between the two levels in question. In this case, one of the two upstream circuit breakers interrupts the short-circuit once the programmed delay time of $t_{ZSI} = 50$ ms has elapsed.

*Example as illustrated in **Graphic 2-6**.*

This shows a section of a power distribution system that has been installed with the ZSI module. WL Circuit Breakers are implemented at different levels.

Short-circuit at 3:

Circuit breakers -Q5, -Q3, and -Q1 establish that a short-circuit has occurred. -Q5 blocks -Q3 by means of the ZSI signal and, as a result, -Q1 too, so that they do not trip in 50 ms. Since -Q5 does not receive a blocking signal from a subordinate circuit breaker, it is responsible for interrupting the short-circuit as quickly as possible. If this does not take place, because the circuit breaker is no longer operational due to an overcurrent, -Q3, as a backup, trips after the time-discriminating response time of 150 ms.

Short-circuit at 2:

-Q1 and -Q3 establish that a short-circuit has occurred; -Q5 does not. For this reason, -Q3 does not receive a blocking signal from -Q5, but provides a blocking signal for -Q1. This information tells -Q3 that it is closest to the short-circuit and trips with a delay of $t_s = 50$ ms instead of $t_{sd} = 150$ ms. Time saved = 100 ms.

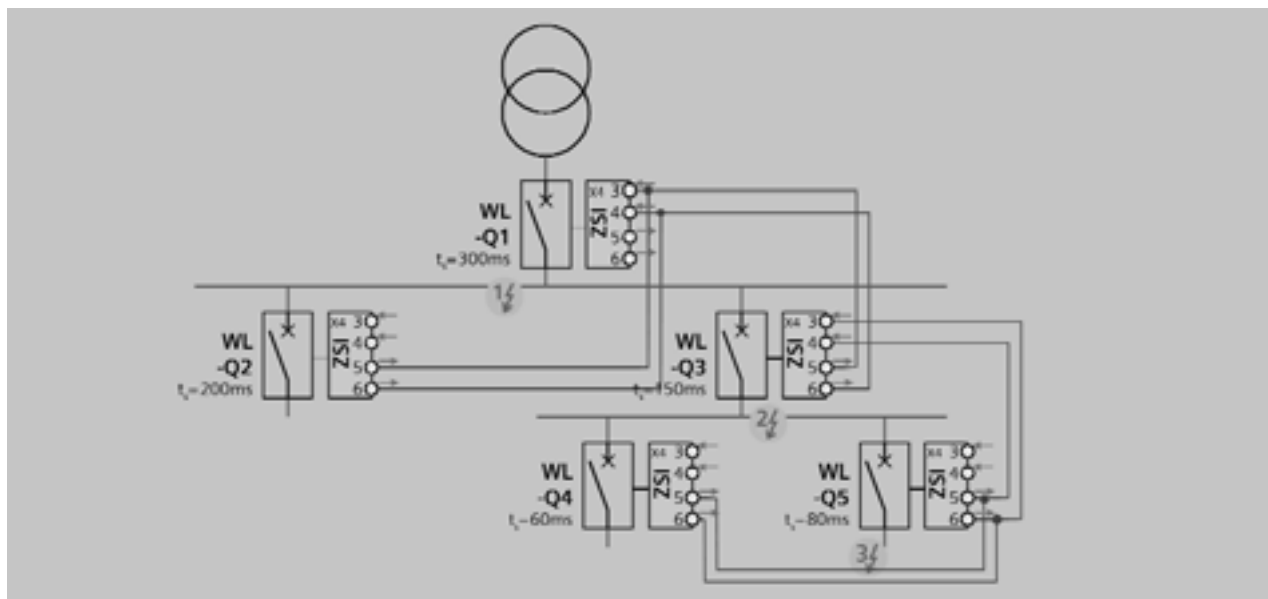

Graphic 2-6 This graphic illustrates the operating principle of the ZSI function using an example in a power distribution system. It is also a connection diagram that shows how the ZSI module must be wired if the WL Circuit Breakers are used.

Communication-capable Circuit Breakers

WL Circuit Breaker

Short-circuit at 1:

Only -Q1 establishes that a short-circuit has occurred and does not receive a blocking signal from a subordinate level. For this reason, it trips after $t_{ZSI} = 50$ ms. Time saved = 250 ms.

The ZSI function can be used for short-circuits between the phases (S), with respect to ground (G), or for both simultaneously (S+G). The operating mode is set using the rotary switch. If the switch is in the "OFF" position, the ZSI is deactivated.

The ZSI module also provides the blocking signal for the medium-voltage level.

If a tie breaker is used in the power distribution system, this can also be equipped with the ZSI function and integrated in the overall concept.

Up to 8 circuit breakers can be connected to ZSI IN, and up to 20 to ZSI OUT.

Attention: Proper performance cannot be guaranteed if these limits are exceeded.



Figure 2-17 The function of the ZSI module is selected using the rotary switch.

The ZSI module must always be the first external **CubicleBUS** module to be connected to the COM16 module or to X8.

Test function

The outputs are set (i.e. a blocking signal is sent to other circuit breakers) when the rotary switch is set to "TEST".

Pressing the "TEST" key switches the ZSI module to test mode, which is indicated by the yellow DEVICE LED. The inputs and outputs are selected in the same way as the digital input/output modules. When the ZSI module input is selected, the input can be toggled internally by pressing and releasing the TEST key. When the outputs are selected, the outputs can be toggled by pressing and releasing the TEST key. This enables the circuit to be checked.

Active inputs and outputs are indicated by a yellow LED.

It is recommended that the ZSI signal be transmitted via a shielded twisted pair with a cross-section of at least 0.75 mm^2 (18 AWG), and no more than 400 m long.

Technical data for the ZSI module

Operating voltage min./max.	19.2V / 28.8V
Operating current min./max.	31mA / 61mA
Automatic output reset after no more than...	3 s
Shortest time blocking signal can be present at the outputs LV	100 ms
Shortest time blocking signal can be present at the outputs MV	500 ms
Standard trip time (incl. all delays)	approx. 80 ms
Max. no. of circuit breakers connectable to ZSI IN	20
Max. no. of circuit breakers connectable to ZSI OUT	8
Max. no. of modules on one WL Circuit Breaker	1
Max. wire length for 2 x 18 AWG twisted pair	400 m
Power loss min./max.	0.8W / 1.76W
Dimensions W/H/D	70mm/86mm/95mm
Weight	0.223 kg
Operating temperature range	-20°C / 60°C

Table 2-22 This table provides technical data for the ZSI module on the **CubicleBUS**.

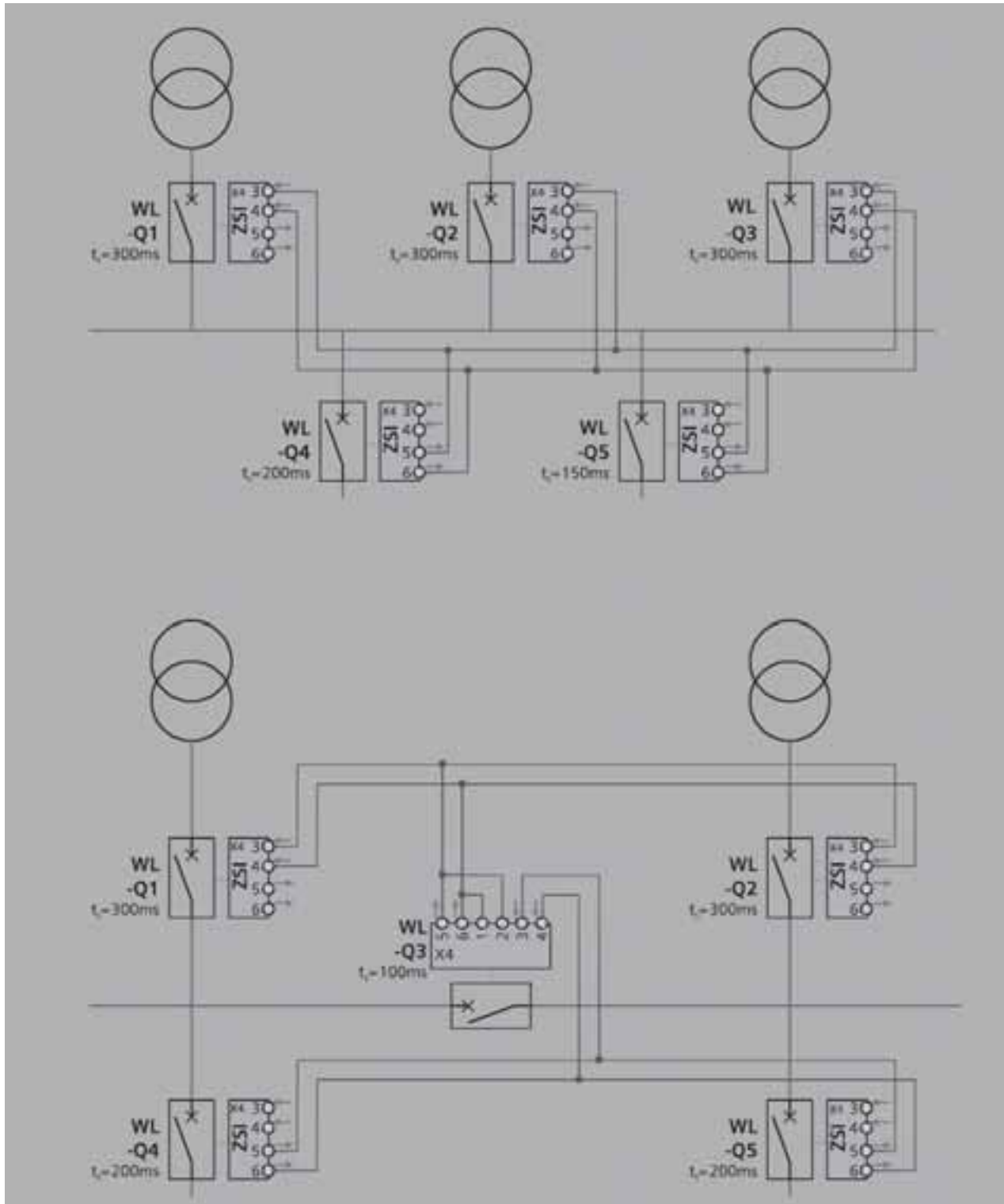

Graphic 2-7 This diagram consists of two parts: the top half is a connection diagram. The bottom half shows the circuitry when a tie breaker is used.

Communication-capable Circuit Breakers

WL Circuit Breaker

External power consumption of a WL Circuit Breaker with CubicleBUS

WL Circuit Breakers with **CubicleBUS** are designed to provide internal and external communication when the main contacts are open. It is therefore necessary to connect an external power supply.

General information

The current sensing devices of WL Circuit Breakers consist of two components. The Rogowski coils deliver the current measuring values, and the energy converters provide the trip units with power. For breakers without an additional external supply, the trip units are

already activated and monitor the current at minimum values of 80A for Frame Size II, and 150A for Frame Size III.

The current from the sensors are sufficient to not only activate the protective functions of the ETU745 or ETU748 trip units, but also to activate the display, however, the back-lighting requires an external power supply. If the **CubicleBUS** has been connected to a UL Listed 24V DC class 2 power supply, the display is fed with energy from this supply.

The display of the ETU776 only functions when an external **CubicleBUS** power supply has been connected. The protective functions are fully operational when primary current is flowing even though the display is not active.

If additional **CubicleBUS** components are applied on a WL Circuit Breaker, the breaker must be connected to an external UL Listed 24V DC class 2 power supply.

The **CubicleBUS** consists of four wires, two for the communications and two for the UL Listed 24V DC class 2 power supply. The **CubicleBUS** is connected to the external terminal X8.1 to X8.4.

Table to calculate the power consumption of an CubicleBUS System

CubicleBUS Modules	# of CubicleBUS modules per breaker	Max. continuous current	Max. peak inrush current for each module
Trip unit ETU745	1	120mA	2000mA
Trip unit ETU755	1	120mA	2000mA
Trip unit ETU776	1	170mA	2000mA
Metering Function or Metering Function Plus	1	120mA	120mA
Breaker Status Sensor BSS	1	40mA	110mA
COM16 MODBUS communication module	1	125mA	280mA
ZSI module	1	50mA	125mA
Digital output module with rotary switch, relay output	1 - 2	180mA	125mA
Digital output module with rotary switch, opto coupler	1 - 2	50mA	125mA
Digital output module configurable, relay output	1	180mA	125mA
Digital output module configurable, opto coupler	1	50mA	125mA
Analog output module	1 - 2	110mA	800mA
Digital input module	1 - 2	30mA	125mA
BDA or BDA Plus	1	250mA	350mA
	Summary		

Table 2-23 To find a suitable external power supply for the WL Circuit Breaker with **CubicleBUS** the continuous current and the peak inrush current must be observed.

The + 24V DC connection must be connected to X8.3 and the ground of the 24V DC voltage supply must be connected to X8.4.

Selection criteria for the external power supply:

- First, the maximum continuous current which the **CubicleBUS** modules draw from the **CubicleBUS** supply must be calculated. (see Table 2-23)
- Second, the peak inrush current of all modules must be calculated. The power supply must be capable of bearing the maximum peak inrush current for a period of 100 ms.

A power supply must be selected in accordance with these two characteristic values. Several WL Circuit Breakers can be connected to one power supply. For this purpose, however, the total of the continuous currents must be considered. For example, the 6EP1332-2BA00 power supply can

be used with up to 3 ETUs and up to 16 **CubicleBUS** modules simultaneously. The 6EP1332-1SH42 power supply can be used with 2 ETUs and up to 8 **CubicleBUS** modules simultaneously.

Selecting a suitable power supply from the Siemens product line

Output current	Inrush current	Type	Order No.
2.5 A	< 30 A	Logo! Power	WLSITOP25
3.8 A	< 32 A	SITOP Power	WLSITOP1

Table 2-24 A Siemens power supply can be selected for one or more WL Circuit Breakers.

One WLSITOP1 can power the following combinations of accessories

For example: (2) ETU745 + (2) Metering Functions + (2) COM16 + (16) Digital CubicleBUS modules + (8) Analog CubicleBUS modules + (1) BDA

	6	5	5	5	4	4	4	4	3	3	3	3	2	2	2	2
ETU745-776																
Metering	0	0	5	0	0	4	0	4	0	3	0	3	0	2	0	2
COM16 or COM15	0	0	0	5	0	0	4	4	0	0	3	3	0	0	2	2
ZSI/Digital CubicleBUS modules	0	16	8	0	32	25	16	13	24	24	24	24	16	16	16	16
Analog CubicleBUS modules	0	2	1	0	5	3	2	2	7	6	5	5	9	9	8	8
BDA/BDA Plus	0	1	1	0	0	1	1	1	1	1	1	1	1	1	1	1

One WLSITOP25 can power the following combinations of accessories

For example: (2) ETU776 + (2) Metering Functions + (2) COM16 + (16) Digital CubicleBUS modules + (5) Analog CubicleBUS modules + (1) BDA

	4	4	4	4	3	3	3	3	3	2	2	2	2
ETU745-776													
Metering	0	4	4	0	0	3	3	0	3	0	2	0	2
COM16 or COM15	0	0	0	4	0	0	0	3	3	0	0	2	2
ZSI/Digital CubicleBUS modules	12	8	6	0	24	24	23	16	13	16	16	16	16
Analog CubicleBUS modules	2	1	1	0	4	4	3	2	2	6	6	5	5
BDA/BDA Plus	0	0	1	0	1	0	1	1	1	1	1	1	1

Communication-capable Circuit Breakers

WL Circuit Breaker

Notes

MODBUS Profile for WL Circuit Breaker

MODBUS Communication with the WL Circuit Breaker

Integration into Supervisory Systems

Supported Function Codes

Exception Responses

Default Register List

WL Configurator Brief Description

3

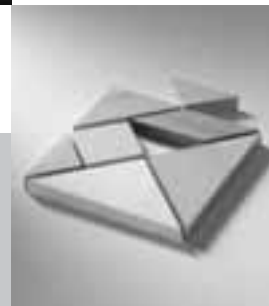

Communication-capable Circuit Breakers

WL Circuit Breaker

Supervisory Systems

The WL Circuit Breaker supports the industry standard MODBUS protocol through the COM16 interface. Communication connections to the COM16 are made through the DB-9 port on the front of the COM16; see Graphic 3-2 for connecting cable pin assignments. Typically the communication wiring from the COM16 will be installed at the factory and run to communication terminal blocks in the switchgear. At these terminal blocks customers can connect twisted shielded pair RS 485 cable to Ethernet Converters, MODBUS Masters, PLCs or supervisory control systems. When the WL Circuit Breaker is installed in Siemens switchgear as part of an ACCESS power monitoring system, the default wiring will be through a Siemens power meter Ethernet gateway or Ethernet converter

connected to a WinPM.Net workstation. For customers with existing MODBUS networks or who require integration into a MODBUS system the following information can be used to develop a software interface to the WL / COM16.

Data in the COM16 is organized in what is referred to as "Datasets". Each dataset contains a group of functionally common registers. For instance all metered data is organized in a dataset, which consists of 119 registers, min./max. information in another dataset, and diagnostic information in another dataset. In all, the COM16 has a total of 28 datasets, which can be read via communication. Users can take advantage of this structure and ask for blocks of data in one message request, making integration into MODBUS system fast and efficient. The COM16 also

supports pre-configured or standard register maps for simple data interfacing. Users can define what types of data they want in any of three default register sets. Type 1 provides 4 default registers. Type 2 provides 8 registers, and Type 3 provides 14 registers, all in consecutive order for easy requests. The WL is included in WinPM.Net and can be configured remotely using the software or using the remote set-up tool, WL Config.

Each register includes a corresponding status register, which can be read in order to validate the real-time data. This register is referred to as the property byte.

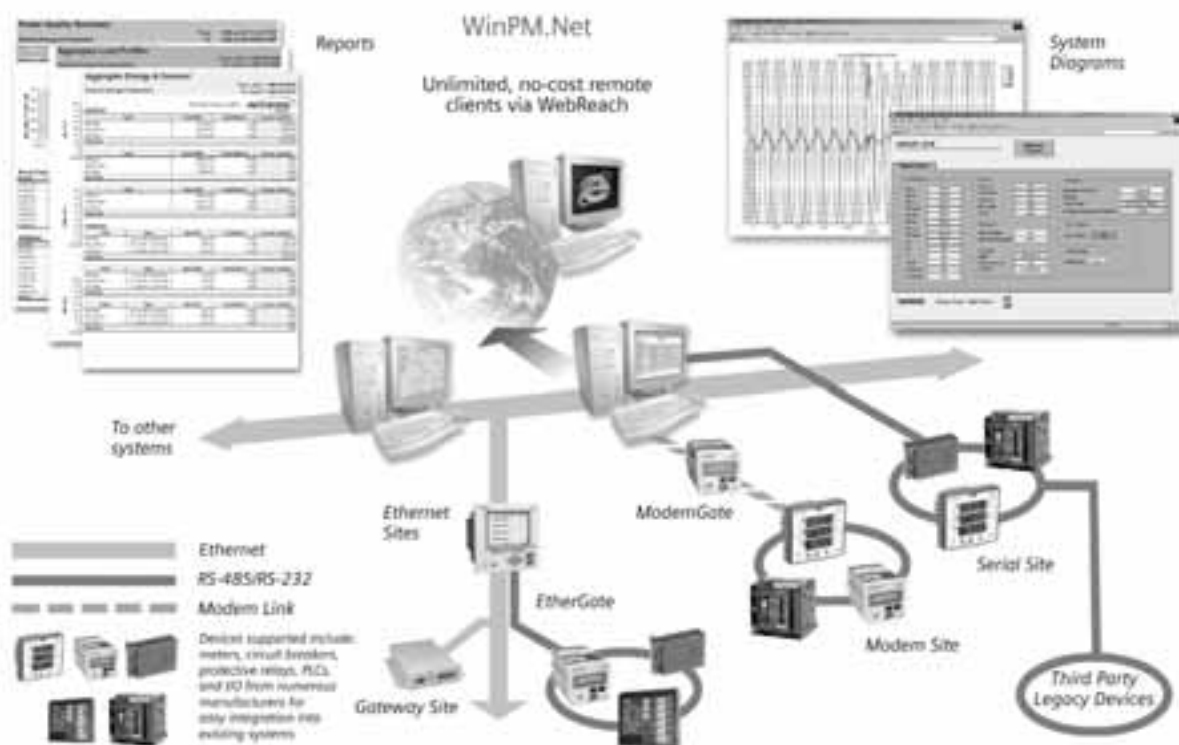

Graphic 3-1 Siemens Power Monitoring and control software WinPM.Net communicates to multiple device types using Ethernet, modem and RS 485 serial networks. The integration of the WL Circuit Breaker into WinPM.Net is a key component of totally integrated power.

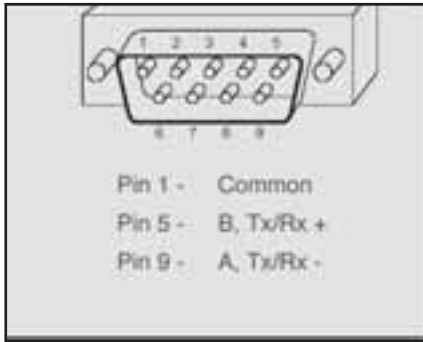

Graphic 3-2

Default Communication Parameters

The COM16 comes set-up with the following default Communication Parameters:

Baud: 19,200 Unit ID: 126 Parity: Even

Graphic 3-3

Data formatting byte order

Data points larger than two bytes transmitted in the Motorola Format (Big-Endian)

Byte order		Type of data	
Byte 0	Byte 0		char, unsigned char
Byte 1	Byte 1		
Byte 0	High byte		signed int, unsigned int
Byte 1	Low byte		
Byte 0	High byte	High word	signed long, unsigned long
Byte 1	Low byte		
Byte 2	High byte	Low word	
Byte 3	Low byte		

COM16 Supported Function Codes

Function 01: Read Coils

Function	This function reads the state of multiple Control Bits and Extra Flags in a COM16 slave.
Bit Start Address	Any value from 0000 hex to 000F hex. If any other address is specified, an Exception Code of 02 (Invalid Data Address) will be returned.
Quantity of Bits	If "Quantity of Bits" is not in the range of 1 to 16, an Exception Code of 03 (Invalid Data Value) will be returned. If an attempt to read a bit beyond Bit Address 000F hex is made, an Exception Code of 02 (Invalid Data Address) will be returned.

Function 02: Read Discrete Inputs

Function	This function reads the state of the bits in the Status Register in a COM16 slave.
Bit Start Address	Any value from 0000 hex to 000F hex. If any other address is specified, an Exception Code of 02 (Invalid Data Address) will be returned.
Quantity of Bits	If "Quantity of Bits" is not in the range of 1 to 16, an Exception Code of 03 (Invalid Data Value) will be returned. If an attempt to read a bit beyond Bit Address 000F hex is made, an Exception Code of 02 (Invalid Data Address) will be returned.

Communication-capable Circuit Breakers

WL Circuit Breaker

Function 03: Read Holding Registers

Function	This function reads a set of registers from a COM16 slave.
Start Address	Any value within the address range defined for each of the data sets. If any other address is specified, an Exception Code of 02 (Invalid Data Address) will be returned.
Quantity of Registers	If "Quantity of Registers" is not in the range of 1 to 125, an Exception Code of 03 (Invalid Data Value) will be returned. If the "Quantity of Registers" is not correct for the Dataset indicated by the "Start Address", an Exception Code of 02 (Invalid Data Address) will be returned.

Example:

Request Message to slave

The following is an example of a request to read Dataset 0 from a COM16 slave device at MODBUS address 7. The length of Dataset 0 is 4 bytes.

```
07H   Slave Address
03H   Function Code
00H   Register Start Address "High" (Dataset 0 address is 0000 hex)
b7H   Register Start Address "Low"
00H   Quantity of Registers "High" (Register quantity is 4 decimal)
04H   Quantity of Registers "Low"
xxH   CRC Check Code "Low"
xxH   CRC Check Code "High"
```

Reply Message from slave

The response returns 2 registers containing the contents of Dataset 0.

```
07H   Slave Address
03H   Function Code
04H   Byte Count (Bytes returned is 4)
00H   Register Address 00H Data "High"
03H   Register Address 00H Data "Low"
00H   Register Address 00H Data "High"
00H   Register Address 01H Data "Low"
xxH   CRC Check Code "Low"
xxH   CRC Check Code "High"
```

Function 04: Read Input Registers

Function	This function reads the Basic Data Registers from a COM16 slave. All three Basic Types (1, 2 and 3) are supported. (see pages 3/11, 3/12 and 3/13 for Basic Data)
Start Address	Any Data Block register address that is valid for the currently selected Basic Type. If any other address is specified, an Exception Code of 02 (Invalid Data Address) will be returned.
Quantity of Registers	If "Quantity of Registers" is not in the range of 1 to 125, an Exception Code of 03 (Invalid Data Value) will be returned. If the "Quantity of Registers" specified attempts to read beyond the last register of the currently selected Basic Type, an Exception Code 02 (Invalid Data Address) will be returned.

Function 05: Write Single Coil

Function	This function sets the state of a single Control bit or Extra flag in a COM16 slave.
Bit Address	Any value from 0000 hex to 000F hex. If any other address is specified, an Exception Code of 02 (Invalid Data Address) will be returned.
Bit status	The following two values are valid as the Bit Status: FF00H set bit 0000H clear bit If any other value is specified, an Exception Code of 03 (Invalid Data Value) will be returned.

Function 07: Read Exception Status

Function	This function reads the state of eight Exception Status bits from the COM16 slave. The bits are defined in Table 3-1.
----------	---

Bit Number	WL
0	Set = Inspect breaker contacts*
1	Set = Communication with trip unit is OK
2	Set = COM16 is OK
3	not defined, always zero
4	not defined, always zero
5	not defined, always zero
6	not defined, always zero
7	not defined, always zero

Table 3-1

*Refer to the Operator's Manual for proper procedure. (Only for WL ANSI / UL 1066 version.)

Communication-capable Circuit Breakers

WL Circuit Breaker

Function 08: Diagnostics

Function	This function provides a method for checking the communication between the master and a COM16 slave. COM16 slaves support the diagnostic sub-functions Return Query Data (0000 hex) and Clear Event Counter (000A hex).
Diagnostic Code	0000 hex: Echoes the test data sent by the master. 000A hex: Clears the COM16 slave's communications counters. (The data field for both Request and Reply is set to 0000 hex.) If any other value is specified, an Exception Code of 03 (Invalid Data Value) will be returned.

Function 11: Get Communication Event Counter

Function	Returns a status word and an event count from the COM16 slave's communications event counter. The event counter is incremented once for each successful message completion. It is not incremented for exception responses or Fetch Communication Event Counter commands. The event counter can be reset by means of the Diagnostics function (code 08), with the sub-function Clear Counters (code 000A hex). The normal response contains a two-byte status word, and a two-byte event count. The status word will be all ones (FFFF hex) if the COM16 slave is still processing a previously issued program command (a busy condition exists). Otherwise, the status word will be all zeros.
----------	---

Function 12: Get Communication Event Log

Function	Returns a status word, event count, message count and a field of event bytes from the slave. The status word and event count are identical to that returned by Function 11 (Fetch Communications Event Counter). The message counter is incremented once for each message processed by the slave. The event bytes field contains 64 bytes, with each byte corresponding to the status of one MODBUS send or receive operation for the slave. The slave enters the events into the field in chronological order. The Byte 1 is the most recent event. Each new byte flushes the oldest byte from the field. The normal response contains a two-byte Status field, a two-byte Event Count field, a two-byte Message Count field and a 64 byte Event Byte field. The Byte Count contains the total number of bytes in these four fields.
----------	--

What the Event Bytes Contain

For a COM16 slave, an event byte returned by the Fetch Communications Event Log function can be either of two types. The type is defined by bit 7 (the high-order bit) in each byte.

COM16 slave Receive Event

The slave stores this type of event byte when a query message is received. It is stored before the slave processes the message. This event is defined by bit 7 set to a logic "1". The other bits will be set to a logic "1" if the corresponding condition is TRUE. The bit layout is:

Bit	Contents
0	Not Used
1	Communications Error
2	Not Used
3	Not Used
4	Character Overrun
5	Currently in Listen Only Mode (always zero, the COM16 does not support Listen Only Mode)
6	Broadcast Received
7	1

Table 3-2

COM16 slave Send Event

The slave stores this type of event byte when it finishes processing a query message. It is stored if the slave returned a normal or exception response, or no response. This event is defined by bit 7 set to a logic "0", with bit 6 set to a "1". The other bits will be set to a logic "1" if the corresponding condition is TRUE.

The bit layout is:

Bit	Contents
0	Read Exception Sent (Exception Codes 1-3)
1	Slave Abort Exception Sent (Exception Code 4)
2	Slave Busy Exception Sent (Exception Codes 5-6)
3	Slave Program NAK Exception Sent (Exception Code 7)
4	Write Timeout Error Occurred
5	Currently in Listen Only Mode (always zero, the COM16 does not support Listen Only Mode)
6	1
7	0

Table 3-3

Communication-capable Circuit Breakers

WL Circuit Breaker

Function 15: Write Multiple Coils

Function	This function sets the state of multiple control bits and extra flags in a COM16 slave.														
Bit Start Address	Any value from 0000 hex to 000F hex. If any other address is specified, an Exception Code of 02 (Invalid Data Address) will be returned.														
Quantity of Bits	If "Quantity of Bits" is not in the range of 1 to 16, an Exception Code of 03 (Invalid Data Value) will be returned. If an attempt to write a bit beyond Bit Address 000F hex is made, an Exception Code of 02 (Invalid Data Address) will be returned.														
Byte Count	<p>This is the "Quantity of Bits" / 8. If the division remainder is non-zero, then 1 is added to "Byte Count". If "Byte Count" is incorrect, an Exception Code of 03 (Invalid Data Value) is returned.</p> <p>The following is an example of a request to set the state of six extra flags in a COM16 slave device at MODBUS address 7. Attempts to change unused bits will have no effect. Setting the indicated bits would: Clear Logs, Clear Min./Max., Clear Counters and Sync Time Stamp.</p> <table><tr><td>Bit:</td><td>10</td><td>11</td><td>12</td><td>13</td><td>14</td><td>15</td></tr><tr><td>State:</td><td>1</td><td>1</td><td>0</td><td>0</td><td>1</td><td>1</td></tr></table> <p>The data contents are one byte: 33 hex (0011 0011 binary). The binary bits correspond in the following way: The byte transmitted (33 hex) addresses bits 10 ... 15, with the least significant bit addressing the lowest bit (10) in this set. The unused bits are zero-filled.</p> <p>The response returns the slave address, function code, starting address and Quantity of Bits written.</p>	Bit:	10	11	12	13	14	15	State:	1	1	0	0	1	1
Bit:	10	11	12	13	14	15									
State:	1	1	0	0	1	1									

Function 16: Write Multiple Registers

Function	This function writes a complete Dataset to a COM16 slave.
Start Address	Any value within the address range defined for each of the data sets. If any other address is specified, an Exception Code of 02 (Invalid Data Address) will be returned.
Quantity of Registers	If "Quantity of Registers" is not in the range of 1 to 125, an Exception Code of 03 (Invalid Data Value) will be returned. If the "Quantity of Registers" is not correct for the Dataset indicated by the "Start Address", an Exception Code of 02 (Invalid Data Address) will be returned.

Exception Responses

Except for broadcast messages, when a master device sends a query to a slave device, it expects a normal response. One of four possible events can occur from the master's query:

1. If the slave device receives the query without a communication error, and can handle the query normally, it returns a normal response.
2. If the slave does not receive the query due to a communication error, no response is returned. The master program will eventually process a timeout condition for the query.
3. If the slave receives the query, but detects a communication error (parity or CRC), no response is returned. The master program will eventually process a timeout condition for the query.
4. If the slave receives the query without a communication error, but cannot handle it (for example, if the request is to read a non-existent coil or register), the slave will return an exception response informing the master of the nature of the error.

The exception response message has two fields that differentiate it from a normal response:

Function Code Field: In a normal response, the slave echoes the function code of the original query in the function code field of the response. All function codes have a most-significant bit (MSB) of 0 (their values are all below 80 hex). In an exception response, the slave sets the MSB of the function code to 1 (adds 80 hex to the function code). With the function code's MSB set, the master's application program can recognize the exception response and can examine the data field for the exception code.

Data Field: In a normal response, the slave may return data or statistics in the data field (any information that was requested in the query). In an exception response, the slave returns an exception code in the data field. This defines the slave condition that caused the exception.

Example:

Request Message to slave

The following is an example of a request to read Dataset 1 (Diagnostic Information) from a COM16 slave device at MODBUS address 7. Dataset 1 has 8 registers, but in this example, the Master tries to read just 6 registers.

07H	Slave Address
03H	Function Code
01H	Register Start Address "High" (Dataset 1 address is 0100 hex)
00H	Register Start Address "Low"
00H	Quantity of Registers "High"
06H	Quantity of Registers "Low" (6 registers is not valid)
xxH	CRC Check Code "Low"
xxH	CRC Check Code "High"

Reply Message from slave

The response returns the function code with the high bit set indicating an exception response. The Exception Code returned is 03 (Invalid Data Value). This exception code indicates that an illegal amount of data was specified for the requested Dataset.

07H	Slave Address
83H	Function Code
03H	Exception Code (Illegal Register Amount)
xxH	CRC Check Code "Low"
xxH	CRC Check Code "High"

Exception Codes

Code	Name	Meaning
01 hex	Illegal Function	The function code received in the query is not an allowable action for the COM16 slave. If a Poll Program Complete command was issued, this code indicates that no program function preceded it.
02 hex	Illegal Data Address	The data address received in the query is not an allowable address for the COM16 slave.
03 hex	Illegal Data Value	A value contained in the query data field is not an allowable value for the COM16 slave.
04 hex	Slave Device Failure	An unrecoverable error occurred while the COM16 slave was attempting to perform the requested action.
05 hex	Acknowledge	The COM16 slave has accepted the request and is processing it, but a long duration of time will be required to do so. This response is returned to prevent a timeout error from occurring in the master. The master can next issue a Poll Program Complete message to determine if processing is completed.
06 hex	Slave Device Busy	The COM16 slave is still busy processing the previous request. The master should re-transmit the message later when the COM16 slave is free.
07 hex	Negative Acknowledge	This code is returned for an unsuccessful programming request using function code 13 or 14 decimal. The COM16 slave will never return this exception response since it does not support function 13 or 14.
08 hex	Memory Parity Error	The COM16 slave attempted to read extended memory, but detected a parity error in the memory. The master can retry the request, but service may be required on the COM16 slave device.

Table 3-4

The following functions are not supported by the COM16. If a COM16 slave receives a query for any of these functions, an Exception Code of 01 (Illegal Function) will be the response.

Function 06: Write Single Register

Function 17: Report Slave ID

Function 20: Read General Reference

Function 21: Write General Reference

Function 22: Mask Write 4X Register

Function 23: Read/Write 4X Registers

Function 24: Read FIFO Queue

Communication-capable Circuit Breakers

WL Circuit Breaker

Default Register Lists (Function 04 Data Blocks)

Basic Data Type 1 Registers and Default Data Points

Register	Byte	Name	Default Data Point – WL
1	0, 1	Status Register	WL status bits
2	2, 3	Data Block 1	Phase 1 current
3	4, 5	Data Block 2	Phase 2 current
4	6, 7	Data Block 3	Phase 3 current
5	8, 9	Data Block 4	Max current in phase under highest load
6	10	Block 1 property byte	PB of phase 1 current
	11	Block 2 property byte	PB of phase 2 current
7	12	Block 3 property byte	PB of phase 3 current
	13	Block 4 property byte	PB of max current in phase under highest load

Table 3-5

Basic Data Type 2 Registers and Default Data Points

Register	Byte	Name	Default Data Point – WL
1	0, 1	Status Register	WL status bits
2	2, 3	Data Block 1	Phase 1 current
3	4, 5	Data Block 2	Phase 2 current
4	6, 7	Data Block 3	Phase 3 current
5	8, 9	Data Block 4	Max current in phase under highest load
6	10, 11	Data Block 5	Current in neutral conductor
7	12, 13	Data Block 6	Average phase to phase voltage
8	14, 15	Data Block 7	Average of power factors of 3 phases
9	16, 17	Data Block 8	Total active energy of 3 phases*
10	18	Block 1 property byte	PB of phase 1 current
	19	Block 2 property byte	PB of phase 2 current
11	20	Block 3 property byte	PB of phase 3 current
	21	Block 4 property byte	PB of max current in phase under highest load
12	22	Block 5 property byte	BP of current in neutral conductor
	23	Block 6 property byte	BP of average phase to phase voltage
13	24	Block 7 property byte	BP of average of power factors of 3 phases
	25	Block 8 property byte	BP of total active energy of 3 phases

*Only 2 bytes of the 4 byte data point will be communicated (range: 0 - 65535MWh)

Table 3-6

Basic Data Type 3 Registers and Default Data Points

Register	Byte	Name	Default Data Point – WL
1	0, 1	Status Register	WL status bits
2	2, 3	Data Block 1	Phase 1 current
3	4, 5	Data Block 2	Phase 2 current
4	6, 7	Data Block 3	Phase 3 current
5	8, 9	Data Block 4	Max current in phase under highest load
6	10, 11	Data Block 5	Current in neutral conductor
7	12, 13	Data Block 6	Phase to phase voltage L1 to L2
8	14, 15	Data Block 7	Phase to phase voltage L2 to L3
9	16, 17	Data Block 8	Phase to phase voltage L3 to L1
10	18, 19	Data Block 9	Phase to neutral voltage L1
11	20, 21	Data Block 10	Phase to neutral voltage L2
12	22, 23	Data Block 11	Phase to neutral voltage L3
13	24, 25	Data Block 12	Average of power factors of 3 phases
14	26, 27	Data Block 13	Total active energy of 3 phases*
15	28, 29	Data Block 14	Total apparent power of 3 phases
16	30	Block 1 property byte	PB of phase 1 current
	31	Block 2 property byte	PB of phase 2 current
17	32	Block 3 property byte	PB of phase 3 current
	33	Block 4 property byte	PB of max current in phase under highest load
18	34	Block 5 property byte	PB of current in neutral conductor
	35	Block 6 property byte	PB of phase to phase voltage L1 to L2
19	36	Block 7 property byte	PB of phase to phase voltage L2 to L3
	37	Block 8 property byte	PB of phase to phase voltage L3 to L1
20	38	Block 9 property byte	PB of phase to neutral voltage L1
	39	Block 10 property byte	PB of phase to neutral voltage L2
21	40	Block 11 property byte	PB of phase to neutral voltage L3
	41	Block 12 property byte	PB of average of power factors of 3 phases
22	42	Block 13 property byte	PB of total active energy of 3 phases*
	43	Block 14 property byte	PB of total apparent power of 3 phases

*Only 2 bytes of the 4 byte data point will be communicated (range: 0 - 65535MWh)

Table 3-7

For additional information on the controlling documents for the definitions of all MODBUS Public Function Codes referenced may be downloaded in PDF format from the MODBUS website <http://www.modbus.org>.

Complete List of Datasets

Datasets: addresses, number of registers and read/write access of each.

Dataset	Description	Starting register address	Number of registers	Number of data bytes	Padding byte required	Read/write access
0	NST 2000/S7 diagnostic information	0000h	2	4	-	Rd
1	NST 2000/S7 diagnostic information (includes DSO)	0100h	8	16	-	Rd
51	Main overview	3300h	119	238	-	Rd
60	Control waveform	3C00h	28	55	Yes	Rd/Wr
61	Diagnostic waveform	3D00h	27	54	-	Rd
62	Diagnostic waveform data channel A and B	3E00h	120	240	-	Rd
64	Diagnostic harmonics	4000h	66	131	Yes	Rd
68	Modules information overview	4400h	23	45	Yes	Rd/Wr
69	Control modules	4500h	22	43	Yes	Rd
72	Metering data: min./max. current, form factor, crest factor	4800h	118	236	-	Rd
73	Metering data: min./max. voltage	4900h	87	174	-	Rd
74	Metering data: min./max. power	4A00h	68	136	-	Rd
76	Metering data: min./max. frequency and THD	4C00h	46	92	-	Rd
77	Metering data: min./max. temperature	4D00h	29	58	-	Rd
78	Metering data: min./max. current (VL only)	4E00h	52	104	-	Rd
91	Statistic information	5B00h	42	84	-	Rd
92	Diagnostic breaker	5C00h	97	194	-	Rd
93	Control metering/trip unit	5D00h	14	27	Yes	Wr
94	Metering data	5E00h	99	197	Yes	Rd
97	Identification details	6100h	112	223	Yes	Rd
98	HW/SW versions	6200h	47	93	Yes	Rd
100	Identification NST2000	6400h	50	100	-	Rd
128	Metering parameters	8000h	52	103	Yes	Rd/Wr
129	Protective parameters	8100h	70	139	Yes	Rd/Wr
130	Set point parameters	8200h	74	148	-	Rd/Wr
131	Parameters ON/OFF	8300h	35	70	-	Rd/Wr
160	Bus parameters	A000h	39	77	Yes	Rd/Wr
162	Device configuration	A200h	38	75	Yes	Rd/Wr
165	Identification description	A500h	97	194	-	Rd/Wr

NOTE:

1. Each Dataset's starting address is the Dataset's number, converted to hex, used as the high byte of the address. Example for Dataset 51:51 decimal equals 33 hex, which gives an address of 3300 hex.
2. Notice that datasets: 60, 64, 68, 69, 93, 94, 97, 98, 128, 129, 160 and 162 have an odd number of data bytes and must be padded with an extra byte at the end of the dataset (set to 00 hex) to create an even number of words (registers).
3. Dataset 98 is for internal use only.

Table 3-8

Sample Dataset

Dataset 94 – Current Metering Values
Starting Address: 5E00 hex, Total Registers: 99, Access: Read Only

Byte	Register	Description	Units	Min	Max	Format	Length (Bits)	Scale
0	424065	Phase unbalance current (in %)	%	0	100	unsigned char	8	0
1		Reserved	-	-	-	-	8	-
2	424066	Demand current 3-phases	A		8000	unsigned int	16	0
4	424067	Demand current L1	A	30	8000	unsigned int	16	0
6	424068	Demand current L2	A	30	8000	unsigned int	16	0
8	424069	Demand current L3	A	30	8000	unsigned int	16	0
10	424070	Phase A current	A	0	65535	unsigned int	16	0
12	424071	Phase B current	A	0	65535	unsigned int	16	0
14	424072	Phase C current	A	0	65535	unsigned int	16	0
16	424073	Current demand over three phases	A	0	65535	unsigned int	16	0
18	424074	Current N-phase	A	0	65535	unsigned int	16	0
20	424075	Ground fault current	A	0	65535	unsigned int	16	0
22	424076	Phase unbalance voltage (in %)	%	0	100	unsigned char	8	0
23		Reserved	-	-	-	-	8	-
24	424077	Delta voltage between Phase L1 and L2	V	15	1150	unsigned int	16	0
26	424078	Delta voltage between Phase L2 and L3	V	15	1150	unsigned int	16	0
28	424079	Delta voltage between Phase L3 and L1	V	15	1150	unsigned int	16	0
30	424080	Star voltage Phase L1	V	10	700	unsigned int	16	0
32	424081	Star voltage Phase L2	V	10	700	unsigned int	16	0
34	424082	Star voltage Phase L3	V	10	700	unsigned int	16	0
36	424083	Demand of the delta voltage	V	5	1150	unsigned int	16	0
38	424084	Demand of the star voltage	V	10	700	unsigned int	16	0
40	424085	Sum of apparent power	kVA	39	24000	unsigned int	16	0
42	424086	Sum of real power	kW	-24000	24000	signed int	16	0
44	424087	Real power in Phase L1	kW	-8000	8000	signed int	16	0
46	424088	Real power in Phase L2	kW	-8000	8000	signed int	16	0
48	424089	Real power in Phase L3	kW	-8000	8000	signed int	16	0
50	424090	Sum of reactive power	kvar	-24000	24000	signed int	16	0
52	424091	Demand of the real power 3-phases	kW	-8000	8000	signed int	16	0
54	424092	Demand of the real power in Phase L1	kW	-8000	8000	signed int	16	0
56	424093	Demand of the real power in Phase L2	kW	-8000	8000	signed int	16	0
58	424094	Demand of the real power in Phase L3	kW	-8000	8000	signed int	16	0
60	424095	Demand of the apparent power 3-phases	kVA	13	8000	unsigned int	16	0
62	424096	Apparent power in Phase L1	kVA	13	8000	unsigned int	16	0
64	424097	Apparent power in Phase L2	kVA	13	8000	unsigned int	16	0
66	424098	Apparent power in Phase L3	kVA	13	8000	unsigned int	16	0
68	424099	Demand of the apparent power i. d. Phase L1	kVA	13	8000	unsigned int	16	0

(continued on the next page)

Communication-capable Circuit Breakers

WL Circuit Breaker

Dataset 94 – Current Metering Values

Starting Address: 5E00 hex, Total Registers: 99, Access: Read Only (continued from the previous page)

Byte	Register	Description	Units	Min	Max	Format	Length (Bits)	Scale
70	424100	Demand of the apparent power i. d. Phase L2	kVA	13	8000	unsigned int	16	0
72	424101	Demand of the apparent power i. d. Phase L3	kVA	13	8000	unsigned int	16	0
74	424102	Demand of the reactive power 3-phases	kvar	-8000	8000	signed int	16	0
76	424103	Reactive power in Phase L1	kvar	-8000	8000	signed int	16	0
78	424104	Reactive power in Phase L2	kvar	-8000	8000	signed int	16	0
80	424105	Reactive power in Phase L3	kvar	-8000	8000	signed int	16	0
82	424106	Real energy in normal direction	MWh	0	10000	unsigned long	32	0
86	424108	Real energy in reverse direction	MWh	0	10000	unsigned long	32	0
90	424110	Reactive energy in normal direction	Mvarh	0	10000	unsigned long	32	0
94	424112	Reactive energy in reverse direction	Mvarh	0	10000	unsigned long	32	0
98	424114	Demand of the power factor	PF	600	1000	signed int	16	0.001
100	424115	Power factor in Phase L1	PF	600	1000	signed int	16	0.001
102	424116	Power factor in Phase L2	PF	600	1000	signed int	16	0.001
104	424117	Power factor in Phase L3	PF	600	1000	signed int	16	0.001
106	424118	Frequency	Hz	1500	44000	unsigned int	16	0.01
108	424119	THD of the current	%	1	100	unsigned char	8	0
109	--	THD of the voltages	%	1	100	unsigned char	8	0
110	424120	Form factor	0	0	255	unsigned char	8	0.1
111	--	Crest factor	0	0	255	unsigned char	8	0.1
112	424121	Reserved	-	-	-	-	16	-
114	424122	Temperature in the cubicle (detected in the COM16)	°C	-127	128	unsigned char	8	0
115	--	Temperature in the circuit breaker (detected in BSS)	°C	-20	85	unsigned char	8	0

Bit Mapping for Breaker Status Register 413158

Byte	Register	Description
0	Bit 0	Breaker Open
0	Bit 1	Breaker Closed
0	Bit 2	Breaker Tripped (mechanical trip indication)
0	Bit 3	Breaker is ready to close
0	Bit 4	Storage spring is charged
0	Bit 5	1st auxillary release is operated
0	Bit 6	2nd auxillary release is operated

WL Configurator Brief Description

WL Configuration software, WL Config[®], is a software configuration tool used to set protective settings, set points and additional protective functions in the WL trip unit. It is designed for use on a Windows 2000 or XP PC with a minimum of 128MB RAM and a 1.2GHz or faster processor. The installation is a simple and intuitive process, with step-by-step instructions for the user.

WL Config runs in a web browser window, with the "Main Menu" tree below displayed at start-up:



After the program is installed on the PC, WL Config[®] communicates with WL Trip Units via the PC's serial port. The COM16 MODBUS communication module is required for use with this software. An RS485 to RS232 converter is provided as part of the WL Config Software Kit (catalog number: WLCONFIG). WL Config uses the MODBUS protocol to communicate with the COM16 (typically at 19,200 baud, even parity and with a default MODBUS address of 126).

The internal CubicleBUS communications bus of the WL Circuit Breaker allows connectivity between the COM16, Digital I/O, Analog I/O, and Electronic Trip Units (ETU). **CubicleBUS** requires 24V DC+ power and provides a serial link to all the modules in the WL Circuit Breaker **CubicleBUS** system. 24V DC power must be available in the system for communication to exist between the PC and the COM16. The serial data generated by the Trip Unit is available at the COM16, which serves as a gateway to the **CubicleBUS** data.

The main purpose of WL Config is to configure the communication, protective and alarm programmable parameters of the WL Trip Unit, and also configure **CubicleBUS** Module parameters.

The parameters changed by the user and sent to the device are verified by the PC program and the device for a valid setting, and if out of range, an error message is displayed. Alarms can also be configured for any associated I/O modules.

WL Config can interrogate a Trip Unit for instantaneous or historical data and display that information for user evaluation. If the system is equipped with the optional Metering *Plus* module, the voltage and current waveforms and any harmonic information can be viewed.

Note: *WL Config can be also used in an offline mode, without a WL Trip Unit attached, to allow the configuration of a particular job to be completed and verified prior to downloading. This offers the advantages of quickly configuring many trip units with the same data and also provides organized electronic files for storing past configurations.*



Communication-capable Circuit Breakers

WL Circuit Breaker

Notes

Breaker Data Adapter (BDA) Breaker Data Adapter *Plus* (BDA *Plus*)

Short Description of the BDA/BDA Plus

System Requirements

Connect the BDA/BDA Plus to the WL Circuit Breaker

Communication via the Serial Interface

Communication via the Ethernet Interface

Operating Instructions

Troubleshooting

4

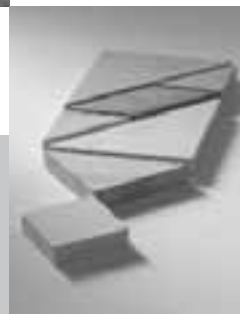

Breaker Data Adapter (BDA)

Brief Description and System Requirements

The Breaker Data Adapter (BDA) is the first circuit breaker parameterization device to feature an integrated webserver for parameterization, monitoring and diagnostics. The BDA *Plus* also features an Ethernet interface for connection to the Ethernet, Intranet or Internet.

Description

The BDA can be used to read and change the parameters of WL Circuit Breakers, display measured values, as well as visualize, analyze and store diagnostic data.

It is comprised of a microcomputer on which an embedded Linux operating system featuring a web server application runs. The HTML pages and the Java program codes are stored in the internal flash and can be displayed on a browser. The browser itself displays the HTML pages, while the more complex functions are implemented using Java applets. A Java Virtual Machine (VM) is required to run the Java applets. This is available free of charge for a wide range of browsers and operating systems.

All the pages that can be displayed are stored on the BDA in German and English; the language is selected when the data is called up in the browser for the first time. A new language can be selected during operation.

The cable supplied is used to connect the BDA to the WL Circuit Breaker. The BDA can either be connected directly to the trip unit or to the last

CubicleBUS module. The indicator with the browser application (e.g. laptop) is connected to the BDA using a null modem cable.

The Breaker Data Adapter *Plus* features an additional Ethernet interface, which means that the BDA *Plus* can also be addressed via the Intranet or Internet. The communication options available via the Intranet or Internet are restricted only by the network administration.

All write actions (changing parameters or switching actions) are password protected.

When connected temporarily, the BDA can be used to read and change parameters, perform diagnoses, or display measured values. For this reason, a magnet is supplied with the BDA so that it can be attached to doors and other elements containing iron. The DIN rail installation kit supplied can be used to connect the BDA permanently. Depending on the application, the BDA *Plus* is normally used for a permanent connection. In this way, it can be accessed via the Ethernet, Intranet or Internet.

If the WL is to be switched open or closed via the BDA, the MODBUS COM16 module must also be installed. This contains the connections for activating the opening and closing solenoids and the motorized drive.

The MODBUS communication function does not have to be enabled at this point.

Benefits of the BDA:

- No special software has to be installed; the display software is supplied with the circuit breaker data directly from the BDA. The appropriate help pages are also stored directly in the BDA, which means they are always available when they are needed.
- The comprehensive use of Java technology ensures the systems can operate regardless of the operating system. This means that the BDA can be used with all Windows versions, Linux, and all other operating systems provided by the corresponding Java Virtual Machine.
- Smaller hand-held devices with PocketPC as the operating system can also be used, as can PCs or notebooks, provided they fulfill the system requirements.



Breaker Data Adapter (BDA)

WL Circuit Breaker

BDA in Offline Mode (or BDA Plus)

In offline mode, the BDA or BDA Plus is only connected to a laptop (represents all input/output devices). All the required parameters can be set in this operating mode and saved for later use (download to the circuit-breakers). No power is supplied via the laptop COM interface, which means that an additional power supply unit (24V DC) must be connected to the BDA.

BDA as a Hand-Held Device (or BDA Plus)

As a hand-held device, the BDA is operated by connecting it temporarily to the appropriate WL trip unit interface.

All circuit breakers in a system can be parameterized one after the other using just one BDA, and the parameter data saved to a laptop for further processing. In addition, all the diagnostic data of the circuit breaker can be read via the BDA.

An additional 24V DC power supply is required if the circuit breaker is not yet supplied with power (e.g. by means of an external 24V DC source on the CubicleBUS).



Graphic 4-1 The BDA must be supplied externally with 24V DC. Parameters can be set, stored, and printed out.



Graphic 4-2 In temporary mode, the BDA is normally attached using magnets.



Breaker Data Adapter (BDA)

WL Circuit Breaker

BDA *Plus* as an Ethernet Interface

In addition to the previously mentioned functions, the BDA *Plus* enables data to be accessed via the Ethernet. In this case, the circuit breaker data is not transmitted as net data, but displayed on HTML pages in an application-specific format. The BDA/BDA *Plus* cannot be used to integrate the circuit breakers in higher level visualization systems. To display several WL Circuit Breakers around the clock online using the communication system in a switchgear unit without the MODBUS module, one BDA *Plus* is required for each circuit breaker. In this case, the circuit breaker is selected by entering the BDA-specific IP address in the browser. Password protection in the BDA and BDA *Plus* prevents unauthorized access.

By making the appropriate settings on any firewall, WL Circuit Breakers can also be accessed via the Intranet and Internet.

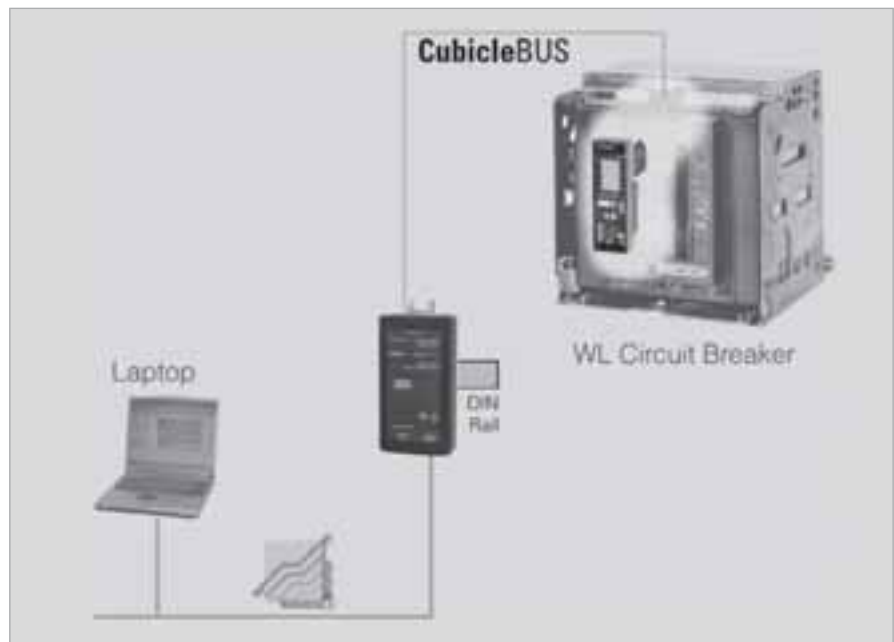

Graphic 4-3 Depending on the network settings (routing tables and firewall entries), the circuit breaker can be diagnosed by all PCs with an Internet connection.

System Requirements

Certain prerequisites have to be fulfilled before the BDA or BDA Plus can be operated. One of the two standard browsers (Internet Explorer V5.5 or higher or Netscape Navigator V6.2 or higher) must be installed on the output device (e.g. laptop). Compatibility with other browsers cannot be guaranteed.

To ensure independence between the operating systems and browsers, all the pages have been written in HTML code and Java applets. A Java Virtual Machine is required to display the pages.

What is Java?

Java is a platform-neutral object-oriented programming language originally developed by Sun Microsystems. Java is implemented in all IT areas of the commercial, industrial and administrative sectors, and is available free of charge for many operating systems and platforms – from cell phones to real-time mainframe systems.

Unlike most compiler languages, Java applets are not directly translated into a set of commands that can be understood by a "Real Processor". Instead, they are first converted to the "Java Byte Code". Although this byte code is highly machine-oriented, a "Java Virtual Machine" (VM), which emulates a standardized processor for all Java applets, is required on the target computer.

Since Java normally compiles data twice (once with the developer and once with the user), this principle is known as the "Just-In-Time" (JIT) Compiler. Although, Java applets take longer to start, since the machine code is generated during initialization.

However, the same Java applet can run on all supported systems without modifications.

The Java Virtual Machine V2 V1.4.0_01 is required to display the BDA pages. When these pages are called up for the first time, the BDA checks whether Java VM2 is available on the browser. If not, the system automatically displays a window informing the user of this and automatically links the user to the appropriate Sun Microsystems page. An Internet connection must be established to ensure the automatic installation procedure functions properly. If this is not the case, the Virtual Machine required for the Microsoft Windows operating systems can be downloaded from the following address:

http://java.sun.com/products/archive/j2se/1.4.0_01/index.html

Once installed, the option Java 2VM V1.4.0_01 must be activated in the browser (if it is not already).

To avoid conflicts with other Java versions, it is recommended that you uninstall older versions of Java and delete the cache in the browser.

The target system with the browser also requires one or both of the following communication interfaces:

- A serial interface with RS232 design, usually integrated on standard PCs (e.g. COM1) for point-to-point (PPP) communication with the BDA.
- A LAN interface for communicating with the BDA Plus via the Ethernet.

Circuit breaker requirements

The BDA can be connected to WL Circuit Breakers with the following trip units: ETU745, ETU748, ETU755 and ETU776. It can be connected either directly to the trip unit or to the last external CubicleBUS module. Circuit breakers can also communicate with the BDA if they have been retrofitted with the communication function.

Getting started with the BDA Plus

If the BDA Plus is being installed for the first time, the settings for the IP address and the standard gateway as well as the subnet mask must be set using the serial communication via RS232. After this the BDA Plus must be rebooted to load the Ethernet driver with the specified parameters.



Breaker Data Adapter (BDA)

WL Circuit Breaker

Connection to WL Circuit Breakers

To operate the BDA, it must be connected to the target system (e.g. a PC) on one side and a circuit breaker on the other. Different scenarios are possible depending on the application.

For WL Circuit Breakers, two basic methods are available for connecting the BDA, temporary or permanent installation.

Temporary

If the BDA is to be used as a local parameterization tool and several circuit breakers are to be set in succession, the local front interface of the trip unit can be used. The cable required is supplied with the BDA. An additional 24V DC power supply unit is also required if the circuit breaker is not yet supplied with power via the **CubicleBUS**. For this purpose, a voltage connection is located on the top of the BDA next to the interface to the circuit breaker.

In temporary mode, the BDA can be quickly secured to any switchgear cubicle using magnets on the back.

Note: Do not use temporary magnetic installation for BDA where it can fall into energized parts.

Permanent

The trip unit interface through the front connection is not suitable if a BDA or BDA *Plus* is to be permanently connected to a WL Circuit Breaker. The connection on the last **CubicleBUS** module, such as the COM16 module, or one of the other modules, is more suitable. In this case, a cable is supplied with the BDA that can be connected directly to the RJ45 plug-in contact of the **CubicleBUS** module. Typically,

a BDA *Plus* is used for permanent installation. The DIN rail installation kit supplied is used to secure the device.

The principle regarding the power supply is the same as for temporary operation: if the **CubicleBUS** is supplied with power, the BDA will also operate without an extra power supply unit. Otherwise, the BDA must also be connected to a 24V DC power supply unit.



Figure 4-1 The physical BDA interfaces. The connection to the circuit breaker and optional power supply are on the top, while the RS232 interface (or the Ethernet interface in the case of BDA *Plus*) and the RESET button are on the bottom.

Operation

As a microcomputer, the BDA is booted in the same way as a PC. This takes approximately 40 seconds and is started automatically when the power supply is switched on. During this time, the content is loaded from the Flash memory to the main memory, an internal self test is carried out, the operating system (embedded Linux) is booted, and the web server application started.

The RESET button on the underside enables the BDA to be restarted manually at any time.

The LEDs indicate the operating status during the boot-up process. The upper DEVICE LED is first red/green, while the lower **CubicleBUS** LED is red only. After about 10 seconds, this also changes to red/green. During the load process, the Ethernet connection is checked for a connected network. Only then is the appropriate driver loaded. Since the BDA Plus is to be operated with an Ethernet connection, a physical connection to the Ethernet must already exist during the boot-up process.

Meaning of the LEDs on the BDA		
LED	Display	Meaning
DEVICE	red	BDA out of order
	green	BDA in operation
	red/green	BDA booting up
CubicleBUS	red	BDA in online mode and connection to circuit breaker interrupted
	green	Connection exists to CubicleBUS
	red/green	BDA booting up
	off	BDA in offline mode, even if circuit breaker is connected

Table 4-1 The LEDs on the BDA indicate the current operating status.



Figure 4-2 For temporary operation, the BDA can be connected to the local interface of the trip unit. In this configuration, only the RS232 connection to the PC is typically used.

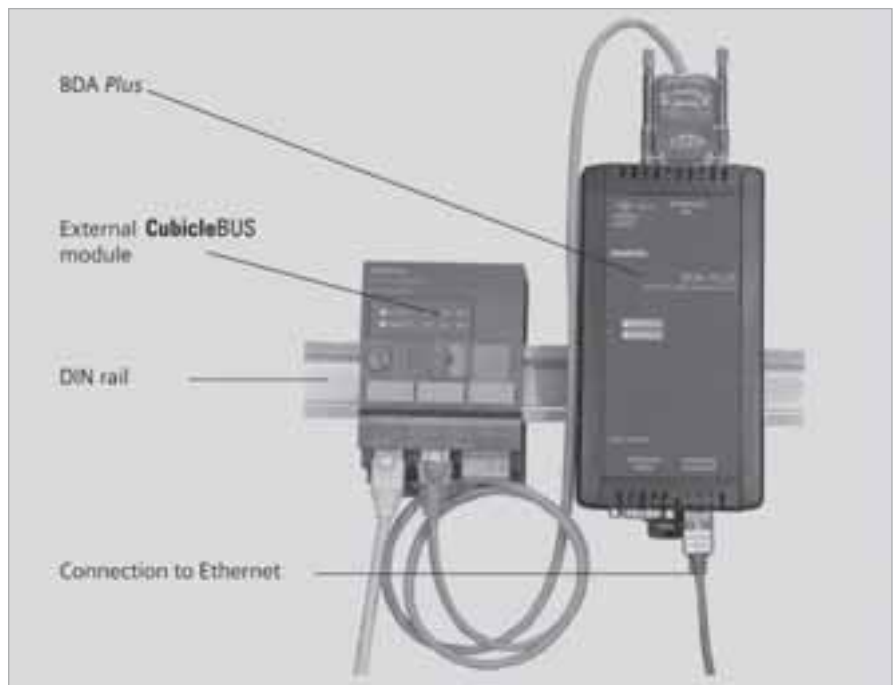

Figure 4-3 In a permanent installation, the BDA should be connected to the last external CubicleBUS module. It can be secured using a DIN rail, as shown above.

Breaker Data Adapter (BDA)

WL Circuit Breaker

When the boot-up process is complete, the DEVICE LED switches to green, while the **CubicleBUS** LED switches to green or is extinguished, depending on the connection.

If the BDA is not supplied power via the **CubicleBUS** of the WL, it must be activated via an external 24V DC power supply. Siemens SITOP 24V DC power supplies are suitable for this purpose.

Other 24V DC power supply units that supply the required power can also be used.

Technical data for the BDA and BDA Plus

Min./Max. operating voltage	19.2V / 28.8V
Current input from the CubicleBUS or power supply unit min./max.	100mA / 300mA
Power loss min./typ./max.	3W / 5W / 7W
Dimensions W/H/D	82mm /153mm / 38mm
Weight	0.38 kg
Operating temperature range	0 to 55°C

Figure 4-4 This table provides technical data for the BDA and BDA Plus



Connection to the BDA via the Serial Communication System

To operate the BDA, it must be connected to the target system (e.g. a PC) on one side and a circuit breaker on the other. A range of options are available, depending on the application and operating system.

To ensure that serial communication is possible between the target system and the BDA, you should carry out the following steps:

- Connect the BDA to the circuit breaker and power supply.
- Connect the BDA to the COM interface of the target system (e.g. PC) using a fully assigned null modem cable. **Note:** With a null modem cable, pins 2 and 3, 4 and 6, and 7 and 8 must be assigned and reversed with respect to each other. The COM port cannot be used by a different application.
- Installing a standard modem. Once the physical connection has been established using a null modem cable, a standard modem must be installed on each PC. The procedure for installing the modem varies slightly depending on the operating system. The screenshots on the following pages provide a step-by-step guide to the procedure. The standard modem to be selected - 28800 bps - is not related to the actual transmission rate. The examples illustrate the connection to the COM1 interface; other interfaces must be set accordingly. The installation process always begins in the Control Panel of the operating system. The default settings in the "Properties" windows of the modem do not

usually have to be changed. They are shown as a reference.

The screenshots on the following pages for Windows98 are identical for Windows95, WindowsNT, and WindowsME. WindowsXP screens are virtually the same as those in Windows2000.

- Installing a data communications connection. Once a standard modem has been installed, a communications link must be established via this modem. To do so, a data communications connection must be set up via "Workstation > Data Communications Network". Once the appropriate modem has been selected, the maximum rate has to be selected again. The name of the connection is user defined, while the user name must be "ppp" and the address signal "555". A preselection code and password must not be entered. All of these settings are shown on the following pages. Windows98 screenshots are used to represent the operating systems Windows95, Windows98; WindowsNT, and WindowsME. Only the screenshots from WindowsXP are used for Windows2000 and WindowsXP.
- Establishing the connection. A communications link is established by activating the installed data communications connection. Once the user name and password have been checked (a password must not be entered), the window for establishing the connection disappears from the Windows systray. The systray is the area on the bottom right next to the system clock in the toolbar. A small icon with two computers appears here. Double-clicking this opens a window displaying the properties of this connection. A test ping can also be used to

check that the connection has been established correctly. Once you have opened the entry screen (Start > Execute) and entered "ping 2.2.2.1", a DOS box appears that displays either "Reply from 2.2.2.1 after..." (connection OK) or "Reply timed out" (connection not available).

- Start the browser (Internet Explorer or Netscape Navigator)
- Entering the target IP address 2.2.2.1. You have to enter 2.2.2.1 in the address line. The usual "http://" does not have to be entered. When you press ENTER, the pages will be loaded from the BDA. **Note:** You may have to include the address 2.2.2.1 in the list of addresses that do not use a proxy server. The use of a proxy server is optional and depends on the network.

A desktop link can be created if the BDA connection is used frequently. To create an Internet Explorer link with the local IP address of the BDA on the desktop, you have to drag the Internet Explorer icon in the address line to the left of the address to the desktop. Alternatively, the BDA start icon can be used. To do so, press the left mouse button to save it on the hard disk as a bitmap and specify it as an icon in the properties window of the link saved on the desktop.



Breaker Data Adapter (BDA)

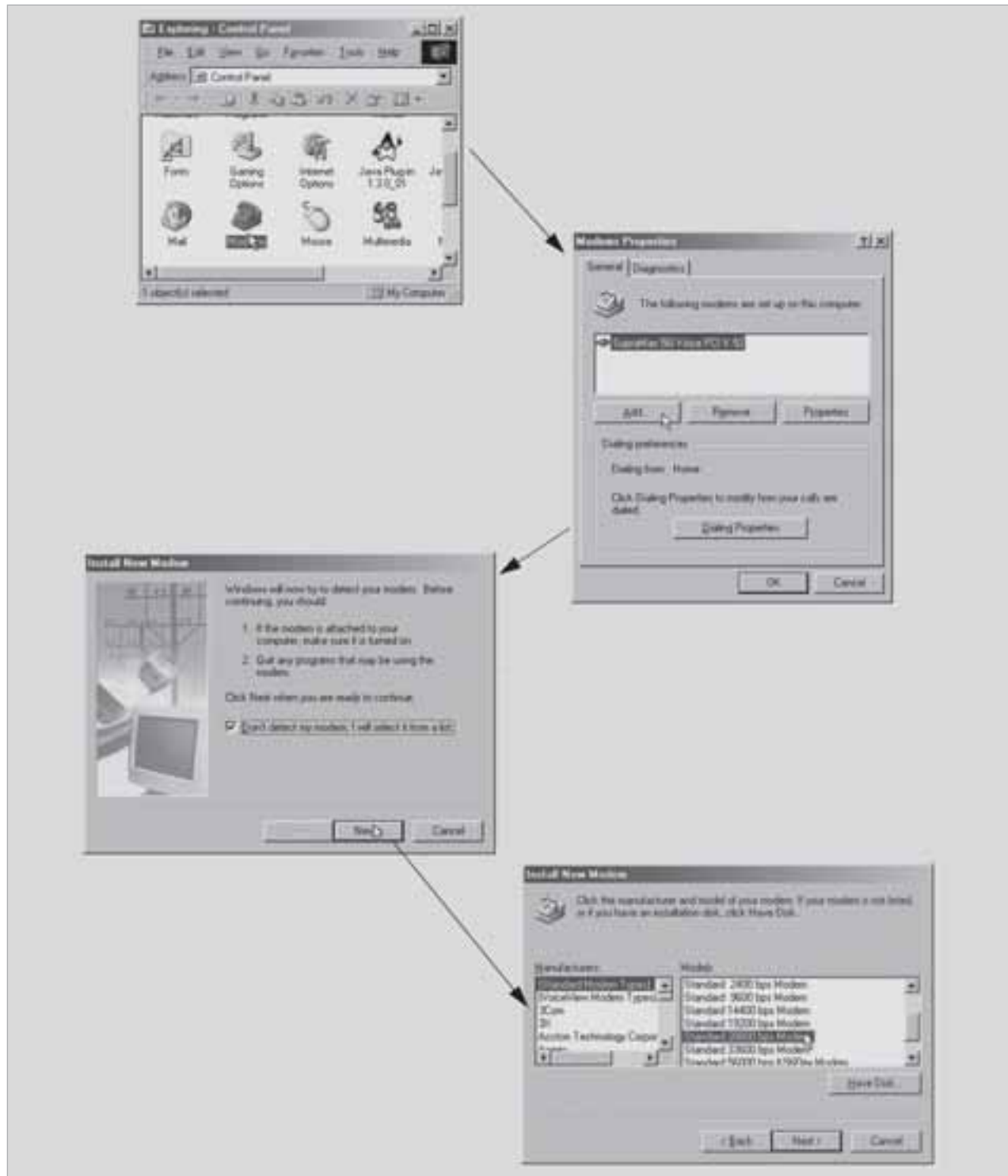

Figure 4-5 Installing a standard modem with Windows98, part 1 (identical to Windows95, WindowsNT and WindowsME): A standard modem (28800 bps) is selected and installed in the Control Panel. The automatic identification function must be switched off for this purpose.

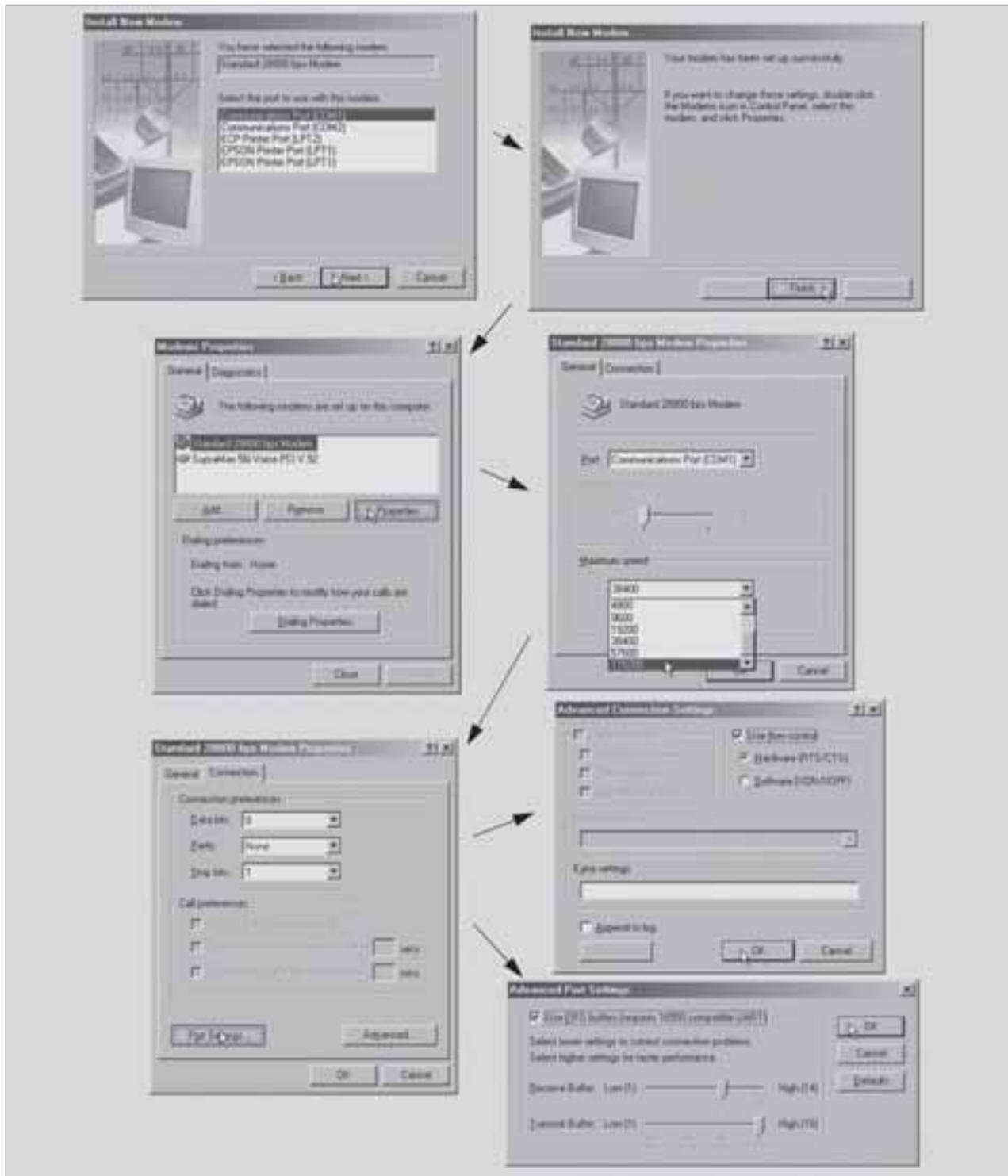

Figure 4-6 Installing a standard modem with Windows98, part 2 (identical to Windows95, WindowsNT and WindowsME): Once you have installed the standard modem, you have to set it to the maximum rate of 115200; the default settings in the other windows are retained.

Breaker Data Adapter (BDA)

WL Circuit Breaker

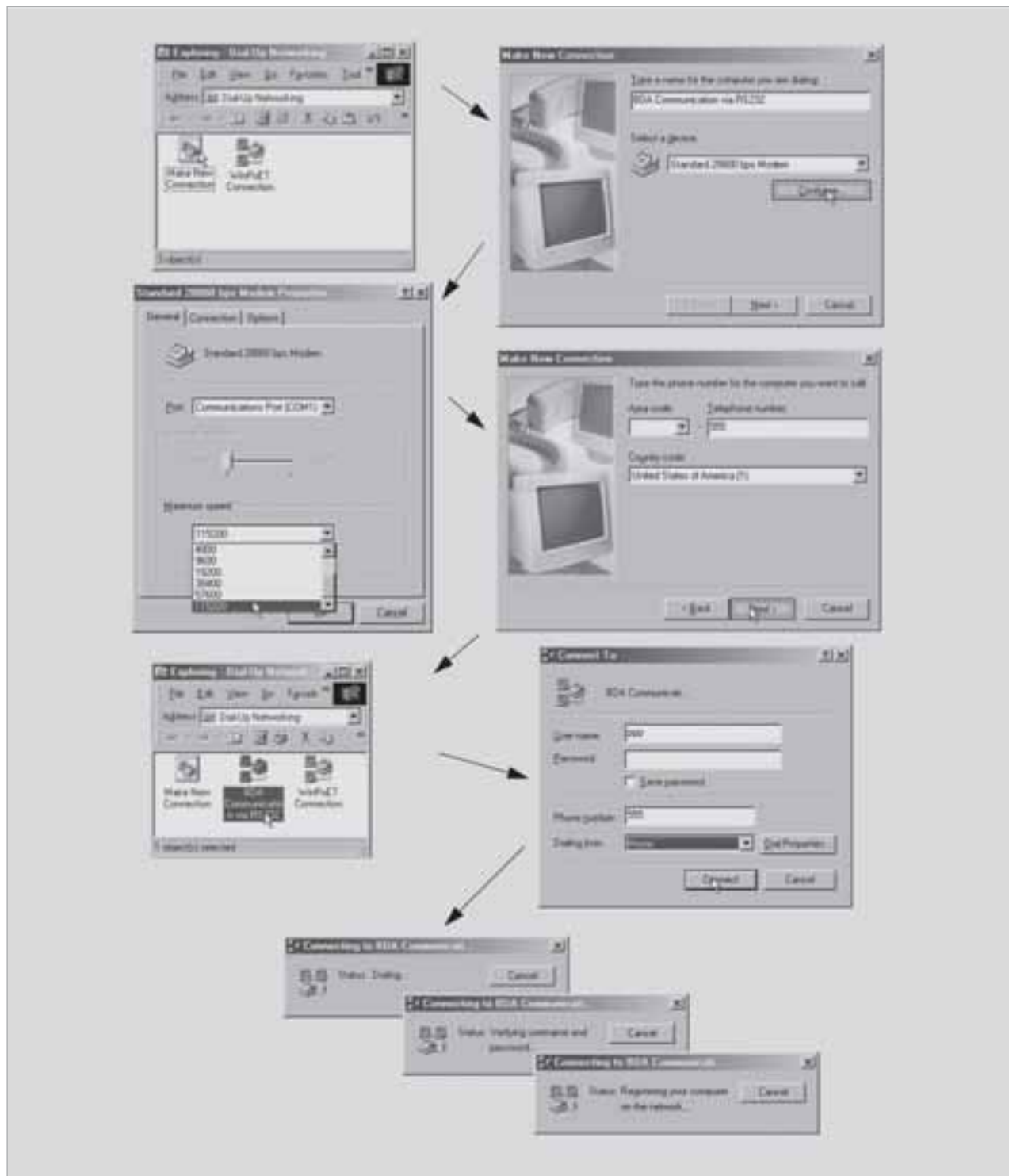

Figure 4-7 Installing a data communications connection to the BDA with Windows98, part 1 (identical to Windows95 and WindowsME): You now have to establish a data communications connection to the BDA. To do so, double-click "Establish New Connection" in the Control Panel and then maintain the windows as shown.



Figure 4-8 Installing a data comm. connection to the BDA with Windows98, part 2 (identical to Windows95 and WindowsME): Once communication has been established, the connection window disappears from the Windows systray. To display the BDA pages, enter address 2.2.2.1 in the browser. To call up the connection window, double-click the relevant icon in the systray.



Figure 4-9 Installing a standard modem with Windows2000, part 1 (identical to WindowsXP): To install a standard modem in WindowsXP, double-click the "Telephone and Modem Options" icon in the Control Panel.

Breaker Data Adapter (BDA)

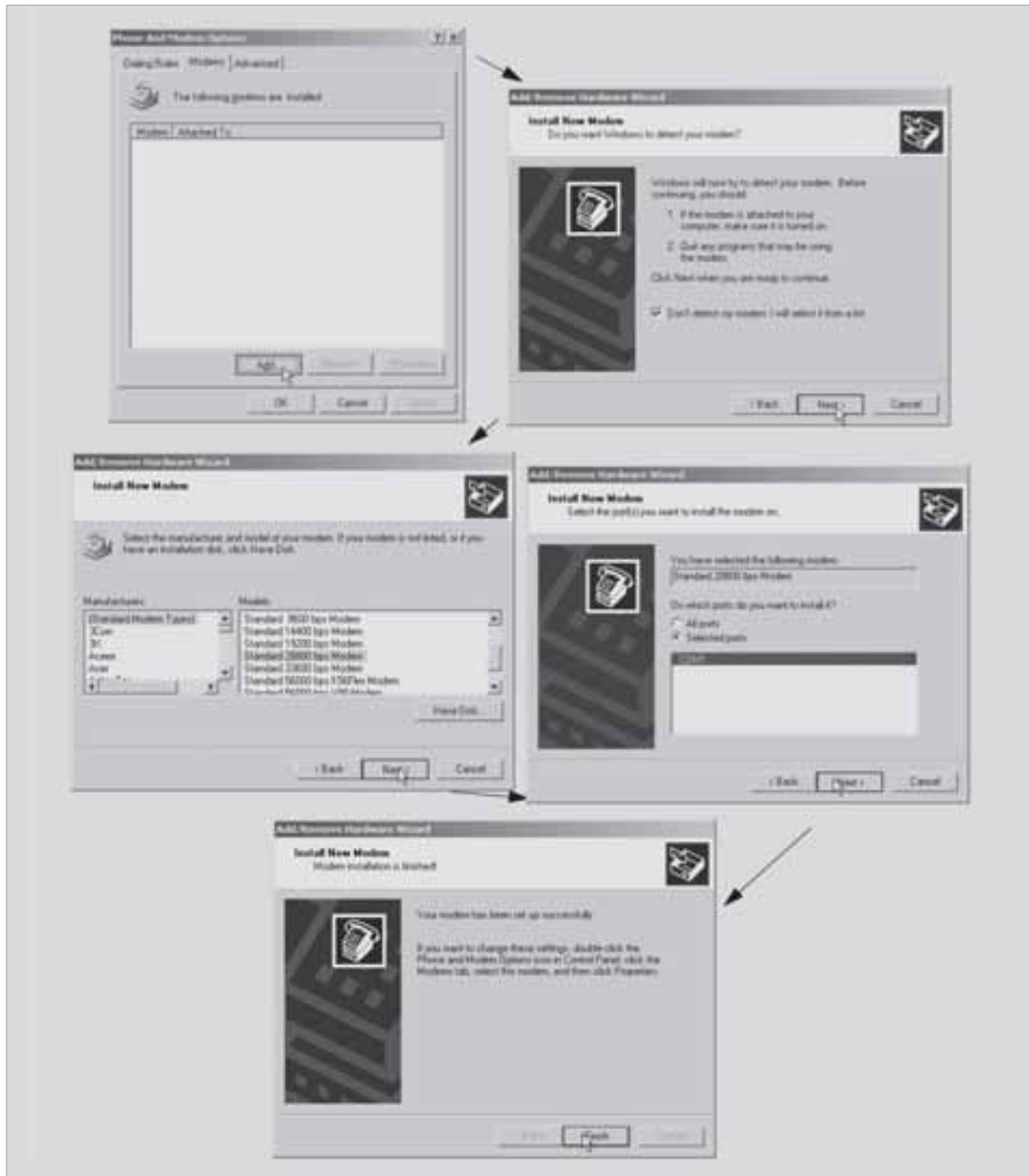

Figure 4-10 Installing a standard modem with Windows2000, part 2 (identical to WindowsXP): Select the standard modem (28800) and assign it to a free COM interface.

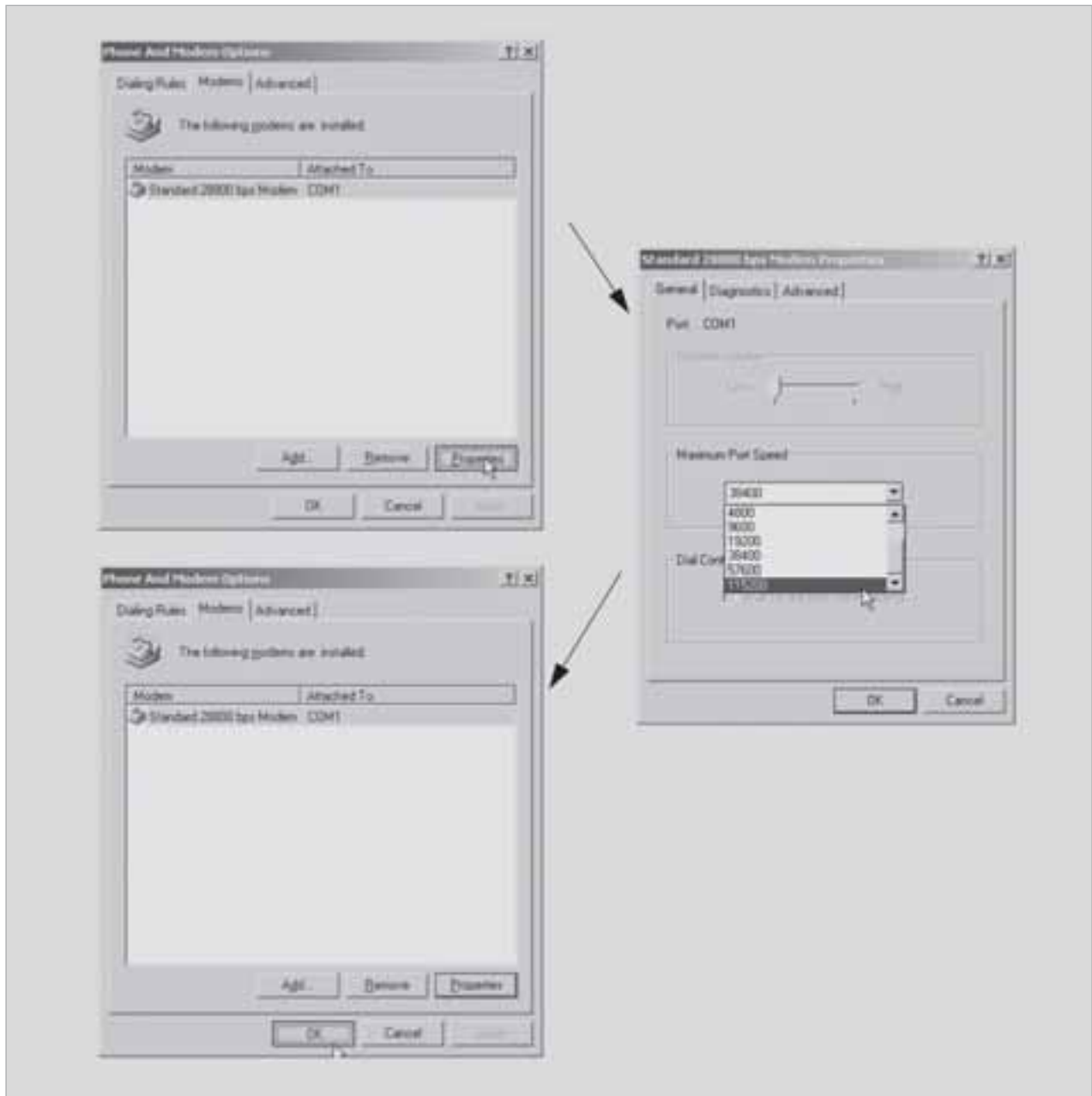

Figure 4-11 Installing a standard modem with Windows2000, part 3 (identical to WindowsXP): After installation, you have to set the maximum rate to 115200. This completes the installation procedure.

Breaker Data Adapter (BDA)

WL Circuit Breaker

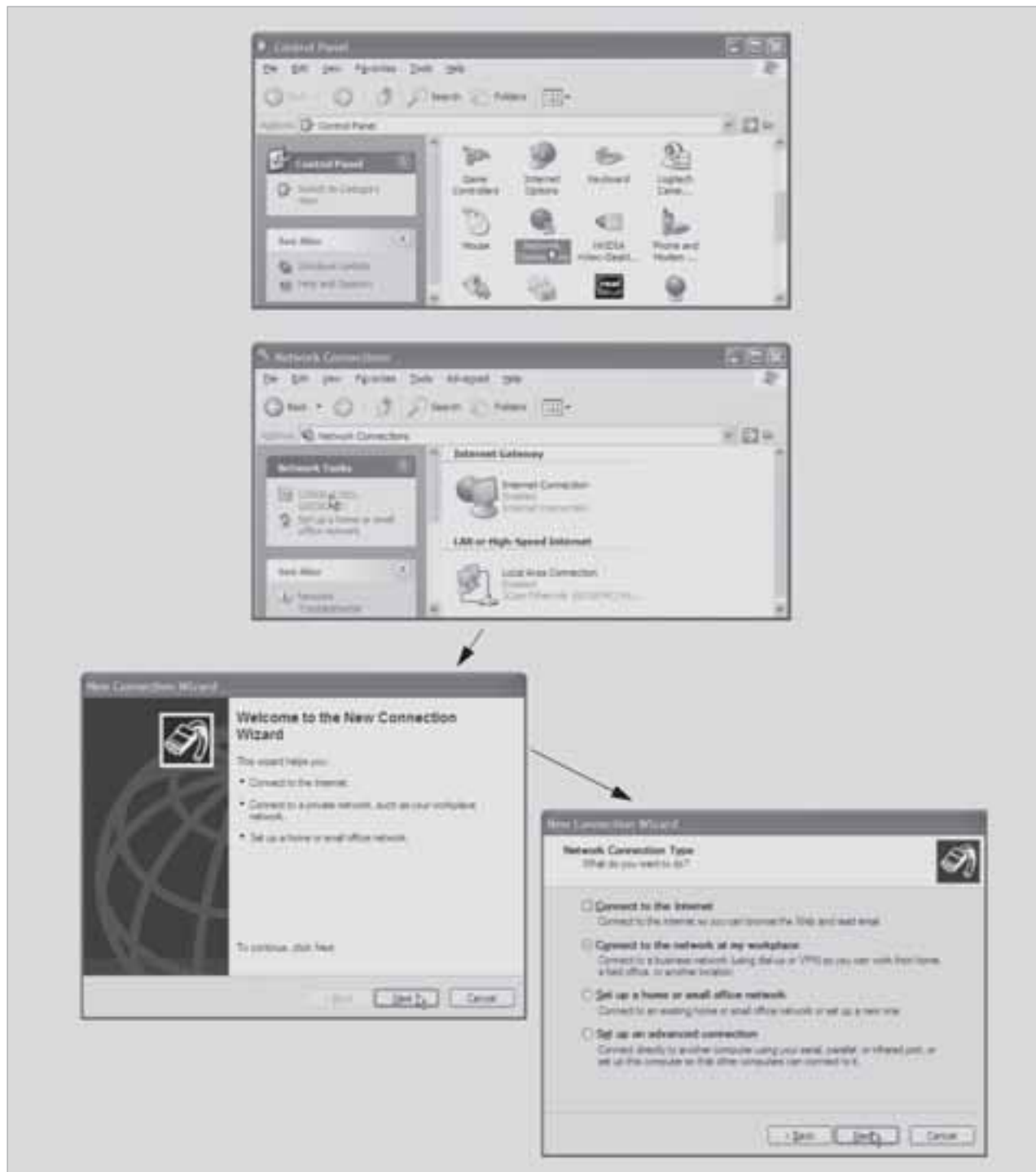

Figure 4-12 Setting up a data communications connection to the BDA with WindowsXP, part 1:

Go from the Control Panel to "Network Environments" and click "Establish New Connection", as shown above. Then follow the instructions provided by the Installation Wizard.

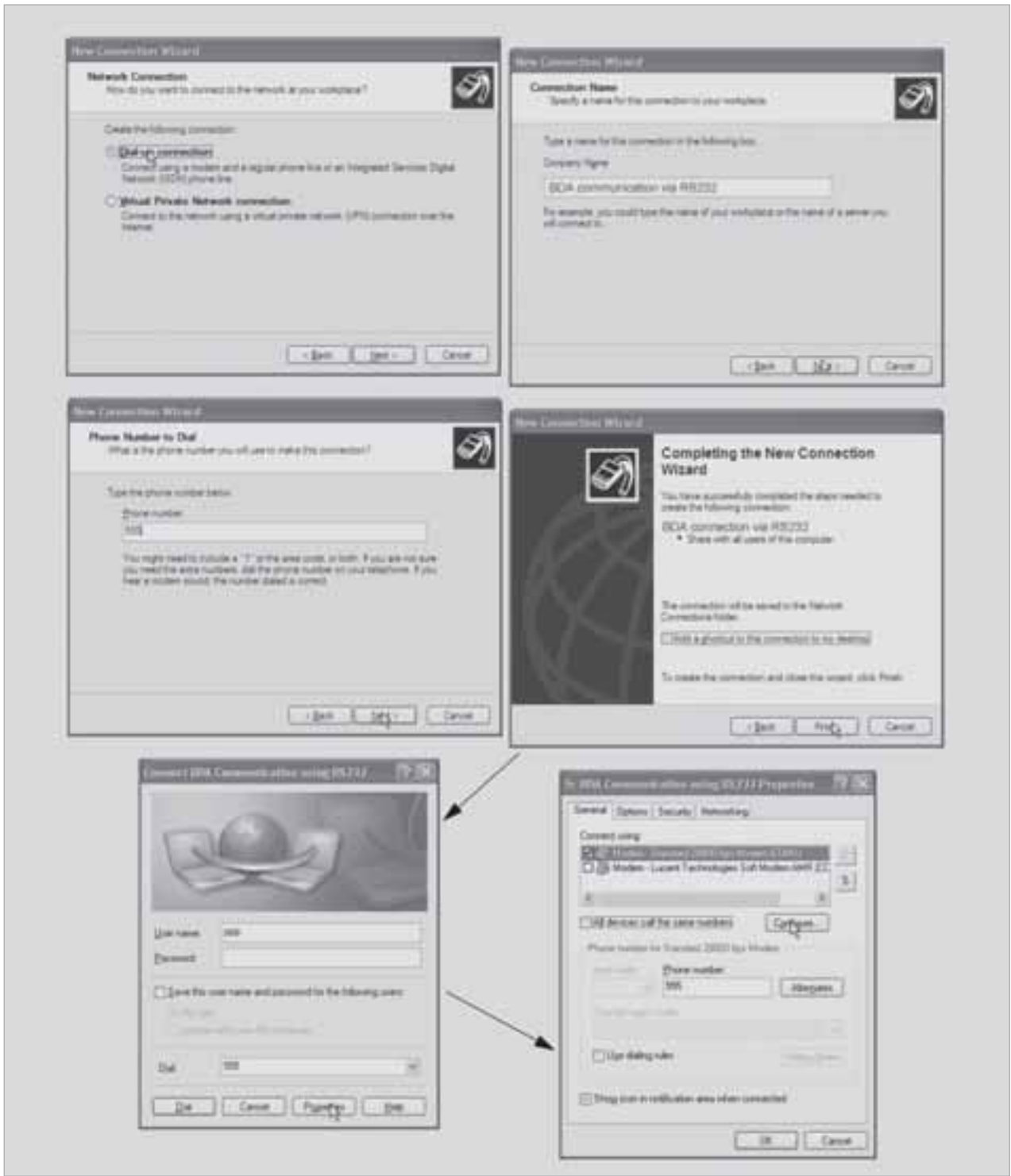

Figure 4-13 Setting up a data communications connection to the BDA with WindowsXP, part 2: Continue following the instructions and maintain the windows as shown above.

Breaker Data Adapter (BDA)

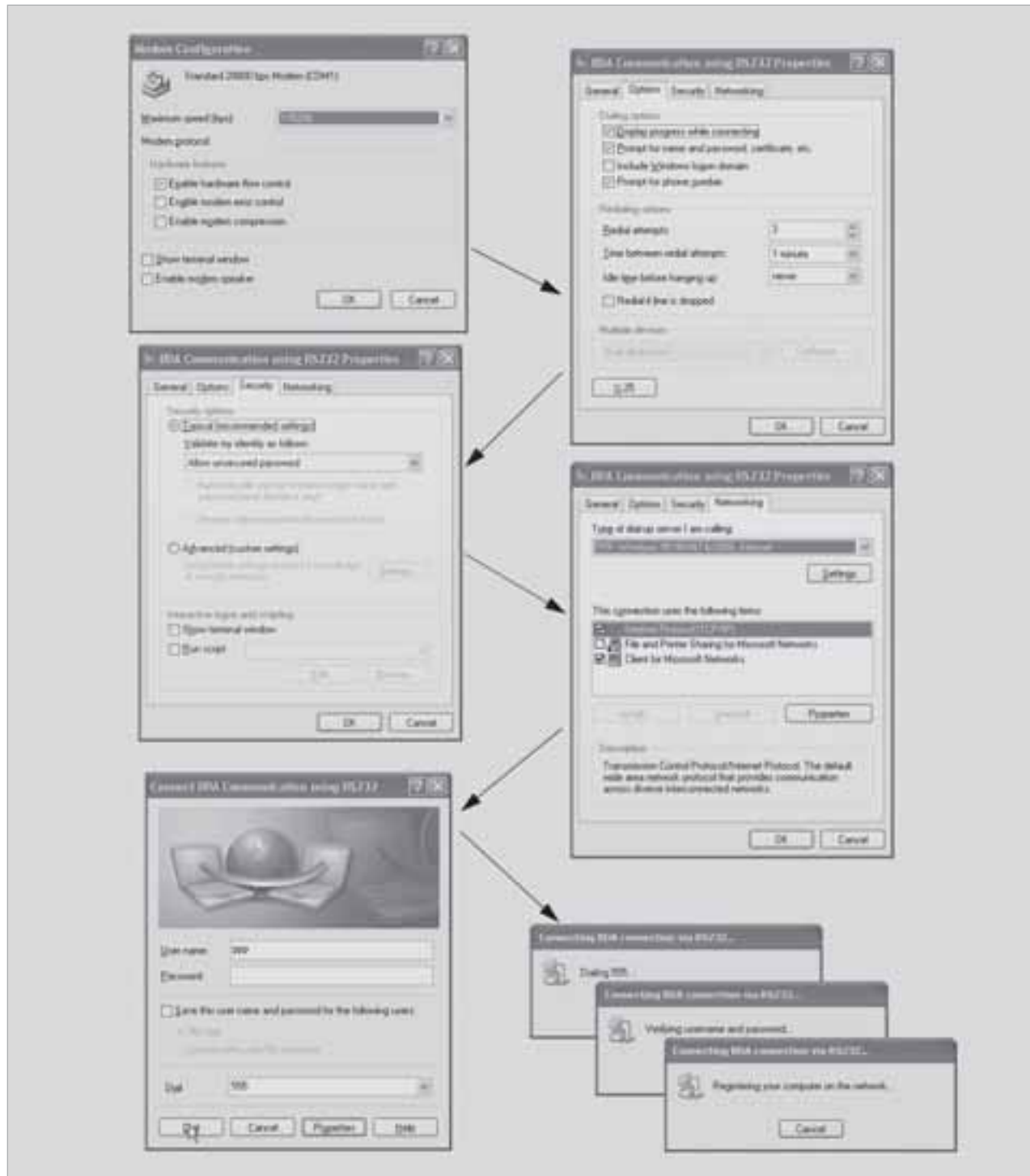

Figure 4-14 Setting up a data communications connection to the BDA with WindowsXP, part 3: Once the data communications connection has been successfully set up, WindowsXP establishes a connection with the BDA when you click "Dial".



Figure 4-15 Setting up a data communications connection to the BDA with WindowsXP, part 4:
 Once the connection has been established, start the browser and enter the address 2.2.2.1. To display the connection properties so that you can check them, double-click the appropriate icon in the systray.

Breaker Data Adapter (BDA)

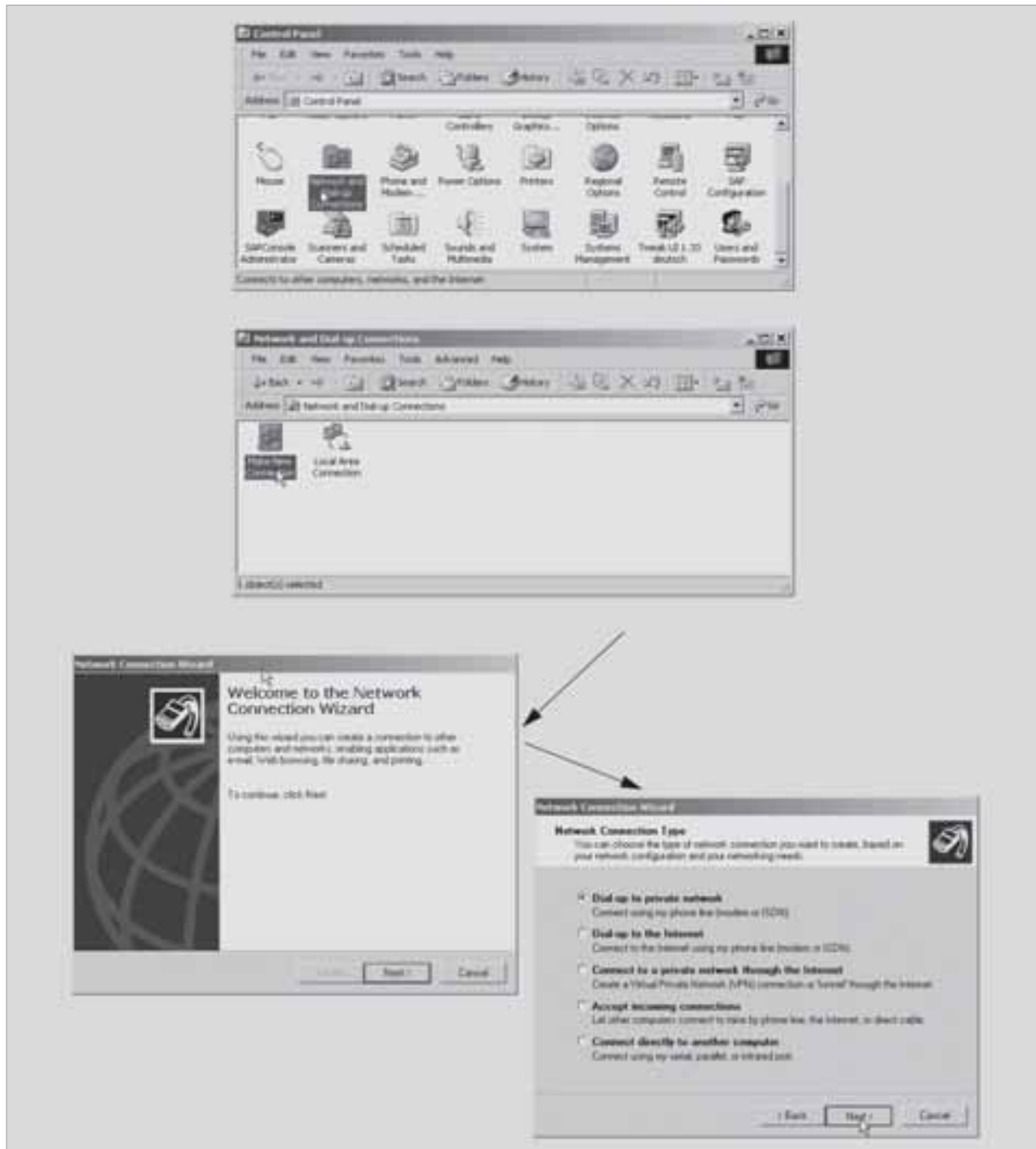

Figure 4-16 Setting a data communications connection to the BDA with Windows2000, part 1 (similar to WindowsNT):
A modem is installed for Windows2000 in the same way as for WindowsXP. You then have to set up the data communications connection to the BDA. To do so, proceed as shown in the screenshots.

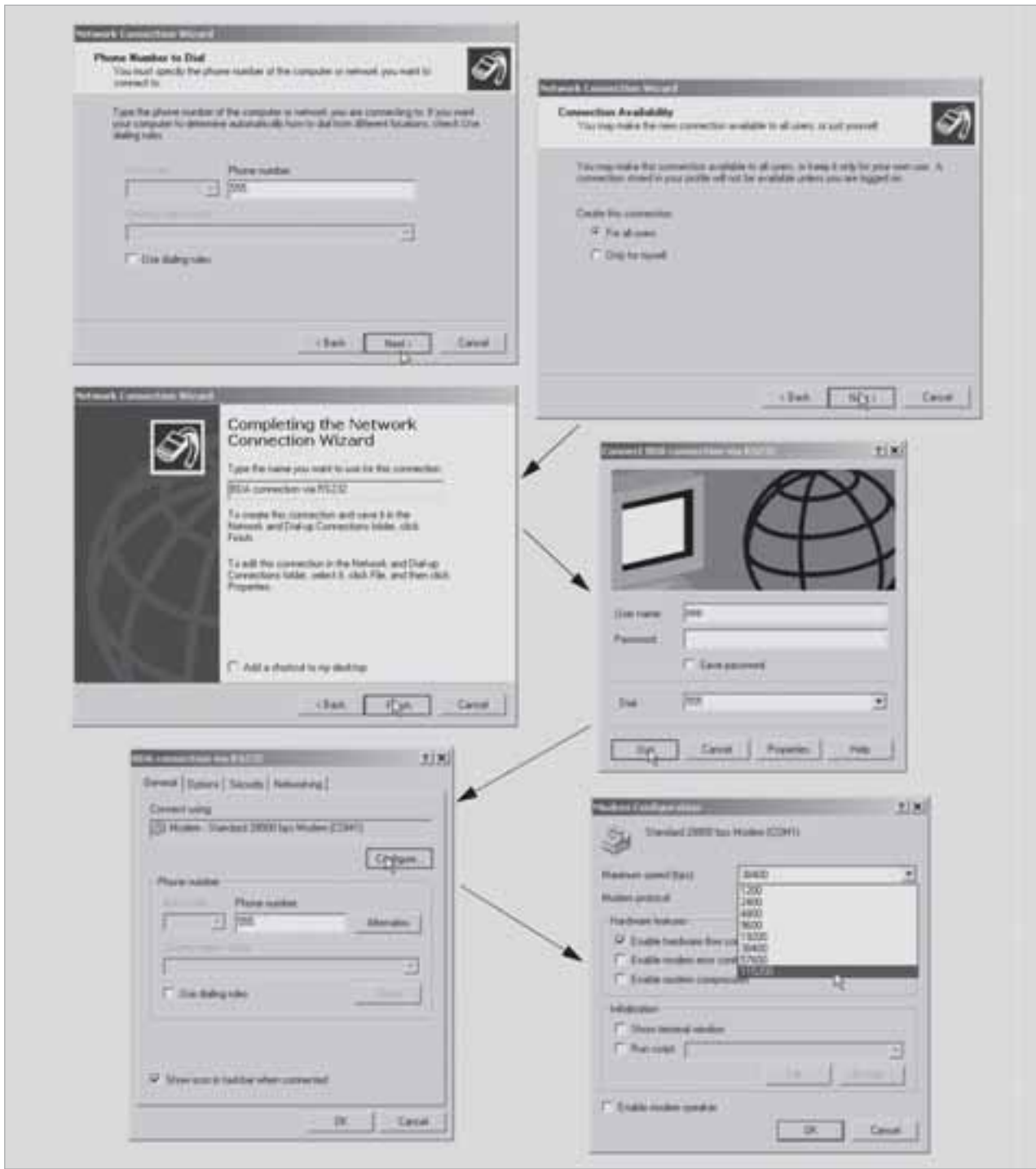

Figure 4-17 Setting up a data communications connection to the BDA with Windows2000, part 2 (similar to WindowsNT): The procedure for setting up the data communications connection for WindowsNT is largely the same as the example shown above for Windows2000.

Breaker Data Adapter (BDA)

WL Circuit Breaker

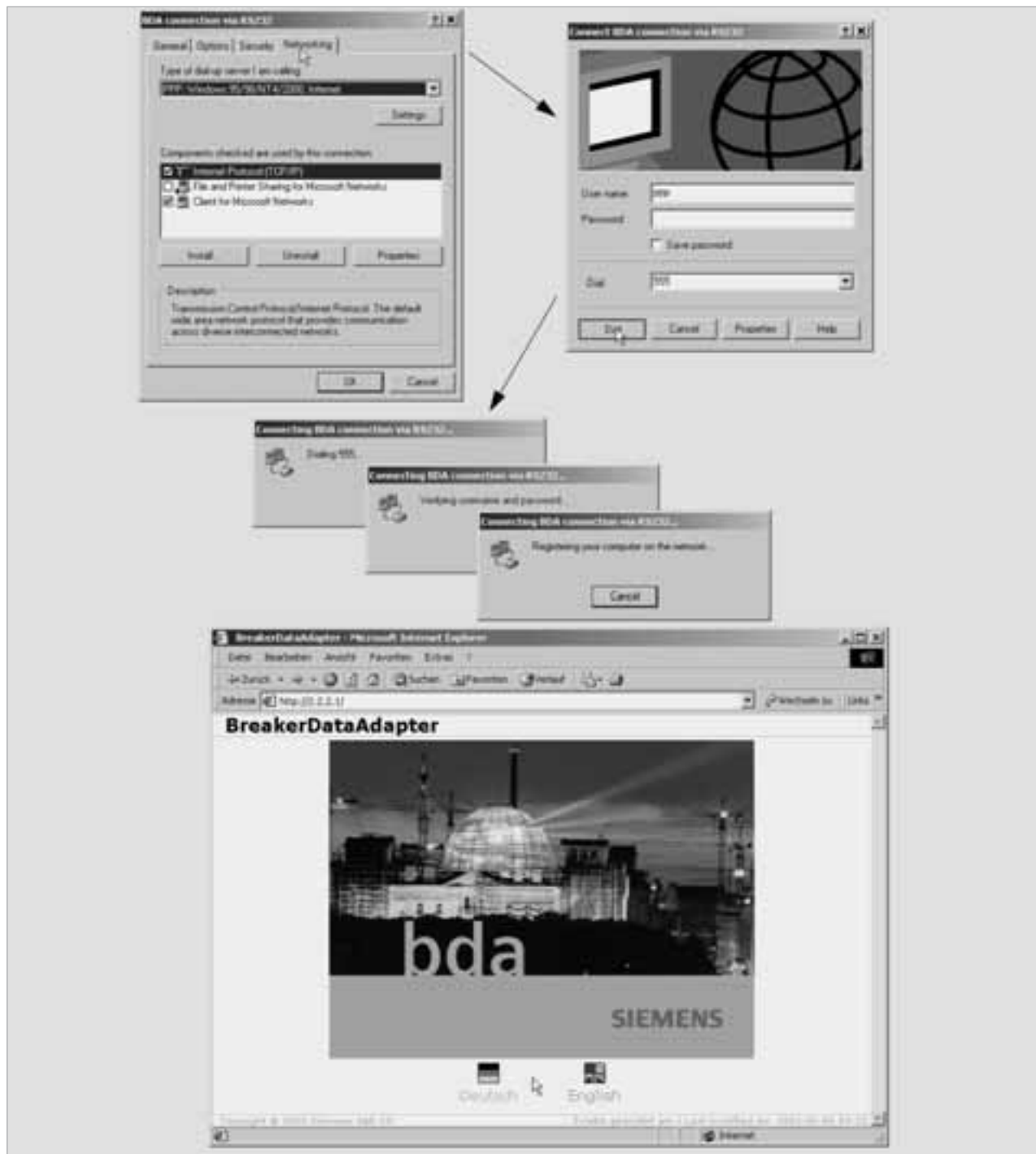

Figure 4-18 Setting up a data communications connection to the BDA with Windows2000, part 3 (similar to WindowsNT): Once the installation is complete and the connection has been established via the null modem cable, start the browser by entering the address 2.2.2.1. The PC temporarily adopts the address 2.2.2.2.

Connection to the BDA Plus via the Ethernet Interface

In addition to communication via the serial RS232 channel, the BDA Plus features an Ethernet interface. If the BDA Plus is to be addressed via this interface, it must be integrated in the local Ethernet (LAN). This chapter explains a number of key terms and settings.

Ethernet

Unlike the MODBUS, Ethernet does not function according to a master-slave principle. All the stations have equal priority on the bus, which means that any station can be the sender and/or receiver.

A sender can only send on the bus if no other station is sending at that point. This is due to the fact that the stations are always "listening in" to find out whether any messages are being sent to them or any

senders are currently active.

If a sender has started sending, it checks that the message it has sent is not corrupt. If the message is not corrupt, the send operation continues. If the sender detects that its data is corrupt, it must abort the send operation because a different sender has already started sending data.

After a random time has elapsed, the sender restarts the send operation. This is known as CSMA/CD and, because it is a "random" access procedure, does not guarantee a response within a certain time frame. This largely depends on the bus load, which means that real-time applications cannot yet be implemented with Ethernet.

Definition of Key Terms

An Intranet system is comprised of several Ethernet lines connected to each other via gateways within a company. The structure of an Intranet system can be just as

diverse as that of the Internet: it can be restricted to one location or distributed worldwide.

Ethernet/Intranet lines are connected to each other using repeaters, bridges/switches, routers and gateways. These modules work at different levels in the ISO/OSI 7-layer model.

The repeater (or star coupler) only regenerates and strengthens the electrical signal; it does not interpret bits. The bridge (or switch) physically separates the networks and performs fault and load disconnection. Filtering and guidance mechanisms are usually implemented. The router decouples the networks at the logical level (protocol level) by means of the specified addresses. Using routing tables, it knows which messages are to be sent to which address. It continues to work, however, on a protocol-dependent basis. The gateway also enables the router to convert services.

This means that it can act as a security mechanism, such as a firewall, while functioning as a proxy.

A proxy is a program in a gateway that acts as both the server and client. It processes requests, translates them if necessary, and forwards them to the addressees. Proxies are also used to control access (firewall) and forward requests for protocols that are not supported. Intranet users in particular are familiar with the Internet/Intranet page caching function offered by proxies.

The Intranet is connected to the Internet via a company proxy, which can also act as a firewall. If a PC (user) wants to access an area of the Intranet from the Internet, the firewall must be informed of which addresses can be accessed from outside.

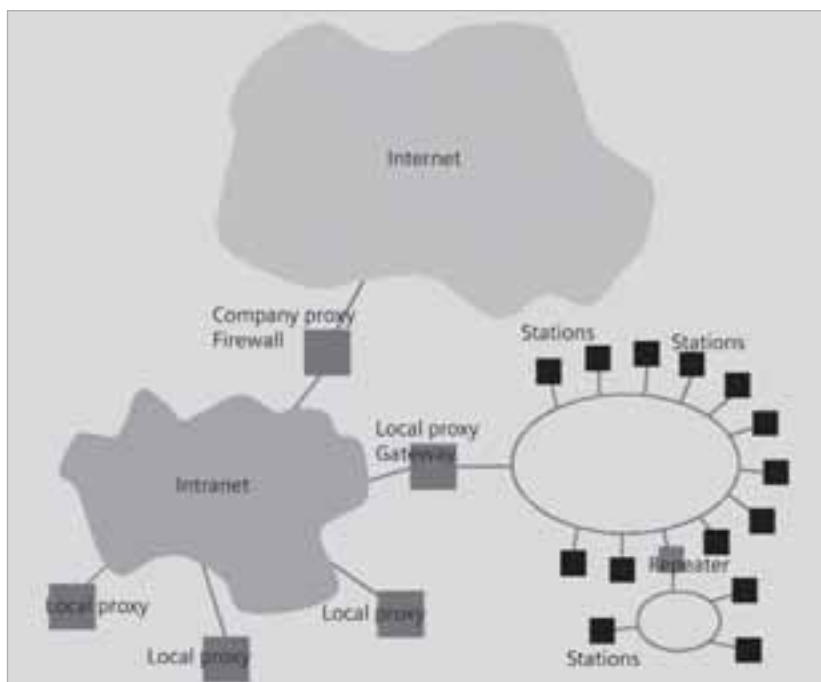

Graphic 4-5 This diagram illustrates the structure of an Ethernet, how an intranet is integrated, and how this is connected to the Internet.

Breaker Data Adapter (BDA)

WL Circuit Breaker

IP Addresses

The partner must have a unique address so that it can be addressed in the extensive Intranet/Internet system. The IP address format is used for this purpose, which, as of Version 4, comprises four figures from 0 to 255, separated by a decimal point. Example: 146.254.245.62

The address is 32 bits long. Three classes have been created to enable the addresses to be structured on a world-wide basis and to ensure that the same address does not exist twice. The IP address is comprised of a small header, which describes the class, a network number, and a host number. The address of a subnetwork (Intranet, for example) is encoded in the network number. The host number is basically the unique address of a station in a network of class X and subnetwork Y.

The first byte of class A IP addresses contains a number from 0 to 127: e.g. 98.x.x.x. This class can support up to 128 subnetworks, each with around 16 million connections. Since class A networks are very limited in number, these addresses are only available for large global companies and organizations. A Network Information Center (NIC) is responsible for assigning the classes and network numbers.

Class B networks (these begin with 128.x.x.x to 191.x.x.x) support up to 16,384 subnetworks, each with up to 65,535 stations. The majority of large companies and providers have a class B address.

With around 2.1 million subnetworks, each with up to 256 stations, class C addresses are often used by smaller providers and companies with no more than 256 connections in their corporate network. The IP addresses start from 192.x.x.x to 223.x.x.x

Subnet Mask

The subnet mask provides information on the size of the subnetwork (Intranet) and its address band. In this way, each station knows whether the IP address to be addressed is located in the same subnetwork or whether it has to be addressed via a gateway.

Example:

IP address 1st BDA: 206.150.100.89

IP address 2nd BDA:
206.150.102.32

IP address gateway: 206.150.100.1

IP address browser: 206.150.100.50

Subnet mask: 255.255.255.0

Subnet mask 255.255.255.0 means that all addresses whose first three bytes are the same as the station address are located on the line of that station. These can be addressed directly (in the example above, from the browser of the first BDA). A comparison of the address of the second BDA with the subnet mask shows that this address is not on the same line as the station. This means that the gateway must be addressed, via which the request is then forwarded to the second BDA. The subnet mask is usually 255.255.255.0.

BDA IP Address

The BDA must be assigned its own unique IP address that has not been used before so that it can run on the Ethernet. This address must be in the same range as the other addresses on this line.

Gateway IP Address

If an address that is not located in the subnetwork is addressed in the browser, the request is forwarded to the gateway. The gateway knows the location to which the request has to be forwarded on account of the configuration. The IP address of the gateway must be obtained from the network administrator.

If 0.0.0.0 is set as the gateway IP address, no access to a gateway has been configured.

Operation

Once the addresses have been set, it should be possible to call up the BDA Plus via the Ethernet. This can be checked using a test ping. To do so, enter "ping x.x.x.x" in Start > Execute (x.x.x.x is the placeholder for the IP address of the BDA to be addressed). The DOS box that then appears tells you either that a reply from the "pinged" IP address is received, or that the request has been timed out. In this case, no connection has yet been established from the BDA Plus to the target system.

Note: You may have to include the IP address of the BDA Plus in the list of addresses that do not use a proxy server. The use of a proxy server is optional and depends on the network.

Once a connection has been established, start the browser and enter the IP address of the BDA Plus in the address line.

Operating Instructions and Troubleshooting

The BDA supports state-of-the-art communications technology. It can be implemented regardless of the operating system and browser used. The instructions provided here, show you how to make particular settings. A troubleshooting table is included at the end to help you solve any problems.

Languages and Help

The BDA interface is in German and English. The language is selected every time the browser is started.

In addition to the HTML pages and Java applets, the BDA stores the accompanying help pages in different languages. The help pages can be called up where they are available via the question mark icon in the top right-hand corner of the screen. They are available whenever the BDA is activated. The help pages are available in German and English.

Offline/Online Mode

The BDA (and BDA Plus) can be run in two different operating modes.

Online mode

Online mode is activated automatically when the BDA is connected to a circuit breaker. In this mode, the current operating and diagnostic data, as well as the parameters are displayed and loaded directly to the circuit breaker after they have been changed. Online mode is indicated by a green **CubicleBUS** LED.

If the connection to the circuit breaker is interrupted, the BDA switches to offline mode. This also occurs if a file has been opened under "Parameter Transfer" or received from the circuit breaker.

Offline mode

If the BDA is supplied with 24V DC and is not connected to a circuit breaker, the BDA starts in Offline mode, indicated by the **CubicleBUS** LED not illuminated. Offline mode is used to configure the BDA even if it is not connected to a circuit breaker, and save this file for later use.

To switch from Offline to Online mode, first connect a circuit breaker. You then press either the "Online" or "Send Parameters" button in "Parameter Transfer".

Displaying Data

WL Circuit Breakers use "Property Bytes", which provide information on the required value, such as

whether it is available, or readable and/or writable. The display then changes depending on the property byte.

If a value is not available, for example, because the circuit breaker does not have any neutral conductor protection (N-conductor protection parameter), it is displayed as an empty white field with no outline.

If a value is available, the system differentiates between whether it is only readable or also writable. "Read Only" data is displayed in black on a gray background in a black, outlined field. If the value is also writable, the background is white.

Values that are available but not currently valid are displayed in red. This could be the case, for example, if the number of measured values available for calculating the long-term values of the current is insufficient because the circuit breaker has just been closed.



Figure 4-19 The way data is displayed on the BDA pages depends on the property byte. This tells you which data is read only, which data can be written, and which data is not available.

Breaker Data Adapter (BDA)

WL Circuit Breaker

Password Protection

All write actions that would result in a change to the status or a parameter in the circuit breaker are password protected. This ensures that parameters cannot be changed and switching is impossible without this password.

Note: The electronic relays of the COM16 module are required to open and close the WL via the BDA.

The default password is
"sentron"

This can be changed by choosing "Extras > Password" in the BDA tree (recommended). You have to enter the new password twice. When you click OK, the BDA asks you for the old password.

If you have forgotten it, it can be reset by means of a master password. To do so, contact Technical Assistance at 1-800-964-4114
seainfo@sea.siemens.com



Operation Example

This example describes the functionality of the BDA. If you want to set the MODBUS address of the COM16 module for a WL Circuit Breaker, open the Communication node by choosing "Device Parameters > Circuit Breaker". Then click the input/output field next to the MODBUS address and edit it with the new address. Once you have changed this parameter and exited the field, the outline turns blue to indicate parameters that have not yet been transferred to the circuit breaker.

You can then change other parameters. If you want to transfer the modified parameters to the circuit breaker, click OK on this page.

If the parameter transfer process is the first write action in this session, the system prompts you to enter the password. Once you have entered the password successfully, the data is transmitted to the circuit breaker.

If you want to reset the modified parameters, click the "Undo" button.

If you exit the parameters page without clicking OK, the changes are ignored.

Printing

Since Java applets are used, the normal print function in your browser on the parameter pages will not provide a satisfactory printout.

If you want to print the parameters for documentation purposes, open the pages to be printed from the tree in the BDA. All the parameter pages are displayed again under "Extras > Print", and you can print them individually as required using the print menu in your browser.

Comparing Parameters

The parameter comparison function is used to check whether the parameters set in WL Config or the BDA match those in the device. The following parameters are checked:

- Protection parameters A and B
- Extended protection function parameters
- Threshold value settings
- Measurement function settings
- Communication parameters
- Settings for the configurable output module

The parameter comparison function can be used, for example, to ensure that the set parameters are transferred without any errors once they have been downloaded to the device.

It is not possible to determine whether the parameters and settings loaded to the device have actually been transferred. This is because, for example:

- BDA just forwards parameter changes. Whether a parameter is correct can only be verified in the memory location (e.g. in the trip unit). If this changes the value because one has exceeded the maximum value, for example, the modified value is reported back to the BDA. This discrepancy would be detected when a subsequent parameter comparison is performed.
- In the BDA interface, not all values regarding the differences between minimum/maximum values and other parameters are checked. This means that a parameter could be entered that cannot be copied in the trip unit in its current form.

Troubleshooting List	
Fault Description	Solution
An error message appears (e.g. Modem not initialized, etc.) a PPP connection is established with the BDA.	<p>Ensure that you are using a fully-assigned null modem cable. With a null modem cable, pins 2 and 3, 4 and 6, and 7 and 8 must be assigned and reversed with respect to each other.</p> <p>Before starting the BDA, disconnect the null modem cable from the BDA and reboot the BDA (DEVICE LED is green). Then reconnect the cable.</p> <p>The COM port that you are using on the target system must not be used by a different application.</p> <p>Check the modem and data communications connection settings. You must choose "555". Only the user name "ppp" works.</p> <p>In the Control Panel, you also have to set the baud rate for the COM interface that you are using to 115200.</p>
Nothing happens after you select the language on the first page.	<p>Ensure that the option "Use Java v1.4.0 <applet>" is active in the browser.</p> <p>Delete the cache memory of the browser.</p> <p>Open the Java plug-in operator panel in the Control Panel. Check that the plug-in is active and Version 1.4.0 is selected under "Extended". On the "Browser" tab page, the browser that you are using must be active, and the Java VM cache can be deleted. Then restart the system.</p> <p>If the problem persists, remove any older versions of Java you may have.</p>
You cannot establish a connection to the BDA Plus via the Ethernet.	<p>Check the settings for the gateway, the subnet mask, and the proxy. Enter the address of the BDA to be addressed in the proxy so that it is not routed via the proxy. This only works if the BDA is located in the network specified by the subnet mask.</p> <p>Ping the BDA address to check whether TCP/IP communication is established to the BDA. If the ping does not work, check the network configuration again with your network administrator. If the BDA replies to a ping but not to a request to call up the browser, reset the BDA.</p> <p>The BDA must have already been booted with a connected Ethernet cable so that the Ethernet interface is activated. To solve the problem, connect the active Ethernet cable and boot up the BDA.</p>
The system displays a message about security settings and the BDA pages stop loading.	<p>The security level of the browser is set to "Secure" and stops Java applets from running, for example. For this reason, you have to reduce the security level to a level where the security message no longer appears and the BDA pages are displayed.</p>

Table 4-3 This troubleshooting list helps you solve any problems you may encounter communicating with the BDA. If you have any other problems, Technical Assistance at 1-800-964-4114 will be happy to help.



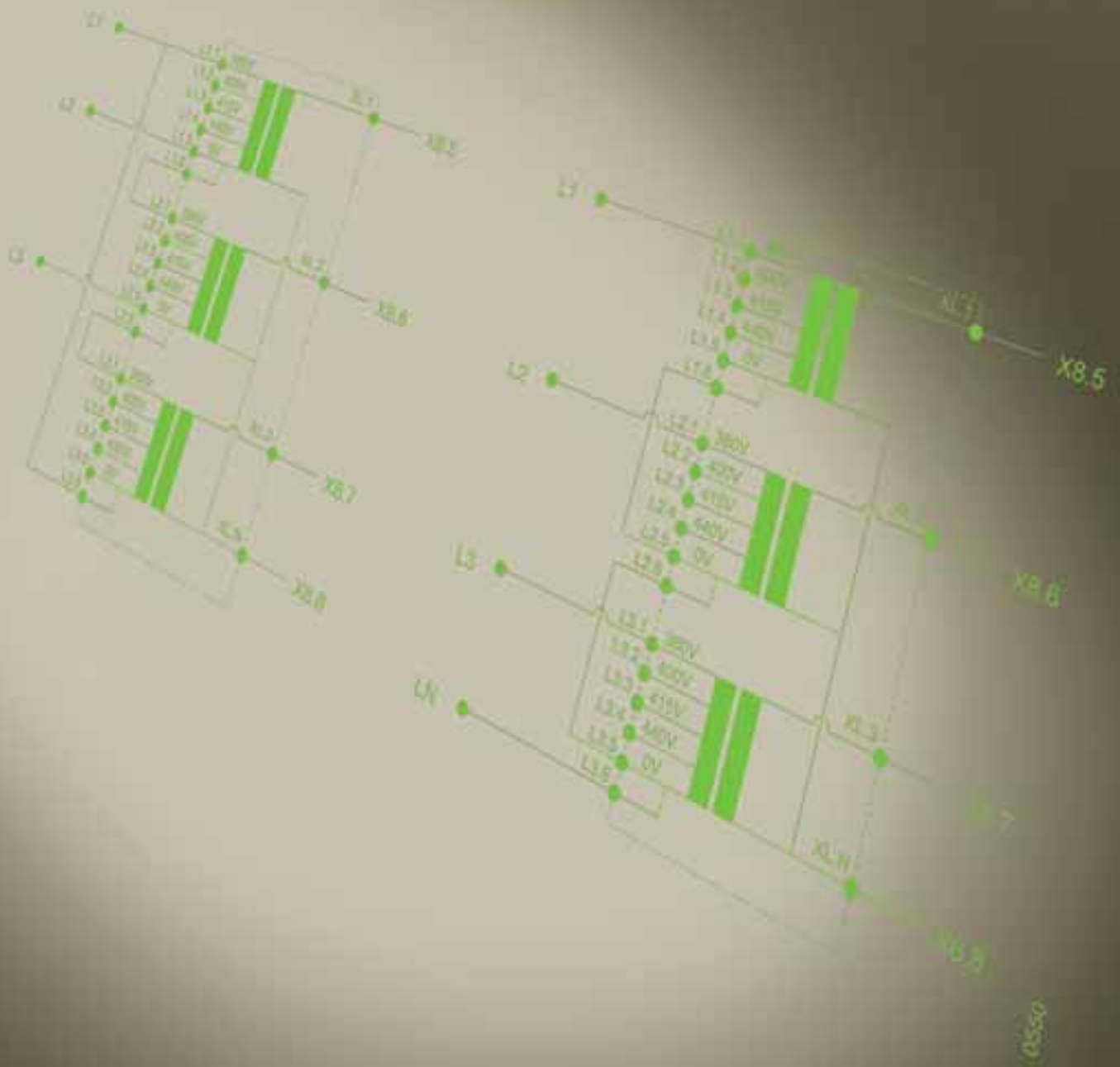

Siemens Energy & Automation, Inc.

3333 Old Milton Parkway
 Alpharetta, GA 30005

1-800-964-4114
 seainfo@sea.siemens.com

www.sea.siemens.com/power

© 2005 Siemens Energy & Automation, Inc. All Rights Reserved

Siemens is a registered trademark of Siemens AG. Product names mentioned may be trademarks or registered trademarks of their respective companies. Specifications are subject to change without notice.