

SHARP

MICRO COMPONENT SYSTEM

MODEL

XL-DK227N

OPERATION MANUAL



iPod is a registered trademark of Apple Inc.



MP3



Thank you for purchasing this SHARP product.
To obtain the best performance from this product, please read this manual carefully. It will guide you in operating your SHARP product.

XL-DK227N Micro component system consisting of XL-DK227N (main unit) and CP-DK227N (speaker system).

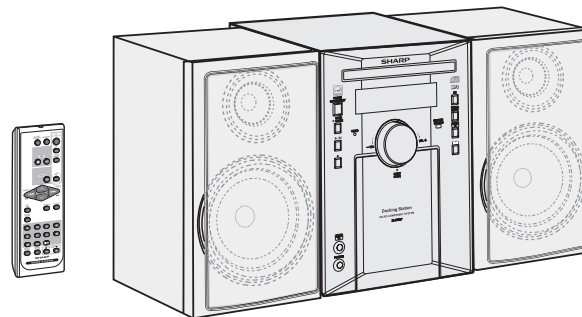

CD-R/RW
Playable 

Accessories

Please confirm that only the following accessories are included.

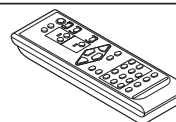

Remote control × 1
(RRMCGA152AWSA)

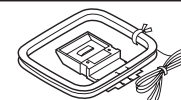

AM loop antenna × 1
(QANTL0010AWZZ)

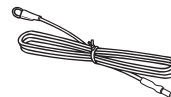

FM antenna × 1
(92LFANT1535A)



iPod® adaptor × 8
(UACRTA008AW01)

SPECIAL NOTES

Important Instruction



CAUTION

**RISK OF ELECTRIC SHOCK
DO NOT OPEN**



CAUTION: TO REDUCE THE RISK OF ELECTRIC SHOCK, DO NOT REMOVE COVER (OR BACK). NO USER-SERVICEABLE PARTS INSIDE. REFER SERVICING TO QUALIFIED SERVICE PERSONNEL.

Explanation of Graphical Symbols:



The lightning flash with arrowhead symbol, within an equilateral triangle, is intended to alert the user to the presence of uninsulated "dangerous voltage" within the product's enclosure that may be of sufficient magnitude to constitute a risk of electric shock to persons.



The exclamation point within an equilateral triangle is intended to alert the user to the presence of important operating and maintenance (servicing) instructions in the literature accompanying the appliance.

WARNING: TO REDUCE THE RISK OF FIRE OR ELECTRIC SHOCK, DO NOT EXPOSE THIS APPLIANCE TO RAIN OR MOISTURE.

This product is classified as a CLASS 1 LASER PRODUCT Caution - Use of any controls, adjustments or procedures other than those specified herein may result in hazardous radiation exposure.

Note to CATV system installer:

This reminder is provided to call the CATV system installer's attention to Article 820-40 of the National Electrical Code that provides guidelines for proper grounding and, in particular, specifies that the cable ground shall be connected to the grounding system of the building, as close to the point of cable entry as practical.

NOTE

This equipment has been tested and found to comply with the limits for a Class B digital device, pursuant to Part 15 of the FCC Rules. These limits are designed to provide reasonable protection against harmful interference in a residential installation. This equipment generates, uses, and can radiate radio frequency energy and, if not installed and used in accordance with the instructions, may cause harmful interference to radio communications. However, there is no guarantee that interference will not occur in a particular installation. If this equipment does cause harmful interference to radio or television reception, which can be determined by turning the equipment off and on, the user is encouraged to try to correct the interference by one or more of the following measures:

- Reorient or relocate the receiving antenna.
- Increase the separation between the equipment and receiver.
- Connect the equipment into an outlet on a circuit different from that to which the receiver is connected.
- Consult the dealer or an experienced radio/TV technician for help.

WARNING

FCC Regulations state that any unauthorized changes or modifications to this equipment not expressly approved by the manufacturer could void the user's authority to operate this equipment.

Note:

- Licensed under one or more of U.S. Pat. 4,972,484, 5,214,678, 5,323,396, 5,530,655, 5,539,829, 5,544,247, 5,606,618, 5,610,985, 5,740,317, 5,777,992, 5,878,080 or 5,960,037.

FOR YOUR RECORDS

For your assistance in reporting this unit in case of loss or theft, please record below the model number and serial number which are located on the rear of the unit.

Please retain this information.

Model number

Serial number

Date of purchase

Place of purchase

IMPORTANT SAFETY INSTRUCTIONS

XL-DK227N

Electricity is used to perform many useful functions, but it can also cause personal injuries and property damage if improperly handled. This product has been engineered and manufactured with the highest priority on safety. However, improper use can result in electric shock and/or fire. In order to prevent potential danger, please observe the following instructions when installing, operating and cleaning the product. To ensure your safety and prolong the service life of this product, please read the following precautions carefully before use.

- 1) Read these instructions.
- 2) Keep these instructions.
- 3) Heed all warnings.
- 4) Follow all instructions.
- 5) Do not use this apparatus near water.
- 6) Clean only with dry cloth.
- 7) Do not block any ventilation openings. Install in accordance with the manufacturer's instructions.
- 8) Do not install near any heat sources such as radiators, heat registers, stoves, or other apparatus (including amplifiers) that produce heat.
- 9) Do not defeat the safety purpose of the polarized or grounding-type plug. A polarized plug has two blades with one wider than the other. A grounding type plug has two blades and a third grounding prong. The wide blade or the third prong are provided for your safety. If the provided plug does not fit into your outlet, consult an electrician for replacement of the obsolete outlet.
- 10) Protect the power cord from being walked on or pinched particularly at plugs, convenience receptacles, and the point where they exit from the apparatus.
- 11) Only use attachments/accessories specified by the manufacturer.
- 12) Use only with the cart, stand, tripod, bracket, or table specified by the manufacturer, or sold with the apparatus. When a cart is used, use caution when moving the cart/apparatus combination to avoid injury from tip-over.
- 13) Unplug this apparatus during lightning storms or when unused for long periods of time.
- 14) Refer all servicing to qualified service personnel. Servicing is required when the apparatus has been damaged in any way, such as power-supply cord or plug is damaged, liquid has been spilled or objects have fallen into the apparatus, the apparatus has been exposed to rain or moisture, does not operate normally, or has been dropped.
- 15) Power Sources - This product should be operated only from the type of power source indicated on the marking label. If you are not sure of the type of power supply to your home, consult your product dealer or local power company. For product intended to operate from battery power, or other sources, refer to the operating instructions.
- 16) Overloading - Do not overload wall outlets, extension cords, or integral convenience receptacles as this can result in a risk of fire or electric shock.
- 17) Object and Liquid Entry - Never push objects of any kind into this product through openings as they may touch dangerous voltage points or short-out parts that could result in a fire or electric shock. Never spill liquid of any kind on the product.



Additional Safety Information

IMPORTANT SAFETY INSTRUCTIONS (continued)

- 18) **Damage Requiring Service** - Unplug this product from the wall outlet and refer servicing to qualified service personnel under the following conditions :
- When the AC cord or plug is damaged,
 - If liquid has been spilled, or objects have fallen into the product,
 - If the product has been exposed to rain or water,
 - If the product does not operate normally by following the operating instructions. Adjust only those controls that are covered by the operating instructions as an improper adjustment of other controls may result in damage and will often require extensive work by a qualified technician to restore the product to its normal operation,
 - If the product has been dropped or damaged in any way, and
 - When the product exhibits a distinct change in performance - this indicates a need for service.
- 19) **Replacement Parts** - When replacement parts are required, be sure the service technician has used replacement parts specified by the manufacturer or have the same characteristics as the original part. Unauthorized substitutions may result in fire, electric shock, or other hazards.
- 20) **Safety Check** - Upon completion of any service or repairs to this product, ask the service technician to perform safety checks to determine that the product is in proper operating condition.
- 21) **Wall or ceiling mounting** - When mounting the product on a wall or ceiling, be sure to install the product according to the method recommended by the manufacturer.
- 22) **Power Lines** - An outside antenna system should not be located in the vicinity of overhead power lines or other electric light or power circuits, or where it can fall into such power lines or circuits. When installing an outside antenna system, extreme care should be taken to keep from touching such power lines or circuits as contact with them might be fatal.

- 23) **Outdoor Antenna Grounding** - If an outside antenna or cable system is connected to the product, be sure the antenna or cable system is grounded so as to provide some protection against voltage surges and built-up static charges. Article 810 of the National Electrical Code, ANSI/NFPA 70, provides information with regards to proper grounding of the mast and supporting structure, grounding of the lead-in wire to an antenna discharge unit, connection to grounding electrodes, and requirements for the grounding electrode.

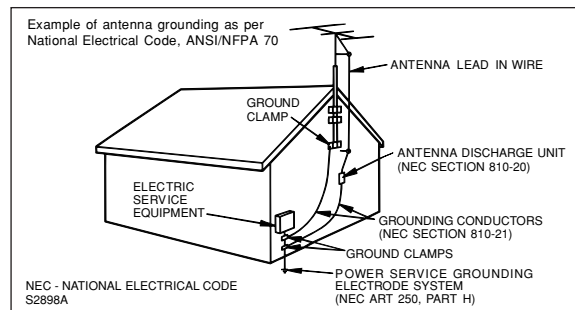

- 24) **Protective Attachment Plug** - The product is equipped with an attachment plug having overload protection. This is a safety feature. See Instruction Manual for replacement or resetting of protective device. If replacement of the plug is required, be sure the service technician has used a replacement plug specified by the manufacturer that has the same overload protection as the original plug.
- 25) **Stand** - Do not place the product on an unstable cart, stand, tripod or table. Placing the product on an unstable base can cause the product to fall, resulting in serious personal injuries as well as damage to the product. Use only a cart, stand, tripod, bracket or table recommended by the manufacturer or sold with the product. When mounting the product on a wall, be sure to follow the manufacturer's instructions. Use only the mounting hardware recommended by the manufacturer.

Contents

Page

- **General Information**
 - Precautions 6
 - Controls and indicators 7 - 9
- **Preparation for Use**
 - System connections 10 - 12
 - Remote control 13
- **Basic Operation**
 - General control 14
 - Setting the clock (Remote Control only) 15
- **iPod**
 - Listening to the iPod 16 - 19
- **CD or MP3/WMA disc Playback**
 - Listening to a CD or MP3/WMA disc 19 - 21
 - Advanced CD or MP3/WMA disc playback 21 - 23
 - MP3/WMA folder mode (only for MP3/WMA files) 24 - 25
- **Radio**
 - Listening to the radio 26 - 27
- **Advanced Features**
 - Timer and sleep operation (Remote Control only) 28 - 31
 - Enhancing your system 31 - 32
- **References**
 - Troubleshooting chart 33 - 34
 - Maintenance 34
 - Specifications 35
- CONSUMER LIMITED WARRANTY** Back cover

ENERGY STAR® Program Information



Products that have earned the ENERGY STAR® are designed to protect the environment through superior energy efficiency.

To comply with the ENERGY STAR® standards mentioned above, please cancel the demonstration mode, as described on page 12.

ENERGY STAR® is a U.S. registered mark.

Special Note

Supply of this product does not convey a license nor imply any right to distribute content created with this product in revenue-generating broadcast systems (terrestrial, satellite, cable and/or other distribution channels), revenue-generating streaming applications (via Internet, intranets and/or other networks), other revenue-generating content distribution systems (pay-audio or audio-on-demand applications and the like) or on revenue-generating physical media (compact discs, digital versatile discs, semiconductor chips, hard drives, memory cards and the like). An independent license for such use is required. For details, please visit <http://mp3licensing.com>
 MPEG Layer-3 audio coding technology licensed from Fraunhofer IIS and Thomson.

Precautions

■ General

- Please ensure that the equipment is positioned in a well-ventilated area and ensure that there is at least 4" (10 cm) of free space along the sides, top and back of the equipment.

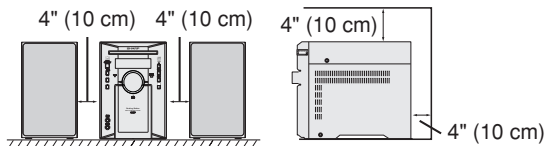

- Use the unit on a firm, level surface free from vibration.

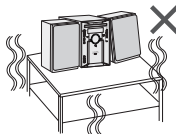

- Keep the unit away from direct sunlight, strong magnetic fields, excessive dust, humidity and electronic/electrical equipment (home computers, facsimiles, etc.) which generate electrical noise.

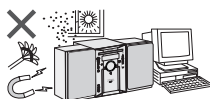

- Do not place anything on top of the unit.
- Do not expose the unit to moisture, to temperatures higher than 140°F (60°C) or to extremely low temperatures.
- If your system does not work properly, disconnect the AC power cord from the AC outlet. Plug the AC power cord back in, and then turn on your system.
- In case of an electrical storm, unplug the unit for safety.

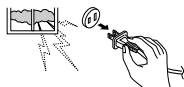

- Hold the AC power plug by the head when removing it from the AC outlet, as pulling the cord can damage internal wires.
- The AC power plug is used as a disconnect device and shall always remain readily operable.

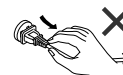

- Do not remove the outer cover, as this may result in electric shock. Refer service to your local SHARP service facility.

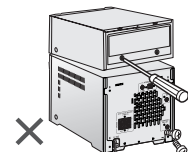

- This unit should only be used within the range of 41°F - 95°F (5°C - 35°C).

Warning:

The voltage used must be the same as that specified on this unit. Using this product with a higher voltage other than that which is specified is dangerous and may result in a fire or other type of accident causing damage. SHARP will not be held responsible for any damage resulting from use of this unit with a voltage other than that which is specified.

■ Volume control

The sound level at a given volume setting depends on speaker efficiency, location and various other factors. It is advisable to avoid exposure to high volume levels, which occurs while turning the unit on with the volume control setting up high, or while continually listening at high volumes. Excessive sound pressure from earphones and headphones can cause hearing loss.

Controls and indicators

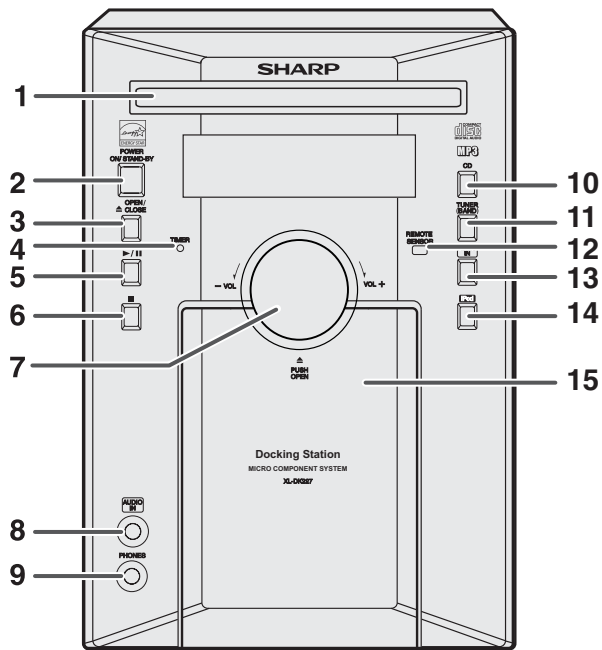

■ Front panel

	Reference page
1. Disc Tray	20
2. Power On/Stand-by Button	14, 15, 20, 26, 28
3. Disc Tray Open/Close Button	20
4. Timer Indicator	29
5. Disc or iPod Play or Pause Button	19, 21
6. Disc Stop Button	21
7. Volume Control	14
8. Audio In Jack	31
9. Phones Jack	31
10. CD Button	20
11. Tuner (Band) Button	26
12. Remote sensor	13
13. Audio In Button	32
14. iPod Button	16
15. iPod Docking Station	17

Controls and indicators (continued)

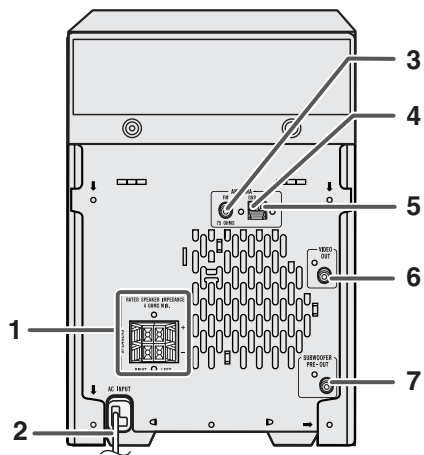
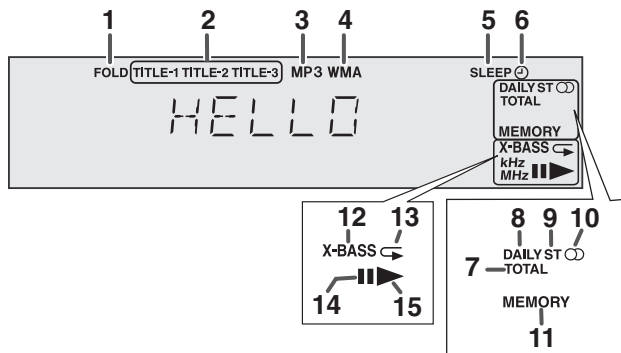

■ Display

Reference page

1. MP3/WMA Folder Indicator	25
2. MP3/WMA Title Indicators	25
3. MP3 Indicator	20
4. WMA Indicator	20
5. Sleep Indicator	30
6. Timer Play Indicator	29
7. MP3/WMA Total Indicator	25
8. Daily Timer Indicator	29
9. FM Stereo Mode Indicator	26
10. FM Stereo Receiving Indicator	26
11. Memory Indicator	23
12. Extra Bass Indicator	14
13. Disc Repeat Play Indicator	22
14. Disc Pause Indicator	21
15. Disc Play Indicator	20

■ Rear panel

Reference page

1. Speaker Terminals	11
2. AC Power Cord	12
3. FM 75 Ohms Antenna Jack	11
4. AM Antenna Ground Terminal	11
5. AM Loop Antenna Terminal	11
6. Video Out Jack	11, 31
7. Subwoofer Pre-output Jack	32

■ Speaker system

1. Tweeter
2. Woofer
3. Bass Reflex Duct
4. Speaker Wire

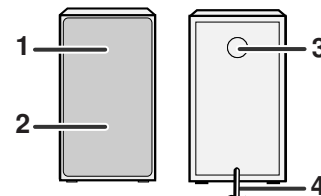

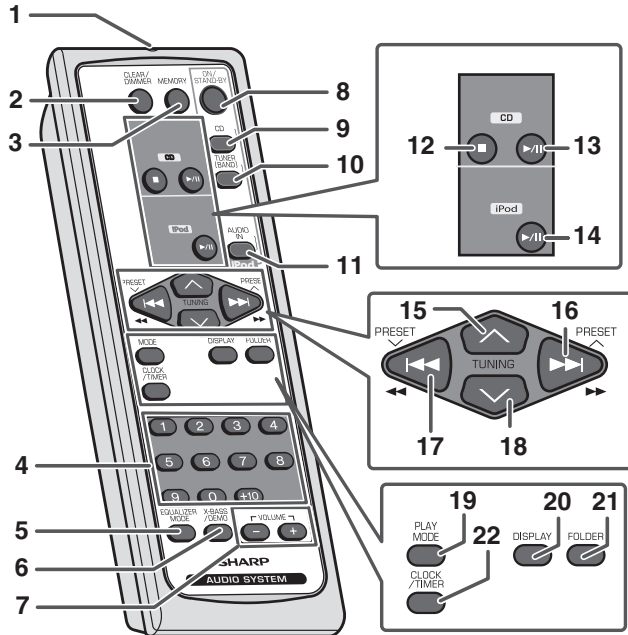

■ Remote control

	Reference page
1. Remote Control Transmitter	13
2. Disc Clear/Dimmer, iPod Menu Button	19, 23
3. Memory, iPod Enter Button	15, 19, 23, 27, 31
4. Disc Direct Search Buttons	21
5. Equalizer Mode Select Button	14
6. Extra Bass/Demo Button	14
7. Volume Up and Down Buttons	14
8. Power On/Stand-by Button	14
9. CD Button	20
10. Tuner (Band) Button	26
11. Audio In/iPod Button	16, 32
12. Disc Stop Button	21
13. Disc Play or Pause Button	20, 22
14. iPod Play or Pause Button	16, 17, 19
15. Tuning Up, Select iPod Menu Items Button	19, 26
16. CD Track Up or Fast Forward, Tuner Preset Up, Time Up Button	15, 19, 21, 27, 28, 31
17. CD Track Down or Fast Reverse, Tuner Preset Down, Time Down Button	15, 19, 21, 27, 28, 31
18. Tuning Down, Select iPod Menu Items Button	19, 26
19. Play Mode Button	22
20. Display Button	19, 25
21. Folder Button	24
22. Clock/Timer Button	15, 28, 31

System connections

Preparation for Use

Make sure to unplug the AC power cord before making any connections.

■ Antenna connection (see page 11)

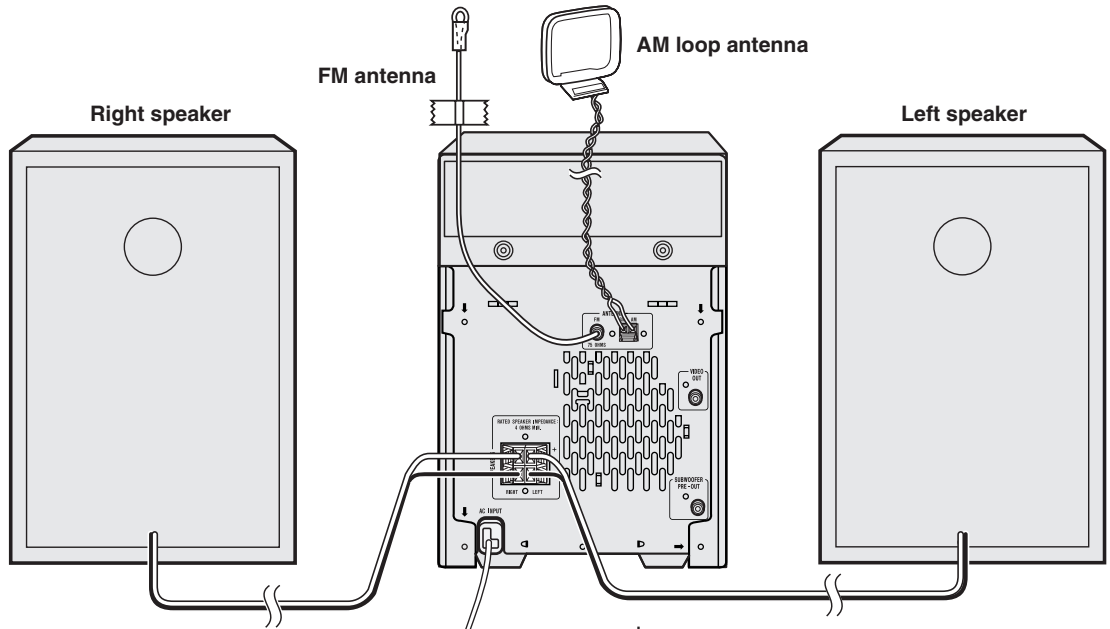

■ Speaker connection (see page 11)



■ AC power connection (see page 12)

■ Antenna connection

Supplied FM antenna:

Connect the FM antenna wire to the FM 75 OHMS jack and position the FM antenna wire in the direction where the strongest signal can be received.

Supplied AM loop antenna:

Connect the AM loop antenna to the AM and GND terminals. Position the AM loop antenna for optimum reception. Place the AM loop antenna on a shelf, etc., or attach it to a stand or a wall with screws (not supplied).

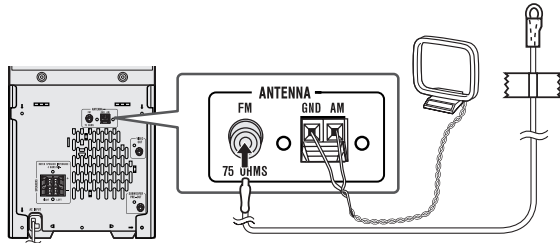

Note:

Placing the antenna on the unit or near the AC power cord may cause noise pickup. Place the antenna away from the unit for better reception.

Installing the AM loop antenna:

< Assembling >

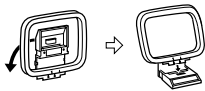

< Attaching to the wall >



■ Speaker connection

Connect the black wire to the minus (-) terminal, and the red wire to the plus (+) terminal.

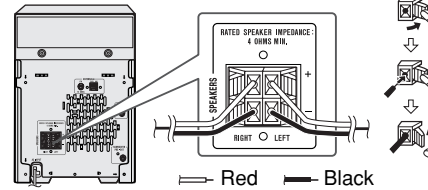

Caution:

- Use speakers with an impedance of 4 ohms or more, as lower impedance speakers can damage the unit.
- Do not mistake the right and the left channels. The right speaker is the one on the right side when you face the unit.
- **Do not let the bare speaker wires touch each other.**
- Do not allow any objects to fall into or to be placed in the bass reflex ducts.
- Do not stand or sit on the speakers. You may be injured.

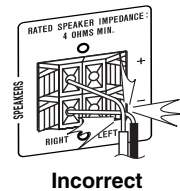

■ Connecting iPod to a TV

The iPod with photo and video can be viewed by connecting to a TV/monitor. If the TV/monitor has a video input, connect it to the VIDEO OUT jack on the rear of the unit.

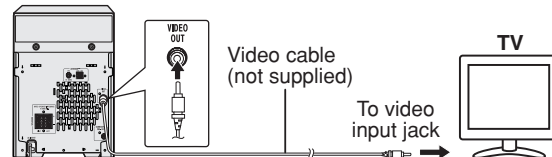

Note:

Please make sure to set iPod unit to either NTSC or PAL to match your TV signal. Please visit Apple's home page for further information.

System connections (continued)

■ AC power connection

After checking all the connections have been made correctly, plug the AC power cord of this unit into the AC outlet. If you plug in the unit first, the unit will enter the demonstration mode.

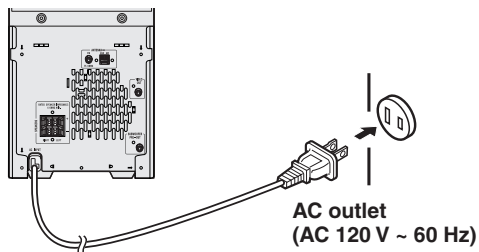

Note:

Unplug the AC power cord from the AC outlet if the unit will not be in use for a prolonged period of time.

■ Demonstration mode

The first time the unit is plugged in, the unit will enter the demonstration mode. You will see words scroll.

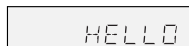

To cancel the demonstration mode:

When the unit is in the power stand-by mode (demonstration mode), press the X-BASS/DEMO button. The unit will enter the low power consumption mode.

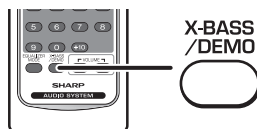

To return to the demonstration mode:

When the unit is in the power stand-by mode, press the X-BASS/DEMO button again.

Note:

When the power is on, the X-BASS/DEMO button can be used to select the extra bass mode.

■ Outdoor FM antenna

Use an outdoor FM antenna if you require better reception. Consult your dealer.

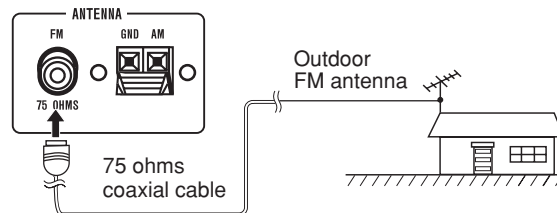

Note:

When an outdoor FM antenna is used, disconnect the supplied FM antenna wire.

Remote control

■ Battery installation

Use 2 “AA” size batteries (UM/SUM-3, R6, HP-7 or similar).

Batteries are not included.

- 1 **Open the battery cover.**
- 2 **Insert the batteries according to the direction indicated in the battery compartment.**
When inserting or removing the batteries, push them toward the ⊖ battery terminals.
- 3 **Close the cover.**

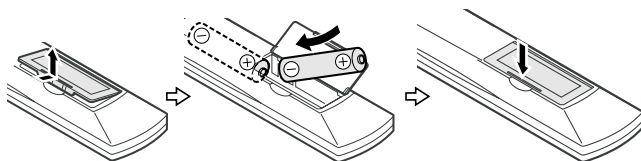

Precautions for battery use:

- Replace all old batteries with new ones at the same time.
- Do not mix old and new batteries.
- Remove the batteries if the unit will not be used for long periods of time. This will prevent potential damage due to battery leakage.

Caution:

- Do not use rechargeable batteries (nickel-cadmium battery, etc.).
- Installing the batteries incorrectly may cause the unit to malfunction.
- Batteries (battery pack or batteries installed) shall not be exposed to excessive heat such as sunshine, fire or the like.

Battery removal:

Open the battery cover and pull up the battery to take out.

Notes concerning use:

- Replace the batteries if the operating distance is reduced or if the operation becomes erratic.
- Periodically clean the transmitter on the remote control and the sensor on the unit with a soft cloth.
- Exposing the sensor on the unit to strong light may interfere with operation. Change the lighting or the direction of the unit if this occurs.
- Keep the remote control away from moisture, heat, shock, and vibrations.

■ Test of the remote control

Check the remote control after checking all the connections (see pages 10 - 12).

Point the remote control directly at the remote sensor on the unit.

The remote control can be used within the range shown below: Press the ON/STAND-BY button. Does the power turn on? Now, you can enjoy the music.

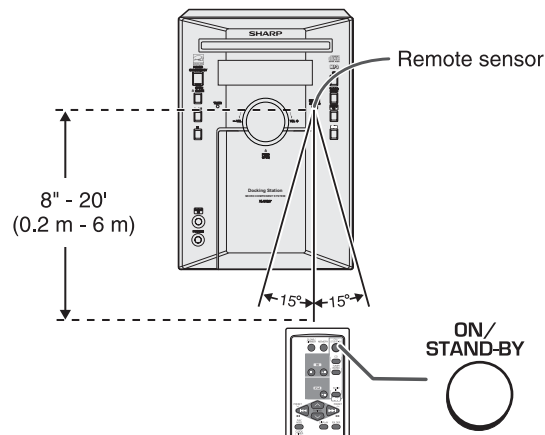

General control

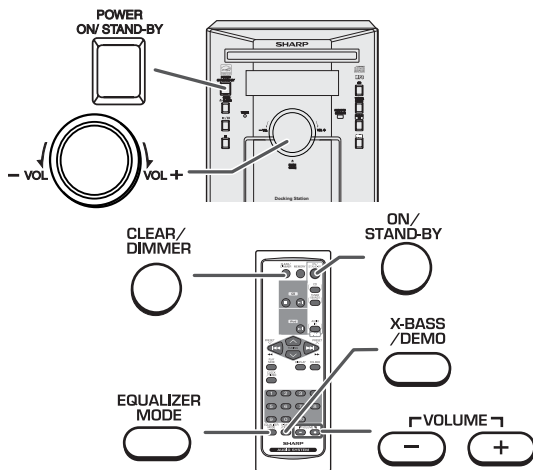

■ To turn the power on

Press the ON/STAND-BY button to turn the power on.

After use:

Press the ON/STAND-BY button to enter the power stand-by mode.

■ Illumination light control

When the unit's power is turned on, the ring around the volume control lights up. To turn on/off the light, hold down the CLEAR/DIMMER button on the remote control for more than 2 seconds.

■ Volume auto fade-in

If you turn off and on the main unit with the volume set to 27 or higher, the volume starts at 16 and fades in to the last set level.

■ Volume control

Main unit operation:

When the VOLUME control is turned clockwise, the volume will increase. When it is turned counterclockwise, the volume will decrease.

Remote control operation:

Press the VOLUME (+ or -) button to increase or decrease the volume.



■ Bass control

When the power is first turned on, the unit will enter the extra bass mode which emphasizes the bass frequencies, and "X-BASS" will appear. To cancel the extra bass mode, press the X-BASS button on the remote control.

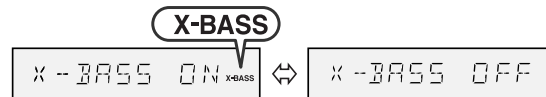

■ Equalizer

When the EQUALIZER MODE button is pressed, the current mode setting will be displayed. To change to a different mode, press the EQUALIZER MODE button repeatedly until the desired sound mode appears.

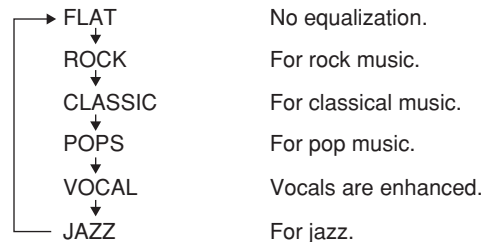

Setting the clock (Remote Control only)

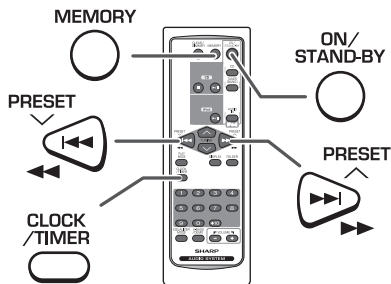

In this example, the clock is set for the 12-hour (AM 12:00) display.

<p>1 Press the ON/STAND-BY button to turn the power on.</p>										
<p>2 Press the CLOCK/TIMER button.</p>										
<p>3 Within 10 seconds, press the \lll or \ggg button to select "CLOCK", and press the MEMORY button.</p> <div style="text-align: center; margin: 10px 0;"> </div>										
<p>4 Press the \lll or \ggg button to select 12-hour or 24-hour display and then press the MEMORY button.</p> <div style="text-align: center; margin: 10px 0;"> </div> <table style="width: 100%; border-collapse: collapse;"> <tr> <td style="width: 15%; padding: 5px;">"AM 12:00" →</td> <td style="padding: 5px;">The 12-hour display will appear. (AM 12:00 - PM 11:59)</td> </tr> <tr> <td style="text-align: center; padding: 5px;">↓</td> <td></td> </tr> <tr> <td style="padding: 5px;">"AM 0:00" →</td> <td style="padding: 5px;">The 12-hour display will appear. (AM 0:00 - PM 11:59)</td> </tr> <tr> <td style="text-align: center; padding: 5px;">↓</td> <td></td> </tr> <tr> <td style="padding: 5px;">"0:00" →</td> <td style="padding: 5px;">The 24-hour display will appear. (0:00 - 23:59)</td> </tr> </table>	"AM 12:00" →	The 12-hour display will appear. (AM 12:00 - PM 11:59)	↓		"AM 0:00" →	The 12-hour display will appear. (AM 0:00 - PM 11:59)	↓		"0:00" →	The 24-hour display will appear. (0:00 - 23:59)
"AM 12:00" →	The 12-hour display will appear. (AM 12:00 - PM 11:59)									
↓										
"AM 0:00" →	The 12-hour display will appear. (AM 0:00 - PM 11:59)									
↓										
"0:00" →	The 24-hour display will appear. (0:00 - 23:59)									

5 Press the \lll or \ggg button to adjust the hour and then press the MEMORY button.



Press the \lll or \ggg button once to advance the time by 1 hour. Hold it down to advance continuously.

6 Press the \lll or \ggg button to adjust the minutes and then press the MEMORY button.



Press the \lll or \ggg button once to advance the time by 1 minute. Hold it down to change the time in 5-minute intervals.

To confirm the time display:

[When the unit is in the stand-by mode]

Press the CLOCK/TIMER button.

The time display will appear for about 10 seconds.

[When the power is on]

Press the CLOCK/TIMER button.

Within 10 seconds, press the \lll or \ggg button to display the time.

The time display will appear for about 10 seconds.

Note:

The "CLOCK" will appear or time will flash to confirm the time display when the AC power supply is restored after a power failure or unplugging the unit. If incorrect, readjust the clock as follows.

To readjust the clock:

Perform "Setting the clock" from step 1. If the "CLOCK" does not appear in step 3, step 4 (for selecting the 12-hour or 24-hour display) will be skipped.

To change the 12-hour or 24-hour display:

- 1 Clear all the programmed contents. [Refer to "Factory reset, clearing all memory" on page 34 for details.]
- 2 Perform "Setting the clock" from step 1 onwards.

Listening to the iPod

Supported iPod models:

- iPod nano (software 1.2 above)
- iPod mini (software 1.2 above)
- 5th Generation iPod (software 1.2 above) (Dock connector equipped Click Wheel model)
- 4th Generation iPod (software 3.0.2 above) (Dock connector equipped Click Wheel model)
- iPod nano 2G (software 1.0.0 above)
- iPod nano 3G (software 1.0.3 above)
- iPod classic (software 1.0.3 above)
- iPod touch (software 1.1 above)

Caution:

- Please update your iPod unit to the latest software version before using it. Please visit Apple's homepage to download the latest version for your iPod.

Notes:

- Once the iPod is connected to the unit it will begin charging.
- The iPod unit cannot be charged while the main unit is in the stand-by mode.

Auto power on function:

When you press any of the following buttons, the unit turns on.

- iPod button: The unit turns on and the iPod function is activated.
- iPod ► / || button on the remote control: The unit turns on and the iPod playback start (regardless of the last function).
- ► / || button on the main unit: The unit turns on and playback of the last function will start (iPod, CD, TUNER, AUDIO IN).

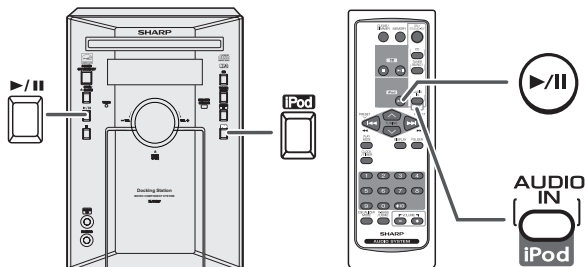

■ iPod adaptor connection

Choose the iPod adaptor that fits your iPod. Your iPod will fit snugly into the correct adaptor. If your iPod is not mentioned below, an iPod adaptor may have been included with your iPod unit.

The number (3-10) shows which iPod fits



iPod Adaptor No.	iPod Description	Capacity
3	iPod mini	4GB & 6GB
4	4G iPod & U2 iPod	20GB
5	4G iPod	40GB
6	iPod photo & Color U2 iPod	20GB & 30GB
7	iPod photo	40GB & 60GB
6	iPod with color display	20GB
7	iPod with color display	60GB
8	iPod nano	2GB & 4GB
9	5G iPod & U2 iPod with video	30GB
10	5G iPod with video	60GB & 80GB

Notes:

- iPod nano 2G, iPod nano 3G, iPod classic and iPod touch are not compatible with the iPod adaptors listed above. Please use the adaptor supplied with your iPod unit.
- If you have an iPod that does not have an iPod 30 Pin connector, you can use an audio cable to connect it to the AUDIO IN jack.

■ To insert iPod adaptor

1. Press the ON/STAND-BY button to turn the power on.
2. Open the iPod docking station by pushing the area marked "▲ PUSH OPEN".

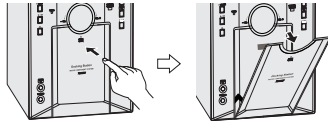

3. Insert the iPod adaptor into the ipod dock and connect your iPod.

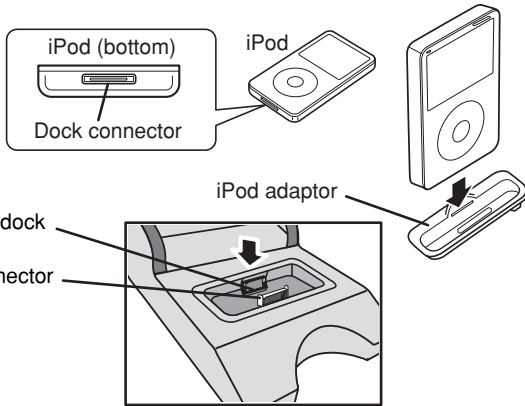

Caution:

Do not place the iPod docking base without any support from below when inserting the iPod unit, otherwise it may damage the iPod docking station.

■ To remove iPod unit

Press and hold the iPod docking base when removing the iPod unit.

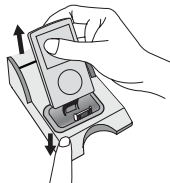

■ To remove iPod adaptor

1. Adaptor with tip.
Hold this tip and pull as direction shown to remove adaptor

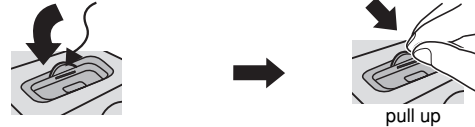

2. Adaptor without tip.
Insert the tip of a screwdriver ("—" type, small) into the iPod adaptor hole as shown and lift upward to remove)

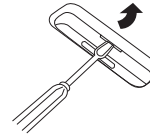

■ iPod playback

- 1 Press the ON/STAND-BY button to turn the power on.
- 2 Press the iPod button to select iPod function.
- 3 Insert iPod unit in iPod dock of main unit. "DOCK OK" will be displayed for 3 seconds except for iPod mini and 4th Generation iPod.

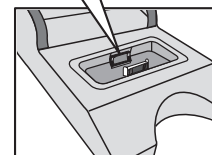
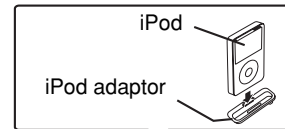

- 4 Press the ► / || button to start playback.

Listening to the iPod (continued)

■ To disconnect iPod

Simply remove the iPod from the iPod dock. It is safe to do so even during playback.

■ Navigating the iPod menus with the remote control

1 Press the CLEAR/DIMMER button to view the menu on iPod unit. Press it again to go back to previous menu.

2 Use the TUNING (∨ or ∧) button to select an item on the menu and then press MEMORY button.

Notes:

- When navigating the iPod menus with remote control, do not operate any of the buttons on the iPod unit.
- The volume level is adjusted by pressing the VOL (+ or -) button on the main unit or the remote control. Adjusting the volume on the iPod unit gives no effect.

■ Watching videos on a TV connected to iPod

1 Press the DISPLAY button for more than 2 seconds. "TV DISP" will appear on display.

2 Select the desired video from iPod unit to be played.

3 Press the MEMORY button to start playback.

Notes:

- If the TV Out setting is already turned on at video menu, the video is automatically displayed on the TV screen when MEMORY key is pressed.
- To return to watching video on iPod screen, press the CLEAR button to enter video menu. Then press the DISPLAY button for more than 2 seconds until "iPod DISP" appears. Repeat steps 2 and 3.
- During iPod video playback, pressing the DISPLAY button will not toggle video out display between iPod and TV.

iPod operation

The operations described below depend on the generation iPod you are using.

System on operation

When the main unit is powered on, the iPod unit will automatically power on when docked in the unit (including TIMER function).

System off (stand-by operation)

When the main unit is turned to stand-by mode, the docked iPod unit will automatically turn to stand-by mode.













iPod playback detection function

Once the play button on the iPod unit is pressed, the main unit will automatically change to iPod function overriding the previous function selected.

Caution:

- Unplug all accessories for the iPod before inserting it into the iPod dock.
- Stop button (■) at main unit is invalid during iPod function.

■ Various iPod functions

Function	Main unit	Remote control	Operation
Play			Press in the pause mode.
Pause			Press in the playback mode.
Track up/down	—		Press in the playback or pause mode. If you press the button in the pause mode, press the ► / button to start the desired track.
Fast forward/reverse	—		Press and hold down in the playback mode. Release the button to resume playback.
Display	—		iPod back light ON. Press for more than 2 seconds to toggle the video out display between iPod or TV.
Repeat	—		Press to toggle repeat mode.
Shuffle	—		Press and hold down to toggle shuffle mode.
iPod Menu	—		Press to view the iPod menu during iPod function.
iPod Enter	—		Press to confirm the selection.
iPod Cursor Up/Down	—		Press to select the iPod menu.

Listening to a CD or MP3/WMA disc

This system can play back a standard CD, CD-R/RW in the CD format and CD-R/RW with MP3 or WMA files, but cannot record on them. Some audio CD-R and CD-RW discs may not be playable due to the state of the disc or the device that was used for recording.

MP3:

MP3 is a form of compression. It is an acronym which stands for MPEG Audio Layer 3.

MP3 is a type of audio code which is processed by significant compression from the original audio source with very little loss in sound quality.

- This system supports MPEG 1 Layer 3, MPEG 2 Layer 3, and VBR files.
- During VBR file playback, time counter in the display may differ from its actual playback time.
- Bitrate which is supported by MP3 is 32 ~ 320 kbps.

WMA:

WMA files are Advanced System Format files that include audio files which are compressed with Windows Media Audio codec. WMA is developed by Microsoft as an audio format file for Windows Media Player.

- “MP3” and “WMA” indicator will light up after the unit reads information on an MP3 or WMA disc.
- Bitrate which is supported by WMA is 64 ~ 160 kbps.

Auto power on function:

When you press any of the following buttons, the unit turns on.

- CD button (main unit and remote control): The unit turns on and the “CD” function is activated.
- CD ► / || button on the remote control: The unit turns on and CD playback starts (regardless of the last function).
- ► / || button on the main unit: The unit turns on and playback of the last function starts (CD, TUNER, AUDIO IN, iPod).

Auto power off function:

In the stop mode of CD, MP3 or WMA operation, the main unit enters the stand-by mode after 15 minutes of inactivity.

Listening to a CD or MP3/WMA disc (continued)

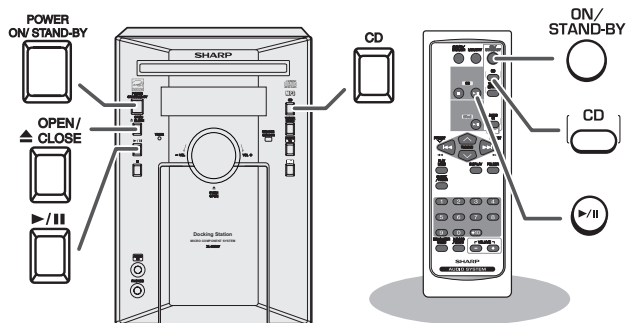

1 Press the ON/STAND-BY button to turn the power on.

2 Press the CD button.

3 Press the \blacktriangle OPEN/CLOSE button to open the disc tray.

4 Place the disc on the disc tray, label side up.

Be sure to place 3" (8 cm) disc in the middle of the disc tray.

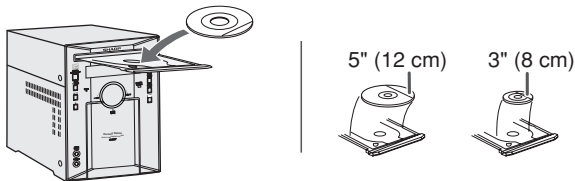

5 Press the \blacktriangle OPEN/CLOSE button to close the disc tray.

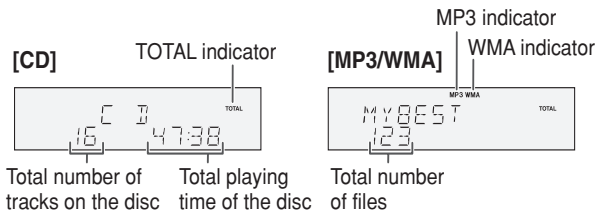

- Due to the structure of the disc information, it takes longer to read an MP3/WMA disc than a normal CD (approximately 20 to 90 seconds).

6 Press the \blacktriangleright / \parallel button to start playback.



- After the last track is played, the unit will stop automatically.













To remove the discs:

In the stop mode, press the \blacktriangle OPEN/CLOSE button.

Caution:

- Do not place two discs in one disc tray.
- Do not play discs of special shapes (heart, octagon, etc). It may cause malfunctions.
- Do not push the disc tray while it is moving.
- If the power fails while the tray is open, wait until the power is restored.
- If TV or radio interference occurs during CD operation, move the unit away from the TV or radio.

■ Various disc functions

Function	Main unit	Remote control	Operation
Play 			Press in the stop mode.
Stop 			Press in the playback mode.
Pause 			Press in the playback mode. Press the ► / button to resume playback from the paused point.
Track up/ Track down			Press in the playback or stop mode. If you press the button in the stop mode, press the ► / button to start the desired track.
Fast forward/ Fast reverse			Press and hold down in the playback mode. Release the button to resume playback.

Notes for CD or MP3/WMA disc:

- When the end of the last track is reached during fast forward, "END" will appear on the display and CD operation will be paused. When the beginning of the first track is reached during fast reverse, the unit will enter the playback mode.
- Rewritable multi-session discs with unfinished writing, can still be played.

Advanced CD or MP3/WMA disc playback

■ Direct track search

By using the direct search buttons, the desired tracks on the current disc can be played.

Use the direct search buttons on the remote control to select the desired track while playing the selected disc.



Selected track number

- The direct search buttons allow you to select up to number 9.
- When selecting number 10 or higher, use the "+10" button.

A. For example, to choose 13

- Press the "+10" button once.
- Press the "1" button.
- Press the "3" button.

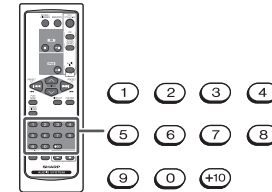

B. For example, to choose 130

- Press the "+10" button twice.
- Press the "1" button.
- Press the "3" button.
- Press the "0" button.

Notes:

- A track number higher than the number of tracks on the disc cannot be selected.
- During random play, direct search is not possible.

To stop playback:

Press the ■ (CD ■) button.

Advanced CD or MP3/WMA disc playback (continued)

■ Repeat play

Repeat play can play one track, all tracks or a programmed sequence continuously.

To repeat one track:

Press the PLAY MODE button once.
Press the ► / || button.

To repeat all tracks:

Press the PLAY MODE button twice.
Press the ► / || button.

To repeat desired tracks :

Perform steps 1 - 6 in “Programmed play” section on page 23 and then press the PLAY MODE button once.
Press the ► / || button.



To cancel repeat play:

Press the PLAY MODE button again until “C” disappears.

■ Random play

The tracks on the disc can be played in random order automatically.

To random play all tracks:

Press and hold down PLAY MODE button on the remote control.
Press the ► / || button.

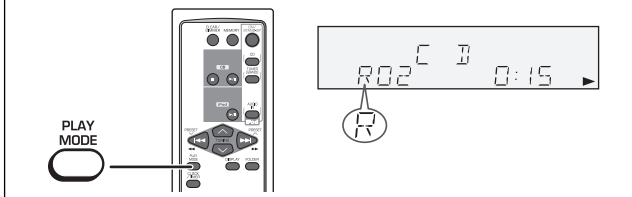

To cancel random play:

Press the PLAY MODE button.
“R” will disappear.

Notes:



- If you press the ►| button during random play, you can move to the track selected next by the random operation. On the other hand, the |◀◀ button does not allow you to move to the previous track. The beginning of the track being played will be located.
- In random play, the unit will select and play tracks automatically. (You cannot select the order of the tracks.)

Caution:

After performing repeat or random play, be sure to press the ■ (CD ■) button. Otherwise, the disc will play continuously.

■ Programmed play

You can choose up to 32 selections for playback in the order you like.

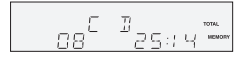
<p>1 While in the stop mode, press the MEMORY button on the remote control to enter the programming save mode.</p>	
<p>2 Press the direct search buttons on the remote control to select the desired track.</p>	 <p style="text-align: center;">Selected track number</p> <p>You can also select a track by pressing the ◀◀ or ▶▶ button.</p>
<p>3 Press the MEMORY button to save the track number.</p>	
<p>4 Repeat steps 2 - 3 for other tracks. Up to 32 tracks can be programmed.</p> <p>If you make a mistake, the programmed tracks can be cleared by pressing the CLEAR/DIMMER button.</p>	
<p>5 Press the ■ (CD ■) button.</p> <p>The total number in memory will appear.</p>	
<p>6 Press the ▶ / button to start playback.</p>	

To clear the programmed selections:

Press the CLEAR/DIMMER button on the remote control while the "MEMORY" indicator is flashing. Each time the button is pressed, one track will be cleared, beginning with the last track programmed.

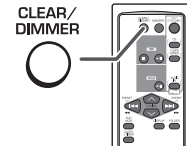

To cancel the programmed play mode:

While in the stop mode and the "MEMORY" indicator is lit, press the CLEAR/DIMMER button on the remote control. The "MEMORY" indicator will disappear and all the programmed contents will be cleared.

Adding tracks to the program:

If a program has been previously stored, the "MEMORY" indicator will be displayed. Then follow steps 1 - 6 to add tracks. The new tracks will be stored after the last track of the previous program.

To check which tracks are programmed:

While the unit is stopped in the programmed play mode, press the ◀◀ or ▶▶ button.

MP3/WMA Folder programmed:

Only tracks in the same folder can be select. Select which folder to be programmed before entering program mode. (refer page 25 to select folder)

Notes:

- When a disc ejected, the program is automatically canceled.
- Even if you press the ON/STAND-BY button to enter the stand-by mode or change the function from CD to another, the programmed selections will not be cleared.
- During the program operation, random play is not possible.

MP3/WMA folder mode (only for MP3/WMA files)

To play back MP3/WMA (Windows Media Audio) file

There are many music sites on the internet that you can download MP3/WMA (Windows Media Audio) music files. Follow the instructions from the website on how to download the music files. You can then play back these downloaded music files by burning them to a CD-R/RW disc.

- Your downloaded song/files are for personal use only. Any other usage of the song without owner's permission, is against the law.

■ About folder playback order

If MP3/WMA files are recorded in several folders, a folder number will be set to each folder automatically.

These folders can be selected by the FOLDER button on the remote control. If there is no supported file formats inside the selected folder, the folder is skipped and the next folder will be selected.

Example: How to set folder number if MP3/WMA format files are recorded as below figure.

1. ROOT folder is set as folder 1.
2. As for folders inside ROOT folder (Folder A and Folder B), the folder which is recorded earlier on the disc will be set as folder 2 and folder 3.
3. As for folder inside Folder A (Folder C and Folder D), the folder which is recorded earlier on the disc will be set as folder 4 and folder 5.
4. Folder E that is inside Folder D will be set as folder 6.

- The folder and file order information which is recorded on the disc depends on the writing software. There may be possibilities that this unit will playback the files not according to our expected playback order.
- For CD MP3/WMA, 512 numbers of folders and files inclusive of the folders which have non playable files can be read.

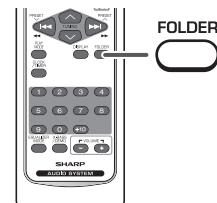

Folder mode on/off can be operated by the FOLDER button on the remote control. Files that are played when folder mode is set to the on position, may differ from those played back when folder mode is turned off.

Folder Mode Off case:

All the files starting from the selected file will be played back. If file 3 inside Folder C is selected, all the files starting from file 3 will be played back until file 10 of Folder E.

Folder Mode On case:

All the files inside the selected folder will be played back. In case Folder D is selected, file 6, 7 and 8 will be played back. File 9 and 10 in Folder E will not be played back.

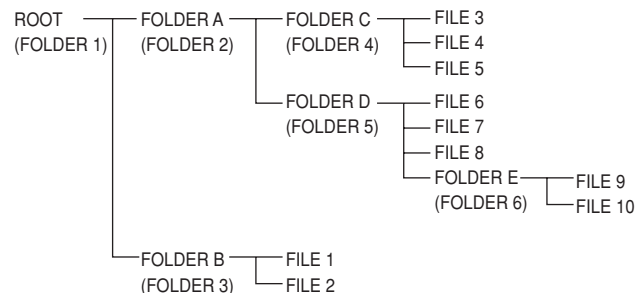

■ Procedure to play back MP3/WMA disc with folder mode on

To play back CD-R/RW.

1 Press the CD button, and load an MP3/WMA disc.

- After disc is loaded, disc info will be displayed.

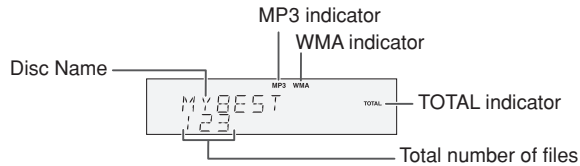

2 Press the FOLDER button, and press the TUNING (∨ or ∧) button to select desired playback folder. (Folder mode on)

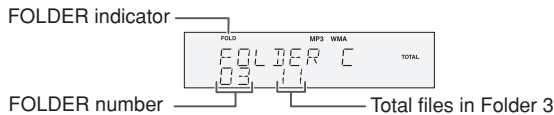

3 Select desired file to be played back by pressing the <<<< or >>>> button.



4 Press the >> / || (CD >> / ||) button.

Playback will start and file name will be displayed.

- Title, Artist & Album name are displayed if they are recorded on the disc.
- Display content can be changed by pressing the DISPLAY button.

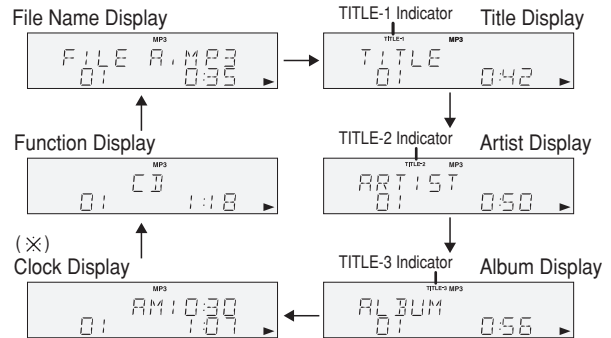

In case of playback with the folder mode on, press the TUNING (∨ or ∧) button, and the folder can be selected even though it is in playback/pause mode.

It will continue playback/pause mode in the 1st track of the selected folder.

(※) Only appears when clock is already set.

Note:

- If “NO SUPPORT” is displayed, it means “Copyright protected WMA file” or “Not supported playback file” is selected.

Listening to the radio

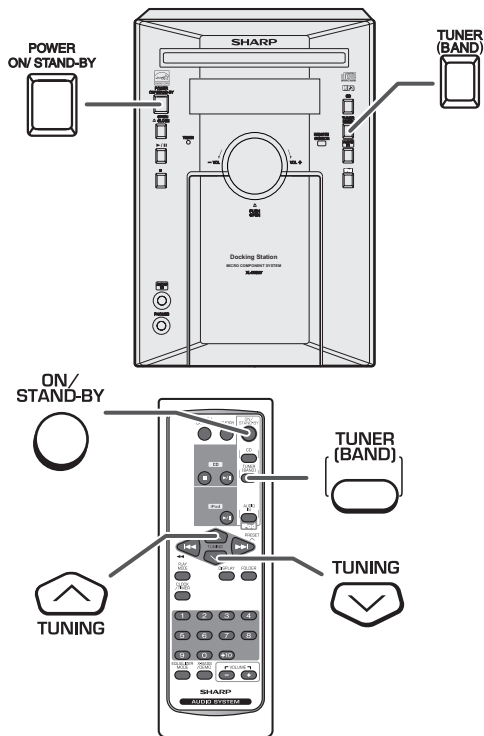

Auto power on function:

When you press any of the following buttons, the unit turns on.

- TUNER (BAND) button (main unit and remote control): The unit turns on and the "TUNER" function is activated.
- ► / || button on the main unit: The unit turns on and playback of the last function starts (CD, TUNER, AUDIO IN, iPod).

■ Tuning

- 1 Press the ON/STAND-BY button to turn the power on.
- 2 Press the TUNER (BAND) button repeatedly to select the desired frequency band (FM or AM).
- 3 Press the TUNING (∨ or ^) button on the remote control to tune in to the desired station.

Manual tuning:

Press the TUNING (∨ or ^) button as many times as required to tune in to the desired station.

Auto tuning:

When the TUNING (∨ or ^) button is pressed for more than 0.5 seconds, scanning will start automatically and the tuner will stop at the first receivable broadcast station.

Notes:

- When radio interference occurs, auto scan tuning may stop automatically at that point.
- Auto scan tuning will skip weak signal stations.
- To stop the auto tuning, press the TUNING (∨ or ^) button again.

To receive an FM stereo transmission:

Press the TUNER (BAND) button to select stereo mode and "ST" indicator will be displayed.

- "ST" will appear when an FM broadcast is in stereo.
- If the FM reception is weak, press the TUNER (BAND) button to extinguish the "ST" indicator. The reception changes to monaural, and the sound becomes clearer.

FM stereo mode indicator



FM stereo receiving indicator

■ Memorizing a station

You can store 40 AM and FM stations in memory and recall them at the push of a button. (Preset tuning)

- 1 Perform steps 1 - 3 in "Tuning" on page 26.**
- 2 Press the MEMORY button to enter the preset tuning saving mode.**
- 3 Within 30 seconds, press the PRESET (^ or v) button to select the preset channel number.**

Store the stations in memory, in order, starting with preset channel 1.
- 4 Within 30 seconds, press the MEMORY button to store that station in memory.**

If the "MEMORY" and preset number indicators disappear before the station is memorized, repeat the operation from step 2.
- 5 Repeat steps 1 - 4 to set other stations, or to change a preset station.**

When a new station is stored in memory, the station previously memorized for that preset channel number will be erased.

Note:

The backup function protects the memorized stations for a few hours should there be a power failure or the AC power cord become disconnected.

■ To recall a memorized station

Press the PRESET (^ or v) button for less than 0.5 seconds to select the desired station.

■ To scan the preset stations

The stations saved in memory can be scanned automatically. (Preset memory scan)

- 1 Press the PRESET (^ or v) button for more than 0.5 seconds. The preset number will flash and the programmed stations will be tuned in sequentially, for 5 seconds each.
- 2 Press the PRESET (^ or v) button again when the desired station is located.

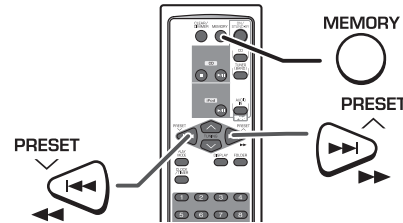

■ To erase entire preset memory

- 1 Press the ON/STAND-BY button to enter the stand-by mode.
- 2 While pressing down the ■ button, press the TUNER (BAND) button until "TUNER CLEAR" appears.

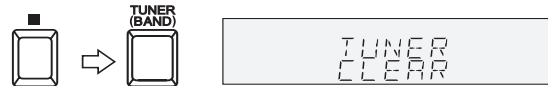

Timer and sleep operation (Remote Control only)

Timer playback:

The unit turns on and plays the desired source (CD, TUNER, iPod, AUDIO IN) at a preset time.

This unit has 2 types of timer: ONCE TIMER and DAILY TIMER.

Once timer: Once timer play works for one time only at a preset time.

Daily timer: Daily timer play works at the same preset time every day.

For example, set the timer as a wake-up call every morning.

Using the once timer and daily timer in combination:

For example, use the once timer to listen to a radio program, and use the daily timer to wake up.

- 1 Set the daily timer (pages 28 - 30).
- 2 Set the once timer (pages 28 - 30).

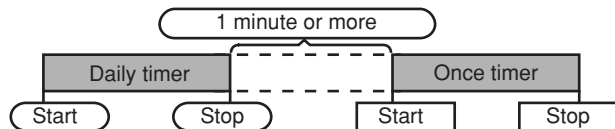

Note:

When set times for the daily timer and once timer overlap, the once timer takes priority. Allow an interval of at least 1 minute between operations.

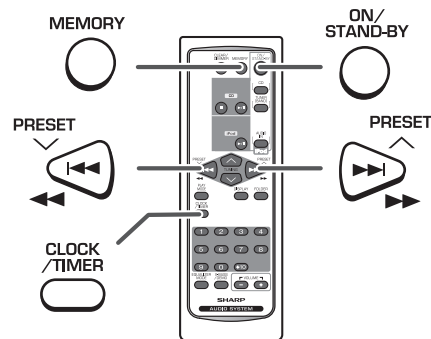

■ Timer playback

Before setting timer:

- 1 Check that the clock is set to the correct time (refer to page 15). If it is not set, you cannot use the timer function.
- 2 For timer playback: Load disc to be played.



- 1 Press the ON/STAND-BY button to turn the power on.
- 2 Press the CLOCK/TIMER button.
- 3 Within 10 seconds, press the <<<< or >>>> button to select "ONCE" or "DAILY", and press the MEMORY button.



Set the clock to the correct time if "ONCE" or "DAILY" does not appear.

- 4** Within 10 seconds, press the **◀◀** or **▶▶** button to select “ONCE SET” or “DAILY SET”, and press the **MEMORY** button.



- 5** Press the **◀◀** or **▶▶** button to adjust the hour and then press the **MEMORY** button.



The illustrations show the timer playback setting in the daily timer mode.

- 6** Press the **◀◀** or **▶▶** button to adjust the minutes and then press the **MEMORY** button.



- 7** Set the time to finish as in steps 5 and 6 above.

- 8** Switch input with the **◀◀** or **▶▶** button, and then press the **MEMORY** button.

To select the timer playback source: CD, TUNER, iPod or AUDIO IN.

- When you select the tuner, select a station by pressing the **◀◀** or **▶▶** button, and then press the **MEMORY** button.
- If a station has not been programmed, “NO PRESET” will be displayed and timer setting will be canceled.

- 9** Adjust the volume using the **VOLUME** control, and then press the **MEMORY** button.

Do not turn the volume up too high.

- 10** Press the **ON/STAND-BY** button to enter the power stand-by mode.

The “TIMER” indicator lights up and the unit is ready for timer playback.

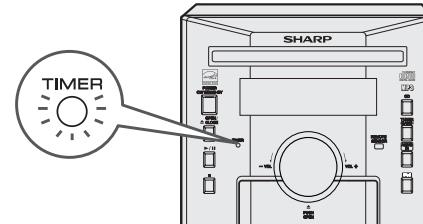

- 11** When the preset time is reached, playback will start.

The volume will increase gradually until it reaches the preset volume.

- 12** When the timer end time is reached, the system will enter the power stand-by mode automatically.

Once timer:

The timer will be canceled.

Daily timer:

The timer will operate at the same time every day. It will continue until the daily timer setting is canceled. Cancel the daily timer when it is not in use.

Timer and sleep operation (Remote Control only) (continued)

Note:

When performing timer playback using another unit connected to the iPod terminal or AUDIO IN jack, select "iPod" or "AUDIO IN" in step 8. This unit will turn on or enter the power stand-by mode automatically. However, the connected unit to AUDIO IN jack will not turn on or off.

Checking the timer setting in the timer stand-by mode:

- 1 Press the CLOCK/TIMER button.
- 2 Within 10 seconds, press the **◀◀◀** or **▶▶▶** button to select "ONCE" or "DAILY", and press the MEMORY button.
- 3 Within 10 seconds, press the **◀◀◀** or **▶▶▶** button to select "ONCE CALL" or "DAILY CALL", and press the MEMORY button. The unit returns to the timer stand-by mode after displaying the settings in order.

Canceling the timer setting in the timer stand-by mode:

- 1 Press the CLOCK/TIMER button.
- 2 Within 10 seconds, press the **◀◀◀** or **▶▶▶** button to select "ONCE" or "DAILY", and press the MEMORY button.
- 3 Within 10 seconds, press the **◀◀◀** or **▶▶▶** button to select "ONCE OFF" or "DAILY OFF", and press the MEMORY button. Timer will be canceled (the setting will not be canceled).



Reusing the memorized timer setting:

The timer setting will be memorized once it is entered. To reuse the same setting, perform the following operations.

- 1 Turn the power on and press the CLOCK/TIMER button.
- 2 Within 10 seconds, press the **◀◀◀** or **▶▶▶** button to select "ONCE" or "DAILY", and press the MEMORY button.
- 3 Within 10 seconds, press the **◀◀◀** or **▶▶▶** button to select "ONCE ON" or "DAILY ON", and press the MEMORY button.
- 4 Press the ON/STAND-BY button to enter the power stand-by mode.

■ Sleep operation

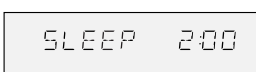
The radio, compact disc and iPod can be turned off automatically.

1	Play back the desired sound source.	
2	Press the CLOCK/TIMER button.	
3	Within 10 seconds, press the ◀◀◀ or ▶▶▶ button to select "SLEEP", and press the MEMORY button.	
4	Press the ◀◀◀ or ▶▶▶ button to select the time. (Maximum: 3 hours - Minimum: 1 minute) ● 3 hours - 5 minutes → 5-minute intervals ● 5 minutes - 1 minute → 1-minute intervals	
5	Press the MEMORY button. "SLEEP" will appear.	
6	The unit will enter the power stand-by mode automatically after the preset time has elapsed. The volume will be turned down 1 minute before the sleep operation finishes.	

To confirm the remaining sleep time:

- 1 While "SLEEP" is indicated, press the CLOCK/TIMER button.
- 2 Within 10 seconds, press the **◀◀◀** or **▶▶▶** button to select "SLEEP X : XX".
"X : XX" is sleep remaining time.
● The remaining sleep time is displayed for about 10 seconds.
● You can change the remaining sleep time while it is displayed by pressing the MEMORY button (steps 4 - 5).

Enhancing your system

XL-DK227N

To cancel the sleep operation:

Press the ON/STAND-BY button while "SLEEP" is indicated. To cancel the sleep operation without setting the unit to the stand-by mode, proceed as follows.

- 1 While "SLEEP" is indicated, press the CLOCK/TIMER button.
- 2 Within 10 seconds, press the ◀◀◀◀ or ▶▶▶▶ button to select "SLEEP OFF", and press the MEMORY button.

■ To use timer and sleep operation together

Sleep and timer playback:

For example, you can fall asleep listening to the radio and wake up to CD in the next morning.

- 1 Set the sleep time (see left, steps 1 - 5).
- 2 While the sleep timer is set, set the timer playback (steps 2 - 10, pages 28 - 29).

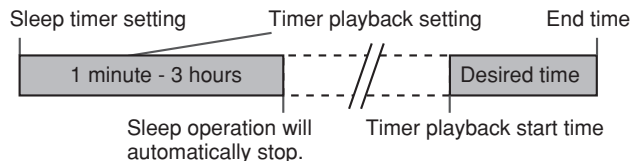

The connection cord is not included. Purchase a commercially available cord as shown below.

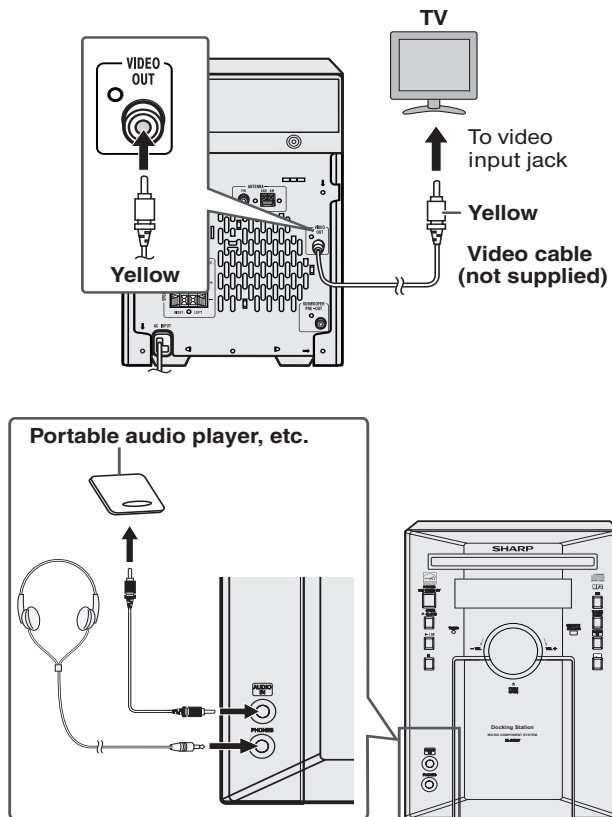

Enhancing your system (continued)

Auto power on function:

When you press any of the following buttons, the unit turns on.

- AUDIO IN button (main unit and remote control): The unit turns on and the "AUDIO IN" function is activated.
- ► / || button on the main unit: The unit turns on and playback of the last function starts (CD, TUNER, AUDIO IN, iPod).

■ Listening to the playback sounds of Portable Audio Player, etc.

1 Use a connection cord to connect the Portable Audio Player etc. to the AUDIO IN jack.

When using video equipment, connect the audio output to this unit and the video output to a television.

2 Press the ON/STAND-BY button to turn the power on.

3 Press the AUDIO IN button.

4 Play the connected equipment.

Note:

To prevent noise interference, place the unit away from the television.

■ Headphones

- Do not turn the volume on to full at switch on. Listen to music at moderate levels. Excessive sound pressure from earphones and headphones can cause hearing loss.
- Before plugging in or unplugging the headphones, reduce the volume.
- Be sure your headphones have a 1/8" (3.5 mm) diameter plug and impedance between 16 and 50 ohms. The recommended impedance is 32 ohms.
- Plugging in the headphones disconnects the speakers automatically. Adjust the volume using the VOLUME control.

■ Subwoofer connection

When a commercially available subwoofer with a built-in amplifier is connected to this unit, you can enjoy sound with emphasized bass. Connect an RCA cord from a commercially available speaker with a built-in amplifier to the SUBWOOFER PRE-OUT jack.

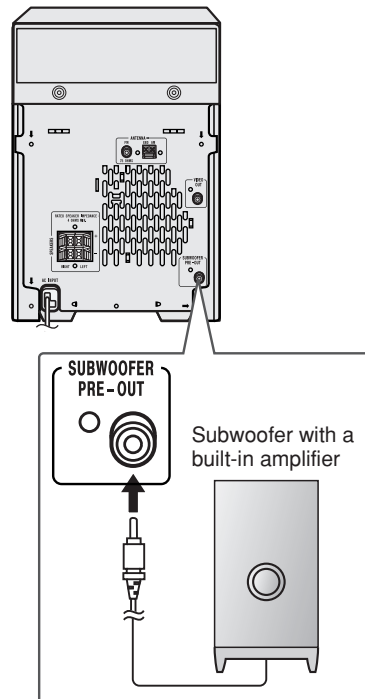

Troubleshooting chart

Many potential problems can be resolved by the owner without calling a service technician.

If something is wrong with this product, check the following before calling your authorized SHARP dealer or service center.

■ General

Symptom	Possible cause
<ul style="list-style-type: none"> ● The clock is not set to the correct time. 	<ul style="list-style-type: none"> ● Did a power failure occur? Reset the clock. (Refer page 15)
<ul style="list-style-type: none"> ● When a button is pressed, the unit does not respond. 	<ul style="list-style-type: none"> ● Set the unit to the power stand-by mode and then turn it back on. ● If the unit still malfunctions, reset it. (Refer page 34)
<ul style="list-style-type: none"> ● No sound is heard. 	<ul style="list-style-type: none"> ● Is the volume level set to "0"? ● Are the headphones connected? ● Are the speaker wires disconnected?

■ CD player

Symptom	Possible cause
<ul style="list-style-type: none"> ● Playback does not start. ● Playback stops in the middle or is not performed properly. 	<ul style="list-style-type: none"> ● Is the disc loaded upside down? ● Does the disc satisfy the standards? ● Is the disc distorted or scratched?
<ul style="list-style-type: none"> ● Playback sounds are skipped, or stopped in the middle of a track. 	<ul style="list-style-type: none"> ● Is the unit located near excessive vibrations? ● Is the disc very dirty? ● Has condensation formed inside the unit?

■ Remote control

Symptom	Possible cause
<ul style="list-style-type: none"> ● The remote control does not operate. 	<ul style="list-style-type: none"> ● Is the AC power cord of the unit plugged in? ● Is the battery polarity correct? ● Are the batteries dead? ● Is the distance or angle incorrect? ● Does the remote control sensor receive strong light?

■ Tuner

Symptom	Possible cause
<ul style="list-style-type: none"> ● The radio makes unusual noises continuously. 	<ul style="list-style-type: none"> ● Is the unit placed near the TV or computer? ● Is the FM antenna or AM loop antenna placed properly? Move the antenna away from the AC power cord if it's located nearby.

■ iPod

Symptom	Possible cause
<ul style="list-style-type: none"> ● No sound is produced. No image appears on the TV/monitor. 	<ul style="list-style-type: none"> ● The iPod is not playing. ● The iPod is not properly connected to the unit. ● Is the AC power cord of the unit plugged in? ● The video cable is not properly connected. ● The TV/monitor's input selection is not properly set. ● Does the display shows "DOCK OK".
<ul style="list-style-type: none"> ● iPod will not charge. 	<ul style="list-style-type: none"> ● Wrong iPod adaptor is used. ● The iPod is not making full contact with the iPod connector. ● The main unit is in stand-by mode. ● Using 3rd Generation iPod

Troubleshooting chart (continued)

■ Condensation

Sudden temperature changes, storage or operation in an extremely humid environment may cause condensation inside the cabinet (CD pickup, etc.) or on the transmitter on the remote control. Condensation can cause the unit to malfunction. If this happens, leave the power on with no disc in the unit until normal playback is possible (about 1 hour). Wipe off any condensation on the transmitter with a soft cloth before operating the unit.

■ If trouble occurs

When this product is subjected to strong external interference (mechanical shock, excessive static electricity, abnormal supply voltage due to lightning, etc.) or if it is operated incorrectly, it may malfunction.

If such a problem occurs, do the following:

- 1 Set the unit to the stand-by mode and turn the power on again.
- 2 If the unit is not restored in the previous operation, unplug and plug in the unit, and then turn the power on.

Note:

If neither operation above restores the unit, clear all the memory by resetting it.

■ Factory reset, clearing all memory

- 1 Press the ON/STAND-BY button to enter the power stand-by mode.
- 2 While pressing down the  button, press the CD button until "CLEAR ALL" appears.



Caution:

This operation will erase all data stored in memory including clock, timer settings, tuner preset, and CD program.

■ Before transporting the unit

Remove CD from the unit. Make sure there is no CD in the disc tray. Then, set the unit to the power stand-by mode. Carrying the unit with disc left inside can damage the unit.

■ Care of compact discs

Compact discs are fairly resistant to damage, however mistracking can occur due to an accumulation of dirt on the disc surface. Follow the guidelines below for maximum enjoyment from your CD collection and player.

- Do not write on either side of the disc, particularly the non-label side from which signals are read. Do not mark this surface.
- Keep your discs away from direct sunlight, heat, and excessive moisture.
- Always hold the CDs by the edges. Fingerprints, dirt, or water on the CDs can cause noise or mistracking. If a CD is dirty or does not play properly, clean it with a soft, dry cloth, wiping straight out from the center, along the radius.

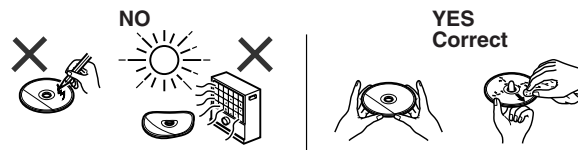

Maintenance

■ Cleaning the CD pickup lens

In order to ensure proper operation of the CD player, preventative maintenance (cleaning of the laser pickup lens) should be performed periodically. Lens cleaners are commercially available. Contact your local CD software dealer for options.

■ Cleaning the cabinet

Periodically wipe the cabinet with a soft cloth and a diluted soap solution, then with a dry cloth.

Caution:

- Do not use chemicals for cleaning (gasoline, paint thinner, etc.). It may damage the cabinet finish.
- Do not apply oil to the inside of the unit. It may cause malfunctions.

Specifications

As part of our policy of continuous improvement, SHARP reserves the right to make design and specification changes for product improvement without prior notice. The performance specification figures indicated are nominal values of production units. There may be some deviations from these values in individual units.

■ General

Power source	AC 120 V ~ 60 Hz
Power consumption	35 W
Dimensions	Width: 7-1/16" (180 mm) Height: 10-2/8" (260 mm) Depth: 10-6/8" (273 mm)
Weight	8.8 lbs (4 kg)

■ Amplifier

Output power	RMS : Total 64 W (32 W per channel into 4 ohms at 1 kHz, 10% Total harmonic distortion.) FTC : 25 W minimum RMS per channel into 4 ohms from 100 Hz to 20 kHz, 10% Total harmonic distortion.
Output terminals	Speakers: 4 ohms Headphones: 16 - 50 ohms (recommended: 32 ohms) Subwoofer pre-out (audio signal): 150 mV/10 k ohms at 70 Hz
Input terminals	Audio In (Audio signal): 250 mV/47 k ohms

■ CD player

Type	Single disc multi-play compact disc player
Signal readout	Non-contact, 3-beam semiconductor laser pickup
D/A converter	Multi bit D/A converter
Frequency response	20 - 20,000 Hz
Dynamic range	90 dB (1 kHz)

■ Tuner

Frequency range	FM: 87.5 - 108 MHz AM: 530 - 1,720 kHz
------------------------	---

■ Speaker

Type	2-way type speaker system 2" (5 cm) tweeter 4" (10 cm) woofer
Maximum input power	64 W
Rated input power	32 W
Impedance	4 ohms
Dimensions	Width: 5-13/16" (148 mm) Height: 10-1/4" (260 mm) Depth: 6-15/16" (175.5 mm)
Weight	4.72 lbs (2.14 kg)/each

CONSUMER LIMITED WARRANTY

SHARP ELECTRONICS CORPORATION warrants to the first consumer purchaser that this Sharp brand product (the "Product"), when shipped in its original container, will be free from defective workmanship and materials, and agrees that it will, at its option, either repair the defect or replace the defective Product or part thereof with a new or remanufactured equivalent at no charge to the purchaser for parts or labor for the period(s) set forth below.

This warranty does not apply to any appearance items of the Product nor to the additional excluded item(s) set forth below nor to any Product the exterior of which has been damaged or defaced, which has been subjected to improper voltage or other misuse, abnormal service or handling, or which has been altered or modified in design or construction.

In order to enforce the rights under this limited warranty, the purchaser should follow the steps set forth below and provide proof of purchase to the servicer.

The limited warranty described herein is in addition to whatever implied warranties may be granted to purchasers by law. ALL IMPLIED WARRANTIES INCLUDING THE WARRANTIES OF MERCHANTABILITY AND FITNESS FOR USE ARE LIMITED TO THE PERIOD(S) FROM THE DATE OF PURCHASE SET FORTH BELOW. Some states do not allow limitations on how long an implied warranty lasts, so the above limitation may not apply to you.

Neither the sales personnel of the seller nor any other person is authorized to make any warranties other than those described herein, or to extend the duration of any warranties beyond the time period described herein on behalf of Sharp.

The warranties described herein shall be the sole and exclusive warranties granted by Sharp and shall be the sole and exclusive remedy available to the purchaser. Correction of defects, in the manner and for the period of time described herein, shall constitute complete fulfillment of all liabilities and responsibilities of Sharp to the purchaser with respect to the Product, and shall constitute full satisfaction of all claims, whether based on contract, negligence, strict liability or otherwise. In no event shall Sharp be liable, or in any way responsible, for any damages or defects in the Product which were caused by repairs or attempted repairs performed by anyone other than an authorized servicer. Nor shall Sharp be liable or in any way responsible for any incidental or consequential economic or property damage. Some states do not allow the exclusion of incidental or consequential damages, so the above exclusion may not apply to you.

THIS WARRANTY GIVES YOU SPECIFIC LEGAL RIGHTS. YOU MAY ALSO HAVE OTHER RIGHTS WHICH VARY FROM STATE TO STATE.

Model Specific Section

Your Product Model Number & Description:

XL-DK227N Micro Component System

(Be sure to have this information available when you need service for your Product.)

Warranty Period for this Product:

One (1) year parts and labor from the date of purchase.

Additional Item(s) Excluded from Warranty Coverage (if any):

Non-functional accessories, supplies, and consumable items.

Where to Obtain Service:

At a Sharp Authorized Servicer located in the United States.

To find a location of the nearest Sharp Authorized Servicer, call Sharp toll free at 1-800-BE-SHARP.

What to do to Obtain Service:

Ship prepaid or carry in your Product to a Sharp Authorized Servicer.

Be sure to have **Proof of Purchase** available. If you ship the Product, be sure it is insured and packaged securely.

TO OBTAIN SUPPLY, ACCESSORY OR PRODUCT INFORMATION, CALL **1-800-BE-SHARP**.

SHARP

SHARP ELECTRONICS CORPORATION

Sharp Plaza, Mahwah, New Jersey 07430

SHARP CORPORATION

Printed in Malaysia

TINSEA228AWZZ

08B R KI ①