

# SHARP®

## LC-32DH57E LC-32DH57S

LCD COLOUR TELEVISION  
LCD-FARBfernsehgerät  
TÉLÉvISEUR COULEUR À ÉCRAN  
CRISTAUX LIQUIDES (LCD)  
TELEVISORE A COLORI LCD  
LCD-KLEURENTELEVISIE  
TELEVISIÓN EN COLOR LCD  
TELEVISOR DE CRISTAL LÍQUIDO

OPERATION MANUAL  
BEDIENUNGSANLEITUNG  
MODE D'EMPLOI  
MANUALE DI ISTRUZIONI  
GEBRUIKSAANWIJZING  
MANUAL DE MANEJO  
MANUAL DE OPERAÇÃO

ENGLISH

DEUTSCH

FRANÇAIS

ITALIANO

NETHERLANDS

ESPAÑOL

PORTUGUÊS

# AQUOS



**HD  
TV**

**HD  
ready**



**HDMI™**  
HIGH-DEFINITION MULTIMEDIA INTERFACE

**DVB**  
Digital Video  
Broadcasting

**DOLBY**  
DIGITAL PLUS



### **SPECIAL NOTE FOR USERS IN THE U.K.**

The mains lead of this product is fitted with a non-rewireable (moulded) plug incorporating a 13A fuse. Should the fuse need to be replaced, a BSI or ASTA approved BS 1362 fuse marked  or  and of the same rating as above, which is also indicated on the pin face of the plug, must be used. Always refit the fuse cover after replacing the fuse. Never use the plug without the fuse cover fitted. In the unlikely event of the socket outlet in your home not being compatible with the plug supplied, cut off the mains plug and fit an appropriate type.

#### **DANGER:**

The fuse from the cut-off plug should be removed and the cut-off plug destroyed immediately and disposed of in a safe manner.

Under no circumstances should the cut-off plug be inserted elsewhere into a 13A socket outlet, as a serious electric shock may occur.

To fit an appropriate plug to the mains lead, follow the instructions below:

#### **IMPORTANT:**

The wires in the mains lead are coloured in accordance with the following code:

**Blue: Neutral**

**Brown: Live**

As the colours of the wires in the mains lead of this product may not correspond with the coloured markings identifying the terminals in your plug, proceed as follows:

- The wire which is coloured blue must be connected to the plug terminal which is marked N or coloured black.
  - The wire which is coloured brown must be connected to the plug terminal which is marked L or coloured red.
- Ensure that neither the brown nor the blue wire is connected to the earth terminal in your three-pin plug.

Before replacing the plug cover make sure that:

- If the new fitted plug contains a fuse, its value is the same as that removed from the cut-off plug.
- The cord grip is clamped over the sheath of the mains lead, and not simply over the lead wires.

**IF YOU HAVE ANY DOUBT, CONSULT A QUALIFIED ELECTRICIAN.**

- The illustrations and the OSD in this operation manual are for explanation purposes and may vary slightly from the actual operations.
- The examples used throughout this manual are based on the LC-32DH57E model.
- LC-32DH57E and LC-32DH57S models are compatible with H.264 (MPEG4 H.264, MPEG4 AVC, MPEG4 AVC/H.264) compressed broadcasts.
- The marks (-BK, etc.) at the end of model name represent the colour of the TV cabinet.

**Dear SHARP customer**

Thank you for your purchase of the SHARP LCD colour TV product. To ensure safety and many years of trouble-free operation of your product, please read the Important Safety Precautions carefully before using this product.

## Contents

<b>Contents</b> .....	<b>1</b>	<b>Basic adjustment</b> .....	<b>17</b>
<b>Introduction</b> .....	<b>2</b>	Picture Settings .....	17
Important Safety Precautions .....	2	AV MODE.....	18
Trademarks.....	2	Audio Settings .....	18
Remote control unit .....	3	Automatic volume adjustment .....	19
TV (Front view) .....	4	Outputting audio only.....	19
TV (Rear view).....	4	Setting audio input.....	19
<b>Preparation</b> .....	<b>5</b>	Power Save Settings.....	20
Supplied accessories .....	5	Channel Settings .....	20
Optional accessory .....	5	Auto Installation .....	20
Attaching the stand unit .....	5	Channel detail settings.....	20
Inserting the batteries.....	6	Password/Parental lock settings .....	22
Using the remote control unit .....	6	Language Settings.....	22
Cautions regarding the remote control unit.....	6	<b>Useful viewing functions</b> .....	<b>23</b>
<b>Quick guide</b> .....	<b>7</b>	Selecting the picture size .....	23
Initial installation overview.....	7	Display Settings .....	23
Before turning on the power .....	8	Channel display.....	23
Initial auto installation .....	9	Time and Title display .....	23
Checking signal strength.....	9	<b>Other useful features</b> .....	<b>24</b>
<b>Watching TV</b> .....	<b>10</b>	Setting when using external devices .....	24
Daily operation .....	10	Input source settings.....	24
Switching on/off.....	10	Skipping specified inputs .....	24
Switching between digital and analogue		Reset.....	24
broadcasts.....	10	Identification .....	24
Changing channels .....	10	Software update .....	24
Selecting an external video source.....	10	<b>Connecting a PC</b> .....	<b>25</b>
Selecting a sound mode .....	10	Connecting a PC .....	25
EPG.....	11	Displaying a PC image on the screen.....	25
Teletext .....	12	Selecting the picture size .....	25
Using the MHEG-5 application (UK only) .....	12	Adjusting the PC image automatically .....	26
<b>Connecting external devices</b> .....	<b>13</b>	Adjusting the PC image manually .....	26
Video connections .....	13	RS-232C port specifications .....	27
HDMI connection .....	13	PC compatibility chart .....	28
Component connection .....	14	RS-232C command list .....	28
VIDEO connection.....	14	<b>Appendix</b> .....	<b>29</b>
SCART connection .....	14	Troubleshooting .....	29
Audio connections .....	15	Specifications .....	30
Speaker/amplifier connection.....	15	End of life disposal.....	31
Inserting the CA Card into the CI Module .....	15	Rating table for Child Lock.....	32
<b>Menu operation</b> .....	<b>16</b>	Abbreviation list .....	32
What is the MENU? .....	16		
Basic Operation .....	16		

# Introduction

## Important Safety Precautions

- **Cleaning**—Unplug the AC cord from the AC outlet before cleaning the product. Use a damp cloth to clean the product. Do not use liquid cleaners or aerosol cleaners.
- **Water and moisture**—Do not use the product near water, such as bathtub, washbasin, kitchen sink, laundry tub, swimming pool and in a wet basement.
- Do not place vases or any other water-filled containers on this product. The water may spill onto the product causing fire or electric shock.
- **Stand**—Do not place the product on an unstable cart, stand, tripod or table. Doing so can cause the product to fall, resulting in serious personal injuries as well as damage to the product. Use only a cart, stand, tripod, bracket or table recommended by the manufacturer or sold with the product. When mounting the product on a wall, be sure to follow the manufacturer's instructions. Use only the mounting hardware recommended by the manufacturer.
- When relocating the product placed on a cart, it must be moved with utmost care. Sudden stops, excessive force and uneven floor surface can cause the product to fall from the cart.
- **Ventilation**—The vents and other openings in the cabinet are designed for ventilation. Do not cover or block these vents and openings since insufficient ventilation can cause overheating and/or shorten the life of the product. Do not place the product on a bed, sofa, rug or other similar surface, since they can block ventilation openings. This product is not designed for built-in installation; do not place the product in an enclosed place such as a bookcase or rack, unless proper ventilation is provided or the manufacturer's instructions are followed.
- The LCD panel used in this product is made of glass. Therefore, it can break when the product is dropped or impact applied. If the LCD panel is broken, be careful not to be injured by broken glass.
- **Heat sources**—Keep the product away from heat sources such as radiators, heaters, stoves and other heat-generating products (including amplifiers).
- To prevent fire, never place any type of candle or naked flames on the top or near the TV set.
- To prevent fire or shock hazard, do not place the AC cord under the TV set or other heavy items.
- **Headphones**—Do not set the volume at a high level. Hearing experts advise against extended listening at high volume levels.
- Do not display a still picture for a long time, as this could cause an afterimage to remain.
- There is power consumption always if main plug is connected.
- **Servicing**—Do not attempt to service the product yourself. Removing covers can expose you to high voltage and other dangerous conditions. Request a qualified person to perform servicing.

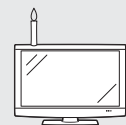

The LCD panel is a very high technology product, giving you fine picture details.

Due to the very large number of pixels, occasionally a few non-active pixels may appear on the screen as a fixed point of blue, green or red. This is within product specifications and does not constitute a fault.

### Precautions when transporting the TV

When transporting the TV, never carry it by holding onto the speakers. Be sure to always carry the TV by two people holding it with two hands—one hand on each side of the TV.

## Trademarks

• "HDMI, the HDMI logo and High-Definition Multimedia Interface are trademarks or registered trademarks of HDMI Licensing LLC."

• Manufactured under license from Dolby Laboratories.  
• "Dolby" and the double-D symbol are trademarks of Dolby Laboratories.

• The "HD ready" Logo is a trademark of EICTA.

• The "HD TV" Logo is a trademark of EICTA.

• The DVB logo is the registered trademark of the Digital Video Broadcasting—DVB—project.

### NOTE

- LC-32DH57E and LC-32DH57S models are compatible with Dolby Digital Plus.

# Introduction

## Remote control unit

- 1** | **(Standby/On)**  
(Page 10)
- 2** **Numeric buttons 0–9**  
Set the channel.  
Enter desired numbers.  
Set the page in teletext mode.
  - When the five Nordic countries (Sweden, Norway, Finland, Denmark, or Iceland) are selected in the country setting from “Auto Installation” (Page 20), DTV/ATV channels are four digits. When another country is selected, DTV/ATV channels are three digits.
- 3** **(Flashback)**  
Press to return to the previously selected channel or external input.
- 4** **(WIDE MODE)**  
Select a wide mode (Pages 23 and 25).
- 5** **(Freeze)**  
Press to freeze a moving image on the screen.
- 6** **(Cursor)**  
Select a desired item on the setting screen.  
**OK**  
Execute a command within the “MENU” screen.  
TV: Display the programme list when no other “MENU” screen is running.
- 7** **END**  
Exit the “MENU” screen.
- 8** **Colour (Red/Green/Yellow/Blue) buttons**  
The coloured buttons are correspondingly used to select the coloured items on the screen (e.g., EPG, MHEG-5, Teletext).
- 9** **EPG**  
TV: Display the EPG screen (Page 11).

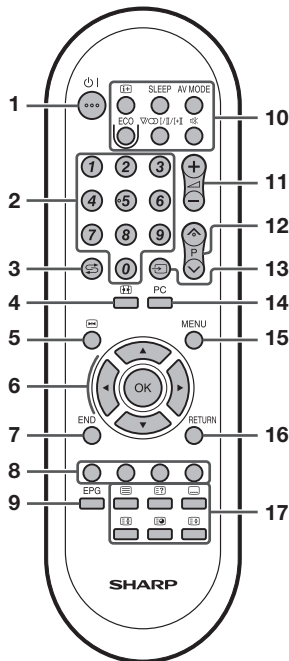

- 11** **(Volume)**  
Increase/decrease TV volume.
- 12** **P ^ / \ V**  
Select the TV channel.
- 13** **(INPUT SOURCE)**  
Select an input source (Page 10).
- 14** **PC**  
Directly select EXT 4.
- 15** **MENU**  
“MENU” screen on/off.
- 16** **RETURN**  
Return to the previous “MENU” screen.
- 17** **Buttons for useful operations**
  - (Teletext)**  
ATV: Display analogue teletext (Page 12).  
DTV: Select MHEG-5 and teletext for DTV (Page 12).
  - (Reveal hidden Teletext)**  
(Page 12)
  - (Subtitle)**  
Switch subtitle languages on/off (Pages 12 and 22).
  - (Freeze/Hold)**  
Press to freeze a moving image on the screen.  
Teletext: Stop updating teletext pages automatically or release the hold mode (Page 12).
  - (Subpage)**  
(Page 12)
  - (Top/Bottom/Full)**  
Set the area of magnification in teletext mode (Page 12).
- 10** **(Display information)**  
Press to display the station information (channel number, signal, etc.) in the upper right corner of the screen (Page 23).  
**SLEEP**  
Press to schedule a time for the TV to automatically standby.  
**AV MODE**  
Select a video setting (Page 18).  
**ECO (Off/Standard/Advanced)**  
Select “Energy Save” setting (Page 20).  
 **(Sound mode)**  
Select a sound multiplex mode (Page 10).  
 **(Mute)**  
TV sound on/off.

# Introduction

## TV (Front view)

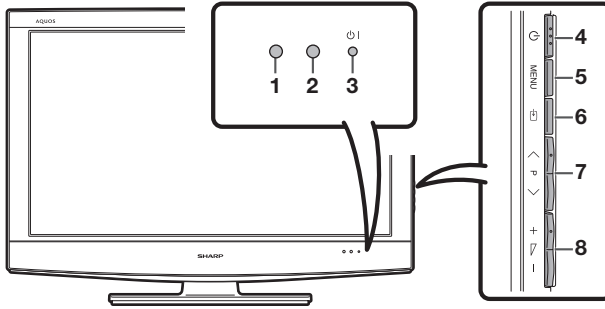

- 1 Remote control sensor
- 2 OPC sensor
- 3 | (Standby/On indicator)
- 4 (Power button)
- 5 **MENU** (Menu button)
- 6 (Input source button)
- 7 **P** / **V** (Programme [channel] buttons)
- 8 **+** / **-** (Volume buttons)

## TV (Rear view)

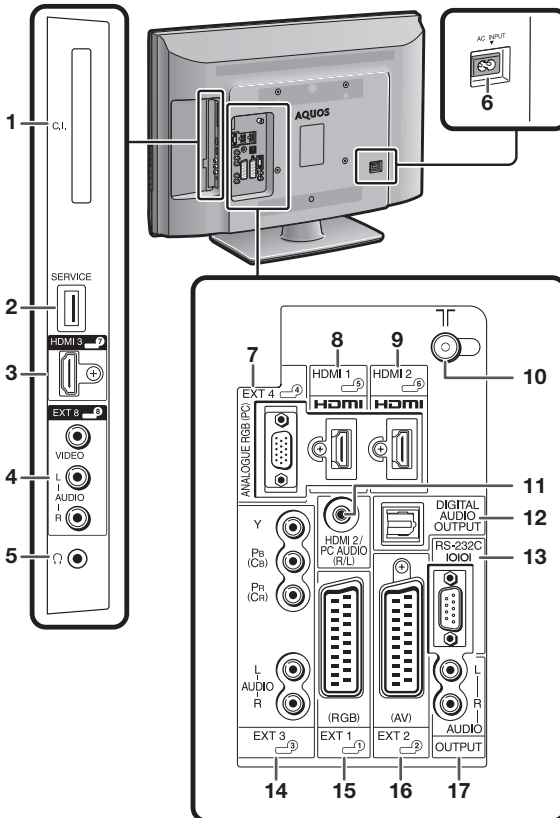

- 1 COMMON INTERFACE slot
- 2 SERVICE terminal (USB terminal for service personnel only)
- 3 HDMI 3 (HDMI) terminal
- 4 EXT 8 terminals
- 5 Headphones
- 6 AC INPUT terminal
- 7 EXT 4 (ANALOGUE RGB) terminal
- 8 HDMI 1 (HDMI) terminal
- 9 HDMI 2 (HDMI) terminal
- 10 Antenna terminal
- 11 HDMI 2/PC AUDIO (R/L) jack\*
- 12 DIGITAL AUDIO OUTPUT terminal
- 13 RS-232C terminal
- 14 EXT 3 (COMPONENT/AUDIO) terminals
- 15 EXT 1 (RGB) terminal
- 16 EXT 2 (AV) terminal
- 17 OUTPUT (AUDIO) terminals

### WARNING

- Excessive sound pressure from earphones and headphones can cause hearing loss.
- Do not set the volume at a high level. Hearing experts advise against extended listening at high volume levels.
- The SERVICE terminal is reserved only for qualified service personnel. Do not connect anything to the terminal.

\* The HDMI 2 and EXT 4 terminals can both use the same audio input terminal (HDMI 2/PC AUDIO (R/L)). However, the proper item must be selected in the "PC Audio Select" menu (Refer to page 19 for details).

# Preparation

## Supplied accessories

Remote control unit ( x 1)



Pages 3 and 6

AC cord ( x 1)

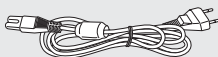

Product shape varies in some countries.

Page 8

Stand unit ( x 1)

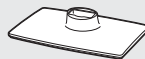

Page 5

- Operation manual (This publication)
- "AA" size zinc-carbon battery ( x 2) ... Page 6

## Optional accessory

The listed optional accessory is available for this LCD colour TV. Please purchase them at your nearest shop.

- Additional optional accessories may be available in the near future. When purchasing, please read the newest catalogue for compatibility and check the availability.

No.	Part name	Part number
1	Wall mount bracket (LC-32DH57E, LC-32DH57S)	AN-37AG5

## Attaching the stand unit

- Before attaching (or detaching) the stand, unplug the AC cord from the AC INPUT terminal.
- Before performing work, spread cushioning over the surface on which you will be laying the TV. This will prevent it from being damaged.

### CAUTION

- **Attach the stand in the correct direction.**
- **Be sure to follow the instructions. Incorrect installation of the stand may result in the TV falling over.**

- 1** Confirm that there are four screws with the stand unit.



- 2** Place the stand unit onto the supporting post on the bottom of the TV (①).

- 3** Insert and tighten the four screws on the bottom of the stand unit as shown (②).

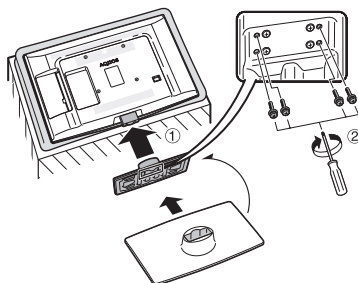

### NOTE

- To detach the stand unit, perform the steps in reverse order.
- A screw driver is not supplied with this product.

# Preparation

## Inserting the batteries

Before using the TV for the first time, insert two supplied "AA" size zinc-carbon batteries. When the batteries become depleted and the remote control unit fails to operate, replace the batteries with new "AA" size batteries.

- 1 Open the battery cover.
- 2 Insert two supplied "AA" size batteries.
  - Place batteries with their terminals corresponding to the (+) and (-) indications in the battery compartment.
- 3 Close the battery cover.

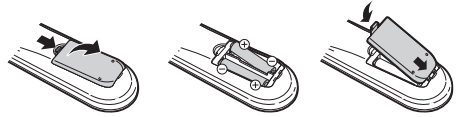

### CAUTION

Improper use of batteries can result in chemical leakage or explosion. Be sure to follow the instructions below.

- Do not mix batteries of different types. Different types of batteries have different characteristics.
- Do not mix old and new batteries. Mixing old and new batteries can shorten the life of new batteries or cause chemical leakage in old batteries.
- Remove batteries as soon as they have worn out. Chemicals that leak from batteries can cause a rash. If you find any chemical leakage, wipe thoroughly with a cloth.
- The batteries supplied with this product may have a shorter life expectancy due to storage conditions.
- If you will not be using the remote control unit for an extended period of time, remove the batteries from it.

## Using the remote control unit

Use the remote control unit by pointing it towards the remote control sensor. Objects between the remote control unit and sensor may prevent proper operation.

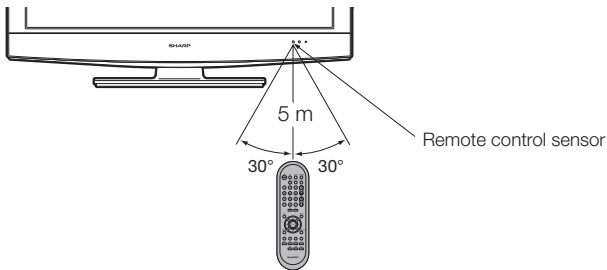

## Cautions regarding the remote control unit

- Do not expose the remote control unit to shock. In addition, do not expose the remote control unit to liquids, and do not place in an area with high humidity.
- Do not install or place the remote control unit under direct sunlight. The heat may cause deformation of the unit.
- The remote control unit may not work properly if the remote control sensor of the TV is under direct sunlight or strong lighting. In such cases, change the angle of the lighting or the TV, or operate the remote control unit closer to the remote control sensor.

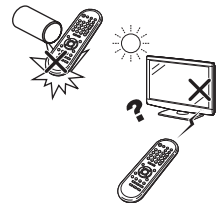



# Quick guide

## Initial installation overview

Follow the steps below one by one when using the TV for the first time. Some steps may not be necessary depending on your TV installation and connection.

1

### Preparation

- 1 Connect an antenna cable to the antenna terminal (Page 8).

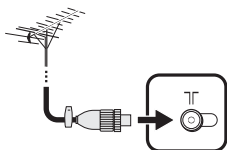

- 2 If necessary, insert a CA card into the CI slot to watch scrambled broadcasts (Page 15).



- 3 Connect the AC cord to the TV (Page 8).

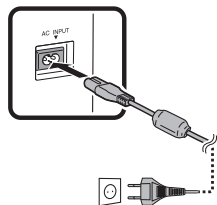

Product shape varies in some countries.

2

### Run the initial settings

- 1 Turn on the power using  on the TV (Page 10).

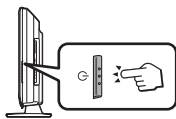

- 2 Run the initial auto installation (Page 9).

#### ✓ Language setting



#### ✓ Home/Store setting



#### ✓ Country setting



#### ✓ Installation start confirmation



**Start searching channels**

3

### Watch TV

- 1 **Congratulations!**  
**Now you can watch TV.**
- 2 If necessary, adjust the antenna to attain maximum signal reception (Page 9).

### Connect external devices

- 1 Connect external devices such as a DVD player/recorder as instructed (Pages 13–14).

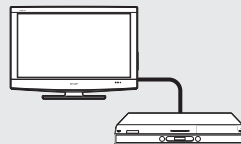

- 2 Connect external audio devices such as speakers/amplifier as instructed (Page 15).



## Quick guide

### Before turning on the power

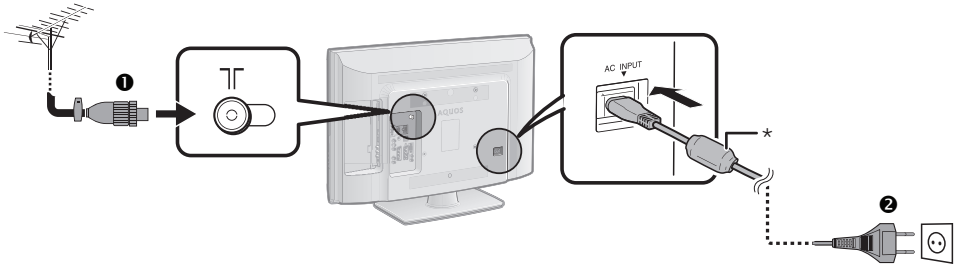

❶ Standard DIN45325 plug (IEC 169-2) 75 Ω coaxial cable

❷ AC cord (Product shape varies in some countries)

\* The AC cord is supplied either with a ferrite core or without a ferrite core. Neither type causes unnecessary electrical wave emissions or interference.

Place the TV close to the AC outlet, and keep the power plug within reach.

### Supplying power to the antenna

When an active antenna is used, power must be supplied to the antenna using the following procedures after connecting the antenna cable to the antenna terminal on the rear of the TV in order to receive terrestrial digital signals.

- 1 Press **MENU** and the "MENU" screen displays.
- 2 Press **◀/▶** to select "Setup".
- 3 Press **▲/▼** to select "Antenna Setup", and then press **OK**.
- 4 Press **▲/▼** to select "Supply Voltage", and then press **OK**.
- 5 Press **◀/▶** to select "On", and then press **OK**.

### Mounting the TV on a wall

- **This TV should be mounted on a wall only with the wall mount bracket available from SHARP (Page 5). The use of other wall mount brackets may result in an unstable installation and may cause serious injuries.**
- **Mounting the LCD colour TV requires special skills and should only be performed by qualified service personnel. Customers should not attempt to do the work themselves. SHARP bears no responsibility for improper mounting or mounting that results in accident or injury.**
- You can ask qualified service personnel about using an optional bracket to mount the TV to a wall.
- When you mount the TV on a wall, you should attach the supporting post.

### When using wall mount bracket AN-37AG5

You can check the centre of the TV screen using the mark engraved on the wall mount bracket when mounting the TV on the wall.

#### AN-37AG5

LC-32DH57E, LC-32DH57S: The centre of the TV screen is 24.5 mm above the mark "A" on the wall bracket.

# Quick guide

## Initial auto installation

When the TV is powered on for the first time after purchase, the initial auto installation wizard appears. Follow the menus and make the necessary settings one after another.

### Confirm the following before turning on the power

- Is the antenna cable connected?
- Is the AC cord plugged in?

- 1 Press **⏻** on the TV.
  - The initial auto installation wizard appears.
- 2 Setting the OSD language.



Press **▲/▼** to select the desired language, and then press **OK**.

- 3 Selecting the location of the TV.



Press **▲/▼** to select where you will use this TV, and then press **OK**.

- HOME: "STANDARD" will be the default value for the "AV MODE" setting.
- STORE: "DYNAMIC (Fixed)" will be the default value for the "AV MODE" setting. If the "AV MODE" is changed, the TV will automatically switch back to "DYNAMIC (Fixed)" when there is no signal input from the TV or remote control unit for 30 minutes.

- 4 Setting the country.



Press **▲/▼** to select your country or area, and then press **OK**.

- This setting screen only appears during the first installation.

- 5 Starting channel search.



Press **▲/▼** to select "Start" or "Skip", and then press **OK**.

- If you want to search for more broadcasts, execute "Additional Search" from the "Programme Setup" menu (Page 21).

- 6 The TV searches for, sorts and stores all the receivable TV stations according to their settings and the connected antenna.
  - To abort the initial auto installation in progress, press **RETURN**.

### NOTE

- If you turn off the power on the TV after performing step 5 or if you select "Skip" on step 5, the initial auto installation wizard will not appear. The auto installation function allows you to execute the installation again from the "Setup" menu (Page 20).
- The initial auto installation wizard will go off if you leave the TV unattended for 10 minutes before searching for channels in step 6.
- After initial auto installation is completed, the default PIN is automatically set to "1234". To change the PIN setting, refer to **Password/Parental lock settings** (Page 22). To clear the PIN setting (PIN input will no longer be needed), refer to **CLEARING THE PIN** (Page 24).
- When "Italy" is selected in the country setting, the default PIN is automatically set to "1234" and the default age restriction value is set to 18.

## Checking signal strength

If you install an antenna for the first time or relocate it, you should adjust the alignment of the antenna to receive a good reception while checking the antenna setup screen.

- 1 Press **MENU** and the "MENU" screen displays.
- 2 Press **◀/▶** to select "Setup".
- 3 Press **▲/▼** to select "Antenna Setup", and then press **OK**.
- 4 Press **▲/▼** to select "Signal Strength".

### NOTE

- The values of "Signal Strength" indicates when to check the appropriate alignment of the antenna.

# Watching TV

## Daily operation

### Switching on/off

#### Turning on/off the power

Press on the TV.  
Switch it off by pressing on the TV.

### Standby mode

#### To standby mode

If the TV is switched on, you can switch it to standby by pressing on the remote control unit.

#### Switching on from standby

From standby, press on the remote control unit.



### TV indicator status

(Standby/On indicator)	Status
Off	Power off
Green	Power on
Red	Standby

### NOTE

- If you are not going to use this TV for a long period of time, be sure to remove the AC cord from the AC outlet.
- A small amount of electric power is still consumed even when is turned off.

## Switching between digital and analogue broadcasts

### Watching digital broadcasts

001 to 900 ch

### Watching analogue broadcasts

From 901 ch

### NOTE

- If the TV cannot search digital broadcasts, the analogue broadcasts are set from 001 channel.

## Changing channels

With :



With 0-9:



## Selecting an external video source

Once the connection is made, press to display the "INPUT SOURCE" screen, and then press or to switch over to the appropriate external source with **OK**.

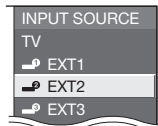

## Selecting a sound mode

### For DTV

If multi sound modes are received, each time you press or the mode switches as follows.

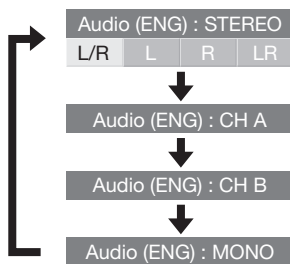

Press or to select L or R sound when the STEREO or DUAL MONO screen is displayed.



### NOTE

- The sound mode screen disappears in six seconds.
- Selectable items vary depending on the received broadcasts.

### For ATV

Each time you press or , the mode switches as shown in the following tables.

NICAM TV broadcasts selection	
Signal	Selectable items
Stereo	NICAM STEREO, MONO
Bilingual	NICAM CH A, NICAM CH B, NICAM CH AB, MONO
Monaural	NICAM MONO, MONO
A2 TV broadcasts selection	
Signal	Selectable items
Stereo	STEREO, MONO
Bilingual	CH A, CH B, CH AB
Monaural	MONO

### NOTE

- When no signal is input, the sound mode will display "MONO".

# Watching TV

## EPG

EPG is a programme list that is displayed on the screen. With the EPG, you can check the schedule of DTV/RADIO, view detailed information about them, tune to an event currently on-air.

### Basic Operation

The illustrations on this page are explained using three digit channels.

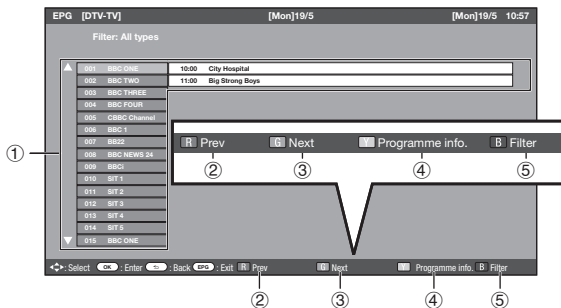
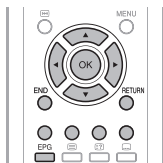

### ● Display/Close the EPG screen

Press **EPG**.

### ● Search for a programme on the main screen

#### ① Search for a channel and programme

- 1 Press **▲/▼** to select the channel you want to search, and then press **▶** to move the cursor to the programme table.
  - If **▲** or **▼** are displayed on the left of the channels, continue to press **▲/▼** to display next or previous screen.
- 2 Press **▲/▼** to select the desired programme, and then press **OK** to display the programme information.

### Searching for a programme using colour buttons on the remote control unit

#### ② Search for a programme on the previous day

Press the red button to move to the programme table for the previous day.

#### ③ Search for a programme on the next day

Press the green button to move to the programme table for the next day.

#### ④ Check programme information

- 1 Press **▲/▼** to select the programme you want to check.
- 2 Press the yellow button to display the programme information.
- 3 Press the yellow button or **RETURN** to go back to the EPG screen.

#### ⑤ Search a programme in a category

- 1 Press the blue button.
- 2 Press **▶** to select the desired filter category.
  - Each time you press **▶**, the filter category switches (e.g., "Movie", "News", etc.).
- 3 Press **OK** or the blue button to display the programme table for the selected category.
- 4 Press the blue button or **RETURN** to go back to the EPG screen.

# Watching TV

## Teletext



### What is Teletext?

Teletext broadcasts pages of information and entertainment to specially equipped TV. Your TV receives teletext signals broadcast by a TV network, and decodes them into graphical format for viewing. News, weather and sports information, stock exchange prices and programme previews are among the many services available.

### Turning Teletext on/off



- 1 Select a TV channel or external source providing a teletext programme.
- 2 Press  to display the Teletext.
  - Many stations use the TOP operating system, while some use FLOF (e.g., CNN). Your TV supports both these systems. The pages are divided into topic groups and topics. After switching on the teletext, up to 2,000 pages are stored for fast access.
  - If you select a programme with no teletext signal, "No Teletext available" displays.
  - The same message displays during other modes if no teletext signal is available.



- Each time you press , the screen switches as shown above.
- Press  again to display the teletext on the right screen and the normal image on the left screen.

### Teletext Language







If teletext information is not displayed correctly, select the language type from among nine kinds of language tables; "West Europe", "East Europe", "Russia", "Russia-2", "Greek", "Turkey", "Arab/Hbrw", "Farsian", or "Arab".

- 1 Go to "MENU" > "Digital Setup" > "Teletext Language" > "Decode Page Lang."
- 2 Press /  to select a receivable teletext broadcasting language in your area, and then press **OK**.

### NOTE

- Teletext can be displayed only when it is sent by a network. Not used to convert between languages.

## Buttons for teletext operations

Buttons	Description
	Increase or decrease the page number.
<b>Colour (Red/Green/Yellow/Blue)</b>	Select a group or block of pages displayed in the coloured brackets at the bottom of the screen by pressing the corresponding Colour (Red/Green/Yellow/Blue) on the remote control unit.
<b>Numeric buttons 0-9</b>	Directly select any page from 100 to 899 by using the <b>0-9</b> numeric buttons.
 (Top/Bottom/Full)	Switch the teletext image to Top, Bottom or Full.
 (Reveal hidden Teletext)	Reveal or hide hidden information such as an answer to a quiz.
 (Freeze/Hold)	Stop updating teletext pages automatically or release the hold mode.
 (Subtitle for Teletext)	Display the subtitle or exit the subtitle screen. <ul style="list-style-type: none"> <li>• Subtitles will not be displayed when the service does not contain subtitle information.</li> </ul>
 (Subpage)	Reveal or hide subpages. <ul style="list-style-type: none"> <li>• Red button: Move to the previous subpage.</li> <li>• Green button: Move to the following subpage.</li> <li>• These two buttons are shown on the screen by the symbols "+" and "-".</li> </ul>

## Using the MHEG-5 application (UK only)

Some services bring you programmes with the MHEG application encoded, letting you experience DTV interactively. When provided, the MHEG-5 application will start when you press .



# Connecting external devices

## Before connecting ...

- Be sure to turn off the TV and any devices before making any connections.
- Firmly connect a cable to a terminal or terminals.
- Carefully read the operation manual of each external device for possible connection types. This also helps you get the best possible audiovisual quality to maximise the potential of the TV and the connected device.
- Refer to page 25 for connecting a PC to the TV.

## NOTE

- The cables illustrated in pages 13–15 are commercially available items.

## Video connections

### HDMI connection

#### Example of connectable devices

- DVD player/recorder
- Blu-ray player/recorder
- Game console

The HDMI connections permit digital video and audio transmission via a connection cable from a player/recorder. The digital picture and sound data are transmitted without data compression and therefore lose none of their quality. Analogue/digital conversion is no longer necessary in the connected devices, which also would result in quality losses.

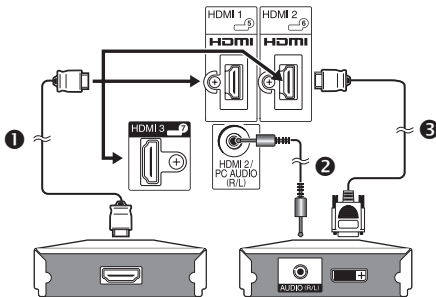

- 1 HDMI-certified cable
- 2 ø 3.5 mm stereo minijack cable
- 3 DVI/HDMI cable

### Controlling HDMI devices using AQUOS LINK

Set to "On" to enable interactive operation of compatible HDMI devices (AV amplifiers, DVD player/recorders, Blu-ray player/recorders).

#### AQUOS LINK Control

Go to "MENU" > "Option" > "AQUOS LINK Control" > select "On".

### AQUOS LINK functions

#### One touch play

When images are played back from the connected HDMI device, the TV will automatically switch to the appropriate input source.

#### Standby

When the TV enters standby mode, the connected HDMI device enters standby mode as well.

## NOTE

- The availability of the AQUOS LINK function depends on the HDMI device used. Depending on the manufacturer and type of equipment used, it is possible that the described functions may be completely or partially unusable.

### DVI/HDMI conversion

Using a DVI/HDMI cable, the digital video signals of a DVD can also be played via the compatible HDMI connection. The sound must be fed in additionally.

- When connecting a DVI/HDMI cable to the HDMI terminal, the image may not come in clearly.

### When using the HDMI 2 terminal

You must set the audio signal input source depending on the type of HDMI cable connected (Refer to page 19 for details).

#### HDMI-certified cable

Go to "MENU" > "Option" > "PC Audio Select" > select "EXT 4 (RGB)".

#### DVI/HDMI cable

Go to "MENU" > "Option" > "PC Audio Select" > select "HDMI 2".

## NOTE

- Video noise may occur depending on the type of HDMI cable used. Make sure to use a certified HDMI cable.
- When playing the HDMI image, the best possible format for the picture will be detected and set automatically.

### Supported video signal:

576i, 576p, 480i, 480p, 1080i, 720p, 1080p  
See page 28 for PC signal compatibility.

# Connecting external devices

## Component connection

### Example of connectable devices

- VCR
- DVD player/recorder
- Blu-ray player/recorder

You will enjoy accurate colour reproduction and high quality images through the EXT 3 terminal when connecting a DVD player/recorder or other device.

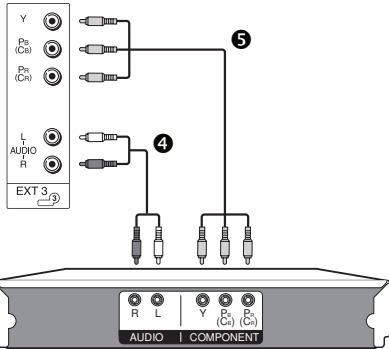

4 Audio cable

5 Component cable

## VIDEO connection

### Example of connectable devices

- VCR
- DVD player/recorder
- Game console
- Camcorder

You can use the EXT 8 terminal when connecting to a game console, camcorder, a DVD player/recorder or other device.

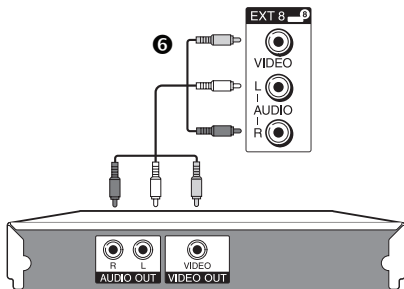

6 AV cable

## SCART connection

### Example of connectable devices

- Decoder

### EXT 1 (RGB) terminal

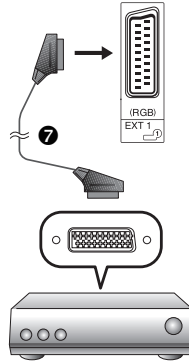

7 SCART cable

### Example of connectable devices

- VCR
- DVD player/recorder

### EXT 2 (AV) terminal

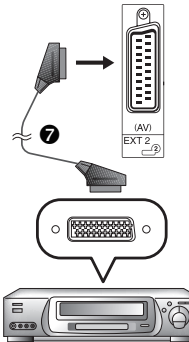

7 SCART cable

### NOTE

- Do not connect a decoder to the EXT 2 terminal.



# Connecting external devices

## Audio connections

### Speaker/amplifier connection

Connect an amplifier with external speakers as shown below.

#### ● Connecting an amplifier with digital audio input

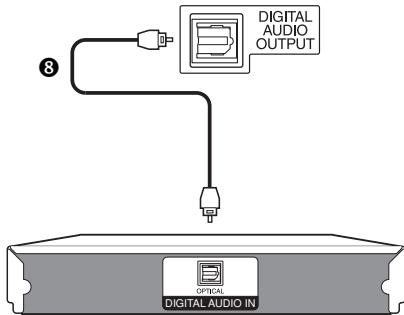

8 Optical audio cable

#### ● Connecting an amplifier with analogue audio input

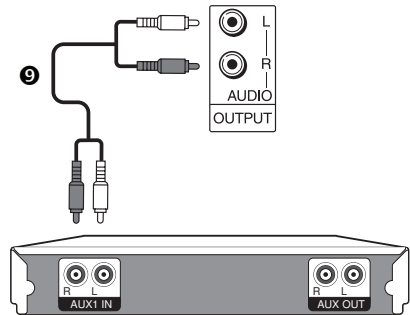

9 Audio cable

#### ● After connecting

##### Digital audio output setting

After connecting an amplifier with digital audio input and external speakers as shown, you should set an audio output format compatible with the programme you are watching or the device connected.

Go to "MENU" > "Option" > "Digital Audio Output" > select "PCM" or "Dolby Digital".

##### NOTE

- When set to "Dolby Digital", Dolby Digital is output when the Dolby Digital or Dolby Digital Plus audio formats are received. When set to "PCM", PCM is output no matter what audio formats are received.
- Some audio formats such as HE-AAC cannot be output as Dolby Digital.

## Inserting the CA Card into the CI Module

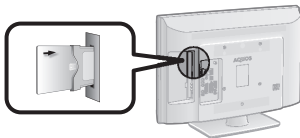

- 1 Carefully insert the CI Module in the CI slot with the contact side forward.
- 2 The logo on the CI Module must be facing outward from the rear of the TV.

### Checking CI Module information

Go to "MENU" > "Digital Setup" > "CI Menu".

- The content of this menu depends on the provider of the CI Module.

#### Module

General information on CI Module displays.

#### Menu

Adjustment parameters of each CA Card displays.

#### Enquiry

You can input numerical values such as passwords here.

#### NOTE

- Make sure that the CI Module is properly inserted.

# Menu operation

## What is the MENU?

- You need to call up the OSD to perform settings for the TV. The OSD for the settings is called "MENU".
- The "MENU" enables various settings and adjustments.

## Basic Operation

1

### Display the MENU Screen

Press **MENU** and the "MENU" screen displays.

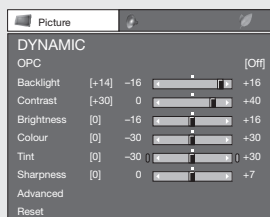

3

### Exit the MENU screen

The operation will exit the "MENU" screen if you press **END** before it is completed.

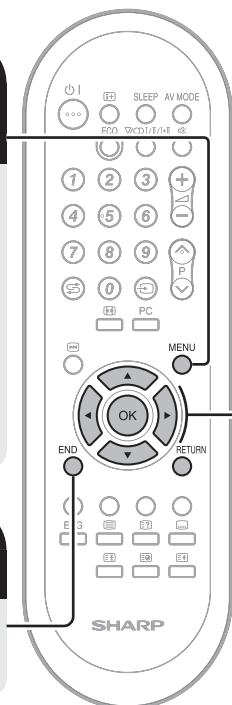

2

### Select an item

Press **▲/▼/◀/▶** to select/adjust the desired menu, and adjust the item to the desired level, and then press **OK**. Press **RETURN** to return to the previous "MENU" page.

#### Selecting in the MENU

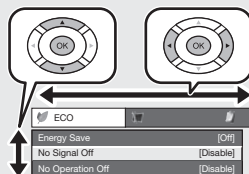

#### Selecting options

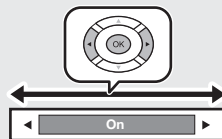

## NOTE

- "MENU" options differ in the selected input modes, but the operating procedures are the same.
- Items with  cannot be selected for various reasons.
- The "MENU" screen will disappear if left unattended for several seconds.

## Operation without a remote control unit

This function is useful when there is no remote control unit within your reach.

- 1 Press **MENU** and the "MENU" screen displays.
- 2 Press **P▲/▼** instead of **▲/▼** or **◀+/-** instead of **◀/▶** to select the item.
- 3 Press **→** to complete the setting.

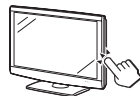

## About the Guide Display

The Guide Display at the bottom of the screen shows operations with the OSD.

- The bar above is an operational guide for the remote control unit. The bar will change in accordance with each menu setting screen.

◀: Select **OK**: Enter **→**: Back **MENU**: End

# Basic adjustment

## Picture Settings

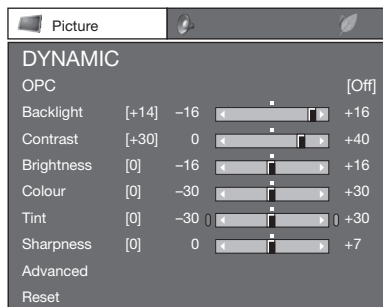

## Picture OPC

Automatically adjusts the brightness of the screen.

Item	
<b>On:Display</b>	Displays the OPC effect on the screen while adjusting the brightness of the screen.
<b>On</b>	Automatically adjusts.
<b>Off</b>	The brightness is fixed at the value set in "Backlight".

### NOTE

- When set to "On", the TV senses the surrounding light and automatically adjusts the backlight brightness. Make sure no object obstructs the OPC sensor, which could affect its ability to sense surrounding light.

## Picture Picture adjustments

Adjusts the picture to your preference with the following picture settings.

### Adjustment items

Selectable items	◀ (Cursor)	▶ (Cursor)
<b>Backlight</b>	The screen dims	The screen brightens
<b>Contrast</b>	For less contrast	For more contrast
<b>Brightness</b>	For less brightness	For more brightness
<b>Colour</b>	For less colour intensity	For more colour intensity
<b>Tint</b>	Skin tones become purplish	Skin tones become greenish
<b>Sharpness</b>	For less sharpness	For more sharpness

## Picture Advanced

This TV provides various advanced functions for optimising the picture quality.

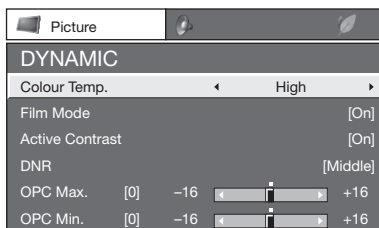

### Colour Temp.

Adjusts the colour temperature to give the best white image.

Item	
<b>High</b>	White with bluish tone.
<b>Mid-High</b>	Intermediate tone between "High" and "Middle".
<b>Middle</b>	Natural tone.
<b>Mid-Low</b>	Intermediate tone between "Middle" and "Low".
<b>Low</b>	White with reddish tone.

### Film Mode

Automatically detects a film-based source (originally encoded at 24 or 25 frames per second, depending on the vertical frequency), analyses it and then recreates each still film frame for high-definition picture quality.

### Active Contrast

Automatically adjusts the contrast of an image according to the scene.

### DNR

"DNR" produces a clearer image ("Off", "High", "Middle", "Low").

### NOTE

- This function may not be available depending on the input signal type.

# Basic adjustment

## Range of OPC

The brightness level range of the OPC sensor's automatic adjustments can be set according to your preferences. The adjustment range of the OPC sensor can be set to a maximum of + 16 and a minimum of - 16.

### NOTE

- This function is available only when the "OPC" setting is set to "On" or "On:Display".
- The maximum setting cannot be set to a smaller number than the minimum setting.
- The minimum setting cannot be set to a bigger number than the maximum setting.
- The maximum and minimum settings cannot be set to the same number.
- Depending on the brightness of the surrounding light, the OPC sensor might not operate if the adjustment range is small.

## AV MODE

"AV MODE" gives you several viewing options to choose from to best match the system environment, which can vary due to factors like room-brightness, type of programme watched or the type of image input from external equipment.

- 1 Press **AV MODE**.
- 2 Each time you press **AV MODE**, the mode changes.

- You can also switch the mode on the "Picture" and "Audio" menu screen by pressing **AV MODE**.

Item	
<b>STANDARD</b>	For a highly defined image in a normally bright room.
<b>MOVIE</b>	For viewing a movie in a darkened room.
<b>GAME</b>	For playing of video games.
<b>PC*</b>	For PC.
<b>USER</b>	Allows you to customise settings as desired. You can set the mode for each input source.
<b>DYNAMIC (Fixed)</b>	For a clear-cut image emphasising high contrast for sports viewing (The "Picture" and "Audio" settings cannot be adjusted).
<b>DYNAMIC</b>	For a clear-cut image emphasising high contrast for sports viewing.

### NOTE

- The item marked with \* is available only when selecting "HDMI 1", "HDMI 2", "HDMI 3" or "EXT 4" from the "INPUT SOURCE" menu.

## Audio Settings

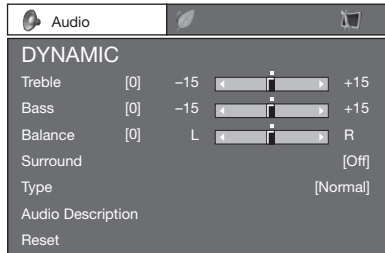

## Audio adjustment

You can adjust the sound quality to your preference with the following settings.

Selectable items	◀ (Cursor)	▶ (Cursor)
<b>Treble</b>	For weaker treble	For stronger treble
<b>Bass</b>	For weaker bass	For stronger bass
<b>Balance</b>	Decrease audio from the right speaker	Decrease audio from the left speaker

## Audio Surround

This function allows you to enjoy realistic live sound.

## Basic adjustment



### Audio

#### Type

Item	
<b>Normal</b>	Audio stream is output normally.
<b>Audio Description</b>	Selecting this item enables you to adjust the settings for the visually impaired (see below).
<b>Hard of Hearing</b>	Audio for the hearing impaired is output on the TV speakers by default when the programme contains audio information.



### Audio

#### Audio Description

Available only when you set "Audio Description" in the "Type" menu above.

Item	
<b>Speaker</b>	When set to "On", audio for the visually impaired is output from the TV speakers.
<b>Headphone</b>	When set to "On", audio for the visually impaired is output from the headphone terminal.
<b>Volume</b>	Adjust the volume of the speakers or headphones.

## Automatic volume adjustment



### Option

#### Auto Volume

Different sound sources sometimes do not have the same volume level, such as a programme and its commercial breaks. The Automatic Volume Control (Auto Volume) reduces this problem by equalizing levels.

## Outputting audio only



### Option

#### Audio Only

When listening to music from a music programme, you can set the TV off and enjoy audio only.

Item	
<b>Off</b>	Both screen images and audio are output.
<b>On</b>	Audio is output without a screen image.

## Setting audio input



### Option

#### PC Audio Select

When using the EXT 4 terminal or HDMI 2 terminal, you must select which terminal uses the AUDIO (R/L) jack for analogue audio input.

Item	
<b>HDMI 2</b>	When connecting devices (including a PC) with DVI/HDMI cable to the HDMI 2 terminal and inputting analogue audio signals from the AUDIO (R/L) jack*.
<b>EXT 4 (RGB)</b>	When connecting a PC to the EXT 4 terminal, and inputting analogue audio signals from the AUDIO (R/L) jack.

\* HDMI signals have priority when the signal includes audio.

### NOTE

- You must set this to "EXT 4 (RGB)" when connecting devices (including a PC) with an HDMI-certified cable to the HDMI 2 terminal. If "HDMI 2" is set, there will be no sound output.

## Basic adjustment

### Power Save Settings

 ECO		
Energy Save	[Standard]	
No Signal Off	[Disable]	
No Operation Off	[Disable]	

#### ECO Energy Save



This function enables you to automatically reduce the backlight brightness in order to decrease the power consumption and increase the backlight life span.

Item	
Off	The backlight brightness is the same value of your settings in the selected "AV MODE".
Standard	Reduces the backlight brightness by 20 %.
Advanced	Reduces the backlight brightness by 30 %.

#### NOTE

- This function does not work when "AV MODE" is set to "DYNAMIC (Fixed)".

#### "Energy Save" status icons

Icon	Description
	"Energy Save" is set to "Standard".
	"Energy Save" is set to "Advanced".

#### ECO No Signal Off

When set to "Enable", the TV will automatically enter standby mode if there is no signal input for 15 minutes.

#### ECO No Operation Off

The TV will automatically enter standby mode if no operations are performed during the time span you set ("30 min." or "3 hr.").

### Channel Settings

#### Auto Installation

##### Setup Auto Installation

The TV automatically detects and stores all available channels in your area. This function also allows you to perform the channel setting for digital and analogue individually and reconfigure the settings after the initial auto installation has been completed.

After selecting "Yes" on the screen, you can set language and channel search the same as in the initial auto installation.

#### NOTE

- PIN input is required when executing "Auto Installation". The default PIN is "1234". To change the PIN setting, refer to **Password/Parental lock settings** (Page 22). To clear the PIN setting (PIN input will no longer be needed), refer to **CLEARING THE PIN** (Page 24).
- You cannot set the Home/Store setting and the country setting in "Auto Installation" in the "Setup" menu. If you want to reconfigure those settings, automatically execute initial auto installation after executing "Reset" from the "Setup" menu.

#### Channel detail settings

##### Setup Programme Setup

You can reconfigure the DTV/ATV channel settings automatically or manually.

#### NOTE

- PIN input is required when executing "Programme Setup". The default PIN is "1234". To change the PIN setting, refer to **Password/Parental lock settings** (Page 22). To clear the PIN setting (PIN input will no longer be needed), refer to **CLEARING THE PIN** (Page 24).

# Basic adjustment

## Additional Search

Use this menu to add new channels automatically after auto installation has been completed.

## Channel Edit

This menu allows you to reconfigure some settings for the channel currently selected.

### Label

When a TV channel sends its Network Name, the "Auto Installation" detects the information and assigns a name to it. However, you can change channel names individually.

- 1 Press **▲/▼/◀/▶** to select each character of the new name for the channel, and then press **OK**.
- 2 Repeat step 1 above until the name is fully spelt out.

### NOTE

- The name can be six characters or less.
- If a channel name is less than six characters, select "END" to set the channel name.

### Frequency

You can adjust the frequency to the desired position (only for analogue channels).

### NOTE

- Adjust while checking the background picture as a reference.
- You can set the frequency by pressing **◀/▶**. Each time you press **◀** or **▶**, the value is changed in increments of 0.05 MHz.

### Colour System

Select the optimum colour system to receive ("Auto", "PAL", "SECAM", "NTSC") (only for analogue channels).

### Sound System

Select the optimum sound systems (Broadcasting systems) to receive ("B/G", "A2 B/G", "D/K", "A2 D/K", "A2 D/K1", "I", "L", "L1") (only for analogue channels).

## Channel Skip

Channels with a **✓** mark are passed over when pressing **P▲/▼** on the TV or remote control unit.

- ① Press **▲/▼** to select the desired channel.
- ② Press **OK** to set a **✓** mark at the channel that you want to skip.

## Channel Sort

The item position of channels can be sorted.

- ① Press **▲/▼** to select the channel whose item position you want to move, and then press **OK**.

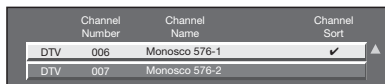

Channel Number	Channel Name	Channel Sort
DTV 006	Monosco 576-1	✓
DTV 007	Monosco 576-2	

- ② Press **▲/▼** to move it to the desired position, and then press **OK**.

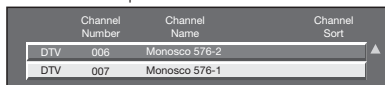

Channel Number	Channel Name	Channel Sort
DTV 006	Monosco 576-2	
DTV 007	Monosco 576-1	

- ③ Repeat steps 1 and 2 until all desired channel items are sorted.

## Decoder

When connecting a decoder to the TV, you need to select channels that need to be decoded.

## Channel Lock

When the channel is locked, you must enter your PIN whenever you tune to the channel.

### NOTE

- See "Child Lock" for setting a PIN.
- When "Channel Lock" is set for a channel, "Child lock has been activated" displays, and the image and sound of the channel are blocked.
- When pressing **RETURN** while "Child lock has been activated" displays, the PIN input window will display. Inputting the correct PIN unlocks the "Child Lock" temporarily until the power is turned off.

# Basic adjustment

## Password/Parental lock settings



### Setup

## Child Lock

Allows you to use a PIN to protect certain settings from being accidentally changed.

### NOTE

- PIN input is required when executing "Child Lock". The default PIN is "1234". To clear the PIN setting (PIN input will no longer be needed), refer to **CLEARING THE PIN** (Page 24).

### Change PIN

Register a four-digit password number to use the "Child Lock" function.

- 1 Enter the four-digit number as a PIN using 0–9 numeric buttons.
- 2 Enter the same four-digit number as in step 1 to confirm.

### NOTE

- To view a locked channel, you must enter the PIN (See page 21 for locking channels). When you select a locked channel, a PIN prompt message pops up. Press **RETURN** to display the PIN input window.

### Cancel PIN

Allows you to reset your PIN.

### NOTE

- As a precautionary measure, make a note of your PIN on the back of this operation manual, cut it out and keep it in a safe place that children cannot reach.

### Parental rating

This function allows DTV channels to be restricted. It prevents children from watching violent or sexual scenes that may be harmful.

### NOTE

- "Universal viewing" and "Parental approval pref." are ratings used exclusively in France.
- Refer to page 32 for details about ratings.

## Language Settings



### Setup

## Language

You can select an OSD language from the "Setup" menu. Select from among 23 languages. Refer to the **OSD language** column in the specification table for the selectable languages (Page 30).



### Digital Setup

## Subtitle

Set up to two preferred subtitle languages (including subtitles for the hearing impaired) to display if subtitles are available.

### Selectable items

- 1st Language
- 2nd Language
- For hearing impaired

### Switching subtitle languages

Each time you press  on the remote control unit, the subtitle switches.



### Set "For hearing impaired" to "Yes"

Subtitles for the hearing impaired have priority over each of the subtitle language settings (e.g., "1st Language", "2nd Language", etc.).

### EXAMPLE

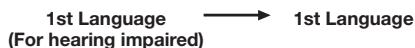

### NOTE

- Subtitles will not be displayed when the programme does not contain subtitle information.



### Option

## Digital Audio Language

Select the preferred language from "1st Digital Audio Language" ("2nd Digital Audio Language") to set up the first (second) priority language for digital audio. This setting is effective only when more than one audio language is available.

### Switching the multi audio languages

Each time you press  on the remote control unit, the audio language switches.

### NOTE

- You can set up to two preferred multi audio languages if the audio languages are available.



# Useful viewing functions

## Selecting the picture size

You can select the picture size. Selectable picture size varies with the type of signal received.

Item (for SD [Standard-Definition] signals)	
<b>Auto</b>	This mode allows the TV to switch automatically among the different picture sizes.
<b>Normal</b>	Keeps the original aspect ratio in a full screen display.
<b>Zoom 14:9</b>	For 14:9 letterbox pictures. A thin side bar appears on each side, and you may also see bars on the top and bottom with some programmes.
<b>Panorama</b>	In this mode, the picture is stretched toward each side of the screen. The picture may appear similar to "Full" depending on broadcast signals.
<b>Full</b>	For 16:9 squeeze pictures.
<b>Cinema 16:9</b>	For 16:9 letterbox pictures. Bars may appear on the top and bottom with some programmes.
<b>Cinema 14:9</b>	For 14:9 letterbox pictures. Bars may appear on the top and bottom with some programmes.

Item (for HD [High-Definition] signals)	
<b>Auto</b>	This mode allows the TV to switch automatically among the different picture sizes.
<b>Full</b>	Displays with an Overscan image. Crops all sides of screen.
<b>Underscan</b>	Displays with an Underscan image. Displays with the High-Definition image adjusted optimally. Noise may appear on the edge of the screen with some programmes.
<b>Dot by Dot</b>	Displays an image with the same number of pixels on the screen.

### NOTE

- Some items do not appear depending on the type of received signal.

- Press **[F4]**.
  - The "WIDE MODE" menu displays.
  - The menu lists the "WIDE MODE" options selectable for the type of video signal currently received.
- Press **[F4]** or **▲/▼** while the "WIDE MODE" menu displays on the screen.
  - As you toggle the options, each is immediately reflected on the screen. There is no need to press **OK**.

Basically, if you set "Auto" in the "WIDE MODE" menu, the optimum "WIDE MODE" is automatically chosen for every broadcast or programme played using a VCR or DVD player/recorder.

## Display Settings

### Channel display

You can display the channel information by pressing **[F1]** on the remote control unit.

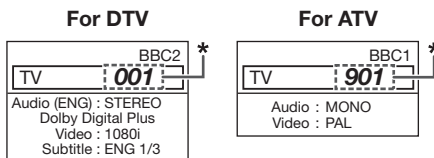

- \* Four digit numbers (e.g., 0001) are displayed after selecting the five Nordic countries in the country setting.

### Time display in channel information

You can display the time information included in DTV and teletext broadcasts.

- Select a TV channel.
- Press **[F1]**. The channel display will appear on the TV.
  - Each time you press **[F1]**, the display format of the time display and the channel information switches.

### Time and Title display

**Option**

**Programme Title Display**

This function allows you to display programme information such as the title and airtime by tuning a channel.

**Digital Setup**

**Time Zone**

Set up the proper time zone in your area.

# Other useful features

## Setting when using external devices

### Input source settings

#### Setup Input Label

You can label each input source with a custom description.

- 1 Press to select the desired input source.
- 2 Go to "MENU" > "Setup" > "Input Label".
- 3 Press /// to select each character of the new name for the input source, and then press **OK**.

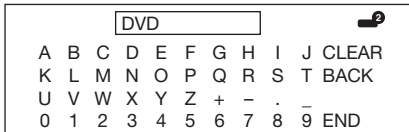

- 4 Repeat until the label is fully spelt out.

#### NOTE

- The label can be six characters or less.
- When you want to set an input source label of less than six characters, select "END" to set the name.

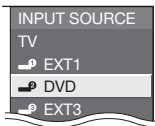

#### NOTE

- You cannot change labels if the input source is "TV".

### Skipping specified inputs

#### Setup Input Skip

This setting allows you to set the input source you want to skip during "INPUT SOURCE" selection operations.



## Reset

#### Setup Reset

If complex adjustments are made so that the settings cannot be restored to normal, you can reset the settings to the factory preset values.

- 1 Go to "MENU" > "Setup" > "Reset".
- 2 Press / to select "Yes", and then press **OK**.
  - After the reset has completed, the power shuts off and then comes back on. The screen will have returned to its original settings.

#### NOTE

- PIN input is required when executing "Reset". The default PIN is "1234". To change the PIN setting, refer to **Password/Parental lock settings** (Page 22). To clear the PIN setting (PIN input will no longer be needed), refer to **CLEARING THE PIN** (Page 24).

## Identification

#### Setup Identification

You can check the TV ID on the screen for reporting to customer service.

## Software update

If you use DVB-T, the TV automatically receives the update service and updates new software. When a confirmation message is received about the software update on the screen, follow the screen prompts.

#### CAUTION

- Do not disconnect the AC cord when the software update is in progress. If you have the problem, ask qualified service personnel.

## CLEARING THE PIN

If you lose or forget your PIN, you can clear the PIN following these steps.

- 1 Go to "MENU" > "Setup" > "Child Lock".
- 2 Enter the four-digit number on page 32 to clear your PIN.

#### NOTE

- As a precautionary measure, make a note of your PIN on the back of this operation manual, cut it out and keep it in a safe place that children cannot reach.

# Connecting a PC

## Connecting a PC

### HDMI Connection



- 1 HDMI-certified cable

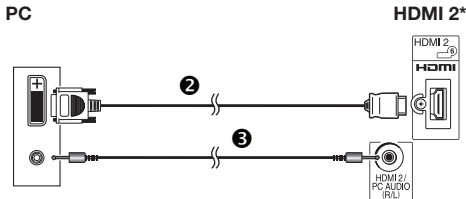

- 2 DVI/HDMI cable  
3 ø 3.5 mm stereo minijack cable

\* When using the HDMI 2 terminal, you must select the proper item in the "PC Audio Select" menu depending on the type of HDMI cable connected (Refer to page 19 for details).

### Analogue Connection

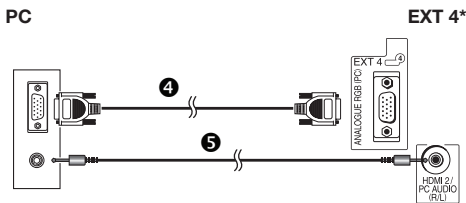

- 4 RGB cable  
5 ø 3.5 mm stereo minijack cable

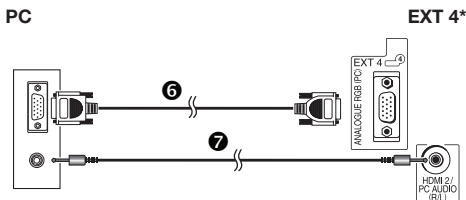

- 6 DVI/RGB conversion cable  
7 ø 3.5 mm stereo minijack cable

\* When using the EXT 4 terminal, you must select "EXT 4 (RGB)" in the "PC Audio Select" menu (Refer to page 19 for details).

### NOTE

- The PC input terminals are DDC1/2B-compatible.
- Refer to page 30 for a list of PC signals compatible with the TV.
- When connecting to a PC, the input signal type is automatically detected.

## Displaying a PC image on the screen

### Selecting the picture size

You can select the picture size.

- Press **[+]**.
  - The "WIDE MODE" menu displays.
- Press **[+]** or **[▲/▼]** to select a desired item.

### EXAMPLE

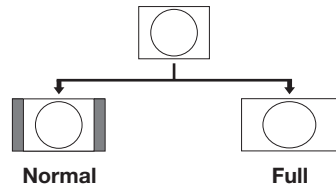

Item	
Full	An image fully fills the screen.
Cinema	For letterbox pictures. Bars may appear on the top and bottom with some programmes.
Normal	Keeps the original aspect ratio in a full screen display.
Dot by Dot	Displays an image with the same number of pixels on the screen.

### NOTE

- Connect the PC before making adjustments.
  - Selectable picture size may vary with input signal type.
  - Refer to page 23 for AV signals.
- HDMI: 480i/480p/576i/576p/720p/1080i/1080p  
ANALOGUE RGB: 576p/720p (60 Hz)/1080i/1080p

## Connecting a PC

### Adjusting the PC image automatically

This function enables the screen to be automatically adjusted to its best possible condition when the analogue terminals of the TV and PC are connected with a commercially available DVI/RGB conversion cable, etc.



Setup

### Auto Sync.

#### NOTE

- "Auto Sync." may fail if the PC image has low resolution, has unclear (black) edges, or is moved while executing "Auto Sync."
- Be sure to connect the PC to the TV and switch it on before starting "Auto Sync."
- "Auto Sync." can be executed only when inputting analogue signals through the EXT 4 terminal.

### Adjusting the PC image manually

Ordinarily you can easily adjust the picture as necessary to change image position using "Auto Sync.". In some cases, however, manual adjustment is needed to optimise the image.



Setup

### Fine Sync.

- 1 Press **▲/▼** to select the specific adjustment item.
- 2 Press **◀/▶** to adjust the item to the desired position.

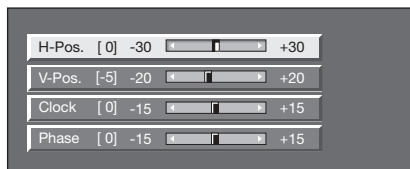

Item	
<b>H-Pos.</b>	Centres the image by moving it to the left or right.
<b>V-Pos.</b>	Centres the image by moving it up or down.
<b>Clock</b>	Adjusts when the image flickers with vertical stripes.
<b>Phase</b>	Adjusts when characters have low contrast or when the image flickers.

#### NOTE

- For resetting all adjustment items to the factory preset values, press **▲/▼** to select "Reset", and then press **OK**.
- "Clock" and "Phase" in the "Fine Sync." menu can be adjusted only when inputting analogue signals through the EXT 4 terminal.

# Connecting a PC

## RS-232C port specifications

### PC Control of the TV

- When a programme is set, the TV can be controlled from the PC using the RS-232C terminal. The input signal (PC/video) can be selected, the volume can be adjusted and various other adjustments and settings can be made, enabling automatic programmed playing.
- Use an RS-232C serial control cable (cross type) (commercially available) for the connections.

### NOTE

- This operation system should be used by a person who is accustomed to using PCs.



RS-232C serial control cable (cross type)

### Communication conditions

Set the RS-232C communications settings on the PC to match the TV's communications conditions. The TV's communications settings are as follows:

<b>Baud rate:</b>	9,600 bps
<b>Data length:</b>	8 bits
<b>Parity bit:</b>	None
<b>Stop bit:</b>	1 bit
<b>Flow control:</b>	None

### Communication procedure

Send the control commands from the PC via the RS-232C connector.

The TV operates according to the received command and sends a response message to the PC.

Do not send multiple commands at the same time. Wait until the PC receives the OK response before sending the next command.

Make sure to send "A" with the carriage return and confirm that "ERR" returns before operating.

### Command format

Eight ASCII codes +CR

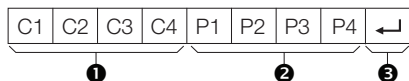

- ① Command four digits: Command. The text of four characters.
- ② Parameter four digits: Parameter 0–9, blank, ?, minus
- ③ Return code (ODH): ↵

### Parameter

Input the parameter values, aligning left, and fill with blank(s) for the remainder (Be sure that four values are input for the parameter).

When the input parameter is not within an adjustable range, "ERR" returns (Refer to "Response code format").

0			
---	--	--	--

0	0	0	9
---	---	---	---

1	0	0	
---	---	---	--

0	0	5	5
---	---	---	---

When "?" is input for some commands, the present setting value responds.

?	?	?	?
---	---	---	---

### Response code format

Normal response

O	K	↵
---	---	---

Return code (ODH)

Problem response (communication error or incorrect command)

E	R	R	↵
---	---	---	---

Return code (ODH)

# Connecting a PC

## PC compatibility chart

Resolution		Horizontal Frequency	Vertical Frequency	Analogue (D-Sub)	Digital (HDMI)	VESA Standard
VGA	640 x 480	31.5 kHz	60 Hz	✓	✓	✓
SVGA	800 x 600	37.9 kHz	60 Hz	✓	✓	✓
XGA	1,024 x 768	48.4 kHz	60 Hz	✓	✓	✓
WXGA	1,280 x 768	47.7 kHz	60 Hz	✓	✓	✓
WXGA	1,360 x 768	47.7 kHz	60 Hz	✓	✓	✓
SXGA	1,280 x 1,024	64.0 kHz	60 Hz	✓	✓	✓
SXGA+	1,400 x 1,050	65.3 kHz	60 Hz	✓	✓	✓

VGA, SVGA, XGA, WXGA, SXGA and SXGA+ are registered trademarks of International Business Machines Corporation.

### NOTE

- This TV has only limited PC compatibility, correct operation can only be guaranteed if the video card conforms exactly to the VESA 60 Hz standard. Any variations from this standard will result in picture distortions.

## RS-232C command list

CONTROL ITEM	COMMAND	PARAMETER	CONTROL CONTENTS
POWER SETTING	P O W R 0	_ _ _	POWER OFF
INPUT SELECTION A	I T G D	_ _ _	INPUT SWITCHING (TOGGLE)
	I T V D	_ _ _	TV (CHANNEL FIXED)
	I A V D *	_ _ _	EXT 1-4, 8 (1-4, 8), HDMI 1-3 (5-7)
CHANNEL	D C C H * * *	_ _ _	THREE DIGIT DIRECT CHANNEL (1-999) (Non-Nordic countries)
	D C C H * * *	_ _ _	FOUR DIGIT DIRECT CHANNEL (1-9999) (Nordic countries only)
	D C C H ? ? ?		Reply current TV channel number
	C H U P	_ _ _	CHANNEL UP
	C H D W	_ _ _	CHANNEL DOWN
AV MODE SELECTION	A V M D 0	_ _ _	TOGGLE
	A V M D 1	_ _ _	STANDARD
	A V M D 2	_ _ _	MOVIE
	A V M D 3	_ _ _	GAME
	A V M D 4	_ _ _	USER
	A V M D 5	_ _ _	DYNAMIC (Fixed)
	A V M D 6	_ _ _	DYNAMIC
	A V M D 7	_ _ _	PC
	A V M D ? ? ?		1-7
	VOLUME	V O L M * *	_ _
AUDIO CHANGE	A C H A	_ _ _	TOGGLE

CONTROL ITEM	COMMAND	PARAMETER	CONTROL CONTENTS
WIDE MODE	W I D E 0	_ _ _	TOGGLE (AV)
	W I D E 1	_ _ _	NORMAL (AV)
	W I D E 2	_ _ _	ZOOM 14:9 (AV)
	W I D E 3	_ _ _	PANORAMA (AV)
	W I D E 4	_ _ _	FULL (AV)
	W I D E 5	_ _ _	CINEMA 16:9 (AV)
	W I D E 6	_ _ _	CINEMA 14:9 (AV)
MUTE	M U T E 0	_ _ _	TOGGLE
	M U T E 1	_ _ _	MUTE ON
	M U T E 2	_ _ _	MUTE OFF
SURROUND	A C S U 0	_ _ _	SURROUND TOGGLE
	A C S U 1	_ _ _	SURROUND ON
	A C S U 2	_ _ _	SURROUND OFF
SLEEP TIMER	O F T M 0	_ _ _	OFF
	O F T M 1	_ _ _	SLEEP TIMER 30 MIN
	O F T M 2	_ _ _	SLEEP TIMER 1 HOUR
	O F T M 3	_ _ _	SLEEP TIMER 1 HOUR 30 MIN
	O F T M 4	_ _ _	SLEEP TIMER 2 HOUR
	O F T M 5	_ _ _	SLEEP TIMER 2 HOUR 30 MIN
TEXT	T E X T 0	_ _ _	TEXT OFF
	T E X T 1	_ _ _	TEXT ON (TOGGLE)
	D C P G * * *		DIRECT PAGE JUMP (100-899)

# Appendix

## Troubleshooting

Problem	Possible Solution
<ul style="list-style-type: none"><li>No power.</li></ul>	<ul style="list-style-type: none"><li>Check if you pressed <b>⏻</b> on the remote control unit. If the indicator on the TV lights up red, press <b>⏻</b>.</li><li>Is the AC cord disconnected?</li><li>Check if you pressed <b>⏻</b> on the TV.</li></ul>
<ul style="list-style-type: none"><li>The TV cannot be operated.</li></ul>	<ul style="list-style-type: none"><li>External influences such as lightning, static electricity, etc., may cause improper operation. In this case, operate the TV after first turning off the power, or unplugging the AC cord and re-plugging it in after one or two minutes.</li></ul>
<ul style="list-style-type: none"><li>Remote control unit does not operate.</li></ul>	<ul style="list-style-type: none"><li>Are batteries inserted with polarity (+, -) aligned?</li><li>Are batteries worn out? (Replace with new batteries.)</li><li>Are you using it under strong or fluorescent lighting?</li><li>Is a fluorescent light illuminating to the remote control sensor?</li></ul>
<ul style="list-style-type: none"><li>Picture is cut off.</li></ul>	<ul style="list-style-type: none"><li>Is the image position correct?</li><li>Are screen mode adjustments (WIDE MODE) such as picture size made correctly? (Pages 23 and 25)</li></ul>
<ul style="list-style-type: none"><li>Strange colour, light colour, or dark colour, or colour misalignment.</li></ul>	<ul style="list-style-type: none"><li>Adjust the picture tone.</li><li>Is the room too bright? The picture may look dark in a room that is too bright.</li><li>Check the "Colour System" setting (Page 21).</li></ul>
<ul style="list-style-type: none"><li>Power is suddenly turned off.</li></ul>	<ul style="list-style-type: none"><li>The TV's internal temperature has increased. Remove any objects blocking the vent or clean.</li><li>Is sleep timer set? Set to "Off" by pressing <b>SLEEP</b> on the remote control unit (Page 3).</li><li>Is "No Signal Off" or "No Operation Off" activated?</li></ul>
<ul style="list-style-type: none"><li>No picture.</li></ul>	<ul style="list-style-type: none"><li>Are connections to external equipment correct? (Pages 13–14)</li><li>Is the correct input source selected? (Page 10)</li><li>Is a non-compatible signal being input? (Page 2B)</li><li>Is the picture adjustment correct? (Pages 17–18)</li><li>Is the antenna connected properly? (Page 8)</li><li>Is "On" selected in "Audio Only"? (Page 19)</li></ul>
<ul style="list-style-type: none"><li>No sound.</li></ul>	<ul style="list-style-type: none"><li>Is the volume too low?</li><li>Make sure that headphones are not connected.</li><li>Check if you pressed <b>🔊</b> on the remote control unit.</li><li>Is the proper item selected in the "PC Audio Select" menu when connecting devices to the HDMI 2 terminal or the EXT 4 terminal? (Pages 13 and 19)</li></ul>
<ul style="list-style-type: none"><li>The TV sometimes makes a cracking sound.</li></ul>	<ul style="list-style-type: none"><li>This is not a malfunction. This happens when the cabinet slightly expands and contracts according to changes in temperature. This does not affect the TV's performance.</li></ul>

### Cautions regarding use in high and low temperature environments

- When the TV is used in a low temperature space (e.g., room, office), the picture may leave trails or appear slightly delayed. This is not a malfunction, and the TV will recover when the temperature returns to normal.
- Do not leave the TV in a hot or cold location. Also, do not leave the TV in a location exposed to direct sunlight or near a heater, as this may cause the cabinet to deform and the LCD panel to malfunction.  
Storage temperature: + 5 °C to + 35 °C.

### Information on the software license for this product

#### Software composition

The software included in this product is comprised of various software components whose individual copyrights are held by SHARP or by third parties.

#### Software developed by SHARP and open source software

The copyrights for the software components and various relevant documents included with this product that were developed or written by SHARP are owned by SHARP and are protected by the Copyright Act, international treaties, and other relevant laws. This product also makes use of freely distributed software and software components whose copyrights are held by third parties. These include software components covered by a BSD-like License or other license agreement.

We are unable to answer any questions about the source code for the open source software. The source code for the software components whose copyrights are held by SHARP is not distributed.

#### Acknowledgements

The following open source software components are included in this product:

- Freetype • unicode • Teletext font • libpng • zlib

# Appendix

## Specifications

Item		LCD COLOUR TV (32"), LC-32DH57E, LC-32DH57S	
LCD panel		Advanced Super View & BLACK TFT LCD (32")	
Resolution		1,049,680 pixels (1,366 x 768)	
Video Colour System		PAL/SECAM/NTSC 3.58/NTSC 4.43/PAL 60	
TV Function	TV-Standard	Analogue	CCIR (B/G, I, D/K, L/L')
		Digital	DVB-T (2K/8K OFDM)
	Receiving Channel	VHF/UHF	IR A ch–E69 ch (Digital), E2–E69 ch, F2–F10 ch, I21–I69 ch, IR A–IR J ch
		CATV	Hyper-band, S1–S41 ch
	TV-Tuning System	Auto Preset 999 ch (non-Nordic [DTV]), Auto Preset 9999 ch (Nordic [DTV]), Auto Preset 99 ch (ATV), Auto Label, Auto Sort	
STEREO/BILINGUAL		NICAM/A2	
Viewing angles		176 ° (H), 176 ° (V)	
Audio amplifier		10 W x 2	
Speaker		(35 mm x 100 mm) x 2	
Terminals	Antenna	UHF/VHF 75 Ω Din type (Analogue & Digital)	
	RS-232C	D-Sub 9 pin male connector	
	EXT 1	SCART (AV input, Y/C input, RGB input, TV output)	
	EXT 2	SCART (AV input/monitor output, Y/C input)	
	EXT 3	COMPONENT IN (Y/P <sub>r</sub> (C <sub>r</sub> )/P <sub>b</sub> (C <sub>b</sub> ), RCA pin (AUDIO R/L))	
	EXT 4	15 pin mini D-sub	
	HDMI 1 (EXT 5)	HDMI	
	HDMI 2 (EXT 6)	HDMI	
	HDMI 3 (EXT 7)	HDMI	
	EXT 8	RCA pin (AV input)	
	SERVICE	USB	
	HDMI 2/PC AUDIO (R/L)	Ø 3.5 mm jack*	
	DIGITAL AUDIO OUTPUT	Optical Digital audio output	
	C. I. (Common Interface)	EN50221, R206001	
OUTPUT	RCA pin (AUDIO R/L)		
Headphones	Ø 3.5 mm jack (Audio output)		
OSD language		Czech, Danish, Dutch, English, Estonian, Finnish, French, German, Greek, Hungarian, Italian, Latvian, Lithuanian, Norwegian, Polish, Portuguese, Russian, Slovak, Slovene, Spanish, Swedish, Turkish, Ukrainian	
Power Requirement		AC 220–240 V, 50 Hz	
Power Consumption (Method IEC62087)		90 W (0.6 W Standby)	
Weight		10.5 kg (Without stand), 11.5 kg (With stand)	
Operating temperature		0 °C to + 40 °C	

- \* The HDMI 2 and EXT 4 terminals can both use the same audio input terminal.
- As a part of our policy of continuous improvement, SHARP reserves the right to make design and specification changes for product improvement without prior notice. The performance specification figures indicated are nominal values of production units. There may be some deviations from these values in individual units.

### NOTE

- Refer to the inside back cover for dimensional drawings.



## End of life disposal



Attention: Your product is marked with this symbol. It means that used electrical and electronic products should not be mixed with general household waste. There is a separate collection system for these products.

### A. Information on Disposal for Users (private households)

#### 1. In the European Union

Attention: If you want to dispose of this equipment, please do not use the ordinary dust bin!

Used electrical and electronic equipment must be treated separately and in accordance with legislation that requires proper treatment, recovery and recycling of used electrical and electronic equipment. Following the implementation by member states, private households within the EU states may return their used electrical and electronic equipment to designated collection facilities free of charge\*. In some countries\* your local retailer may also take back your old product free of charge if you purchase a similar new one. \*) Please contact your local authority for further details.

If your used electrical or electronic equipment has batteries or accumulators, please dispose of these separately beforehand according to local requirements.

By disposing of this product correctly you will help ensure that the waste undergoes the necessary treatment, recovery and recycling and thus prevent potential negative effects on the environment and human health which could otherwise arise due to inappropriate waste handling.

#### 2. In other Countries outside the EU

If you wish to discard this product, please contact your local authorities and ask for the correct method of disposal.

For Switzerland: Used electrical or electronic equipment can be returned free of charge to the dealer, even if you don't purchase a new product. Further collection facilities are listed on the homepage of [www.swico.ch](http://www.swico.ch) or [www.sens.ch](http://www.sens.ch).

### B. Information on Disposal for Business Users

#### 1. In the European Union

If the product is used for business purposes and you want to discard it:

Please contact your SHARP dealer who will inform you about the take-back of the product. You might be charged for the costs arising from take-back and recycling. Small products (and small amounts) might be taken back by your local collection facilities.

For Spain: Please contact the established collection system or your local authority for take-back of your used products.

#### 2. In other Countries outside the EU

If you wish to discard of this product, please contact your local authorities and ask for the correct method of disposal.



Pb

The battery supplied with this product contains traces of Lead.

For EU: The crossed-out wheeled bin implies that used batteries should not be put to the general household waste! There is a separate collection system for used batteries, to allow proper treatment and recycling in accordance with legislation. Please contact your local authority for details on the collection and recycling schemes.

For Switzerland: The used battery is to be returned to the selling point.

For other non-EU countries: Please contact your local authority for correct method of disposal of the used battery.

# Appendix

## Rating table for Child Lock

User-adjusted rating	Broadcasted rating															
	AGE															
	4	5	6	7	8	9	10	11	12	13	14	15	16	17	18	
Universal viewing	✓	–	–	–	–	–	–	–	–	–	–	–	–	–	–	
Parental approval pref.	✓	✓	✓	✓	✓	–	–	–	–	–	–	–	–	–		
X-rated	✓	✓	✓	✓	✓	✓	✓	✓	✓	✓	✓	✓	✓	✓		

User-adjusted rating	Broadcasted rating		
	Universal viewing	Parental approval pref.	X-rated
Universal viewing	–	–	–
Parental approval pref.	✓	–	–
X-rated	✓	✓	–

## Abbreviation list

Abbreviated term	Stands for
ATV	Analogue TV
DNR	Digital Noise Reduction
DTV	Digital TV
DVB-T	Digital Video Broadcasting-Terrestrial
DVI	Digital Visual Interface
EPG	Electronic Programme Guide
HDCP	High-bandwidth Digital Content Protection
HDMI	High-Definition Multimedia Interface
MHEG	Multimedia and Hypermedia Expert Group
OSD	On Screen Display
PCM	Pulse Code Modulation
USB	Universal Serial Bus



- 1 Go to “MENU” > “Setup” > “Child Lock” (Page 22).
- 2 Enter “3001” to cancel out the current PIN.
  - The current PIN clears.

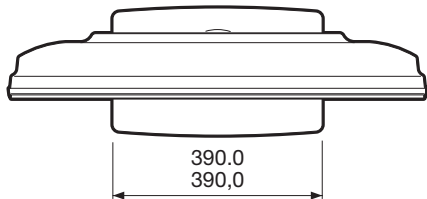

390.0  
390.0

791.0  
791.0

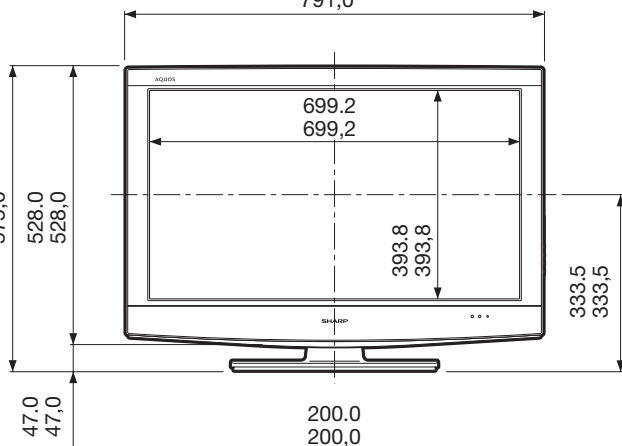

575.0  
575.0

528.0  
528.0

47.0  
47.0

200.0  
200.0

699.2  
699.2

393.8  
393.8

333.5  
333.5

66.2  
66.2

123.5  
123.5

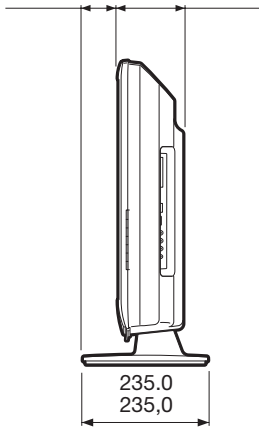

235.0  
235.0

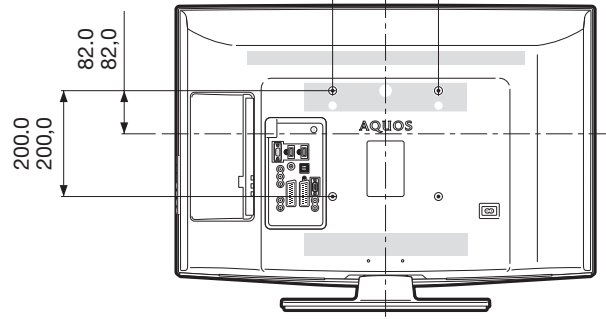

200.0  
200.0

82.0  
82.0

200.0  
200.0

AQUOS

# SHARP®

SHARP ELECTRONICS (Europe) GmbH

Sonninstraße 3, D-20097 Hamburg

SHARP CORPORATION

Printed in Poland  
Gedruckt in Polen  
Imprimé en Pologne  
Stampato in Polonia  
Gedruckt in Polen  
Impreso en Polonia  
Impresso na Polónia

TINS-E056WJZZ  
09P04-PL-NG

PIN

--	--	--	--