



Features and Design

This Multimedia Projector is designed with the most advanced technology for portability, durability, and ease of use. This projector utilizes built-in multimedia features, a palette of 16.77 million colors, and matrix liquid crystal display (LCD) technology.

◆ **Large Screen in Limited Space**

Short focus lens allows you to project large images from short distance (p.14).

◆ **Antitheft Alarm Function**

This projector is equipped with an Antitheft alarm function which sounds when a vibration is detected. (pp.50 – 52).

◆ **Security Features**

The Security function helps you to ensure security of the projector. With the Key lock function, you can lock the operation on the top control or remote control (p.47). PIN code lock functions prevents unauthorized use of the projector (pp.47–48).

◆ **Logo Function**

The Logo function allows you to customize the screen logo. The Logo page identifies the owner of the projector (pp.43, 44).

◆ **Compact Design**

This projector is designed to be compact in size and weight. It is easy to carry and work anywhere you want to use.

◆ **Simple Computer System Setting**

The projector has a Multi-scan system to conform to almost all computer output signals quickly (p.27).

◆ **Compatibility**

The projector widely accepts various video and computer input signals including; Computers, 6 Color systems (PAL, SECAM, NTSC, NTSC4.43, PAL-M, or PAL-N), Component video, S-Video and RGB scart.

◆ **Quick Termination**

The AC power cord can be unplugged immediately after turning off the projector without waiting for the projector to cool down (p.20).

◆ **Digital Zoom (for Computer)**

The digital zoom function allows you to focus on crucial information during a presentation. You can expand the images approx. 16 times the screen size and compress them to approximately a quarter of the screen size (p.34).

◆ **Blackboard Function**

A blackboard can be used as a projection screen. (pp.31, 38)

*The board color is limited to Green.

◆ **Multilanguage Menu Display**

The Operation menu is available in 16 languages: English, German, French, Italian, Spanish, Portuguese, Dutch, Swedish, Finnish, Polish, Hungarian, Romanian, Russian, Chinese, Korean, and Japanese (p.42).

◆ **Switchable Interface Terminal**

The projector provides a switchable interface terminal. You can use the terminal as computer input or monitor output conveniently (p.45).

◆ **Power Management**

The Power management function reduces power consumption and maintains lamp life (p.45).

✓ **Notes:**

- The On-Screen Menu and figures in this manual may differ slightly from the product.
- The contents of this manual are subject to change without notice.

Table of Contents

Features and Design	2	Computer Input	26
Table of Contents	3	Input Source Selection	26
To the Owner	4	Computer System Selection	27
Safety Instructions	5	Auto PC Adjustment	28
Air Circulation	6	Manual PC Adjustment	29
Installing the Projector in Proper Position	6	Image Level Selection	31
Moving the Projector	6	Image Level Adjustment	32
Compliance	7	Screen Size Adjustment	33
Part Names and Functions	8	Video Input	35
Front	8	Input Source Selection (Video, S-Video)	35
Back	8	Input Source Selection	
Bottom	8	(Component, RGB Scart 21-pin)	36
Rear Terminal	9	Video System Selection	37
Top Control	10	Image Level Selection	38
Antitheft Alarm Setting Buttons	11	Image Level Adjustment	39
Remote Control	12	Screen Size Adjustment	41
Remote Control Battery Installation	13	Setting	42
Operating Range	13	Setting	42
Installation	14	Antitheft Alarm function	50
Positioning the Projector	14	How to Use the Antitheft Alarm Function	50
Adjustable Feet	14	Maintenance and Cleaning	53
Connecting the AC Power Cord	15	Warning Indicator	53
Connecting to a Computer	16	Cleaning the Air Filters	54
Connecting to Video Equipment	17	Attaching the Lens Cover	54
Connecting to Component Video Equipment	18	Cleaning the Projection Lens	55
Basic Operation	19	Cleaning the Projector Cabinet	55
Turning On the Projector	19	Lamp Replacement	56
Turning Off the Projector	20	Lamp Replacement Counter	57
How to Operate the On-Screen Menu	21	Appendix	58
Menu Bar	22	Troubleshooting	58
Focus Adjustment	23	Menu Tree	60
Keystone Correction	23	Indicators and Projector Condition	62
Sound Adjustment	24	Compatible Computer Specifications	63
Remote Control Operation	24	Technical Specifications	64
		Optional Parts	65
		Configurations of Terminals	66
		PIN Code Label	67

Trademarks

Each name of corporations or products in this book is either a registered trademark or a trademark of its respective corporation.





To the Owner

Before operating this projector, read this manual thoroughly and operate the projector properly.

This projector provides many convenient features and functions. Operating the projector properly enables you to manage those features and maintain it in good condition for many years to come.

Improper operation may result in not only shortening the product life, but also malfunctions, fire hazard, or other accidents.

If your projector seems to operate improperly, read this manual again, check operations and cable connections, and try the solutions in the "Troubleshooting" section in the back of this manual. If the problem still persists, contact the dealer where you purchased the projector or the service center.

	CAUTION RISK OF ELECTRIC SHOCK DO NOT OPEN	
CAUTION: TO REDUCE THE RISK OF ELECTRIC SHOCK, DO NOT REMOVE COVER (OR BACK). NO USER-SERVICEABLE PARTS INSIDE EXCEPT LAMP REPLACEMENT. REFER SERVICING TO QUALIFIED SERVICE PERSONNEL.		
	THIS SYMBOL INDICATES THAT DANGEROUS VOLTAGE CONSTITUTING A RISK OF ELECTRIC SHOCK IS PRESENT WITHIN THIS UNIT.	
	THIS SYMBOL INDICATES THAT THERE ARE IMPORTANT OPERATING AND MAINTENANCE INSTRUCTIONS IN THE OWNER'S MANUAL WITH THIS UNIT.	

NOTE: This symbol and recycle system are applied only to EU countries and not applied to the countries in the other area of the world.



Your SANYO product is designed and manufactured with high quality materials and components which can be recycled and reused.

This symbol means that electrical and electronic equipment, at their end-of-life, should be disposed of separately from your household waste.

Please dispose of this equipment at your local community waste collection/recycling centre.

In the European Union there are separate collection systems for used electrical and electronic products.

Please help us to conserve the environment we live in!

Safety Precaution

WARNING: TO REDUCE THE RISK OF FIRE OR ELECTRIC SHOCK, DO NOT EXPOSE THIS APPLIANCE TO RAIN OR MOISTURE.

- This projector produces intense light from the projection lens. Avoid staring directly into the lens as much as possible, otherwise eye damage could result. Be especially careful that children do not stare directly into the beam.
- Install the projector in a proper position. Otherwise it may result in fire hazard.
- Allowing the proper amount of space on the top, sides, and rear of the projector cabinet is critical for proper air circulation and cooling of the unit. The dimensions shown here indicate the minimum space required. If the projector is to be built into a compartment or similarly enclosed, these minimum distances must be maintained.
- Do not cover the ventilation slot on the projector. Heat build-up can reduce the service life of your projector, and can also be dangerous.

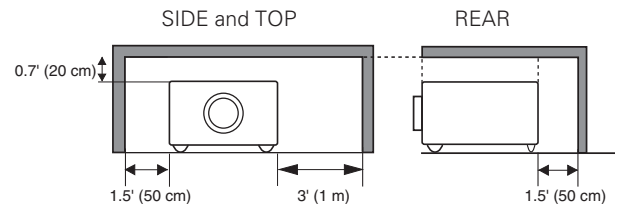

- If the projector is unused for an extended time, unplug the projector from the power outlet.

CAUTION ON HANGING FROM THE CEILING

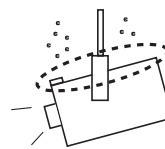

When hanging the projector from the ceiling, clean the air intake vents, air filters, and the top of the projector periodically with a vacuum cleaner. If you leave the projector unclean for a long time, the cooling fans can be clogged with dust, and it may cause a breakdown or a disaster.

DO NOT SET THE PROJECTOR IN GREASY, WET, OR SMOKY CONDITIONS SUCH AS IN A KITCHEN TO PREVENT A BREAKDOWN OR DISASTER. IF THE PROJECTOR COMES IN CONTACT WITH OIL OR CHEMICALS, IT MAY BECOME DETERIORATED.

CAUTION

Not for use in a computer room as defined in the Standard for the Protection of Electronic Computer/Data Processing Equipment, ANSI/NFPA 75.

Ne peut être utilisé dans une salle d'ordinateurs telle que définie dans la norme ANSI/NFPA 75 Standard for Protection of Electronic Computer/Data Processing Equipment.

READ AND KEEP THIS OWNER'S MANUAL FOR LATER USE.

Safety Instructions

All the safety and operating instructions should be read before the product is operated.

Read all of the instructions given here and retain them for later use. Unplug this projector from AC power supply before cleaning. Do not use liquid or aerosol cleaners. Use a damp cloth for cleaning.

Follow all warnings and instructions marked on the projector.

For added protection to the projector during a lightning storm, or when it is left unattended and unused for long periods of time, unplug it from the wall outlet. This will prevent damage due to lightning and power line surges.

Do not expose this unit to rain or use near water... for example, in a wet basement, near a swimming pool, etc...

Do not use attachments not recommended by the manufacturer as they may cause hazards.

Do not place this projector on an unstable cart, stand, or table. The projector may fall, causing serious injury to a child or adult, and serious damage to the projector. Use only with a cart or stand recommended by the manufacturer, or sold with the projector. Wall or shelf mounting should follow the manufacturer's instructions, and should use a mounting kit approved by the manufacturers.

An appliance and cart combination should be moved with care. Quick stops, excessive force, and uneven surfaces may cause the appliance and cart combination to overturn.



Slots and openings in the back and bottom of the cabinet are provided for ventilation, to ensure reliable operation of the equipment and to protect it from overheating.

The openings should never be covered with cloth or other materials, and the bottom opening should not be blocked by placing the projector on a bed, sofa, rug, or other similar surface. This projector should never be placed near or over a radiator or heat register.

This projector should not be placed in a built-in installation such as a book case unless proper ventilation is provided.

Never push objects of any kind into this projector through cabinet slots as they may touch dangerous voltage points or short out parts that could result in a fire or electric shock. Never spill liquid of any kind on the projector.

Do not install the projector near the ventilation duct of air-conditioning equipment.

This projector should be operated only from the type of power source indicated on the marking label. If you are not sure of the type of power supplied, consult your authorized dealer or local power company.

Do not overload wall outlets and extension cords as this can result in fire or electric shock. Do not allow anything to rest on the power cord. Do not locate this projector where the cord may be damaged by persons walking on it.

Do not attempt to service this projector yourself as opening or removing covers may expose you to dangerous voltage or other hazards. Refer all servicing to qualified service personnel.

Unplug this projector from wall outlet and refer servicing to qualified service personnel under the following conditions:

- When the power cord or plug is damaged or frayed.
- If liquid has been spilled into the projector.
- If the projector has been exposed to rain or water.
- If the projector does not operate normally by following the operating instructions. Adjust only those controls that are covered by the operating instructions as improper adjustment of other controls may result in damage and will often require extensive work by a qualified technician to restore the projector to normal operation.
- If the projector has been dropped or the cabinet has been damaged.
- When the projector exhibits a distinct change in performance-this indicates a need for service.

When replacement parts are required, be sure the service technician has used replacement parts specified by the manufacturer that have the same characteristics as the original part. Unauthorized substitutions may result in fire, electric shock, or injury to persons.

Upon completion of any service or repairs to this projector, ask the service technician to perform routine safety checks to determine that the projector is in safe operating condition.



Voor de klanten in Nederland

Bij dit produkt zijn batterijen geleverd. Wanneer deze leeg zijn, moet u ze niet weggooien maar inleveren als KCA.

Air Circulation

Openings in the cabinet are provided for ventilation. To ensure reliable operation of the product and to protect it from overheating, these openings must not be blocked or covered.

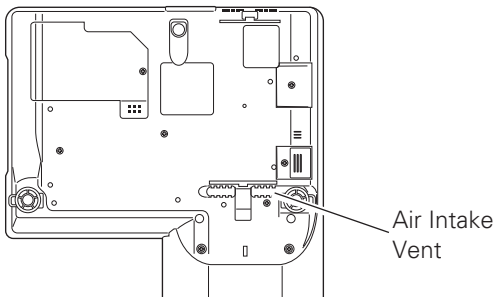
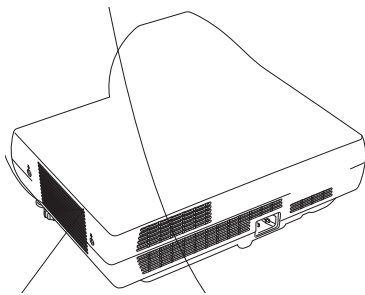
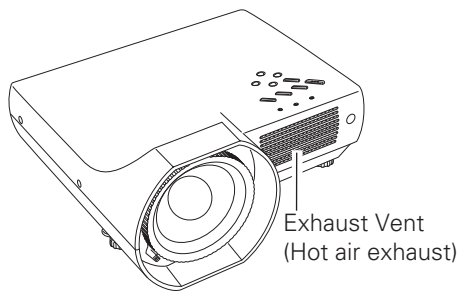

Installing the Projector in Proper Position

Install the projector properly. Improper Installation may reduce the lamp life and cause fire hazard.

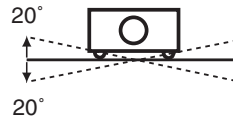

Do not tilt the projector more than 20 degrees from side to side.



Do not point the projector up to project an image.



Do not point the projector down to project an image.



Do not put the projector on either side to project an image.

Moving the Projector

When moving the projector, replace the lens cover and retract the adjustable feet to prevent damage to the lens and cabinet. When the projector is not in use for an extended period, put it into a suitable case.

Care must be taken when handling the projector; do not drop, bump, subject it to strong forces, or put other things on the cabinet.

Federal Communication Commission Notice

This equipment has been tested and found to comply with the limits for a Class B digital device, pursuant to Part 15 of the FCC Rules. These limits are designed to provide reasonable protection against harmful interference in a residential installation. This equipment generates, uses, and can radiate radio frequency energy. If it is not installed and used in accordance with the instructions, it may cause harmful interference to radio communications. However, there is no guarantee that interference will not occur in a particular installation. If this equipment does cause harmful interference to radio or television reception, which can be determined by turning the equipment off and on, the user is encouraged to try to correct the interference by one or more of the following measures:

- Reorient or relocate the receiving antenna.
- Increase the separation between the equipment and receiver.
- Connect the equipment into an outlet on a circuit different from that to which the receiver is connected.
- Consult the dealer or an experienced radio/TV technician for help.

Use of shielded cable is required to comply with Class B limits in Subpart B of Part 15 of FCC Rules.

Do not make any changes or modifications to the equipment unless otherwise specified in the instructions. If such changes or modifications should be made, you could be required to stop operation of the equipment.

Model Number(s) : PLC-XL40
Trade Name : Sanyo
Responsible party : SANYO FISHER COMPANY
Address : 21605 Plummer Street, Chatsworth, California 91311
Telephone No. : (818)998-7322

AC Power Cord Requirement

The AC Power Cord supplied with this projector meets the requirement for use in the country you purchased it.

AC Power Cord for the United States and Canada:

AC Power Cord used in the United States and Canada is listed by the Underwriters Laboratories (UL) and certified by the Canadian Standard Association (CSA).

AC Power Cord has a grounding-type AC line plug. This is a safety feature to be sure that the plug will fit into the power outlet. Do not try to defeat this safety feature. Should you be unable to insert the plug into the outlet, contact your electrician.

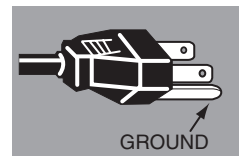

AC Power Cord for the United Kingdom:

This cord is already fitted with a moulded plug incorporating a fuse, the value of which is indicated on the pin face of the plug. Should the fuse need to be replaced, an ASTA approved BS 1362 fuse must be used of the same rating, marked thus \diamond . If the fuse cover is detachable, never use the plug with the cover omitted. If a replacement fuse cover is required, ensure it is of the same colour as that visible on the pin face of the plug (i.e. red or orange). Fuse covers are available from the Parts Department indicated in your User Instructions.

If the plug supplied is not suitable for your socket outlet, it should be cut off and destroyed.

The end of the flexible cord should be suitably prepared and the correct plug fitted.

WARNING: A PLUG WITH BARED FLEXIBLE CORD IS HAZARDOUS IF ENGAGED IN A LIVE SOCKET OUTLET.

The Wires in this mains lead are coloured in accordance with the following code:

Green-and-yellow Earth
Blue Neutral
Brown Live

As the colours of the wires in the mains lead of this apparatus may not correspond with the coloured markings identifying the terminals in your plug proceed as follows:

The wire which is coloured green-and-yellow must be connected to the terminal in the plug which is marked by the letter E or by the safety earth symbol \perp or coloured green or green-and-yellow.

The wire which is coloured blue must be connected to the terminal which is marked with the letter N or coloured black.

The wire which is coloured brown must be connected to the terminal which is marked with the letter L or coloured red.

WARNING: THIS APPARATUS MUST BE EARTHED.

THE SOCKET-OUTLET SHOULD BE INSTALLED NEAR THE EQUIPMENT AND EASILY ACCESSIBLE.

Part Names and Functions

Front

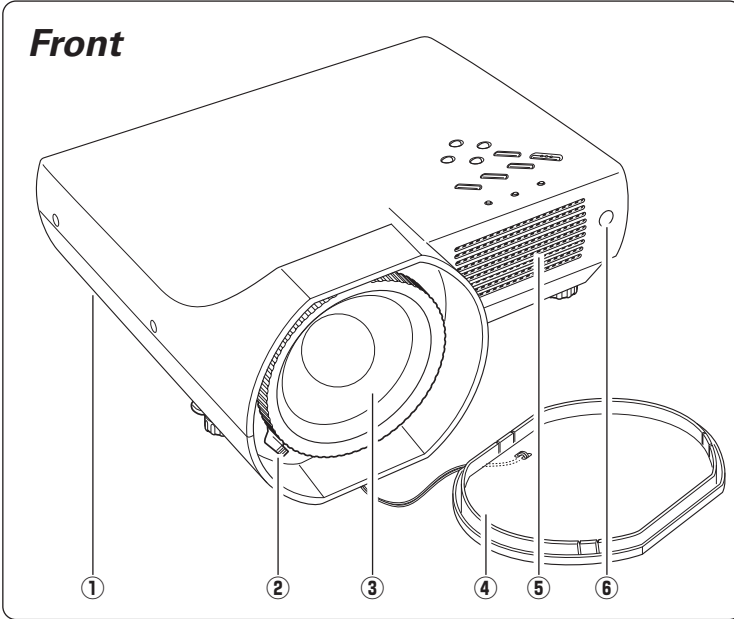

- ① Antitheft alarm setting buttons
- ② Focus Lever
- ③ Projection Lens
- ④ Lens Cover
(See page 54 for attaching.)

⚠ CAUTION

Do not turn on the projector with putting the lens cover on. The light beam may damage lens cover and result in fire hazard. Attach the lens cover while the projector is not in use to avoid scratching the lens surface.

- ⑤ Exhaust Vents

⚠ CAUTION

Hot air is exhausted from the exhaust vent. Do not put heat-sensitive objects near this side.

Back

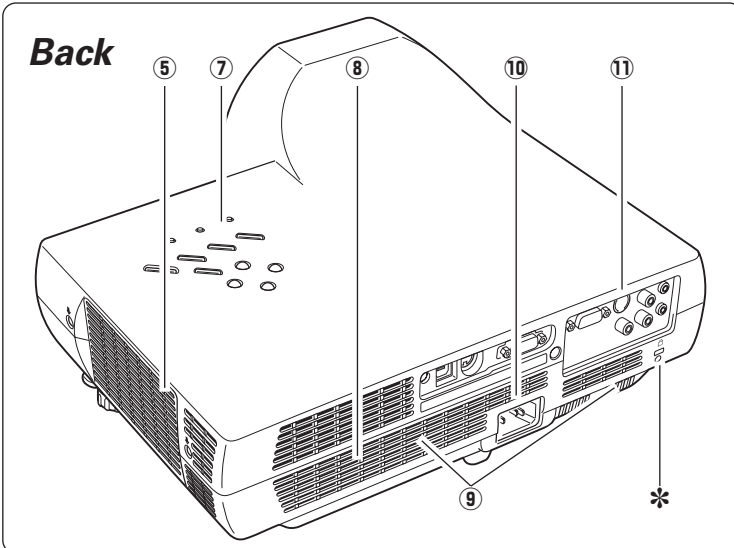

- ⑥ Infrared Remote Receiver

- ⑦ Top controls and Indicators

- ⑧ Speaker

- ⑨ Air Intake Vent

- ⑩ Power Cord Connector

- ⑪ Terminals and Connectors

- ⑫ Lamp Cover

- ⑬ Air Intake Vents

- ⑭ Air Filters

- ⑮ Battery Compartment
(For Antitheft alarm function)

- ⑯ Adjustable Feet

Bottom

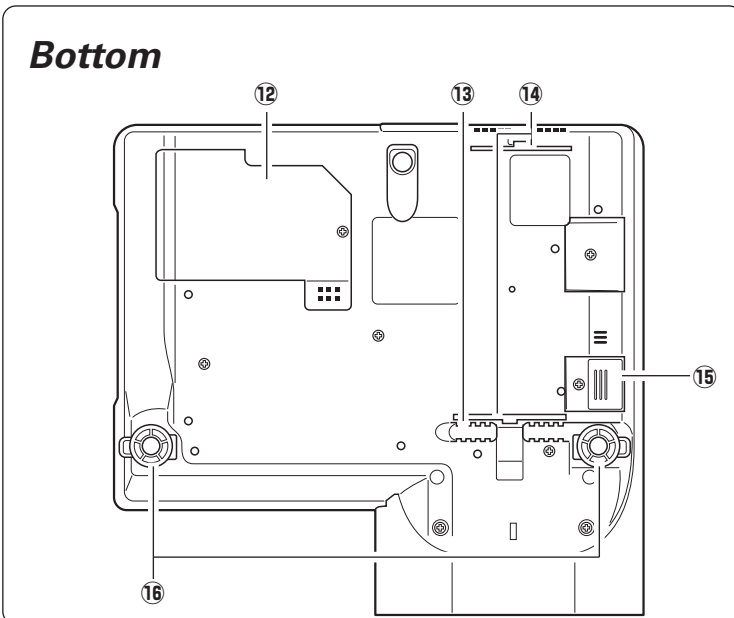

*Kensington Security Slot

This slot is for a Kensington lock used to deter theft of the projector.

*Kensington is a registered trademark of ACCO Brands Corporation.

Rear Terminal

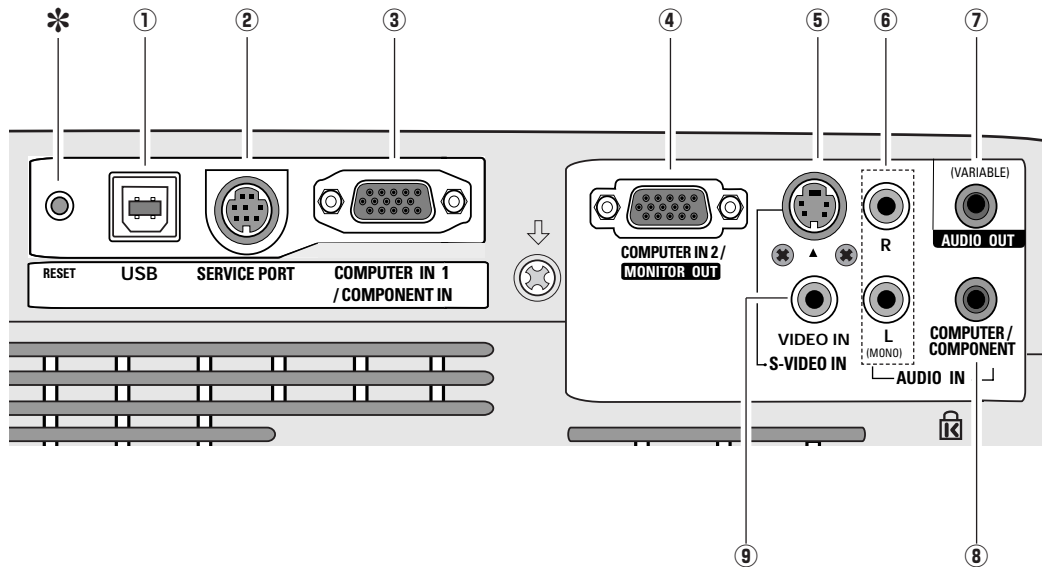

① USB (Series B)

In order to operate the computer with the remote control during a presentation, connect the USB port of the computer to the projector with a USB cable (not supplied) (p.16).

② SERVICE PORT

This jack is used to service the projector.

③ COMPUTER IN 1/COMPONENT IN

Connect output signal from a computer, RGB scart 21-pin video output, or component video output to this terminal (pp.16, 18).

When the cable is of the longer variety, it is advisable to use this terminal and not COMPUTER IN 2/MONITOR OUT.

④ COMPUTER IN 2/MONITOR OUT

This terminal is switchable and can be used for input from a computer or output to the other monitor.

Set the terminal up as either Computer input or Monitor output properly. [Used for Monitor out, this terminal outputs only incoming signal from COMPUTER IN 1/COMPONENT IN terminal (pp. 16, 45)].

⑤ S-VIDEO IN

Connect the S-VIDEO output from video equipment to this jack (p.17).

⑥ AUDIO IN

Connect the audio output from video equipment connected to ⑤ or ⑨ to this jack. [When the audio output is monaural, connect it to L (MONO) jack (p.17)].

⑦ AUDIO OUT(VARIABLE)

Connect an external audio amplifier to this jack (pp.16 – 18).

This terminal outputs sound from AUDIO IN terminal (⑥ or ⑧).

⑧ COMPUTER/COMPONENT AUDIO IN

Connect the audio output (stereo) from a computer or video equipment connected to ③ or ④ to this jack (pp.16, 18).

⑨ VIDEO IN

Connect the composite video output from video equipment to VIDEO jack (p.17).

* RESET button

A built-in micro processor which controls this unit may occasionally malfunction and need to be reset. Press the RESET button with a pen, then the projector shuts down and restarts. Do not use the RESET function excessively.

Top Control

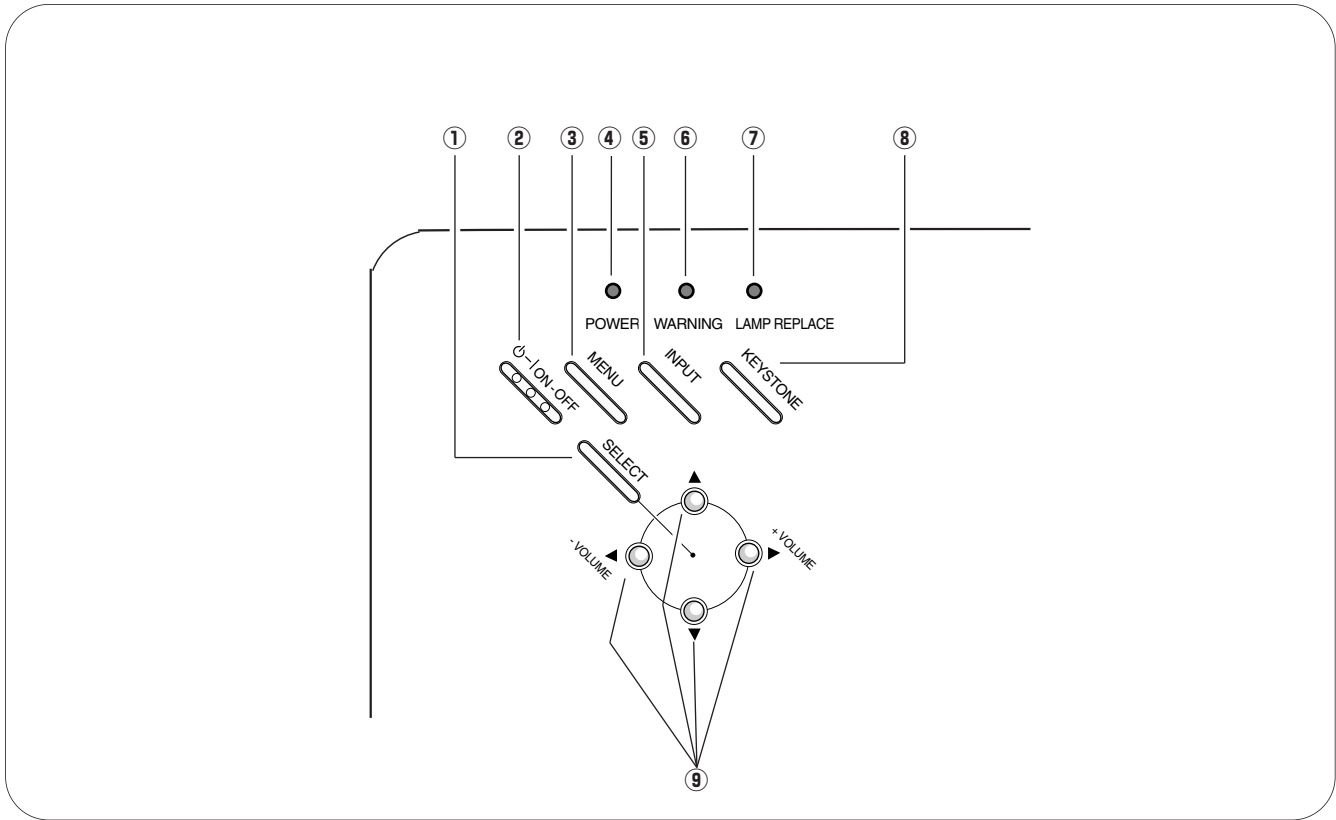

- ① **SELECT button**
 - Execute the selected item (p.21).
 - Expand or compress the image in Digital zoom mode (p.34).
- ② **POWER ON–OFF button**
 - Turn the projector on or off (pp.19–20).
- ③ **MENU button**
 - Open or close the On-Screen Menu (p.21).
- ④ **POWER indicator**
 - Lights red when the projector is in stand-by mode.
 - Lights green during operations.
 - Blinks green in the Power management mode (pp.45, 62).
- ⑤ **INPUT button**
 - Select input source (pp.26, 35, 36).
- ⑥ **WARNING indicator**
 - Lights red light when the projector detects an abnormal condition.
 - Blinks red when the internal temperature of the projector exceeds the operating range (pp.53, 62).
- ⑦ **LAMP REPLACE indicator**
 - Turn yellow when the life of the projection lamp draws to an end (pp.56, 62).
- ⑧ **KEystone button**
 - Correct the keystone distortion (pp.23, 42).
- ⑨ **POINT (▲▼◀▶) buttons**
 - Select an item or adjust the value in the On-Screen Menu (p.21).
 - Pan the image in Digital zoom + mode (p.34).
 - Adjust the volume level (Point ◀▶ buttons) (p.24).

Antitheft Alarm Setting Buttons

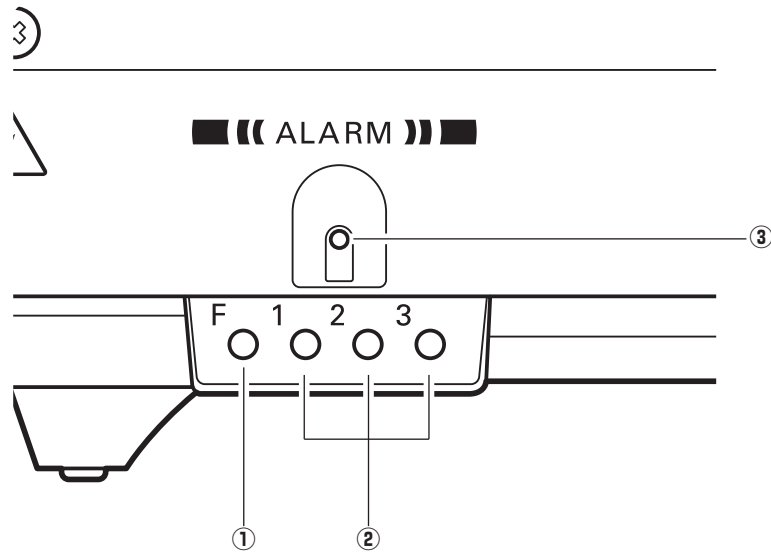

These buttons are used for the Antitheft alarm function (pp.50 – 52).

- ① **F button**
Used for the Antitheft alarm setting.
- ② **Button 1-3**
Used for the Antitheft alarm setting.
- ③ **ALARM indicator**
Blinks red to indicate the battery condition or key operation.

Remote Control

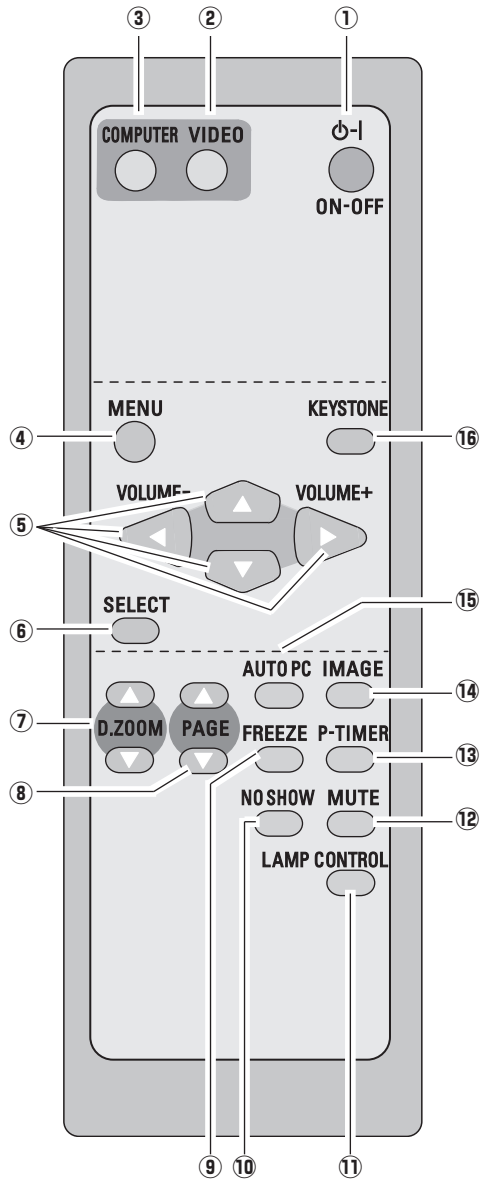

- ① **POWER ON-OFF button**
Turn the projector on or off (pp.18, 19).
- ② **VIDEO button**
Select VIDEO input source (pp.24, 35).
- ③ **COMPUTER button**
Select COMPUTER input source (pp.24, 26, 36).
- ④ **MENU button**
Open or close the On-Screen Menu (p.21).
- ⑤ **Point ▲▼ ◀▶ (VOLUME + / -) buttons**
–Select an item or adjust the value in the On-Screen Menu. (p.21)
–Pan the image in Digital zoom + mode (p.34).
–Adjust the volume level (Point ◀▶ buttons) (p.24).
- ⑥ **SELECT button**
–Execute the selected item (p.21).
–Expand or compress the image in Digital zoom mode. (p.34).
- ⑦ **D.ZOOM ▲▼ buttons**
Zoom in and out the images (pp.25, 34).
- ⑧ **PAGE ▲▼ buttons**
Scroll back and forth pages on the screen when giving a presentation. Connect the projector and your computer with a USB cable (not supplied) to use these buttons (pp.9, 16).
- ⑨ **FREEZE button**
Freeze the picture (p.24).
- ⑩ **NO SHOW button**
Temporarily turn off the image on the screen (p.25).
- ⑪ **LAMP CONTROL button**
Select the lamp mode (pp.25, 46).
- ⑫ **MUTE button**
Mute the sound (p.24).
- ⑬ **P-TIMER button**
Operate the P-timer function (p.25).
- ⑭ **IMAGE button**
Select the image level (pp.25, 31, 38).
- ⑮ **AUTO PC button**
Automatically adjust the computer image to its optimum setting (pp.25, 28).
- ⑯ **KEYSTONE button**
Correct the keystone distortion (pp.23, 42).



- To ensure safe operation, observe the following precautions:
- Do not bend, drop, or expose the remote control to moisture or heat.
 - For cleaning, use a soft dry cloth. Do not apply benzene, thinner, splay, or any other chemicals.

Remote Control Battery Installation

- 1** Open the battery compartment lid.

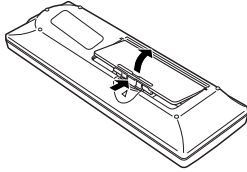

- 2** Install new batteries into the compartment.

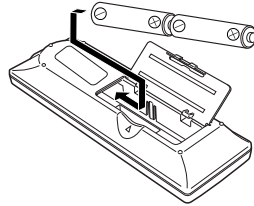

Two AA size batteries

For correct polarity (+ and -), be sure battery terminals are in contact with pins in the compartment.

- 3** Replace the compartment lid.

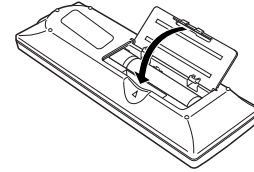

To insure safe operation, please observe the following precautions:

- Use two (2) AA or LR6 type alkaline batteries.
- Always replace batteries in sets.
- Do not use a new battery with a used battery.
- Avoid contact with water or liquid matter.
- Do not expose the remote control to moisture or heat.
- Do not drop the remote control.
- If the battery has leaked on the remote control, carefully wipe the case clean and install new batteries.
- Risk of explosion if a battery is replaced by an incorrect type.
- Dispose of used batteries according to the instructions.

Operating Range

Point the remote control toward the projector (Infrared Remote Receiver) when pressing any button. Maximum operating range for the remote control is about 16.4' (5 m) and 60 degrees in front of the projector.

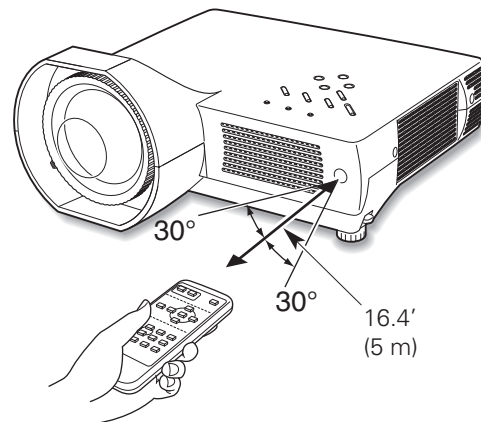

Installation

Positioning the Projector

For projector positioning, see the figures below.
The projector should be set perpendicularly to the plane of the screen.

✓Notes:

- This projector is not equipped with an optical zoom. To adjust the screen size, change the throw distance.
- The brightness in the room has a great influence on picture quality. It is recommended to limit the ambient lighting in order to get the best image.
- All measurements are approximate and may vary from the actual sizes.

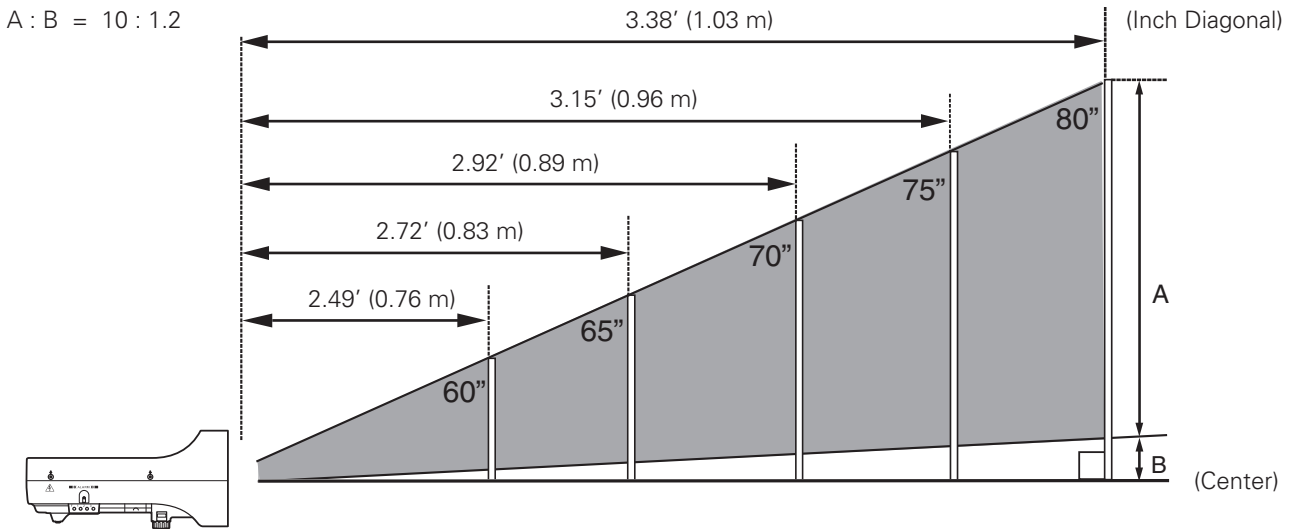

Screen Size (W x H) mm	60"	65"	70"	75"	80"
4:3 aspect ratio	1219 x 914	1321 x 991	1422 x 1067	1524 x 1143	1626 x 1219
Throw distance	2.49' (0.76 m)	2.72' (0.83 m)	2.92' (0.89 m)	3.15' (0.96 m)	3.38' (1.03 m)

Adjustable Feet

Projection angle can be adjusted up to 10.0 degrees with the adjustable feet.

- 1 Lift the front of the projector and pull the feet lock latches on both sides of the projector upward.
- 2 Release the feet lock latches to lock the adjustable feet and rotate the adjustable feet to adjust the position and tilt.
- 3 To retract the adjustable feet, lift the front of the projector and pull and undo the feet lock latches. Keystone distortion of the projected image can be corrected by menu operation (pp.23, 42).

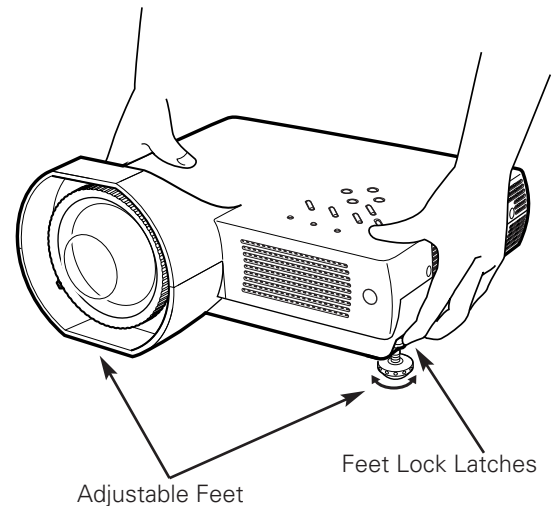

Connecting the AC Power Cord

This projector uses nominal input voltages of 100–120 V or 200–240 V AC and it automatically selects the correct input voltage. It is designed to work with single-phase power systems having a grounded neutral conductor. To reduce the risk of electrical shock, do not plug into any other type of power system.

If you are not sure of the type of power being supplied, consult your authorized dealer or service station.

Connect the projector with all peripheral equipment before turning it on.

CAUTION

For safety, unplug the AC power cord when the projector is not in use. When the projector is connected to an outlet with the AC power cord, it is in stand-by mode and consumes a little electric power.

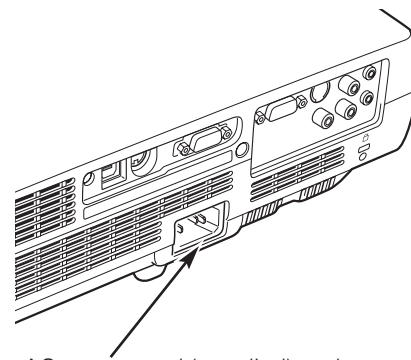

Connect the AC power cord (supplied) to the projector.
The AC outlet must be near this equipment and must be easily accessible.

NOTE ON THE POWER CORD

AC power cord must meet the requirements of the country where you use the projector. Confirm the AC plug type with the chart below and proper AC power cord must be used. If the supplied AC power cord does not match your AC outlet, contact your sales dealer.

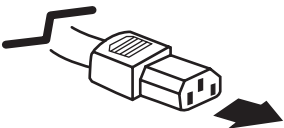
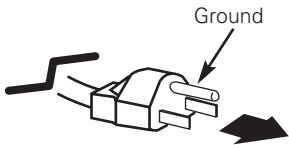
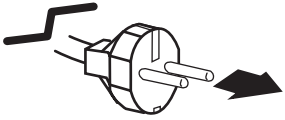
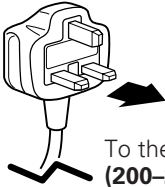
Projector side	AC outlet side		
 <p>To power cord connector on your projector.</p>	<p>For the U.S.A. and Canada</p>  <p>To the AC outlet. (120 V AC)</p>	<p>For Continental Europe</p>  <p>To the AC outlet. (200–240 V AC)</p>	<p>For the U.K.</p>  <p>To the AC outlet. (200–240 V AC)</p>

Connecting to a Computer

Cables used for connection

- VGA Cables (Mini D-sub 15 pin)*
 - USB Cable
 - Audio Cables (Mini Plug; stereo)
- (*One cable is supplied; other cables are not supplied with the projector.)

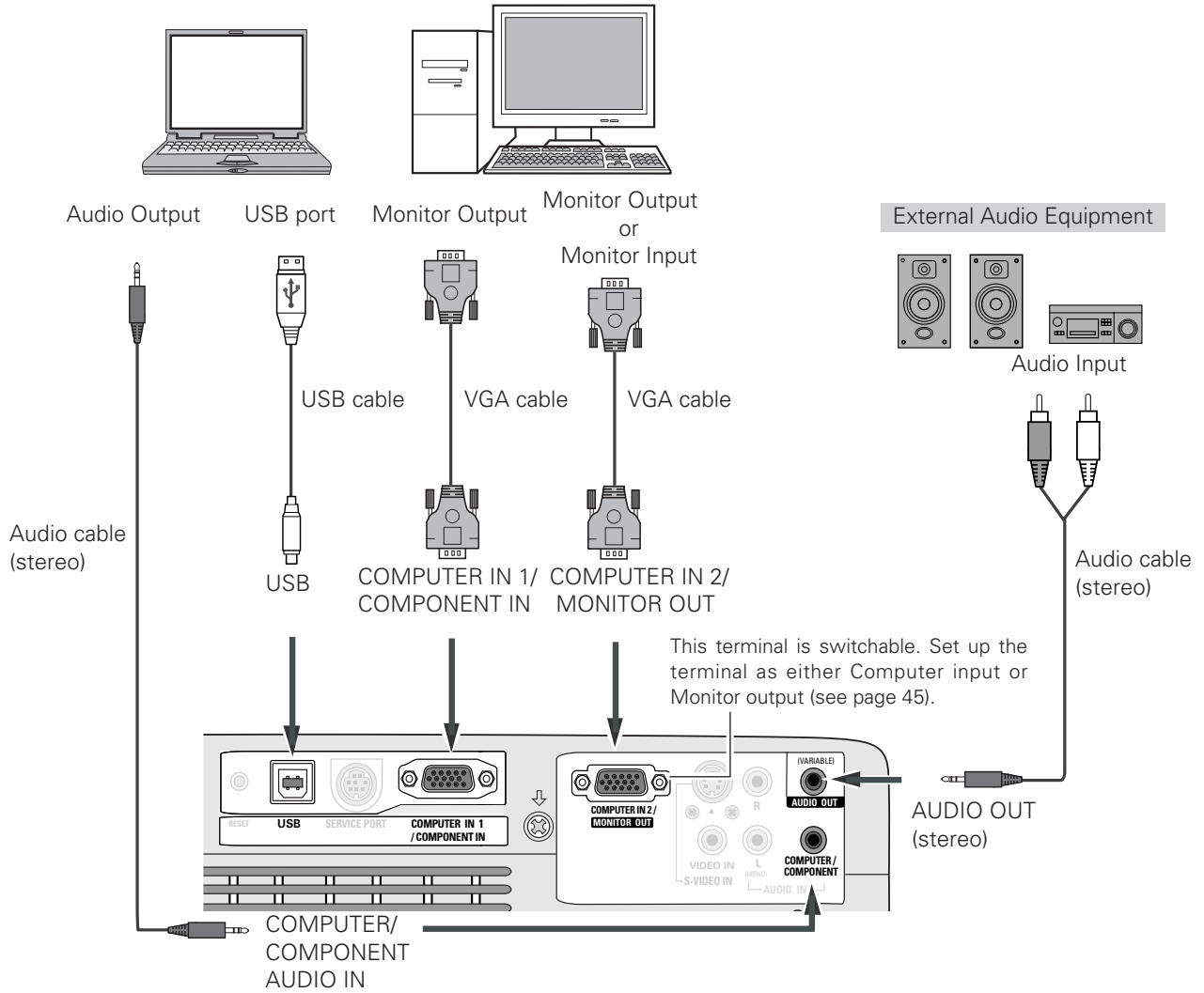

Notes:

- Input sound to the *COMPUTER/COMPONENT AUDIO IN* terminal when using the *COMPUTER IN 1/COMPONENT IN* and the *COMPUTER IN 2/MONITOR OUT* terminal as input.
- When connecting the *AUDIO OUT* to external audio equipment, the projector's built-in speaker is disconnected.
- When the cable is of the longer variety, it is advisable to use the *COMPUTER IN 1/COMPONENT IN* and not the *COMPUTER IN 2 /MONITOR OUT*.
- See page 65 for ordering optional cables.



Unplug the power cords of both the projector and external equipment from the AC outlet before connecting the cables.

Connecting to Video Equipment

Cables used for connection

- Video and Audio Cable (RCA x 3)
 - S-VIDEO Cable
 - Audio Cable (Mini Plug: stereo)
- (Cables are not supplied with the projector.)

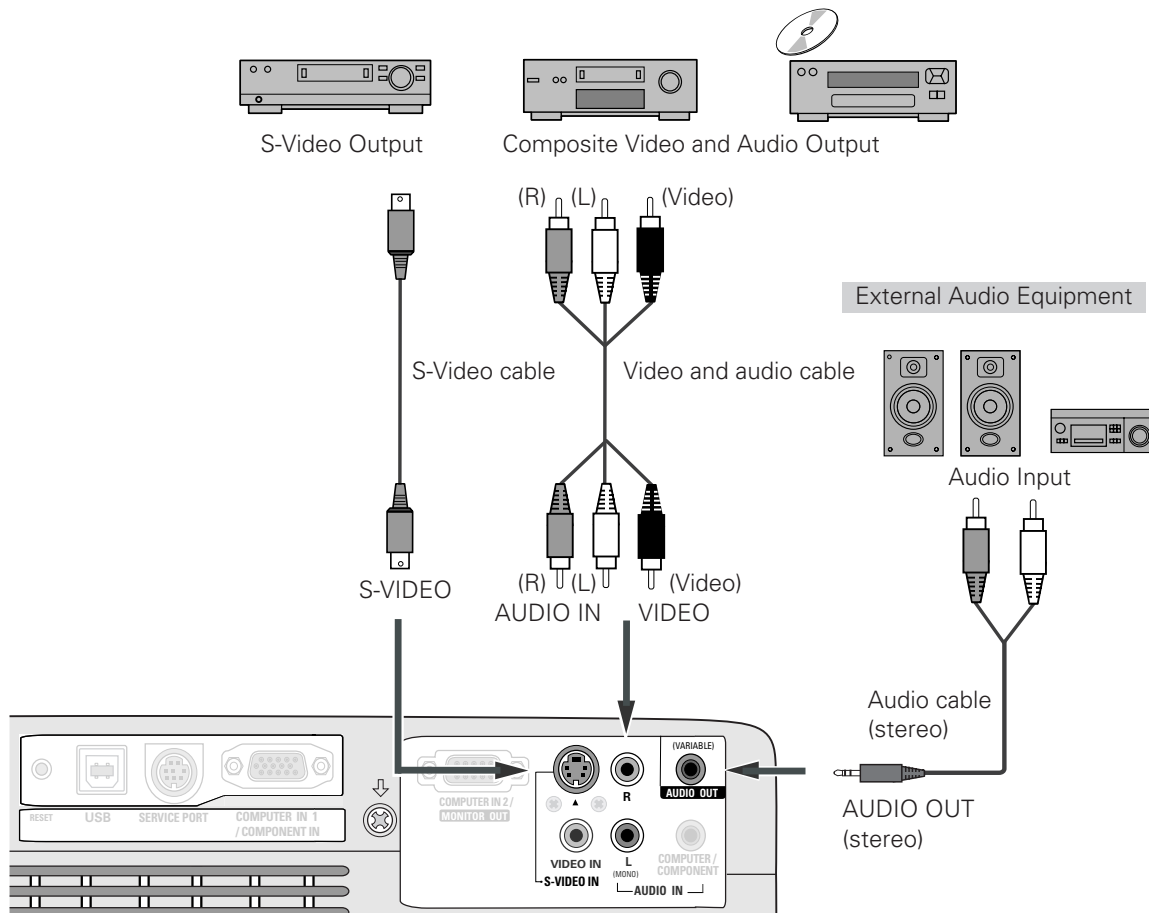

Notes:

- When connecting AUDIO OUT to external audio equipment, the projector's built-in speaker is disconnected.
- The S-VIDEO jack connection overrides the VIDEO jack connection when selecting AUTO in the Input Menu (p.35).
- See page 65 for ordering optional cables.



Unplug the power cords of both the projector and external equipment from the AC outlet before connecting the cables.

C

external equipment from the AC outlet before connecting the cables.

Basic Operation

Turning On the Projector

- 1 Complete peripheral connections (with a computer, VCR, etc.) before turning on the projector.
- 2 Connect the projector's AC power cord into an AC outlet. The POWER indicator turns red.
- 3 Press the POWER ON-OFF button on the top control or on the remote control. The POWER indicator becomes green and the cooling fans start to operate. The preparation display appears on the screen and the count down starts.
- 4 After the countdown, the input source that was selected the last time and the Lamp mode status icon (see page 46) will appear on the screen. If the projector is locked with a PIN code, a PIN code Input Dialog Box appears. Enter the PIN code as instructed below.

Enter a PIN code

Use the Point ◀▶ buttons to select a number and press the SELECT button to fix the number; the number changes to "*"." If you fixed an incorrect number, move the pointer to "Set" or "Clear" once with the Point ▼ button, then return to "PIN code." Enter the correct number.

Repeat this step to complete entering a four-digit number. "1234" is set as the initial PIN code at the factory.

When the four-digit number is fixed, the pointer automatically moves to "Set." Press the SELECT button so that you can start to operate the projector.

If you entered an incorrect PIN code, "PIN code" and the number (****) will turn red and disappear. Enter the PIN code all over again.

What is PIN code?

PIN (Personal Identification Number) code is a security code that allows the person who knows it to operate the projector. Setting the PIN code prevents unauthorized use of the projector.

A PIN code consists of a four-digit number. Refer to PIN code lock function in the Setting Menu on pages 47–48 for locking operation of the projector with your PIN code.



CAUTION ON HANDLING THE PIN CODE

If you forget your PIN code, the projector can no longer be started. Take special care in setting a new PIN code; write down the number and keep it at hand. Should the PIN code be missing or forgotten, consult your dealer or service center.



The preparation display disappears after 30 seconds.

Selected Input Source and Lamp Mode



See page 46 for the Lamp mode.

PIN Code Input Dialog Box



OK After the OK icon disappears, you can operate the projector.

✓Notes:

- When the Logo select function is "Off," the logo will not be displayed on the screen (p.43).
- When the "Countdown off" or "Off" is selected in the Display function, the countdown will not be shown on the screen (p.42).
- During the countdown period, all operations are invalid.
- If the correct PIN code number is not entered for 3 minutes after the PIN code dialog box appeared, the projector will be turned off automatically.

Turning Off the Projector

- 1** Press the POWER ON-OFF button on the top control or on the remote control, and "Power off?" appears on the screen.
- 2** Press the POWER ON-OFF button again to turn off the projector. The POWER indicator starts to blink red, and the cooling fans keep running. (You can select the level of the fans' quietness and running speed. See page 49.) At this time you can disconnect the AC power cord even if the fans are still running.
- 3** When the projector has cooled down enough to be turned on again, the POWER indicator stops blinking.



TO MAINTAIN THE LAMP LIFE, ONCE YOU TURN THE PROJECTOR ON, WAIT AT LEAST 5 MINUTES BEFORE TURNING IT OFF.

✓Notes:

- When the On start function is "On," this projector is turned on automatically by connecting the AC power cord to an AC outlet (p. 46).
- Do not operate the projector continuously without rest. Continuous use may result in shortening the lamp life. Turn off the projector and let stand for about an hour in every 24 hours.
- The running speed of cooling fans is changed according to the temperature inside the projector.
- Do not put the projector in a case before the projector is cooled enough.
- If the WARNING indicator blinks or emits a red light, see "Warning Indicator" on page 53.

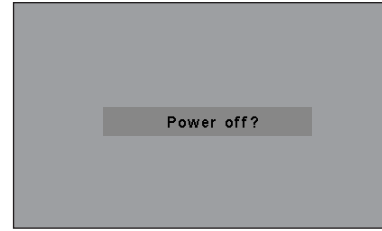

"Power off" disappears after 4 seconds.

How to Operate the On-Screen Menu

The projector can be adjusted or set via the On-Screen Menu. For each adjustment and setting procedure, refer to the respective sections in this manual.

- 1 Press the MENU button on the top control or on the remote control to display the On-Screen Menu.
- 2 Use the Point ◀▶ buttons to select a Menu icon; use the Point ▲▼ buttons to select an item.
- 3 Press the SELECT button to show the item data. To adjust the data, use the Point ◀▶ buttons. Refer to the relevant pages for more details about each adjustment.

To close the On-Screen Menu, press the MENU button again.

✓Note:

- The selected item is not active until the SELECT button is pressed.

Top Control

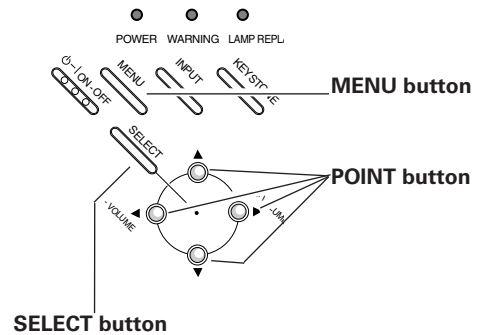

Remote Control

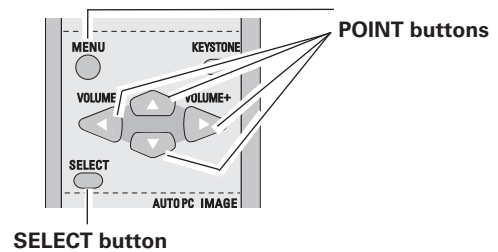

On-Screen Menu

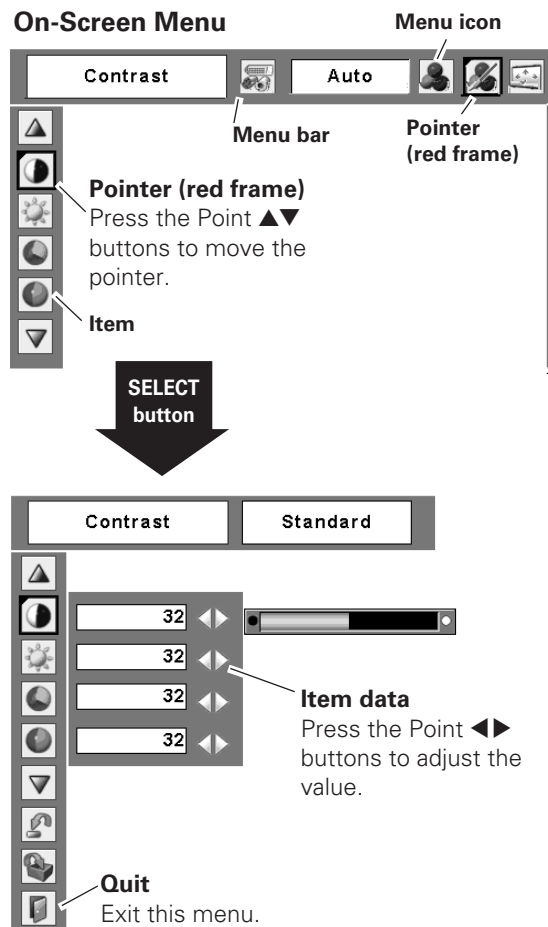

Menu Bar

For detailed functions, see Menu Tree on pages 60–61.

For computer source

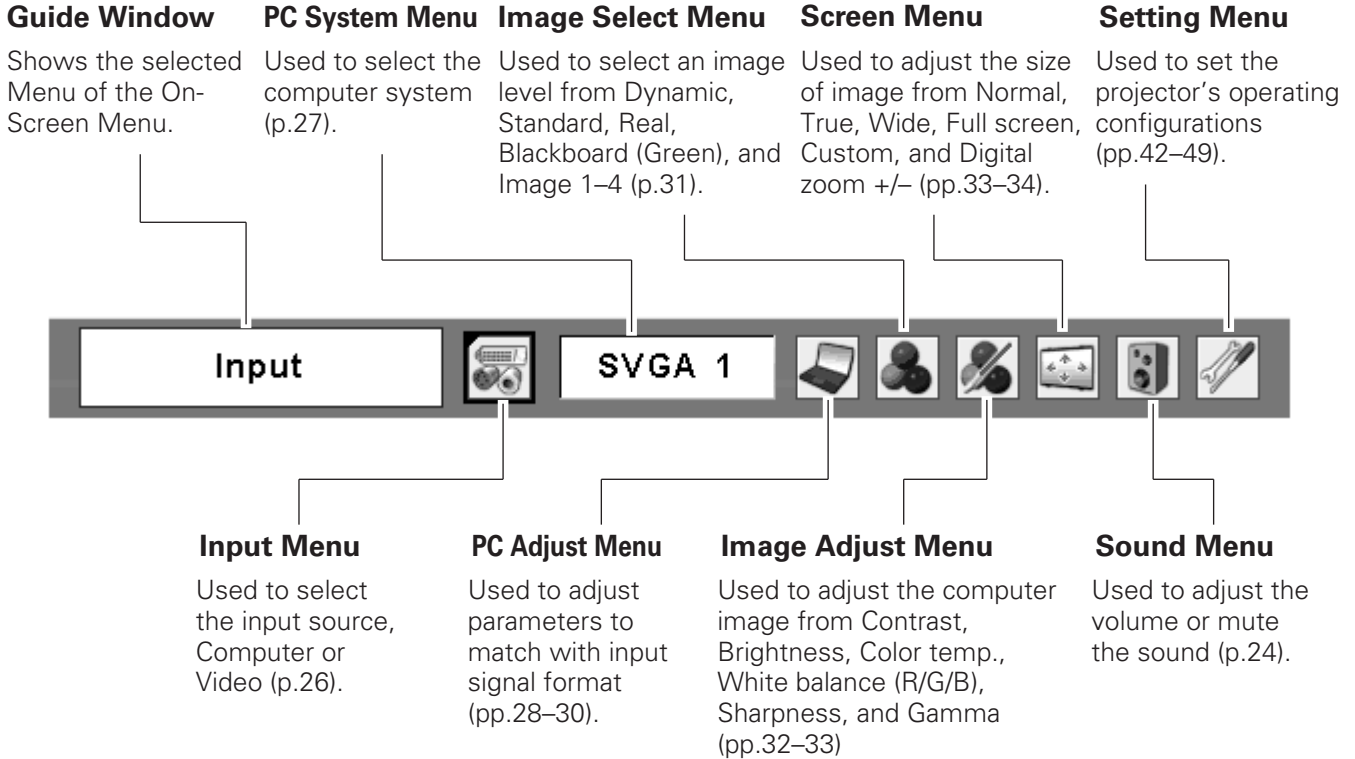

For video source

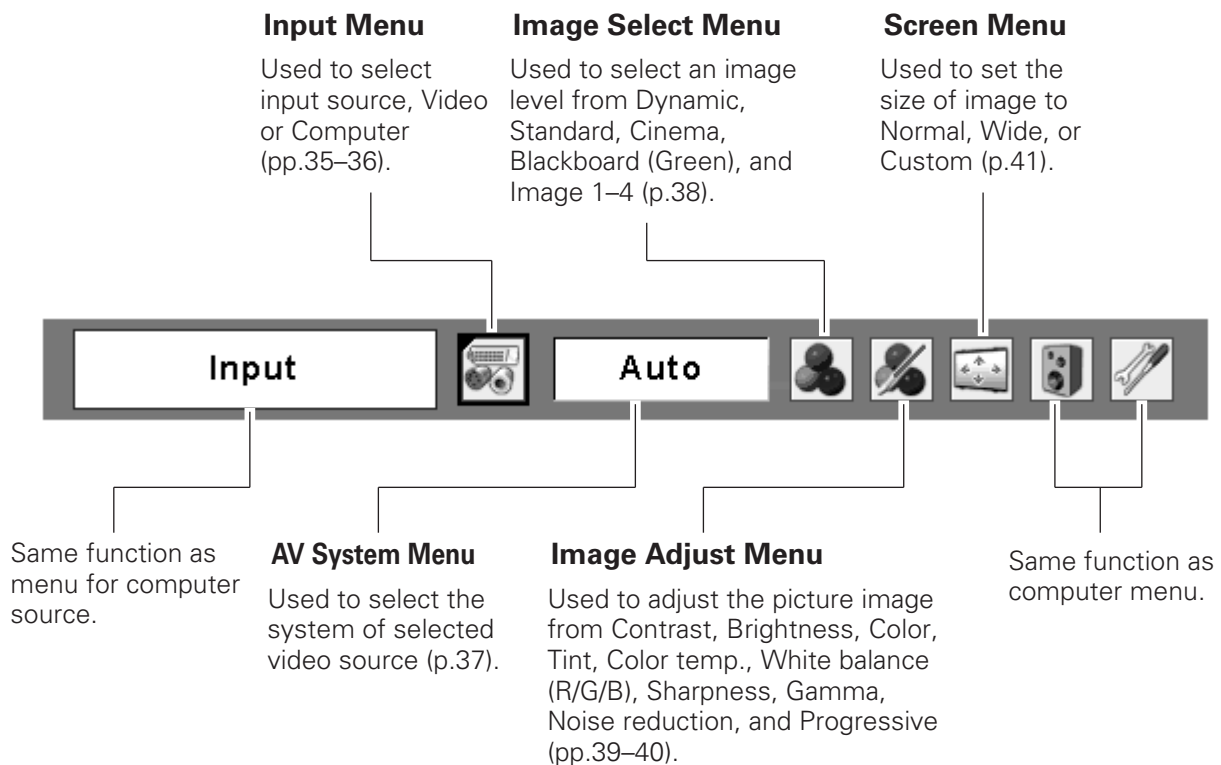

Focus Adjustment

Top Control

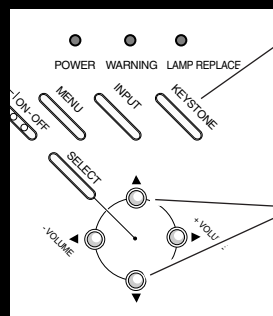

KEYSTONE button

POINT ▲▼ buttons

KEYSTONE button

POINT ▲▼ buttons

Sound Adjustment

Direct Operation

Volume

Press the VOLUME+/- buttons on the top control or on the remote control to adjust the volume. The volume dialog box appears on the screen for a few seconds.

Mute

Press the MUTE button on the remote control to turn off the sound. To restore the sound to its previous level, press the MUTE button again or press the VOLUME+/- buttons. Mute function is also effective for AUDIO OUT jack.

Menu Operation

- 1 Press the MENU button to display the On-Screen Menu. Use the Point ◀▶ buttons to move the red frame pointer to the Sound Menu icon.
- 2 Press the Point ▲▼ buttons to move the red frame pointer to the desired item, and then press the SELECT button.

Volume

Press the Point ▶ button to turn up the volume; press the Point ◀ button to turn down the volume.

Mute

Press the Point ◀▶ buttons to turn off the sound. The mute dialog box display is changed to "On" and the sound is turned off. To restore the sound to its previous level, press the Point ▶ buttons again.

Remote Control Operation

Using the remote control for some frequently used operations is advisable. Just pressing one of the buttons enables you to make the desired operation quickly without calling up the On-Screen Menu.

COMPUTER/VIDEO button

Press the COMPUTER or VIDEO button to select an input source. See pages 26, 35–36 for more details.

FREEZE button

Press the FREEZE button to freeze the picture on the screen. To cancel the Freeze function, press the FREEZE button again or press any other button.

Top Control

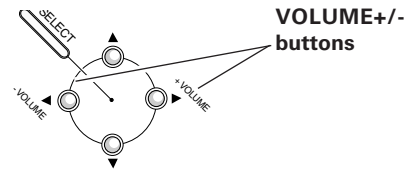

Remote Control

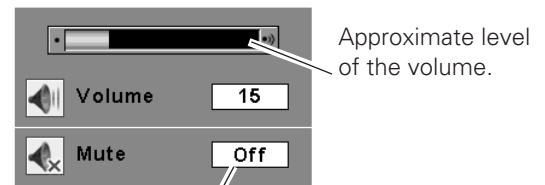
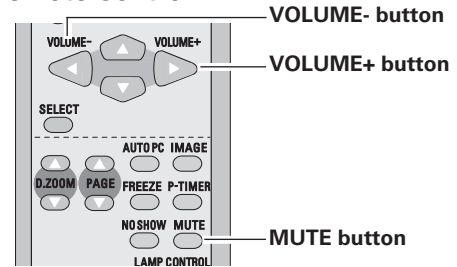

Press the MUTE button to set the Mute function On or Off. The display disappears after 4 seconds.

Sound Menu

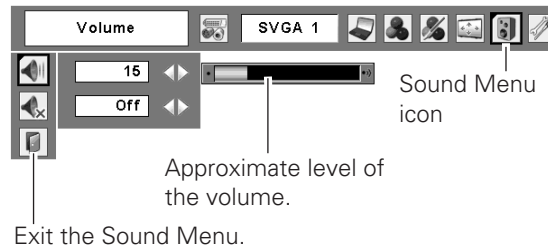

Remote Control

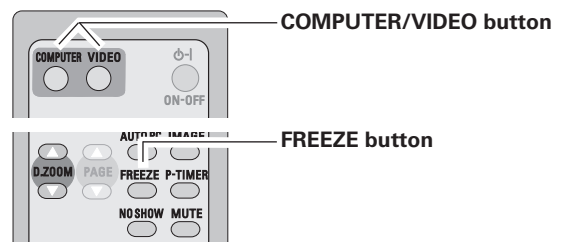

✓ Note:

- See the next page for the description of other buttons.

AUTO PC button

Press the AUTO PC button to operate the Auto PC function. See page 28 for more details.

D.ZOOM buttons

Press the D.ZOOM buttons to zoom in and zoom out the images. See page 34 for more details.

NO SHOW button

Press the NO SHOW button to black out the image. To restore to normal, press the NO SHOW button again or press any other button. When the projected image is captured and is set as "User" in the Logo selection (p.43), the screen changes each time you press the NO SHOW button as follows.

black out → the captured image → normal →

KEystone button

For details, see page 23.

IMAGE button

Press the IMAGE button to select an image level of the screen. See pages 31, 38 for more details.

P-TIMER button

Press the P-TIMER button. The timer display "00:00" appears on the screen and the timer starts to count time (00:00–59:59).

To stop the P-Timer, press the P-TIMER button. Press the P-TIMER button again, then the P-timer display disappears.

LAMP CONTROL button

Press the LAMP CONTROL button to select the lamp mode for changing the brightness of the screen.

- ⦿ NormalNormal brightness
- ⦿A AutoBrightness according with the input signal
- ⦿ EcoLower brightness reduces the lamp power consumption and extends the lamp life.

Remote Control

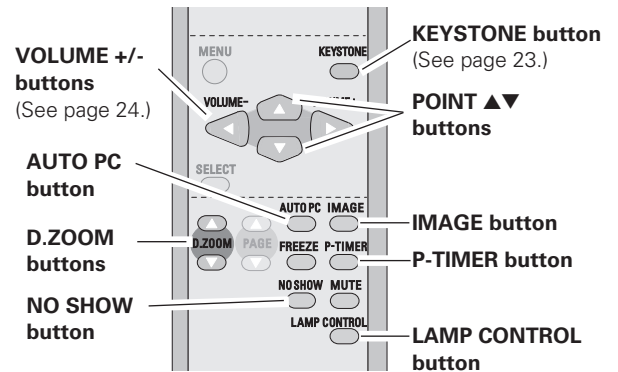

✓ Note:

• See the previous page for the description of other buttons.

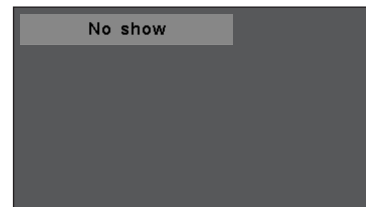

"No show" disappears after 4 seconds.



P-Timer display

Computer Input

Input Source Selection

Direct Operation

Press the INPUT button on the top control or the COMPUTER button on the remote control to select either Computer 1 or Computer 2.

Before using the INPUT or COMPUTER buttons, select the correct input source through Menu operation as described below.

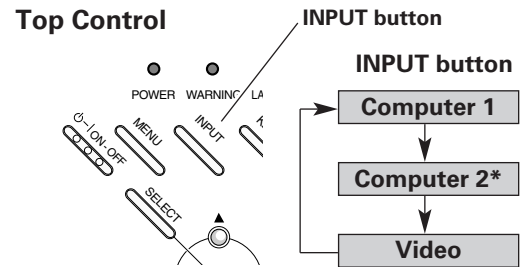

Remote Control

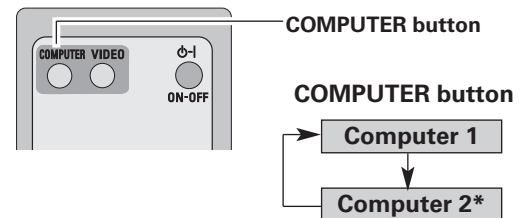

*See Notes at the bottom of this page.

Menu Operation

- 1 Press the MENU button to display the On-Screen Menu. Use the Point ◀▶ buttons to move the red frame pointer to the Input Menu icon.
- 2 Use the Point ▲▼ buttons to move the red arrow pointer to either Computer 1 or Computer 2, and then press the SELECT button.
- 3 After the Source Select Menu appeared for Computer 1, move the pointer to RGB and then press the SELECT button.

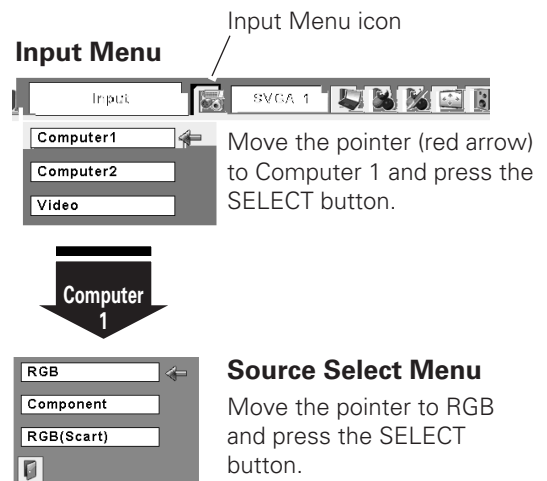

✓Notes:

- Computer 2 is not displayed when the COMPUTER IN 2/MONITOR OUT terminal is set as Monitor out (p.45).
- Computer 2 (COMPUTER IN 2/MONITOR OUT) can accept only the RGB signal.

Input Menu

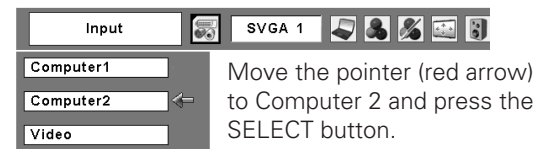

Computer System Selection

The projector automatically tunes to various types of computers based on VGA, SVGA, XGA, SXGA, WXGA, or UXGA with its Multi-scan system and Auto PC Adjustment. If computer is selected as a signal source, the projector automatically detects the signal format and tunes to project proper images without any additional setting. (Signal formats provided in this projector is shown on page 63.)

One of the following messages may appear when:

- Auto** The projector cannot recognize the connected signal conforming to the provided PC Systems. "Auto" is displayed on the PC System Menu icon and the Auto PC Adjustment function works to display proper images. If images are not projected properly, adjust manually. (pp.29-30)
- There is no signal input from computer. Check the connection between your computer and the projector. (See "Troubleshooting" on page 58.)
- Mode 1** The preset system is manually adjusted in the PC Adjust Menu. The adjusted data can be stored in Mode 1-5 (pp.29-30).
- SVGA 1** A PC System provided in the projector is selected. The projector selects a proper system provided in the projector and displays it.

*Mode 1 and SVGA 1 are examples.

PC System Menu

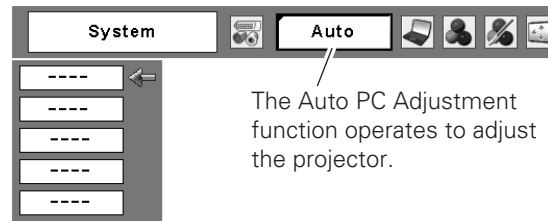

Selecting Computer System Manually

PC system can also be selected manually.

- 1** Press the MENU button to display the On-Screen Menu. Use the Point ◀▶ buttons to move the red frame pointer to the PC System Menu icon.
- 2** Use the Point ▲▼ buttons to move the red arrow pointer to the desired system, and then press the SELECT button.

PC System Menu

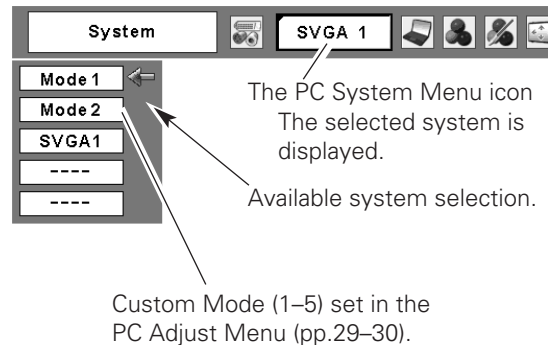

Auto PC Adjustment

Auto PC Adjustment function is provided to automatically adjust Fine sync, Total dots, Horizontal, and Vertical positions to conform to your computer.

Direct Operation

The Auto PC adjustment function can be operated directly with the AUTO PC button on the remote control.

Remote Control

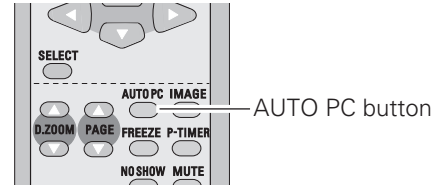

Menu Operation

Auto PC Adj.

- 1 Press the MENU button to display the On-Screen Menu. Use the Point ◀▶ buttons to move the red frame pointer to PC Adjust Menu.
- 2 Use the Point ▲▼ buttons to move the red frame pointer to Auto PC Adj. and then press the SELECT button twice.

To store the adjusted parameters

The system parameters adjusted in the Auto PC Adjustment can be stored in the projector. Once parameters are stored, the setting can be done just by selecting a Mode in the PC System Menu (p.27). See "Store" on page 30, for details.

✓Notes:

- Fine sync, Total dots, Horizontal, and Vertical positions of some computers cannot be fully adjusted with this Auto PC Adjustment function. When the image is not provided properly with this operation, manual adjustments are required (pp.29–30).
- The Auto PC Adjustment cannot be operated when 480i, 575i, 480p, 575p, 720p, 1035i, or 1080i is selected in the PC System Menu (p.27).

PC Adjust Menu

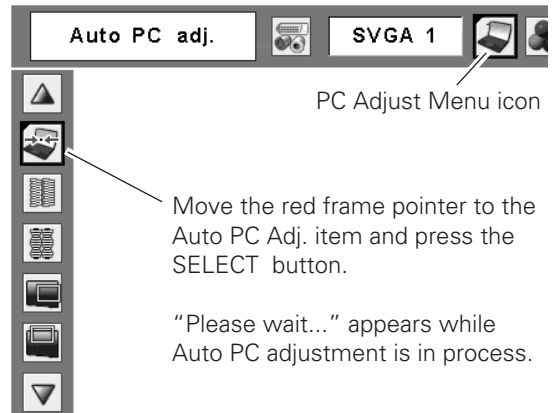

Manual PC Adjustment

Some computers employ special signal formats which may not be tuned by Multi-scan system of this projector. Manual PC Adjustment enables you to precisely adjust several parameters to match those signal formats. The projector has five independent memory areas (Mode 1–5) to store those parameters manually adjusted, which allows you to recall the setting for a specific computer.

- 1 Press the MENU button to display the On-Screen Menu. Use the Point ◀▶ buttons to move the red frame pointer to the PC Adjust Menu icon.
- 2 Use the Point ▲▼ buttons to move the red frame pointer to the desired item and then press the SELECT button to display the adjustment dialog box. Press the Point ◀▶ buttons to adjust the value.

Fine sync

Use the Point ◀▶ buttons to adjust the value to cut off flicker from the image displayed (from 0 to 31).

Total dots

Use the Point ◀▶ buttons to adjust the number of total dots in one horizontal period to match your PC image.

Horizontal

Use the Point ◀▶ buttons to adjust the horizontal picture position.

Vertical

Use the Point ◀▶ buttons to adjust the vertical picture position.

Current mode

Press the SELECT button to show H-sync freq. and V-sync freq. of the connected computer.

Clamp

Use the Point ◀▶ buttons to adjust the clamp level. When the image has dark bars, try this adjustment.

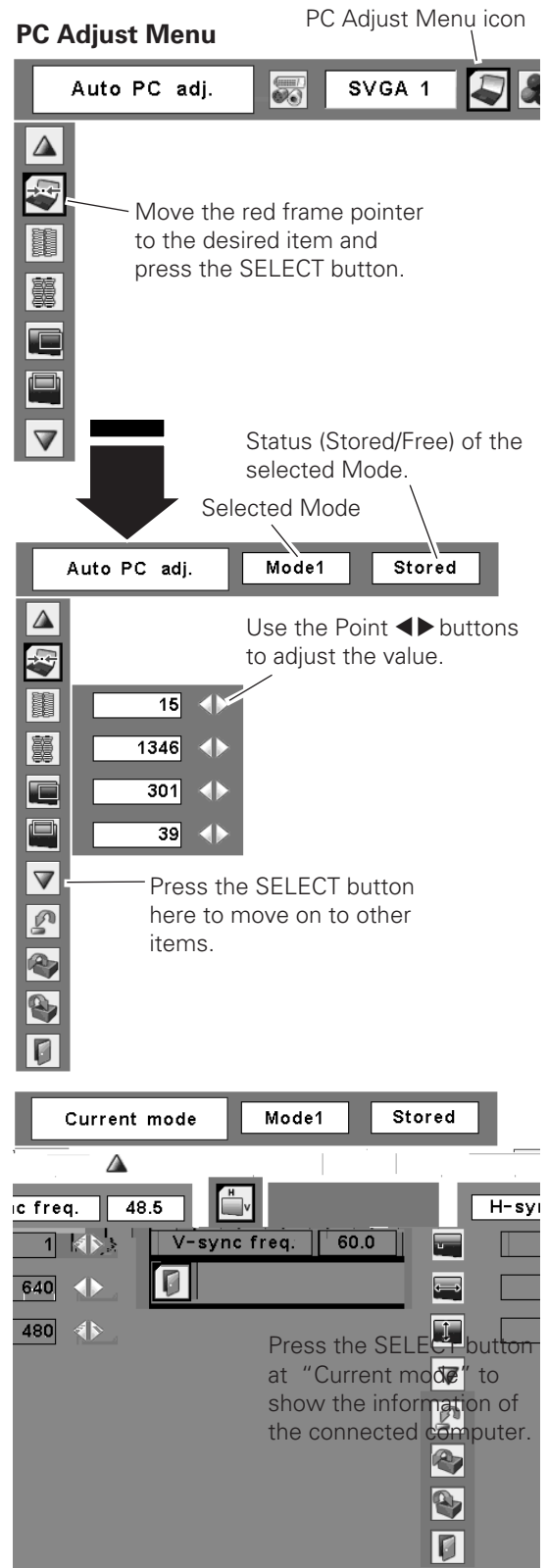

Display area H

Use the Point ◀▶ buttons to adjust the horizontal area displayed by this projector.

Display area V

Use the Point ◀▶ buttons to adjust the vertical area displayed by this projector.

Reset

To reset the adjusted data, select "Reset" and press the SELECT button. A confirmation box appears and then select "Yes." All adjustments return to their previous figures.

Mode free

To clear the stored data, select "Mode free" and then press the SELECT button. Move the red arrow pointer to the Mode that you want to clear and then press the SELECT button.

Store

To store the adjusted data, select "Store" and then press the SELECT button. Move the red arrow pointer to one of the Mode 1 to 5 in which you want to store, and then press the SELECT button.

Quit

Exit the PC Adjust Menu.

✓Note:

- Display area (H/V) cannot be selected when 480i, 575i, 480p, 575p, 720p, 1035i, or 1080i is selected in the PC System Menu (p.27).

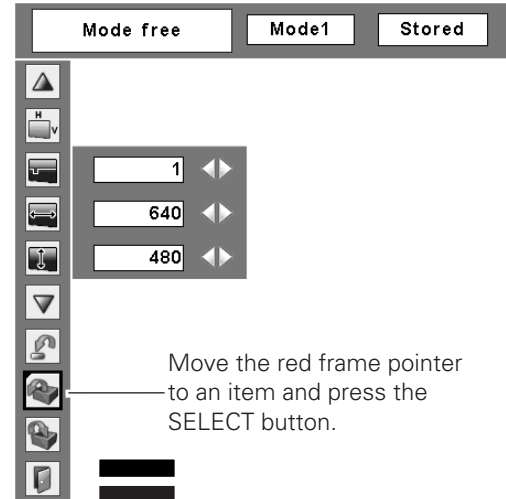

Move the red frame pointer to an item and press the SELECT button.

To clear adjusted data

This Mode has stored parameters.

Where to free?						
Mode1	Stored	800	142	34	1024	768
Mode2	Free	800	142	34	1024	768
Mode3	Free	800	142	34	1024	768
Mode4	Free	800	142	34	1024	768
Mode5	Free	800	142	34	1024	768

Vacant Mode

Values of "Total dots," "Horizontal," "Vertical," "Display area H," and "Display area V."

To store adjusted data

Where to store?						
Mode1	Stored	800	142	34	1024	768
Mode2	Free	800	142	34	1024	768
Mode3	Free	800	142	34	1024	768
Mode4	Free	800	142	34	1024	768
Mode5	Free	800	142	34	1024	768

Close this dialog box.

Image Level Selection

Direct Operation

Select an image level from among Dynamic, Standard, Real, Blackboard (Green), Image 1, Image 2, Image 3, and Image 4 with the IMAGE button on the remote control.

Dynamic

For viewing pictures in a bright room.

Standard

Normal picture level preset on the projector.

Real

Picture level with improved halftone for graphics.

Blackboard (Green)

For viewing the image projected on a blackboard. This mode assists to enhance the image projected on a blackboard. This is mainly effective on a green colored board, not truly effective on a black colored board.

Image 1-4

User preset image in the Image Adjust Menu (p.33).

Remote Control

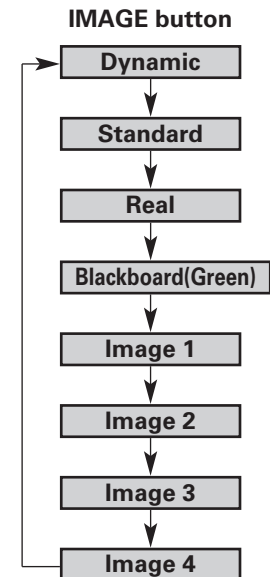
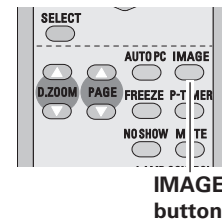

Menu Operation

- 1 Press the MENU button to display the On-Screen Menu. Use the Point ◀▶ buttons to move the red frame pointer to the Image Select Menu icon.
- 2 Use the Point ▲▼ buttons to move the red frame pointer to the desired level and then press the SELECT button.

Dynamic

For viewing pictures in a bright room.

Standard

Normal picture level preset on this projector.

Real

Picture level with improved halftone for graphics.

Blackboard(Green)

For viewing the image projected on a blackboard. See above for further description.

Image 1-4

User preset image in the Image Adjust Menu (p.33).

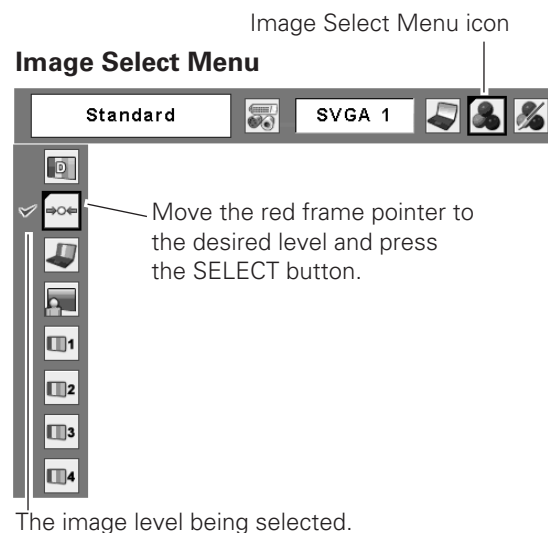

The image level being selected.

- 1 Press the MENU button to display the On-Screen Menu. Use the Point ◀▶ buttons to move the red frame pointer to the Image Adjust Menu icon.
- 2 Use the Point ▲▼ buttons to move the red frame pointer to the desired item, and then press the SELECT button. The level of each item is displayed. Use the Point ◀▶ buttons to adjust each level.

Contrast

Press the Point ◀ button to decrease the contrast; press the Point ▶ button to increase the contrast (from 0 to 63).

Brightness

Press the Point ◀ button to decrease the brightness; press the Point ▶ button to increase the brightness (from 0 to 63).

Image Adjust Menu

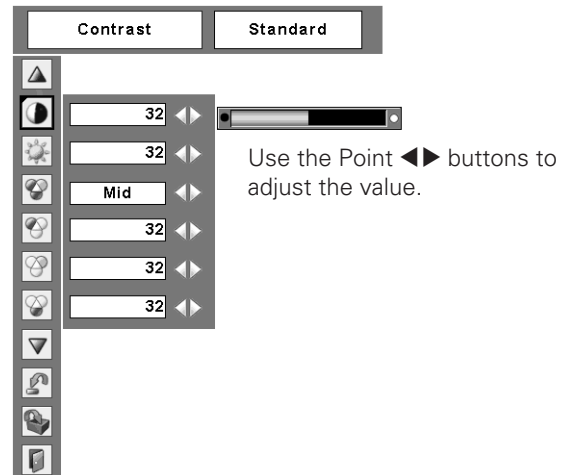
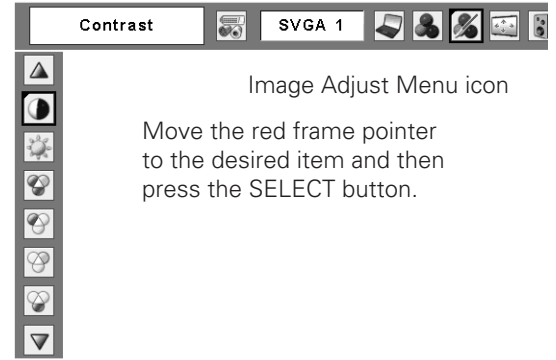

 **Store**

To store the adjusted data, select "Store" and press the SELECT button. The Image Level Menu appears. Use the Point ▲▼ buttons to choose one of the four image level and press the SELECT button. A confirmation box appears and then select "Yes."

The stored data can be called up by selecting "Image" in the Image Level Selection on page 31.

 **Quit**

Exit the Image Adjust Menu.

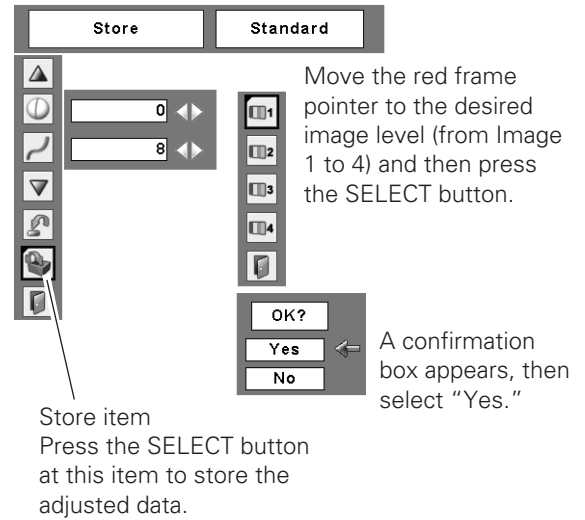

Screen Size Adjustment

This projector has the picture screen resize function, which enables you to customize the image size.

- 1 Press the MENU button to display the On-Screen Menu. Use the Point ◀▶ buttons to move the red frame pointer to the Screen Menu icon.
- 2 Use the Point ▲▼ buttons and move the red frame pointer to the desired function and then press the SELECT button.

 **Normal**

Provide the image to fit the screen size.

 **True**

Provide the image in its original size. When the original image size is larger than the screen size (1024 x 768), the projector automatically switches to the panning mode. Use the Point ▲▼◀▶ buttons to pan the image. When adjusted, the arrows turn red. When reached to the correction limit, the arrows disappear.

 **Wide**

Provide the image to fit wide video aspect ratio (16:9) by expanding the image width uniformly. This function can be used to provide the squeezed video signal at 16:9.

 **Full screen**

Provide the full screen image.

Screen Menu

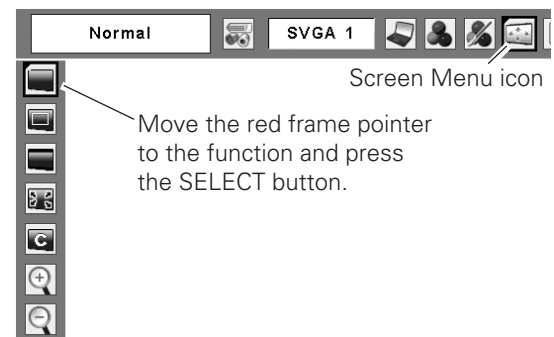

✓ **Notes:**

- This projector cannot display any resolution higher than 1600 x 1200. If your computer's resolution is higher than that, lower the resolution before connecting to the projector.
- The image data other than 1024 x 768 is modified to fit the screen size in initial mode.
- True, Full screen, and Digital zoom +/- cannot be selected when 480i, 575i, 480p, or 575p is selected in the PC System Menu (p.27).

Custom

Adjust the screen scale and position manually with this function.

Press the SELECT button at Custom and the "Custom" is displayed on the screen for a few seconds and then the Aspect dialog box appears.

- Scale H/V..... Adjust the Horizontal/Vertical screen scale.
- H&V..... When set to "On," the aspect ratio is fixed. "Scale V" appears dimmed and becomes unavailable. Adjust "Scale H," then the screen scale is automatically modified based on the aspect ratio.
- Position H/V Adjust the Horizontal/Vertical screen position.
- Common Save the adjusted scale. Press the SELECT button at Common to display a confirmation box. To save the scale, press the SELECT button at "Yes." When Custom is selected, the saved scale is used.
- Reset..... Reset the Common data. Press the SELECT button at Reset to display a confirmation box. To reset, press the SELECT button at "Yes."

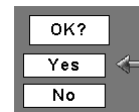
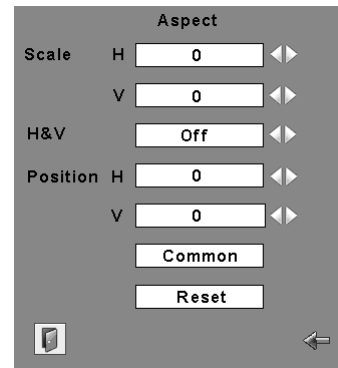

Press the SELECT button at Common or Reset, to display a confirmation box.

✓ Notes:

- When no signal is detected, "Normal" is set automatically and the Aspect dialog box disappears.
- The adjustable range for Scale H/V and Position H/V is limited depending on the input signal.

For zooming in and out the images

Digital zoom +

When Digital zoom + is selected, the On-Screen Menu disappears and "D. zoom +" is displayed. Press the SELECT button to expand the image size. Use the Point  buttons to pan the image. The Panning function can work only when the image is larger than the screen size.

A projected image can be also expanded by pressing the D.ZOOM  button on the remote control.

Digital zoom -

When Digital zoom - is selected, the On-Screen Menu disappears and "D. zoom -" is displayed. Press the SELECT button to compress image size.

The projected image can be also compressed by pressing the D.ZOOM  button on the remote control.

To exit the Digital zoom +/- mode, press any button except the D.ZOOM , SELECT, and Point buttons.

To return to the previous screen size, select a screen size in the Screen Size Adjustment or select an input source from the Input Source Selection (p.26) again, or adjust the screen size with the D.ZOOM  buttons.

Remote Control

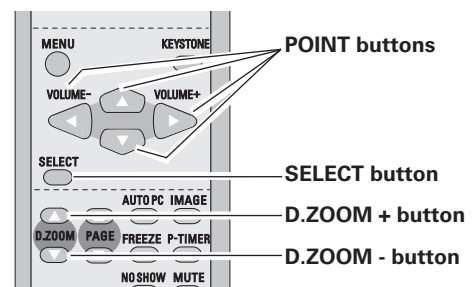

✓ Notes:

- The panning function may not operate properly if the stored Mode in the PC Adjust Menu is used (p.30).
- The minimum compression ratio is limited depending on the input signal or when the Keystone function is working.
- True, Full screen, and Digital zoom +/- cannot be selected when 480i, 575i, 480p, or 575p is selected in the PC System Menu (p.27).
- Digital zoom +/- cannot be selected when Full screen or True is selected.

Video Input

Input Source Selection (Video, S-Video)

Direct Operation

Press the INPUT button on the top control or VIDEO button on the remote control to select "Video."

Before using INPUT or VIDEO buttons, select the correct input source through menu operation as described below.

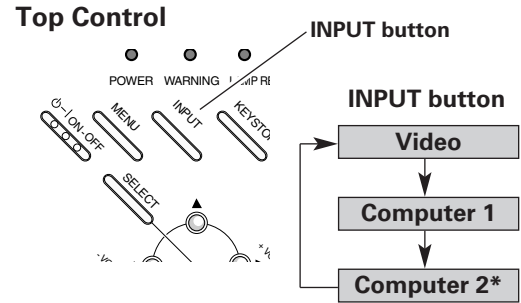

*See Note at the bottom of this page.

Menu Operation

- 1 Use the MENU button to display the On-Screen Menu. Press the Point ◀▶ buttons to move the red frame pointer to the Input Menu icon.
- 2 Use the Point ▲▼ buttons to move the red arrow pointer to Video and then press the SELECT button to display the Source Select Menu .
- 3 Move the pointer to the desired source that and then press the SELECT button.

Auto

When selecting "Auto," the projector automatically detects the incoming video signal, and adjusts itself to optimize its performance. The projector selects connection in the following order:

1. S-Video
2. Video

Video

When the video input signal is connected to the VIDEO jack, select Video.

S-Video

When the video input signal is connected to the S-VIDEO jack, select S-Video.

✓Note:

- Computer 2 is not displayed when the COMPUTER IN 2/MONITOR OUT terminal is set as Monitor out (p.45).

Remote Control

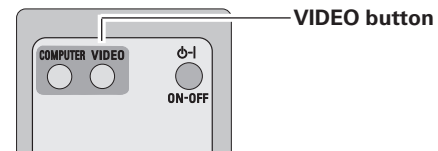

Input Menu

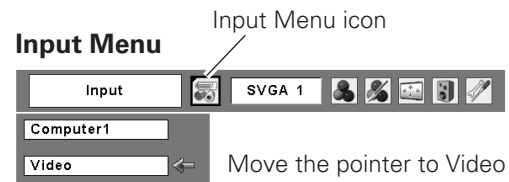

Move the pointer to Video and press the SELECT button.



Source Select Menu (VIDEO)

Move the pointer to the desired source and press the SELECT button.

Input Source Selection (Component, RGB Scart 21-pin)

Direct Operation

Press the INPUT button on the top control or COMPUTER on the remote control to select Computer 1. Before using INPUT or COMPUTER buttons, select the correct input source through Menu operation as described below.

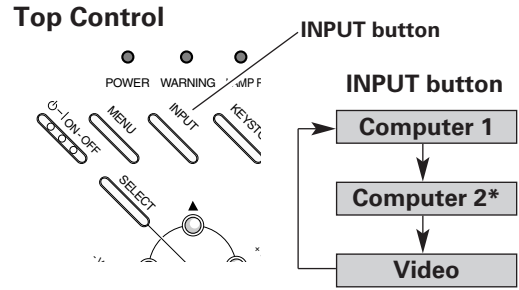

Remote Control

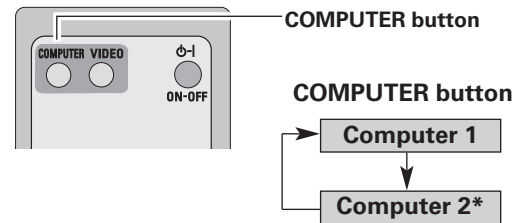

*See Note at the bottom of this page.

Menu Operation

- 1 Use the MENU button to display the On-Screen Menu. Press the Point ◀▶ buttons to move the red frame pointer to the Input Menu icon.
- 2 Use the Point ▲▼ buttons to move the red arrow pointer to Computer 1 and then press the SELECT button.
- 3 After the Source Select Menu appeared for Computer 1, move the pointer to Component or RGB (Scart) and then press the SELECT button.

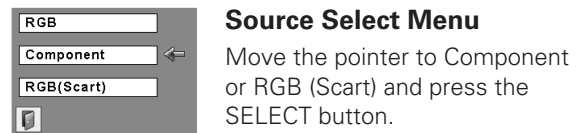
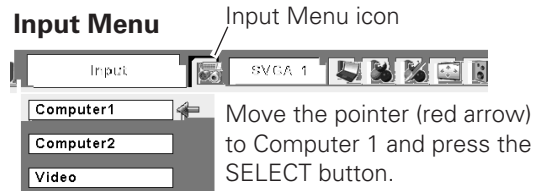

Component

When the input source is coming from video equipment connected to the COMPUTER IN 1/COMPONENT IN terminal with a Component-VGA Cable, select Component.

RGB (Scart)

When the input source is coming from video equipment connected to the COMPUTER IN 1/COMPONENT IN terminal with a Scart-VGA Cable, select RGB (Scart).

✓Notes:

- Computer 2 is not displayed when the COMPUTER IN 2/MONITOR OUT terminal is set as Monitor out (p.45).
- Computer 2 (COMPUTER IN 2/MONITOR OUT) can accept only RGB signal.

Video System Selection

- 1 Press the MENU button to display the On-Screen Menu. Use the Point ◀▶ buttons to move the red frame pointer to the AV System Menu icon.
- 2 Use the Point ▲▼ buttons to move the red arrow pointer to the desired system and then press the SELECT button.

Video or S-Video

Auto

The projector automatically detects an incoming video system, and adjusts itself to optimize its performance. When Video System is PAL-M or PAL-N, select the system manually.

PAL/SECAM/NTSC/NTSC4.43/PAL-M/PAL-N

If the projector cannot reproduce proper video image, select a specific broadcast signal format from among PAL, SECAM, NTSC, NTSC 4.43, PAL-M, and PAL-N.

AV System Menu (Video or S-Video)

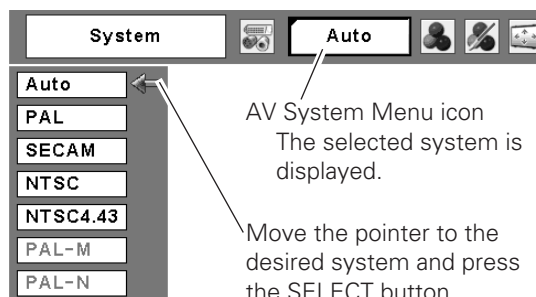

Component

Auto

The projector automatically detects an incoming video signal, and adjusts itself to optimize its performance.

COMPONENT VIDEO SIGNAL FORMAT

If the projector cannot reproduce proper video image, select a specific component video signal format from among 480i, 575i, 480p, 575p, 720p, 1035i, and 1080i.

AV System Menu (Component)

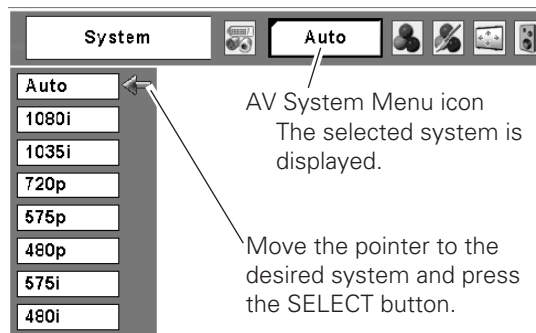

✓Note:

- The AV System Menu cannot be selected when selecting RGB (Scart).

Image Level Selection

Direct Operation

Select an image level from among Dynamic, Standard, Cinema, Blackboard (Green), Image 1, Image 2, Image 3, and Image 4 with the IMAGE button on the remote control.

Dynamic

For viewing pictures in a bright room.

Standard

Normal picture level preset on this projector.

Cinema

Picture level adjusted for the picture with fine tone.

Blackboard(Green)

For viewing the image projected on a blackboard.
This mode assists to enhance the image projected on a blackboard. This is mainly effective on a green colored board, not truly effective on a black colored board.

Image 1-4

User preset image in the Image Adjust Menu (pp.39-40).

Menu Operation

- 1 Use the MENU button to display the On-Screen Menu. Press the Point ◀▶ buttons to move the red frame pointer to the Image Select Menu icon.
- 2 Use the Point ▲▼ buttons to move the red frame pointer to the desired level and then press the SELECT button.

Dynamic

For viewing picture in a bright room.

Standard

Normal picture level preset on this projector.

Cinema

Picture level adjusted for the picture with fine tone.

Blackboard (Green)

For viewing the image projected on a Blackboard. See above for further description.

Image1-4

User preset image in the Image Adjust Menu (pp.39-40).

Remote Control

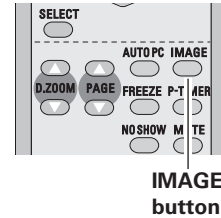

IMAGE button

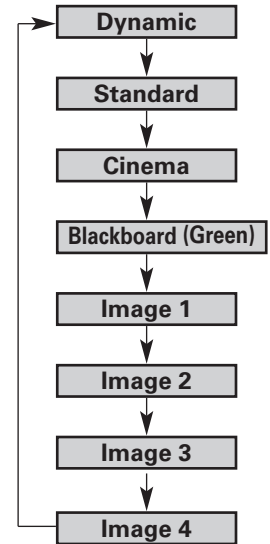

Image Select Menu

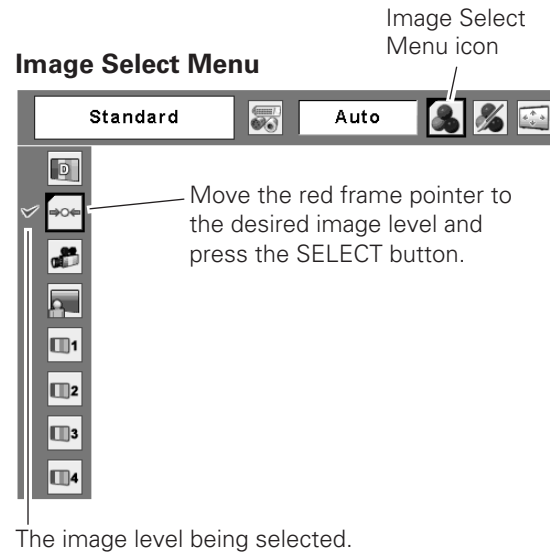

Image Level Adjustment

- 1 Press the MENU button to display the On-Screen Menu. Use the Point ◀▶ buttons to move the red frame pointer to the Image Adjust Menu icon.
- 2 Use the Point ▲▼ buttons to move the red frame pointer to the desired item and then press the SELECT button. The level of each item is displayed. Adjust each level by pressing the Point ◀▶ buttons.

Contrast

Press the Point ◀ button to decrease the contrast; press the Point ▶ button to increase the contrast (from 0 to 63).

Brightness

Press the Point ◀ button to decrease the brightness; press the Point ▶ button to increase the brightness (from 0 to 63).

Color

Press the Point ◀ button decrease the intensity of the color; press the Point ▶ button increase the intensity of the color (from 0 to 63).

Tint

Use the Point ◀▶ buttons to adjust the tint value to get a proper color balance (from 0 to 63).

Color temp.

Use the Point ◀ ▶ buttons to select the desired Color temp. level (XLow, Low, Mid, or High).

White balance (Red)

Press the Point ◀ button to lighten the red tone; press the Point ▶ button to deepen the red tone (from 0 to 63).

White balance (Green)

Press the Point ◀ button to lighten the green tone; press the Point ▶ button to deepen the green tone (from 0 to 63).

White balance (Blue)

Press the Point ◀ button to lighten the blue tone; press the Point ▶ button to deepen the blue tone (from 0 to 63).

✓Notes:

- The Tint cannot be selected when the video system is PAL, SECAM, PAL-M, or PAL-N.
- After adjusting the White balance Red, Green or Blue, the Color temp. level will change to "Adj."

Image Adjust Menu

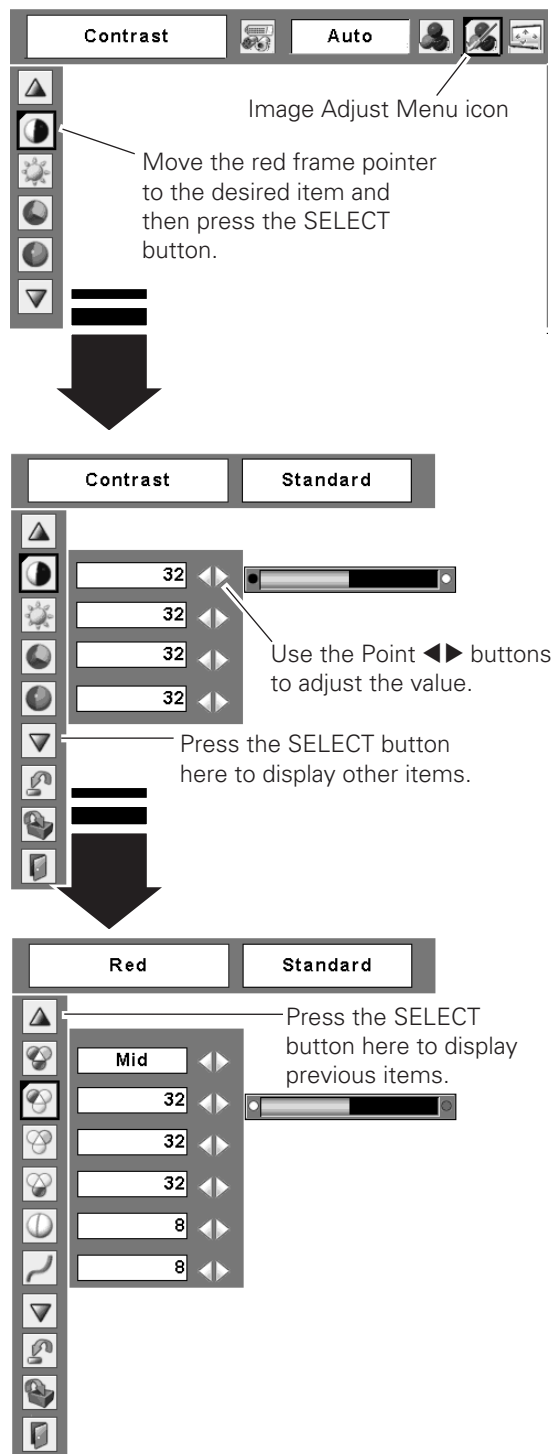



Press the Point ◀ button to decrease the sharpness of the better balance of contrast (f.6(3 qualitS.0772 Tw260.77 2.9825 TD-0.000227.59Gamma)TjET0 0 0 0 k56.69 695.62 18.43 -78.

Gamma

Use the Point ◀▶ buttons to adjust the gamma value to get better balance of contrast (from 0 to 15).



Noise reduction

Noise interference on the screen can be reduced. Select one of the following options to get smoother images.

- Off..... disabled.
- L1..... lower reduction
- L2..... higher reduction



Progressive

An interlaced video signal can be displayed in a progressive picture. Select one of the following options.

- Off..... Disabled.
- L1..... For an active picture.
- L2..... For a still picture.
- Film..... For watching a film. With this function, the projector reproduces pictures faithful to the original film quality.



Reset

To reset the adjusted data, select Reset and press the SELECT button. A confirmation box appears and then select "Yes." All adjustments return to their previous figures.



Store

To store the adjusted data, select Store and press the SELECT button. Select a level from Image 1 to 4 with the Point ▲▼ buttons and press the SELECT button. A confirmation box appears and then select "Yes." Stored data can be called up by selecting "Image" in the Image Level Selection on page 38.



Quit

Exit the Image Adjust Menu.

✓Note:

- Noise reduction and Progressive cannot be selected when 480p, 575p, 720p, 1035i, or 1080i is selected (p.37).

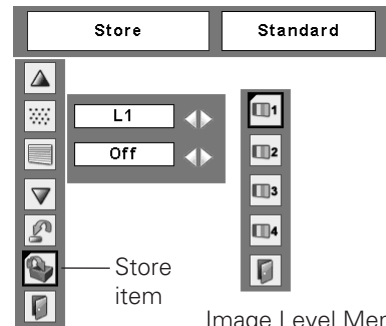
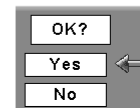

Image Level Menu

Move the red frame pointer to an image item to be set and then press the SELECT button.



A confirmation box appears and then select "Yes."

Screen Size Adjustment

This projector has the picture screen resize function, which enables you to customize the image size.

- 1 Press the MENU button to display the On-Screen Menu. Use the Point ◀▶ buttons to move the red frame pointer to the Screen Menu icon.
- 2 Use the Point ▲▼ buttons and move the red frame pointer to the desired function and then press the SELECT button.

Screen Menu

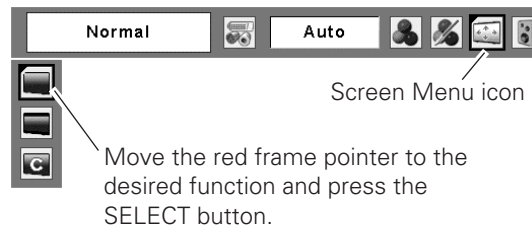

Normal

Provide the image at a normal video aspect ratio of 4:3.

Wide

Provide the image at a wide screen ratio of 16:9.

Custom

Adjust the screen scale and position manually. Press the SELECT button at Custom icon. "Custom" is displayed on the screen for a few seconds and then the Aspect dialog box appears.

- Scale H/V..... Adjust the Horizontal/Vertical screen scale.
- H&V..... When selecting "On," the aspect ratio is fixed. "Scale V" appears dimmed and becomes unavailable. Adjust Scale H, then the screen scale is automatically modified based on the aspect ratio.
- Position H/V Adjust the Horizontal/Vertical screen position.
- Common Save the adjusted scale. Press the SELECT button at Common to display the confirmation box. To save the scale, press the SELECT button at "Yes." When Custom is selected, the saved scale is used.
- Reset..... Reset the Common data. Press the SELECT button at Reset to display the confirmation box. To reset, press the SELECT button at "Yes."

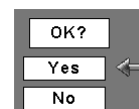
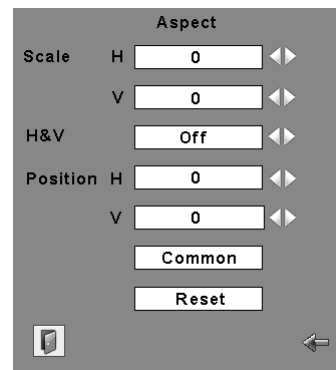

Press the SELECT button at Common or Reset, to display the confirmation box.

✓Notes:

- Wide is not available when 720p, 1035i, or 1080i is selected in the AV System Menu (p.37).
- When no signal is detected, Normal is set automatically and "Aspect" screen disappears.
- The adjustable range of Scale H/V and Position H/V can be limited depending on the input signal.

Setting

This projector has Setting menu that allows you to set up the other various functions described as follows:

- 1 Press the MENU button to display the On-Screen Menu. Use the Point ◀▶ buttons to move the red frame pointer to the Setting Menu icon.
- 2 Use the Point ▲▼ buttons to move the red frame pointer to the item that you want to set and then press the SELECT button. The Setting dialog box appears.

Language

The language used in the On-Screen Menu is available in English, German, French, Italian, Spanish, Portuguese, Dutch, Swedish, Finnish, Polish, Hungarian, Romanian, Russian, Chinese, Korean, or Japanese.

Keystone

This function corrects distortion of a projected image. Select either Store or Reset with the Point ◀▶ buttons, and then press the SELECT button. The keystone dialog box appears. Correct keystone with the Point ▲▼ buttons (p.23).

- Store Store the keystone correction even when the AC power cord is unplugged.
- Reset Reset the keystone correction when the AC power cord is unplugged.

Blue back

Press the Point ◀▶ buttons to switch on/off. When this function is "On," a blue image is displayed while the input signal is not detected.

Display

Press the Point ◀▶ buttons to switch on/off. This function decides to display On-Screen Displays.

- On Display all the On-Screen Displays. Use this function when you want to project images after the lamp becomes bright enough. This mode is set as a default.
- Countdown off ... Display the input image instead of the countdown when turning on the projector. Use this function when you want to project the image as early as possible even when the lamp is not bright enough.
- Off Do not show On-Screen Displays. except:

- On-Screen Menu
- "Power off?"
- P-Timer
- "No signal" for Power management item (p.45)
- "Please wait..."
- White arrows for panning mode (pp.33–34)

Setting Menu (Language)

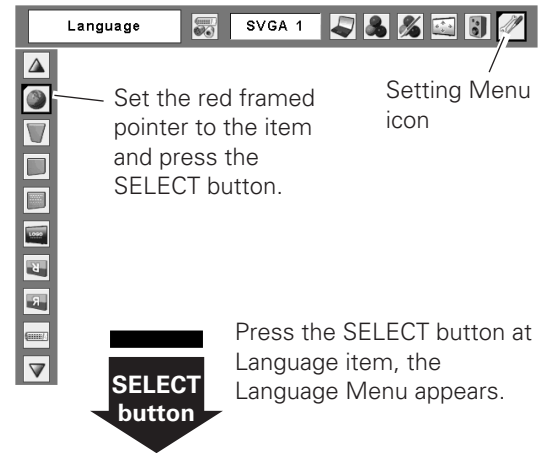

Press the SELECT button at Language item, the Language Menu appears.

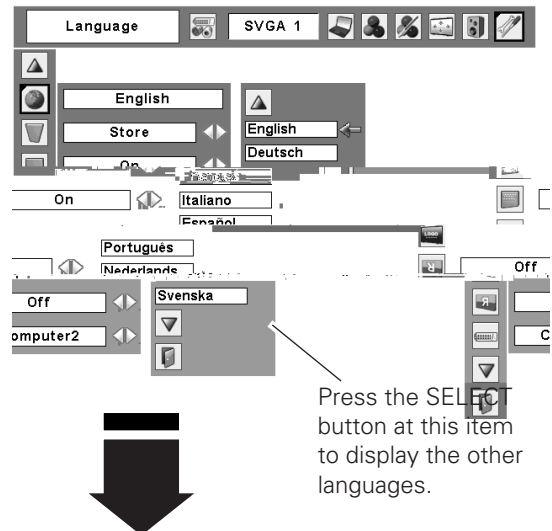

Press the SELECT button at this item to display the other languages.

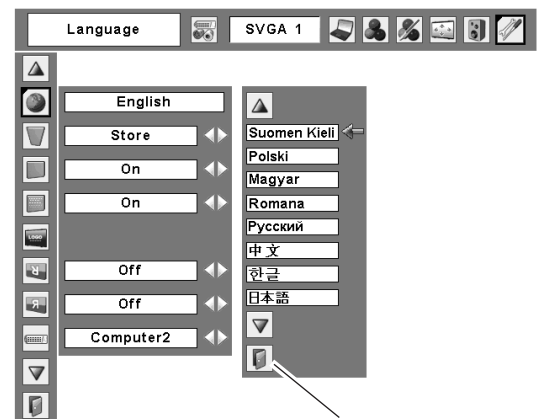

Press the SELECT button at this item to close the dialog box.



Logo (Logo and Logo PIN code lock settings)

This function allows you to customize the screen logo with Logo select, Capture, and Logo PIN code lock functions.

✓Note:

- When "On" is selected in Logo PIN code lock function, Logo select and Capture functions cannot be selected.



Logo select

This function decides the start-up display as follows:

- User The image you captured
- Default The factory-set logo
- Off..... Countdown only

Logo select

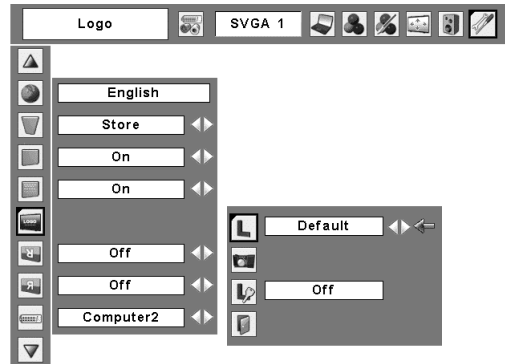

Capture

This function enables you to capture the image being projected and use it for a start-up display or interval of presentations.

After capturing the projected image, go to the Logo select function and set it to "User." Then the captured image is displayed when turning on the projector next time or pressing the NO SHOW button (p 25).

To capture the image, select "Yes." To cancel the Capture function, select "No."

✓Notes:

- Before capturing an image, select "Standard" in the Image Select Menu to capture a proper image (pp.31, 38).
- A signal from a computer can be captured up to XGA(1024x768). A signal from video equipment can be captured except for 720p, 1035i, and 1080i.
- When capturing the image that has been adjusted by the Keystone function, the adjusted data is automatically reset and the projector captures an image without keystone adjustment.
- When the Logo PIN code lock function is "On," Capture menu cannot be selected.
- When starting to capture a new image, the previously stored image is cleared even if you cancel the capturing.

Capture

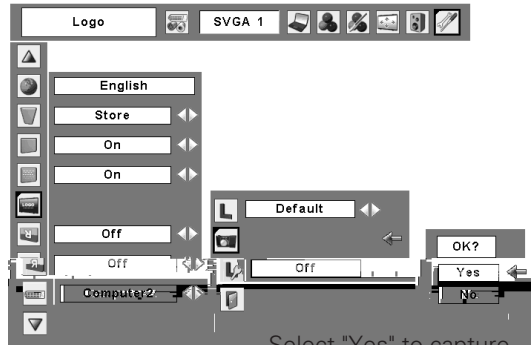

Select "Yes" to capture the projected image.

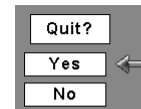

Select "Yes" to stop capturing.





Logo PIN code lock

This function prevents an unauthorized person from changing the screen logo.

- Offthe screen logo can be changed freely from the Logo select menu (p.43).
- Onthe screen logo cannot be changed without the Logo PIN code.

If you want to change the Logo PIN code setting, enter a Logo PIN code along the following steps. The initial Logo PIN code is set "4321" at the factory.

Enter a Logo PIN code

Use the Point ◀▶ buttons to select a number and press the SELECT button to fix the number; the number changes to "*"." If you fixed an incorrect number, move the pointer to "Set" or "Clear" once by pressing the Point ▼ button, then return to "Logo PIN code." Enter the correct number.

Repeat this step to complete entering a four-digit number.

When the four-digit number is fixed, the pointer automatically moves to "Set." Press the SELECT button so that you can change the Logo PIN code lock setting.

If you entered an incorrect Logo PIN code, "Logo PIN code," the numbers (****) will turn red and disappear. Enter the Logo PIN code all over again.

Change the Logo PIN code

Logo PIN code can be changed to your desired four-digit number. Select "Logo PIN code change" with the Point ▼ button and press the SELECT button. Set a new Logo PIN code.

Be sure to note the new Logo PIN code and keep it at hand. If you lost the number, you could no longer change the Logo PIN code setting. For details on PIN code setting, refer to relevant instructions of the PIN code lock function on pages 47–48.

CAUTION:
WHEN YOU HAVE CHANGED THE LOGO PIN CODE, TAKE A MEMO AND KEEP IT SECURELY. SHOULD THE LOGO PIN CODE BE LOST OR FORGOTTEN, THE LOGO PIN CODE SETTING CAN NO LONGER BE CHANGED.

Logo PIN code lock

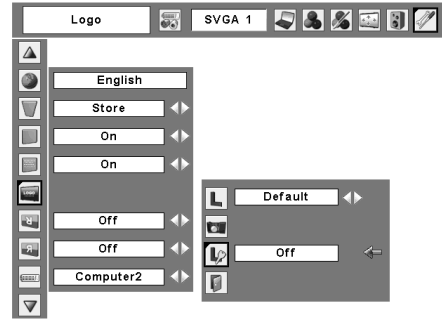

Logo PIN code lock Dialog Box



After a correct Logo PIN code is entered, the following dialog box appears.

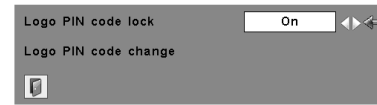

Select On/Off by pressing the Point ◀▶ buttons or change the Logo PIN code.

 **Ceiling**

When this function is set to "On," the picture is top/bottom and left/right reversed. This function is used to project the image from a ceiling-mounted projector.

 **Rear**

When this function is set to "On," the picture is left/right reversed. This function is used to project the image to a rear projection screen.

 **Terminal**

The COMPUTER IN 2/MONITOR OUT terminal on the back of the projector is switchable for computer input or monitor output (p.9). Select Computer 2 or Monitor Out with the Point ◀▶ buttons.

- Computer 2 computer input
- Monitor Out monitor out

Terminal function is not available when selecting Computer 2 to the input source. Change the input source to the others (Computer1 or Video) so that the Terminal function is available (pp.26, 35–36).

 **Power management**

For reducing power consumption as well as maintaining the lamp life, the Power management function turns off the projection lamp when the input signal is interrupted and no button is pressed for a certain period.

When the input signal is interrupted and no button is pressed for more than 30 seconds, the timer display with "No signal" appears. The countdown starts to turn off the lamp.

Select one of the operations.

- Ready When the lamp has been fully cooled down, the POWER indicator changes to green blinking. In this condition, the projection lamp is turned on if the input signal is reconnected or any button on the top control or on the remote control is pressed.
- Shut down When the lamp has been fully cooled down, the power is turned off.
- Off Power management function is off.

Then set the countdown timer with the Point ◀▶ buttons.

Ceiling

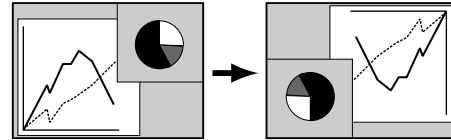

Rear

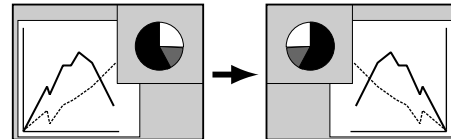

Power management



Time left before Lamp is off.

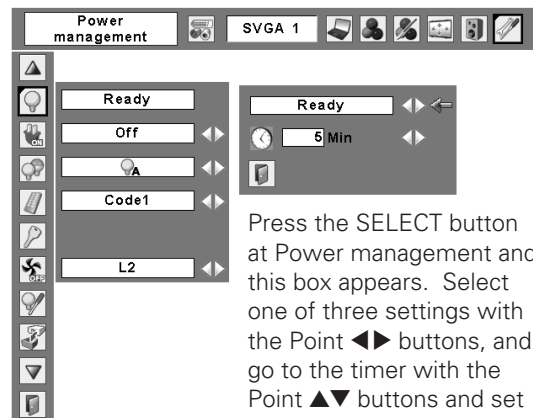

Press the SELECT button at Power management and this box appears. Select one of three settings with the Point ◀▶ buttons, and go to the timer with the Point ▲▼ buttons and set time with the Point ◀▶ buttons.



On start

When this function is set to “On,” the projector is automatically turned on just by connecting the AC power cord to an outlet.

✓Note:

- Be sure to turn the projector off properly (see “Turning Off the Projector” on page 20). If the projector is turned off in the incorrect sequence, the On start function does not operate properly.



Lamp control

You can change the brightness of the screen.

- Normal Normal brightness
- Auto Brightness according with the input signal
- Eco Lower brightness reduces the lamp power consumption and extends the lamp life.



Remote control

This projector provides two different remote control codes; the factory-set, initial code (Code 1) and the secondary code (Code 2). This switching function prevents remote control interference when operating several projectors or video equipment at the same time.

When operating the projector in “Code 2,” both the projector and the remote control must be switched to “Code 2.”

To change the code for the projector:

Select either “Code 1” or “Code 2” in this Setting Menu.

To change the code for the remote control:

Press and hold both the MENU and IMAGE buttons together for more than 10 seconds. After changing the code, make sure the remote control operates properly.

✓Notes:

- When different codes are set on the projector and on the remote control, any operation cannot be made. In that case, switch the code on the remote control to fit the code on the projector.
- When the batteries of the remote control are replaced, the remote control code automatically returns to the initial code (Code 1).

On start

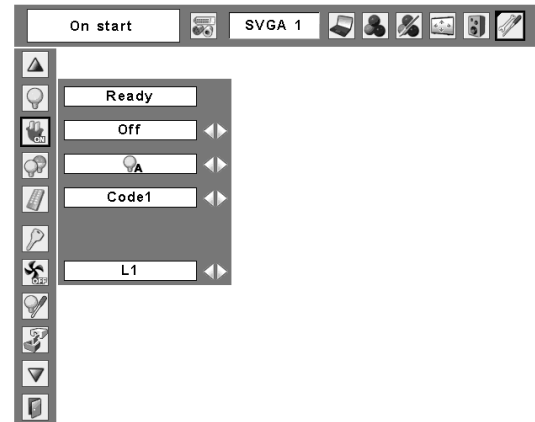

Remote control

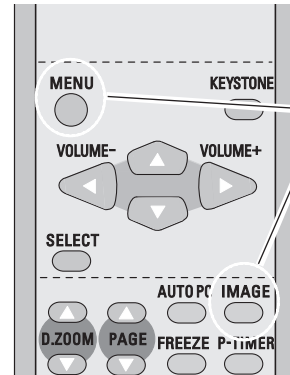



Press and hold MENU and IMAGE buttons for more than 10 seconds.

 **Security (Key lock, PIN code lock, and Alarm settings)**

This function allows you to use Key lock, PIN code lock, and Alarm functions to set the security for the projector operation.

 **Key lock**

This function locks operation of the top control and remote control. It helps to prevent operation by an unauthorized person.

-  Unlocked.
-  Locks operation of the top control. To unlock, use the remote control.
-  Locks operation of the remote control. To unlock, use the top control.

If the top control accidentally becomes locked and you do not have the remote control nearby or there is something wrong with your remote control, contact the dealer where you purchased the projector or the service center.

 **PIN code lock**

This function prevents the projector from being operated by unauthorized persons and provides the following setting options for security.

- Off.....The projector is not locked with the PIN code.
- On1.....Requires to enter a PIN code every time turning on the projector.
- On2.....Requires to enter a PIN code to operate the projector once the power cord is disconnected; as long as the AC power cord is connected, the projector can be operated without a PIN code.

Whenever you change the PIN code lock setting or the PIN code (a four-digit number), you are required to enter the PIN code. "1234" is set as the initial PIN code at the factory.

Key lock

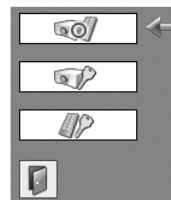
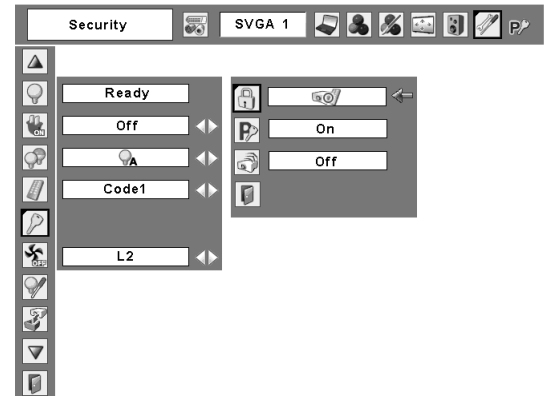

Select Key lock and this dialog box appears. Use the Point ▲▼ buttons to choose one of the options and select "Yes" to activate it.

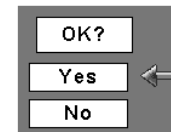

PIN code lock

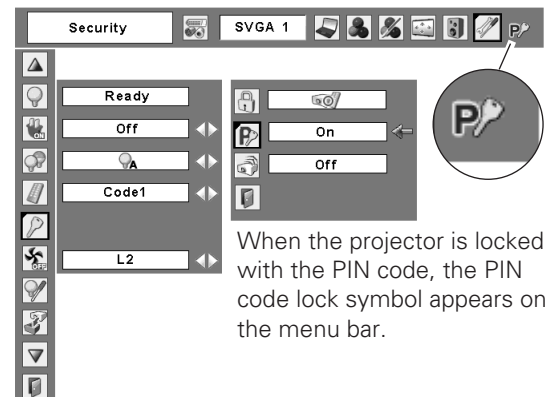

When the projector is locked with the PIN code, the PIN code lock symbol appears on the menu bar.

Enter a PIN code

Use the Point ◀▶ buttons to select a number and press the SELECT button to fix the number; the number changes to “*.” If you fixed an incorrect number, move the pointer to “Set” or “Clear” once by pressing the Point ▼ button, then return to “PIN code.” Enter the correct number.

Repeat this step to complete entering a four-digit number.

When the four-digit number is fixed, the pointer automatically moves to “Set.” Press the SELECT button so that you can change the following PIN code lock settings.

If you entered an incorrect PIN code, “PIN code” and the number (****) turn red and disappear. Enter the PIN code all over again.

Change the PIN code lock setting

Select Off, On1, or On2 with the Point ◀▶ buttons and then move the red frame pointer to “Quit” with the Point ▼ button. Press the SELECT button to close the dialog box.

Change the PIN code

The PIN code can be changed to your desired four-digit number.

Select “PIN code change” with the Point ▼ button, and press the SELECT button to display the New PIN code input dialog box.

Select a number with the Point ◀▶ buttons and fix the number with the SELECT button. Repeat it to complete entering a four-digit number. When the four-digit number is fixed, the pointer automatically moves to “Set.” Then press the SELECT button.

CAUTION:
WHEN YOU HAVE CHANGED THE PIN CODE, TAKE A MEMO AND KEEP IT SECURELY. IF YOU FORGET YOUR PIN CODE, THE PROJECTOR CAN NO LONGER BE STARTED.

 **Alarm**

This function allows you to configure the Alarm operation. See pages 50–52 for the Antitheft alarm function.

Enter a PIN code

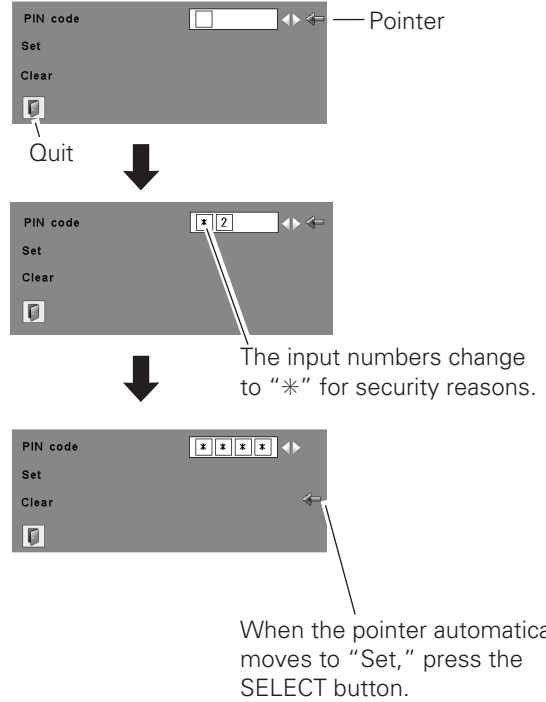

Change the PIN code lock setting



Change the PIN code

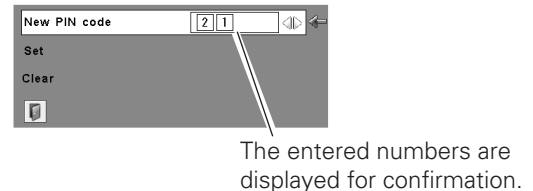
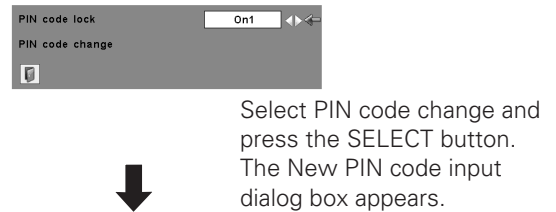



Fan

This function provides the following options in the cooling fans' operation after turning off the projector (p.20).

- L1..... Normal operation
- L2..... Slower and lower-sound than the normal operation (L1), but it takes longer to cool down the projector.



Lamp counter

This function is used to reset the lamp replacement counter. When replacing the projection lamp, reset the lamp replacement counter by using this function. See page 57 for operation.



Factory default

This function returns all setting values except for the user logo, PIN code lock, Logo PIN code lock and the lamp counter to the factory default settings.



Quit

Exit the Setting Menu.

Factory default

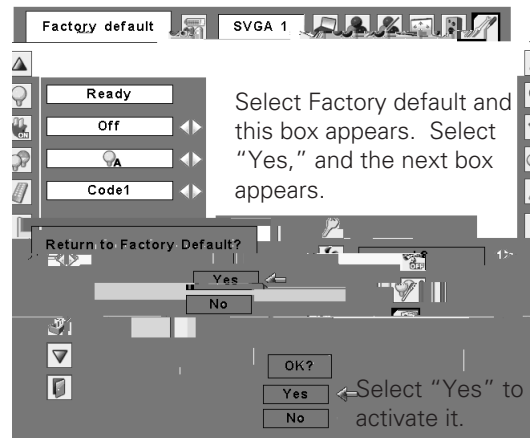

Antitheft Alarm Function

How to Use the Antitheft Alarm Function

The Antitheft alarm function is provided to prevent the projector from being stolen. When this function is set to "On," the alarm rings as an unauthorized person tries to move the projector.

✓Notes:

- This function is not a guarantee against stealing.
- The alarm does not ring while the AC power cord is connected to an outlet even if the projector detects vibrations.
- Pressing the buttons is always accompanied by a sound. If no sound is produced after pressing a button, you need to press it again.

Install a battery

Before operating the Antitheft alarm function, install a battery in the projector (see page 52 for installation).

Set and release the Antitheft alarm function

Set the alarm

Press the F button twice to turn the alarm function on. The ALARM indicator blinks for a few seconds and the projector enters the warning mode.

While the Antitheft alarm function is on, the projector emits a low-pitched sound when detecting a vibration. When the projector does not detect a vibration for a few seconds after the sound, it goes back to the warning mode. When the projector detects more vibrations after the low-pitched sound, the alarm starts ringing.

The Alarm operation configuration (Alarm volume, Sensitivity, and Ringing time) can be selected in the Alarm function on page 51.

✓Notes:

- You can test the alarming sound without setting the alarm. Press and hold the F button, then the alarm starts ringing.
- If you want to stop the alarm while it is ringing, insert the AC power cord to an outlet or press the F button and enter the four-digit PIN code number.

Release the alarm setting

Press the F button and enter the four-digit PIN code number within about 10 seconds. (The default PIN code is set to "1111.") When the alarm is released, you will hear a high-pitched confirmation sound.

When entering an incorrect PIN code, you will hear a low-pitched sound. If you enter an incorrect PIN code three times in a row, the alarm starts ringing.

Side Control

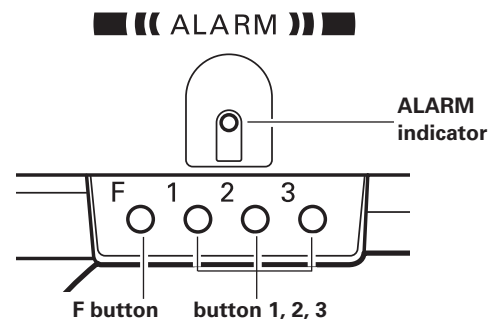

Other settings

Change the PIN code

- 1 Press the F button and enter the four-digit PIN code number within about 10 seconds. The ALARM indicator blinks red for a few seconds and a high-pitched confirmation sound is produced.
- 2 While the indicator is blinking, enter a new PIN code, then you will hear a high-pitched confirmation sound and the ALARM indicator is turned off.

When entering an incorrect PIN code, you will hear a low-pitched sound. If you enter incorrect PIN code three times in a row, the alarm starts ringing.

The PIN code for the Antitheft alarm function is a combination of 1, 2, or 3. Use the buttons 1, 2, and 3 to enter the PIN code. The default PIN code is set to "1111."

Reset the settings

Select Factory default in the Setting menu to reset the settings for the Antitheft alarm function.

✓Note:

- This is effective only when the Antitheft alarm setting is released.

Alarm operating configuration

The Alarm operating configuration can be changed when the Antitheft alarm function is set to "Off." See page 50 to set or release this function.

Press the SELECT button at Alarm icon in the Setting Menu to display the Alarm setting dialog box. Use the Point ▲▼ buttons to select Alarm volume, Sensitivity, or Ringing time, and set each item with the Point ◀▶ buttons.

Alarm volume

Small, Medium, Large

Sensitivity

LowLess sensitive
 MediumNormal sensitivity
 HighHighly sensitive (default)

Ringing time

10 secondsRings about 10 seconds (default).
 60 secondsRings about 60 seconds.
 Long timeRings until the end of the battery life.

CAUTION:

WHEN YOU HAVE CHANGED THE PIN CODE, WRITE DOWN THE NEW PIN CODE AND KEEP IT SECURELY. IF YOU FORGET YOUR PIN CODE, SOME SETTINGS OF THE ANTITHEFT ALARM FUNCTION CAN NO LONGER BE CHANGED.

Side Control

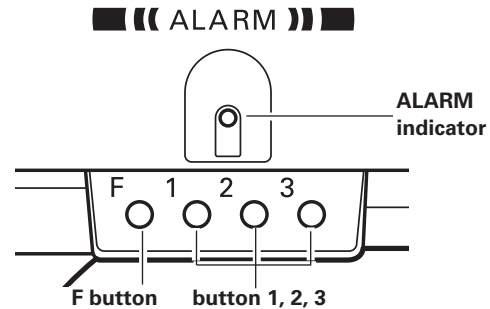

Alarm

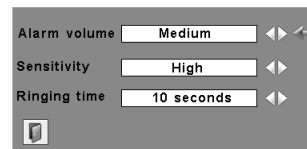
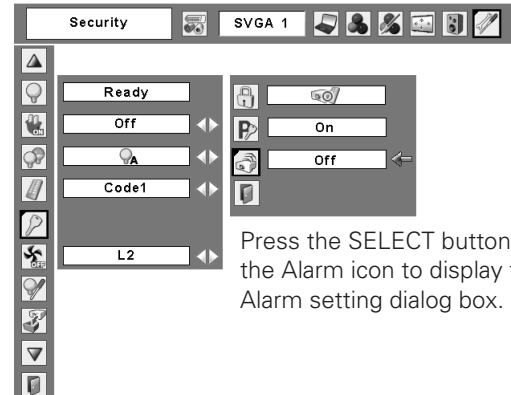

Set the Alarm volume, Sensitivity, or Ringing time with the Point ◀▶ buttons.

✓Notes:

- The Alarm icon appears dimmed and can be unavailable when the Antitheft alarm function is set to "On" or if the battery is not installed or it is coming to the end of its life.
- While the Alarm icon is selected, the Antitheft alarm setting buttons on the side panel can be unavailable.
- When selecting "Long time" option in the Ringing time, the duration of alarm sounding differs depending on the battery life.

How to install the battery

To use the Antitheft alarm function, you need to install a battery into the projector. (Use a SANYO Electric Co., Ltd. CR2 3V lithium battery.)

Unplug the AC power cord from a wall outlet before installing the battery. Remove the screw and open the battery cover on the bottom of the projector.

When the battery is installed properly, the ALARM indicator blinks for about 10 seconds. After placing the battery, put the cover back and secure it with the screw.

When the battery comes to the end of its life, the ALARM indicator flashes and the warning sound is produced at some intervals.

Replace the battery by following the procedures above.

✓Notes:

- *The PIN code and settings you have changed are effective even after the battery is changed.*
- *When changing the battery, set the Antitheft alarm function to "Off." Otherwise the alarm starts ringing as you try to open the battery cover.*

Loosen the screw and open the battery cover.



Install the battery, then put back the battery cover and secure it with the screw.

Maintenance and Cleaning

Warning Indicator

The WARNING indicator shows the state of the function which protects the projector. Check the state of the WARNING indicator and the POWER indicator to take proper maintenance.

The projector is shut down and the WARNING indicator is blinking red.

When the temperature inside the projector reaches a certain level, the projector is automatically shut down to avoid overheating. The POWER indicator is blinking while the projector is being cooled down. When the projector has cooled down enough (to its normal operating temperature), it can be turned on again by pressing the POWER ON-OFF button.

✓Note:

- The WARNING indicator continues to blink even after the temperature inside the projector returns to normal. When the projector is turned on again, the WARNING indicator stops blinking.

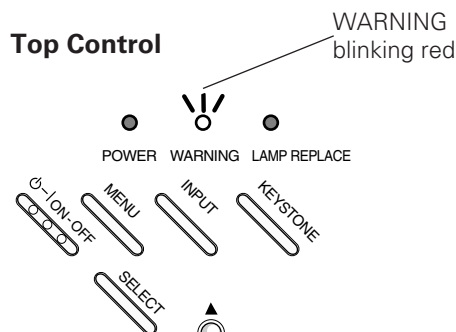

Then check the matters below:

- Did you provide appropriate space for the projector to be ventilated? Check the installing condition to see if ventilation slots are not blocked.
- Has the projector been installed near an Air-Conditioning/ Heating Duct or Vent? Move the installation of the projector away from the duct or vent.
- Are the air filters clean? Clean the air filters periodically. (p.54)

The projector is shut down and the WARNING indicator lights red.

When the projector detects an abnormal condition, it is automatically shut down to protect the inside of the projector and the WARNING indicator lights red. In this case, unplug the AC power cord and plug it, and then turn on the projector once again to verify operation. If the projector cannot be turned on and the WARNING indicator lights red, unplug the AC power cord and contact the service station.

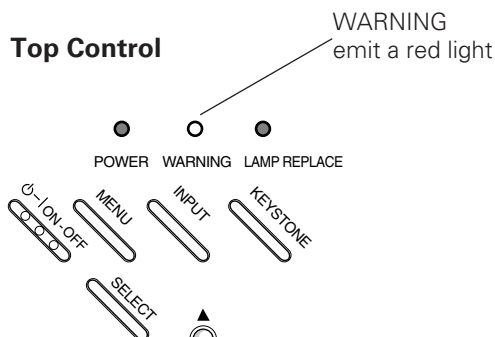

CAUTION

DO NOT LEAVE THE PROJECTOR WITH THE AC POWER CORD CONNECTED UNDER AN ABNORMAL CONDITION. IT MAY RESULT IN FIRE OR ELECTRIC SHOCK.



jectio

U cord before
F it with a blo
le lens cleanin
m (anol). Avoid e
Do ve cleaners,
ch to avoid damag
Wh tor is not in use, r

ning the Pro

the AC pow
wipe the pro
if it is he
deterge and
excess
othe
cr

soft dry cle
small amount
eaning cloth
re cleaners, solv
scratch the surface

When the projector is
appropriate case to

jector in an
atched.

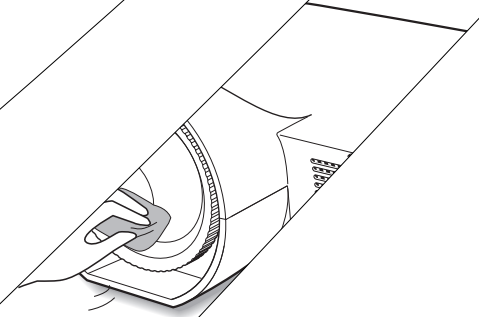

Lamp Replacement

When the projection lamp of the projector reaches the end of its life, the LAMP REPLACE indicator emits a yellow light. If this indicator lights yellow, replace the lamp with a new one promptly.



WARNING:
TURN OFF THE UV LAMP BEFORE
OPENING THE LAMP COVER

Top Control

POWER WARNING LAMP REPLACE
● ● ○

This indicator turns yellow when the projection lamp reaches the end of its life.



CAUTION

Allow the projector to cool for at least 45 minutes before you open the Lamp cover. The inside of the projector can become very hot.



CAUTION

For continued safety, replace with a lamp of the same type. Do not drop a lamp or touch a glass bulb! The glass can shatter and may cause injury.

Follow these steps to replace the lamp.

- 1** Turn off the projector and unplug the AC power cord. Let the projector cool for at least 45 minutes.
- 2** Turn the projector over. Remove the screw that secures the lamp cover, and then open the lamp cover.
- 3** Remove the two screws that secures the lamp. Lift the lamp out of the projector by using the built in handle.
- 4** Replace the lamp with a new one and secure it with the two screws. Make sure that the lamp is set properly. Put the lamp cover back and secure it with the screw.
- 5** Connect the AC power cord to the projector and turn on the projector.
- 6** **Reset the lamp replacement counter.**
See "Lamp Replacement Counter" on the next page.

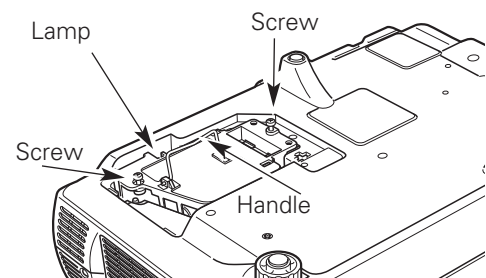
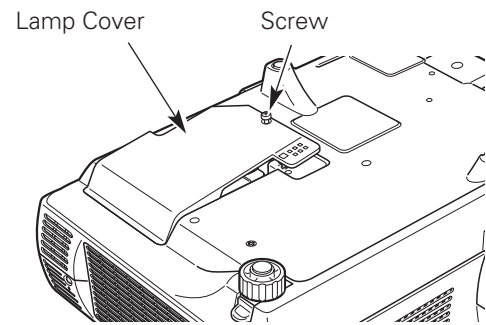

ORDER REPLACEMENT LAMP

Replacement lamp can be ordered through your dealer. When ordering a projection lamp, give the following information to the dealer.

- **Model No. of your projector** : **PLC-XL40**
- **Replacement Lamp Type No.** : **POA-LMP90**
(Service Parts No. 610 323 0726)

Lamp Replacement Counter

Be sure to reset the Lamp replacement counter after the lamp is replaced. When the Lamp replacement counter is reset, the LAMP REPLACE indicator stops lighting.

- 1 Turn the projector on and press the MENU button to display the On-Screen Menu. Use the Point ◀▶ buttons to move the red frame pointer to the Setting Menu icon.
- 2 Use the Point ▲▼ buttons to move the red frame pointer to Lamp counter and then press the SELECT button. The first dialog box appears showing the total accumulated lamp time and reset option. If you select Reset, "Lamp replacement counter Reset?" appears. Select "Yes" to continue.
- 3 Another confirmation dialog box appears, and select "Yes" to reset the Lamp replacement counter.

✓Note:

- Do not reset the Lamp replacement counter without implementing lamp replacement. Be sure to reset the Lamp replacement counter only after replacing the lamp.

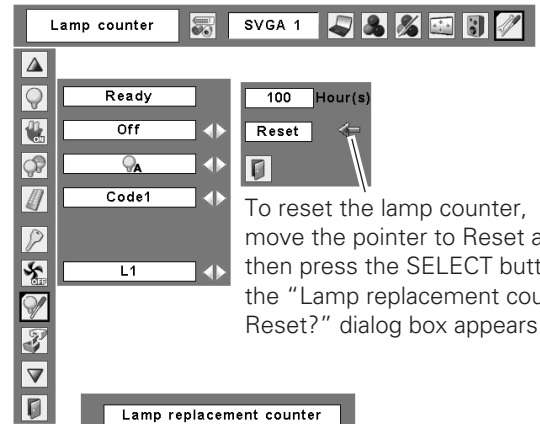

To reset the lamp counter, move the pointer to Reset and then press the SELECT button. The "Lamp replacement counter Reset?" dialog box appears.

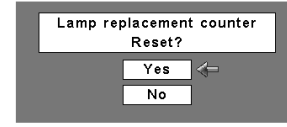

Select "Yes," then another confirmation box appears.

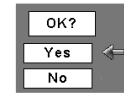

Select "Yes" again to reset the lamp counter.



LAMP HANDLING PRECAUTIONS

This projector uses a high-pressure lamp which must be handled carefully and properly. Improper handling may result in accidents, injury, or create a fire hazard.

- Lamp life may differ from lamp to lamp and according to the environment of use. There is no guarantee of the same life for each lamp. Some lamps may fail or terminate their life in a shorter period of time than other similar lamps.
- If the projector indicates that the lamp should be replaced, i.e., if the LAMP REPLACE indicator lights up, replace the lamp with a new one IMMEDIATELY after the projector has cooled down. (Follow carefully the instructions in the Lamp Replacement section of this manual.) Continuous use of the lamp with the LAMP REPLACE indicator lighted may increase the risk of lamp explosion.
- A Lamp may explode as a result of vibration, shock, or degradation as a result of hours of use, as it comes to the end of life. Risk of explosion may differ according to the environment or conditions in which the projector and lamp are being used.

IF A LAMP EXPLODES, THE FOLLOWING SAFETY PRECAUTIONS SHOULD BE TAKEN.

If a lamp explodes, disconnect the projector's AC plug from the AC outlet immediately. Contact an authorized service station for a checkup of the unit and replacement of the lamp. Additionally, check carefully to ensure that there are no broken shards or pieces of glass around the projector or coming out from the cooling air circulation holes. Any broken shards found should be cleaned up carefully. No one should check the inside of the projector except those who are authorized trained technicians and who are familiar with projector service. Inappropriate attempts to service the unit by anyone, especially those who are not appropriately trained to do so, may result in an accident or injury caused by pieces of broken glass.

Troubleshooting

Before calling your dealer or service center for assistance, check the items below once again.

- Make sure you have properly connected the projector to peripheral equipment as described on pages 16–18.
- Make sure all equipment is connected to an AC outlet and the power is turned on.
- When you operate the projector with a computer and it does not project an image, restart the computer.

Problem:	Solutions
No power	<ul style="list-style-type: none">– Plug the power cord of the projector into an AC outlet.– See if the POWER indicator lights red.– Wait 90–120 seconds after the projector is turned off when turning the projector back on. The projector can be turned on after the POWER indicator turns red (see page 20).– Check the WARNING indicator. If the WARNING indicator lights red, the projector cannot be turned on (see on page 53).– Check the projection lamp (see page 56).
Image is out of focus.	<ul style="list-style-type: none">– Adjust focus of the projector (see page 23).– Provide proper distance between the projector and the projection screen (see page 14).– Check the projection lens to see if it needs cleaning (see page 55).– Moving the projector from a cool to warm place may result in moisture condensation on the projection lens. If this occurs, leave the projector off and wait until condensation evaporates.
No image	<ul style="list-style-type: none">– Check the connection between your computer or video equipment and the projector (see pages 16–18).– See if the input signal is correctly output from your computer. Some laptop computers may need to change the setting for monitor output when connecting to the projector. See your computer's instruction manual for the setting.– It takes about 30 seconds to display an image after turning on the projector.– See if the selected system is corresponding with your computer or video equipment (see pages 27, 37).– Select correct input source once again through menu operation (see pages 26, 35–36).– Make sure the temperature is not out of the specified operating temperature (41 °F–95 °F [5 °C–35 °C]).
Image is Left/Right reversed. Image is Top/Bottom reversed.	<ul style="list-style-type: none">– Check the Ceiling/Rear function (see page 45).– Check the Ceiling function (see page 45).
No sound	<ul style="list-style-type: none">– Check the audio cable connection from audio input source.– Adjust the audio source.– Press the Volume + button (see page 24).– Press the Mute button (see page 24).

<i>Some displays are not seen during the operation.</i>	– Check the Display function (see page 42).
<i>PIN code dialog box appears at start-up.</i>	– PIN code lock is being set. Enter a PIN code; the “1234” or numbers you have set (see pages 19, 47–48).
<i>Computer 2 cannot be selected.</i>	– Select Computer 2 in the Terminal function (see page 45).
<i>The Terminal function cannot be selected.</i>	– The Terminal function cannot be selected after Computer 2 is selected. Select other input source such as Computer 1 or Video with the COMPUTER button or the VIDEO button on the remote control so that the Terminal function can be selected.
<i>The Remote Control does not work.</i>	<ul style="list-style-type: none"> – Check the batteries. – Make sure no obstruction is between the projector and the remote control. – Make sure you are not too far from the projector when using the remote control. Maximum operating range is 16.4’ (5 m). – Make sure the code of the remote control is conformed to that of the projector (see page 46). – Unlock the Key lock function for the remote control (see page 47).
<i>Cooling fans are still running after the AC plug is disconnected.</i>	– This is a normal condition. The fans keep running for a certain time even after disconnecting the AC plug.

WARNING :

High voltages are used to operate this projector. Do not attempt to open the cabinet.

If problems still persist after following all operating instructions, contact the dealer where you purchased the

 The CE Mark is a Directive conformity mark of the European Community (EC).

Menu Tree

Computer Input/Video Input

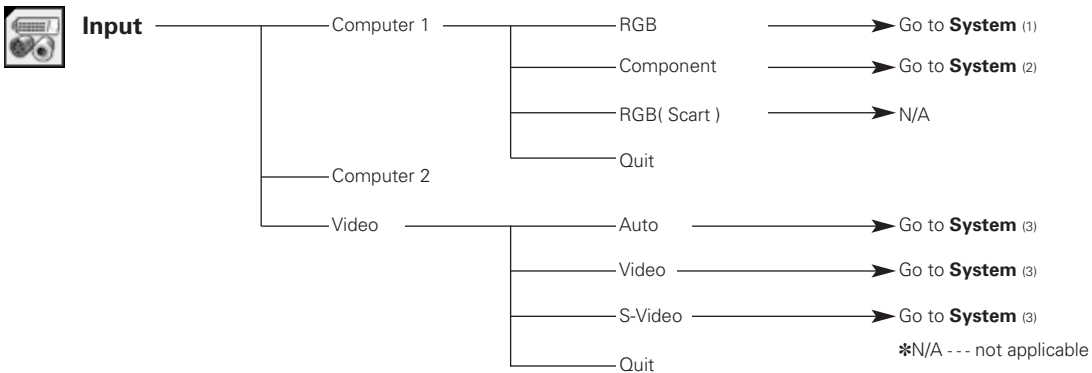

Sound

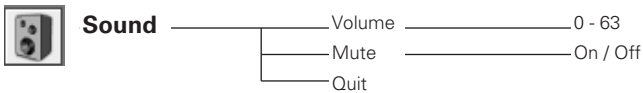

Computer Input

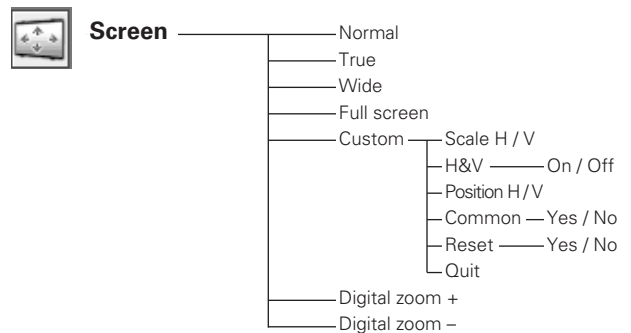
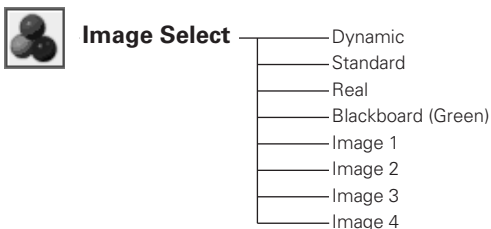
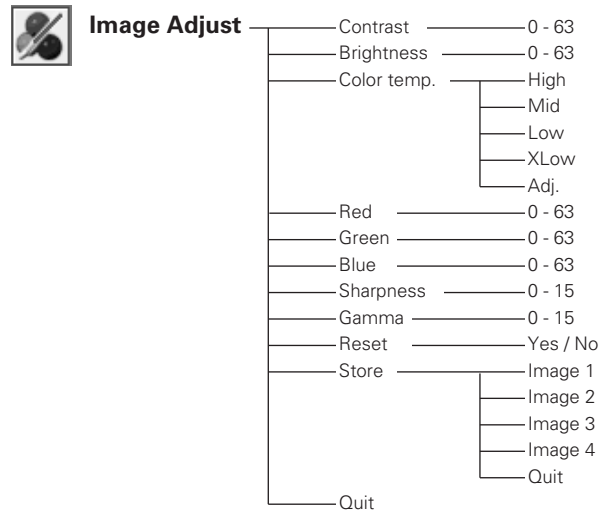
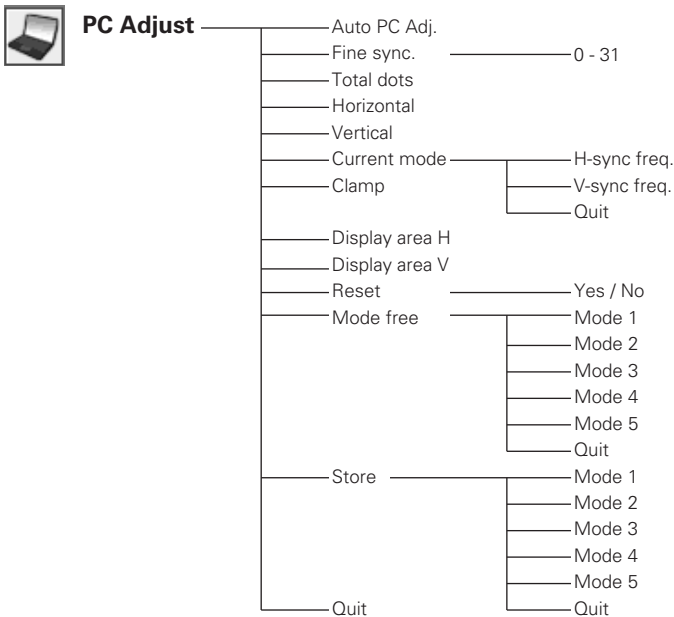
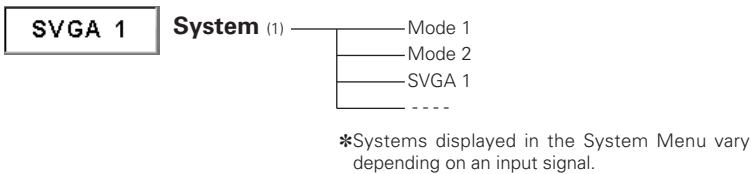

Video Input

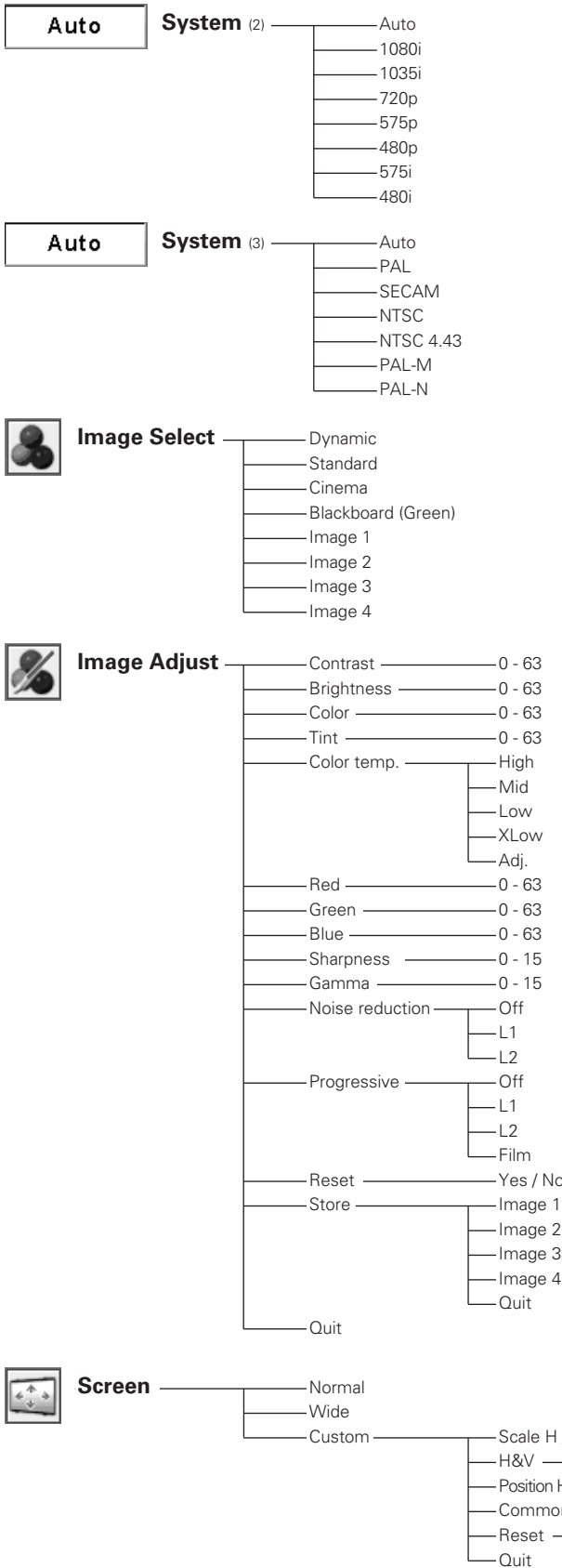



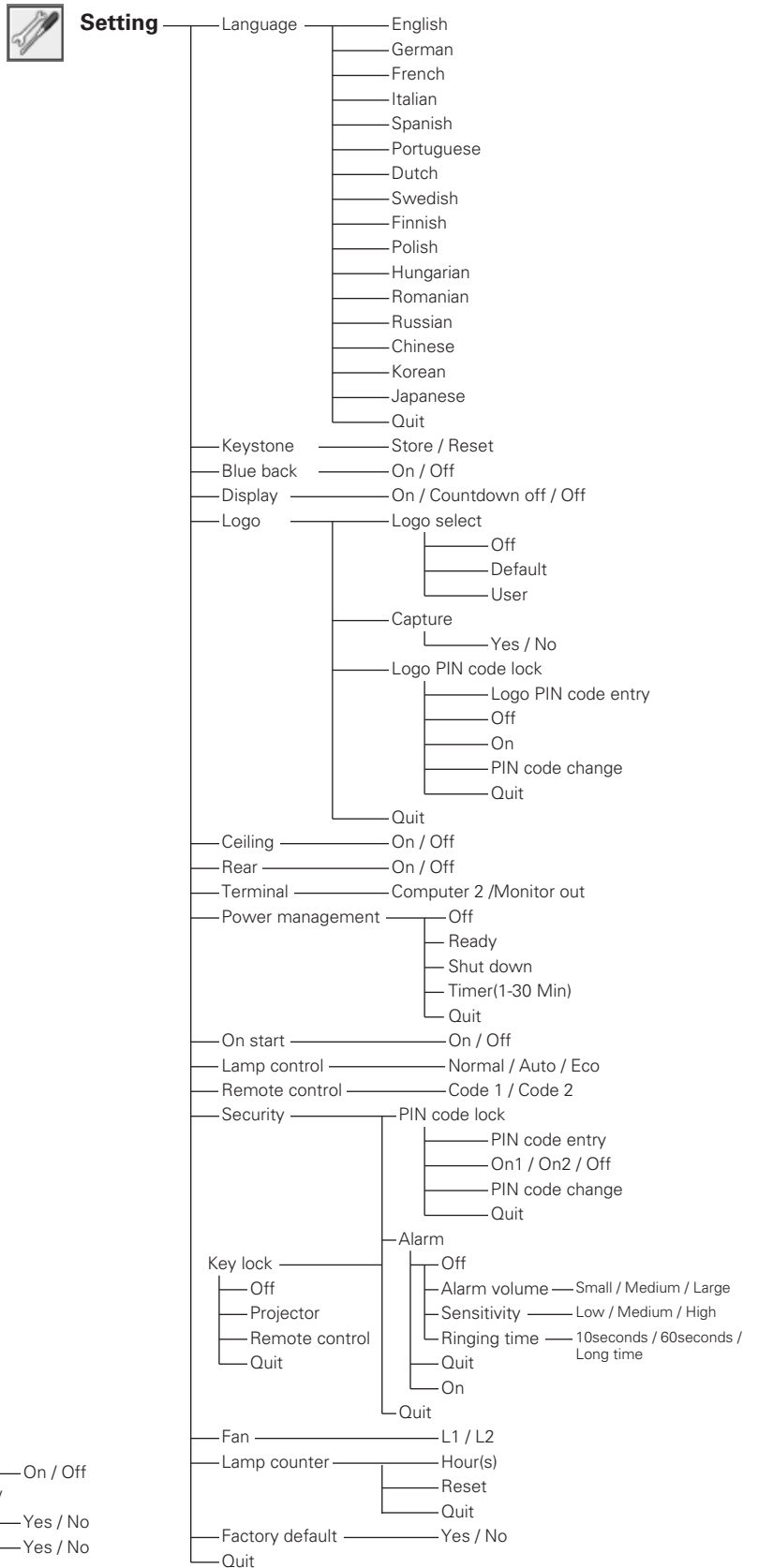





















Setting



Indicators and Projector Condition

Check the indicators for projector condition.

Indicators			Projector Condition
POWER red/green	WARNING red	LAMP REPLACE yellow	
			The projector is off. (The AC power cord is unplugged.)
			The projector is preparing for stand-by or the projection lamp is being cooled down. The projector cannot be turned on until cooling is completed.
			The projector is ready to be turned on with the POWER ON-OFF button.
			The projector is operating normally.
			The projector is in the Power management mode.
			The temperature inside the projector is abnormally high. The projector cannot be turned on. When the projector is cooled down enough and the temperature returns to normal, the POWER indicator emits a red light and the projector can be turned on. (The WARNING indicator keeps blinking.) Check and clean the air filters.
			The projector has been cooled down enough and the temperature returns to normal. When turning on the projector, the WARNING indicator stops blinking. Check and clean the air filters.
			The projector detects an abnormal condition and cannot be turned on. Unplug the AC power cord and plug it again to turn on the projector. If the projector is turned off again, disconnect the AC power cord and contact the dealer or the service center for service and checkup. Do not leave the projector on. It may cause an electric shock or a fire hazard.

 ••• green.

 ••• red

 ••• off

 ••• blinks green.

 ••• blinks red.

*When the projection lamp reaches the end of its life, the LAMP REPLACE indicator lights yellow. When this indicator lights yellow, replace the projection lamp with a new one promptly. Reset the lamp replacement counter after replacing the lamp. See pages 56–57.

Compatible Computer Specifications

Basically this projector can accept the signal from all computers with the V-, H-Frequency mentioned below and less than 140 MHz of Dot Clock.

 When selecting these modes, PC adjustment can be limited.

ON-SCREEN DISPLAY	RESOLUTION	H-Freq. (kHz)	V-Freq. (Hz)	ON-SCREEN DISPLAY	RESOLUTION	H-Freq. (kHz)	V-Freq. (Hz)
VGA 1	640 x 480	31.47	59.88	SXGA 1	1152 x 864	64.20	70.40
VGA 2	720 x 400	31.47	70.09	SXGA 2	1280 x 1024	62.50	58.60
VGA 3	640 x 400	31.47	70.09	SXGA 3	1280 x 1024	63.90	60.00
VGA 4	640 x 480	37.86	74.38	SXGA 4	1280 x 1024	63.34	59.98
VGA 5	640 x 480	37.86	72.81	SXGA 5	1280 x 1024	63.74	60.01
VGA 6	640 x 480	37.50	75.00	SXGA 6	1280 x 1024	71.69	67.19
VGA 7	640 x 480	43.269	85.00	SXGA 7	1280 x 1024	81.13	76.107
MAC LC13	640 x 480	34.97	66.60	SXGA 8	1280 x 1024	63.98	60.02
MAC 13	640 x 480	35.00	66.67	SXGA 9	1280 x 1024	79.976	75.025
480p	640 x 480	31.47	59.88	SXGA 10	1280 x 960	60.00	60.00
575p	768 x 575	31.25	50.00	SXGA 11	1152 x 900	61.20	65.20
480i	————	15.734	60.00 (Interface)	SXGA 12	1152 x 900	71.40	75.60
575i	————	15.625	50.00 (Interface)	SXGA 13	1280 x 1024	50.00	86.00 (Interface)
SVGA 1	800 x 600	35.156	56.25	SXGA 14	1280 x 1024	50.00	94.00 (Interface)
SVGA 2	800 x 600	37.88	60.32	SXGA 15	1280 x 1024	63.37	60.01
SVGA 3	800 x 600	46.875	75.00	SXGA 16	1280 x 1024	76.97	72.00
SVGA 4	800 x 600	53.674	85.06	SXGA 17	1152 x 900	61.85	66.00
SVGA 5	800 x 600	48.08	72.19	SXGA 18	1280 x 1024	46.43	86.70 (Interface)
SVGA 6	800 x 600	37.90	61.03	SXGA 19	1280 x 1024	63.79	60.18
SVGA 7	800 x 600	34.50	55.38	SXGA 20	1280 x 1024	91.146	85.024
SVGA 8	800 x 600	38.00	60.51	SXGA 21	1400 x 1050	63.979	60.190
SVGA 9	800 x 600	38.60	60.31	SXGA 22	1400 x 1050	65.346	60.116
SVGA 10	800 x 600	32.70	51.09	SXGA 23	1400 x 1050	65.121	59.902
SVGA 11	800 x 600	38.00	60.51	MAC21	1152 x 870	68.68	75.06
MAC 16	832 x 624	49.72	74.55	MAC	1280 x 960	75.00	75.08
XGA 1	1024 x 768	48.36	60.00	MAC	1280 x 1024	80.00	75.08
XGA 2	1024 x 768	68.677	84.997	WXGA 1	1366 x 768	48.36	60.00
XGA 3	1024 x 768	60.023	75.03	WXGA 2	1360 x 768	47.70	60.00
XGA 4	1024 x 768	56.476	70.07	WXGA 3	1376 x 768	48.36	60.00
XGA 5	1024 x 768	60.31	74.92	WXGA 4	1360 x 768	56.16	72.00
XGA 6	1024 x 768	48.50	60.02	WXGA 6	1280 x 768	47.776	59.87
XGA 7	1024 x 768	44.00	54.58	WXGA 7	1280 x 768	60.289	74.893
XGA 8	1024 x 768	63.48	79.35	WXGA 8	1280 x 768	68.633	84.837
XGA 9	1024 x 768	36.00	87.17 (Interface)	WXGA 9	1280 x 800	49.600	60.050
XGA 10	1024 x 768	62.04	77.07	UXGA 1	1600 x 1200	75.00	60.00
XGA 11	1024 x 768	61.00	75.70	UXGA 2	1600 x 1200	81.25	65.00
XGA 12	1024 x 768	35.522	86.96 (Interface)	UXGA 3	1600 x 1200	87.5	70.00
XGA 13	1024 x 768	46.90	58.20	UXGA 4	1600 x 1200	93.75	75.00
XGA 14	1024 x 768	47.00	58.30	720p	1280 x 720	45.00	60.00
XGA 15	1024 x 768	58.03	72.00	1035i	1920 x 1035	33.75	60.00 (Interface)
MAC 19	1024 x 768	60.24	75.08	1080i/60	1920 x 1080	33.75	60.00 (Interface)
				1080i/50	1920 x 1080	28.12	50.00 (Interface)

Technical Specifications

Mechanical Information

Projector Type	Multi-media Projector
Dimensions (W x H x D)	10.50" x 4.86" x 9.58" (320 mm x 148 mm x 292 mm) (Not including adjustable feet)
Net Weight	7.3 lbs (3.3 kg)
Feet Adjustment	0° to 10.0°

Panel Resolution

LCD Panel System	0.6" TFT Active Matrix type, 3 panels
Panel Resolution	1,024 x 768 dots
Number of Pixels	2,359,296 (1,024 x 768 x 3 panels)

Signal Compatibility

Color System	PAL, SECAM, NTSC, NTSC4.43, PAL-M, and PAL-N
High Definition TV Signal	480i, 480p, 575i, 575p, 720p, 1035i, and 1080i
Scanning Frequency	H-sync. 15 kHz–100 kHz, V-sync. 50–100 Hz

Optical Information

Projection Image Size (Diagonal)	Adjustable from 60" to 80"
Projection Lens	F 1.85 lens with f 8.1 mm with manual focus
Throw Distance	2.49'–3.38' (0.76 m–1.03 m)
Projection Lamp	200 W

Interface

Video Input Jack	RCA Type x 1
S-Video Input Jack	Mini DIN 4 pin x 1
Audio Input Jacks	RCA Type x 2
Computer Input 1 / Component Input Terminal	Analog RGB (Mini D-sub 15 pin) Terminal x 1
Computer Input 2 / Monitor Output Terminal	Analog RGB (Mini D-sub 15 pin) Terminal x 1 (In/Out switchable)
Computer/ Component Audio Input Jack	Mini Jack (stereo) x 1
Service Port Connector	Mini DIN 8 pin x 1
USB Connector	USB Series B receptacle x 1
Audio Output Jack	Mini Jack (stereo) x 1 (Variable)

Audio

Internal Audio Amp	1.0 W RMS
Built-in Speaker	1 speaker, ø1.1" (28 mm)

Power

Voltage and Power Consumption	AC 100–120 V (2.9A Max. Ampere), 50/60 Hz (The U.S.A and Canada) AC 200–240 V (1.4 A Max. Ampere), 50/60 Hz (Continental Europe and The U.K.)
-------------------------------	--

Operating Environment

Operating Temperature	41°F–95°F (5°C–35°C)
Storage Temperature	14°F–140°F (-10°C–60°C)

Remote Control

Battery	AA or LR6 1.5V ALKALINE TYPE x 2
Operating Range	16.4' (5 m)/±30°
Dimensions	1.9" (W) x 0.87" (H) x 5.7" (D) (49 mm x 22 mm x 145.3 mm)
Net Weight	3.53 oz (100 g) (including batteries)

Antitheft Alarm

Battery	CR2 3V LITHIUM BATTERY x 1
---------	----------------------------

Accessories

Owner's Manual (CD-ROM)
 Quick Reference Guide
 AC Power Cord
 Remote Control and Batteries
 Battery for Antitheft alarm function
 VGA Cable
 Lens Cover with String
 PIN Code Label
 Alarm Label

- The specifications are subject to change without notice.
- LCD panels are manufactured to the highest possible standards. Even though 99.99% of the pixels are effective, a tiny fraction of the pixels (0.01% or less) may be ineffective by the characteristics of the LCD panels.

Optional Parts

The parts listed below are optionally available. When ordering those parts, specify the item name and Model No. to the sales dealer.

	<i>Model No.</i>
COMPONENT-VGA Cable	: POA-CA-COMPVGA
SCART-VGA Cable	: POA-CA-SCART
Mini D-sub Extension Cable	: KA-MC-DB10
Presentation Remote Control	: POA-RCKIT-03
Presentation Remote Control	: POA-RCKIT-04

Configurations of Terminals

COMPUTER INPUT/COMPONENT INPUT/MONITOR OUTPUT TERMINAL (ANALOG)

Terminal : Analog RGB (Mini D-sub 15 pin)

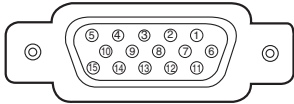

1	Red (R/Cr) Input / Output	9	----
2	Green (G/Y) Input / Output	10	Ground (Vert.sync.)
3	Blue (B/Cb) Input / Output	11	Ground / ----
4	----	12	----
5	Ground (Horiz.sync.)	13	Horiz. sync. Input/Output (Composite H/V sync.)
6	Ground (Red)	14	Vert. sync.
7	Ground (Green)	15	----
8	Ground (Blue)		

SERVICE PORT CONNECTOR

Terminal : Mini DIN 8-PIN

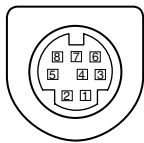

	Serial
1	R X D
2	----
3	----
4	GND
5	RTS / CTS
6	T X D
7	GND
8	GND

USB CONNECTOR (Series B)

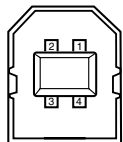

1	Vcc
2	- Data
3	+ Data
4	Ground

PIN Code Label

While the projector is locked with the PIN code...

Put on the label below (supplied) to a prominent place of the projector's body while it is locked with a PIN code.

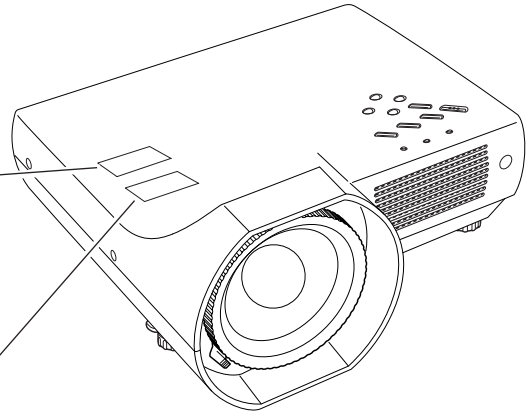

While the Antitheft alarm function is set...

Put on the label below (supplied) to a prominent place of the projector's body while the Antitheft alarm function is set.





SANYO Electric Co., Ltd.