

ENGLISH



Canon

PowerShot G6
DIGITAL CAMERA

Camera User Guide



DiG!C

- Please read the *Read This First* section (page 5).
- Please also read the *Software Starter Guide* and the *Direct Print User Guide*.



Canon

Canon DIGITAL CAMERA PowerShot G6 Camera User Guide

Flowchart and Reference Guides

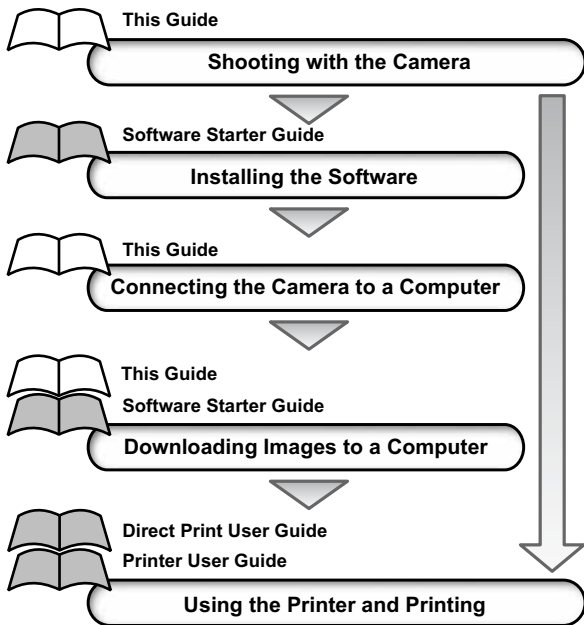

Use of genuine Canon accessories is recommended.

This product is designed to achieve excellent performance when used with genuine Canon accessories. Canon shall not be liable for any damage to this product and/or accidents such as fire, etc., caused by the malfunction of non-genuine Canon accessories (e.g., a leakage and/or explosion of a battery pack). Please note that this warranty does not apply to repairs arising out of the malfunction of non-genuine Canon accessories, although you may request such repairs on a chargeable basis.

(i)

Camera Body Temperature

If your camera is used for prolonged periods, the camera body may become warm. Please be aware of this and take care when operating the camera for an extended period.

About the LCD Monitor

The LCD monitor is produced with extremely high-precision manufacturing techniques. More than 99.99% of the pixels operate to specification. Less than 0.01% of the pixels may occasionally misfire or appear as red or black dots. This has no effect on the recorded image and does not constitute a malfunction.

Video Format

Please set the camera's video signal format to the one used in your region before using it with a TV monitor (p. 160).

Language Setting

Please see page 28 to change the language setting.





Disclaimer

- While every effort has been made to ensure that the information contained in this guide is accurate and complete, no liability can be accepted for any errors or omissions.
- Canon reserves the right to change the specifications of the hardware and software described herein at any time without prior notice.
- No part of this guide may be reproduced, transmitted, transcribed, stored in a retrieval system, or translated into any language in any form, by any means, without the prior written permission of Canon.
- Canon makes no warranties for damages resulting from corrupted or lost data due to a mistaken operation or malfunction of the camera, the software, the CompactFlash™ cards (CF cards), personal computers, peripheral devices, or use of non-Canon CF cards.

Trademark Acknowledgements

- Canon and PowerShot are trademarks of Canon, Inc.
- CompactFlash is a trademark of SanDisk Corporation.
- Macintosh, Mac OS and QuickTime are trademarks of Apple Computer, Inc, registered in the United States and other countries.
- Microsoft, Windows, and Windows NT are either registered trademarks or trademarks of Microsoft Corporation in the U.S. and/or other countries.
- Other names and products not mentioned above may be registered trademarks or trademarks of their respective companies.

Symbols Used

Icons under title bars show the operations mode. As in the example below, the mode dial should be set to **AUTO**, , , , , **P**, **Tv**, **Av** or **M**.

Using the Built-In Flash

Mode Dial

     **P** **Tv** **Av** **M**









: This mark denotes issues that may affect the camera's operation.













: This mark denotes additional topics that complement the basic operating procedures.

Table of Contents

★: Functions and operations tables.

Read This First	5
Components Guide	11
Front View	11
Back/Bottom View	12
Controls	13
Mode Dial	14
Main Dial	15
Display Panel	16
Preparing the Camera	18
Charging the Battery Pack	18
Installing the Battery Pack	21
Installing the CF Card	23
Attaching the Neck Strap	25
Attaching the Lens Cap	25
Setting the Date/Time	26
Setting the Language	28
Basic Functions	29
Turning the Power On/Off	29
Switching between Shooting and Playback	32
Using the LCD Monitor	33
★ Confirming information on the LCD Monitor	36
Using the Optical Viewfinder to Shoot	41
Using the Zoom (Focal Length)	42
Pressing the Shutter Button	43
★ Selecting Menus and Settings	45
Resetting the Settings to Default	54
Shooting – Letting the Camera Select Settings	55
 Auto Mode	55
Reviewing an Image Right after Shooting	57
Changing the Resolution and Compression	60
Changing the File Format	62
 Using the Built-In Flash	64
 Portrait Mode	67
 Landscape Mode	67
 Night Scene Mode	68
 Shooting Panoramic Images (Stitch Assist)	69

	Movie Mode	72
	Macro Mode	74
	Super Macro Mode	75
	Self-Timer	76
	Digital Zoom	77
	Continuous Shooting	78
Shooting – Selecting Particular Effects		80
P	Program AE	80
Tv	Setting the Shutter Speed	82
Av	Setting the Aperture	85
M	Manually Setting the Shutter Speed and Aperture	87
	Selecting an AF Frame	89
	Switching between Light Metering Modes	92
	Adjusting the Exposure	94
WB	Adjusting the Tone (White Balance)	95
	Changing the ISO Speed	98
	Changing the Photo Effect	99
	Auto Exposure Bracketing (AEB Mode)	101
	Focus Bracketing (Focus-BKT Mode)	103
*	Locking the Exposure Setting (AE Lock)	105
*	Locking the Flash Exposure Setting (FE Lock)	107
	Switching between Flash Adjustment Settings	109
	Switching the Timing at which the Flash Fires	111
	Shooting Images at Set Intervals (Intervalometer)	112
	Shooting Problem Subjects for the Autofocus	114
	Switching between Focus Settings	118
C1 C2	Saving Custom Settings	119
	Using the ND Filter	120
	Setting the Auto Rotate Function	121
	Resetting the File Numbers	122
Playback		124
	Displaying Images Individually	124
	Magnifying Images	125
	Viewing Nine Images at a Time (Index Playback)	126
JUMP	Jumping Between Images	127
	Viewing Movies	128
	Editing Movies	130
	Rotating Images in the Display	132
	Attaching Sound Memos to Images	133
	Automated Playback (Slide Show)	135
	Protecting Images	139

Erasing	140
 Erasing Images Individually	140
Erasing All Images	140
Formatting a CF Card	141
Print Order	142
About Printing	142
Print Settings (DPOF Print Settings)	144
Image Transmission Settings (DPOF Transfer Order)	149
Selecting Images for Transferring	149
Downloading Images to a Computer	151
Downloading via a Camera to Computer Connection	152
Computer System Requirements	152
Downloading Images by Direct Transfer	156
Connecting the Camera to the Computer to Download Images without Installing the Software	158
Downloading Directly from a CF Card	159
Viewing Images on a TV Set	160
Customizing the Camera (My Camera Settings)	161
Changing My Camera Settings	161
Registering the My Camera Settings	163
List of Error/Message Codes	167
List of Messages	168
Troubleshooting	170
Appendix	175
Using the Wireless Controller	175
Attaching the Lens Hood LH-DC30 (Sold Separately)	178
Using an Externally Mounted Flash (Sold Separately)	180
Using Conversion Lenses/Close-up Lenses (Sold Separately)	185
Using a Compact Power Adapter (Sold Separately)	189
Using a Battery Charger (Sold Separately) and Car Battery Cable (Sold Separately)	190
Replacing the Date Battery	191
Camera Care and Maintenance	192
Specifications	193
Index	202
★ Functions Available in Each Shooting Mode	206

Please Read

Test Shots

Before you try to photograph important subjects, we highly recommend that you shoot several trial images to confirm that the camera is operating and being operated correctly.

Please note that Canon, its subsidiaries and affiliates, and its distributors are not liable for any consequential damages arising from any malfunction of a camera or accessory, including CompactFlash™ cards, that results in the failure of an image to be recorded or to be recorded in a format that is machine readable.

Warning Against Copyright Infringement

Please note that Canon digital cameras are intended for personal use and should never be used in a manner that infringes upon or contravenes international or domestic copyright laws and regulations. Please be advised that in certain cases the copying of images from performances, exhibitions, or commercial properties by means of a camera or other device may contravene copyright or other legal rights even if the image was recorded for personal use.

Warranty Limitations

This camera's warranty is only effective in the country of sale. If a problem arises while the camera is in use abroad, please convey it back to the country of sale before proceeding with a warranty claim to a Canon Customer Support Help Desk.

For Canon Customer Support contacts, please see the Canon Limited Warranty supplied with your camera.

Safety Precautions

- Before using the camera, please ensure that you read and understand the safety precautions described below. Always ensure that the camera is operated correctly.
- The safety precautions noted on the following pages are intended to instruct you in the safe and correct operation of the camera and its accessories to prevent injuries or damage to yourself, other persons and equipment.
- In the next few pages, the term “equipment” refers primarily to the camera and its power supply accessories (see the System Map for power supply accessory details).

⚠ Warnings

- **Do not aim the camera directly into the sun or at other intense light sources which could damage your eyesight.**
- **Do not trigger the flash in close proximity to human or animal eyes.** Exposure to the intense light produced by the flash may damage eyesight. In particular, remain at least one meter (39 inches) away from infants when using the flash.
- **Store this equipment out of the reach of children and infants.** Accidental damage to the camera or batteries by a child could result in serious injury. In addition, placement of the strap around the child's neck could result in asphyxiation.
- **Be particularly careful to keep the date battery used in the camera away from children.** Seek medical assistance immediately if a child swallows a battery.
- **Do not attempt to disassemble or alter any part of the equipment that is not expressly described in this guide.** Disassembly or alteration may result in high voltage electrical shock. Internal inspections, alterations and repairs should be conducted by qualified service personnel authorized by your camera distributor or a Canon Customer Support Help Desk.
- **To avoid the risk of high-voltage electrical shock, do not touch the flash portion of the camera if it has been damaged.** Similarly, never touch internal portions of the equipment that become exposed as a result of damage. There is a risk of high voltage electrical shock. Please take the first opportunity to consult your camera distributor or a Canon Customer Support Help Desk.
- **Stop operating the equipment immediately if it emits smoke or noxious fumes.** Failure to do so may result in fire or electrical shock. Immediately turn the camera's power off, remove the camera battery or unplug the power cord from the power outlet. Confirm that smoke and fume emissions have ceased. Please consult your camera distributor or the closest Canon Customer Support Help Desk.
- **Stop operating the equipment if it is dropped or the casing is damaged.** Failure to do so may result in fire or electrical shock. Immediately turn the camera's power off, remove the camera battery or unplug the power cord from the power outlet. Please consult your camera distributor or the closest Canon Customer Support Help Desk.

-
- **Do not allow the equipment to come into contact with, or become immersed in, water or other liquids.** Do not allow liquids to enter the interior. The camera has not been waterproofed. If the exterior comes into contact with liquids or salt air, wipe it dry with a soft, absorbent cloth. In the event that water or other foreign substances enter the interior, immediately turn the camera's power off and remove the camera battery or unplug the power cord from the power outlet. Continued use of the equipment may result in fire or electrical shock. Please consult your camera distributor or the closest Canon Customer Support Help Desk.
-
- **Do not use substances containing alcohol, benzene, thinners or other flammable substances to clean or maintain the equipment.** The use of these substances may lead to fire.
 - **Remove the power cord on a regular periodic basis and wipe away the dust and dirt that collects on the plug, the exterior of the power outlet and the surrounding area.** In dusty, humid or greasy environments, the dust that collects around the plug over long periods of time may become saturated with humidity and short-circuit, leading to fire.
 - **Do not cut, damage, alter or place heavy items on the power adapter cord.** Any of these actions may cause an electrical short circuit, which may lead to fire or electrical shock.
 - **Do not handle the power cord if your hands are wet.** Handling it with wet hands may lead to electrical shock. When unplugging the cord, ensure that you hold the solid portion of the plug. Pulling on the flexible portion of the cord may damage or expose the wire and insulation, creating the potential for fires and electrical shocks.
 - **Use only the recommended power accessories.** Use of power sources not expressly recommended for this equipment may lead to overheating, distortion of the equipment, fire, electrical shock or other hazards.
 - **Do not place the batteries near a heat source or expose them to direct flame or heat. Neither should you immerse them in water.** Such exposure may damage the batteries and lead to the leakage of corrosive liquids, fire, electrical shock, explosion or serious injury.
-

-
- **Do not attempt to disassemble, alter or apply heat to the batteries.** There is serious risk of injury due to an explosion. Immediately flush with water any area of the body, including the eyes and mouth, or clothing, that comes into contact with the inner contents of a battery. If the eyes or mouth contact these substances, immediately flush with water and seek medical assistance.
-
- **Avoid dropping or subjecting the batteries to severe impacts that could damage the casings.** It could lead to leakage and injury.
-
- **Do not short-circuit the battery terminals with metallic objects, such as key holders.** It could lead to overheating, burns and other injuries. Use the supplied terminal cover to transport or store the battery.
-
- **Before you discard a battery, cover the terminals with tape or other insulators to prevent direct contact with other objects.** Contact with the metallic components of other materials in waste containers may lead to fire or explosions. Discard the batteries in specialized waste facilities if available in your area.
-
- **Use only recommended battery packs and battery chargers.** Use of batteries not expressly recommended for this equipment may cause explosions or leaks, resulting in fire, injury and damage to the surroundings.
-
- **Disconnect the compact power adapter from both the camera and power outlet when the camera is not in use to avoid fires and other hazards.** Continuous use over a long period of time may cause the unit to overheat and distort, resulting in fire.
-
- **Exercise due caution when screwing on the separately sold wide converter, tele-converter lens, close-up lens and conversion lens adapter.** If they loosen, fall off and shatter, the glass shards may cause an injury.
-

Caution about magnetic fields

Keep objects that are sensitive to magnetic fields (such as credit cards) away from the speaker of the camera (p. 11). Such items may lose data or stop working.

⚠ Cautions

- **Avoid using, placing or storing the equipment in places subject to strong sunlight or high temperatures, such as the dashboard or trunk (boot) of a car.** Exposure to intense sunlight and heat may cause the batteries to leak, overheat or explode, resulting in fire, burns or other injuries. High temperatures may also cause deformation of the casing. Ensure that there is good ventilation when using the compact power adapter to power the camera.

- **Do not store the equipment in humid or dusty areas.** Storage in such areas could lead to fire, electrical shock or other damage.

- **Be careful not to bang the camera or subject it to strong impacts or shocks** that could lead to injury or damage the equipment when wearing or holding it by the strap.

- **Be careful not to cover the flash with your fingers or clothing when shooting.** The flash may be damaged and emit smoke or noise. In addition, do not touch the surface of the flash after taking several pictures in rapid succession. Either action could result in burns.

- **Do not operate the flash with dirt, dust or other items stuck to its lens.** The resulting heat build-up could damage the flash.

- **Ensure that the battery charger or compact power adapter is plugged into a power outlet of the specified rating, not over the specified rating.** The plug of the battery charger varies according to region.

- **Do not use the battery charger or compact power adapter if the cable or plug is damaged, or if the plug is not fully inserted into the power outlet.**

- **Do not allow metal objects (such as pins or keys) or dirt to contact the charger terminals or plug.**

- **If your camera is used for prolonged periods, the camera body may become warm.** Please take care when operating the camera for an extended period as your hands may experience a burning sensation.

■ **Avoid Strong Magnetic Fields**

Never place the camera in close proximity to electric motors or other equipment generating strong electromagnetic fields.

Exposure to strong magnetic fields may cause malfunctions or corrupt image data.

■ **Avoid Condensation Related Problems**

Moving the equipment rapidly between hot and cold temperatures may cause condensation (water droplets) to form on its external and internal surfaces.

You can avoid this by placing the equipment in an airtight, resealable plastic bag and letting it adjust to temperature changes slowly before removing it from the bag.

■ **If Condensation Forms Inside the Camera**

Stop using the camera immediately if you detect condensation. Continued use may damage the equipment. Remove the CF card, and battery or a household power source, from the camera and wait until the moisture evaporates completely before resuming use.

■ **Extended Storage**

When not using the camera for extended periods of time, remove the battery from the camera or battery charger and store the equipment in a safe place. Storing the camera for extended periods with batteries installed will run down the battery. (Do not remove the date battery.)

Front View

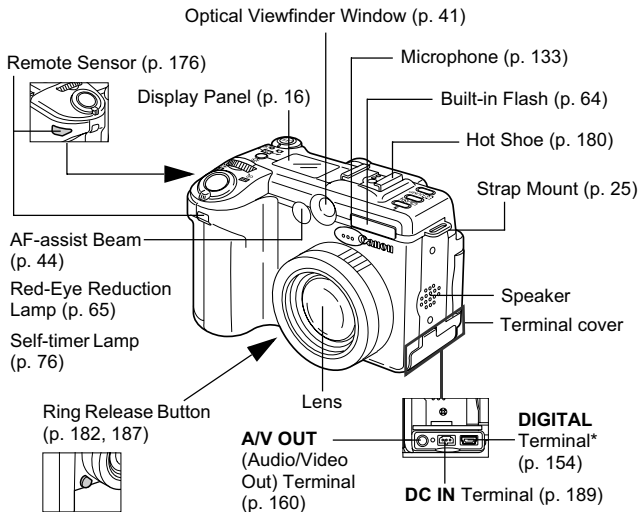

* To connect the camera to a computer or printer, use one of the following cables.

Computer: Interface Cable IFC-400PCU (supplied with the camera)

Direct Print Compatible Printers (Sold Separately)

- CP Printers: Interface Cable IFC-400PCU (supplied with the camera) or the Direct Interface Cable DIF-100 (supplied with CP-100/CP-10).

- Bubble Jet Printers

- *Bubble Jet Direct* Compatible Printers: Please refer to your Bubble Jet printer user guide.

- *PictBridge* Compliant Printers: Interface Cable IFC-400PCU (supplied with the camera)

- *PictBridge* Compliant Non-Canon Printers: Interface Cable IFC-400PCU (supplied with the camera)

Please refer to the *System Map* or the *Direct Print User Guide* supplied with the camera for direct print compatible printer information.

Back/Bottom View

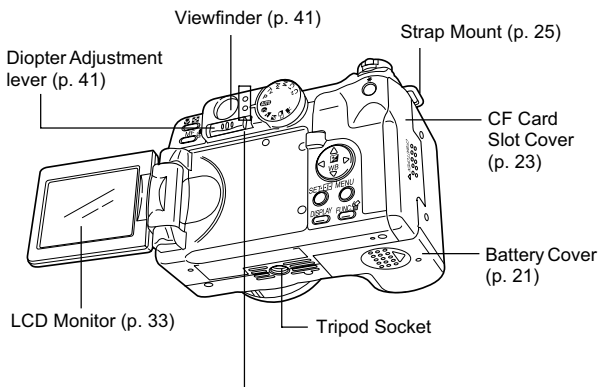

● Upper Indicator

The indicators light or blink when the shutter button is pressed or the following operations are underway.

- Green: Ready to record
- Blinking Green: Recording to CF card/Reading CF card/
Erasing from CF card/Transmitting data (during
a computer connection)
- Orange: Ready to record (flash on)
- Blinking Orange: Ready to record (camera shake warning/
insufficient exposure)

● Lower Indicator

- Yellow: Macro mode/Super Macro mode/Manual focus
mode
- Blinking Yellow: Focusing difficulty (although you can press the
shutter button, try using focus lock or adjusting
the focus manually (p. 114, 115))

Controls

Top

⚡ (Flash) Button
(p. 64)

Zoom Lever

Shooting: (Telephoto)/ (Wide Angle) (p. 42)
Playback: (Zoom in)/ (Zoom out) (p. 125)

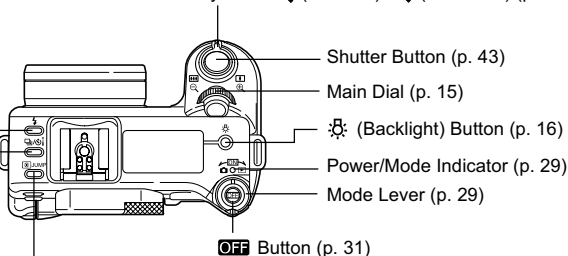

(Light Metering)/**JUMP** Button (p. 92, 127)

(Continuous)/ (Self-Timer/Wireless Controller) Button (p. 76, 78, 176)

Back

(Macro)/ (Index) Button (p. 74, 75, 126)

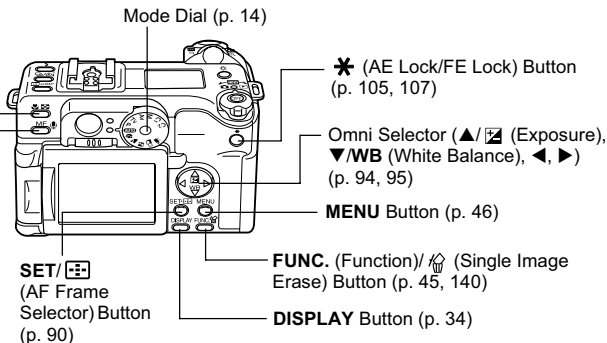

MF (Manual Focus)/ (Microphone) Button (p. 115, 116, 133)

Mode Dial

Use the mode dial to switch between the shooting modes.

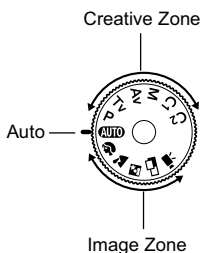

AUTO : Auto (p. 55)

The camera automatically selects settings.

Image Zone

The camera automatically selects settings according to the image composition type.

-  : Portrait (p. 67)
-  : Landscape (p. 67)
-  : Night Scene (p. 68)
-  : Stitch Assist (p. 69)
-  : Movie (p. 72)

Creative Zone

The user selects exposure, aperture or other settings to achieve special effects.

- P** : Program AE (p. 80)
- Tv** : Shutter Speed-Priority AE (p. 82)
- Av** : Aperture-Priority AE (p. 85)
- M** : Manual Exposure (p. 87)
- C1** : Custom 1 (p. 119)
- C2** : Custom 2 (p. 119)

Main Dial

The main dial is used for selecting certain menus and for displaying images. You can easily and swiftly select, confirm and switch menus.

Turning the Main Dial

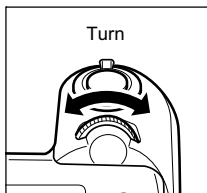

In Shooting Mode

- Selects aperture value and shutter speed (p. 82, 85, 87)
- Selects menu settings by pressing the **FUNC.** button (p. 45)
- Selects exposure compensation and white balance (p. 94, 95)
- Manually sets the focus (p. 115)

In Playback Mode

- Displays the previous and next image (p. 124)

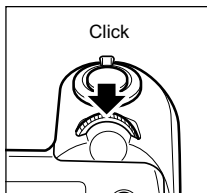

Clicking the Main Dial



In Shooting Mode







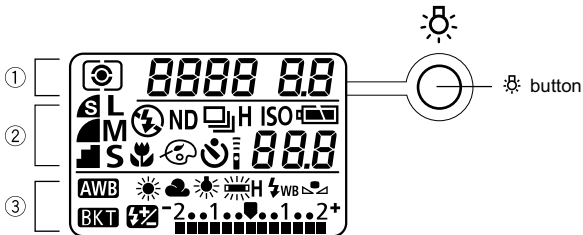









- Fixes menu items set by pressing the **FUNC.** button (p. 45)
- Switches between shutter speeds and aperture values in **M** mode (p. 87)

Display Panel

The display panel shows the camera settings, the remaining image capacity, movie shooting time, battery charge and other information. In Shooting mode (p. 30), you can turn on the backlight of the display panel for six seconds by pressing the  button. To turn off the backlight within six seconds, press the  button again.



	Icons	Indication	Reference pages
		Evaluative Metering/Spot Metering/ Center-Weighted Average Metering	92
①		Shutter Speed/Movie Shooting Time/ White Balance/ISO Speed/Photo Effect/ Bracket	72, 82, 87, 95, 98, 99, 101, 103
		Aperture Setting	85, 87
		AiAF Center point	89
		Compression	60
		Resolution (Not displayed with RAW images)	60
②		Flash On/Flash Off (Not displayed with Auto)	64
		ND filter	120
		Single Shot Standard Continuous Shooting High-speed Continuous Shooting	78



	Icons	Indication	Reference pages
	ISO	ISO speed	98
	 	Battery Charge State	22
		Macro Mode*	74
		Photo Effect	99
	 	Self-Timer/Wireless Controller	76, 175
	888	Remaining Image Capacity/Message Code/Error Code/ <i>Int</i> (Intervalometer)/Interval Shooting Remaining Shots	112, 167
	        	White Balance Settings	95
③	BKT	Bracket	101, 103
		Flash Exposure Compensation Flash Output Adjustment	109
	-2..1..1..1..1..2+ 	Exposure Compensation Level/AEB Level/ Flash Exposure Compensation Level/ Flash Output Adjustment Level	94, 101, 109

* Turns off in Super Macro mode. The Super Macro mode icon appears on the LCD monitor (p. 75).



- The diagram above shows all the icons appearing at once. Normally, only the icons applicable to the selected mode and camera state appear.

Charging the Battery Pack

Use the following procedures to charge the battery pack the first time and subsequently when the “Change the battery pack” message displays on the LCD monitor or the low battery icon () and Lb () message are lit on the Display Panel.

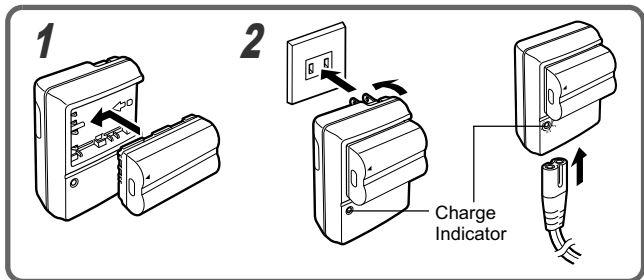

1 Align the edge of the battery pack with the line on the battery charger, then slide the battery in the direction of the arrow.

2 Battery charger model names and types vary by region.

(For CG-580)

Plug the battery charger into a power outlet.

(For CB-5L)

Attach the power cord to the battery charger and plug the other end into a power outlet.

- The charge indicator blinks while the battery pack is charging and lights steadily once charging is complete.
- After charging, unplug the battery charger and remove the battery pack.



- This is a lithium ion battery pack so there is no need to completely use or discharge it before recharging. It can be recharged at any time. However, since the maximum number of charge cycles is approximately 300 (battery life) (based on Canon's testing standard), you are recommended to charge the battery pack only after having discharged it completely to prolong battery life.
- The initial charging of a fully discharged battery pack takes approximately 90 minutes. It takes a further hour for the battery pack to reach a fully charged state (based on Canon's testing standard).
- Charging times will vary according to the surrounding humidity and battery pack charge state.
- The separately sold Battery Pack BP-511, BP-512 and BP-514 can also be used in this camera.

Battery Pack Handling Precautions

- Keep the battery pack and camera terminals (\oplus \ominus D B) clean at all times. Dirty terminals may cause a poor contact between the battery pack and camera. Polish the terminals with a tissue or a dry cloth before charging or using the battery pack.
- Do not cover the battery charger with anything, such as a tablecloth, cushion or blanket, when it is charging. Heat will build up internally and possibly lead to fire.
- Do not charge batteries other than Battery Pack BP-511A, BP-511, BP-512 or BP-514 with the supplied equipment. This may cause a malfunction.
- The battery pack continues to discharge a small amount when left in the camera or battery charger even with the power turned off. This shortens the battery life. Remove the battery pack from the camera when it is not in use.
- Store the battery in an indoor location with low relative humidity and between the temperatures of 0 to 30 °C (32 to 86 °F).
- Do not allow any metal objects such as keyrings to touch the " \oplus " and " \ominus " terminals (Fig. A), as this can damage the battery pack. To carry the battery pack, or store it during periods of disuse, always replace the terminal cover (Fig. B) or place it in the supplied case and store it in a cool, dry place.

Charging the Battery Pack (continued)

When using Battery Pack BP-511A or BP-514, you can distinguish between the discharged battery pack and fully charged battery pack by changing the direction of the battery cover (Fig. C and D). Recharge the battery fully before using it again.

Fig. A

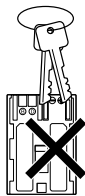

Fig. B

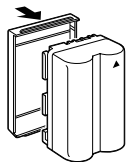
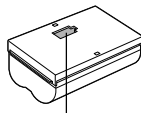

Fig. C

Fully Charged Battery



Attach so the blue portion of the battery pack can be seen through the window.

Fig. D

Used Battery

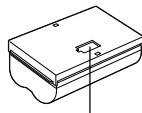

Attach in the opposite way of Fig. C.

- Even charged battery packs continue to discharge naturally. You are advised to charge the battery on the day of use, or one day before, to ensure a full charge.
- Since storing a fully charged battery pack for long periods of time (about 1 year) can shorten its lifecycle or affect performance, you are recommended to use the battery pack in the camera until the Lb symbol displays and to store it at normal temperature (30 °C/ 86 °F) or lower. If you do not use the battery pack for long periods of time, charge it fully and discharge it fully in the camera at least once a year before returning it to storage.
- The camera consumes the battery charge when the power is on even when a function is not being used. To conserve the battery charge, be particularly attentive in turning the camera off.
- Although the battery pack's maximum operating range is 0 to 40 °C (32 to 104 °F), the optimal range is 10 to 30 °C (50 to 86 °F). At cold temperatures, such as those experienced when skiing, performance will temporarily decline, reducing the usable time before recharging.
- If the usable time of a battery pack diminishes substantially even when fully charged, it should be replaced.

Installing the Battery Pack

Install Battery Pack BP-511A (supplied) into the camera as follows. Use the Compact Power Adapter CA-560 (sold separately) to power the camera for extended periods (p. 189).

- Charge the battery pack before using it for the first time (p. 18).

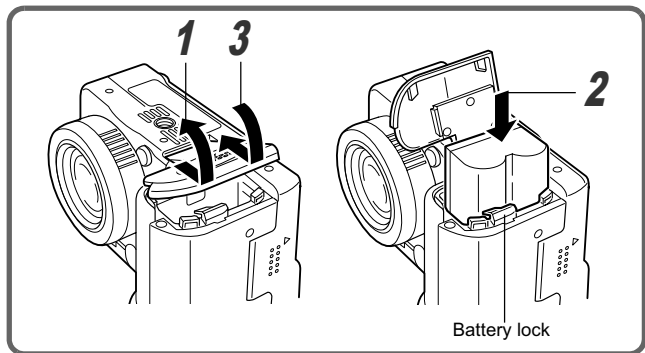

1 Check that the power is off (p. 29) and slide the battery cover in the direction of the arrow.

2 Insert the battery pack.

- The terminal side of the battery pack should face downward.
- Insert the battery pack all the way in until the battery lock clicks. To remove the battery pack, push the battery lock.

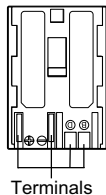

3 Slide the battery cover closed.



- When the indicator next to the viewfinder blinks green, the camera is writing, reading, erasing or transmitting an image to or from the card. Do not perform the following, or image data may be lost or corrupted:
 - Do not shake the camera.
 - Do not turn off the power or open the battery cover or CF card slot cover.
- Remove the battery pack when the camera is not in use.





- See *Battery Performance* (p. 196).

Battery Status Symbols

The following icons indicate the battery status on the display panel. These icons will not appear while the camera is powered with a compact power adapter.

 : Sufficient battery charge

 : Low battery

 : Replace or recharge battery

Installing the CF Card

Install the CF card (supplied) into the camera as follows.

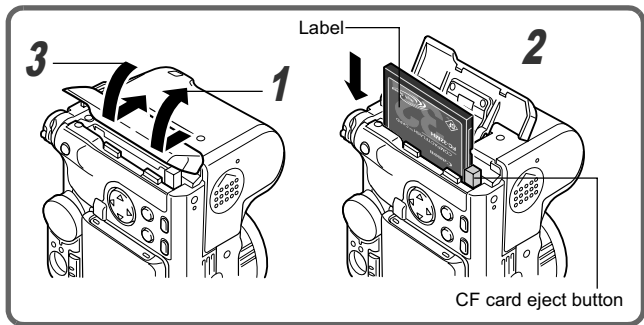

1 Check that the power is off (p. 29) and slide the CF card slot cover in the direction of the arrow.

2 Insert the CF card as shown in the illustration.

- Push the card in until the CF card eject button fully extends. To remove the CF card, push the CF card eject button and pull the card out.

3 Slide the CF card slot cover closed.

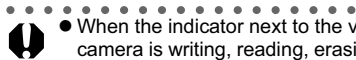

- When the indicator next to the viewfinder blinks green, the camera is writing, reading, erasing or transmitting an image to or from the card. Do not perform the following, or image data may be lost or corrupted:
 - Do not shake the camera.
 - Do not turn off the power or open the battery cover or CF card slot cover.
- You are recommended to use CF cards that have been formatted in your camera (p. 141). The card supplied with the camera may be used without further formatting.



- See *CF Cards and Estimated Capacities (Recordable Images)* (p. 198).

CF Card Handling Precautions

- CF cards are high-precision electronic devices. Do not bend, force, or subject them to shocks or vibration.
- Do not attempt to disassemble or alter a CF card.
- Moving a CF card rapidly between temperature extremes may cause condensation to form in the card, leading to potential malfunctions. To avoid condensation formation, place the CF card in a sealed plastic bag before moving it into a different temperature zone and allow it to adjust slowly to the new temperature.
If condensation forms on the CF card, put it aside until the water droplets have evaporated completely.
- Place the CF card in the supplied case for storage.
- Do not use or store CF cards in the following types of locations.
 - Locations subject to dust or sand
 - Locations subject to high humidity and high temperatures

Microdrives are a recording medium with a hard disk. Their merits are a large capacity and a low price per megabyte of capacity. However, they can be more susceptible to vibrations and shocks than CF cards, which use durable flash memories. Please be careful, therefore, not to subject the camera to vibrations or shocks when using a microdrive, especially while recording or during playback.

Attaching the Neck Strap

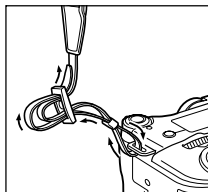

Attach the strap as illustrated on the left. Pull the strap tight in the buckle so that it does not slip. Perform the same steps on the other side of the camera (p. 11).



- Avoid waving the camera about or catching it on other items when suspending it from the strap.

Attaching the Lens Cap

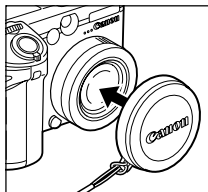

Fit the lens cap over the lens casing so that it covers the entire lens. Always attach the lens cap after use.





- Attach the lens cap cord to the strap.
- Remove the lens cap before turning on the camera's power.

Setting the Date/Time

The set Date/Time menu will appear the first time the camera power is turned on or whenever the lithium date battery charge is low. Start from Step 5 to set the date and time.

1 Turn on the camera (p. 29).

2 Press the MENU button.

- The [ (Rec.)] or [ (Play)] menu appears.

 (Rec.) Menu in Auto mode

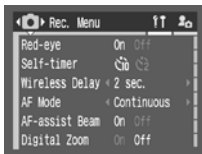

3 Press the ► arrow on the omni selector to select the [(Set up)] menu.

- Pressing the **JUMP** button or turning the zoom lever also switches between menus.

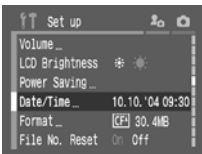

4 Press the ▲ or ▼ arrow on the omni selector to select [Date/Time] then press the SET button.

- The factory default for the date format may differ from that shown here in some regions.

5 Set the date and time.

- Press the ◀ or ▶ arrow on the omni selector to select a field to change.
- Press the ▲ or ▼ arrow on the omni selector to set the values.
- The date can be set up to the year 2030.

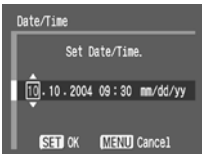

6 Press the SET button.

- After adjusting the settings, press the **MENU** button to close the menu window.





- The Date/Time cannot be inserted in the actual image even if the Date/Time have been set. For printing images with the date on them, refer to the *Direct Print User Guide* or *Software Starter Guide*.
- *Replacing the Date Battery* (p. 191)

Setting the Language

Use this feature to select the language used in the menus and messages.

1 Turn on the camera (p. 29).

2 Press the MENU button.

- The [ (Rec.)] or [ (Play)] menu appears.

 (Rec.) Menu in Auto mode

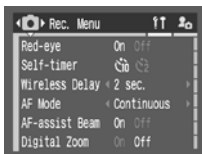

3 Press the ► arrow on the omni selector to select the [(Set up)] menu.

- Pressing the **JUMP** button or turning the zoom lever also switches between menus.

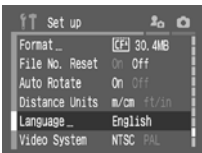

4 Press the ▲ or ▼ arrow on the omni selector to select [Language] and press the SET button.

5 Press the ▲, ▼, ◀ or ▶ arrow on the omni selector to select a language.



6 Press the SET button.

- After adjusting the settings, press the **MENU** button to close the menu window.



- In playback mode, you can change the language by holding the **SET** button while you press the **JUMP** button, except when a separately sold printer is connected or during movie playback.

Turning the Power On/Off

The power/mode indicator remains lit while the power of the camera is on. The power/mode indicator indicates the state of the camera as follows.

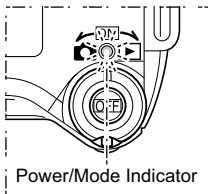

Power/Mode Indicator

- Orange:** Shooting mode
- Green :** Playback mode/Printer connection mode*
- Yellow :** Computer connection mode*
- Off :** The power of the camera is off.

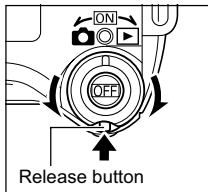

* For printer connection mode information, see the *Direct Print User Guide*. For computer connection mode information, see the *Software Starter Guide*.



Release button

Mode Lever

Use this lever to turn the power on.

To operate the mode lever, press the release button as shown on the left. The mode lever will not operate if the release button is not pressed. After the camera is turned on in  or , release the lever. The mode lever returns to its original position (center).



- You will hear a start-up sound and see the start-up image when the power comes on. (To change the start-up sound and image, see pages 53 and 161.)
- The start-up image does not appear when the LCD monitor is off in shooting mode or the **A/V OUT** terminal is connected to a TV.

Turning on the camera without the start-up sound and image

Press and hold the  button, then turn on the power. You can also turn the camera on with the LCD monitor closed.

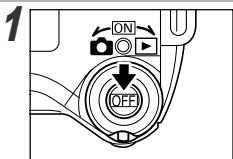

Turning the Power Off



Press the **OFF** button.

- The power goes off.

Power Saving Function

This camera is equipped with a power saving function. When this function is turned on and it activates, restore power by turning the mode lever toward  or .

Shooting Mode: Powers down approximately 3 minutes after the last control is accessed on the camera.

The LCD monitor also shuts off approximately 1 minute* after the last control is accessed on the camera. Press any button except the mode lever to turn the LCD monitor back on.

* This time can be changed (p. 52).

Playback Mode: Powers down approximately 5 minutes after the last control is accessed on the camera.

Printer Connection Mode: Powers down approximately 5 minutes after the last control is accessed on the camera.

- Please note that the camera continues to consume a minimal amount of power even when the power saving function shuts it down.
- The power saving function is disabled while a slide show plays on the camera or during a computer connection (p. 135, 151).
- You can turn off the power saving function in the Set up menu (p. 52).

Switching between Shooting and Playback

You can quickly switch between Shooting mode and Playback mode. This is convenient when you wish to shoot again after checking or erasing an image immediately after it is shot.

● Shooting Mode ➔ Playback Mode

Open the LCD monitor and turn the mode lever to  (Playback) while pressing the release button (p. 30).

- The camera switches to Playback mode. In this case, the lens does not retract. (If the mode lever is turned to  (Playback) again, the lens retracts.)

● Playback Mode ➔ Shooting Mode

Remove the lens cap and press the shutter button halfway, or turn the mode lever to  (Shooting) while pressing the release button (p. 30).

Using the LCD Monitor

The LCD monitor can be used in the following cases:

- when you want to check your composition as you shoot.
- when you want to playback the images you have shot.
- when you want to operate the camera menus.

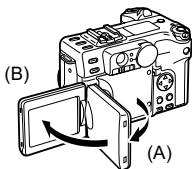

The monitor can be locked open at 90 degrees (A), or opened all the way to 180 degrees (B).

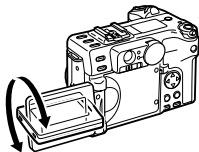

The monitor can be rotated forward 180 degrees in the direction of the lens, or rotated backward 90 degrees.



The LCD monitor will automatically turn off when the LCD monitor clicks shut against the camera body facing in. To protect the monitor, always make sure the monitor is stowed as described above when the camera is not in use.

The LCD monitor can also be positioned as below.

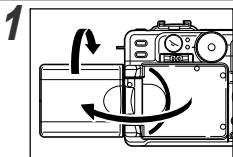

The monitor can be opened through 180 degrees, and then rotated 180 degrees to face outwards, in the same direction as the lens.

- In this position, icons and messages do not appear on the LCD monitor.
- The image shown on the LCD monitor is automatically flipped and reversed (the Reverse Display function) so that it appears correctly from in front of the lens. (You can disable the Reverse Display function (p. 50).)

2

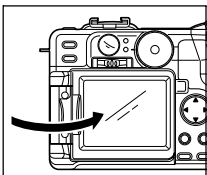

Fold the LCD monitor back against the camera body.

- Fold it until it clicks into place against the camera body. If it is not fully closed, the image will appear reversed and icons and messages will not display.
- Icons and messages will appear and images will show properly (not reversed) when the LCD monitor is folded right against the camera until it clicks.



- In Playback mode, images do not appear reversed. Also, icons and messages always show properly.

Switching between Display Mode

Each time you press the **DISPLAY** button the LCD monitor cycles to the next information mode.

● Shooting Mode



Each time you press the **DISPLAY** button the information view switches as follows.

On (No Information) → On (Information View)* → Off

A diagram showing a horizontal line with an arrow pointing right from 'On (No Information)' to 'On (Information View)*', and another arrow pointing right from 'On (Information View)*' to 'Off'. A vertical line with an upward-pointing arrow connects 'On (Information View)*' to the 'On (No Information)' label.

* Depending on the LCD monitor's position, the information view may not display.



- You can check detailed information about the image you just shot without switching the camera to Playback mode. To do so, while the image is being reviewed on the LCD monitor right after being taken, press the **SET** button or ***** button, then **DISPLAY** button.
- The display mode is memorized when the camera is turned off. It assumes the last mode when it is turned on again. When the LCD monitor is used for shooting and the low battery icon  appears, however, the LCD monitor may not automatically turn on the next time the camera is started.
- Setting the mode dial to  or  turns on the LCD monitor regardless of whether it is set to on or off.

● Playback Mode

Each time you press the **DISPLAY** button the information view mode cycles as follows.

Single Image Playback (p. 124):

Standard Information View → Detailed Information View → No Information
↑

Index Playback (p. 126):

Standard Information View ↔ No Information

Confirming information on the LCD Monitor



Information Displayed on the LCD Monitor

The LCD monitor displays information in Shooting or Playback mode, such as the camera settings, remaining image capacity and shooting date/time.

● Shooting Mode

Settings which have been altered will be displayed on the LCD monitor for approximately six seconds, even if the information display has been turned off. (Sometimes no information appears depending on the camera setting at that time.)



- A slow shutter speed has likely been selected because of insufficient lighting if the camera shake icon  appears on the LCD monitor after metering preparations are complete. Set the flash to  (On) or  (Auto), or affix the camera to a tripod to shoot.



- After you take a photo by fully pressing the shutter button, the image displays on the LCD monitor for approximately two seconds (or the review duration you set from 2 to 10 seconds). If you press the **SET** button or  button while the image is displayed, it will continue to display (p. 57).
- You can check the brightness of the image during the image review after shooting using the histogram (p. 40), a graph which allows you to judge the brightness of the recorded image and other information appearing with the image. You can adjust the exposure according to the results, then shoot again if necessary. (If no histogram appears, press the **DISPLAY** button.)

The following displays in information view.

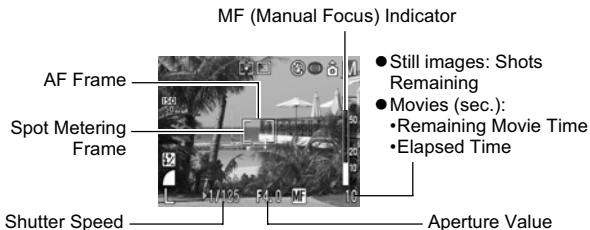



-2...+2	Exposure Compensation	p. 94
	White Balance (WB)	p. 95
	Drive Mode	p. 76, 78
	ISO Speed	p. 98
	Photo Effect	p. 99
	Bracket	p. 101
	Flash Exposure Compensation/Flash Output	p. 109
	Compression Settings	p. 60
L M1 M2 M3 S	Resolution Settings	p. 60
RAW	File Format	p. 62
4.0x 4.7x 6.0x 7.7x 9.6x 12x 16x	Digital Zoom Setting*	p. 77
	Low Battery	p. 22
	Flash	p. 64
	Red-eye Reduction	p. 65
	Macro Mode/Super Macro Mode	p. 74, 75
	Light Metering Mode	p. 92
	Auto Rotate	p. 121
	Shooting Mode	p. 14
ND	ND Filter	p. 120
	Camera Shake Warning	p. 36
*	AE Lock/FE Lock	p. 105, 107

Confirming information on the LCD Monitor (continued)

MF	Manual Focus	p. 115, 116
● (Red)	Movie Recording Mode	p. 72

* Zoom powers reflect the combined optical and digital zoom effects. These figures appear when the digital zoom is activated. ("4.0x" is the telephoto-end setting of the optical zoom.)

- The icons in the shaded boxes () above and  appear even when the information view is turned off.
- In addition to the above, the messages, AF frame, Spot Metering Frame, shutter speed, aperture value, MF indicator (when manual focus is selected) and zoom bar (during the zoom operation) are shown as in the upper screen example.

● Playback Mode







In standard display mode, the following information appears.

Image Number and
Total
(Display Image/Total)



File Number

Shooting Date/Time

    	Compression Settings	p. 60
L M1 M2 M3 S	Resolution Settings (still images)	p. 60
RAW	File Format	p. 62
	Sound memo (wave file)	p. 133
AVI	Movie	p. 128
	Protection Status	p. 139

In detailed display mode, the following information also appears.



Shutter Speed

Histogram

Aperture Value



Movie Length

50 100 200 400	ISO Speed	p. 98
	Photo Effect	p. 99
	Shooting Mode	p. 14
	Resolution Settings (Movie)	p. 60
-2...±0...+2	Exposure level	p. 94
-2...±0...+2	Flash Exposure Compensation	p. 109
	White Balance	p. 95
	Light Metering Mode	p. 92
	Macro Mode/Super Macro Mode	p. 74, 75
MF	Manual Focus	p. 115, 116

- In addition to the above, the shutter speed, aperture setting, movie length, histogram and overexposure warning appear.

The following information may also appear with some image files.

	An audio file other than a wave file, or a file with an unrecognized format, is attached.
	JPEG file with format not conforming to Design rule for Camera File System Standards (p. 195).
	File with unrecognized format.



- Please note that image information recorded by this camera may not display correctly on other cameras and image information recorded by other cameras may not display correctly on this camera.

About the Histogram

The histogram is a graph that allows you to judge the brightness of the recorded image. The greater the bias toward the left in the graph, the darker the image. The greater the bias toward the right, the brighter the image.

If the image is dark, adjust the exposure compensation to a positive number. Similarly, adjust the exposure compensation to a negative number if the image is bright (p. 94).

Sample
Histograms



Dark Image



Balanced Image



Bright Image

Overexposure Warning

In the following conditions, overexposed portions of the image blink.

- When an image just shot is being reviewed on the LCD monitor (Information view).
- In the detailed display mode of the Playback mode.

Using the Optical Viewfinder to Shoot

Setting the LCD monitor to Off and using the optical viewfinder can help conserve power while shooting.

- You can adjust the viewfinder with the diopter adjustment lever to adapt to your vision so that the subject appears in crisp focus. Adjustments of -3 to $+1$ m^{-1} (diopter equivalent) can be made.
- The viewfinder has a field of vision of approximately 80% of the actual shooting image.

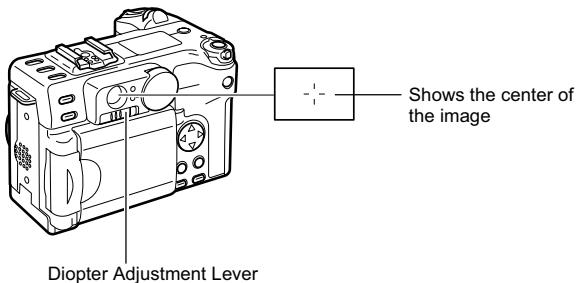

Image Seen in Viewfinder vs. Recorded Image

Please note that the actual image may differ from the image seen in the optical viewfinder due to the physical separation between the viewfinder and lens. This is called the parallax phenomenon and is more noticeable the closer the subject is to the lens. In some cases, portions of images shot up close that appear in the viewfinder will not appear in the recorded image. Please use the LCD monitor to shoot images up close.

Shooting with an Off-Center AF Frame Selected



When setting the AF frame to the desired position to shoot an image, please use the LCD monitor (p. 89).

Using the Zoom (Focal Length)

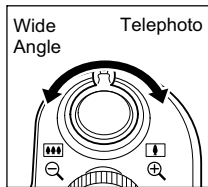
The zoom can be adjusted from 35 to 140 mm (equivalent to 35mm film format).



Telephoto/Wide Angle

Turning the zoom lever toward  magnifies the subject (telephoto). Turning the zoom lever toward  decreases the size of the subject (wide angle). The zoom bar appears during the zoom operation.

Zoom Bar



Digital Zoom

An image already zoomed with the optical zoom lens can be further zoomed digitally up to an approximate factor of 16 (p. 77). The factor displays after the zoom operation.



- The digital zoom cannot be used with certain Shooting modes (p. 206).



- The more the image is zoomed digitally, the coarser its image quality becomes.

Pressing the Shutter Button

The shutter button features a two-stage action.

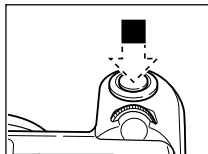

● Pressing Halfway

Pressing halfway automatically sets the exposure and focus.

- The indicators light or blink as follows.

Upper indicator

- Green: Metering complete (two beeps sound)
- Orange: Flash will fire
- Blinking Orange: Camera shake warning/Insufficient exposure

Lower indicator

- Yellow: Macro mode/Super Macro mode/Manual focus mode
- Blinking Yellow: Focusing difficulty* (single beep sounds)

* Use the focus lock, or focus manually, to shoot when the indicator blinks yellow (p. 114, 115).

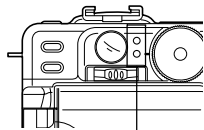

Indicators



AF Frame

- The AF frame appears as follows when the LCD monitor is on.

- Green: Metering complete
- Yellow: Focusing difficulty*

* The AF frame does not appear when the focus area is set to be selected automatically (AiAF), (p. 89).

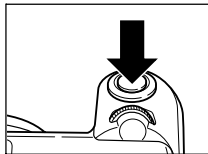

● Pressing Fully

Pressing fully releases the shutter.

- The upper indicator blinks green while the image is recording onto the CF card.
- You will hear the shutter sound when the shot is complete. Do not move the camera until you hear this sound.



- If the  icon appears, the AF frame displays in yellow, or the orange or yellow lamp starts to blink when you press the shutter button halfway, you can still shoot the image by pressing the shutter button all the way down.
- Images are first saved into the camera's internal memory before being recorded onto the CF card, allowing the next images to be taken immediately as long as sufficient space is available in the internal memory.
- The beep and shutter sound can be set to On or Off using the Mute option in the Set up menu.
- If the Mute option is on, the shutter will not make a sound even if the shutter sound option is on.
- There is no shutter sound in Movie mode.
- Shots cannot be taken while the flash is charging.

AF-assist Beam

- The AF-assist beam will sometimes emit when the shutter button is pressed halfway to assist focusing in certain conditions, i.e. dark conditions.
- The AF-assist beam can be turned off (p. 49).
If animals are your subject, turn off the beam when shooting in the dark to avoid startling them. However, please keep in mind the following facts.
 - Turning the AF-assist beam off may make it more difficult for the camera to focus, e.g. dark conditions.
 - The red-eye reduction lamp may emit when you press the shutter button halfway even if the AF-assist beam is turned off.In order to prevent any lamp from emitting before the flash fires, set both the red-eye reduction function and the AF-assist beam to [Off] in the Shooting menu.

Selecting Menus and Settings

● Selecting Settings by Pressing the FUNC. Button (Only in Shooting Mode)

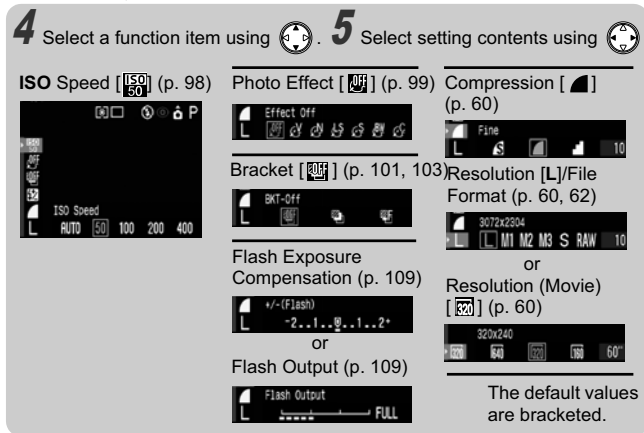
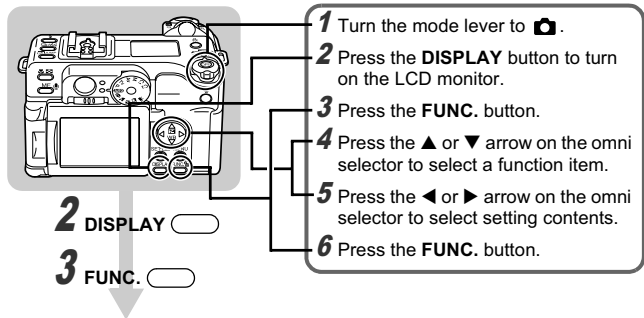

6 **FUNC.**

In Steps 5 and 6, you can also use the main dial.

5 Turn

6 Click

● Selecting Settings by Pressing the MENU Button

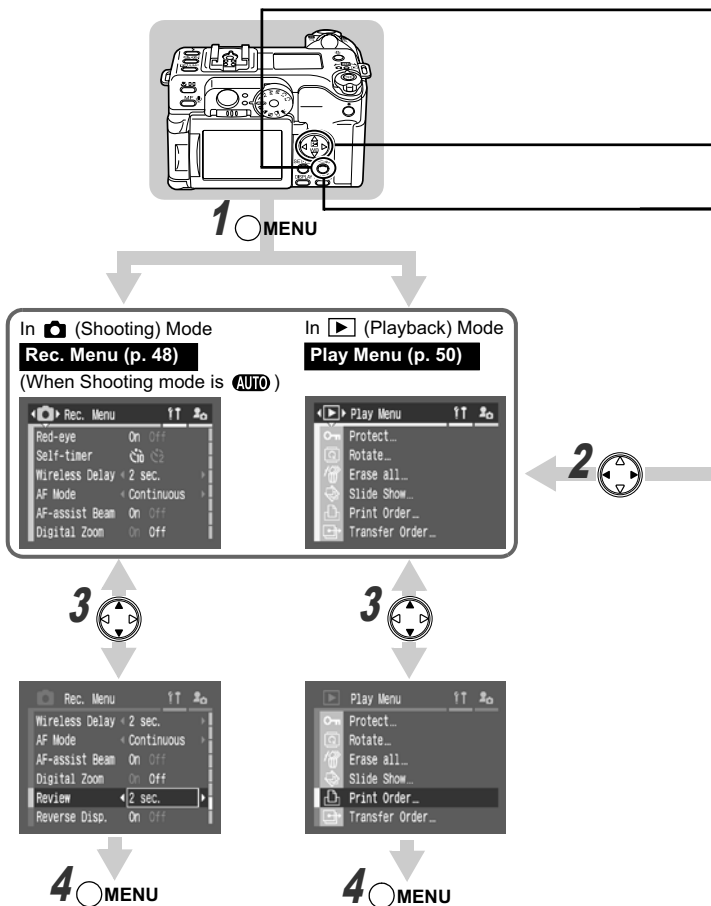

- 1** Press the **MENU** button.
- 2** Press the ◀ or ▶ arrow on the omni selector to switch between menu tabs.
- 3** Press the ▲ or ▼ arrow on the omni selector to select a menu item, then press the ◀ or ▶ arrow on the omni selector to select setting contents.
- 4** Press the **MENU** button.

- In Step 2, you can also use the **JUMP** button and zoom lever.
- Settings cannot be selected with the main dial.
- Press the **SET** button for items followed by an ellipsis (...) and then select a setting. Press the button again to confirm the setting.
- In Shooting mode, the menu can be closed by pressing the shutter button halfway. (In Playback mode, the menu closes when the shutter button is pressed halfway and the camera switches to shooting mode.)

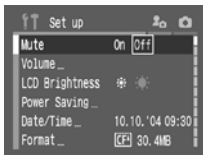
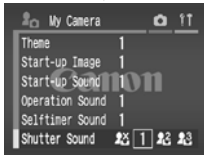
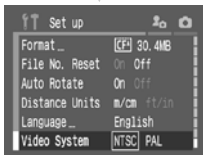
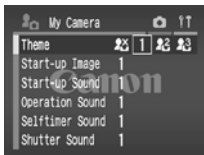
Set up Menu (p. 51)

My Camera Menu (p. 53, 161)



- Displayed menu items will vary according to the shooting mode and setting contents (p. 206).
- You can apply a desired image and sound to [L3] and [L3] in the My Camera menu. For details, see *Registering the My Camera Settings* (p. 163) or the *Software Starter Guide*.
- The default of all the settings changed by the menu and button operations except for [Date/Time], [Language] and [Video System] can be restored all at once (p. 54).

Menu Items Selectable with the MENU Button and Default Settings

This chart shows the options for each menu and the default settings.

● (Rec.) Menu

Menu Item	Setting Content	Reference Page
Flash Sync	Sets the timing at which the flash fires. 1st-curtain*/2nd-curtain	111
Slow Synchro	Sets whether or not the flash will fire with a slow shutter speed. On/Off*	66
Flash Adjust	Sets whether or not the flash is adjusted automatically. Auto*/Manual	109
Red-eye	Sets whether or not the red-eye reduction lamp fires when the flash fires. On*/Off	65
Cont. Shooting	In the Continuous Shooting mode, choose whether you view the subject as you shoot continuously (standard) or shoot with a short shutter interval without viewing (high speed). * (standard)/ (high speed)	78
Self-timer	Sets the duration before the self-timer releases the shutter once the shutter button is pressed. 10 sec.*/2 sec.	76

* Default setting

Menu Item	Setting Content	Reference Page
Wireless Delay	Sets the duration before the self-timer releases the shutter once the remote control shutter button is pressed. 0 sec./2 sec.*10 sec.	175
Spot AE Point	Sets the option of [Spot AE Point] (one of the light metering modes), Center (the AE point is fixed to the center) or AF Point (the AE point corresponds to the AF point). Center*/AF Point	92
ND Filter	Sets the ND filter. On/Off*	120
Safety Shift	Adjusts the settings so that the exposure will be appropriate when the shooting mode dial is set to Tv or Av and a shutter speed or aperture value has been set. On/Off*	86
MF-Point Zoom	Sets whether or not the focusing point is magnified when using the manual focus. On*/Off	116
AF Mode	Sets the frequency of autofocus activation, Continuous (continuous autofocusing) or Single (autofocused only when the shutter button is pressed halfway). Continuous*/Single	118
AF-assist Beam	Sets whether or not the AF-assist Beam is activated as needed when using the auto focus. On*/Off	44
Digital Zoom	Sets whether or not the digital zoom combines with the optical zoom to zoom images. On/Off*	77
Review	Sets the duration images display on the LCD monitor after the shutter button is released. Off/2 sec.* to 10 sec.	57

Selecting Menus and Settings (continued)

Menu Item	Setting Content	Reference Page
Reverse Disp.	Sets whether or not the image is reversed when the LCD monitor is tilted 180 degrees toward the lens. On*/Off	33
RAW + JPEG Rec.	It is possible to select the resolution for JPEG thumbnails contained within RAW format image files. This is useful when displaying enlarged RAW-format images with the camera, or when checking either the focus or for camera shake. Setting the camera to L enables the focus to be checked with greater precision. L/M1/M2/M3/S* ● The size of the file will depend on the selected resolution.	63
Intervalometer	Shoots automatically at set intervals. 2* to 100 shots 1* to 60 min.	112
Save Settings	Saves settings selected in the Rec. menu and the Function menu to the mode dial's C1 or C2 mode.	119

* Default setting



● (Play) Menu

Menu Item	Setting Content	Reference Page
Protect	Protects images from accidental erasure.	139
Rotate	Rotates images 90 or 270 degrees clockwise in the display.	132
Erase all	Erases all images from a CF card (excluding protected images).	140
Slide Show	Plays images in an automated slide show.	135
Print Order	Sets the images that will be printed on a direct print compatible printer or at a photo lab service, the number of copies and other parameters.	144

* Default setting

Menu Item	Setting Content	Reference Page
Transfer Order	Specifies images before downloading to a computer.	149



● **11** (Set up) Menu





Menu Item	Setting Content	Reference Page	
Mute	Set [On] to mute the start-up sound, operation sound, selftimer sound and shutter sound all at once. On/Off* <ul style="list-style-type: none"> If you set [Mute] to [On], no sound will be heard even when any sound item in the My Camera menu is set to [1], [2] or [3] (On). Note that the error warning signal beeps even when the Mute setting is [On]. The main dial does not beep even if it is pressed regardless of the setting. 	44, 134, 162	
Volume	① Start-up Vol.	Adjusts the Start-up Sound volume when the camera powers up.	29, 53
	② Operation Vol.	Adjusts the Operation Sound volume of operation buttons other than the shutter button.	53
	③ Selftimer Vol.	Adjusts the sound volume of the Selftimer Sound informing you that the photo will be taken in 2 seconds.	53, 76
	④ Shutter Volume	Adjusts the Shutter Sound volume when the shutter button is pressed all the way. There is no shutter sound in Movie mode.	44, 53
	⑤ Playback Vol.	Adjusts the sound volume when a sound memo or a movie is played.	128, 133, 134
	Settings of Above Items (① - ⑤)	 Off 1 2* 3 4 5	
LCD Brightness	Sets the brightness level of the LCD monitor.  (Normal)* /  (Bright)	-	

Selecting Menus and Settings (continued)

Menu Item		Setting Content	Reference Page
Power Saving	Auto Power Down	Sets whether or not the camera automatically powers down after a specified period of time elapses without camera operation. On*/Off	31
	Display Off	Sets the length of time before the LCD monitor goes off when no camera operation is performed. 10 sec./20 sec./30 sec./1 min./2 min./3 min.	31
Date/Time		Sets the date, time and date format.	26
Format		Formats (initializes) a CF card.	141
File No. Reset		Sets how file numbers are assigned to images when new CF cards are inserted. On/Off*	122
Auto Rotate		Sets whether or not images shot with the camera held vertically are automatically rotated in the display. On*/Off	121
Distance Units		Sets the format of the displayed distance units of the MF indicator. m/cm* or ft/in	115, 116
Language		Sets the language used in the menus and messages on the LCD monitor. English*/Deutsch/Français/Nederlands/Dansk/Suomi/Italiano/Norsk/Svenska/Español/Chinese/Русский/Português/Japanese You can change the language during image playback by holding the SET button and pressing the JUMP button.	28
Video System		Sets the video output signal standard. NTSC/PAL	160

● (My Camera) Menu

You can select the theme, start-up image and sound, operation sound, selftimer sound and shutter sound used on this camera. These are called My Camera settings. You can also customize the  and  options for each item with images from the CF card and newly recorded sounds or by using the supplied software. See the *Software Starter Guide* for details.

Menu Item	Setting Content	Reference Page
Theme	Selects a common theme for each My Camera settings item.*1	161
Start-up Image	Sets the start-up image when you turn on the camera.	161
Start-up Sound	Sets the start-up sound when you turn on the camera.*1	161
Operation Sound	Sets the sound when the omni selector or any button other than the shutter button is operated.*1	161
Selftimer Sound	Sets the sound informing you that the photo will be taken in 2 seconds.*1	161
Shutter Sound	Sets the shutter sound when you depress the shutter button. There is no shutter sound while a movie is being shot.*1	161
Settings of Above Items	 (Off) /  1 * /  / 	

*1 See also [Mute] in the Set up Menu (p. 51).

Resetting the Settings to Default

You can reset the menu and button operation settings to default.

1 Turn on the camera.

- You can turn on the camera in either Shooting or Playback mode.

2 Press the MENU button for longer than 5 seconds.

- The message “Reset settings to default?” appears on the LCD monitor.

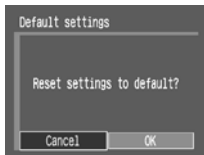

3 Select [OK] using the ◀ or ▶ arrow on the omni selector, then press the SET button.

- The screen on the right appears while resetting. The normal screen resumes when resetting is complete.
- To cancel resetting, select [Cancel] instead of [OK].

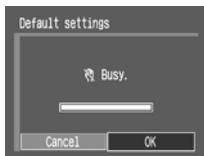

- The following settings cannot be reset to default:
 - The [Date/Time], [Language] and [Video System] options in the **i** menu (p. 52)
 - White balance data set with the custom white balance function (p. 96)
 - Newly registered My Camera settings (p. 163)
- When the camera is in Shooting mode and the mode dial is set to **C1/C2**, only the **C1/C2** mode settings will revert to default. In other cases, the **C1/C2** settings will not revert to default.

Shooting – Letting the Camera Select Settings

See *Functions Available in Each Shooting Mode* (p. 206) at the end of this manual to find out which settings can be changed in which shooting modes.

AUTO Auto Mode

In this mode, all you have to do is press the shutter button and let the camera do everything else.

1 Check that the camera is in Shooting mode (p. 30).

2 Turn the mode dial to **AUTO**.

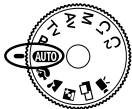

3 Aim the camera at the subject.

4 Use the zoom lever to achieve the desired composition (relative subject size on the LCD monitor).

5 Press the shutter button halfway (p. 43).

- The camera focuses on the subject. Two beeps will sound when the camera has finished metering, and the indicator will light green or orange.

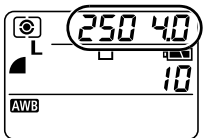

- If the LCD Monitor is on, the AF frame(s) will be displayed in green.
- The shutter speed and aperture value are automatically determined and show on the display panel. The shutter speed and aperture will also be displayed on the LCD Monitor if the monitor is on.
- If the camera is having difficulty focusing, one beep will sound and the lamp will blink yellow. The AF frame(s) will also be displayed in yellow when the center-point AF frame is selected.



AF Frame

6 Press the shutter button all the way (p. 43).

- You will hear the sound of the shutter when the shutter activates.
- If the LCD Monitor is on, the images you have just shot will be displayed on the monitor for around two seconds.



- See page 206 for settings that can be changed in this mode.
- With the Review function, you can change the length of time images appear on the LCD monitor after shooting, or set it so they do not appear at all (p. 57).

Reviewing an Image Right after Shooting

Mode Dial

AUTO  P Tv Av M

Reviewing the Image

After a photo is taken, the image appears on the LCD monitor for two seconds (you can change this setting). In addition, the image will keep on displaying regardless of the review duration setting if one of the following operations is performed.

● Keeping the shutter button pressed

The image continues to appear on the LCD monitor as long as you keep the shutter button fully depressed.

● Pressing the SET button or button while the image is displayed*

The image will continue to display even after the shutter button is released. To let the camera return to Shooting mode, press the shutter button halfway.



● You can perform the following while images are displayed*.

- Erasing images individually (p. 140)
- Displaying images in Detailed Display mode (p. 36)
- Magnifying Images (p. 125)
- Changing the recording format (p. 58)
- Attaching sound memos (p. 133)

* Not available in  (Stitch Assist) mode.

Changing the Image Display Duration

The length of time images are displayed after a photo has been taken can be changed anywhere from 2 seconds to 10 seconds or turned off.

1

In the [ (Rec.)] menu, select [Review].

- See *Selecting Menus and Settings* (p. 46).

2 Select a Review setting and press the MENU button.

- [Off]: The image will not automatically display.
- [2 sec.] to [10 sec.]: The image will appear for the time selected even if the shutter button is released.
- You can continue to display the image as long as the shutter button is held down regardless of the Review setting.
- Another picture can be taken by pressing the shutter button even while the last is displayed.

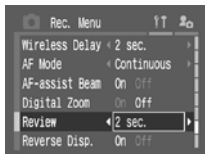

Changing the Recording Format Right after Shooting

Mode Dial

P Tv Av M

By following the instructions below, you can save images shot in the JPEG format in the RAW format (p. 62) right after shooting.*

You can easily process images saved in the RAW format using a computer to edit the resolution, photo effect and white balance without any loss of quality.

* The JPEG format image will not be saved.

1 Right after shooting, press the button while the image is displayed on the LCD monitor.

2 Select [OK] using the ◀ or ▶ arrow on the omni selector and press the SET button.

- The image is recorded in the RAW format.
- When you press the shutter button halfway, the camera returns to the shooting screen.
- To cancel recording the image in the RAW format, perform one of the actions below.
 - Select Cancel and press the **SET** button.
 - Press the ⚡ button.



- The above operations cannot be performed if the image was shot with the digital zoom or when **RAW** is already selected as the recording format.

Changing the Resolution and Compression

Mode Dial

You can change the resolution and compression (still images) settings to suit the purpose of the image you are about to shoot. To record the CCD output without compression, select the RAW file format (p. 62).

● Still images

Resolution			Purpose
L (L) Large	3072 x 2304 pixels	High Low	<ul style="list-style-type: none"> • Print A4 size* 210 x 297 mm (8.3 x 11.7 in.) or larger prints
M1 (M) Medium 1	2592 x 1944 pixels		<ul style="list-style-type: none"> • Print letter size* 216 x 279 mm (8.5 x 11 in.) or larger prints
M2 (M) Medium 2	2048 x 1536 pixels		<ul style="list-style-type: none"> • Print A4 size* 210 x 297 mm (8.3 x 11.7 in.) prints • Print letter size* 216 x 279 mm (8.5 x 11 in.) prints
M3 (M) Medium 3	1600 x 1200 pixels		<ul style="list-style-type: none"> • Print postcard size 148 x 100 mm (6 x 4 in.) prints • Print L size 119 x 89 mm (4.7 x 3.5 in.) prints
S (S) Small	640 x 480 pixels		<ul style="list-style-type: none"> • Send images as e-mail attachments • Shoot more images

* Paper sizes vary according to region.

(The icons in the parentheses appear on the display panel.)

Compression			Purpose
Superfine	High Normal	Shoot higher quality images	
Fine		Shoot normal quality images	
Normal		Shoot more images	

● Movies

Resolution	
	640 x 480 pixels
	320 x 240 pixels
	160 x 120 pixels

1 Press the DISPLAY button to turn the LCD monitor on.

- You can also change camera settings using the icons in the Display Panel (except for movies).

2 Press the FUNC. button.

3 Select **▲*** (Compression) or **L*** (Resolution) using the **▲** or **▼** arrow on the omni selector.

- * The current setting is displayed.



4 Select the compression or resolution you wish to set using the main dial or the **◀** or **▶** arrow on the omni selector.

- You can shoot the image right after selecting settings by pressing the shutter button. This screen will appear again, once the image is shot.

Resolution (Excluding **▶**)



Compression

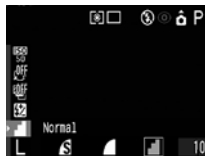

Number of shots remaining* (Only displayed when the resolution, compression or file format is selected)
* In the case of a movie clip, the remaining shooting time (in seconds) appears.

5 Press the FUNC. button or click the main dial.



- See *CF Cards and Estimated Capacities (Recordable Images)* (p. 198)
- See *Image File Sizes (Estimated)* (p. 199)

Changing the File Format

Mode Dial

P Tv Av M

The camera can be set to record images in the RAW format before shooting.

This camera records images in either JPEG format or RAW format.

● JPEG format

When pictures are taken in JPEG format, the images are processed inside the camera for optimum image quality, and also compressed to allow a larger number of images to be stored on the CF Card.

However, the compression process is irreversible, meaning that the original image data cannot be recovered once it has been compressed.

● RAW format

When pictures are taken in RAW format, no processing is carried out inside the camera, and the raw data from the CCD is recorded as is. As with JPEG format, the RAW images are compressed at the time of recording. However, with the RAW format, the compression process is completely reversible, meaning you can obtain high quality pictures without any image degradation, similar to those recorded with non-compression file formats such as RGB-TIFF. The file size of RAW image is also very compact, at around one quarter* of the size of RGB-TIFF images.

Standard uncompressed files formats, such as RGB-TIFF, are processed by the camera, meaning that if you make further adjustments with image editing software, image quality may be affected. Images in RAW format cannot be opened using photo-editing software and must be first converted (processed) into a standard file type such as TIFF or JPEG. If you use the bundled software ZoomBrowser EX (Windows)/ImageBrowser (Macintosh), you can process RAW images into a standard file type after adjusting the quality of the original image data. This ensures that you can create the image of your choice while preserving high image quality. For further details, please refer to the *Software Starter Guide*. The resolution (3072 x 2304) and compression settings cannot be adjusted for RAW images. When a RAW image is recorded, a JPEG thumbnail will be created at the same time.

*As measured by Canon's testing standard.

1 Press the DISPLAY button to turn the LCD monitor on.

- You can also change camera settings using the icons in the Display Panel.

2 Press the FUNC. button.

3 Select L* (LCD monitor) or L* (Display Panel) using the ▲ or ▼ arrow on the omni selector.

- * The current setting is displayed.



4 Select RAW (LCD monitor) or r (r) (Display Panel) using the main dial or the ◀ or ▶ arrow on the omni selector.

- You can shoot the image right after selecting settings by pressing the shutter button. The previous screen will appear again, once the image is shot.

5 Press the FUNC. button or click the main dial.







- It is possible to select the resolution for JPEG thumbnails contained within RAW format image files. This is useful when displaying enlarged RAW format images with the camera, or when checking either the focus or for camera shake (p. 50).
- Images shot in the JPEG format can also be changed to the RAW format while they are displayed right after shooting (p. 58).

⚡ Using the Built-In Flash

Mode Dial

AUTO    P Tv Av M

Use the flash according to the guidelines below.

	Auto with red-eye reduction	The flash fires automatically as required by the lighting level, and the red-eye reduction lamp fires each time the main flash fires.
	Auto	The flash fires automatically as required by the lighting level.
	Flash on with red-eye reduction	The red-eye reduction lamp and the flash always fire.
	Flash on	The flash always fires.
	Flash off	The flash does not fire.

* No icon appears on the display panel.

• For information on the external flash, see page 180.

1 Press the ⚡ button to switch between flash modes.

- The selected flash mode appears on the display panel. It will also be displayed on the LCD Monitor if the monitor is on.
- You can switch between settings by pressing the ⚡ button. Some settings are not available with certain shooting modes (p. 206).

When the red-eye reduction function is on (p. 65)

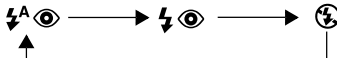

When the red-eye reduction function is off (p. 65)

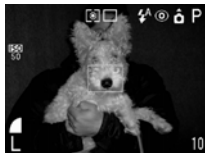
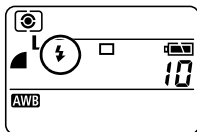
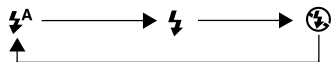

Setting the Red-eye Reduction Function

Mode Dial

AUTO     P Tv Av M

The red-eye reduction lamp fires when the flash is used in dark areas. This reduces light reflecting back from the eyes and making them appear red.

1 In the [(Rec.)] menu, set [Red-eye] to [On].

-  appears on the LCD monitor if it is set to Information View display.
- When shooting with the red-eye reduction function, the subjects must look right at the red-eye reduction lamp for this mode to be effective. Try asking them to look directly at the lamp. Even better results can be obtained by shooting with the lens set to a wide angle, increasing the lighting in indoor settings or approaching closer to the subject.

Setting the Slow Synchro

Mode Dial



You can shoot images using the flash with a slow shutter speed. This helps brighten up dark backgrounds when shooting night scenes or with indoor lighting conditions.

1 In the [(Rec.)] menu, set [Slow Synchro] to [On].

-  ● When shooting with a high ISO sensitivity while using the built-in flash, there is more of a chance of overexposure the closer you are to the subject.

-  ● The flash fires with automatic adjustments when [Flash Adjust] is set to [Auto] in the Rec. menu. When shooting in **M** mode, or with [Flash Adjust] set to [Manual], the flash fires with the manually set adjustments.
 - When [Flash Adjust] is set to [Auto], the flash fires twice. A pre-flash will fire and will be followed by the main flash. The pre-flash is used by the camera to obtain the subject's exposure data so that the main flash can be set to the optimal intensity for the shot.
 - The fastest shutter speed for flash synchronization is 1/250 second. The camera automatically resets the shutter speed to 1/250 second if a faster speed is selected.
 - Shots cannot be taken while the flash is charging.
 - The flash may take up to approximately 10 seconds to charge in some cases. Actual times will vary according to usage and the battery charge.
 - The flash exposure and the flash output can be changed (p. 109).
 - When shooting with [Slow Synchro] set to [On], camera shake may become a factor. We recommend the use of a tripod.
 - The flash setting is saved when the camera is turned off in the **P**, **Tv**, **Av** and **M** shooting modes.

Portrait Mode

Use this mode when you want the subject to appear sharp and the background to blur.

1

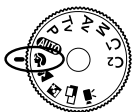

Turn the mode dial to .

Shooting procedures are the same as for the **AUTO** mode (p. 55).



- See page 206 for settings that can be changed in this mode.
- To best achieve the effect of the background gradually blurring, compose the image so that the upper half of the subject's body fills most of the viewfinder or LCD monitor.
- The background gets increasingly indistinct the more you adjust the focal length toward telephoto.

Landscape Mode

Use this mode to shoot expansive landscape scenes.

1

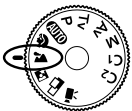

Turn the mode dial to .

Shooting procedures are the same as for the **AUTO** mode (p. 55).



- See page 206 for settings that can be changed in this mode.
- Since a slow shutter speed is often selected, use a tripod to shoot if the  (camera shake warning) icon appears on the LCD monitor.

Night Scene Mode

Use this mode to capture human subjects against the backdrop of an evening sky or night scene. The subjects are illuminated with light from the flash while the backdrop is captured at a slow shutter speed so that both appear correctly exposed.

1

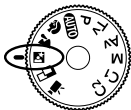

Turn the mode dial to .

Shooting procedures are the same as for the **AUTO** mode (p. 55).



- Always use a tripod to prevent camera shake in this mode.



- See page 206 for settings that can be changed in this mode.
- Warn people to stay still for a few seconds after the flash fires because of the slow shutter speed.
- Since a slow shutter speed is often selected, using the  mode in daylight will produce an effect similar to that of the **AUTO** mode.
- The slow synchro function automatically turns on (p. 66).

Shooting Panoramic Images (Stitch Assist)

Use this mode to shoot a series of overlapping frames for merging (stitching) into a large panoramic image using a computer.

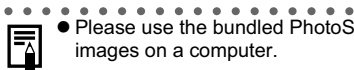
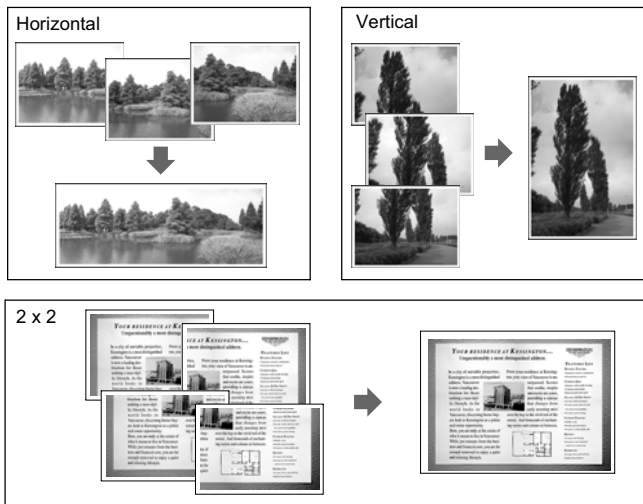

- Please use the bundled PhotoStitch program to merge the images on a computer.

Framing a Subject

PhotoStitch detects the overlapping portions of adjoining images and merges them. When composing shots, try to include a distinctive item (landmark, etc.) in the overlapping portions.

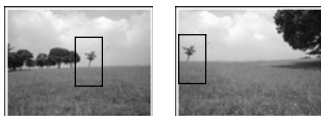







- Compose each frame so that it overlaps 30 to 50% of the adjoining image.
Try to keep the vertical misalignment to within 10% of the image height.
- Do not include moving items in the overlap.
- Do not try to stitch images that include both distant and close subjects. Objects may appear warped or doubled up.
- Make the brightness in each image consistent. The final image will appear unnatural if the difference in brightness is too great.
- For good results, pan (swivel) the camera to take successive shots.
- To shoot close-ups, slide the camera over the subject, keeping it parallel as you move.

Shooting

Images can be shot in the following 5 sequences in Stitch Assist mode.

	Horizontally, left to right
	Horizontally, right to left
	Vertically, bottom to top
	Vertically, top to bottom
	Clockwise starting at the top left

1

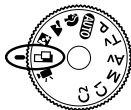

Turn the mode dial to .

- The LCD monitor will turn on.

2

Select the shooting sequence using the ◀ or ▶ arrow on the omni selector and press the SET button.

- The shooting sequence is set.
- You can also press the shutter button directly to shoot without pressing the SET button.



3 Shoot the first image.

- The exposure and white balance settings are set and locked with the first image.

4 Compose and shoot the second image so that it overlaps the first.

- Minor discrepancies in the overlap can be corrected with the software.
- An image can be retaken. Press the ▲, ▼, ◀ or ▶ arrow on the omni selector to return to that frame.



Sequence



Sequence

5 Use the same procedures to shoot the remaining frames.

- A maximum of 26 images can be recorded either horizontally or vertically.

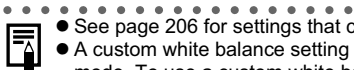

6 Press the SET button after the last shot.



- See page 206 for settings that can be changed in this mode.
- A custom white balance setting (p. 96) cannot be set in mode. To use a custom white balance setting, first set it in another shooting mode.
- The settings in place for the first image are locked in and cannot be changed for subsequent shots.
- A TV cannot be used as the monitor for shooting in this mode.

Movie Mode

Use this mode to shoot movies. The resolution can be selected from the following settings (p. 60):

- [ (640 x 480)]
- [ (320 x 240)]
- [ (160 x 120)]

1

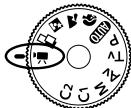

Turn the mode dial to .

The LCD monitor displays the maximum recording time (in seconds).



2

Press the shutter button all the way.

- Shooting and sound recording starts simultaneously.
- During shooting a red circle appears in the upper right of the LCD monitor.

3

Press the shutter button all the way to stop recording the movie.

- The maximum length of individual movie clips is 30 seconds at the  setting (10 frames/second) and 3 minutes at the  and  settings (15 frames/second) (The data reflects Canon's testing standard.). The clip will end automatically after this time elapses or when the CF card becomes full.
- The maximum recording time depends on the type of CF card. See *CF Cards and Estimated Capacities (Recordable Images)* (p. 198).



- You are recommended to use a CF card that has been formatted in your camera to shoot movies (p. 141). The supplied CF card can be used without being formatted.
- The recording time may not display properly during shooting or filming may stop unexpectedly with the following types of CF cards.
 - Slow recording cards
 - Cards formatted on a different camera or a computer
 - Cards which have had images recorded and erased repeatedlyAlthough the recording time may not display properly during shooting, the movie will be recorded correctly on the CF card. Recording time will display properly if you format the CF card in this camera (excluding slow recording CF cards).
- Be careful not to touch the microphone while shooting.
- While shooting, be careful not to touch any camera buttons other than the shutter button, since the sound of the button being pressed will be recorded on your movie.
- The AE, AF, white balance and zoom settings are set and locked to the settings of the first frame.
- If the upper indicator blinks green after a shot, this indicates that the movie is being written to the CF card. You cannot shoot again until it stops blinking.



- See page 206 for settings that can be changed in this mode.
- Sound is recorded monaurally.
- There is no shutter sound in Movie mode.
- QuickTime 3.0 or higher is required to play back movie files (AVI/Motion JPEG) on a computer. (QuickTime (for Windows) is bundled on the supplied Digital Camera Solution Disk. On the Macintosh platform, QuickTime 3.0 or later is generally bundled with Mac OS 8.5 or later operating system.)

Macro Mode



Mode Dial

AUTO     **P Tv Av M**

Use the macro mode to shoot close-ups of subjects in the range of 5 to 50 cm (2.0 in. to 1.6 ft.) at wide angle end and 15 to 50 cm (0.5 ft. to 1.6 ft.) at telephoto end.

1 Press the **DISPLAY** button to turn the LCD monitor on.

2 Press the button.

-  appears on the display panel and the LCD monitor.
- Press the  button again to cancel the macro mode.



- Always use the LCD monitor to compose images in macro mode. Shooting with the viewfinder is possible, though, the parallax phenomenon may cause images composed with the optical viewfinder to be off-center.
- When the lens is zoomed out to the wide angle end, the recordable area is 75 x 50 mm (3.0 in. x 2.0 in.) at the closest focal distance, and at telephoto end, it is 56 x 42 mm (2.2 in. x 1.7 in.).

📷 Super Macro Mode

Mode Dial

P Tv Av M

Compared with normal Macro mode, you can get closer to the subject and magnify it more, when shooting. The background can also be shot with different effects.

You can shoot subjects in Super Macro mode when the distance from the end of the lens to the subject is in the following range: 5 to 20 cm (2.0 to 7.9 in.) (wide angle end – 86 mm (35mm film equivalent)).

The resolution can only be set to **M2**, **M3** or **S**. If the resolution is set to **L**, **M1** or **RAW** when you set the camera to Super Macro mode, the resolution will automatically be changed to **M2**. (The resolution will return to the previous setting when you cancel Super Macro mode.)

1 Press the **DISPLAY** button to turn the LCD monitor on.

2 Hold down the  button until  appears on the LCD monitor.

- The zoom position moves within the recordable area.
- You can cancel the super macro mode by pressing the  button again.



- Be careful not to bang the lens against the subject when shooting in Super Macro mode.
- Super Macro mode does not work properly when any separately sold lens is attached to the camera.



- The digital zoom cannot be used.
- Recordable areas at the minimum shooting range are as follows:

Zoom Position (35mm film equivalent)	Recordable Area
Wide angle end	Approximately 48 x 36 mm (1.9 x 1.4 in.)
86 mm	Approximately 24 x 18 mm (0.9 x 0.7 in.)

- Super Macro mode can also be selected and saved in Custom Modes **C1** and **C2**.

Self-Timer

Mode Dial

AUTO P Tv Av M

1 Press the button.

- Press the button several times until appears on the display panel. If the LCD Monitor is on, press the button until the icon or icon appears in the monitor.
- You can cancel the self-timer by pressing the button again.
- When the self-timer is set to (), the shutter activates 10 (2) seconds after the shutter button is pressed fully.
- When is selected, the self-timer sounds and the self-timer lamp starts blinking when the shutter button is pressed all the way. The blinking gets faster two seconds before the shutter activates.
- When is selected, the self-timer lamp blinks fast from the beginning. The shutter activates in two seconds.
- You can change the self-timer sound by changing the setting in [Selftimer Sound] in the [(My Camera)] menu (p. 53).

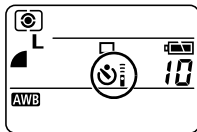

Setting the Number of Seconds until Shooting

You can set the number of seconds from the time the shutter button is pressed to the time the image is shot to 10 seconds or 2 seconds.

1 Select [Self-timer] from the [(Rec.)] menu.

- See *Selecting Menus and Settings* (p. 46).

2 Select [] (10 seconds) or [] (2 seconds) and press the MENU button.

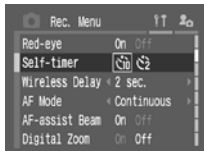

Digital Zoom

Mode Dial

AUTO P Tv Av M

With the combined optical and digital zoom functions, images can be zoomed as follows:

4.7x, 6x, 7.7x, 9.6x, 12x and 16x.

1 Press the **DISPLAY** button to turn the **LCD monitor** on.

2 In the [] (Rec.) menu, select [**Digital Zoom**].

- See *Selecting Menus and Settings* (p. 46).

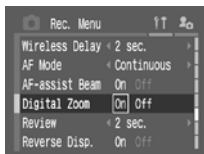

3 Select [**On**] and press the **MENU** button.

4 Press the zoom lever toward .

- The lens will zoom to the maximum optical telephoto setting and stop. Release the lever and press it toward again to further zoom the image digitally.
- Press the zoom lever toward to zoom back out.

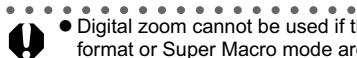

- Digital zoom cannot be used if the LCD Monitor is off, or if RAW format or Super Macro mode are selected.





- Images become coarser the more they are digitally zoomed.

Continuous Shooting

Mode Dial

   **P** Tv Av M

Use this mode to shoot successive frames while the shutter button is fully pressed.

	Standard Continuous Shooting	Use this mode when you would like to shoot in continuous mode but want to confirm your images immediately after you have shot them. The shutter interval is longer in this mode than in  mode.
	High Speed Continuous Shooting	Use this mode to shoot continuously with a short shutter interval. You cannot check images while shooting continuously.

1 In the [(Rec.)] menu, select [Cont. Shooting].



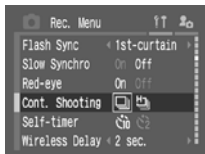

- See *Selecting Menus and Settings* (p. 46).



2 Select [] or [] and press the MENU button.

- Turning the camera off restores the standard shooting mode. However, the selected continuous shooting option will remain effective the next time continuous shooting is activated.

3 Press the button.

- Press the  button several times until  or  appears on the display panel. The icon will also be displayed on the LCD Monitor if the monitor is on.
- You can cancel the continuous mode by pressing the  button until  appears.

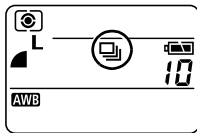

4 Press the shutter button halfway to lock the focus.

5 Press the shutter button all the way to shoot.

- Shooting will stop when the shutter button is released.
- The shooting speed is as follows.

When [] is selected: Approx. 1.2 frames per second*

When [] is selected: Approx. 2.0 frames per second*

* Large/Fine mode with LCD monitor off (These figures reflect Canon's testing standard. The actual figures will vary according to the shooting conditions and settings.)



- The interval between frames lengthens when the internal memory becomes full.
- The built-in flash can be used, but the interval between images will lengthen to accommodate the flash recharge time.
- The flash will not fire with an externally mounted flash.

Camera settings such as shutter speed and aperture value can be freely changed for shooting.

See *Functions Available in Each Shooting Mode* (p. 206) at the end of this manual to find out which settings can be changed in which shooting modes.



- Please see **AUTO** *Auto Mode* (p. 55) for shooting procedures once you have changed a setting.

P Program AE

Use the program AE mode to have the camera automatically set the shutter speed and aperture value to match the brightness of the scene.

1



Turn the mode dial to P.

2 Shoot the image.

- The shutter speed and aperture value will be set automatically and shown on the display panel. The shutter speed and aperture will also be displayed on the LCD Monitor if the monitor is on.
- The correct exposure has been set if the shutter speed and aperture value appear in white on the LCD monitor.
- You can change the automatically selected combinations of shutter speeds and aperture values without altering the exposure (p. 106).

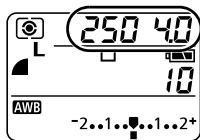



- See page 206 for settings that can be changed in this mode.
- If a correct exposure cannot be obtained, the shutter speed and aperture value show in red on the LCD monitor. Use the following methods to obtain the correct exposure and make them show in white.
 - Use the flash.
 - Change the light metering mode.
 - Change the ISO speed setting.

Differences between the P and **AUTO** Modes

- The following settings can be adjusted in **P** mode, but not in **AUTO** mode.
 - Exposure Compensation
 - Bracket Mode
 - AE Lock
 - Built-In Flash (Flash on, Slow Synchro, 2nd-curtain flash)
 - Continuous Shooting
 - Manual Focus
 - Super Macro Mode
 - White Balance
 - Flash Exposure Compensation
 - FE Lock
 - File Format Settings
 - AF frame selection
 - ISO Speed
 - Photo Effect
 - ND Filter
 - Light Metering Mode
 - Intervalometer

Tv Setting the Shutter Speed

When you set the shutter speed in the shutter speed-priority AE mode, the camera automatically selects an aperture value to match the brightness. Faster shutter speeds allow you to catch an instantaneous image of a moving subject while slower speeds create a flowing effect and allow you to shoot without a flash in dark areas.

1

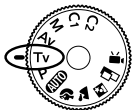

Turn the mode dial to Tv.

- The shutter speed will show on the display panel. It will also be displayed on the LCD Monitor if the monitor is on.

2 Turn the main dial and select a shutter speed.

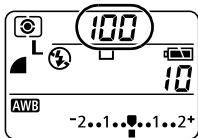

3 Shoot the image.

- The correct exposure has been set if the shutter speed and aperture value show in white on the LCD monitor.
- If the aperture value is shown in red on the LCD monitor, the image is underexposed (insufficient light) or overexposed (too much light). Adjust the shutter speed using the main dial until the aperture value display turns to white. If you set [Safety Shift] to [On] in the Rec. menu, the shutter speed will shift to the correct speed automatically (Safety Shift function (p. 86)).
- You can change the automatically selected combinations of shutter speeds and aperture values without altering the exposure (p. 106).

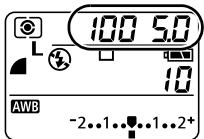



- The nature of CCD image sensors is such that noise in the recorded image increases at slow shutter speeds. This camera, however, applies special processing to images shot at shutter speeds slower than 1.3 seconds to eliminate the noise, thereby producing high-quality images. Nevertheless, a certain amount of processing time may be required before the next image can be shot.



- See page 206 for settings that can be changed in this mode.
- Please note that camera shake becomes a factor at slow shutter speeds. If the camera shake warning  appears on the LCD monitor, secure the camera to a tripod before shooting.
- The fastest shutter speed that can be used effectively with the flash is 1/250 second. If you try to select a speed faster than 1/250 second, the camera automatically resets the shutter speed to 1/250 second.
- The aperture value and shutter speed change according to the zoom state as follows.

	Aperture Value	Shutter Speed (seconds)
Wide Angle	F2.0 – 3.5	to 1/1250
	F4.0 – 8.0	to 1/2000
Telephoto	F3.0 – 5.0	to 1/1250
	F5.6 – 8.0	to 1/2000

Shutter Speed Display

The shutter speeds from 2000 to 4 in the display panel are actually the denominator of a fraction of a second. For example, 160 indicates a speed of 1/160 second. For slower speeds, quote marks indicate the decimal place, so that 0"3 indicates 0.3 second and 2" indicates 2 seconds.

15"	13"	10"	8"	6"	5"	4"	3"2	2"5	2"	1"6	1"3	1"	0"8	0"6		
0"5	0"4	0"3														
4	5	6	8	10	13	15	20	25	30	40	50	60	80	100	125	160
200	250	320	400	500	640	800	1000	1250	1600	2000						

The display of shutter speeds from 1/4 to 1/2000 second differs between the display panel and LCD monitor.

Shutter Speed	15 sec.	...	0.8 sec.	...	1/4 sec.	...	1/2000 sec.
Display Panel	15"	...	0"8	...	4	...	2000
LCD Monitor	15"	...	0"8	...	1/4	...	1/2000

Av Setting the Aperture

When you set the aperture in the aperture-priority AE mode, the camera automatically selects a shutter speed to match the brightness.

Selecting a lower aperture value (opening the aperture) allows you to blur the background and create a beautiful portrait. A higher aperture value (closing it) brings the entire range from foreground to background into focus. The larger the aperture value, the greater the range of the image brought into clear focus.

1

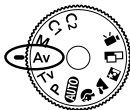

Turn the mode dial to Av.

- The aperture value will show on the display panel. It will also be displayed on the LCD Monitor if the monitor is on.

2 Turn the main dial and select an aperture value.

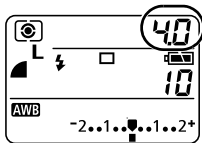

3 Shoot the image.

- The correct exposure has been set if the shutter speed and aperture value show in white on the LCD monitor.
- If the shutter speed is shown in red on the LCD monitor, the image is underexposed (insufficient light) or overexposed (too much light). Adjust the aperture value using the main dial until the shutter speed display turns to white.
If you set [Safety Shift] to [On] in the Rec. menu, the aperture value will shift to the correct value automatically (Safety Shift function (p. 86)).
- You can change the automatically selected combinations of shutter speeds and aperture values without altering the exposure (p. 106).

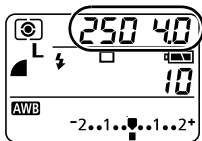



- Depending on the zoom position, certain aperture values may not be available.



- See page 206 for settings that can be changed in this mode.
- Please note that camera shake becomes a factor at slow shutter speeds. If the camera shake warning  appears on the LCD monitor, secure the camera to a tripod before shooting.
- In this mode, the shutter speed with synchronized flash is 1/60 second to 1/250 second. The aperture value setting may therefore be changed automatically to match the synchronized flash speed even if its value was set previously.

Aperture Setting Display

The larger the aperture value, the smaller the lens aperture.

F2.0	F2.2	F2.5	F2.8	F3.0	F3.2	F3.5
F4.0	F4.5	F5.0	F5.6	F6.3	F7.1	F8.0

The display of aperture settings differs between the display panel and LCD monitor.

Aperture Value	F2.5	...	F8.0
Display Panel	<i>2.5</i>	...	<i>8.0</i>
LCD Monitor	F2.5	...	F8.0

Safety Shift

If you set [Safety Shift] to [On] in the Rec. menu when the shooting mode is **Tv** or **Av**, the camera automatically changes the shutter speed or aperture value to obtain the correct exposure if necessary.

- The safety shift function does not work when the flash fires.

M Manually Setting the Shutter Speed and Aperture

You can manually set the shutter speed and aperture to achieve a particular effect. This is convenient for shooting fireworks and other images where it is difficult to set the correct exposure automatically.

1

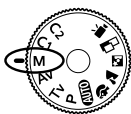

Turn the mode dial to M.

- The shutter speed and aperture value will show on the display panel. They will also be displayed on the LCD Monitor if the monitor is on.

2

Click the main dial and select a setting content (shutter speed or aperture value).

- Clicking the main dial switches between the shutter speed and the aperture value setting.

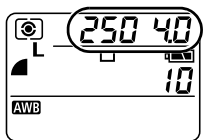

3

Turn the main dial and select a shutter speed or an aperture value.

4

Shoot the image.

- When you press the shutter button halfway, the exposure compensation bar appears on the display panel and a number on the LCD monitor indicates the difference between standard exposure* and the selected exposure. If the difference is more than 2 stops, the LCD monitor shows a red “-2” or “+2”.



* Standard exposure levels are calculated by measuring light according to the currently selected metering method.

Displays in red



M Manually Setting the Shutter Speed and Aperture (continued)



- See page 206 for settings that can be changed in this mode.
- For the correlation between aperture value and shutter speed, see page 83, 84.
- If you wish to change the exposure, adjust the shutter speed or the aperture using the main dial.
- The brightness of the LCD monitor matches the selected shutter speed and aperture value. If the flash is set to  (Flash on, with red-eye reduction) or  (Flash on), or you have attached an external flash, the LCD Monitor will always appear bright.

Selecting an AF Frame

The AF frame indicates the area of the composition on which the camera focuses. You can set the AF frame in the following way.

- Selecting AiAF (auto selection) or a center-point AF frame (see below).
- Selecting a desired position for the AF frame (p. 90).

Mode Dial







You can set the AF mode selection to Auto Selection (AiAF) or to center-point. When Auto Selection (AiAF) is selected, the camera automatically selects an AF frame from 9 points to focus according to the shooting conditions. With the digital zoom, the center-point AF-frame is always selected.

1 Press the button.

- The AF mode selection will appear in the Display Panel. If the LCD Monitor is on, the AF frame will be displayed in green.

2 Select the auto selection or center-point AF frame using the main dial.

- You can select either AiAF (auto selection) or center-point AF using  when the camera is in , , , or  modes.



e.g. Auto Selection





e.g. Center-point

3 Press the button.

- You can immediately shoot the image using the selected AF frame by pressing the shutter button instead of pressing the  button.

4 Press the button.

- You can immediately shoot the image using the selected AF frame by pressing the shutter button instead of pressing the  button.
- The AF frame will move back to its original position (Center) if you hold down the  button.





- The AF frame can also be moved in the macro mode.
- The AF frame can be set in both the macro mode and the standard mode.
- The AF frame cannot be moved in the super macro mode and while manual focus is being used (p. 115).
- When Spot AE Point is selected as the light metering mode, you can use the selected AF frame as the Spot AE Point (p. 92).
- For an explanation of the AF frame colors, please refer to page 43.

Switching between Light Metering Modes

Mode Dial

P Tv Av M

Evaluative Metering is the default light metering mode. This can be switched to another metering mode.

	Evaluative Light Metering	The camera divides images into several zones for light metering. The camera evaluates the complex lighting conditions, such as the position of the subject, the brightness, the background, the direct light, and the backlighting, and adjusts the settings to the correct exposure for the main subject. This mode is particularly well-suited for backlit conditions and general photography.
	Center-Weighted Averaging	Averages the exposure from the entire image, but places more weight on the subject at the center.
	Spot AE Point	Meters the area within the spot AE point frame.
	Center	Locks the spot metering frame to the center of the LCD monitor.
	AF Point*	Moves the spot AE point to the same position as the selected AF frame.

* When the AF frame is set to Auto Selection (p. 89), it will be fixed to the center.

1 Press the **DISPLAY** button to turn the LCD monitor on.

2 Press the button to select the metering mode.



- Each press of the  button changes the metering mode as follows.

 (Evaluative Metering) →  (Center-Weighted Averaging)

↑  (Spot AE Point) ←

- The icon of the currently selected light metering mode appears on the display panel. It will also be displayed on the LCD Monitor if the monitor is on.

If you have selected  (Spot AE Point), go to step 3.

If you have selected  (Evaluative Metering) or  (Center-Weighted Averaging), shoot the image.



3 In the [(Rec.)] menu, select [Spot AE Point].

- See *Selecting Menus and Settings* (p. 46).

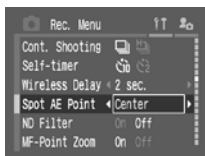

4 Select the [Center] or [AF Point] option, then press the MENU button.

- When [Spot AE Point] is set to [Center], the spot AE point frame appears at the center of the LCD monitor. When [Spot AE Point] is set to [AF Point], it appears inside the AF frame.

Spot AE Point Frame



e.g. Center

Adjusting the Exposure

Mode Dial



Adjust the exposure compensation setting to avoid making the subject too dark when it is backlit or shot against a bright background or to avoid making lights appear too bright in night shots.

1 Press (▲ on the omni selector).

- The exposure compensation bar appears on the display panel. It will also be displayed on the LCD Monitor if the monitor is on.

2 Select a setting using the main dial or the ◀ or ▶ arrow on the omni selector.

- The settings can be adjusted in 1/3 stops in the range of -2 stops to +2 stops.
- You can shoot the image right after selecting settings by pressing the shutter button. The menu displays again after the shot, allowing you to change the settings easily.

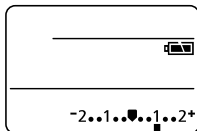

3 Press or click the main dial.

- To cancel the exposure compensation, return the setting to 0.

WB Adjusting the Tone (White Balance)

Mode Dial



When the white balance mode is set to match the light source, the camera reproduces colors more accurately.

AWB (AWB)	Auto	Settings are automatically set by the camera
	Daylight	For recording outdoors on a bright day
	Cloudy	For recording under overcast, shady or twilight skies
	Tungsten	For recording under tungsten and bulb-type 3-wavelength fluorescent lighting
	Fluorescent	For recording under warm-white, cool-white or warm-white (3-wavelength) fluorescent lighting
	Fluorescent H	For recording under daylight fluorescent, or daylight fluorescent-type 3-wavelength fluorescent lighting
	Flash	For flash photography
	Custom1	For setting a custom value with a white sheet of paper, etc., to obtain the optimal white balance for the conditions. There are two custom values: custom1 and custom2.
	Custom2	

The icons in parentheses are the ones on the display panel. (Shown only when there is a difference between the display panel icon and LCD monitor.)

1 Press WB (▼ on the omni selector).

- The current white balance mode will appear on the display panel and the white balance setting menu will appear on the LCD monitor if it is on.

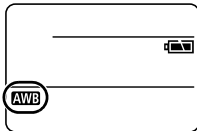

2 Select the desired setting using the main dial or the ◀ or ▶ arrow on the omni selector.

- Please see below regarding the  custom setting.
- You can shoot the image right after selecting settings by pressing the shutter button. The menu displays again after the shot, allowing you to change the settings easily.





3 Press WB or click the main dial.



- The white balance cannot be adjusted when the photo effect is set to  (Sepia) or  (B/W).

Setting a Custom White Balance

Shoot after reading the white balance data in  (Custom1) or  (Custom2) in the following cases since the white balance may not be correctly adjusted in **AWB** (Auto):

- Shooting close-ups
- Shooting subjects of monotone color (such as sky, sea or forest)
- Shooting with a peculiar source of light (such as a mercury-vapor lamp)

1 Press WB (▼ on the omni selector).

- The current white balance mode will appear on the display panel and the white balance setting menu will appear on the LCD monitor if it is on.

2 Select (Custom1) or (Custom2) using the main dial or the ◀ or ▶ arrow on the omni selector.







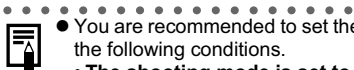

3 Aim the camera at the white paper or cloth, or gray card and press the SET button.

- Aim the camera so that the white paper or cloth, or gray card, completely fills the frame on the LCD monitor or the entire viewfinder before pressing the **SET** button. When you press the **SET** button, the camera reads the white balance data.
- You can shoot the image right after selecting settings by pressing the shutter button. The menu displays again after the shot, allowing you to change the settings easily.

4 Press WB or click the main dial.



- You are recommended to set the white balance when shooting in the following conditions.
 - **The shooting mode is set to P and the exposure compensation and flash exposure adjustment are set to ± 0 .**
The correct white balance may not be obtained when the exposure is incorrect (image is completely black or white).
 - **Use the LCD Monitor, and zoom in to the maximum telephoto setting.**
Set the digital zoom to [Off].
 - **A mode other than  is selected.**
In  mode, white balance data cannot be read.
 - **The ISO speed is set to the same setting to shoot the image.**
 - **The flash is set to  (Flash On) or  (Flash Off).**
Use the same flash setting as the one that will be used for shooting when you set the white balance. If the white balance setting conditions and shooting conditions are not the same, the correct white balance may not be obtained.
When the flash is set to   (Auto with red-eye reduction) or  (Auto), the flash may fire while the white balance data is recorded to the custom white balance. If this happens, make sure the flash also fires when you shoot the image.
- The custom white balance will not be canceled even if you reset camera settings to default (p. 54).

Changing the ISO Speed

Mode Dial

P Tv Av M

By raising the ISO speed, you can shoot bright images even in poor lighting conditions. This function is convenient when you want to prevent camera shake, shoot without the flash or shoot with a faster shutter speed in dark conditions.

1 Press the **DISPLAY** button to turn the LCD monitor on.

2 Press the **FUNC.** button and select **ISO*** (LCD monitor) or **50*** (Display Panel) using the **▲** or **▼** arrow on the omni selector.

* The current setting is displayed.

- The ISO speed setting menu appears on the LCD monitor.



3 Select the desired setting using the main dial or the **◀** or **▶** arrow on the omni selector.

- You can shoot the image right after selecting settings by pressing the shutter button. The menu displays again after the shot, allowing you to change the settings easily.



4 Press the **FUNC.** button or click the main dial.

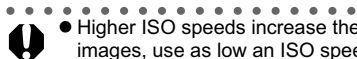















- Higher ISO speeds increase the image noise. To take clean images, use as low an ISO speed as possible.
- The AUTO setting selects the optimal ISO speed. It will automatically raise the speed when the light from the flash is insufficient to illuminate the subject matter.

Changing the Photo Effect

Mode Dial

    P Tv Av M

You can shoot with different saturation and contrast effects.

 ()	Photo Effect Off	Records normally with this setting
 ()	Vivid	Emphasizes the contrast and color saturation to record in bold color.
 ()	Neutral	Tones down the contrast and color saturation to record neutral hues.
 ()	Low Sharpening	Records subjects with softened outlines.
 ()	Sepia	Records in sepia tones.
 ()	B/W	Records in black and white.
 ()	Custom Effect	You can freely set the contrast, sharpness and color saturation.

The icons in parentheses are the ones on the display panel.

1 Press the DISPLAY button to turn the LCD monitor on.

- Photo Effect settings can be changed even if the LCD monitor is off. However, the Custom Effect settings cannot be changed.

2 Press the FUNC. button and select * (LCD monitor) or OFF* (Display Panel) using the ▲ or ▼ arrow on the omni selector.

* The current setting is displayed.

- The Photo Effect setting menu appears on the LCD monitor.

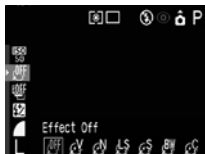

3 Select the desired setting using the main dial or the ◀ or ▶ arrow on the omni selector.

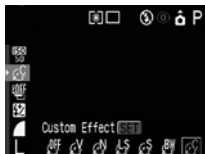

When is selected

A screen allowing you to set the contrast, sharpness and color saturation appears when you press the **SET** button.

In this screen, select the item you wish to set using the ▲ or ▼ arrow on the omni selector and set it using the ◀ or ▶ arrow on the omni selector, then press the **SET** button.

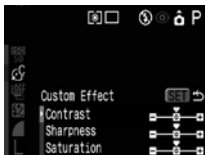

Contrast

- This function allows you to adjust the degree of brightness.
- Select from – (Weak), 0 (Neutral) and + (Strong).

Sharpness

- This function allows you to adjust how sharply outlines are defined.
- Select from – (Weak), 0 (Neutral) and + (Strong).



Saturation

- This function allows you to adjust the color depth.
- Select from – (Low), 0 (Neutral) and + (High).

You can shoot the image right after selecting settings by pressing the shutter button. The menu displays again after the shot, allowing you to change the settings easily.

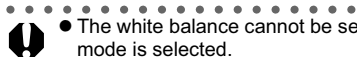
4 Press the FUNC. button or click the main dial.



- The white balance cannot be set when  (Sepia) or  (B/W) mode is selected.

Auto Exposure Bracketing (AEB Mode)

Mode Dial

P Tv Av

In this mode, the camera automatically changes the exposure within a set range to take three shots after you press the shutter button once. You can adjust AEB settings in 1/3EV steps within the range of -2 stops to +2 stops of the standard exposure setting. AEB settings can be combined with exposure compensation settings (p. 94) to extend the adjustment range.

The images are shot in the following order: Standard exposure, underexposure and overexposure.



1 Press the DISPLAY button to turn the LCD monitor on.

- You can also use the Display Panel icons to activate AEB mode, although you cannot adjust the AEB settings without using the LCD Monitor.

2 Press the FUNC. button and select * (LCD monitor) or * (Display Panel) using the ▲ or ▼ arrow on the omni selector.

- * The current setting is displayed.
- The Bracket setting menu appears on the LCD monitor.



- 3** Select  (LCD monitor) or  (Display Panel) using the main dial or the ◀ or ▶ arrow on the omni selector, then press the **SET** button.

- The compensation range cannot be adjusted when the LCD monitor is off, even if you press the **SET** button. AEB operations are carried out with the currently selected compensation range. Press the **FUNC.** button to end the operation.





- 4** Expand or contract the range using the main dial or the ◀ or ▶ arrow on the omni selector.

- Use ▶ to expand the range and ◀ to contract it.
- The camera returns to the Step 3 screen if you press the **SET** button.
- You can shoot the image right after selecting settings by pressing the shutter button. The menu displays again after the shot, allowing you to change the settings easily.



- 5** Press the **FUNC.** button or click the main dial.

- Select  or  in Step 3 to cancel AEB mode.



- The AEB mode is not available when shooting with the flash on. The camera will revert to shooting only one image when the flash is on.

Focus Bracketing (Focus-BKT Mode)

Mode Dial

P Tv Av M

You can shoot three images while the focus changes automatically when shooting with the manual focus (p. 115). Three ranges -small, medium or large- can be selected. Images are shot with the focus position changing in the following order: selected position, further away and closer.

1 Press the **DISPLAY** button to turn the LCD monitor on.

- You can also activate Focus-BKT mode without using the monitor, but you cannot adjust the bracketing range.

2 Press the **FUNC.** button and select **OFF*** (LCD monitor) or **BKT OFF*** (Display Panel) using the **▲** or **▼** arrow on the omni selector.

* The current setting is displayed.

- The Bracket setting menu appears on the LCD monitor.



3 Select **OFF*** (LCD monitor) or **BKT FC-b** (Display Panel) using the main dial or the **◀** or **▶** arrow on the omni selector, then press the **SET** button.

- The range cannot be adjusted when the LCD monitor is off, even if you press the **SET** button. Focus Bracketing operations are carried out with the currently selected range. Press the **FUNC.** button to end the operation.



4 Expand or contract the range using the main dial or the ◀ or ▶ arrow on the omni selector.

- Use ▶ to expand the range and ◀ to contract it.
- The camera returns to the Step 3 screen if you press the **SET** button.
- You can shoot the image right after selecting settings by pressing the shutter button. The menu displays again after the shot, allowing you to change the settings easily.



5 Press the FUNC. button or click the main dial.

- Select **OFF** or **BKT OFF** in Step 3 to cancel Focus-BKT mode.

6 Shoot the image in manual focus (p. 115).

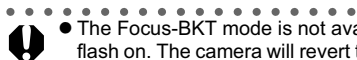

- The Focus-BKT mode is not available when shooting with the flash on. The camera will revert to shooting only one image when the flash is on.

✳ Locking the Exposure Setting (AE Lock)

Mode Dial

P Tv Av

You can set the exposure and focus separately. This is effective when the contrast is too strong between the subject and background or when a subject is backlit.

1 Press the DISPLAY button to turn the LCD monitor on.

2 Focus the AF frame or the spot metering frame on the subject on which you wish to lock the exposure setting and press the shutter button halfway.

- *Selecting an AF Frame* (p. 89)
- *Switching between Light Metering Modes* (p. 92)

3 While pressing the shutter button halfway, press the ✳ button.

- The exposure setting locks (AE lock) and the ✳ icon appears on the LCD monitor.
- Using any button or lever other than the main dial and backlight button cancels the AE lock.



AE Lock Icon

4 Recompose the image and shoot.

- The AF frame focuses on the subject.

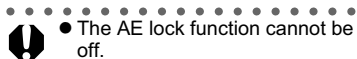

- The AE lock function cannot be used when the LCD monitor is off.



- The automatically selected combinations of shutter speeds and aperture values can be freely changed without altering the exposure with the following procedure.
 1. Turn the mode dial to **P**, **Tv** or **Av**.
 2. Press the **DISPLAY** button to turn the LCD monitor on.
 3. Focus on the subject on which you wish to lock the exposure.
 - Press the shutter button halfway.
 - In **Tv** and **Av** modes, the Safety Shift function works if [Safety Shift] is set to [On] (p. 86).
 4. Press the ***** button.
 - The exposure setting will lock and the ***** icon will appear on the LCD monitor.
 5. Turn the main dial until the desired shutter speed or aperture value is reached.
 6. Recompose the image and shoot.
 - The setting will cancel after the shot is taken.

✳ Locking the Flash Exposure Setting (FE Lock)

Mode Dial

P Tv Av

You can obtain the correct exposure with flash photography regardless of the location of your subject in the composition.

- 1 Press the DISPLAY button to turn the LCD monitor on.**
- 2 Press the  (Flash) button and set the flash to fire (p. 64).**
 - If you are using an externally mounted flash, please refer to its manual for setting instructions.
- 3 Focus the AF frame or the spot metering frame on the subject on which you wish to lock the flash exposure setting and press the shutter button halfway.**
- 4 While pressing the shutter button halfway, press the ✳ button.**
 - The exposure setting locks (FE lock) and the ✳ icon appears on the LCD monitor.
 - The flash will fire a pre-flash and lock the flash exposure to the required intensity to illuminate the subject.
 - Each time you press the ✳ button, the flash exposure fires a pre-flash and locks at the required intensity for that composition.
 - Using any button or lever other than the main dial cancels the FE lock.
- 5 Recompose the image and shoot.**



* Locking the Flash Exposure Setting (FE Lock) (continued)



- The FE lock only functions with the built-in flash, an externally mounted EX series Speedlite, a Macro Ring Lite or a Macro Twin Lite.
- The FE lock function is not available when [Flash Adjust] is set to [Manual].

Switching between Flash Adjustment Settings

Mode Dial

Tv Av

The built-in flash and the externally mounted flash* fire with automatic flash adjustments (except in the **M** mode), but it is possible to set them so that they fire without any adjustments.

* Speedlite 220EX/420EX/550EX/580EX, Macro Ring Lite MR-14EX, Macro Twin Lite MT-24EX

- 1 Select [Flash Adjust] from the [ (Rec.)] menu.**
 - See *Selecting Menus and Settings* (p. 46).

- 2 Select [Auto] or [Manual] and press the MENU button.**

Compensating the Flash Adjustment/Flash Output

Mode Dial

    **P Tv Av M**

Flash Adjust	<ul style="list-style-type: none">● When [Flash Adjust] is set to [Auto], settings can be adjusted in 1/3-stop increments in the range of -2 stops to +2 stops.● You can combine flash exposure compensation with the camera's exposure compensation function for ambient light to achieve creative effects.
Flash Output	<ul style="list-style-type: none">● In M mode or when [Flash Adjust] is set to [Manual], the flash output can be controlled in three steps, starting from FULL, when shooting. This setting is also effective for slave flash photography where multiple flashes are fired at the subject from different positions because the pre-flash does not fire. When an externally mounted flash is attached, its flash output can be controlled (Up to 1/16 from Full, in 1/3 steps).

1 Press the DISPLAY button to turn the LCD monitor on.

2 Press the FUNC. button, then select  using the ▲ or ▼ arrow on the omni selector.

3 Adjust the compensation using the main dial or the ◀ or ▶ arrow on the omni selector.

- You can shoot the image right after selecting settings by pressing the shutter button. The menu displays again after the shot, allowing you to change the settings easily.



e.g. [Flash Adjust] set to [Auto]

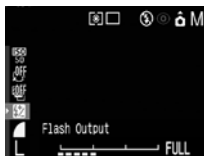

e.g. M mode or [Flash Adjust] set to [Manual]

4 Press the FUNC. button or click the main dial.

- To cancel the compensation, return the setting to .

Switching the Timing at which the Flash Fires

Mode Dial

P Tv Av M

1st-curtain	The flash fires right after the shutter opens, regardless of the shutter speed. Usually, the 1st-curtain is used when shooting.
2nd-curtain	The flash fires right before the shutter closes, regardless of the shutter speed. Compared with the 1st-curtain, the flash fires later and this allows you to shoot images in which, for example, a car's taillights seem to trail off behind.



Image shot with the
1st-curtain setting



Image shot with the
2nd-curtain setting

-
- 1** From the [(Rec.)] menu, select [1st-curtain] or [2nd-curtain] in [Flash Sync].

Shooting Images at Set Intervals (Intervalometer)

Mode Dial

P Tv Av M

You can shoot images at a set interval. This function can be used for fixed-point observation of plants and blooming flowers. The shooting interval time can be set from 1 to 60 minutes and 2 to 100 images can be shot.



- Since the camera may shoot continuously for an extended period of time, the use of the separately sold Compact Power Adapter CA-560 is recommended (p. 189).

1 Select [Intervalometer] from the [Rec.] menu.

- See *Selecting Menus and Settings* (p. 46).

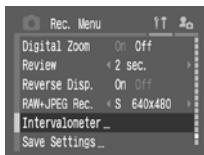

2 Select an interval time using the ◀ or ▶ arrow on the omni selector.

- If you press the ◀ or ▶ arrow on the omni selector continuously, the interval time increases in units of 5 minutes at a time.

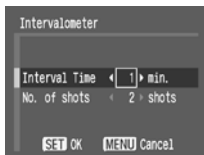

3 Press the ▼ arrow on the omni selector, then select the number of shots using the ◀ or ▶ arrow on the omni selector.

- If you press the ◀ or ▶ arrow on the omni selector continuously, the number of shots increases in units of 5 shots at a time.
- The maximum number of shots* is determined according to the CF card's remaining capacity.

* In some cases, the actual maximum number of shots may be fewer than the displayed number.



4 Press the SET button

- *Int.* appears on the LCD monitor and *Int* appears on the display panel.

5 Press the shutter button.

- The first image is shot and the interval shooting session starts.
- Once the set number of shots is taken, the camera automatically powers down regardless of the power saving function settings.
- If the below operations are accessed while the interval shooting is in process, the interval shooting session will be canceled.
 - Turning the mode dial or pressing the shutter button halfway while the camera is waiting to shoot the next image
 - Opening the CF card slot cover or battery cover
 - Switching to Playback mode
 - Turning off the power



- Once the interval shooting session is started, all operation buttons become inactive.
- The lens stays extended until the next image is shot.
- Images are not displayed on the LCD monitor right after being shot.
- Interval shooting is not available when the date and time are not set.
- Continuous Shooting, AEB mode and Focus-BKT mode are not available. The self-timer can only be used for the first shot in the series.

Shooting Problem Subjects for the Autofocus

The autofocus may not work well on the following types of subjects.

- Subjects with extremely low contrast to the surroundings
- Subjects mixing close and far objects
- Subjects with extremely bright objects at the center of the composition
- Subjects that are moving quickly
- When shooting through glass, get as close as possible to avoid reflection off the glass.
- Subjects with horizontal stripes

To shoot these subjects, first aim the camera at an object at a similar distance, lock the focus (focus lock) or autofocus (AF lock) and recompose the image with the desired subject. You can also use manual focus.

Shooting with Focus Lock

Mode Dial

AUTO      **P** **Tv** **Av** **M**

- 1 Aim the AF frame at an object at a similar distance to the subject you wish to shoot.**
- 2 Press the shutter button halfway to lock the focus.**
 - The AE setting will also lock when you do this. The exposure may occasionally be incorrect if the difference between the two items is too great. Use the AF lock function or the AE lock procedure (p. 105) when this happens.
- 3 Keep it pressed while you recompose the image and press the shutter button all the way to shoot the image.**

Shooting with AF Lock

Mode Dial



- 1** Press the DISPLAY button to turn the LCD monitor on.
- 2** Aim the AF frame at an object at a similar distance to the subject you wish to shoot.
- 3** Press the shutter button halfway to lock the focus. Keep it pressed and press the MF button.
 - The MF icon appears on the LCD monitor.
 - The focus setting will lock even if the shutter button and the MF button are released.
 - The AF lock will cancel if the MF button is pressed again.
- 4** Recompose the image and press the shutter button all the way to shoot the image.



- The AF lock function is convenient because you can let go of the shutter button to recompose the image. Moreover, the focus remains locked after the picture is taken, allowing you to capture a second image with the same focus.

Shooting in Manual Focus Mode

Mode Dial



The focus can be manually set.

- 1** Press the DISPLAY button to turn the LCD monitor on.

2 Press the MF button.



- The  MF icon and the MF indicator will appear on the LCD monitor.



MF indicator

3 Turn the main dial to focus.

- When the [ (Rec.)] menu's [MF-Point Zoom] is set to [On], if a particular AF frame has been manually selected, the portion of the image in that frame will appear magnified.*

* Except in the  and  modes, when the digital zoom is activated or a TV is used as the display.

* Can also be set so that the image displayed is not magnified (p. 49).

- The MF indicator shows approximate figures. Use them as a shooting guideline only.
- Adjust the focus by turning the main dial until the image appears focused on the LCD monitor.
- In **Tv**, **Av** or **M** mode, you can switch between the manual focus, aperture value and shutter speed selection by clicking the main dial. A green  appears at the left of selectable items.
- Pressing the MF button a second time cancels the manual focus mode.

Using the Manual Focus in Combination with the Auto Focus

Mode Dial



The camera automatically searches for a more suitable focusing point from the current manually focused location.

1 Focus the camera with the manual focus, then press the SET button.

- The camera focuses automatically to a more accurate focusing point near the current focusing point.



- You cannot change the AF frame setting while focusing manually. Cancel the manual focus mode, then change the AF frame setting.



- You can use manual focus in the macro focal distance (p. 74). In this case, the fine scale is adopted.
- You can change the MF indicator displayed distance units (p. 52).

Switching between Focus Settings

Mode Dial

AUTO    P Tv Av M

You can switch between focus settings to shoot.

Continuous	The camera is continually focusing on whatever it is aimed even when the shutter button is not pressed, allowing you to shoot without missing opportunities. This is the default setting.
Single	The camera only focuses when the shutter button is pressed halfway, conserving battery power.

1 In the [] (Rec.) menu, select [AF Mode].

- See *Selecting Menus and Settings* (p. 46).

2 Select [Continuous] or [Single] and press the MENU button.

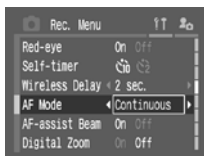

- When the LCD monitor is off, the setting locks in the Single mode.

C1 C2 Saving Custom Settings

You can save frequently used shooting modes and various shooting settings to the **C** (custom) mode. This camera is equipped with two modes ([**C1**] and [**C2**]), allowing you to save two types of custom settings. When necessary, you can then shoot images with previously saved settings by simply turning the mode dial to **C1** or **C2**. Settings that are usually forgotten when the shooting mode is changed or when the power is turned off (such as Macro mode or Drive mode) are also remembered.

1 Turn the mode dial to **P**, **Tv**, **Av**, **M**, **C1** or **C2**.

- When you wish to re-save partially modified settings (except shooting mode) that were previously saved in the **C1** or **C2** mode, select **C1** or **C2**.

2 Set the setting contents you wish to save.

Settings that can be saved to the mode

- Shooting mode (**P**, **Tv**, **Av**, **M**)
- Items that can be set in **P**, **Tv**, **Av** and **M** modes
- Shooting menu settings
- Zoom location
- Manual focus location

3 Select [**Save settings**] from the [**Rec.**] menu.

- See *Selecting Menus and Settings* (p. 46).

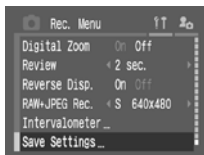

4 Select [**C1**] or [**C2**] and press the SET button.

- Selects a save destination (**C1** or **C2**).

5 Press the MENU button.



- The setting contents do not influence other shooting modes.
- Saved settings can be reset (p. 54).

Using the ND Filter

Mode Dial

 P Tv Av M

The brightness can be decreased by setting the ND filter on. This allows you to select a smaller aperture value and a slower shutter speed than usual.

1 Press the **DISPLAY** button to turn the LCD monitor on.

2 Select **[ND Filter]** in the **[ (Rec.)]** menu.

- See *Selecting Menus and Settings* (p. 46).

3 Select **[On]** and press the **MENU** button.

- **ND** appears on the LCD monitor.

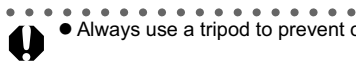

- Always use a tripod to prevent camera shake in this mode.



- Standard brightness is decreased to approximately 1/8 when the ND filter is on. For example, if the appropriate aperture value is 8, it becomes 2.8 when the ND filter is on.

Setting the Auto Rotate Function

Mode Dial

AUTO     P Tv Av M

This camera is equipped with an Intelligent Orientation sensor that detects the orientation of an image shot with the camera held vertically and automatically rotates it to the correct viewing orientation in the display. You can set this function on/off.

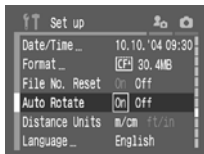

1 Select [Auto Rotate] in the [M] (Set up) menu.

- See *Selecting Menus and Settings* (p. 46).



2 Select [On] and press the MENU button.

- When this function is On, an icon showing the orientation of the camera appears at the upper right corner of the LCD monitor (when information display is on).

	Normal
	Camera on right end
	Camera on left end



- This function may not operate correctly when the camera is pointed straight up or down. Check that the correct camera orientation icon (e.g. ) is displayed and if it is not, then set the Auto Rotate function to Off.
- Even if the Auto Rotate function is set to On, the orientation of images downloaded to a computer will depend upon software used to download the images.



- When the camera is held vertically to shoot, the Intelligent Orientation sensor judges the upper end to be “up” and the lower end to be “down”. It then regulates the optimal white balance and exposure for vertical photography. This function operates regardless of the On/Off status of the Auto Rotate function.

Resetting the File Numbers

File numbers are automatically assigned to your images. You can select the way file numbers are assigned.

On	The file numbers are reset to the start (100-0001) each time a new CF card is inserted. New images recorded on CF cards with existing files are assigned the next available number.
Off	The file number of the last image to be shot is memorized so that images recorded to a new CF card start from the next number.

1 In the [M] (Set up) menu, select [File No. Reset].

- See *Selecting Menus and Settings* (p. 46).

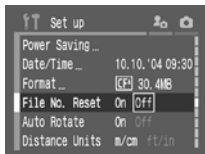

2 Select [On] or [Off] and press the MENU button.

- Setting the [File No. Reset] to [Off] is useful for avoiding file name duplication when images are downloaded to a computer.



About File and Folder Numbers

Images are assigned file numbers from 0001 to 9900, and folders are assigned folder numbers from 100 to 198 (folder numbers cannot contain 99 in the last two digits).

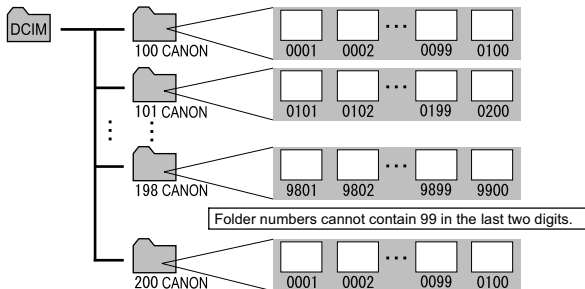

Folder File Capacity

Each folder usually contains up to 100 images.

However, since images shot in Continuous mode or Stitch Assist mode are always saved into the same folder, a folder may contain more than 100 images. The number of images may also exceed 100 if a folder contains images copied from a computer or images shot with other cameras. Please note, however, that the images in folders containing 2001 or more images cannot be replayed in this camera.

Displaying Images Individually

You can view the recorded images on the LCD monitor.

1

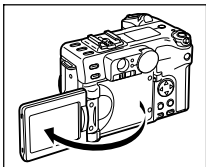

Open the LCD monitor.

- The LCD monitor can be freely opened to any position (p. 33).

2

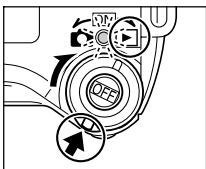





Turn the mode lever to .

- The last recorded image appears (single image playback).
-  appears on the display panel.

3

Move between images turning the main dial or using the or arrow on the omni selector.

- Use  to move to the previous image and  to move to the next. Holding  or  moves more rapidly between images, but the images will not appear as clearly.
- Turn the main dial to the left to move to the previous image and to the right to move to the next.
- You can also switch images by pressing the **JUMP** button (p. 127).
- Press the **DISPLAY** button to show the data for the displayed image (p. 36).
- Press the  button to quickly delete the displayed image (p. 140).



- You may not be able to play back images that have been shot with another camera or edited on a computer or with other software applications.

🔍 Magnifying Images

Images can be magnified up to approximately 10 times while in single image playback.

1 Press the zoom lever toward 🔍.

- Press the ◀, ▶, ▲ or ▼ arrow on the omni selector to move the magnified area around the image.
- You can also magnify images by pressing the zoom lever toward 🔍 while holding the **SET** button. Each press of the 🔍 button magnifies the image approx. 2.5 times, approx. 5 times and 10 times in order. Also, the magnified image can be reduced to approx. 5 times, 2.5 times and normal size in order by pressing the 🔍 button repeatedly while holding the **SET** button.
- Movie frames and index playback images cannot be magnified.
- You can magnify an image while it is displayed on the LCD monitor in Shooting mode immediately after the image is shot (p. 57).
- You can use the main dial to select another image even when the current image is magnified.
- Press 🗄 or the **MENU** button to immediately cancel the magnification.



Approximate position

Viewing Nine Images at a Time (Index Playback)

Up to nine images can be viewed at once in index playback.

1 While in single image playback, press the button.

- Nine images appear at once (index playback).
- The same display appears even if you press the zoom lever once toward .



Movie
Frame

Selected
Image

2 Change the image selection by turning the main dial or using the ▲, ▼, ◀ or ▶ arrow on the omni selector.



← Pressing the ▲ arrow in this row displays the previous set of nine images.

← Pressing the ▼ arrow in this row displays the next set of nine images.

3 Press the button.

- Index playback cancels and the display reverts to single image playback.
- You can cancel index playback by pressing the zoom lever toward .
- Press the **DISPLAY** button to show the data for the displayed image (p. 36).

JUMP Jumping Between Images

The display can be advanced or set back 9 images in either single image playback or index playback.

1 Press the JUMP button while in single image playback (p. 124) or index playback (p. 126).

- The jump bar appears.

2 Change the image selection by turning the main dial or using the ◀ or ▶ arrow on the omni selector.

Single Image Playback

- The 10th image ahead or behind is displayed.
- Display the first or last image by pressing the ◀ or ▶ arrow on the omni selector while holding the SET button.

Index Playback

- The previous or next 9 images are displayed.
- Display the first or last 9 images by pressing the ◀ or ▶ arrow on the omni selector while holding the SET button.

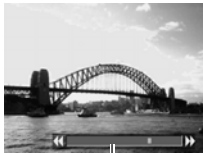

Jump Bar



Jump Bar

3 Press the JUMP button.

- The jump bar disappears and the jump mode cancels.

Viewing Movies

You can play back movies shot in  mode.

1 Turn the mode lever to .

- Movies cannot be viewed in index playback.

2 Select a movie by turning the main dial or using the or arrow on the omni selector.

- A movie displays with the instruction  on it.



3 Press the SET button.

- The movie playback panel appears.







4 Select (Play) using the or arrow on the omni selector and press the SET button.

- The movie images and sound will play.



Volume
Movie playback panel

Movie Playback Panel

	(Exit):	Returns to the screen in Step 1
	(Play):	Plays back the movie images and sounds
	(First Frame):	Shows the first frame
	(Previous Frame):	Rewinds if the SET button is held down
	(Next Frame)	Fast forwards if the SET button is held down
	(Last Frame):	Shows the last frame
	(Edit):	Edits the movie (p. 130)

Playback Operations

: Adjusts the volume during playback

SET: Pauses playback. Press again to resume playback.

When Playback Ends

The last frame remains displayed when playback ends.

SET: Displays the movie playback panel. Press again to play back the movie again from the first frame.

- You may experience frame dropping and audio breakup when playing back a movie on a computer with insufficient system resources.
- The volume at which movies play back can also be adjusted in the Set up menu.
- Please adjust the audio sound level on the TV when viewing movie files on a TV.



- You may not be able to play back or edit movies that have been shot with another camera.

Editing Movies

You can delete unwanted portions from the first or second half of a movie clip.

1 Select the movie you wish to edit and press the **SET** button.

- See *Viewing Movies* (p. 128).

2 Select **[Edit]** using the **◀** or **▶** arrow on the omni selector and press the **SET** button.

- The movie editing panel and the movie editing bar appear.



3 Select an editing method using the **▲** or **▼** arrow on the omni selector.

- [Cut beginning]** : Deletes frames in the first half of the movie
- [Cut end]** : Deletes frames in the second half of the movie
- [Exit]** : Reverts to the movie playback panel



Movie
Editing
Panel

Movie
Editing
Bar

4 Select the range you wish to delete using the **◀** or **▶** arrow on the omni selector.



Editing position

5 Select **[Play]** using the **▲** or **▼** arrow on the omni selector and press the **SET** button.

- The temporarily edited movie will start playing.
- The movie will stop if you press the **SET** button while it is playing.

6 Select (Save) using the ▲ or ▼ arrow on the omni selector and press the SET button.

- When  is selected, the edited movie is not saved and the camera reverts to the movie editing panel.



7 Select [Overwrite] or [New File] using the ◀ or ▶ arrow on the omni selector and press the SET button.

- [Overwrite]: Saves the edited movie under the same file name as the original movie. The original data is deleted.
- [New File]: Saves the edited movie under a new file name. The original data is not deleted.
- When there is not enough space left on the CF card, only the overwrite function is available.



- Protected movies cannot be edited.



- It may take approximately 3 minutes to save an edited movie. If the battery pack runs out of charge partway through, edited movie clips cannot be saved. When editing movies, use a fully charged battery pack or separately sold Compact Power Adapter CA-560 (p. 189).

- Movies with an original length of 1 second or more can be edited in 1-frame units.



Rotating Images in the Display

Images can be rotated 90° and 270° clockwise on the LCD monitor.

Original



90°



270°



1 Select [Rotate] from the [Play] menu.

- See *Selecting Menus and Settings* (p. 46).

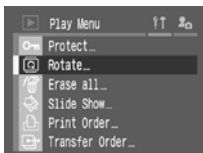

2 Select an image you want to rotate by turning the main dial or by using the ◀ or ▶ arrow on the omni selector and press the SET button.

- The image cycles to the next orientation (90° → 270° → original) each time the **SET** button is pressed.



3 Press the MENU button.

- The Play menu appears again. Press the **MENU** button again to close the menu.



- Movie images cannot be rotated.
- When images are downloaded to a computer, the orientation of images rotated by the camera will depend upon the software used to download the images.



- Images can be magnified when rotated (p. 125).
- Images taken vertically with the auto rotate function (p. 121) set to [On] will automatically be rotated to the vertical position when viewed on the LCD monitor.

Attaching Sound Memos to Images

In playback mode (including single image playback, index playback, magnified playback and the review immediately after shooting in Shooting mode) you can attach sound memos (up to 60 seconds) to an image. The sound data is saved in WAVE format.

1 Press the button while playing back images.

- The Sound Memo panel appears.

2 Select using the ◀ or ▶ arrow on the omni selector, then press the SET button to start recording.



- To stop recording, press the SET button. To restart recording, press the SET button again.
- You can add as many sound memos as you like until their total time reaches 60 seconds.
- Press the  button to end the sound memo settings.



Sound Memo Panel

Playback, Erasing

Playing back the Sound Memos

Select  in step 2 above. Images with sound memos are displayed with the  mark (standard display or detailed display). To stop playback, press the SET button. To restart playback, press the SET button again. You can adjust the volume using the ▲ or ▼ arrow on the omni selector.

Erasing the Sound Memos

Select  in Step 2 on the previous page.



- You cannot attach sound memos to movies.
- You cannot record or playback sound memos for images that already have an incompatible sound file attached. If you attempt to record or play such images, the “Incompatible WAVE format” message will display. Incompatible sound files can be deleted with this camera.
- Sound memos for protected images cannot be erased (p. 139).



- The volume can be adjusted in the Set up menu (p. 51). If you set [Mute] to [On] in the Set up menu (p. 51), no sound is reproduced, however, you can resume the sound and adjust the volume during movie playback by pressing the ▲ or ▼ arrow on the omni selector.

Automated Playback (Slide Show)

Slide show image settings are based on DPOF standards (p. 149).

Starting a Slide Show

All images or a selection of images on a CF card can be displayed one-by-one in an automated slide show.

All Images	Plays all the images on the CF card in order
Slide Show 1 – 3	Plays the images selected for each show in order.

1 In the [(Play)] menu, select [Slide Show] and press the SET button.

- See *Selecting Menus and Settings* (p. 46).

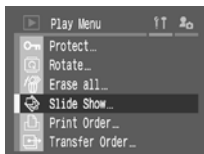

2 Press the ▲ or ▼ arrow on the omni selector to select [Program]. Press the ◀ or ▶ arrow to select between [All Images] or any one of slide [Show 1] – [Show 3].

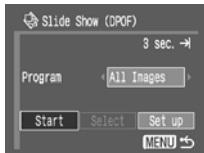

3 Press the ▲ or ▼ arrow on the omni selector to select [Start] and press the SET button.

- The slide show will start and automatically stop when the show is done.

Pausing and Resuming a Slide Show

- Press the SET button to pause the show. Press it again to resume.

Fast Forwarding/Rewinding a Slide Show

- Turn the main dial or use the ◀ or ▶ arrow on the omni selector to move to the previous or next image.

Stopping a Slide Show

Press the MENU button during a slide show to stop it and display the slide show menu.

4 When the slide show is over, press the **MENU** button.

- The slide show menu appears again. Press the **MENU** button again to close the menu.



- Movie images play for the length of time that they were recorded regardless of the time set in the slide show settings.
- The power saving function is disabled while a slide show plays on the camera (p. 31).

Selecting Images for Slide Shows

You can mark images for inclusion in slide shows 1 – 3. Up to 998 images may be marked per slide show. Images display in the order of their selection.

1 Display the slide show menu (p. 135).

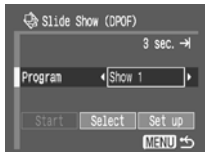

2 Press the **▲** arrow on the omni selector to select [Program]. Press the **◀** or **▶** arrow to select [Show 1], [Show 2] or [Show 3].

- A check mark will appear beside a show already containing images.

3 Press the **▼**, and **◀** or **▶** arrow on the omni selector to choose [Select] and press the **SET** button.

4 Mark images to include in the show.

Single Image Playback

- Move between images using the main dial or the **◀** or **▶** arrow on the omni selector and mark or remove marks from images using the **▲** or **▼** arrow on the omni selector.
- The selection number and a check mark appear at the top of selected images.



Index Playback

- Press the  button to switch to index playback (3 images).
- Select an image using the main dial or the ◀ or ▶ arrow on the omni selector and mark or remove marks from images using the ▲ or ▼ arrow on the omni selector.
- The selection number and a check mark appears at the bottom of selected images.
- After you press the **SET** button, you can select all the images by selecting [Mark all] using ▲ or ▼ on the omni selector and pressing the **SET** button again. (You can deselect all the images by selecting [Clear all].)
- You can select images using the main dial or the ◀ or ▶ arrow on the omni selector and change the settings using the ▲ or ▼ arrow on the omni selector after [Mark all] or [Clear all] has been selected.



5 Press the MENU button.

- The image selection screen will close.

Adjusting the Play Time and Repeat Settings

You can change the play time for all the images in a show and have the show repeat itself continuously.

Play Time	Sets the duration that each image in a slide show is displayed. The options are any one of 3 – 10 seconds, 15 seconds, 30 seconds and Manual.
Repeat	Sets whether the slide show stops when all the slides have been displayed or continues to display until stopped.

1 Display the slide show menu.

- 2** Select [Set up] using the ◀ or ▶ arrow on the omni selector and press the SET button.

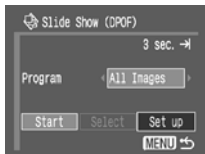

- 3** Select [Play Time] or [Repeat] using the ▲ or ▼ arrow on the omni selector.

- 4** Select a setting using the ◀ or ▶ arrow on the omni selector.

Play Time

- Select a play time.



Repeat

- Select [On] or [Off].



- 5** Press the MENU button.

- The set up menu closes.



- The display interval may vary somewhat for some images.
- Slide shows can be easily edited on a computer with the supplied ZoomBrowser EX or ImageBrowser software programs.

Protecting Images



You can protect important images from accidental erasure.

1 In the [(Play)] menu, select [Protect] and press the SET button.

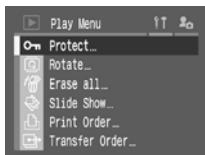
- See *Selecting Menus and Settings* (p. 46).



2 Select an image you want to protect and press the SET button.

- The  icon appears on protected images.
- To remove the protection, press the SET button again (in protection mode).
- You can make the selection of images easier by toggling between single image playback and index playback with the  button.



3 Press the MENU button.

- The protect window closes.



- Please note that formatting (initializing) a CF card erases all data, including protected images (p. 141) and other file types. Please check the contents of a CF card before formatting it.

Erasing Images Individually

Please note that erased images cannot be recovered. Exercise caution before erasing a file.

1 Select the image you wish to erase and press the  button.

2 Select [Erase] using the ◀ or ▶ arrow on the omni selector and press the SET button.

- To cancel instead of erasing, select [Cancel] and press the SET button.
- Protected images cannot be erased with the erase function (p. 139).



Erasing All Images

1 In the [ (Play)] menu, select [Erase all] and press the SET button.

- See *Selecting Menus and Settings* (p. 46).
- The “Erase all images?” message appears.



2 Press the ◀ or ▶ arrow on the omni selector to select [OK] and press the SET button.

- To cancel instead of erasing, select [Cancel] and press the SET button.
- Protected images cannot be erased with the erase function (p. 139).



Formatting a CF Card

You should always format a new CF card or one from which you wish to erase all images and other data. Formatting may restore a CF card if it returns an error or if the “CF” message displays.



- Please note that formatting (initializing) a CF card erases all data, including protected images and other file types. Please check the contents of the CF card before formatting it.

1 In the [SET UP] (Set up) menu, select [Format] and press the SET button.

- See *Selecting Menus and Settings* (p. 46).

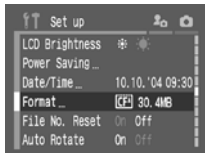

2 Press the ◀ or ▶ arrow on the omni selector to select [OK] and press the SET button.

- To cancel formatting instead, select [Cancel] and press the SET button.
- The capacity of the CF card displayed after formatting will be less than the rated capacity written on the label of the CF card. This is not a malfunction of the CF card or camera.

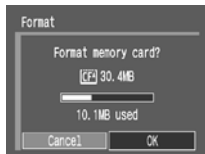

- If the camera does not work properly, the inserted CF card may be malfunctioning. Reformatting the CF card may solve the problem.
- When a non-Canon brand CF card is malfunctioning, reformatting it may solve the problem.
- CF cards formatted in another camera, computer or peripheral device may not operate correctly. When that happens, reformat the CF card with this camera. If formatting in the camera does not work properly, turn the camera off and reinsert the CF card. Then turn the camera back on and format again.

About Printing

There are two ways of printing images shot with this camera.

- You can easily print images stored in the CF card by connecting the camera to a direct print compatible printer*¹ with a cable and then pressing the camera's **SET** button.
- You can specify the images on your CF card you want to print and how many copies you want (DPOF*² Print Settings), and then take the CF card to a participating photo lab that supports DPOF to have them printed out later.

*¹ This camera complies with the industry standard *PictBridge*, therefore, you can connect the camera to non-Canon *PictBridge* compliant printers and print images.

*² Digital Print Order Format

This manual explains the DPOF print settings. For information on how to print images, refer to the *Direct Print User Guide* supplied with the camera. Also, refer to your printer's manual.

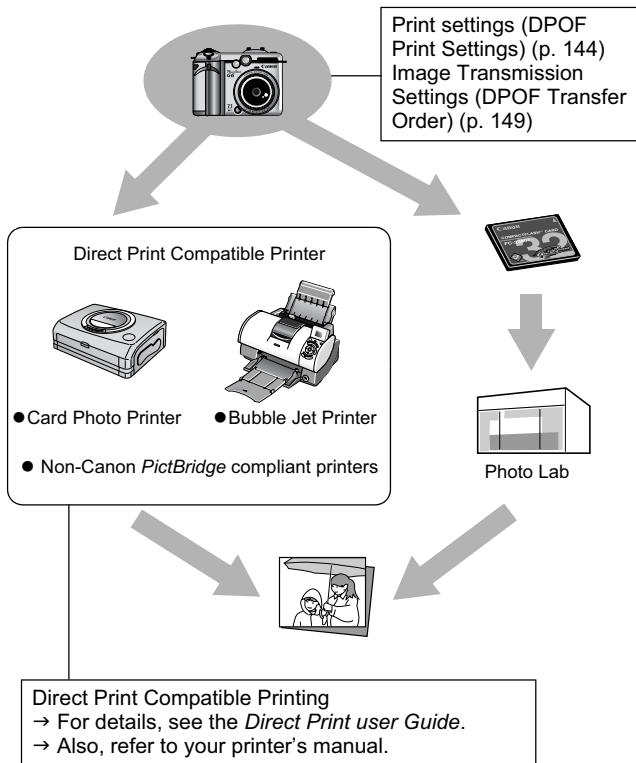

● **Printers that Can Be Used with this Camera**

Canon Direct Print Compatible CP Printers

→ See the *System Map*

Direct Print Compatible Bubble Jet Printers

→ For more information, visit your nearest Canon retailer.

Print Settings (DPOF Print Settings)

Print settings for images on the CF card can be set in advance using the camera. You can select the images you want to print, the number of prints required, and other settings including whether or not to print the time and the date. This is extremely convenient when using a printer compatible with Canon's Camera Direct Printing system to print a series of shots, or when using a photo developing service.

Refer to the *Direct Print User Guide* for instructions on how to select print settings from the printer.



- The  mark may appear on images that have had print marks set by another DPOF compliant camera. These settings will be overwritten by any print marks set by your camera.
- The output of some digital printers or photo lab services may not reflect the specified print settings.
- Print settings cannot be set for movie images or RAW images.

Selecting Images for Printing

1 In the [ (Play)] menu, select [Print Order] and press the SET button.

- See *Selecting Menus and Settings* (p. 46).

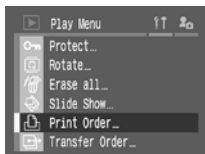

2 Press the ◀ or ▶ arrow on the omni selector to select [Order] and press the SET button.

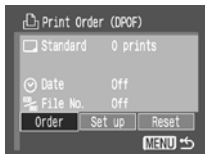

3 Select images for printing.

Single Images

- When the print type (p. 146) is set to [Standard] or [Both], select an image using the main dial or the ◀ or ▶ arrow on the omni selector. You can set the number of copies (up to 99) to be printed using the ▲ or ▼ arrow on the omni selector.
- When the print type (p. 146) is set to [Index], select an image using the main dial or the ◀ or ▶ arrow on the omni selector and mark or remove marks from images using the ▲ or ▼ arrow on the omni selector. A check mark appears on the marked image.
- You can use the same procedures to select images in index playback (3 images). Press the  button to switch between single image playback and index playback.



All the Images on a CF Card

- Press the  button to switch to index playback (3 images).
- You can set one copy of each image to print by pressing the **SET** button, then selecting [Mark all] using the ▲ or ▼ arrow on the omni selector, and pressing the **SET** button again.
- When the print type is set to [Standard] or [Both], the setting for the number of print copies can be changed for each image. When [Index] is selected, the print settings can be deleted. For the instructions on changing settings, please reread Step 3 from the beginning.
- You can cancel all the settings by selecting [Clear all].



4 Press the MENU button.

- The selection mode will turn off and the Print Order menu will reappear.



- Images are printed in order from oldest to newest by the shooting date.
- A maximum of 998 images can be marked per CF card.
- When [Print Type] is set to [Both], the number of copies can be set. When it is set to [Index], the number of copies cannot be set (only one copy will be printed).
- Print settings can also be assigned to images with the supplied software programs (ZoomBrowser EX or ImageBrowser) on a computer.

Setting the Print Style

The following print settings can be selected.

Print Type	<input checked="" type="checkbox"/> Standard	Prints one image per page
	<input type="checkbox"/> Index	Prints the selected images together at a reduced size in an index format
	<input checked="" type="checkbox"/> <input type="checkbox"/> Both	Prints the images in both the standard and index formats
Date		Adds the date to the print
File No.		Adds the file number to the print

1 In the [(Play)] menu, select [Print Order] and press the SET button.

- See *Selecting Menus and Settings* (p. 46).

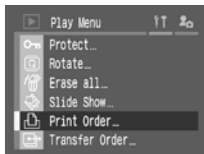

2 Press the ◀ or ▶ arrow on the omni selector to select [Set up] and press the SET button.



3 Press the ▲ or ▼ arrow on the omni selector to select [Print Type], [Date] or [File No.].

4 Press the ◀ or ▶ arrow on the omni selector to select a setting.

Print Type

- Select [Standard], [Index] or [Both].

Date

- Select [On] or [Off].

File No.

- Select [On] or [Off].

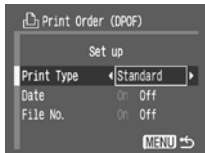

5 Press the MENU button.

- The set up menu will close and the Print Order menu will reappear.



- When [Print Type] is set to [Index], the [Date] and [File No.] cannot be set to [On] at the same time.
- If [Print Type] is set to [Both] or [Standard], then the date and the file no. can both be set to [On] at the same time. However, the information that can be printed may depend on the type of printer.



- The date prints as the date and time in the format specified in the Set Date/Time menu (p. 26).

Resetting the Print Settings

The print settings can all be removed at once. The print type is reset to [Standard] and the date and file number options are set to [Off].

1 In the [▶] (Play) menu, select [Print Order] and press the SET button.

- See *Selecting Menus and Settings* (p. 46).

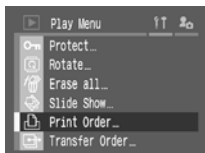

- 2** Press the ◀ or ▶ arrow on the omni selector to select [Reset] and press the SET button.

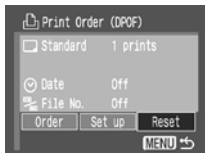

- 3** Press the ◀ or ▶ arrow on the omni selector to select [OK] and press the SET button.

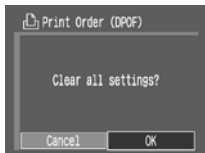



Image Transmission Settings (DPOF Transfer Order)

You can use the camera to specify settings for images before downloading to a computer. Refer to the *Software Starter Guide* for instructions on how to transfer images to your computer. The settings used on the camera comply with the Digital Print Order Format (DPOF) standards.



- The  mark may appear on images that have had transfer marks set by another DPOF compliant camera. These settings will be overwritten by any transfer marks set by your camera.

Selecting Images for Transferring

- 1** In the [ (Play)] menu, select [Transfer Order] and press the SET button.

- See *Selecting Menus and Settings* (p. 46).

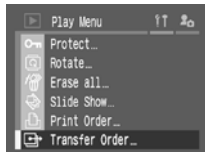

- 2** Select [Order] using the ◀ or ▶ arrow on the omni selector and press the SET button.

- Pressing [Reset] cancels the transfer settings for all images on the CF card.



3 Select images for transferring.

Single Images

- Select an image using the main dial or the ◀ or ▶ arrow on the omni selector and mark or remove marks from images using the ▲ or ▼ arrow on the omni selector. A check mark appears on the marked image.
- You can use the same procedures to select images in index playback (3 images). Press the  button to switch between single image playback and index playback.



All the Images on a CF Card

- Press the  button to switch to index playback (3 images).
- Then press the **SET** button, and select [Mark all] using the ▲ or ▼ arrow on the omni selector and press the **SET** button again. (If you select [Clear all] instead of [Mark all], you can remove marks from all the images.)
- You can select images using the main dial or the ◀ or ▶ arrow on the omni selector and change the settings using the ▲ or ▼ arrow on the omni selector after [Mark all] or [Clear all] has been selected.

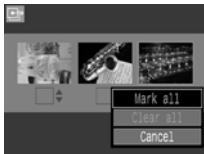

4 Press the MENU button.

- The selection mode will turn off and the Transfer Order menu will reappear.



- Images are transferred in order from oldest to newest by the shooting date.
- A maximum of 998 images can be marked per CF card.

The following methods can be used to download images recorded by the camera to a computer. Some methods are not applicable to all operating systems.

● Downloading via a Camera to Computer Connection

Windows
98 SE

Windows
Me

Windows
2000

Windows
XP

Mac
OS X

- With this method, you download images using computer commands after you have installed the appropriate software.
→ See *Downloading via a Camera to Computer Connection* (p. 152) and the separate *Software Starter Guide*.

Windows
98 SE

Windows
Me

Windows
2000

Windows
XP

- With this method, you download images using camera button operations after you have installed the appropriate software (the computer settings only need to be adjusted for the first download).
→ See *Downloading via a Camera to Computer Connection* (p. 152) and *Downloading Images by Direct Transfer* (p. 156).

Windows
XP

Mac
OS X

- With this method, you download images using computer commands without installing any software.
→ See *Downloading via a Camera to Computer Connection* (p. 152) (software installation is not required) and *Connecting the Camera to the Computer to Download Images without Installing the Software* (p. 158).

● Downloading Directly from a CF Card

With this method, you download images using a card adapter or card reader.

→ See *Downloading Directly from a CF Card* (p. 159).

Downloading via a Camera to Computer Connection

Computer System Requirements

● Windows

OS	Windows 98 Second Edition (SE) Windows Me Windows 2000 Service Pack 4 Windows XP (Including Service Pack 1)
Computer Model	The above OS should be pre-installed on computers with built-in USB ports.
CPU	Pentium 500 MHz or higher processor
RAM	Windows 98 SE/Windows Me: 128 MB or more Windows 2000/Windows XP: 256 MB or more
Interface	USB
Free Hard Disk Space	● Canon Utilities ZoomBrowser EX: 250 MB or more (Including the PhotoRecord printing program) PhotoStitch: 40 MB or more ● Canon Camera TWAIN Driver: 25 MB or more ● Canon Camera WIA Driver: 25 MB or more
Display	1,024 x 768 pixels/High Color (16 bit) or better

● Macintosh

OS	Mac OS X (v10.1.5 – v10.3)
Computer Model	The above OS should be pre installed on computers with built-in USB ports.
CPU	PowerPC G3/G4/G5
RAM	256 MB or more
Interface	USB
Free Hard Disk Space	● Canon Utilities ImageBrowser: 200 MB or more PhotoStitch: 40 MB or more
Display	1,024 x 768 pixels/32,000 colors or better

You must install the software and driver bundled on the supplied Canon Digital Camera Solution Disk onto your computer before connecting the camera to a computer.

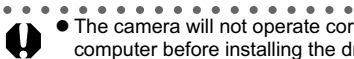

- The camera will not operate correctly if you connect it to your computer before installing the driver and software. If this happens, please refer to the *Troubleshooting* section of the *Software Starter Guide*.

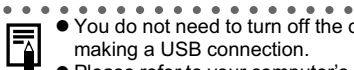

- You do not need to turn off the camera or computer power when making a USB connection.
- Please refer to your computer's manual for information regarding the location of the USB port.
- You are recommended to use a fully charged battery pack or Compact Power Adapter CA-560 (sold separately) to power the camera when connecting to a computer (p. 18, 189).
- All procedures performed with a connection to a USB 2.0 compliant board are not guaranteed.

1 Install the driver and the software applications bundled on the Canon Digital Camera Solution Disk.

- Please see the *Software Starter Guide* for the installation procedures.

With a Macintosh, it is next necessary to set the ImageBrowser on automatic start. For further details, please see the *Software Starter Guide*.

2 Connect the supplied interface cable to the computer's USB port and the camera's DIGITAL terminal.

- When the connection to the computer is complete, the power/mode indicator will light yellow.

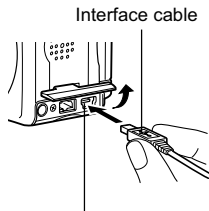
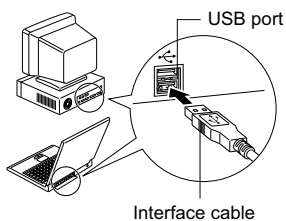

DIGITAL terminal

1. Open the terminal cover with your fingernail.
2. Hold the USB connector so the ← side is up, then insert it into the **DIGITAL** terminal securely.

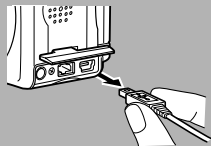

To disconnect the cable from the camera: Hold the cable connector firmly at both sides and pull it straight out.

Windows

→ Proceed to step 3 (p. 155).

Macintosh

→ Refer to the *Software Starter Guide* and download images.

3 Select [Canon CameraWindow] in the events dialog that appears on the computer and click [OK] (first time only).



- If the events dialog fails to appear, click the [Start] menu, followed by [Programs] or [All Programs], [Canon Utilities], [CameraWindow] and [CameraWindow].





The windows shown below will display.



- **Using the software and computer to download images:**
→ See the *Software Starter Guide*.
- **Using the Camera to Download Images (Direct Transfer Function):**
→ See *Downloading Images by Direct Transfer* (p. 156).

Downloading Images by Direct Transfer

Use this method to download images using camera operations. Install the supplied software and adjust the computer settings before using this method for the first time (p. 152).

	All Images	Transfers and saves all images to the computer.
	New Images	Transfers and saves to the computer only the images that have not been previously transferred.
	DPOF Trans. Images	Transfers and saves to the computer only the images with DPOF Transfer Order settings (p. 149).
	Select & Transfer	Transfers and saves single images to the computer as you view and select them.
	Wallpaper	Transfers and saves single images to the computer as you view and select them. The transferred images display on the computer desktop.

1 Use the supplied interface cable to connect the computer's USB port to the camera's DIGITAL terminal. (See step 2 on page 154.)

2 Confirm that the Direct Transfer menu is displayed on the camera's LCD monitor.

- Press the **MENU** button if the Direct Transfer menu fails to appear.

[All Images] [New Images] [DPOF Trans. Images] → Steps 3a, 4a

[Select & Transfer] [Wallpaper] → Steps 3b, 4b



Direct Transfer Menu

3a Select , , or  using the ◀ or ▶ arrow on the omni selector and press the **SET** button.

4a Select [OK] using the ◀ or ▶ arrow on the omni selector and press the SET button.

- The message “Transferring” appears on the LCD monitor.
- To cancel the transfer, press the SET button.
- The images will download and the Direct Transfer menu will reappear.



3b Select  or  using the ▲ or ▼ arrow on the omni selector and press the SET button.

4b Select images to download using the ◀ or ▶ arrow on the omni selector or main dial and press the SET button.

- The images will download.



5 Press the MENU button.

- The Direct Transfer menu will display again.



- Only JPEG format images can be downloaded as wallpaper for the computer. After images are transferred, they are automatically converted to BMP format.

Connecting the Camera to the Computer to Download Images without Installing the Software

If you are using Windows XP or Mac OS X (v10.1.5 – v10.3), you can use the software distributed with these operating systems to download images without installing the software bundled on the Canon Digital Camera Solution Disk. This is useful for downloading images to a computer in which the software is not installed. However, please note that there are certain limitations to downloading images with this method. For more details, please refer to the *For Windows® XP and Mac OS X Users* leaflet.

-
- 1 Use the supplied interface cable to connect the computer's USB port to the camera's DIGITAL terminal. (See step 2 on page 154.)**
 - 2 Follow the onscreen instructions to proceed with downloading.**

Downloading Directly from a CF Card

1

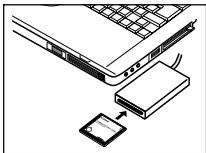

Eject the CF card from the camera, and insert it into a CF card reader connected to the computer.

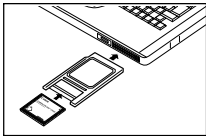

- If you are using a PC card reader or PC card slot in your computer, first insert the CF card into a PC card adapter (sold separately), and then insert the PC card adapter into the computer's PC card reader or PC card slot.
- Refer to your card adapter's or card reader's manual for information regarding the connection between the computer and card adapter or card reader.

2 Double-click the icon of the drive with the CF card.

- Depending on the operating system, a window opens automatically.

3 Copy images from the card into a folder of your choice on the hard disk.

- The images are stored in the [xxxCANON] folders located under the [DCIM] folder (where xxx is a three-digit number from 100 to 998) (p. 122).

Viewing Images on a TV Set

A video-compatible television connected via the supplied AV Cable AVC-DC300 can be used to view images as you shoot or replay them.

1 Turn off the camera and the TV (p. 31).

2

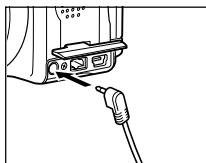

Attach AV Cable AVC-DC300 to the A/V OUT terminal on the camera.

3

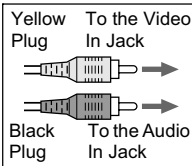

Plug the other ends of the AV cable to the video in and audio in jacks on the TV.

4 Turn on the TV and switch it to Video mode.

5 Turn the mode lever to or (p. 30).

- The image will appear on the TV. Shoot or play back images as usual.



- No image will appear on the LCD monitor when the camera is connected to a TV monitor.
- The video output signal can be switched (NTSC or PAL) to accommodate different regional standards (p. 52). The default setting will vary between regions.
NTSC: Japan, U.S.A., Canada, Taiwan, etc.
PAL: Europe, Asia (excluding Taiwan), Oceania, etc.
If an incorrect video system is set, the output image will not display properly.
- If the TV is a stereo model, you can plug the audio plug into either the left or right Audio In jack. Please refer to the TV's manual for details.
- A TV set cannot be used in  mode.

Customizing the Camera (My Camera Settings)

My Camera settings allows you to customize the start-up image and start-up, shutter, operation and self-timer sounds. Each menu item has three choices.

e.g. Start-up image

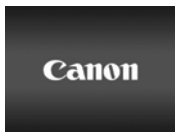

[1]

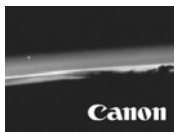

[2]



[3]

The [2] option features science fiction related images and sounds. The [3] option features animals.

Changing My Camera Settings

1 Turn on the camera and press the MENU button.

- The [Rec.] or [Play] menu appears.

2 Select the [My Camera] menu using the ► arrow on the omni selector.

- Pressing the JUMP button also switches between the menu tabs.

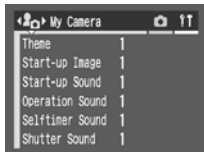

3 Select a menu item using the ▲ or ▼ arrow on the omni selector, then select setting content using the ◀ or ▶ arrow on the omni selector.

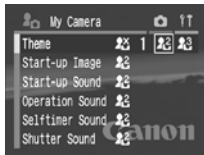

4 Press the MENU button.

- The menu closes and settings are activated.
- In Shooting mode, the menu can be closed by pressing the shutter button halfway. (In Playback mode, the menu closes when the shutter button is pressed halfway and the camera switches to shooting mode.)



- If you select [Theme] in Step 3, you can select a consistent theme for each of the My Camera Settings.
- If [Mute] in the [M] (Set up) menu is set to [On], no sound is reproduced except for the error warning signal regardless of the selected My Camera settings (p. 51). The Start-up image displays.

Registering the My Camera Settings

This function registers new contents to the **[P2]** and **[P3]** options. Images recorded onto the CF card and newly recorded sounds can be added to the camera. You can also use the supplied software to upload your computer's images and sounds to the camera. The following menu items can be saved to the camera.

- Start-up Image
- Shutter Sound
- Selftimer Sound
- Operation Sound
- Start-up Sound



- To return the My Camera Settings to their default values, you will need to use a computer. Use the bundled software program (ZoomBrowser EX or ImageBrowser) to upload the default settings to your camera.

Registering CF Card Images and Sounds

- 1 Turn the mode lever to **[P]** (Playback) and press the **MENU** button.

- The **[P]** (Play) menu appears.

- 2 Select the **[P2]** (My Camera) menu using the **▶** arrow on the omni selector.

- Pressing the **JUMP** button also switches between the menu tabs.

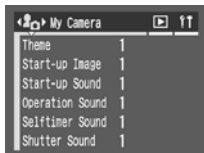

- 3 Select the menu item you wish to register using the **▲** or **▼** arrow on the omni selector, then select **[P2]** or **[P3]** using the **◀** or **▶** arrow on the omni selector.

- **[DISPLAY]** **[P2]** appears.

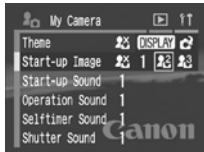

4 Press the DISPLAY button.

- An image appears.

[Start-up Image] → Step 5a, 6a

[Start-up Sound], [Shutter Sound],
[Operation Sound], [Selftimer Sound]
→ Step 5b, 6b



5a Select the image you wish to register using the ◀ or ▶ arrow or on the omni selector.



6a Press the SET button.

5b Select [ (Record)] using the ◀ or ▶ arrow on the omni selector, then press the SET button.

- Recording starts.
- Recording stops when the set amount of time has passed.
Start-up Sound: 1 second
Operation Sound: 0.3 second
Selftimer Sound: 2 seconds
Shutter Sound: 0.3 second



6b Select [ (Register)] using the ◀ or ▶ arrow on the omni selector and press the SET button.

7 Select [OK] using the ◀ or ▶ arrow on the omni selector and press the SET button.





- The following cannot be registered as My Camera settings.
 - RAW images
 - Movies
 - Sound recorded using the Sound Memo function (p. 133)
- When you register new My Camera settings, the previously registered settings are erased.

File Format of My Camera Settings

My Camera settings should conform to the below file formats. However, CF card images shot with this camera can be registered as My Camera settings regardless of the below formats (except RAW images, movies and sounds recorded using the Sound Memo function).

● Start-up Image

- Recording image format JPEG (Base line JPEG)
- Sampling rate 4:2:0 or 4:2:2
- Image size 320 x 240 pixels
- File size 20 KB or less

● Start-up Sound, Operation Sound, Selftimer Sound and Shutter Sound

- Recording format WAVE (monaural)
- Quantization bit 8 bit
- Sampling frequency 11.025 kHz and 8.000 kHz
- Recording time

	11.025 kHz	8.000 kHz
Start-up Sound	1.0 sec. or less	1.3 sec. or less
Operation Sound	0.3 sec. or less	0.4 sec. or less
Selftimer Sound	2.0 sec. or less	2.0 sec. or less
Shutter Sound	0.3 sec. or less	0.4 sec. or less

Any file format other than those described above cannot be used with this camera.

Registering the My Camera Settings (continued)

An example of this function is to record “Say cheese” as a self-timer sound so the camera will replay this sound 2 seconds before the photo is taken. You could also record cheerful music to bring out the natural smiles of your subjects, or so they can strike a pose fitting the music. In these ways you can customize your camera by creating and adding new My Camera settings.

See the supplied *Software Starter Guide* for more information on creating and adding My Camera files.

The following error and message codes may appear on the display panel.

Error Codes

E_{xx}
(XX: number) : The camera has experienced a problem. Turn off the power, wait a second, and then try shooting or playing back. If the error code appears repeatedly, there is a problem. Note the error code number and take the camera in for servicing. If an error code appears immediately after a shot, there is a chance that the image was not recorded. Check the image in playback mode.

Message Codes

P_b : Playing back image.

P_C : Connected to computer in PC connection mode.

 : Adequate battery charge.

 : Low battery charge. Charge the battery as soon as possible to use for any length of time.

 : Battery charge low, camera will not operate. Immediately recharge or replace the battery pack with a charged one.

CF : No CF card in camera, CF card/battery cover is open, or CF card error.

LENS : Power turned on while holding the lens. Turn power off and on again.

int : Intervalometer is set (shoots images automatically at set time intervals). (The number of remaining shots display after the first images is shot.)

List of Messages

The following messages may appear on the LCD monitor.

- For messages which may appear when a printer is connected, refer to the *Direct Print User Guide*.

Busy... :	Image is being recorded to, or read from, CF card. Resetting settings to default.
No memory card:	You turned on the power without a CF card installed.
Cannot record!:	You attempted to shoot an image without a CF card installed.
Memory card error!:	CF card has experienced an anomaly.
Memory card full:	CF card is too full to accommodate more images, image settings (such as slide show or print settings) or sound memos.
Naming error!:	The file could not be created because there is a file with the same name as the directory that the camera is attempting to create, or the highest possible file number has already been reached. In the Set up menu, please set [File No. Reset] to [On]. After you save all the images you wish to retain onto a computer, format the CF card (p. 141). Please note that formatting will erase all the existing images and other data.
Change the battery pack:	Battery charge is insufficient to operate the camera. Replace it immediately with a charged battery pack or recharge it.
No image:	No images recorded on CF card.
Image too large:	You attempted to play back an image larger than 4064 x 3048 pixels.
Incompatible JPEG format:	You attempted to play back an incompatible JPEG file.
Corrupted data:	You attempted to play back an image with corrupted data.
RAW:	You attempted to play back an image recorded in an incompatible RAW format.
Cannot magnify!:	You attempted to magnify a movie or an image that was photographed with another camera, recorded in a different format, or edited on a computer.



Cannot rotate:	You attempted to rotate a movie or an image that was photographed with another camera, recorded in a different format, or edited on a computer.
Unidentified Image:	You attempted to play back an image that was recorded in a special format (proprietary format used by the camera of another manufacturer, etc.) or a movie clip recorded by another camera.
Incompatible WAVE format:	Cannot attach sound memos to the image because the image has some sound file recorded in an inappropriate format.
Protected!:	You attempted to erase a protected image.
Too many marks:	Too many images have been marked with print settings, transfer settings or slide show settings. Cannot process any more.
Unselectable image:	You attempted to set the print settings for a non-JPEG file.
Cannot complete!:	Couldn't save the print, transfer or slide show settings.
Cannot edit:	Slide show settings file is corrupted.
Cannot register this image!:	You attempted to register an image recorded with another camera or shot in the RAW format as a start-up image.
Cannot change!:	You attempted to change to the RAW format an image that was shot with the digital zoom or that was already recorded in the RAW format.

Problem	Cause	Solution
Camera will not operate	Power is not turned on	<ul style="list-style-type: none"> ● Turn on the camera. → See <i>Turning the Power On/Off</i> (p. 29).
	CF card slot cover or battery cover opened	<ul style="list-style-type: none"> ● Confirm that the CF card slot cover or battery cover is securely closed.
	Insufficient battery voltage ([L b] lights in display panel)	<ul style="list-style-type: none"> ● Fully charge the battery before installing it in the camera. ● Use a compact power adapter.
	Poor contact between camera and battery terminals	<ul style="list-style-type: none"> ● Wipe the terminals with a clean, dry cloth.
Camera will not record	Camera is in playback or computer/printer connection mode	<ul style="list-style-type: none"> ● Switch the camera to Shooting mode. → See <i>Switching between Shooting and Playback</i> (p. 32). ● During a computer or printer connection, disconnect the interface cable before switching the camera to shooting mode.
	Flash is charging (Blinking ⚡ on LCD monitor)	<ul style="list-style-type: none"> ● Wait until the upper indicator lights orange, signaling that the flash is charged, then press the shutter button.
	CF card full	<ul style="list-style-type: none"> ● Insert a new CF card. ● If required, download the images to a computer and erase them from the CF card to make space.
	CF card not formatted correctly	<ul style="list-style-type: none"> ● Format CF card. → See <i>Formatting a CF Card</i> (p. 141). ● If reformatting doesn't work, the CF card logic circuits may be damaged. Contact the nearest Canon Customer Support Help Desk.

Problem	Cause	Solution
Cannot play back	You attempted to play back images shot with another camera or images edited at a computer.	<ul style="list-style-type: none"> ● In some cases you may be able to playback the image if you upload it to your camera using the bundled software (ZoomBrowser EX or Image Browser). See the <i>ZoomBrowser EX/ImageBrowser Software User Guide</i> (PDF).
	File name was changed with a computer or file location was changed.	<ul style="list-style-type: none"> ● Set the file name or location to the file format/structure of the camera. (See <i>About File and Folder Numbers</i> (p. 122).)
Lens will not retract	CF card slot cover or battery cover opened with camera on	<ul style="list-style-type: none"> ● Close the CF card slot cover and battery cover, then turn off the camera.
	CF card slot cover or battery cover opened while camera was recording to CF card (warning signal)	<ul style="list-style-type: none"> ● Close the CF card slot cover and battery cover, then turn off the camera.
Battery pack consumed quickly	Battery pack capacity reduced because of disuse for one year or more after being fully charged	<ul style="list-style-type: none"> ● Replace the battery pack with a new one.
	Battery life exceeded	<ul style="list-style-type: none"> ● Replace the battery pack with a new one.
Battery pack will not charge	Battery life exceeded	<ul style="list-style-type: none"> ● Replace the battery pack with a new one.
	Poor contact between battery pack and battery charger	<ul style="list-style-type: none"> ● Clean the battery terminals with a clean dry cloth. ● Attach the battery pack to the battery charger securely. ● Insert the plug of the battery charger firmly into the power outlet.
A noise issues from inside the camera.	The camera's vertical and horizontal orientations have changed.	<ul style="list-style-type: none"> ● The mechanism for detecting the camera's orientations is operating. There is no problem with the camera.

Problem	Cause	Solution
Image is blurred or out of focus	Camera moved	<ul style="list-style-type: none"> ● Be careful not to move the camera when pressing the shutter button. ● Use a tripod at slow shutter speeds when the camera shake warning  appears.
	Autofocus function hampered by obstruction to AF-assist Beam	<ul style="list-style-type: none"> ● Be careful not to block the AF-assist Beam with your finger or other items.
	AF-assist Beam is set to off	<ul style="list-style-type: none"> ● Set the AF-assist Beam to [On]. → See <i>Rec. Menu</i> (p. 48).
	Subject out of focal range	<ul style="list-style-type: none"> ● Ensure that there is at least 50 cm (1.6 ft.) between the camera lens and subject. ● Use the (Macro) mode to shoot close-ups between 5 and 50 cm (2.0 in. and 1.6 ft.) at maximum wide angle and 15 and 50 cm (5.9 in. and 1.6 ft.) at maximum telephoto. ● You can also use Super Macro mode when the distance to the subject is 5 to 20 cm (2.0 to 7.9 in.) (wide angle end to 86 mm*). <p>* Zoom position (35mm film equivalent)</p>
Subject is hard to focus on	<ul style="list-style-type: none"> ● Use the focus lock or the manual focus to shoot the image. ● See <i>Shooting Problem Subjects for the Autofocus</i> (p. 114). 	
Subject in recorded image is too dark	Insufficient light for shooting	<ul style="list-style-type: none"> ● Set the built-in flash to on. ● Use a high-output externally mounted flash.

Problem	Cause	Solution
Subject in recorded image is too dark	Subject dark in comparison to the background	<ul style="list-style-type: none"> ● Set the exposure compensation to a positive (+) setting. ● Use the AE lock or spot metering function. → See <i>Locking the Exposure Setting (AE Lock)</i> (p. 105) and <i>Switching between Light Metering Modes</i> (p. 92).
	Subject too far for flash to reach	<ul style="list-style-type: none"> ● To use the built-in flash, shoot within 70 cm to 5.0 m (2.3 to 16 ft.) of the subject at the maximum wide angle and within 70 cm to 4.0 m (2.3 to 13 ft.) at the maximum telephoto setting. ● Use an externally mounted flash with a large output. ● Raise the ISO sensitivity and then shoot. → See <i>Changing the ISO Speed</i> (p. 98).
	The ND filter is On.	<ul style="list-style-type: none"> ● Set [ND Filter] to [Off]. → See <i>Using the ND Filter</i> (p. 120).
Subject in recorded image is too bright	Subject too close causing flash to be too bright	<ul style="list-style-type: none"> ● Adjust the flash output with the flash exposure compensation function (p. 109).
	Subject bright in comparison to the background	<ul style="list-style-type: none"> ● Set the exposure compensation to a negative (-) setting. ● Use the AE lock or spot metering function. → See <i>Locking the Exposure Setting (AE Lock)</i> (p. 105) and <i>Switching between Light Metering Modes</i> (p. 92). ● Set [ND Filter] to [On]. → See <i>Using the ND Filter</i> (p. 120).
	Light shining directly on subject or reflected off subject into camera	<ul style="list-style-type: none"> ● Change the shooting angle.

Problem	Cause	Solution
Subject in recorded image is too bright	Flash set to On	<ul style="list-style-type: none"> ● Set the flash to Auto or Off.
A vertical bar of light (red, purple) appears on the LCD monitor	Subject too bright	<ul style="list-style-type: none"> ● This is a normal occurrence in devices containing CCDs and does not constitute a malfunction. (This red bar of light will not be recorded when shooting still photos, but it will be recorded when shooting movies.) ● This effect can be reduced by setting [ND Filter] to [On]. → See <i>Using the ND Filter</i> (p. 120).
White dots or white asterisks appear on the image	Light from the flash has reflected off dust particles or insects in the air. This occurs more frequently in the following conditions: <ul style="list-style-type: none"> • When shooting at the wide angle end. • When shooting with a high aperture value in the aperture-priority AE mode. 	<ul style="list-style-type: none"> ● This is a phenomenon that occurs with digital cameras and does not constitute a malfunction.
Flash will not fire	Flash set to Off	<ul style="list-style-type: none"> ● Set the flash to On.
Image not showing on TV	Incorrect video system setting	<ul style="list-style-type: none"> ● Set the video system to the appropriate setting, NTSC or PAL, for your TV (p. 52).
	Shooting mode set to  (Stitch Assist)	<ul style="list-style-type: none"> ● The output will not appear on a TV monitor in  (Stitch Assist) mode. Shoot in a different mode.
Zoom will not operate	Zoom lever turned while shooting in movie mode	<ul style="list-style-type: none"> ● Operate the zoom before shooting in movie mode.
CF card image reading is slow Recording images on the CF card takes too long	Currently used CF card has been formatted in a different device.	<ul style="list-style-type: none"> ● Use a CF card formatted with this camera. → See <i>Formatting a CF Card</i> (p. 141).

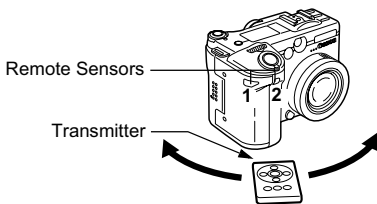

Shooting/Playback

The wireless controller can be used to shoot or play back. The wireless controller can be operated from an approximate distance of up to 5 m (16.4 ft.) from the front remote sensor (2) and approximately 1 m (3.3 ft.) from the side remote sensor (1).



When Macro Ring Lite MR-14EX or Macro Twin Lite MT-24EX is mounted on the camera, it will block the front remote sensor 2. In this case, aim the wireless controller toward the side remote sensor 1.

● Shooting

Press the  /  button on the camera until the  icon appears in the display panel, then shoot the image.

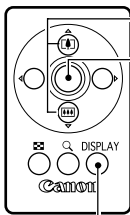

① Compose the image with the zoom buttons.

② Press the shutter button.

The camera will shoot the image after the time set in [Wireless Delay] in the Rec. menu has elapsed (0 seconds, 2 seconds or 10 seconds).

- Each press of this button cycles the LCD monitor to the next display mode. The order is LCD monitor on (no display), LCD monitor on (detailed display) and LCD monitor off.

● Playback

 appears on the display panel.

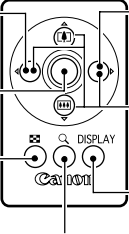
- 
- Displays the previous image
 - Plays back the movie images
 - Displays images in sets of nine (index playback).
 - Displays the next image
 - In magnified mode, these buttons move the magnified area around the image.
 - In index playback, these buttons move the image selection.
 - Each press of this button cycles the information view mode.
 - The display cycles between magnifications of approximately 2.5, 5 and 10.



- The operable range of the wireless controller will shorten under the following circumstances.
 - When the wireless controller is used at an angle to the remote sensor.
 - When strong light strikes the camera.
 - When the battery is weak.



- The movie editing and printing functions are not available.
- When you fix the camera to a tripod and shoot still images, aim the remote controller's transmitter at remote sensor 1 (see the first illustration on page 176) to operate the camera from the side without touching the camera. This prevents camera shake when shooting just like using a remote release. You should set [Wireless Delay] in the Rec. menu to [0 sec.] when you use this method.

Attaching the Lens Hood LH-DC30 (Sold Separately)

When shooting backlit scenes without a flash with the lens set to a wide angle, you should attach the lens hood to prevent light outside the scene from coming into the lens.

- When using the lens hood, you cannot attach any other optical accessories (sold separately) to the camera.
- The LH-DC30 consists of an adapter component and a hood component. At the time of purchase, the adapter and the hood are joined together. Turn in the direction of the arrow to separate the two components.

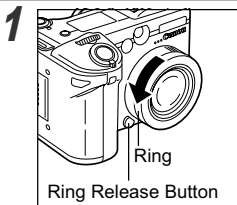
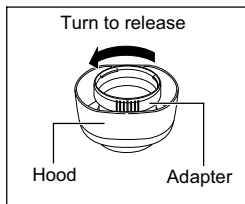

Turn off the camera. Then press and hold the ring release button and remove the outer ring on the lens.

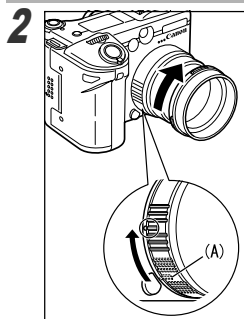

Attach the adapter to the camera by aligning the part of the adapter marked (A) with the ring release button, then rotating the lens adapter until the part marked (A) aligns with the ◡ mark.

Using an Externally Mounted Flash (Sold Separately)

You can make your flash photography even clearer and more natural appearing with the use of a separately sold externally mounted flash.

The camera's auto exposure function will operate with a Canon Speedlite 220EX, 420EX, 550EX, 580EX, a Macro Ring Lite MR-14EX or a Macro Twin Lite MT-24EX (p. 182). (Except with the **M** mode or when [Flash Adjust] is set to [Manual].) Other flashes may fire manually or not fire at all.

Please check the manual for your flash.

* Certain functions noted in the manuals for the Canon Speedlite 220EX, 420EX, 550EX, 580EX, the Macro Ring Lite MR-14EX and Macro Twin Lite MT-24EX cannot be performed when mounted on this camera. Please read this guide before using one of these flashes on the camera.

1

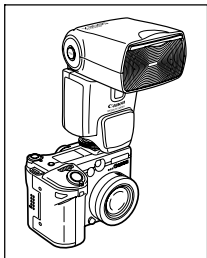

Attach the flash to the camera's hot shoe.





2

Turn the external flash on and turn the mode lever to  (Shooting).

3

Turn the mode dial to a position other than  or .

Speedlite 220EX, 420EX, 550EX, 580EX, Macro Ring Lite MR-14EX or Macro Twin Lite MT-24EX

- The flash will automatically adjust its output in the **AUTO**, , , , **P**, **Tv** and **Av** modes when [Flash Adjust] is set to [Auto]. The maximum flash synchro shutter speed is 1/250 second.
- In **M** mode or when [Flash Adjust] is set to [Manual], the flash will fire with manual adjustments. The maximum flash synchro shutter speed in this case is 1/250 second. Set the aperture to an appropriate value according to the flash's guide number and the distance to the subject. Check the camera's ISO sensitivity setting since the flash's guide number will change with the ISO value.
- When [Flash Adjust] is set to [Manual], the flash output can be adjusted. When [Flash Adjust] is set to [Auto] the flash exposure compensation can be adjusted (p. 109).
- In **M** mode or when [Flash Adjust] is set to [Manual], the output of an externally mounted flash can be adjusted in the flash output adjustment screen (p. 110). When a Speedlite 550EX, 580EX, a Macro Ring Lite MR-14EX or a Macro Twin Lite MT-24EX is mounted on the camera, you can adjust the flash output from either the flash or the camera. (The flash setting overrides the camera setting when both are set.) To set it from the flash, you are recommended to use the flash's manual mode. You can also adjust the flash output even when the camera is set to the E-TTL automatic flash exposure compensation mode by changing the flash exposure compensation setting. In this situation, the +2 step setting fires the flash at full intensity.
To shoot with the flash, you are recommended to set the white balance to the  **WB** (Flash) setting.

Other Canon Flashes



- Since other flashes fire at full strength, set the shutter speed and aperture accordingly. Set the shutter speed to 1/125 second or slower, and set the aperture to a value appropriate to the flash's guide number and the distance to the subject.
You are recommended to set the white balance to  **WB** (Flash) to shoot.

4 Press the shutter button halfway.

- The flash is charged when its pilot lamp lights up.

5 Press the shutter button all the way to shoot the image.



- The externally mounted flash will not fire in ,  or continuous shooting.
- The Bracket mode cannot be used for flash photography. If the flash fires, only one image gets recorded.
- Flashes (especially high-voltage flashes) or flash accessories made by other manufacturers may override certain camera functions or cause a camera malfunction.



- The following functions can be used with a Speedlite 220EX, 420EX, 550EX or 580EX.
 - Auto Exposure (Use the E-TTL mode with a 550EX or 580EX)
 - FE Lock (Not available in **M** mode)
 - Flash Sync (1st-curtain/2nd-curtain) (2nd-curtain priority with Speedlite 550EX or 580EX)
 - Daylight Synchro
 - Slow Synchro
 - Flash Exposure Compensation (When Speedlite 550EX or 580EX is used, if flash exposure adjustments are made both from the camera and the flash, the 550EX's (or 580EX's) flash exposure compensation setting takes precedence when the flash is set to E-TTL mode. The camera's flash exposure compensation setting will not activate.)
 - Auto Zoom (Not available with the 220EX)

How to Mount Macro Ring Lite MR-14EX and Macro Twin Lite MT-24EX

The separately sold Conversion Lens Adapter LA-DC58D is required to mount Macro Ring Lite MR-14EX or Macro Twin Lite MT-24EX on the camera.

1

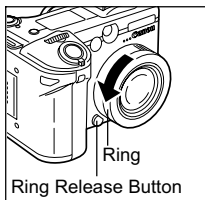

Turn off the camera. Then press and hold the ring release button and remove the outer ring on the lens.

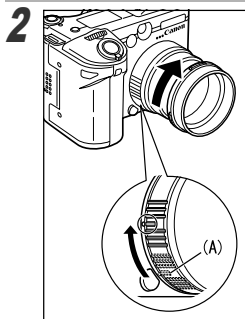

Attach the conversion lens adapter to the camera by aligning the part of the adapter marked (A) with the ring release button, then rotating it until the  mark.

- If you wish to mount the Macro Twin Lite MT-24EX on the camera, it is recommended that you first attach the Macro Lite Adapter 58C (sold separately).
- If you wish to use the Close-up Lens 250D (p. 186) together with the Macro Ring Lite MR-14EX or Macro Twin Lite MT-24EX, the Close-up Lens 250D should be attached first followed by the Macro Lite Adapter 58C (sold separately).

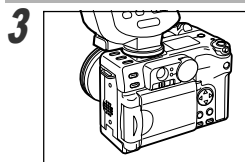

Attach the controller to the camera's hot shoe.

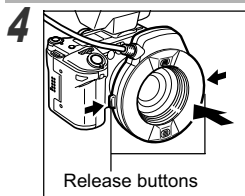

Macro Ring Lite MR-14EX
Press and hold the release buttons on both sides of Macro Ring Lite MR-14EX and fit it into the conversion lens adapter.

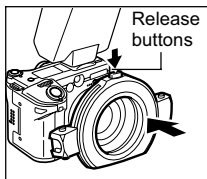

Macro Twin Lite MT-24EX
Press and hold the release button on the top of the external ring and fit it into the conversion lens adapter or Macro Lite Adapter 58C.

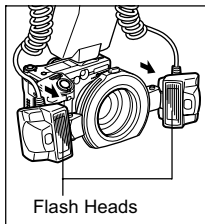

- Attach the flash heads to their respective flash head mounts.

5 Press the button to set the camera to Macro mode and set [ND Filter] to [On].

- Macro mode (p. 74)
- ND filter (p. 120)



- To remove the conversion lens adapter, hold down the ring release button and turn the adapter in the opposite direction shown in Step 2.



- When you are using Macro Ring Lite MR-14EX or Macro Twin Lite MT-24EX, you can shoot in E-TTL automatic flash exposure compensation mode just by setting the camera's shooting mode to **P**, **Av** or **Tv**.

You are recommended to set the aperture in **Av** or **M** mode for full-fledged macro flash photography.

- The following functions can be used with Macro Ring Lite MR-14EX or Macro Twin Lite MT-24EX mounted.
 - E-TTL Automatic Flash Exposure Compensation
 - FE Lock
 - Flash Sync (1st-curtain/2nd-curtain)
(The flash's 2nd-curtain setting takes precedence.)
 - Daylight Synchro
 - Slow Synchro
 - Flash Exposure Compensation
- When exposure compensation settings are selected on both the camera and the Macro Ring Lite MR-14EX and Macro Twin Lite MT-24EX, the macro ring lite setting takes precedence (when in E-TTL mode) and the camera setting is overridden.

Using Conversion Lenses/ Close-up Lenses (Sold Separately)

The separately sold Conversion Lens Adapter LA-DC58D is required to use conversion and close-up lenses with the camera, such as the separately sold Wide Converter WC-DC58N, Tele-converter TC-DC58N and Close-up Lens 250D (58 mm). (The Wide Converter WC-DC58 and the Tele-converter TC-DC58 for the PowerShot G1/ G2 are not recommended since shooting problems may occur.)



- Ensure that the wide converter, tele-converter or close-up lens is firmly screwed onto the adapter. Injury from glass shards can occur if the lens loosens and falls off.
- Never aim the wide converter, tele-converter or close-up lens directly at the sun or bright lights.

Wide Converter WC-DC58N

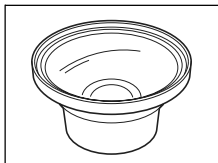

This 58 mm-threaded diameter magnifying conversion lens is for taking wide angle shots. The lens changes the focal length of the camera body's lens by a factor of 0.7x.

Tele-converter TC-DC58N

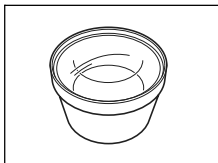

This 58 mm-threaded diameter magnifying conversion lens is for taking telephoto shots. The lens changes the focal length of the camera body's lens by a factor of 1.75x.



- An externally mounted flash may not automatically adjust its output when a conversion lens is mounted on the camera.
- Do not attach filters or lens hoods to the wide converter or tele-converter.
- When using the built-in flash to shoot, a portion of the image may be blocked by the wide converter or tele-converter and appear dark.
- When using the viewfinder to shoot, a portion of the image in the viewfinder may appear to be blocked by the wide converter or tele-converter.
- Use the wide converter lens with the focal length set to the maximum wide angle setting.
- Use the tele-converter lens with the focal length set to the maximum telephoto setting. At other zoom settings, the image will not appear correctly.

Close-up Lens 250D (58 mm)

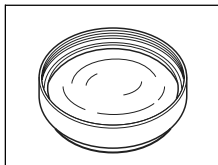

This lens, with a 58 mm-threaded diameter, makes macro shooting easier. With the camera in macro mode, it can shoot subjects as close as 5 cm (2.0 in.) from the lens tip.

- When the lens is zoomed out to the wide angle end, the recordable area is 44 x 33 mm (1.7 x 1.3 in.) at the closest focal distance, and at a telephoto setting of 86 mm (35mm film equivalent), it is 22 x 17 mm (0.87 x 0.67 in.).



- You are recommended to use Macro Ring Lite MR-14EX or Macro Twin Lite MT-24EX for flash photography with the close-up lens mounted on the camera. (If you plan to attach Macro Ring Lite MR-14EX, first attach Macro Lite Adapter 58C (sold separately) to Close-up Lens 250D.)
- When using the built-in flash to shoot, a portion of the image in the viewfinder may appear to be blocked by the wide converter or tele-converter and appear dark.
- When using the viewfinder to shoot, a portion of the image in the viewfinder may appear to be blocked by the wide converter or tele-converter.
- Set the focal length of the camera's lens to telephoto when using the close-up lens.

Mounting the Lenses

1

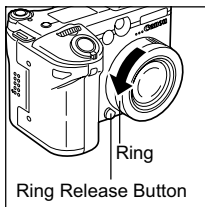

Turn the power off and press the ring release button and remove the ring from around the lens on the camera body.

2

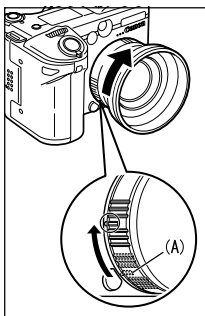

Attach the conversion lens adapter to the camera by aligning the part of the adapter marked (A) with the ring release button, then rotating it until the .

- To remove the conversion lens adapter, hold down the ring release button and turn the adapter in the opposite direction shown.

3



Screw on the lens in the direction of the arrow.



- Since the image seen in the viewfinder does not change when a conversion lens is installed, use the LCD monitor to compose images.
- Please note that the images will not merge properly with the PhotoStitch program on a computer when they are shot in  mode with a conversion or close-up lens.
- To protect the conversion lenses, hold them with one hand while you screw them on the camera with the other hand.
- Completely remove all dust and dirt from conversion lenses with a lens blower brush before use. The camera may focus on any dirt that remains.
- Exercise due caution when handling the conversion lenses since it is easy to dirty them with fingerprints.

Using a Compact Power Adapter (Sold Separately)

You should use the separately sold Compact Power Adapter CA-560 when using the camera for long periods of continuous use or for connecting to a computer or printer.

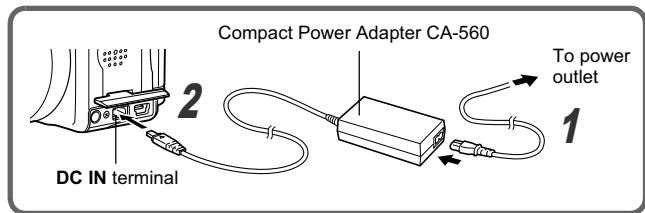

1 Attach the power cord to the compact power adapter and plug it into a power outlet.

2 Open the terminal cover and connect the DC plug of the compact power adapter to the camera's DC IN terminal.

- Always disconnect and unplug the compact power adapter after use.

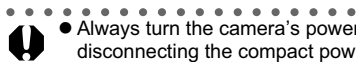

- Always turn the camera's power off before connecting or disconnecting the compact power adapter.
- Only use the Compact Power Adapter CA-560 with cameras that use Battery Pack BP-511A, Battery Pack BP-511, Battery Pack BP-512 or Battery Pack BP-514.

Using a Battery Charger (Sold Separately) and Car Battery Cable (Sold Separately)

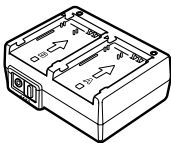

Battery Charger CG-570

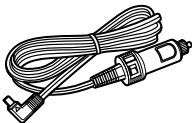

Car Battery Cable CB-570

Combined use of Battery Charger CG-570 (sold separately) and Car Battery Cable CB-570 (sold separately) lets you charge battery packs (up to 2 at the same time) from a car's cigarette lighter socket. It is also possible to charge up to 2 battery packs at the same time from a power outlet if you connect Compact Power Adapter CA-560 (sold separately) or Compact Power Adapter CA-570 (sold separately) to Battery Charger CG-570. Battery Pack BP-511A, Battery Pack BP-511, Battery Pack BP-512 and Battery Pack BP-514 can be charged with these combinations. Refer to each product's manual on how to charge battery packs.

Replacing the Date Battery

If the Set Date/Time menu appears when you turn on the camera power, the date battery charge is low and the date and time settings have been lost. Please replace the battery with a generic CR2016 lithium coin battery with the following procedures.

Please note that the first date battery may appear to expire relatively quickly after you purchase the camera. This is because it is installed in the camera at the point of manufacture, not when you make the purchase.



- Be particularly careful to keep the date batteries out of the reach of children. Seek medical assistance immediately if a child swallows a battery since corrosive battery fluids could damage the stomach or intestinal wall.

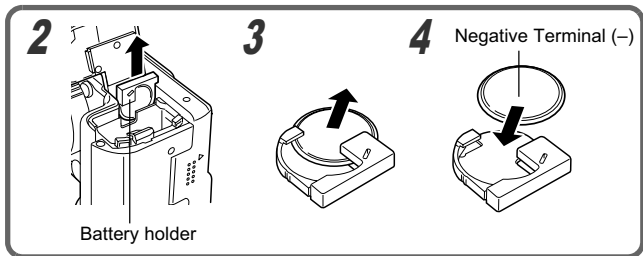

- 1 Turn off the power and open the battery cover (p. 21).
- 2 Remove the battery pack, then pull out the battery holder by hooking your fingertip under the bottom of the battery holder edge.
- 3 Use your fingertip to push the edge of the battery in the direction of the arrow.

4 Place a new date battery into the date battery holder with the negative terminal (–) facing upward.

5 Replace the date battery holder, replace the battery pack and close the battery cover.

If you ever dispose of your camera, first remove the date battery for recycling according to the recycling system of your country.



Camera Care and Maintenance

Use the following procedures to clean the camera body, lens, viewfinder, LCD monitor and other parts.

- | | |
|-----------------------------------|---|
| Camera body | : Wipe the body clean with a soft cloth or eyeglass lens wiper. |
| Lens | : First use a lens blower brush to remove dust and dirt, then remove any remaining dirt by wiping the lens lightly with a soft cloth. <ul style="list-style-type: none">● Never use synthetic cleansers on the camera body or lens. If dirt remains, contact the nearest Canon Customer Support Help Desk as listed on the separate Canon Customer Support leaflet. |
| Viewfinder
LCD Monitor | : Use a lens blower brush to remove dust and dirt. If necessary, gently wipe the viewfinder and LCD monitor with a soft cloth or an eyeglass lens wiper to remove stubborn dirt. <ul style="list-style-type: none">● Never rub or press forcefully on the LCD monitor or viewfinder. These actions may damage them or lead to other problems. |

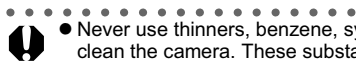

- Never use thinners, benzene, synthetic cleansers or water to clean the camera. These substances may distort or damage the equipment.

All data is based on Canon's testing standard. Subject to change without notice.



PowerShot G6

Camera Effective Pixels:	Approx. 7.1 million
Image Sensor:	1/1.8-inch CCD (Total number of pixels: Approx. 7.4 million)
Lens:	7.2 (W) – 28.8 (T) mm (35mm film equivalent: 35 (W) – 140 (T) mm) f/2.0 (W) – f/3.0 (T)
Digital Zoom:	Approx. 4.1x (Up to approx. 16x in combination with the optical zoom)
Optical viewfinder:	Real-image zoom viewfinder Picture coverage approx. 80% Dioptic adjustment –3 to +1 m ⁻¹ (dpt equivalent)
LCD Monitor:	2.0-inch, low-temperature poly crystalline silicon TFT color LCD, approx. 118,000 pixels (Picture coverage 100%)
AF System:	TTL autofocus (continuous or single) AF lock and Manual focus are available Focusing frame: 9-point (AiAF)/1-point (AF) (any position is available)
Shooting Distance (from the front of the lens):	Normal AF: 50 cm (1.6 ft.) – infinity Macro AF: 5 – 50 cm (2.0 in. – 1.6 ft.) (W) 15 – 50 cm (5.9 in. – 1.6 ft.) (T) Super Macro AF: 5 – 20 cm (2.0 in. – 7.9 in.) (W – 86 mm (35mm film equivalent)) Manual focus: 5 cm – infinity (2.0 in. – infinity) (W)/ 15 cm – infinity (5.9 in. – infinity) (T)
Shutter:	Mechanical shutter + electronic shutter
Shutter Speeds:	15 – 1/2000 sec. • The shutter speed range varies according to shooting mode. • Slow shutter speeds of 1.3 sec. or slower operate with noise reduction.
Light Metering System:	Evaluative, Center-weighted average or Spot (Center or AF-point)

(W): Wide angle end/(T): Telephoto end

Exposure Control System:	Program AE, Shutter-priority AE, Aperture-priority AE or Manual exposure control AE lock is available.
Exposure Compensation:	± 2.0 stops in 1/3-stop increments Auto exposure bracketing (AEB) is available.
Sensitivity:	Auto, ISO 50/100/200/400 equivalent
White Balance:	TTL auto, pre-set (available settings: Daylight, Cloudy, Tungsten, Fluorescent, Fluorescent H or Flash) or custom (Custom1/Custom2)
Built-in Flash:	Auto*, on*, off * Red-eye reduction is available.
Flash Range:	70 cm – 5 m (2.3 – 16 ft.) (W), 70 cm – 4 m (2.3 – 13 ft.) (T) (When sensitivity is set to ISO 100 equivalent.)
Terminals for External Flash:	Sync-terminals on accessory shoe Use of the following external flashes is recommended: Canon Speedlite 220EX, 420EX, 550EX, 580EX, Macro Ring Lite MR-14EX and Macro Twin Lite MT-24EX.
Flash Exposure Compensation:	±2.0 stops in 1/3-stop increments, FE Lock, Slow synchro and 1st-curtain/2nd-curtain flash are available.
Shooting Modes:	Auto Creative zone: Program, Shutter-speed priority, Aperture priority, Manual, Custom1 and Custom2 Image zone: Portrait, Landscape, Night scene, Stitch assist and Movie
Continuous Shooting:	High-speed: Approx. 2.0 shots/sec. Standard: Approx. 1.2 shots/sec. (Large/Fine mode with LCD monitor off)
Interval Shooting:	Shooting interval: approx. 1 – 60 min. (1-min. increments) Number of shots: 2 – 100 shots (Maximum number of shots varies according to CF memory card capacity.)
Self-timer:	Activates shutter after an approx. 10-sec./approx. 2-sec. delay

(W): Wide angle end/(T): Telephoto end

Wireless Control:	Shooting and playback are available (wireless controller is included in the camera kit). When shooting, image is captured instantly/approx. 2-sec./approx. 10-sec. after shutter button is pressed.
PC-controlled Shooting:	Available (USB connection only). Exclusive software program is included in the camera kit.)
Recording Media:	CompactFlash™ (CF) card (Type I and Type II)
File Format:	Design rule for camera file system and DPOF compliant
Image Recording Format	Still images: JPEG (Exif 2.2)* ¹ or RAW Movies: AVI (Image data: Motion JPEG; Audio data: WAVE (monaural))
Compression:	Super fine, Fine, Normal
Number of Recording Pixels	Still images: Large: 3072 x 2304 pixels Medium 1: 2592 x 1944 pixels Medium 2: 2048 x 1536 pixels Medium 3: 1600 x 1200 pixels Small: 640 x 480 pixels Movies: 640 x 480 pixels (30 sec.)* 320 x 240 pixels (3 min.)* 160 x 120 pixels (3 min.)*  : 10 frames/second,   : 15 frames/second
	* The data in parentheses refer to the maximum movie length per shooting.
Playback Modes:	Single (histogram displayable), Index (9 thumbnail images), Magnified (approx. 10x (max.) in LCD monitor), Sound memos (up to 60 sec.) or Slide show.
Direct Print:	<i>Canon Direct Print/Bubble Jet Direct/PictBridge</i> compatible
Display Languages:	14 languages available for menus and messages (English, German, French, Dutch, Danish, Finnish, Italian, Norwegian, Swedish, Spanish, Chinese, Russian, Portuguese and Japanese)
My Camera Settings:	The start-up image, start-up sound, shutter sound, operation sound and self-timer sound can be customized using the following methods: 1. Using the images and sounds recorded on a camera. 2. Using downloaded data from your computer using the supplied software.

Interface:	USB (mini-B, PTP [Picture Transfer Protocol]) Audio/Video output (NTSC or PAL selectable, monaural audio)
Power Source:	1. Rechargeable lithium-ion battery (type: BP-511A) (included in the camera kit/sold separately) 2. Rechargeable lithium-ion battery (type: BP-511/512/514) (sold separately) 3. Compact Power Adapter (CA-560) (sold separately) 4. Car battery adapter (separately sold Charge Adapter/Car Battery Cable Kit CR-560 is required)
Operating Temperature:	0 – 40 °C (32 – 104 °F)
Operating Humidity:	10 – 90%
Dimensions:	104.9 x 72.8 x 73.1 mm (4.1 x 2.9 x 2.9 in.) (Excluding protrusions)
Weight:	Approx. 380 g (13.4 oz.) (camera body only)

*1 This digital camera supports Exif 2.2 (also called “Exif Print”). Exif Print is a standard for enhancing the communication between digital cameras and printers. By connecting to an Exif Print-compliant printer, the camera’s image data at the time of shooting is used and optimized, yielding extremely high quality prints.

Battery Performance

	Number of Images Shot		Playback Time
	Based on the CIPA standard	LCD Monitor Off	
Battery Pack BP-511A (Fully charged)	Approx. 300 images	Approx. 900 images	Approx. 400 minutes

- The actual figures will vary according to the shooting conditions and settings.
- Movie data is excluded.
- At low temperatures, the battery pack performance may diminish and the low battery icon appear very rapidly. In these circumstances, the performance can be improved by warming the battery pack in a pocket before use.

Test Conditions

Shooting: Normal temperature ($23\text{ }^{\circ}\text{C} \pm 2\text{ }^{\circ}\text{C}/73\text{ }^{\circ}\text{F} \pm 3.6\text{ }^{\circ}\text{F}$), normal relative humidity ($50\% \pm 20\%$), alternating wide angle end and telephoto end shots at 30 second intervals with the flash fired once every two shots and the camera power turned off after every tenth shot. Power is left off for a sufficient amount of time*, then the power is turned back on and the testing procedure is repeated.

- The included memory card is used.
- The LCD monitor is turned on for the CIPA standard.

* Until the battery returns to normal temperature

Playback: Normal temperature ($23\text{ }^{\circ}\text{C} \pm 2\text{ }^{\circ}\text{C}/73\text{ }^{\circ}\text{F} \pm 3.6\text{ }^{\circ}\text{F}$), normal relative humidity ($50\% \pm 20\%$), continuous playback at 3 seconds per image.



- *Battery Pack Handling Precautions (p. 19)*

CF Cards and Estimated Capacities (Recordable Images)



CF card included with the camera

		FC-32MH	FC-64MH	FC-128M	FC-256MH	FC-512MSH	
L (Large) 3072 x 2304 pixels		9	19	40	81	163	
		15	32	64	130	261	
		33	67	136	273	547	
M1 (Medium 1) 2592 x 1944 pixels		11	24	49	99	198	
		21	43	88	177	354	
		43	88	176	355	709	
M2 (Medium 2) 2048 x 1536 pixels		18	38	76	154	308	
		33	68	137	276	552	
		67	136	274	548	1096	
M3 (Medium 3) 1600 x 1200 pixels		30	61	122	246	491	
		54	109	219	440	879	
		107	217	435	868	1736	
S (Small) 640 x 480 pixels		119	241	482	962	1893	
		195	393	788	1563	3125	
		336	676	1355	2720	5209	
RAW*	3072 x 2304 pixels	3	7	16	33	68	
Movie	640 x 480 pixels		45 sec	92 sec	186 sec	374 sec	743 sec
	320 x 240 pixels		91 sec	183 sec	368 sec	735 sec	1453 sec
	160 x 120 pixels		241 sec	486 sec	973 sec	1954 sec	3906 sec

* The maximum number of images that can be recorded may be affected by the resolution of the JPEG thumbnails.







- The display panel can only display 3 digits. (Any value exceeding “999” will appear as “999”.)
- These figures reflect standard shooting conditions established by Canon. Actual totals may vary according to the subject, shooting conditions and shooting mode.
- The following are the maximum recording times for movie clips:

: 30 seconds, : 3 minutes*, : 3 minutes. The maximums in the chart reflect continuous shooting.

* These figures apply when using a CF card of 64MB or more.

- (Superfine), (Fine) and (Normal) indicate the relative compression ratio.
- Some CF cards are not sold in some regions.

Image File Sizes (Estimated)

Resolution		Compression		
				
L	(3072 x 2304 pixels)	3045 KB	1897 KB	902 KB
M1	(2592 x 1944 pixels)	2503 KB	1395 KB	695 KB
M2	(2048 x 1536 pixels)	1602 KB	893 KB	445 KB
M3	(1600 x 1200 pixels)	1002 KB	558 KB	278 KB
S	(640 x 480 pixels)	249 KB	150 KB	84 KB
RAW	(3072 x 2304 pixels)	7096 KB		
Movie	 (640 x 480 pixels)	660 KB/sec		
	 (320 x 240 pixels)	330 KB/sec		
	 (160 x 120 pixels)	120 KB/sec		

Battery Charger CG-580*

Input voltage:	AC 100 V – 240 V (50/60 Hz) 22 VA (100 V) – 30 VA (240 V)
Rated output:	DC 8.4 V, 1.2 A
Operating temperatures:	0 – 40 °C (32 – 104 °F)
Dimensions:	91 x 31 x 67 mm (3.6 x 1.2 x 2.6 in.)
Weight:	Approx. 115 g (4.1 oz.)

Battery Charger CB-5L*

Input voltage:	AC 100 V – 240 V (50/60 Hz)
Rated output:	DC 8.4 V
Operating temperatures:	0 – 40 °C (32 – 104 °F)
Dimensions:	67 x 32.3 x 91 mm (2.6 x 1.3 x 3.6 in.)
Weight:	Approx. 105 g (3.7 oz.)

* Sold separately in some regions.

Battery Pack BP-511A

Type:	Rechargeable lithium ion cell
Nominal voltage:	7.4 V
Nominal capacity:	1390 mAh
Charge cycles:	Approx. 300
Operating temperatures:	0 – 40 °C (32 – 104 °F)
Dimensions:	38 x 55 x 21 mm (1.5 x 2.2 x 0.8 in.)
Weight:	Approx. 82 g (2.9 oz.)

Wireless Controller WL-DC100

Power supply:	Lithium button battery CR2025
Operating temperatures:	0 – 40 °C (32 – 104 °F)
Dimensions:	35 x 6.5 x 56.6 mm (1.4 x 0.3 x 2.2 in.)
Weight:	Approx. 10 g (0.4 oz.)

CompactFlash™ Card

Card slot type:	Type I
Dimensions:	36.4 x 42.8 x 3.3 mm (1.4 x 1.7 x 0.1 in.)
Weight:	Approx. 10 g (0.4 oz.)

Compact Power Adapter CA-560 (Sold Separately)

Input voltage:	AC 100 – 240 V (50/60 Hz) 60 VA (100 V) – 75 VA (240 V)
Rated output:	DC 9.5 V/2.7 A
Operating temperatures:	0 – 40 °C (32 – 104 °F)
Dimensions:	57 x 28 x 104 mm (2.2 x 1.1 x 4.1 in.) (body only)
Weight:	Approx. 180 g (6.3 oz.)

Wide Converter WC-DC58N (Sold Separately)

Magnification:	Approx. 0.7x
Focal length:	Infinity
Lens configuration:	3 elements in 3 groups
Focusing range (from end of lens):	20 cm – infinity (7.9 in. – infinity) (when attached to a PowerShot G6 at wide angle end)
Thread diameter:	58 mm Standard filter threads (Conversion Lens Adapter LA-DC58D is required to install the lens on a PowerShot G6)
Dimensions:	Diameter: 94.5 mm (3.7 in.)/Length: 54.9 mm (2.2 in.)
Weight:	Approx. 275 g (9.7 oz.)

Tele-converter TC-DC58N (Sold Separately)

Magnification:	Approx. 1.75x
Focal length:	Infinity
Lens configuration:	3 elements in 3 groups
Focusing range (from end of lens):	160 cm – infinity (5.2 ft. – infinity) (when attached to PowerShot G6 at telephoto end)
Thread diameter:	58 mm Standard filter threads (Conversion Lens Adapter LA-DC58D is required to install the lens on a PowerShot G6)
Dimensions:	Diameter: 75 mm (3.0 in.)/Length: 50 mm (2.0 in.)
Weight:	Approx. 185 g (6.5 oz.)

Close-up Lens 250D (58 mm) (Sold Separately)

Focal length:	250 mm
Focusing range (from end of lens):	10 – 25 cm (3.9 – 9.8 in.) (when attached to PowerShot G6 at telephoto end)
Thread diameter:	58 mm Standard filter threads (Conversion Lens Adapter LA-DC58D is required to install the lens on a PowerShot G6)
Dimensions:	Diameter: 60 mm (2.4 in.)/Length: 12 mm (0.5 in.)
Weight:	Approx. 80 g (2.8 oz.)

A

- AEB Mode 101
- AE Lock 105
- AF-assist Beam 44, 49
- AF Frame 56, 89, 92
- AF Mode 49, 118
- Aperture-Priority AE 85
- Aperture Value 80, 82, 85, 87
- Automated Playback
 - (Slide Show) 50, 135
- Auto Mode 55
- Auto Power Down 52
- Auto Rotate 52, 121

B

- Battery
 - Battery pack change status . 22
 - Charging 18
 - Handling Precautions 19
 - Installing 21
 - Performance 196
 - Status 22
- Battery Cover 12, 21
- Beep 56
- Black and White Mode 99

C

- CF Card
 - Formatting 52
 - Handling Precautions 24
 - Installing 23
 - Recording Capacity 198
- CF Card Slot Cover 12, 23
- Close-up Lens 185
- Compact Power Adapter 189
- Compression 60
- Computer System
 - Requirements 152
- Continuous Shooting 48, 78
- Contrast 100

- Conversion Lens Adapter . . 182, 185
- Creative Zone 14
- Custom Settings 119

D

- Date Battery 191
- Date/Time 26, 52
- Default Setting 48, 54
- Design rule for
 - Camera File system 195
- Digital Zoom 42, 49, 77
- Display
 - Detailed 39
 - Off 52
 - Standard 38
- Display Panel 16, 167
- Distance Units of the
 - MF Indicator 52
- DPOF
 - Print Settings 144
 - Transfer Order (Image
 - Transmission Settings) . . 149

E

- Erasing 140
 - All Images 50, 140
 - Single Images 140
- Exposure Compensation 94

F

- FE Lock 107
- File Format 58, 62
- File Number 38, 52, 122
 - Reset 52, 122
- Flash
 - Exposure Compensation . . 109
 - Externally Mounted Flash . . 180
 - Flash Adjust 48, 109
 - Flash Output 109
 - Switching the Timing . . 48, 111

Focus Bracketing (Focus-BKT Mode)	103
Focus Lock	114
Formatting	52, 54, 141

H

Histogram	40
-----------------	----

I

Image Zone	14
Index Playback	126, 177
Indicator	12
Information View	34, 37, 177
Intervalometer	50, 112
ISO Speed	98

J

Jump	127
------------	-----

L

Landscape Mode	67
Language Settings	28, 52
LCD Monitor	33
Brightness	51
Lens Cap	25
Light Metering Modes	49, 92

M

Macro Mode	74
Macro Ring Lite	182
Macro Twin Lite	182
Magnifying Images	125, 177
Manual Exposure	87
Manual Focus	49, 115
Menu	
My Camera	53
Play	50
Rec.	48
Selecting Menus and Settings	45
Set up	51

Metering Mode	49, 92
MF-Point Zoom	49, 116
Mode Dial	14
Movie	72
Editing	130
Playback	128, 177
Resolution	60
Mute	51, 162
My Camera	161

N

ND Filter	49, 120
Night Scene Mode	68

O

Operation Sound	51, 53, 161
Overexposure Warning	40

P

Photo Effect	99
Playback	124
Auto Playback (Slide Show) ..	135
Movies	128, 177
Single Image	124
TV	160
Volume	51
Playback Mode	30, 32
Portrait Mode	67
Power/Mode Indicator	29
Power On/Off	29
Power Saving	31, 52
Pressing	
Fully	43
Halfway	43
Printing	
Print Order	50, 142
Print Style	146
Resetting	147
Selecting Images	144
Settings	144
Program AE	80

Protect 50, 139

R

RAW File Format 58, 60, 62

Red-eye Reduction 48, 65

Remote Sensor 11, 176

Reset 54

Reverse Display 33, 50

Review 49, 57, 58

Rotate 50, 132

S

Safety Shift 49, 82, 85, 86

Saturation 100

Save Settings 50

Self-Timer 48, 76

 Sound 51, 53, 161

Sharpness 100

Shooting

 Checking Images

 (Reviewing) 49, 57

 Using a TV for Viewing ... 160

Shooting Mode 30, 32

 Functions Available 206

Shutter Button 43, 176

Shutter Sound 43, 53, 56, 161

 Volume 51

Shutter Speed 80, 82, 85, 87

Shutter Speed-Priority AE 82

Single Image Playback 124

Slide Show 50, 135

 Play Time 137

 Repeat 137

 Selecting Images 136

 Starting 135

Slow Synchro 48, 66

Sound Memos 133

Speaker 11

Spot AE Point 92

Spot Metering 37, 49

Start-up Image 29, 53, 161

Start-up Sound 29, 51, 53, 161

Stitch Assist Mode 69, 70

Strap 25

Super Macro Mode 75

T

Tele-converter 185

Telephoto 42

Terminal Cover 19

Transfer Order (Image Transmission

 Settings) 51, 149

 Selecting Images 149

U

Using the Built-In Flash 64

V

Video System 52, 160

Viewfinder 12

Volume 51

W

White Balance 95

Wide Angle 42

Wide Converter 185

Wireless Controller 175

 Wireless Delay 49

Z

Zoom 42, 77, 125, 176

FCC Notice

Digital Camera, Model PC1089

This device complies with Part 15 of the FCC Rules. Operation is subject to the following two conditions;

- (1) this device may not cause harmful interference, and
- (2) this device must accept any interference received, including interference that may cause undesired operation.

Note: This equipment has been tested and found to comply with the limits for Class B digital devices, pursuant to Part 15 of the FCC rules. These limits are designed to provide reasonable protection against harmful interference in a residential installation. This equipment generates, uses and can radiate radio frequency energy and, if not installed and used in accordance with the instructions, may cause harmful interference to radio communications. However, there is no guarantee that interference will not occur in a particular installation. If this equipment does cause harmful interference to radio or television reception, which can be determined by turning the equipment off and on, the user is encouraged to try to correct the interference by one or more of the following measures:

- Reorient or relocate the receiving antenna.
- Increase the separation between the equipment and receiver.
- Connect the equipment into an outlet on a circuit different from that to which the receiver is connected.
- Consult the dealer or an experienced radio/TV technician for help.

The cables with the ferrite core provided with the digital camera must be used with this equipment in order to comply with Class B limits in subpart B of Part 15 on FCC rules.

Do not make any changes or modifications to the equipment unless otherwise specified in the manual. If such changes or modifications should be made, you could be required to stop operation of the equipment.

Canon U.S.A. Inc.

One Canon Plaza, Lake Success, NY 11042, U.S.A.

Tel No. (516) 328-5600

Canadian Radio Interference Regulations

This Class B digital apparatus complies with Canadian ICES-003.

Réglementation canadienne sur les interférences radio

Cet appareil numérique de la classe B est conforme à la norme NMB-003 du Canada.

Functions Available in Each Shooting Mode

This chart shows the functions available in each shooting mode. You can shoot with the settings saved in the **C1** or **C2** mode (p. 119).

		AUTO						P	Tv	Av	M	Reference Page
Resolution (Stills)	Large L	○*	○*	○*	○*	△*	-	○*	○*	○*	○*	60
	Medium 1 M1	○	○	○	○	△	-	○	○	○	○	
	Medium 2 M2	○	○	○	○	△	-	○	○	○	○	
	Medium 3 M3	○	○	○	○	△	-	○	○	○	○	
	Small S	○	○	○	○	△	-	○	○	○	○	
Resolution (Movies)	640 x 480	-	-	-	-	-	○	-	-	-	-	60
	320 x 240	-	-	-	-	-	○*	-	-	-	-	
	160 x 120	-	-	-	-	-	○	-	-	-	-	
Compression	Superfine	○	○	○	○	△	-	○	○	○	○	60
	Fine	○*	○*	○*	○*	△*	-	○*	○*	○*	○*	
	Normal	○	○	○	○	△	-	○	○	○	○	
File Format	JPEG	○	○	○	○	○	-	○*	○*	○*	○*	62
	RAW	-	-	-	-	-	-	○	○	○	○	
Flash	Auto	○*	○*	○	○*	-	-	○	-	-	-	64
	On	-	○	○	○	△	-	○	○	○	○	
	Off	○	○	○*	○*	△*	-	○*	○*	○*	○*	
Red-eye Reduction	○	○	○	○	△	-	○	○	○	○	65	
Slow Synchro	On	-	-	○	○	△	-	○	-	○	-	66
	Off	○	○	-	-	△*	-	○*	○	○*	○	
Flash Adjust	On	○	○	○	○	○	-	○	○*	○*	-	109
	Off	-	-	-	-	-	-	-	○	○	-	
Flash Sync	1st-curtain	○	○	○	○	○	-	○*	○*	○*	○*	111
	2nd-curtain	-	-	-	-	-	-	○	○	○	○	
Drive Mode	Single Shot	○*	○*	○*	○*	△*	○*	○*	○*	○*	○*	-
	Standard Continuous Mode	-	○	○	○	-	-	○	○	○	○	78
	High Speed Continuous Mode	-	○	○	○	-	-	○	○	○	○	
	Self-Timer (10 sec.)	○	○	○	○	○	○	○	○	○	○	76
	Self-Timer (2 sec.)	○	○	○	○	○	○	○	○	○	○	
Intervalometer	-	-	-	-	-	-	-	○	○	○	○	112
AF Frame	AiAF (Auto)	○*	○*	○*	○*	○*	○*	○	○	○	○	89
	Center Point	○	○	○	○	-	-	○*	○*	○*	○*	
	Manual	-	-	-	-	-	-	○	○	○	○	90
AF Frame (Macro Mode)	AiAF (Auto)	○	○	-	○	-	-	○	○	○	○	89
	Center Point	○*	○*	-	○*	○*	○*	○*	○*	○*	○*	
	Manual	-	-	-	-	-	-	○	○	○	○	90
AF Lock	-	○	○	○	○	○	○	○	○	○	115	
Manual Focus	-	○	○	○	○	○	○	○	○	○	115	
Macro Mode	○	○	-	○	○	○	○	○	○	○	74	
Super Macro Mode	-	-	-	-	-	-	-	○	○	○	○	75

		AUTO						P	Tv	Av	M	Reference Page
Safety Shift	On	-	-	-	-	-	-	-	○	○	-	86
	Off	-	-	-	-	-	-	-	○*	○*	-	
Digital Zoom	On	○	○	○	○	-	-	○	○	○	○	77
	Off	○*	○*	○*	○*	-	-	○*	○*	○*	○*	
Exposure Compensation			-	○	○	○	△	○	○	○	-	94
Light Metering System	Evaluative Metering	○	○	○	○	○	○	○*	○*	○*	○*	92
	Center-Weighted Averaging	-	-	-	-	-	-	○	○	○	○	
	Spot Metering	-	-	-	-	-	-	○	○	○	○	
	Center	-	-	-	-	-	-	○*	○*	○*	○*	
	AF Point	-	-	-	-	-	-	○	○	○	○	
AE Lock/FE Lock			-	-	-	-	-	-	○	○	-	105/107
Bracket	AEB	-	-	-	-	-	-	○	○	○	-	101
	Focus-BKT (1)	-	-	-	-	-	-	○(1)	○(1)	○(1)	○(1)	103
White Balance (2)			-(3)	○	○	○	△	○(4)	○	○	○	95
Photo Effect		-	○	○	○	○	△	○	○	○	○	99
Contrast/Sharpness/Saturation		-	-	-	-	-	-	○	○	○	○	
Focus settings	Continuous	○*	○*	○*	○*	△*	○	○*	○*	○*	○*	118
	Single	○	○	○	○	△	-	○	○	○	○	
ISO Speed			-(5)	-(5)	-(5)	-(5)	-(5)	○	○	○	○(6)	98
Reverse Display	On	○*	○*	○*	○*	-	○*	○*	○*	○*	○*	50
	Off	○	○	○	○	○	○	○	○	○	○	
Auto Rotate	On	○*	○*	○*	○*	△*	-	○*	○*	○*	○*	121
	Off	○	○	○	○	△	-	○	○	○	○	
ND Filter		-	-	-	-	-	-	○	○	○	○	120
JPEG Recording in RAW		-	-	-	-	-	-	○	○	○	○	62

* Default setting ○: Setting selection is possible. △: Setting can only be selected for the first image. -: Setting selection is not possible.

(Shaded Area): Setting remains in effect even when the camera is turned off.

The default for the settings changed by the menu and button operations can be restored all at once except for [Date/Time], [Language] and [Video System] (p. 54).

(1) Can only be used with manual focus.

(2) Cannot be adjusted when the photo effect is set to [Sepia] or [B/W].

(3) The white balance is set to [AUTO].

(4) The white balance [flash] cannot be set.

(5) The ISO speed is automatically set by the camera.

(6) ISO [AUTO] cannot be selected.