

RYOBI OPERATOR'S MANUAL **18 VOLT CORDLESS FLASHLIGHT** **MODEL NO. FL1800**

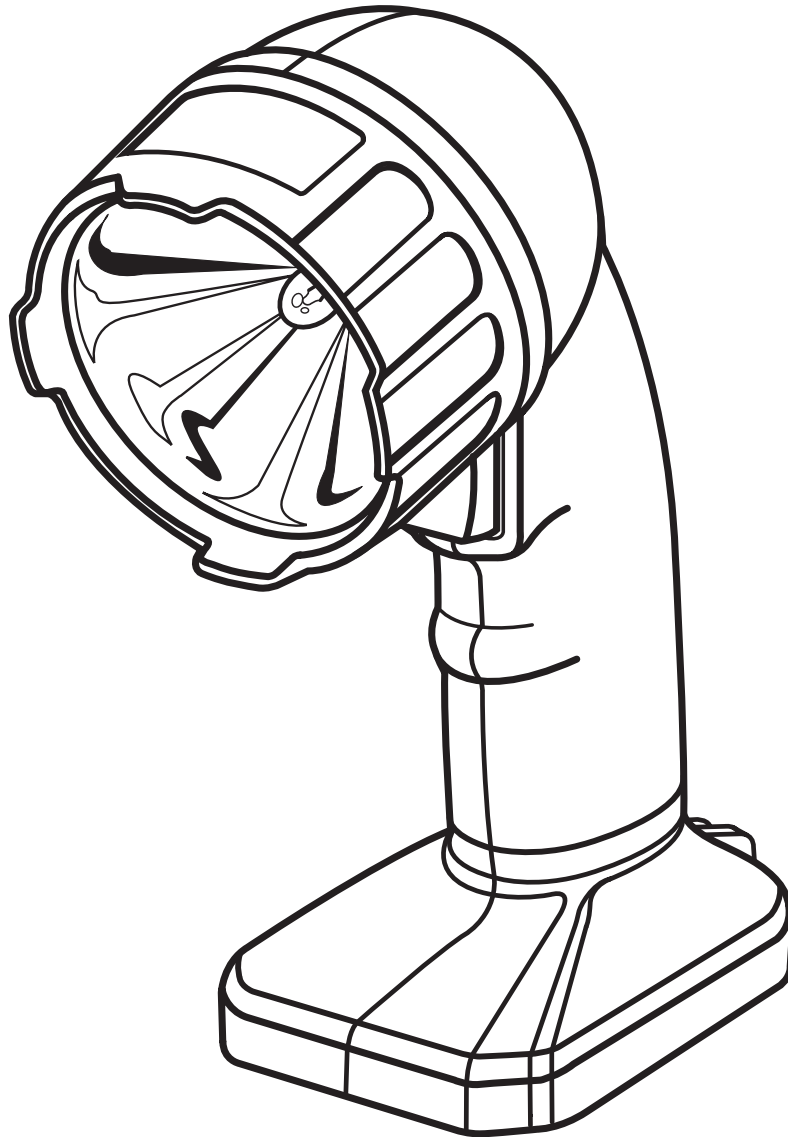

Your new cordless flashlight has been engineered and manufactured to Ryobi's high standard for dependability, ease of operation, and operator safety. Properly cared for, it will give you years of rugged, trouble-free performance.

⚠ WARNING: To reduce the risk of injury, the user must read and understand the operator's manual.

Thank you for buying a Ryobi flashlight.

SAVE THIS MANUAL FOR FUTURE REFERENCE

TABLE OF CONTENTS

■ General Safety Rule	2-3
■ Specific Safety Rules And/Or Symbols	3-4
■ Symbols	5
■ Operation	6-7
■ Maintenance	8
■ Parts Ordering / Service	10

GENERAL SAFETY RULES



WARNING:

Read and understand all instructions. Failure to follow all instructions listed below, can result in electric shock, fire and/or serious personal injury.

SAVE THESE INSTRUCTIONS

Work Area

- **Keep your work area clean and well lit.** Cluttered benches and dark areas invite accidents.
- **Do not operate power tools in explosive atmospheres, such as in the presence of flammable liquids, gases, or dust.** Power tools create sparks which may ignite the dust or fumes.
- **Keep bystanders, children, and visitors away while operating a power tool.** Distractions can cause you to lose control.

Electrical Safety

- **Do not abuse the cord. Never use the cord to carry the charger. Keep cord away from heat, oil, sharp edges, or moving parts. Replace damaged cords immediately.** Damaged cords may create a fire.
- **A battery operated tool with integral batteries or a separate battery pack must be recharged only with the specified charger for the battery.** A charger that may be suitable for one type of battery may create a risk of fire when used with another battery. Use battery only with charger listed.
- **Use battery operated tool only with specifically designated battery pack.** Use of any other batteries may create a risk of fire. Use only with battery pack listed.

Personal Safety

- **Stay alert, watch what you are doing and use common sense when operating a power tool. Do not use tool while tired or under the influence of drugs, alcohol, or medication.** A moment of inattention while operating power tools may result in serious personal injury.
- **Dress properly. Do not wear loose clothing or jewelry. Contain long hair. Keep your hair, clothing, and gloves away from moving parts.** Loose clothes, jewelry, or long hair can be caught in moving parts.
- **Avoid accidental starting. Be sure switch is in the locked or off position before inserting battery pack.** Carrying tools with your finger on the switch or inserting the battery pack into a tool with the switch on, invites accidents.
- **Remove adjusting keys or wrenches before turning the tool on.** A wrench or a key that is left attached to a rotating part of the tool may result in personal injury.
- **Do not overreach. Keep proper footing and balance at all times.** Proper footing and balance enable better control of the tool in unexpected situations. Do not use on a ladder or unstable support.
- **Use safety equipment. Always wear eye protection.** Dust mask, nonskid safety shoes, hard hat, or hearing protection must be used for appropriate conditions.

GENERAL SAFETY RULES

Tool Use and Care

- **Use clamps or other practical way to secure and support the workpiece to a stable platform.** Holding the work by hand or against your body is unstable and may lead to loss of control.
- **Do not force tool. Use the correct tool for your application.** The correct tool will do the job better and safer at the rate for which it is designed.
- **Do not use tool if switch does not turn it on or off.** A tool that cannot be controlled with the switch is dangerous and must be repaired.
- **Disconnect battery pack from tool before making any adjustments, changing accessories, or storing the tool.** Such preventive safety measures reduce risk of starting the tool accidentally.
- **Store idle tools out of reach of children and other untrained persons.** Tools are dangerous in the hands of untrained users.
- **When battery pack is not in use, keep it away from other metal objects like: paper clips, coins, keys, nails, screws, or other small metal objects that can make a connection from one terminal to another.** Shorting the battery terminals together may cause sparks, burns, or a fire.

- **Maintain tools with care. Keep cutting tools sharp and clean.** Properly maintained tools, with sharp cutting edges are less likely to bind and are easier to control.
- **Check for misalignment or binding of moving parts, breakage of parts, and any other condition that may affect the tool's operation. If damaged, have the tool serviced before using.** Many accidents are caused by poorly maintained tools.
- **Use only accessories that are recommended by the manufacturer for your model.** Accessories that may be suitable for one tool, may create a risk of injury when used on another tool.

Service

- **Tool service must be performed only by qualified repair personnel.** Service or maintenance performed by unqualified personnel could result in a risk of injury.
- **When servicing a tool, use only identical replacement parts. Follow instructions in the Maintenance section of this manual.** Use of unauthorized parts or failure to follow Maintenance Instructions may create a risk of shock or injury.

SPECIFIC SAFETY RULES AND/OR SYMBOLS

Hold tool by insulated gripping surfaces when performing an operation where the cutting tool may contact hidden wiring. Contact with a "live" wire will make exposed metal parts of the tool "live" and shock the operator.

Additional Rules For Safe Operation

- **Know your power tool. Read operator's manual carefully. Learn its applications and limitations, as well as the specific potential hazards related to this tool.** Following this rule will reduce the risk of electric shock, fire, or serious injury.

Important Rules for Battery Tools

- **USE ONLY THE CHARGER RECOMMENDED FOR USE WITH YOUR FLASHLIGHT.** Do not substitute any other charger. Use of another charger could cause batteries to explode causing possible serious injury.
- **Battery tools do not have to be plugged into an electrical outlet; therefore, they are always in operating condition. Be aware of possible hazards when not using your battery tool or when changing accessories.** Following this rule will reduce the risk of electric shock, fire, or serious personal injury.
- **Do not place battery tools or their batteries near fire or heat.** This will reduce the risk of explosion and possibly injury.
- **Do not charge battery tool in a damp or wet location.** Following this rule will reduce the risk of electric shock.
- **For best results, your battery tool should be charged in a location where the temperature is more than 50°F but less than 100°F. Do not store outside or in vehicles.**

- **Under extreme usage or temperature conditions, battery leakage may occur. If liquid comes in contact with your skin, wash immediately with soap and water, then neutralize with lemon juice or vinegar. If liquid gets into your eyes, flush them with clean water for at least 10 minutes, then seek immediate medical attention.** Following this rule will reduce the risk of serious personal injury.

WARNING:

Batteries vent hydrogen gas and can explode in the presence of a source of ignition, such as a pilot light. To reduce the risk of serious personal injury, never use any cordless product in the presence of open flame. An exploded battery can propel debris and chemical. If exposed, flush with water immediately.

WARNING:

Never use a battery pack that has been damaged or received a sharp blow. A damaged battery pack is subject to explosion. Properly dispose of a damaged battery pack immediately. Failure to heed this warning can result in serious personal injury.

SPECIFIC SAFETY RULES AND/OR SYMBOLS

Important Safety Instructions For Charger

- **Save these instructions. This manual contains important safety and operating instructions for charger.** Following this rule will reduce the risk of electric shock, fire, or serious personal injury.
- **Before using battery charger, read all instructions and cautionary markings in this manual, on battery charger, and product using battery charger.** Following this rule will reduce the risk of electric shock, fire, or serious personal injury.
- **To reduce risk of injury, charge only nickel-cadmium type rechargeable batteries. Other types of batteries may burst causing personal injury and damage.** Following this rule will reduce the risk of electric shock, fire, or serious personal injury.
- **Do not expose charger to wet or damp conditions.** Following this rule will reduce the risk of electric shock, fire, or serious personal injury.
- **Use of an attachment not recommended or sold by the battery charger manufacturer may result in a risk of fire, electric shock, or injury to persons.** Following this rule will reduce the risk of electric shock, fire, or serious personal injury.
- **To reduce risk of damage to charger body and cord, pull by charger plug rather than cord when disconnecting charger.** Following this rule will reduce the risk of electric shock, fire, or serious personal injury.
- **Make sure cord is located so that it will not be stepped on, tripped over, or otherwise subjected to damage or stress.** Following this rule will reduce the risk of serious personal injury.
- **An extension cord should not be used unless absolutely necessary.** Use of improper extension cord could result in a risk of fire and electric shock. If extension cord must be used, make sure:

- a. That pins on plug of extension cord are the same number, size and shape as those of plug on charger.
- b. That extension cord is properly wired and in good electrical condition; and
- c. That wire size is large enough for AC ampere rating of charger as specified below:

Cord Length (Feet)	25'	50'	100'
Cord Size (AWG)	16	16	16



Note: AWG = American Wire Gage

- **Do not operate charger with a damaged cord or plug. If damaged, have replaced immediately by a qualified serviceman.** Following this rule will reduce the risk of electric shock, fire, or serious personal injury.
- **Do not operate charger if it has received a sharp blow, been dropped, or otherwise damaged in any way; take it to a qualified serviceman.** Following this rule will reduce the risk of electric shock, fire, or serious personal injury.
- **Do not disassemble charger; take it to a qualified serviceman when service or repair is required. Incorrect reassembly may result in a risk of electric shock or fire.** Following this rule will reduce the risk of electric shock, fire, or serious personal injury.
- **To reduce the risk of electric shock, unplug charger from outlet before attempting any maintenance or cleaning. Turning off controls will not reduce this risk.** Following this rule will reduce the risk of electric shock, fire, or serious personal injury.
- **Disconnect charger from power supply when not in use.** Following this rule will reduce the risk of electric shock, fire, or serious personal injury.
- **Save these instructions. Refer to them frequently and use them to instruct others who may use this tool. If you loan someone this tool, loan them these instructions also.** Following this rule will reduce the risk of electric shock, fire, or serious personal injury.

SAVE THESE INSTRUCTIONS

SYMBOLS

Important: Some of the following symbols may be used on your tool. Please study them and learn their meaning. Proper interpretation of these symbols will allow you to operate the tool better and safer.

SYMBOL	NAME	DESIGNATION/EXPLANATION
V	Volts	Voltage
A	Amperes	Current
Hz	Hertz	Frequency (cycles per second)
min	Minutes	Time
~	Alternating Current	Type or a characteristic of current
==	Direct Current	Type or a characteristic of current
n_0	No Load Speed	Rotational speed, at no load
.../min	Revolutions or Reciprocation Per Minute	Revolutions, strokes, surface speed, orbits etc. per minute
	Safety Alert Symbol	Indicates danger, warning or caution. It means attention!!! Your safety is involved.
	Wet Conditions Alert	Do not expose to rain or use in damp locations.
	Hot Surface. Do Not Touch	This decal indicates HOT SURFACE. DO NOT TOUCH. Keep all body parts away from all hot surfaces.

The purpose of safety symbols is to attract your attention to possible dangers. The safety symbols, and the explanations with them, deserve your careful attention and understanding. The safety warnings do not by themselves eliminate any danger. The instructions or warnings they give are not substitutes for proper accident prevention measures.

SYMBOL MEANING



DANGER: Failure to obey a safety warning will result in serious injury to yourself or to others. Always follow the safety precautions to reduce the risk of fire, electric shock and personal injury.



WARNING: Failure to obey a safety warning can result in serious injury to yourself or to others. Always follow the safety precautions to reduce the risk of fire, electric shock and personal injury.



CAUTION: Failure to obey a safety warning may result in property damage or personal injury to yourself or to others. Always follow the safety precautions to reduce the risk of fire, electric shock and personal injury.

NOTE: Advises you of information or instructions vital to the operation or maintenance of the equipment.

OPERATION

CHARGING FLASHLIGHT

If your flashlight did not come in a cordless kit with other cordless products, a battery pack and charger were not included. If you need to purchase a battery pack, request recommended battery pack part number 1322401, 1323303, 130256001, 130224007 or 130255004. If you need to purchase a charger, request recommended charging assembly part number 1423701. If your flashlight came with a kit, use the battery pack and charger included with the kit.

TO CHARGE BATTERY PACK:

- Charge battery pack only with the charger recommended.
- **Make sure power supply is normal house voltage, 120 volts, 60 Hz, AC only.**
- Connect charger to power supply.



DANGER:

RISK OF ELECTRIC SHOCK. DO NOT TOUCH UNINSULATED PORTION OF OUTPUT CONNECTOR OR UNINSULATED BATTERY TERMINAL.

- Place battery pack in charger then press down on battery pack to be sure contacts on battery pack engage properly with charger contacts.
- Red light should turn on.
- When battery pack is fully charged, the red light will turn off and the green light will turn on.
- After normal usage, 1 hour of charging time is required to be fully charged. A minimum charge time of 1-1/2 hours is required to recharge a completely discharged battery pack.

LED FUNCTION OF CHARGER

LED WILL BE LIGHTED TO INDICATE STATUS OF CHARGER AND BATTERY PACK:

- Red LED lighted = Fast Charging Mode
- Green LED lighted = Fully Charged Battery Pack
- Yellow and Green LED Lighted = Control Charge or Defective Battery Pack.



WARNING:

Do not operate flashlight or charger near flammable liquids or in gaseous or explosive atmospheres. Internal sparks can ignite fumes.

TO INSTALL/REMOVE BATTERY PACK

See Figure 1.

- Begin with a fully charged battery pack.
- Orient battery pack so that raised rib on battery pack aligns with groove inside flashlight. Battery pack is designed to fit only one way in flashlight handle.
- Insert battery pack, making sure latches on each side of battery pack snap in place and battery pack is secure in flashlight before use. **NOTE:** When placing battery pack in your flashlight, be sure raised ribs on battery pack aligns with groove inside flashlight handle and latches snap into place properly. Improper insertion of battery pack can cause damage to internal components.
- To remove battery pack, locate latches on end of battery pack and depress to release battery pack from your flashlight.

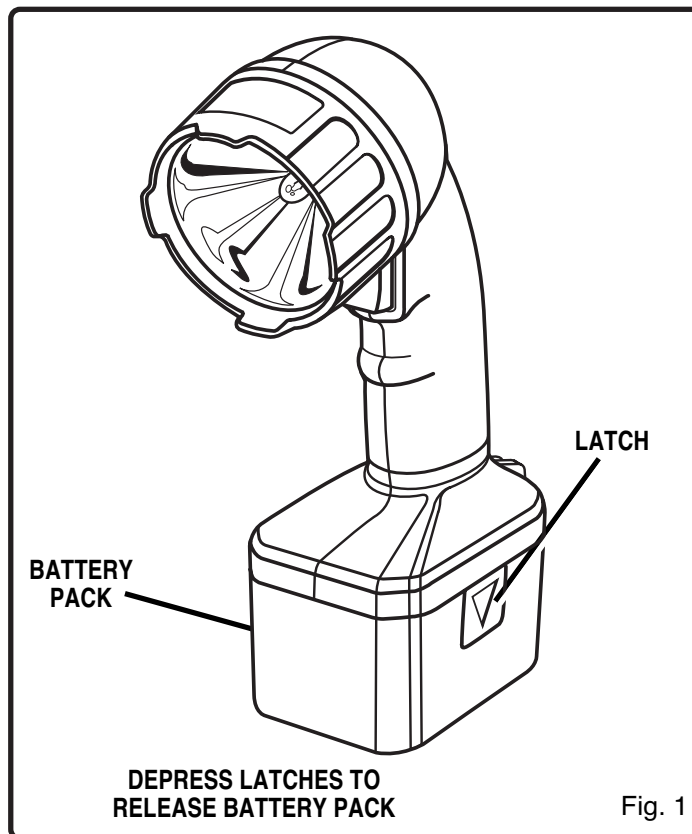

WARNING:

If wrapped or in contact with fabric, the flashlight lens can produce sufficient heat to melt some fabrics. To avoid serious personal injury, never allow the flashlight lens to come in contact with anything.

OPERATION

SWITCH

See Figure 2.

To turn your flashlight on and off, depress switch trigger.

180° ROTATING HEAD

See Figure 2.

Your flashlight has the feature of rotating the head 180° back and forth.

BULB REPLACEMENT

See Figure 3.

When purchasing replacement bulb, request recommended part number 780175002.

TO REPLACE BULB:

- Allow bulb to cool.
- Remove battery pack from flashlight.
- Remove lens cover by turning cover in counterclockwise direction, then remove cover.
- Remove old bulb from spring.
- Position new bulb in spring.
- Replace lens cover.
- Replace battery pack.

Note: For your convenience, your flashlight has a spare bulb storage area. It is located behind the lens cover. See Figure 3.

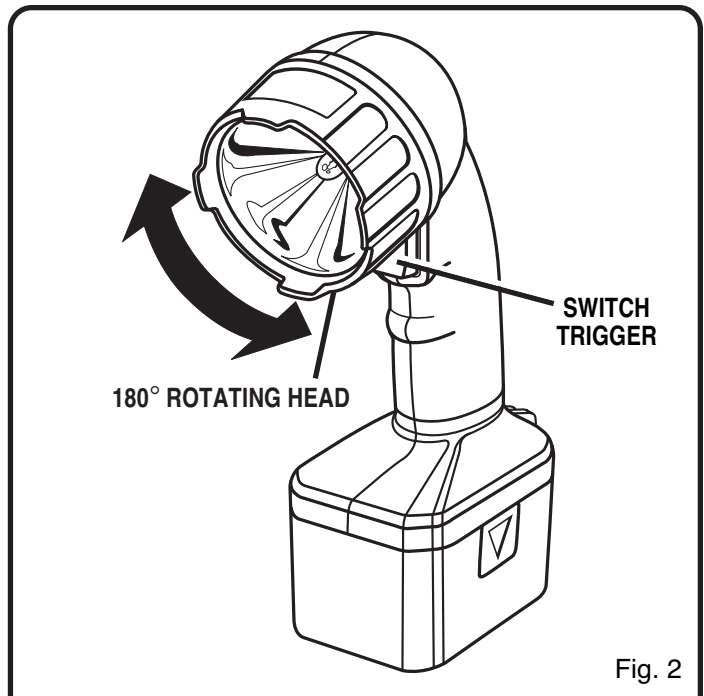

Fig. 2

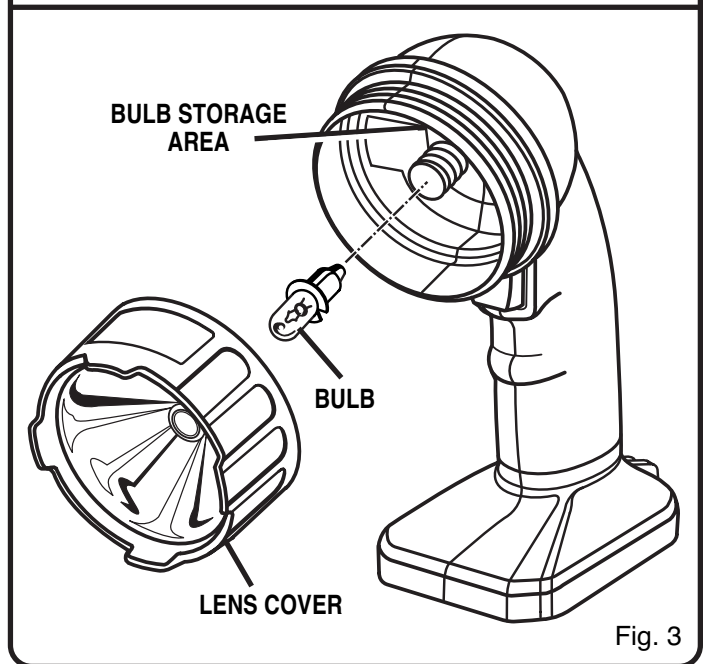

Fig. 3

⚠ WARNING:

Lens and bulb become hot during use:

- During or immediately after use, don't lay flashlight flat on lens surface or place lens area in contact with a plastic or fabric covered surface.
- Handle flashlight with care around any flammable surface.
- Let flashlight cool for several minutes after use before changing bulb.
- Do not use or permit use of flashlight in bed or sleeping bags. This flashlight lens can melt fabric and a burn injury could result.

MAINTENANCE

WARNING:

When servicing, use only identical replacement parts. Use of any other part can create a hazard or cause product damage.

WARNING:

Do not at any time let brake fluids, gasoline, petroleum-based products, penetrating oils, etc. come in contact with plastic parts. They contain chemicals that can damage, weaken or destroy plastic.

DO NOT abuse power tools. Abusive practices can damage tool as well as workpiece.

WARNING:

Do not attempt to modify this tool or create accessories not recommended for use with this tool. Any such alteration or modification is misuse and can result in a hazardous condition leading to possible serious personal injury.

BATTERIES

The battery pack for this flashlight is equipped with nickel-cadmium rechargeable batteries. Length of service from each charging will depend on the type of work you are doing.

The batteries in this battery pack have been designed to provide maximum trouble free life. However, like all batteries, they will eventually wear out. **DO NOT** disassemble battery pack and attempt to replace the batteries. Handling of these batteries, especially when wearing rings and jewelry, could result in a serious burn.

To obtain the longest possible battery life, we suggest the following:

- Store and charge your battery pack in a cool area. Temperatures above 100°F or below 50°F will shorten battery life.
- Never store battery pack in a discharged condition. Recharge battery pack if discharged.
- All batteries gradually lose their charge. The higher the temperature the quicker they lose their charge. If you store battery pack for long periods of time without using it, recharge the batteries every month or two. This practice will prolong battery life.

DISPOSAL OF THE EXHAUSTED BATTERY



To preserve natural resources, please recycle or dispose of properly.

This product uses nickel-cadmium batteries. Local, state or federal laws may prohibit disposal of nickel-cadmium batteries in ordinary trash.

Consult your local waste authority for information regarding available recycling and/or disposal options.

For more information on battery recycling call **1-800-8BATTERY**.

WARNING:

Upon removal, cover the battery pack's terminals with heavy duty adhesive tape. Do not attempt to destroy or disassemble battery pack or remove any of its components. Nickel-cadmium batteries must be recycled or disposed of properly. Also, never touch both terminals with metal objects and/or body parts as short circuit may result. Keep away from children. Failure to comply with these warnings can result in fire and/or serious injury.



OPERATOR'S MANUAL 18 VOLT CORDLESS FLASHLIGHT MODEL NO. FL1800

- **SERVICE**

Now that you have purchased your tool, should a need ever exist for repair parts or service, simply contact your nearest Ryobi Authorized Service Center. Be sure to provide all pertinent facts when you call or visit. Please call 1-800-525-2579 for your nearest Ryobi Authorized Service Center. You can also check our web site at www.ryobitools.com for a complete list of Authorized Service Centers.

- **MODEL NO. AND SERIAL NO.**

The model number of this tool will be found on a plate attached to the motor housing. Please record the serial number in the space provided below.

- **HOW TO ORDER REPAIR PARTS**

WHEN ORDERING REPAIR PARTS,
ALWAYS GIVE THE FOLLOWING INFORMATION:

- MODEL NUMBER **FL1800**
- SERIAL NUMBER _____

RYOBI TECHNOLOGIES, INC.

1428 Pearman Dairy Road, Anderson, SC 29625

Post Office Box 1207, Anderson, SC 29622-1207

Phone 1-800-525-2579

www.ryobitools.com