

CAMM-1
Desktop Sign Maker by Roland DG Corporation

CX-24/12

USER'S MANUAL

Thank you very much for purchasing the CX-24/12.

- To ensure correct and safe usage with a full understanding of this product's performance, please be sure to read through this manual completely and store it in a safe location.
- Unauthorized copying or transferral, in whole or in part, of this manual is prohibited.
- The contents of this operation manual and the specifications of this product are subject to change without notice.
- The operation manual and the product have been prepared and tested as much as possible. If you find any misprint or error, please inform us.
- Roland DG Corp. assumes no responsibility for any direct or indirect loss or damage which may occur through use of this product, regardless of any failure to perform on the part of this product.
- Roland DG Corp. assumes no responsibility for any direct or indirect loss or damage which may occur with respect to any article made using this product.

Contents

To Ensure Safe Use	3	7 Repeating the Same Cutting	39
About the Labels Affixed to the Unit	5	8 Cutting Printed Material	41
Pour utiliser en toute sécurité	6	8-1 Using Crop Marks	41
À propos des étiquettes collées sur l'appareil	8	8-2 Shape and Layout of Crop Marks	41
1 Checking Supplied Items	9	8-3 Loading the Material	42
2 Part Names and Functions	10	8-4 Performing Operations Using Crop Marks	43
2-1 Front View	10	8-5 When Crop Marks Cannot Be Read	49
2-2 Rear View	10	8-6 When the Printing and Cutting Locations Are Misaligned	50
2-3 Operation Panel	11	9 About the Blades and Materials	51
3 Preparing the CX-24/12	12	9-1 Blade and Material Combinations	51
3-1 Setting	12	9-2 About the Materials	52
3-2 Connection	13	10 Display Menu Descriptions	55
3-3 Installing the Driver	14	10-1 How to Read This Chapter	55
3-4 Port Setting	15	10-2 Display Menu Descriptions	55
4 Basic Operation	18	11 Display Menu Flowchart	63
4-1 Installing a Blade	18	12 What to Do If...	65
4-2 Loading the Material	19	12-1 If the CX-24/12 Doesn't Run...	65
4-3 Turning on the Power	22	12-2 The Material Slips Away from the Pinch Rollers During the Cutting Process	66
4-4 Checking Material Feed	24	12-3 Uncut Areas Remain, or Areas Are Not Cleanly Cut	67
4-5 When Performing Long Cutting	25	12-4 The Results of Cutting Are Displaced, and Uncut Portions Remain	67
4-6 Setting the Origin Point	26	12-5 Error Messages	68
4-7 Performing a Cutting Test (How to Adjust Blade Force/Adjusting the Cutter Blade)	27	13 Instruction Support Chart	70
4-8 Downloading Cutting Data	29	14 Specifications	71
4-9 Applying the Completed Cutout	34	Index	73
4-10 When Cutting Is Completed	36		
5 Performing a Self-Test	37		
6 Plotting on Paper Media	38		

Windows®, Windows NT® and MS-DOS are registered trademarks or trademarks of Microsoft® Corporation in the United States and/or other countries.

Macintosh is a registered trademark or trademark of Apple Computer, Inc. in the USA and other countries.



IBM is a registered trademark of International Business Machines Corporation.

Adobe Illustrator is a registered trademark or trademark of Adobe Systems Incorporated in the U.S.A. and other countries.



Adobe and Acrobat are trademarks of Adobe Systems Incorporated.

To Ensure Safe Use

About ⚠️ WARNING and ⚠️ CAUTION Notices

 WARNING	<p>Used for instructions intended to alert the user to the risk of death or severe injury should the unit be used improperly.</p>
 CAUTION	<p>Used for instructions intended to alert the user to the risk of injury or material damage should the unit be used improperly.</p> <p>* Material damage refers to damage or other adverse effects caused with respect to the home and all its furnishings, as well to domestic animals or pets.</p>

About the Symbols

	<p>The ⚠️ symbol alerts the user to important instructions or warnings. The specific meaning of the symbol is determined by the design contained within the triangle. The symbol at left means "danger of electrocution."</p>
	<p>The ⚡ symbol alerts the user to items that must never be carried out (are forbidden). The specific thing that must not be done is indicated by the design contained within the circle. The symbol at left means the unit must never be disassembled.</p>
	<p>The ● symbol alerts the user to things that must be carried out. The specific thing that must be done is indicated by the design contained within the circle. The symbol at left means the power-cord plug must be unplugged from the outlet.</p>

⚠️ WARNING



Do not disassemble, repair, or modify.

Doing so may lead to fire or abnormal operation resulting in injury.



Ground the unit with the ground wire.

Failure to do so may result in risk of electrical shock in the even of a mechanical problem



Do not use with any electrical power supply that does not meet the ratings displayed on the unit.

Use with any other power supply may lead to fire or electrocution.



Do not use while in an abnormal state (i.e., emitting smoke, burning odor, unusual noise, or the like).

Doing so may result in fire or electrical shock.

Immediately switch off the power, unplug the power cord from the electrical outlet, and contact your authorized Roland dealer or service center.



Use only with the power cord included with this product

Use with other than the included power cord may lead to fire or electrocution.

⚠ CAUTION



Do not use with a damaged power cord or plug, or with a loose electrical outlet.

Use with any other power supply may lead to fire or electrocution.

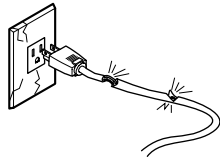

Do not injure or modify the electrical power cord, nor subject it to excessive bends, twists, pulls, binding, or pinching, nor place any object of weight on it.

Doing so may damage the electrical power cord, leading to electrocution or fire.

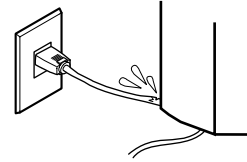

When not in use for extended periods, unplug the power cord from the electrical outlet.

Failure to do so may result in danger of shock, electrocution, or fire due to deterioration of the electrical insulation.

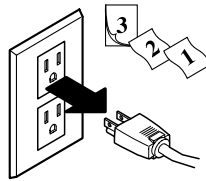

When unplugging the electrical power cord from the power outlet, grasp the plug, not the cord.

Unplugging by pulling the cord may damage it, leading to fire or electrocution.

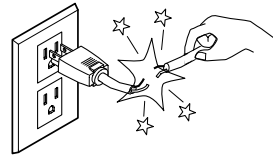

Do not attempt to unplug the power cord with wet hands.

Doing so may result in electrical shock.

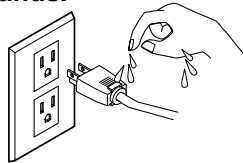

Do not allow liquids, metal objects or flammables inside the machine.

Such materials can cause fire.

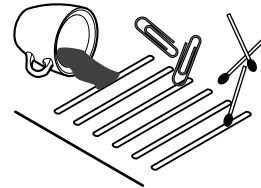

Install on a stable surface.

Failure to do so may result in falling of the unit, leading to injury.

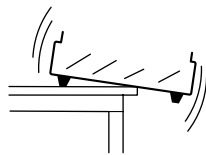

Do not touch the tip of the blade with your fingers.

Doing so may result in injury.



Do not place the hands or anything else on the platen when switching on the power.

Doing so may result in injury. (The cutting carriage moves simultaneously when the power is switched on.)



Do not place hands near the platen while in operation.

Doing so may result in injury.

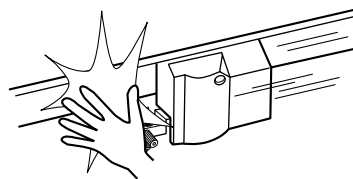

About the Labels Affixed to the Unit

These labels are affixed to the body of this product.
The following figure describes the location and content of these messages.

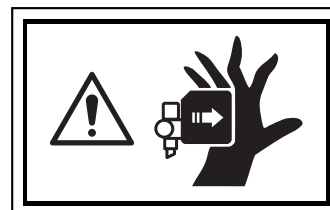
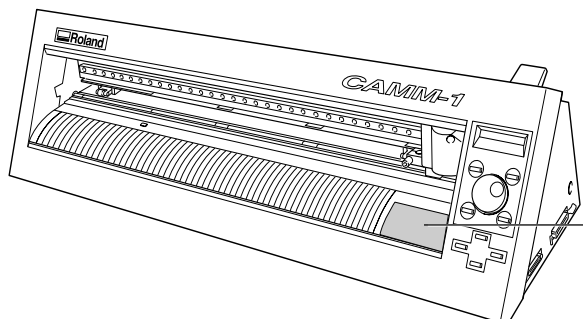

Do not place hands near the platen while in operation.

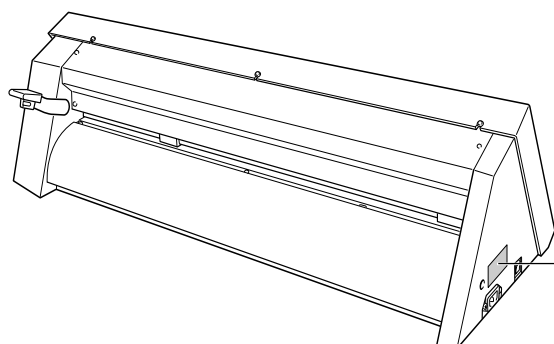

Model name
Rating label
Use a rated power supply.

In addition to the **⚠ WARNING** and **⚠ CAUTION** symbols, the symbols shown below are also used.



NOTICE : Indicates information to prevent machine breakdown or malfunction and ensure correct use.









: Indicates a handy tip or advice regarding use.

Pour utiliser en toute sécurité

Avis sur les avertissements

 ATTENTION	Utilisé pour avertir l'utilisateur d'un risque de décès ou de blessure grave en cas de mauvaise utilisation de l'appareil.
 PRUDENCE	Utilisé pour avertir l'utilisateur d'un risque de blessure ou de dommage matériel en cas de mauvaise utilisation de l'appareil. * Par dommage matériel, il est entendu dommage ou tout autre effet indésirable sur la maison, tous les meubles et même les animaux domestiques.

À propos des symboles

	Le symbole  attire l'attention de l'utilisateur sur les instructions importantes ou les avertissements. Le sens précis du symbole est déterminé par le dessin à l'intérieur du triangle. Le symbole à gauche signifie "danger d'électrocution".
	Le symbole  avertit l'utilisateur de ce qu'il ne doit pas faire, ce qui est interdit. La chose spécifique à ne pas faire est indiquée par le dessin à l'intérieur du cercle. Le symbole à gauche signifie que l'appareil ne doit jamais être démonté.
	Le symbole  prévient l'utilisateur sur ce qu'il doit faire. La chose spécifique à faire est indiquée par le dessin à l'intérieur du cercle. Le symbole à gauche signifie que le fil électrique doit être débranché de la prise.

ATTENTION



Ne pas démonter, réparer ou modifier.

Le non-respect de cette consigne pourrait causer un incendie ou provoquer des opérations anormales entraînant des blessures.



Mettre l'appareil à la masse avec une prise de terre.

Le non-respect de cette consigne pourrait entraîner des décharges électriques en cas de problème mécanique.



Ne pas utiliser avec une alimentation électrique non conforme à la norme indiquée sur l'appareil.

Une utilisation avec toute autre alimentation électrique pourrait provoquer un incendie ou une électrocution.



Ne pas utiliser si l'appareil est dans un état anormal (c'est-à-dire s'il y a émission de fumée, odeur de brûlé, bruit inhabituel etc.).

Le non-respect de cette consigne pourrait provoquer un incendie ou des décharges électriques.

Éteindre l'appareil immédiatement, débrancher le fil électrique de la prise et communiquer avec le revendeur autorisé Roland ou le centre de service.



Utiliser l'appareil uniquement avec le fil électrique fourni.

Utiliser l'appareil avec un autre fil risque de provoquer un incendie ou une électrocution.

⚠️ PRUDENCE



Ne pas utiliser avec une fiche ou un fil électrique endommagé ou avec une prise mal fixée.

Une négligence à ce niveau pourrait provoquer un incendie ou une électrocution.

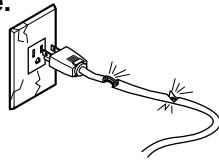

Ne pas endommager ou modifier le fil électrique. Ne pas le plier, le tordre, l'étirer, l'attacher ou le serrer de façon excessive. Ne pas mettre d'objet ou de poids dessus.

Une négligence à ce niveau pourrait endommager le fil électrique ce qui risquerait de provoquer une électrocution ou un incendie.

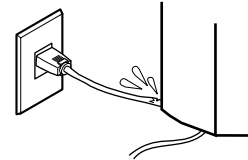

Débrancher le fil lorsque l'appareil reste inutilisé pendant une longue période.

Une négligence à ce niveau pourrait provoquer des décharges électriques, une électrocution ou un incendie dû à une détérioration de l'isolation électrique.

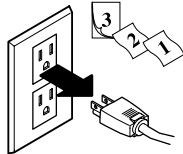

Saisir la fiche et non le fil électrique lorsque vous débranchez.

Débrancher en tirant sur le fil pourrait l'endommager et risquer de provoquer un incendie ou une électrocution.

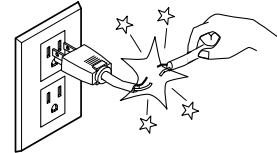

Ne pas essayer de débrancher le fil avec des mains mouillées.

Une négligence à ce niveau pourrait provoquer des décharges électriques.

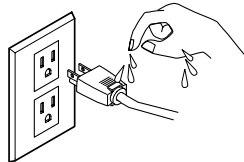

Ne pas introduire de liquide, d'objet métallique ou inflammable dans l'appareil.

Ce genre de matériel peut provoquer un incendie.

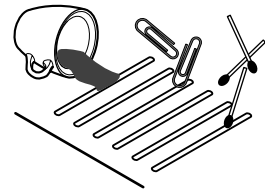

Installer l'appareil sur une surface stable.

Une négligence à ce niveau pourrait provoquer la chute de l'appareil et entraîner des blessures.

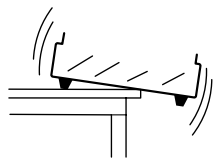

Ne pas toucher l'extrémité de la lame avec les doigts.

Une négligence à ce niveau pourrait provoquer des blessures.



Ne pas mettre les mains ni quoi que ce soit sur le coulisseau au moment de mettre sous tension.

Une négligence à ce niveau peut provoquer des blessures.

(Le chariot de coupe se déplace lorsque l'appareil est mis sous tension.)

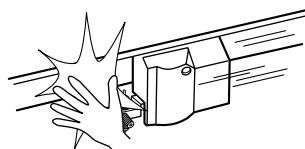

Ne pas mettre les mains près du coulisseau pendant le fonctionnement de l'appareil.

Une négligence à ce niveau peut provoquer des blessures.

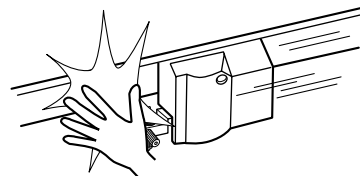

À propos des étiquettes collées sur l'appareil

Ces étiquettes sont collées à l'extérieur de l'appareil.
Les dessins suivants indiquent l'endroit et le contenu des messages.

Avant

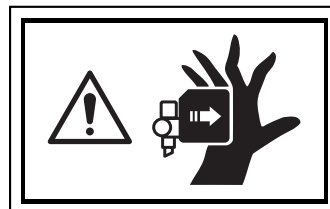
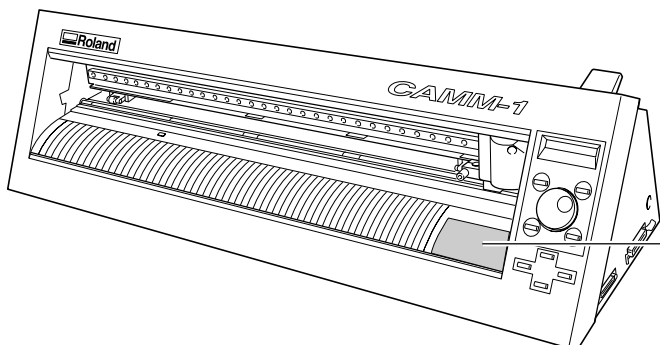

N'approchez pas vos mains du plateau de travail quand le chariot est en mouvement.

Arrière

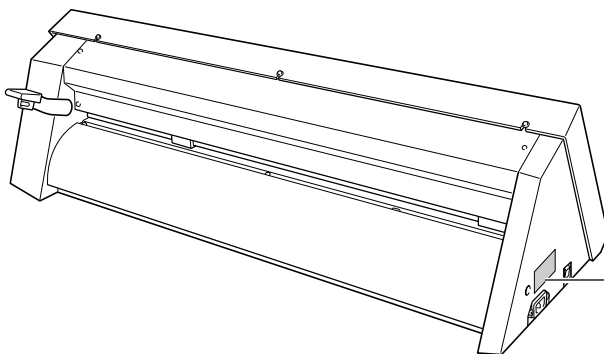

Nom du modèle
Étiquette des caractéristiques électriques
Utiliser l'alimentation appropriée

1 Checking Supplied Items

This product includes the items shown below.
Before starting use, make sure all the items are present.

Power cord: 1

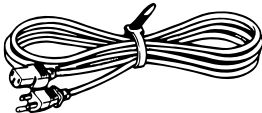

Roland Software Package
CD-ROM: 1

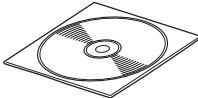

Roller base: 1

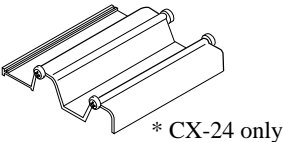

Blade: 1



Blade holder
(XD-CH3) : 1

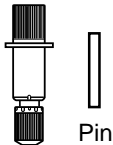

Startup manual: 1

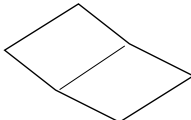

To Ensure Safe Use: 1

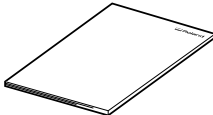

2 Part Names and Functions

In explanations that are common for both the CX-24 and the CX-12, figures depicting the CX-24 are used.

2-1 Front View

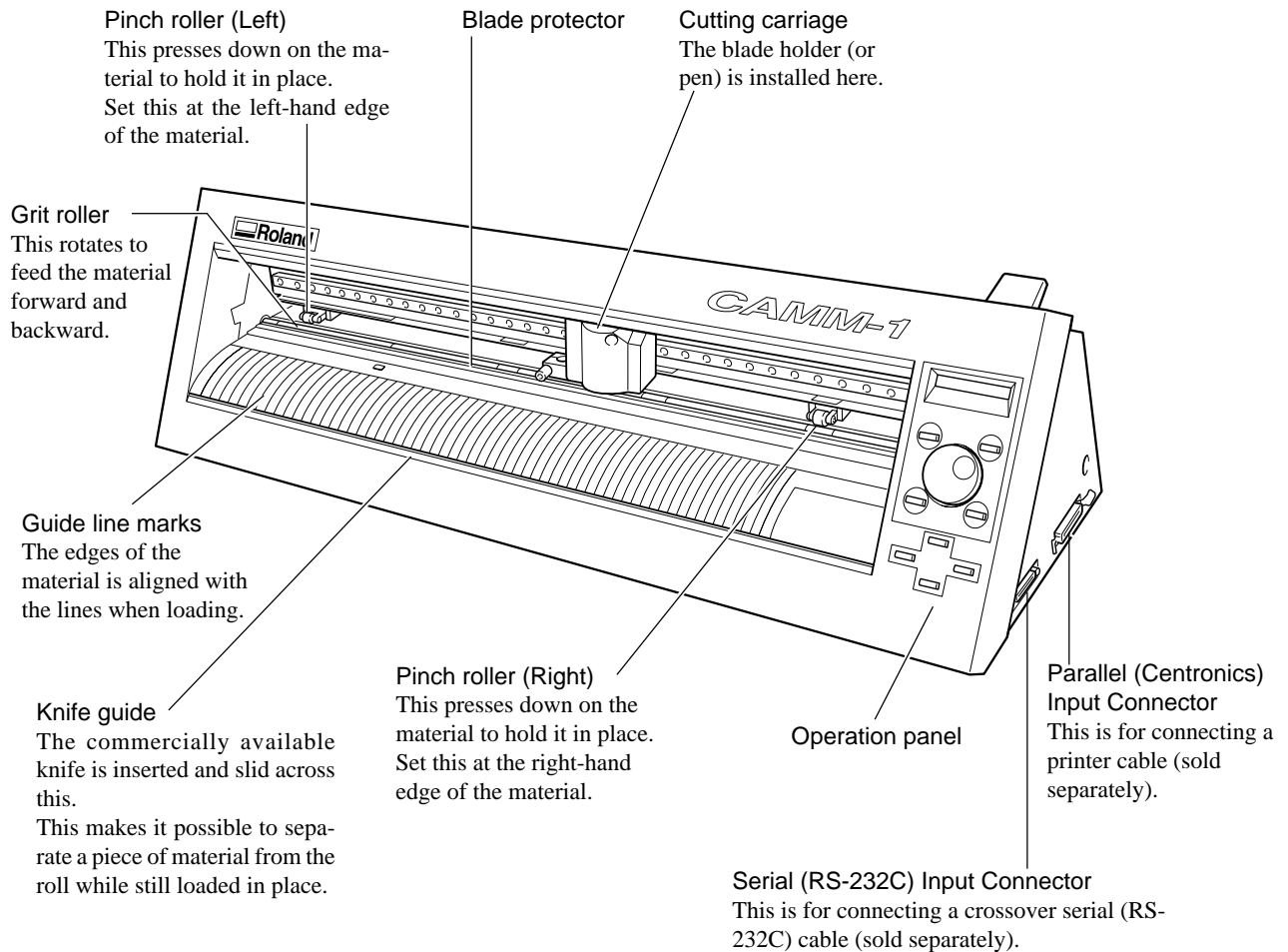

2-2 Rear View

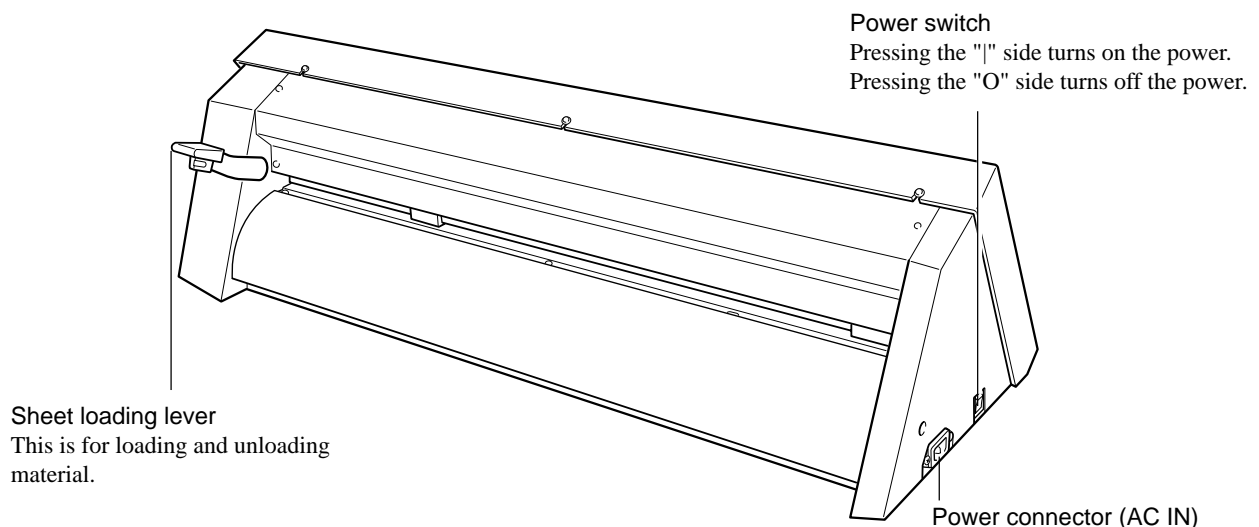

2-3 Operation Panel

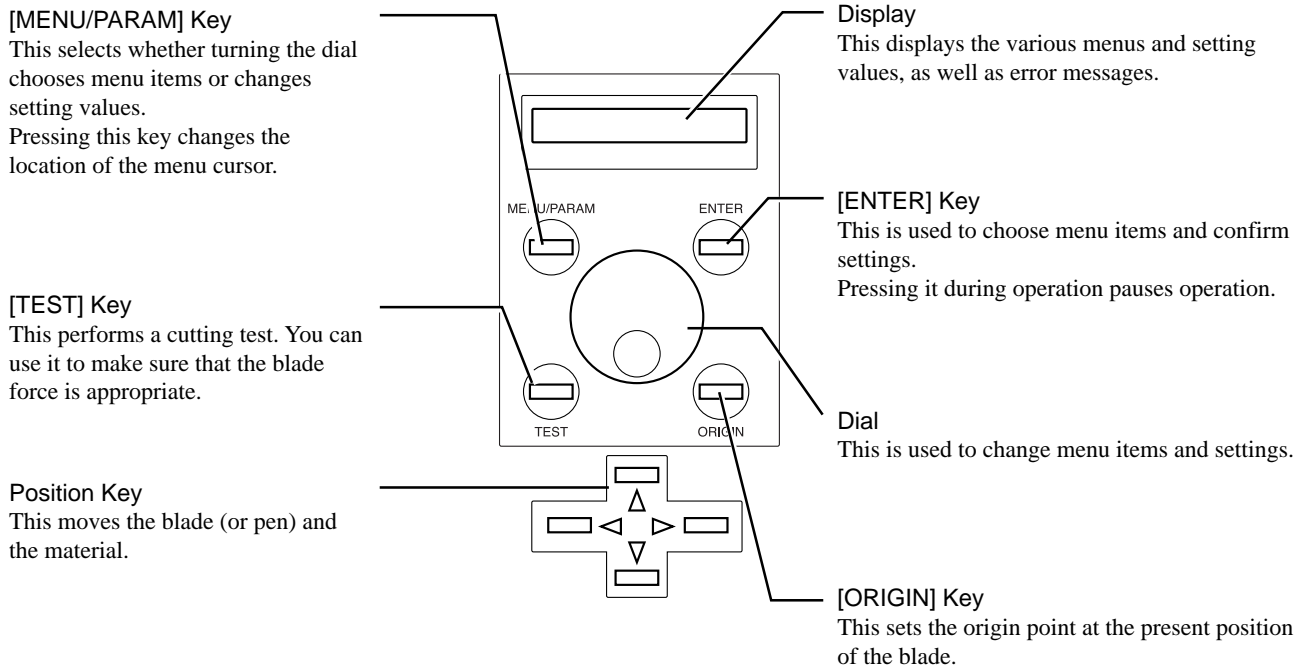

3 Preparing the CX-24/12

3-1 Setting

⚠ WARNING



Ground the unit with the ground wire.
Failure to do so may result in risk of electrical shock in the even of a mechanical problem



Do not use with any electrical power supply that does not meet the ratings displayed on the unit.
Use with any other power supply may lead to fire or electrocution.



Use only with the power cord included with this product
Use with other than the included power cord may lead to fire or electrocution.

⚠ CAUTION



Install on a stable surface.
Failure to do so may result in falling of the unit, leading to injury.

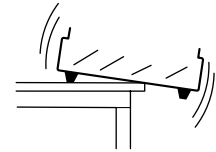

NOTICE

When moving the machine, do not attempt to lift or carry it by grasping the top portion of the machine. Lift and carry the machine by holding it with your hands along the left and right sides of the machine.

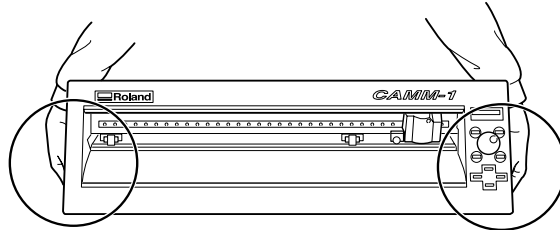

Never install this unit in any of the following situations, as it could result in breakdown or faulty operation:

- Places where the installation surface is unstable or not level.
- Places with excessive electrical noise.
- Places with excessive humidity or dust.
- Places with poor ventilation, because the CX-24/12 generates considerable heat during operation.
- Places with excessive vibration.
- Places exposed to strong illumination or direct sunlight.
- Install at least 1 m (39-3/8 in.) away from a strong indoor lighting source.

Make sure the unit is placed on a stable, sturdy surface.
Installing requires the space shown below.

CX-24

950 mm (37-7/16 in.) wide, 500 mm (19-11/16 in.) in depth, and 300 mm (11-13/16 in.) in height.

CX-12

650 mm (25-5/8 in.) wide, 500 mm (19-11/16 in.) in depth, and 300 mm (11-13/16 in.) in height.

The material moves during cutting. Do not place obstacles that may obstruct the material at the front and rear of the machine.

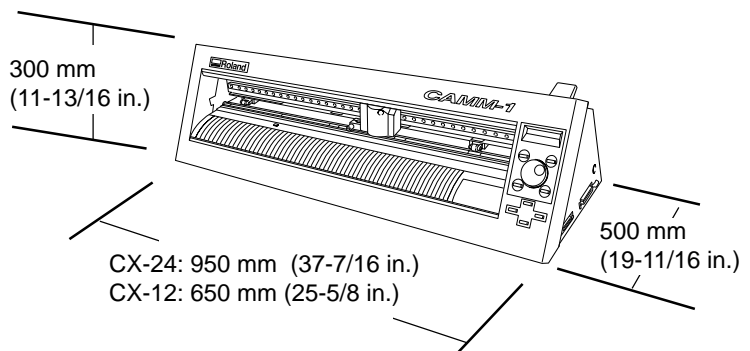

3-2 Connection

NOTICE Connect the cable to either the parallel or the serial port. Be sure that the power to both the computer and the main unit is switched off when connecting the cable.

Securely connect the power cord, computer I/O cable and so on so that they will not be unplugged and cause failure during operation. Doing so may lead to faulty operation or breakdown.

■ For IBM PC or PC Compatibles

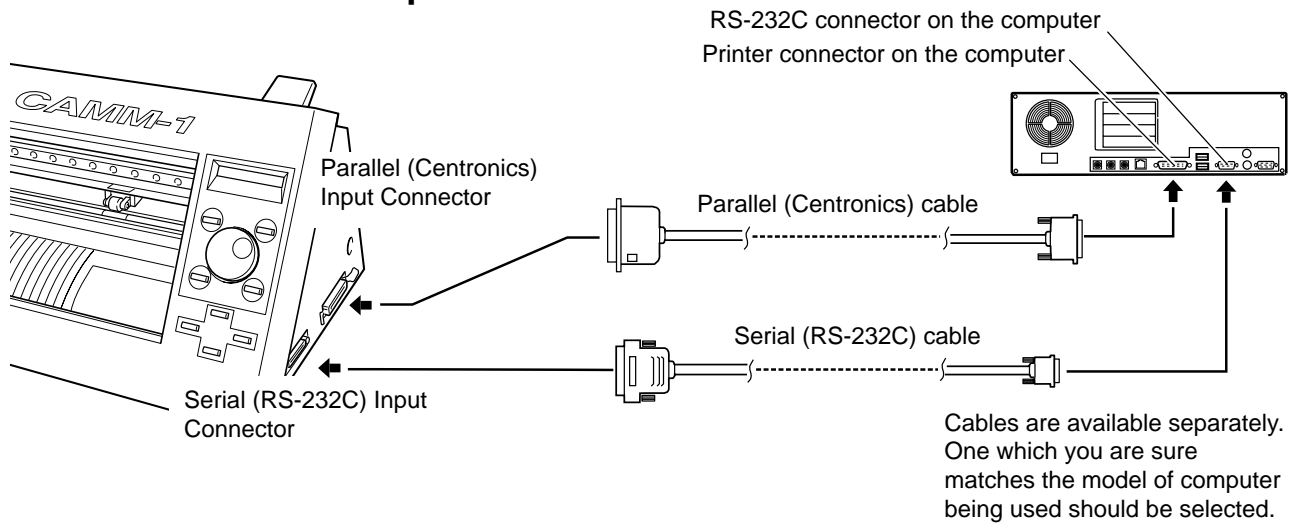

■ For Macintosh

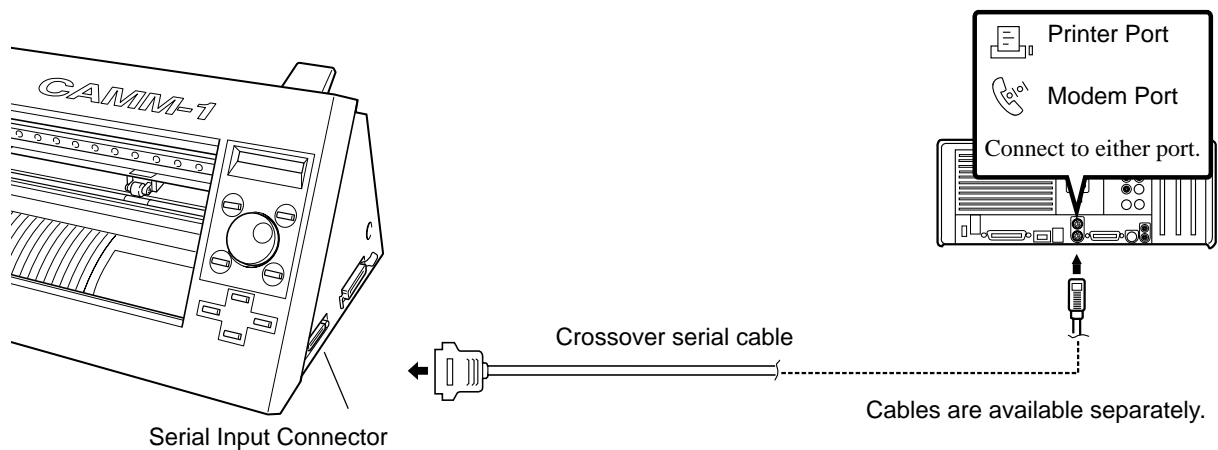

■ Connecting the Power Cord

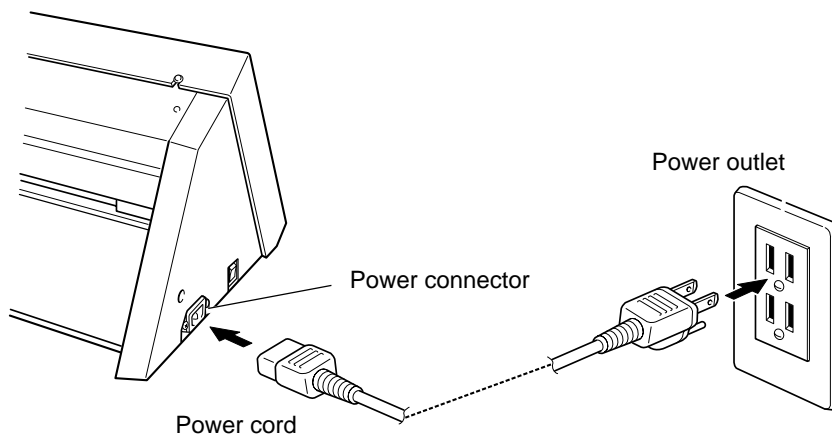

3-3 Installing the Driver

The included Roland Software Package CD-ROM contains a Windows-based program and driver for performing cutting with the CX-24/12.

CAMM-1 DRIVER

This software is required when sending data from a Windows-based program to the CX-24/12. If you're using Windows, be sure to install this driver.

Refer to the included Startup Manual and install them on your computer.

3-4 Port Setting

The CX-24/12 automatically detects the port used for connection to the computer.

However, if cutting data is not sent correctly, check the communication parameters for the driver and use the display menu on the CX-24/12 to make the same settings as for the driver.

■ Checking the Communication Parameters for the Port and Driver - Windows 95/98/Me

- 1 Click [Start].
Point to [Settings] and click [Printers].
The [Printers] folder appears.

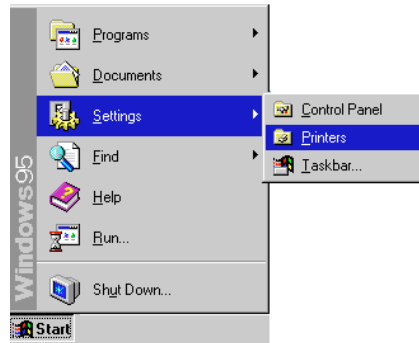

- 2 Right-click on the icon for the driver of the model you're using then click [Properties].
The [Roland CAMM-1 CX** **Properties] dialog box appears.

For the CX-24:

[Roland CAMM-1 CX-24]

For the CX-12:

[Roland CAMM-1 CX-12]

The Properties dialog box for the model you're using appears.

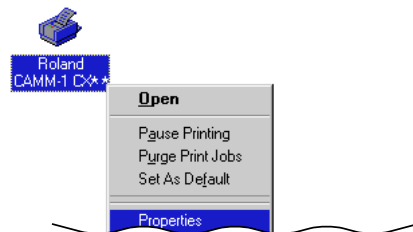

- 3 Make sure the port connected to the CX-24/12 appears under [Print to the following port].
When the connection uses a serial cable, click [Port Settings].
The Properties dialog box for the connected port appears.

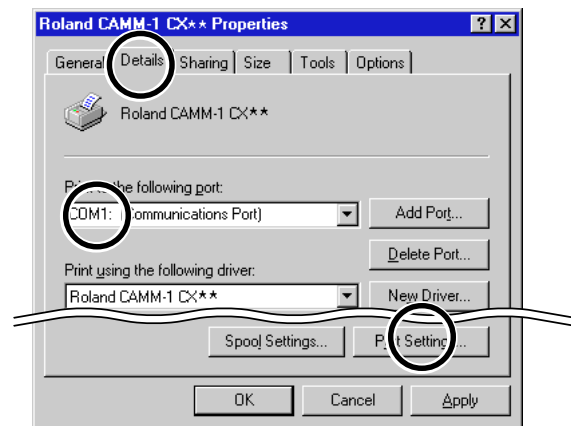

- 4 Check the communication parameters for the driver.

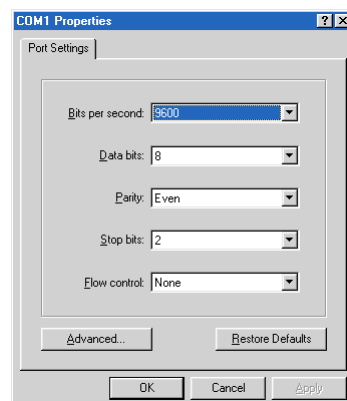

■ Checking the Communication Parameters for the Port and Driver - Windows NT 4.0/2000/XP

If you are installing under Windows 2000/XP or Windows NT 4.0, you need full access permissions for the printer settings. Log on to Windows as a member of the "Administrators" or "Power Users" group. (For more information about groups, refer to the documentation for Windows.) The descriptions of the following procedures use screen shots from Windows 2000.

- 1 Click [Start].
Point to [Settings] and click [Printers].
If you're using Windows XP, click [Start]-[Control Panel] and then click [Printers and Other Hardware]-[Printers and Faxes].
The [Printers] folder appears.
- 2 Right-click on the icon for the driver of the model you're using then click [Properties].
For the CX-24:
 [Roland CAMM-1 CX-24]
For the CX-12:
 [Roland CAMM-1 CX-12]
The Properties dialog box for the model you're using appears.

- 3 Click the [Ports] tab. Make sure the port connected to the CX-24/12 appears under [Print to the following port].
When the connection uses a serial cable, click [Configuration Port].
If you're using Windows 2000/XP, the Properties dialog box for the connected port appears. Skip to step 5.
If you're using Windows NT 4.0, the [Serial Port] dialog box appears. Go to step 4.

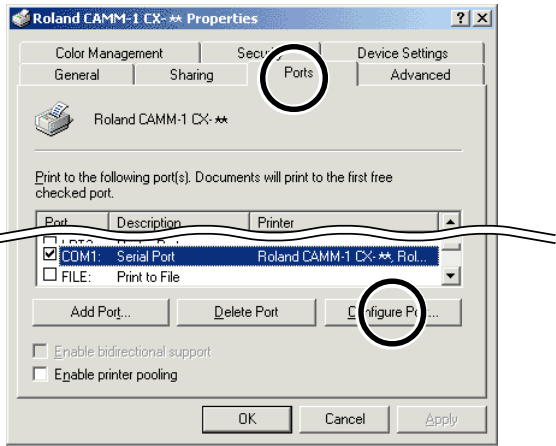

- 4 Click the port you chose in step 3, then click [Settings].
The dialog box for the connected port appears.

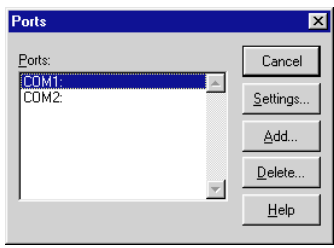

- 5 Check the communication parameters for the driver.

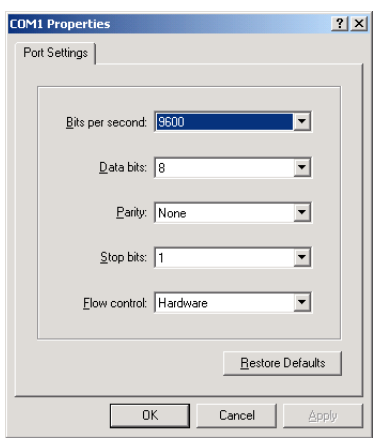

■ Making the Settings from the Menu on the CX-24/12

The display menu can only be used to make settings when material is loaded and set up. Before attempting to make menu settings, refer to "4-3 Turning on the Power" and put the CX-24/12 in a setup state.

- 1** Turn the dial to display the screen shown at right. Press the [MENU/PARAM] key.

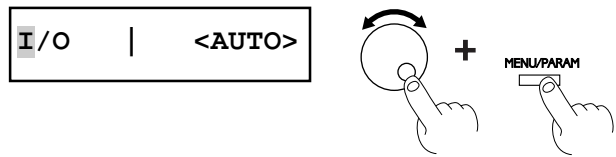

- 2** Turn the dial to display the port where the cable is connected, then press the [ENTER] key to confirm the setting.

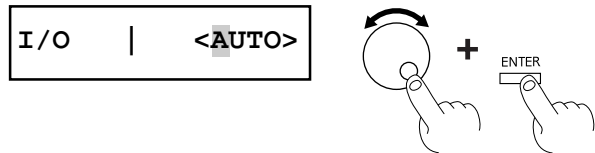

- 3** If you chose [SERIAL] in step 2, the screen for setting the bit rate appears. Turning the dial clockwise successively displays the screens for setting the bit rate, data bit, stop bit, parity checking, and hardware handshaking (flow control). Turning the dial counterclockwise returns to the menu in step 1 without making any changes. At the screen where the setting items are displayed, you can change the setting values by pressing the [MENU/PARAM] key and turning the dial. For more information about how to make settings, see "4-3 Turning on the Power - ■ Making Menu Settings with the Control Panel."

Back to the screen in step 1

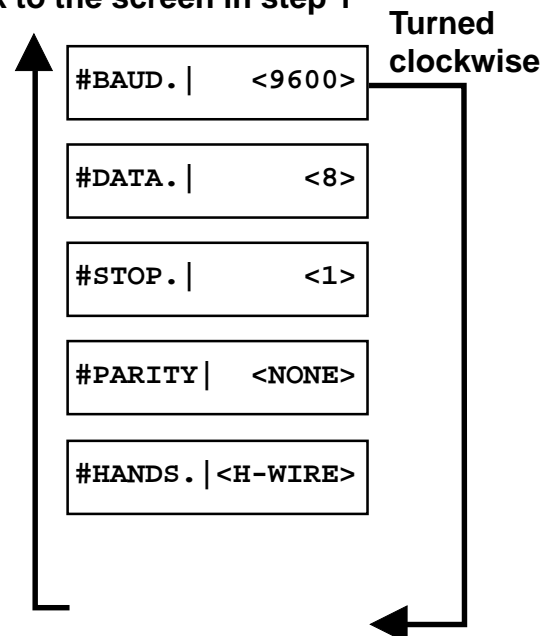

Turned counterclockwise

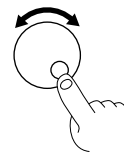

4 Basic Operation

4-1 Installing a Blade

CAUTION

 Do not touch the tip of the blade with your fingers. Doing so may result in injury.



NOTICE Be sure to support the tool mounting screw from below when installing the blade holder. Cutting quality may become poor if installed without supporting the screw in this way.

1 Insert a pin into the blade holder.

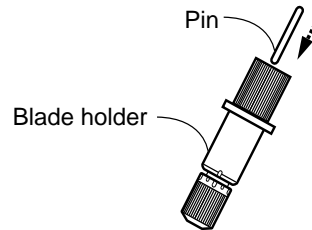

2 Insert a blade into the blade holder.

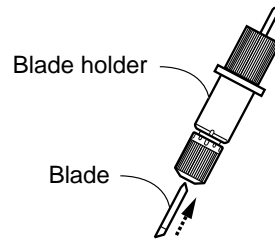

3 Loosen the screw shown in the figure.

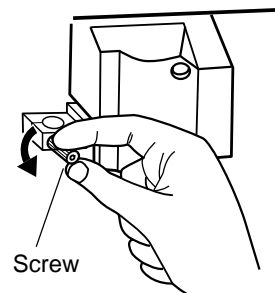

- 4** While supporting the screw from below, insert into the blade holder from above.

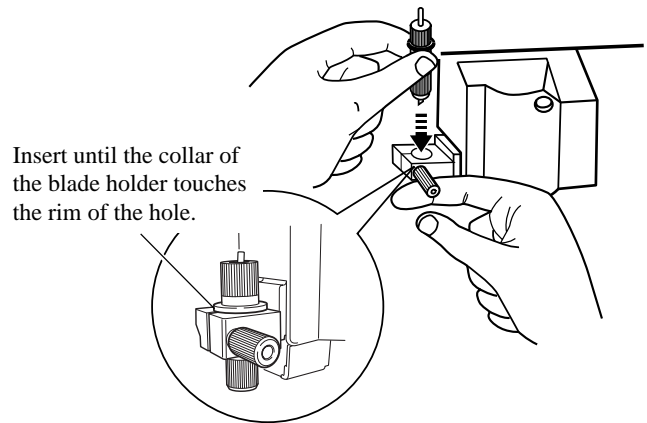

- 5** Tighten the screw securely. Tug the blade holder upward to make sure it does not come loose.

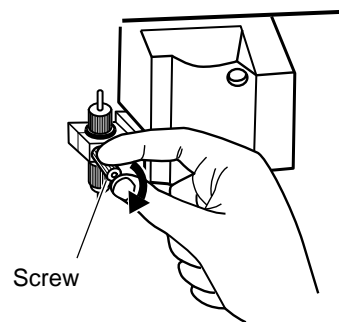

4-2 Loading the Material

NOTICE Do not use excessive force when moving the sheet loading lever. Doing so may damage it.

On the CX-24, use the control panel to choose the configuration of the loaded material.
 On the CX-12, there is no menu for choosing the configuration of the material.

■ Acceptable Material Sizes

	CX-24	CX-12
Width (horizontal dimension)	50 to 700 mm (1-15/16 to 27-3/4 in.)	50 to 395 mm (1-15/16 to 15-1/2 in.)
Length (vertical direction)	For flat material, 100 mm or more; for roll material, no restriction No other restrictions (* Accuracy assured within a range of up to 1,600 mm (63 in.))	No restrictions (* Accuracy assured within a range of up to 1,600 mm (63 in.))

For more information about the range in which cutting is possible, see "9-2 About the Materials - [■ About the Cutting Area.](#)"

■ Loading the Material

Before you load material, make sure the sheet loading lever is lowered.

- If you are using roll material, start with step 1.
- If you are using piece material, start with step 2.

1 Pass the end of the material between the pinch rollers and the grit rollers so that it extends from the front of the unit.

- If You Are Using the Roller Base

On the CX-24, use the roller base. On the CX-12, either see "- If You Are Not Using the Roller Base," or secure in place roll material as a substitute for the roller base.

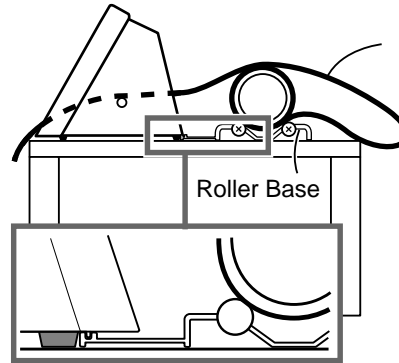

Pull out the portion to cut from the roll.

When loaded as shown in the figure, correct feed cannot be performed.

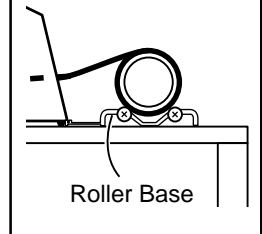

- If You Are Not Using the Roller Base

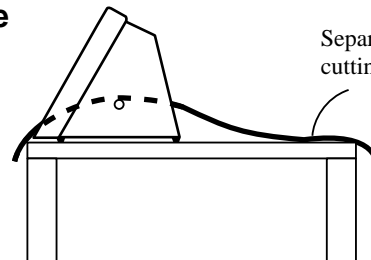

Separate the necessary length for cutting from the roll.

2 Position the material so that both edges are above the grit rollers. For more information about the width of the material and the positions of the grit rollers, see "9-2 About the Material - ■ Acceptable Material Widths."

- CX-24

When viewed from the front, align so that the right-hand edge of the material is above any of the grit rollers and the left-hand edge is above the long grit roller.

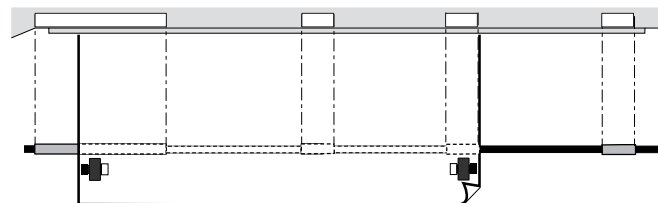

The white areas of the rails serve as a guide for positioning the grit rollers.

For material with a width of 150 mm (6 in.) or less, place the material above the grit roller at the left edge.

- **CX-12**
Position the material so that the left and right edges are each above one of the grit rollers.

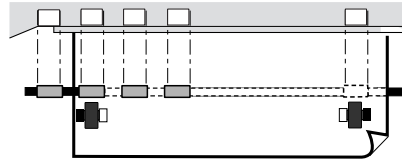

The white areas of the rails serve as a guide for positioning the grit rollers.

- 3** Align so that the left and right edges of the material are parallel with the guide lines.

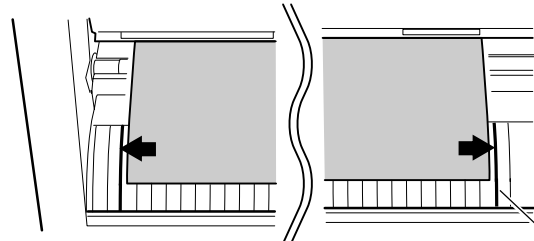

Guide line marks

- 4** Using the stickers on the rails as a guide, adjust the positioning of the left and right pinch rollers above the grit rollers.

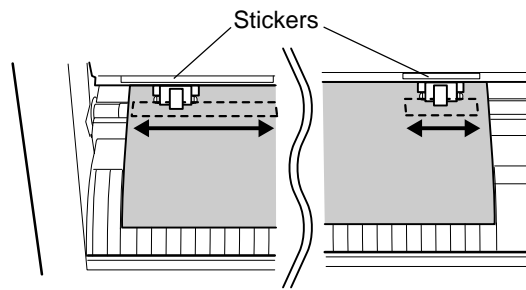

- 5** Make sure the end of the material has been pulled out farther toward the front than the blade protector.

OK

Not OK

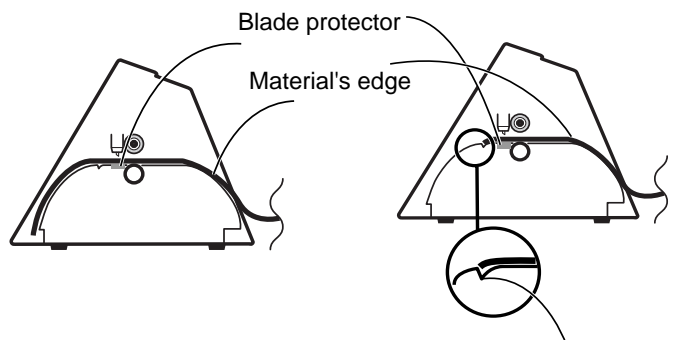

Make sure the end of the material does not catch on this groove.

- 6** Raise the sheet loading lever. This lowers the pinch rollers to hold the material in place.

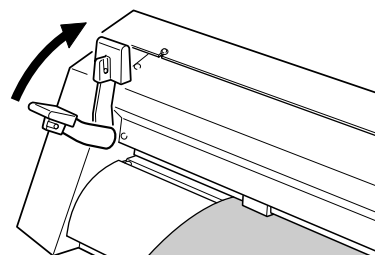

4-3 Turning on the Power

CAUTION



Do not place the hands or anything else on the platen when switching on the power.

Doing so may result in injury.
(The cutting carriage moves simultaneously when the power is switched on.)

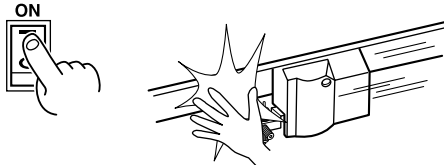

Turn on the CX-24/12.

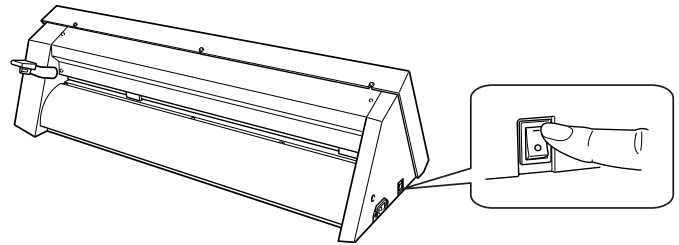

■ Putting the Machine in the Setup State

Use the control panel to put the CX-24/12 in the setup state (the state for receiving data).

For the CX-24:

- 1 Turn the dial.
When the display shows the type of load material, press the [ENTER] key.
The cutting carriage starts to move.



- ROLL: Roll material
- EDGE: When performing cutting from the front edge of the material
- PIECE: Flat material such as standard-size and piece material

- 2** The width of the material is detected and the unit is made ready for cutting.
- * When flat material is loaded, the material moves to the front and rear to detect the length of the material as well.
- At this time, if the material is crooked and looks like it might come loose from the pinch rollers, or actually does come loose, reload the material.

For the CX-12:

- 1** Press the [ENTER] key.
The cutting carriage starts to move.

SETUP -> ENTER

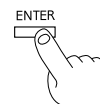

- 2** The width of the material is detected and the unit is made ready for cutting.

■ Making Menu Settings with the Control Panel

How to View the Display

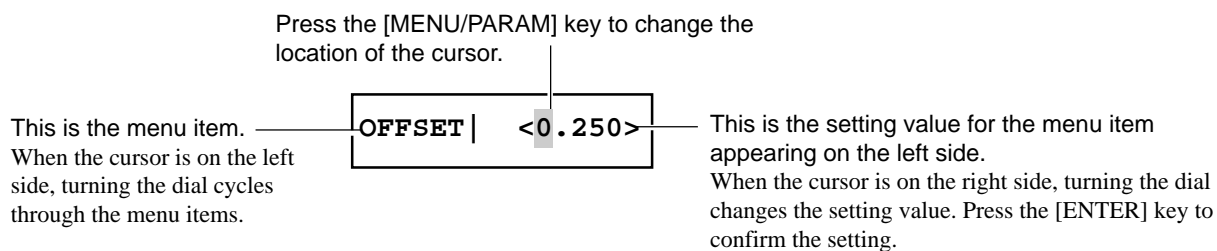

4-4 Checking Material Feed

Make sure that the material does not come loose from the pinch rollers while cutting is in progress.

On the CX-24, when you choose [PIECE] as the material type, the material is moved forward and backward in order to detect the length of the material.

There is no need to perform the steps described below in order to make sure that the material does not come loose at this time.

- 1 Turn the dial to display the screen shown at right.
Press the [MENU/PARAM] key.
This displays the menu for setting the material-feed length.

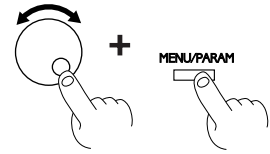
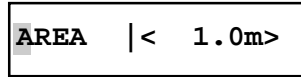

- 2 Turn the dial to change the value to the required length of material for cutting. When the display shows the desired value, press the [ENTER] key.
The display changes to the menu for performing material feed.

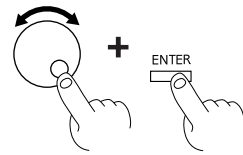
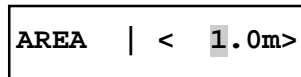

- 3 When the screen shown at right appears, press the [ENTER] key again.
A length of material corresponding to the setting you made in step 2 is fed out.
If the material is crooked and looks like it might come loose from the pinch rollers, or actually does come loose, please reload the material.

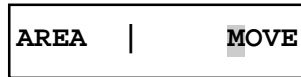

* To perform material feed using the value displayed in step 1, then after step 2, simply press the [ENTER] key, and material feed is performed.

4-5 When Performing Long Cutting

Cutting a length of 1.5 m (59 in.) or more requires material that is at least 50 mm (2 in.) wider than the necessary cutting width.

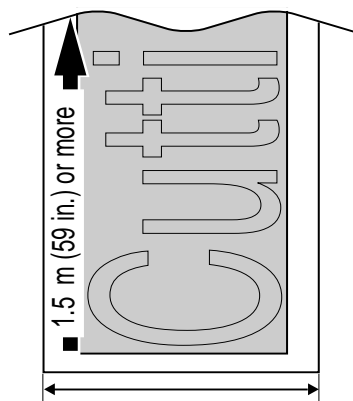

Prepare material that is at least 50 mm (2 in.) wider than the necessary cutting width.

- 1 Refer to the figure at right and move the pinch rollers. Position the pinch rollers so that each one is 25 mm (1 in.) from the respective left or right edge of the material.

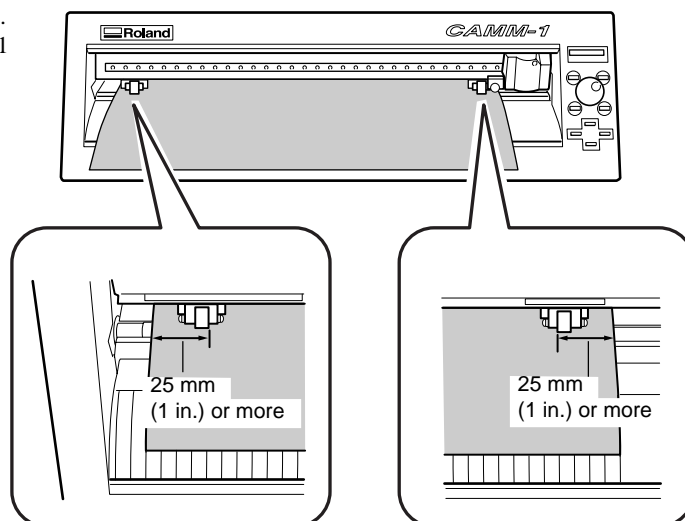

- 2 Raise the sheet loading lever to secure the material in place.

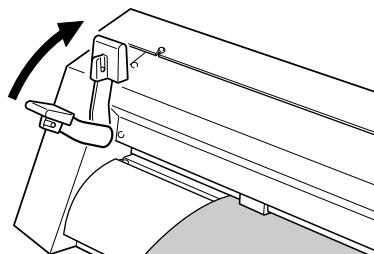

- 3 Before performing material feed, pull out the required length of material from the roll material.

- 4 Refer to the previous section, "[4-4 Checking Material Feed](#)," and perform material feed. If the material comes loose, then reload the material.

4-6 Setting the Origin Point

Loading material and pressing the [ENTER] key automatically sets the origin point for cutting.
The origin point set when you do this varies according to model and the shape of the selected material.

Model	Material shape selected from the menu	Location of the origin point
CX-24	[ROLL]	<ul style="list-style-type: none"> - Near the left pinch roller - Near the right pinch roller when the [ROTATE] menu item is set to ON
	[EDGE] [PIECE]	<ul style="list-style-type: none"> - At the front lower left of the material - Near the front lower right of the material when the [ROTATE] menu item is set to ON
CX-12	There is no material-selection menu.	<ul style="list-style-type: none"> - Near the left pinch roller - Near the right pinch roller when the [ROTATE] menu item is set to ON

CX-24/12, in addition to the foregoing locations, you can freely set the origin point (0, 0) anywhere in the cutting area.
Setting the origin point at an uncut area of the material lets you use the material with less waste.
To set the origin point where you want, follow the steps below.

- 1** Before setting the origin point, load the material.
Refer to "4-2 Loading the Material" and load the material.

- 2** Use the position keys to move the center of the blade holder to the location where you want to set the origin point.

- 3** Press the [ORIGIN] key. The message [ORIGIN SETTING] flashes on the display, and the origin point is set.

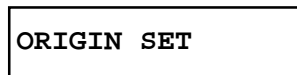
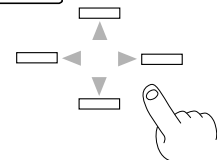
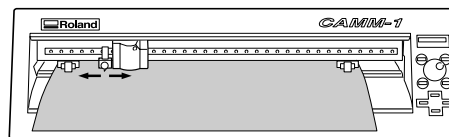

4-7 Performing a Cutting Test (How to Adjust Blade Force/Adjusting the Cutter Blade)

Before carrying out actual cutting, you may wish to perform a "cutting test" to check whether the unit produces the cutout satisfactorily. This is done by examining the results of the cutting test, and adjusting the blade force and the amount of blade extension. The cutting test should be repeated until the appropriate cutting conditions for the material in use are discovered.

If smooth cutting cannot be performed, use the display menu to adjust the blade force.

If adjusting the blade force does not produce good cutting results, then adjust the amount of blade extension from the blade holder.

■ Cutting Test

If a material has not yet been loaded, then refer to "4-2 Loading the Material" to load the material correctly.

- 1 Use the position keys to move the blade holder. Move to the position where the cutting test is to be performed.

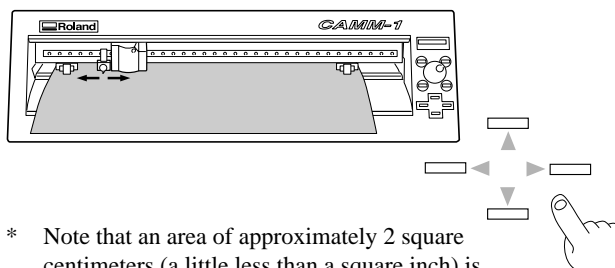

* Note that an area of approximately 2 square centimeters (a little less than a square inch) is required to make a test cutout

- 2 Press the [TEST] key for 0.5 seconds or more.



- 3 The shape shown in the figure at right is cut at the present location of the blade. Peel off the material to check the result of the cutting test.

Peel this off first. The square should remain, without peeling off.

Peel this off next. The blade should leave faint traces on the base paper of the material.

The diagram shows a circular material with a square cutout in the center. Two arrows point to the corners of the square, indicating the peeling direction. The text explains that the square should remain on the base paper while the surrounding material is peeled off.

- 4 If the results are not as described in step 3, use the control panel to gradually raise the blade force.

■ Adjusting the Blade Force

- 1 Turn the dial to display the screen shown at right.
Press the [MENU/PARAM] key.
The menu for setting the blade force appears.

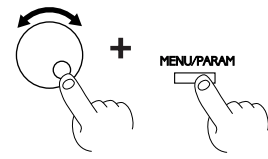
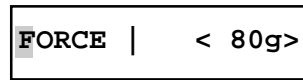

- 2 Turn the dial clockwise to increase the blade force in steps of 10 g.
When the display shows the desired value, press the [ENTER] key.

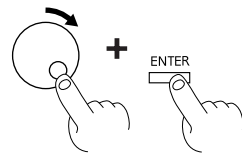

- 3 When adjusting the blade force, take into account the type and thickness of the material you are using, and the hardness of the blade. (See "9-1 Blade and Material Combinations.")
If the adjustment of the blade force is not correct, the symptoms shown at right may occur.

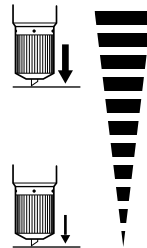

Too large

- The material may be torn
- Blade life will be shortened
- Cutter blade extends through the base paper, and normal advancing of the material becomes impossible
- The CX-24/12 may be damaged.

Too small

- The material may not be cut satisfactorily

■ Adjusting the Amount of Blade Extension

If cutting is not performed smoothly even after you have adjusted the blade force, then adjust the amount of blade extension for the tip of the blade extending from the blade holder.



If you're using the included material or an equivalent general material, then tighten the cap all the way to the top (maximum amount of blade extension: 2.5 mm (0.0984 in.)).
When cutting material having base paper that is thin with respect to the material (material thickness), or material having no base paper, the amount of blade extension should be adjusted so that the blade does not cut through the base paper.

- 1 Remove the blade holder.
- 2 Adjust the amount of blade extension a little at a time, performing cutting tests to check the results.
When the cutting tests show that the blade leaves faint traces on the backing paper, the amount of blade extension is optimal.
Use the following as a guide for calculating the amount of blade extension.

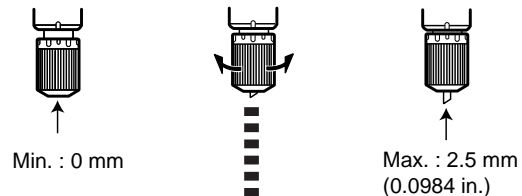

$$\text{Amount of cutter blade extension} = \text{Thickness of the material portion} + \frac{\text{Thickness of the base paper}}{2}$$

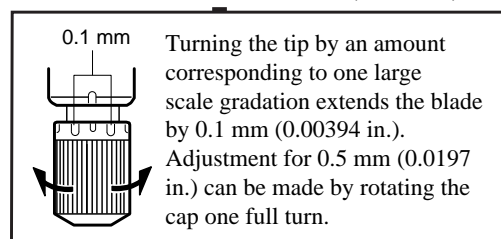

4-8 Downloading Cutting Data

NOTICE When loading a flat material on the CX-12, be sure to use a flat material that is about 70 mm (2-13/16 in.) longer than the vertical size of the cutting data. If data larger than the vertical length of the material is sent, the CX-12 will attempt to cut the data even if it does not all fit in the material. This means that the material is dislodged from the grit roller, and cutting continues with no material. This can cause not only breakage to the blade but also damage to the unit, and adequate care is required to prevent this.

If the material becomes dislodged or there is a problem in operation, then immediately press the [ENTER] key or turn off the power switch on the left side of the machine.

Using the CX-24/12 to cut data created using a program requires the CAMM-1 driver.

The CAMM-1 driver is in the included Roland Software Package. For information on how to install it, take a look at the included Startup Manual.

The explanations in this section assume that the CAMM-1 driver is already installed, and describe how to make the settings for the cutting range and tool parameters.



The cutting range is determined by the positioning of the pinch rollers. Set the cutting range for the driver so that it fits within this range.

If a size that is identical to the load material is specified and data is laid out accordingly, there may be portions which cannot be cut.

 :Cutting area

 :Pinch roller

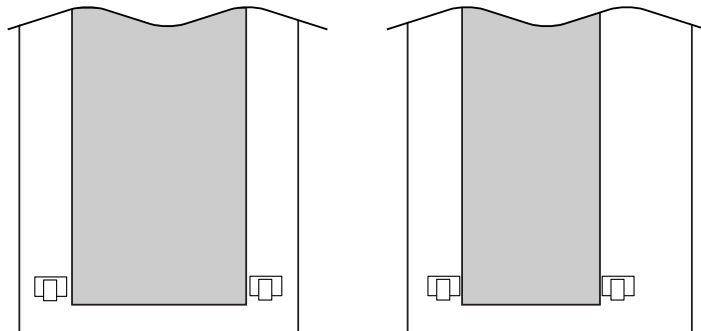

The range that can be cut changes according to the positioning of the pinch rollers. If you're using flat material, use the program to specify a value that is about 70 mm (2-13/16 in.) shorter than the vertical size of the material. For more information about the cutting range, see "9-2 About the Materials - [About the Cutting Area](#)."

■ Making the Settings for the CAMM-1 Driver -Windows 95/98/Me

1 In the program you're using, from the [File] menu, choose [Print Setup] to display the [Printers] dialog box.

* The names of the menu items may be different, depending on the program you're using.

2 For the CX-24, choose [Roland CAMM-1 CX-24]. For the CX-12, choose [Roland CAMM-1 CX-12].

3 Click [Properties]. The [Properties] dialog box appears.

4 Click the [Size] tab and make the settings for the cutting range at the screen shown at right.

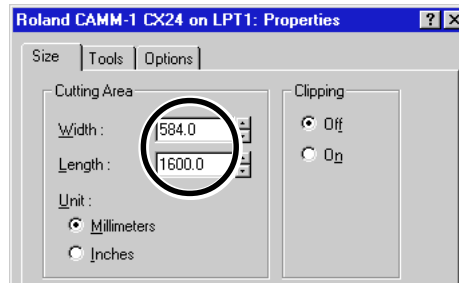

5 Click the [Tools] tab. Clicking the drop-down arrow displays the numerals [1] through [8] and the [Machine Setting] selections. To specify the speed for performing cutting using the driver, choose a number from [1] to [8] and enter the cutting conditions. When you do this, the machine settings for the CX-24/12 are disabled.

To perform cutting using the conditions set with the CX-24/12, choose [Machine Setting]. Click [OK].

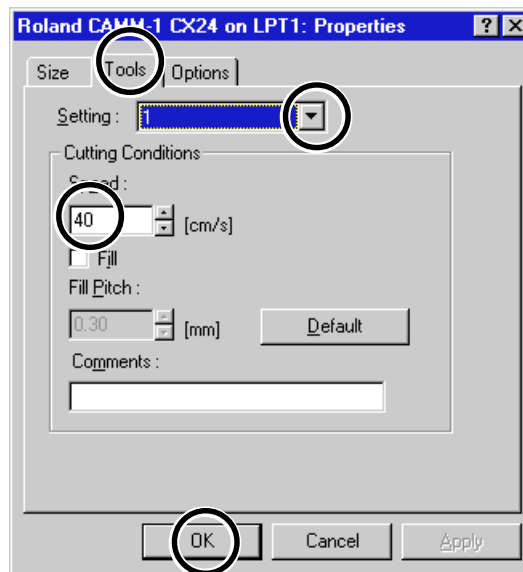

* When you are performing cutting, clear the selection for [Fill Pitch].

6 In the [Printers] dialog box, click [OK]. In the program window, lay out the cutting data so that it fits within the displayed cutting range.

7 Send the cutting data from the program to the CX-24/12.

■ Making the Settings for the CAMM-1 Driver -Windows NT 4.0/2000/XP

If you are installing under Windows 2000/XP or Windows NT 4.0, you need full access permissions for the printer settings. Log on to Windows as a member of the "Administrators" or "Power Users" group. (For more information about groups, refer to the documentation for Windows.) The descriptions of the following procedures use screen shots from Windows 2000.

- 1** In the program you're using, from the [File] menu, choose [Print Setup] to display the [Printers] dialog box.
 - * The names of the menu items may be different, depending on the program you're using.
- 2** For the CX-24, choose [Roland CAMM-1 CX-24].
For the CX-12, choose [Roland CAMM-1 CX-12].
- 3** Click [Properties].
The [Properties] dialog box appears.
- 4** For Windows 2000/XP, click [Advanced].
For Windows NT 4.0, click [Advanced] tab.
- 5** Click the [MediaSizeSettings] document option at the screen shown at right.
For Windows 2000/XP, click [Properties].
For Windows NT 4.0, click [Media Size Settings].
The [Media Size Settings] dialog box appears.

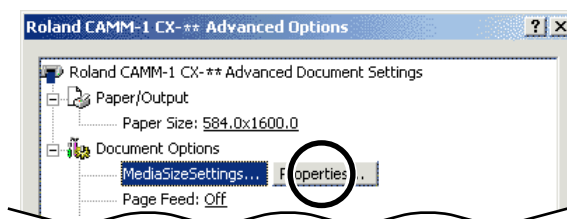

- 6** Click [Add New Media Size], then for [Media Size], enter cutting range for [Width] and [Length].

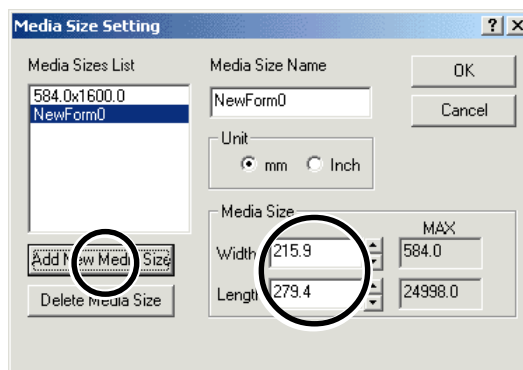

- 7** Enter the [Media Size Name], then click [OK].
 - * For [Media Size Name], use only alphanumeric characters.

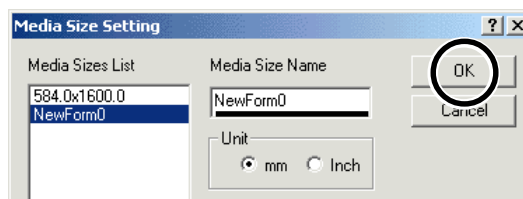

4 Basic Operation

8 Click [Selected Tool] displays the numerals [1] through [4] and the [Machine Setting] selections. To perform cutting using the conditions set with the CX-24/12, choose [Machine Setting].

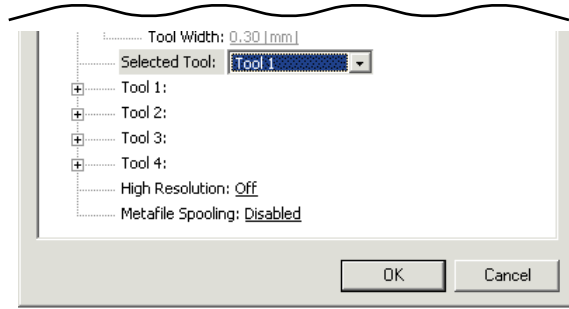

9 To specify the speed for performing cutting using the driver, choose a number from [1] to [4]. Double-click the selected tool number, then enter the value for [Tool Speed]. When you do this, the machine settings for the CX-24/12 are disabled. Click [OK]. If you're using Windows 2000/XP, the [Properties] dialog box appears. Click [OK]. If you're using Windows NT, the [Printers] dialog box appears.

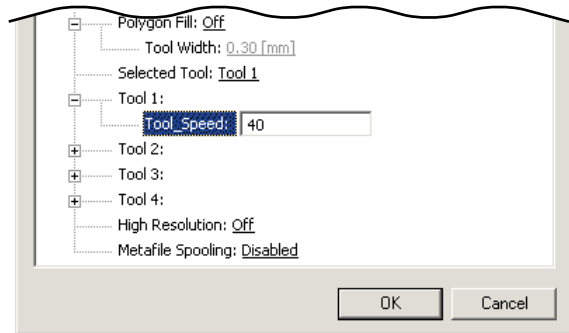

* When you are performing cutting, choose [Off] for [Fill Pitch].

10 Click [OK]. In the program window, lay out the cutting data so that it fits within the displayed cutting range.

11 Send the cutting data from the program to the CX-24/12.

■ Pausing Cutting Operations

Pressing the [ENTER] key displays a screen like the one shown below and pauses cutting.

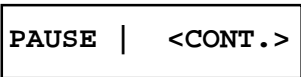

- To resume cutting without change

Press the [PAUSE] key again.

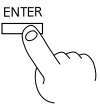

- To stop cutting

Halt transmission of cutting instructions from the computer.

- 1 Click [Start].
Point to [Settings] and click [Printers].
If you're using Windows XP, click [Start]-[Control Panel] and then click [Printers and Other Hardware]-[Printers and Faxes].

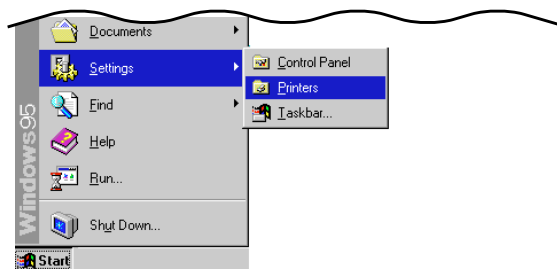

- 2 Double-click the printer icon.
For the CX-24:
[Roland CAMM-1 CX-24]
For the CX-12:
[Roland CAMM-1 CX-12]

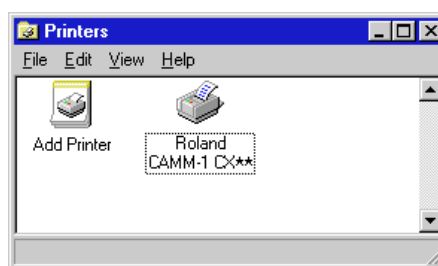

- 3 From the [Printers] menu, click [Purge Print Jobs] or [Purge Print Documents].
Make sure the displayed data for the file being printed disappears.
If you're using Windows 2000/XP, choose [Cancel All Documents].

- 4 Turn the dial on the CX-24/12 to choose [END].

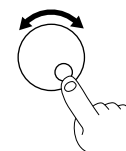
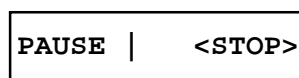

- 5 Pressing the [ENTER] key displays the message shown at right, and cutting stops.

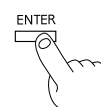

■ When Continuing with Cutting on the Same Piece of Material

- 1 Set the origin point at an uncut location on the material (the location where you want to cut next).
For information on how to set the origin point, see "[4-6 Setting the Origin Point.](#)"

- 2 Send the cutting data from the program to the CX-24/12.

4-9 Applying the Completed Cutout

When cutting ends, affix the material you created.



- Before you affix the material, cleaning the location where you want to affix it to remove any dust or grease.
- When applying on a transparent medium such as window glass, it may be helpful to draw guide lines on the back of the glass with a water-based pen (so that the lines can be wiped off after applying the material).
- If air bubbles are formed under the affixed material, use a needle to pop the bubble, then press out the air to obtain a complete seal.

■ Removing the Material

Piece Material

- 1** Turn the dial to display the screen shown at right.
Press the [MENU/PARAM] key.

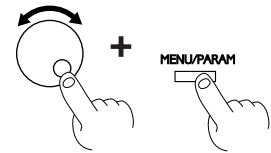
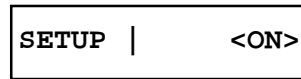

- 2** When the screen at right appears, press the [ENTER] key.
The cutting carriage moves to the right.

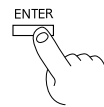
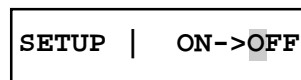

- 3** Lower the sheet loading lever.

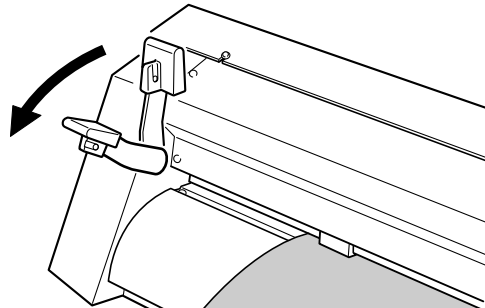

- 4** Remove the material.

- For Roll Materials, or When Detaching Only a Cut Portion

Use the commercially available knife to sever the material along the knife guide.

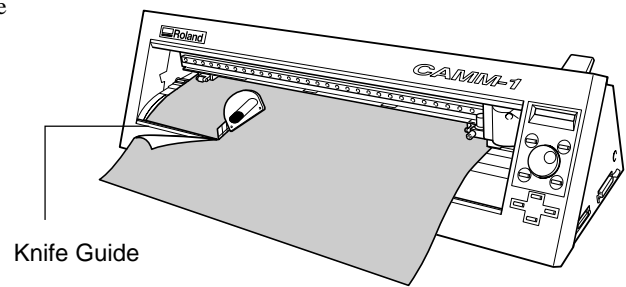

- 1** Use tweezers to peel off unneeded portions of the material you created.

* You should have weed boarders or rectangles drawn around work to facilitate weeding.

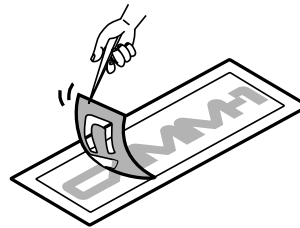

- 2** Stick application tape over the completed work. Press down firmly on the application tape to remove air bubbles. If you do not press firmly enough the cut area will not stick to the surface.



- 3** Transfer the material you created to the application tape.

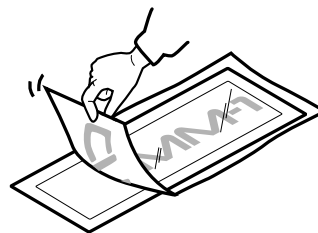

- 4** Decide where to affix the material, then affix it, making sure that it is not misaligned. Rub over the application tape to make sure the work is firmly stuck in place. Then peel off the application tape.

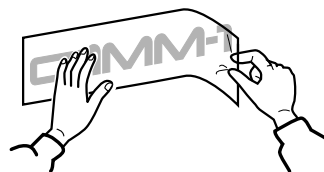

4-10 When Cutting Is Completed

CAUTION



When not in use for extended periods, unplug the power cord from the electrical outlet.

Failure to do so may result in danger of shock, electrocution, or fire due to deterioration of the electrical insulation.

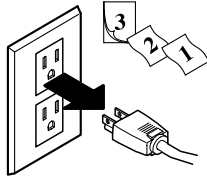

NOTICE Do not leave the tool mounting screws tightened. Tightening the screw makes it more difficult to install the blade holder.

1 Loosen the screw shown in the figure and remove the blade holder from the cutting carriage.

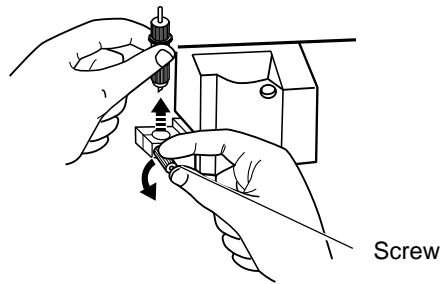

2 Press the pin shown in the figure and detach the blade holder. If a blade was used, wipe the blade with a soft cloth to remove any material that may cling to it.

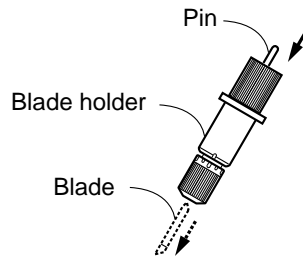

3 Lower the sheet loading lever then remove the material.

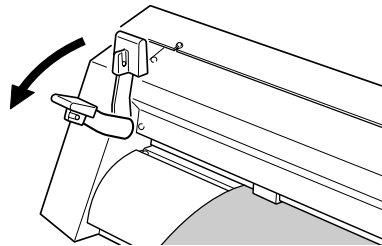

4 Turn off the power.

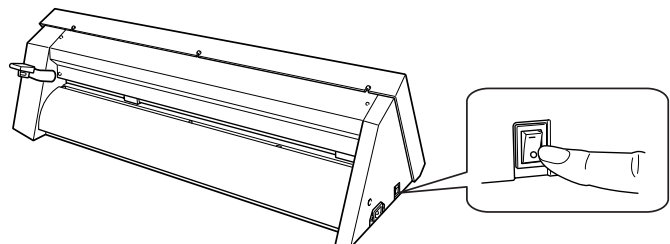

* Use a soft, dry cloth to wipe down the CX-24/12.

5 Performing a Self-Test

The CX-24/12 is equipped with a "self-test" function to conveniently allow you to check whether or not it is capable of operating normally. If the CX-24/12 is not performing correctly, follow the steps below to perform a self-test.

A computer is not required in order to carry out the self-test.

- 1** Refer to "[4-1 Installing a Blade](#)" and install the blade holder to the cutting carriage on CX-24/12.
- 2** Hold down the [▲] key on the panel while you turn the power on.
- 3** Refer to "[4-2 Loading the Material](#)" and load the material.
- 4** When the display shows the screen at right, press the [ENTER] key to start the operation check. Operations is normal if the figure shown at right is cut.

CX-24

SELECT | ROLL

CX-12

SETUP -> ENTER

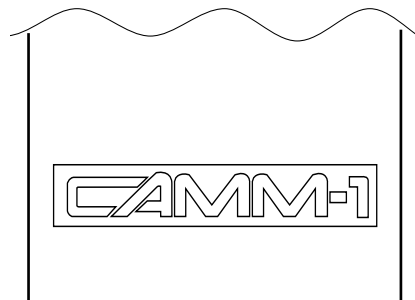

6 Plotting on Paper Media

Before cutting, plotting using pen and paper can ensure that your design is correct without wasting materials. This feature can also be used to plot template designs on thick materials that may not be able to cut.

* Since the design of the CX-24/12 differs inherently from that of dedicated plotters, it does not accommodate functions such as high-speed plotting, automatic pen changes, pen dry protection, or the like.

Acceptable Pens and Paper Media

Acceptable paper : High-quality paper

Acceptable pens : Water-based fiber-tipped pens
Thick water-based fiber-tipped pens

Acceptable paper widths :
CX-24 50 to 700 mm (1-15/16 to 27-3/4 in.)
CX-12 50 to 395 mm (1-15/16 to 15-1/2 in.)

1 Refer to "4-1 Installing a Blade" and install the pen by following the same steps as for installing a blade.

2 Refer to "4-2 Loading the Material" and load the paper by following the same steps as for loading material.
If you're using the CX-24, then when the menu for selecting the type of material appears, choose [PIECE].

3 Turn the dial to display the screen shown at right. Press the [MENU/PARAM] key.

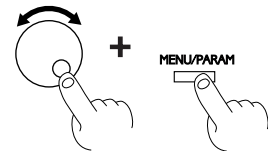
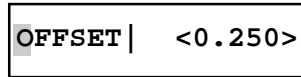

4 Turn the dial to display <0 (PEN)>, then press the [ENTER] key.

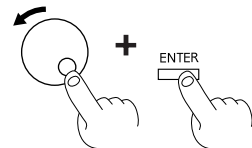
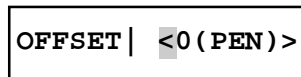

5 When the plot data is sent from the computer, plotting starts.

7 Repeating the Same Cutting

The CX-24/12 can store the data sent from the computer in a buffer (a temporary memory area), and use this data to repeat cutting. In the setup state, when cutting data is sent, the data is buffered at the same time that cutting starts. Data sent until the setup state is released can be recut.



- Even after the setup state is released, data for recutting does not disappear until new data is sent from the computer.
- When the power is switched off, any existing data in the buffer is deleted.
- If the buffer becomes full while data is being sent, recutting cannot be performed. When this happens, running [RELOT] displays the message "DATA TOO LARGE."
- When there is no data in the buffer, the message "NO DATA" appears.

■ Preparing the Cutting Data

When you repeat cutting, all data in the buffer is called up and cut. Before you send data from the computer, delete all the data in the buffer in the CX-24/12.

- 1** Turn the dial to display the screen shown at right.
Press the [MENU/PARAM] key.

RELOT | START

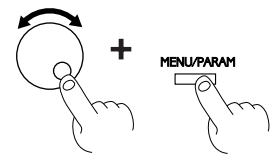

- 2** Turn the dial to display <CLEAR>, then press the [ENTER] key.
The data in the buffer is deleted.

RELOT | CLEAR

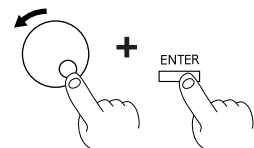

- 3** Refer to "[4-8 Downloading Cutting Data](#)" and send the cutting data from the computer.

■ Getting Ready for Recutting

Repeating Cutting Without Replacing the Material

1 Use the position keys to move the blade holder to the location for setting a new origin point.

2 Press the [ORIGIN] key to set the origin point.



Repeating Cutting on Different Material

1 Turn the dial to display the screen shown at right. Press the [MENU/PARAM] key.

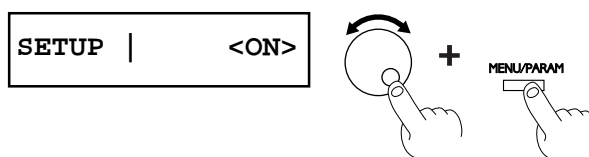

2 Turn the dial to display the screen shown at right. Press the [ENTER] key. The setup state is released.

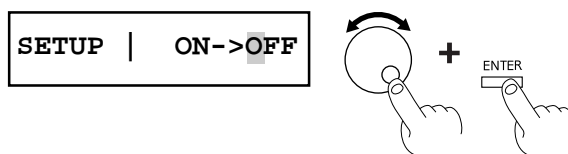

3 Load the new material. For information on how to load the material, see "4-2 Loading the Material."

■ Performing Recutting

1 Turn the dial to display the screen shown at right. Press the [MENU/PARAM] key.

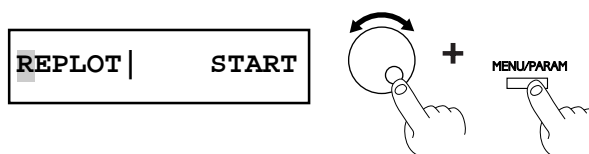

2 Press the [ENTER] key. Recutting starts.



8 Cutting Printed Material

Making stickers and the like involves cutting around figures that have already been printed.

With the CX-24/12, sensors on the cutting carriage read guide marks printed on the material (crop marks) and use these to align the positioning for printing and cutting.

You use the program to lay out the crop marks before creating the design.

8-1 Using Crop Marks

In order for the crop marks to be able to be read by the CX-24/12, the conditions below must be met.

- Data-creation Program

Use a drawing or PostScript program compatible with the CX-24/12.

Data from bitmap programs that work chiefly with images cannot be output with the CX-24/12.

The program must have functions that let you designate specific points as the reference for printing, and also that let you freely move such designated points.

- Printer

Use a laser or inkjet printer.

Depending on the printer, however, the CX-24/12 may be unable to read printed crop marks.

A resolution of 720 dpi or higher is required.

Printers that smudge solid areas during printing produce crop marks that cannot be read.

- Materials

Use material that can be printed by a laser or inkjet printer and that meets the following conditions.

Material type: : Laser printers -> High-quality paper, coated paper, art paper, or PET
Inkjet printers -> High-quality paper or coated paper

Material thickness: about 0.2 mm

Color : White

Crop marks on laminated material cannot be read.

If the CX-24/12 cannot read crop marks or if printing and cutting are misaligned even when all the conditions have been fulfilled and operations have been carried out correctly, the cause may be one of the following.

- Program accuracy

- Printer accuracy

- Expansion or contraction of the material due to ambient temperature or humidity

When unaffected by these factors, the alignment accuracy of the CX-24/12 is as follows.

± 3 mm (0.12 in.) or less with 500 mm (19-5/8 in.) or less of movement distance in the material-feed direction

8-2 Shape and Layout of Crop Marks

■ Shape of Crop Marks

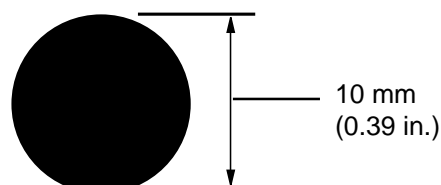

Crop marks that can be read by the sensors must be circular and have a diameter of 10 mm.

For the color density, specify 100% black.



■ Crop Marks and Figure Layout

Place the crop marks at three locations, as shown in the figure below.

 : Printable area  : There must be no soiling and no figures other than crop marks within this area.

For A4 size (portrait)

For sizes larger than A4

55 mm (2-3/16 in.) or more

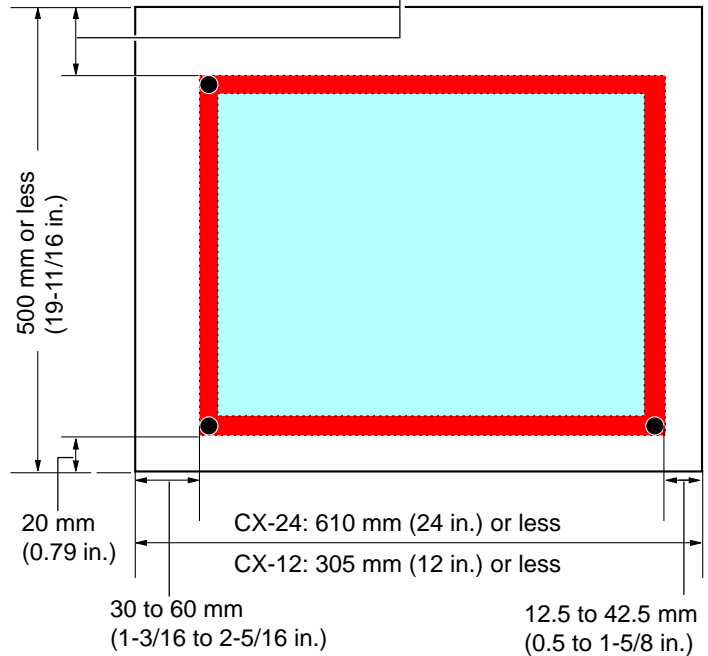
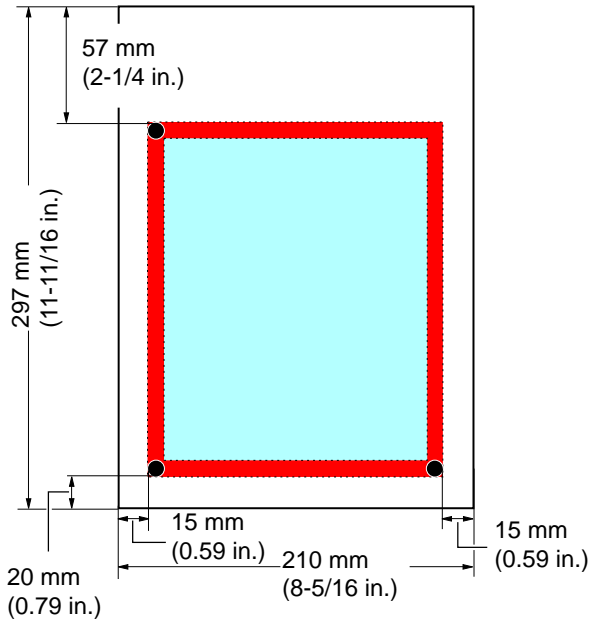

8-3 Loading the Material

Load the printed material on the CX-24/12 so that the crop marks are positioned as shown below.

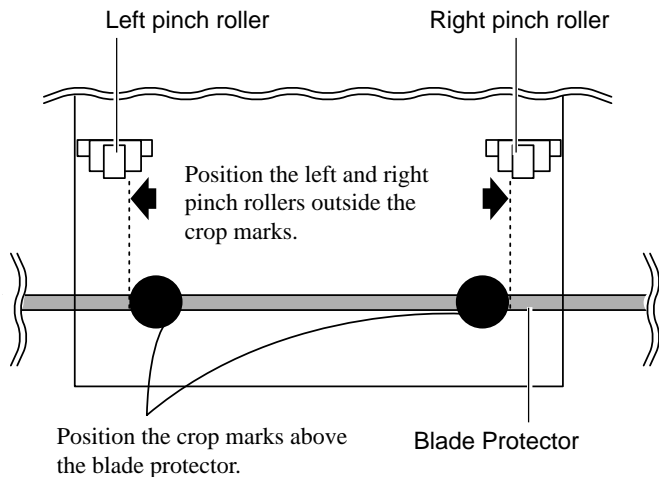

When the left and right crop marks are slanted 5 degrees or more with respect to the direction of movement of the cutting carriage, or when they are displaced by 15 mm (0.59 in.) or more in the direction of material feed, the crop marks cannot be detected.

X: the center of the crop marks

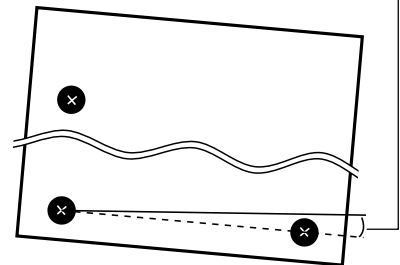

Material may warp when printed on the printer. Do not use material that has warped as shown in the figure. It may not be possible to read the crop marks. In such cases, correct the warping of the material before you load it on the CX-24/12.

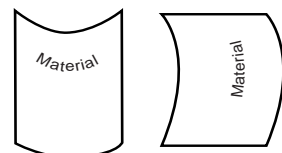

8-4 Performing Operations Using Crop Marks

This section describes how to perform output. The operating environment described below is used in the examples.

Data-creation program: Adobe Illustrator 8.0 for Windows

For detailed information on how to use Illustrator, refer to the user's manual or program help for Illustrator.

The explanations here assume that you are already familiar with the basic operation of Illustrator.

Material Size : A4



How to lay out figures for cutting

Cutting around a figure

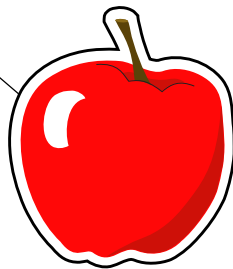

Cutting inside a figure



■ Creating Data and Printing the Material

- 1 From [File] menu, click [Document Setup].
The [Document Setup] dialog box appears.
- 2 For [Units], choose [Millimeters].
- 3 Select the [Use Print Setup] check box, and for [Orientation], click .
- 4 Click [Print Setup].
The [Print Setup] dialog box appears.
- 5 Choose the driver name for the output printer.
Click [Properties].
The [Properties] dialog box appears.
- 6 For the material size, choose [A4] and [Portrait], then click [OK].
The [Print Setup] dialog box appears.

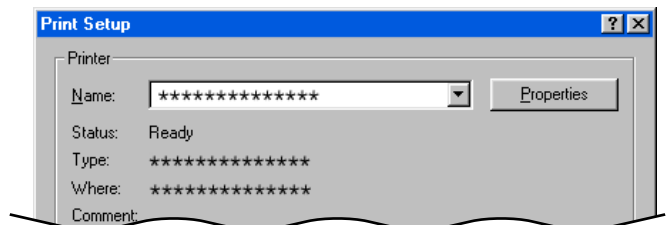
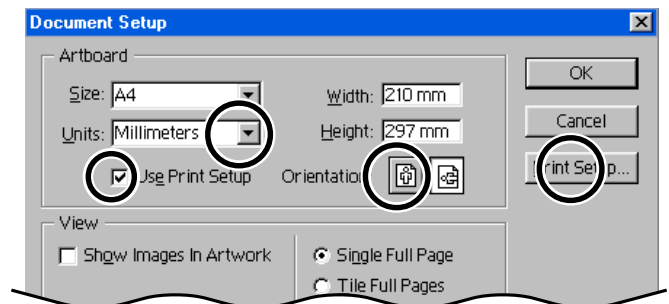

8 Cutting Printed Material

7 Click [OK].
The preview window appears.

8 This example uses the layout and positioning of crop mark for A4-size material. For detailed information, refer to "8-2 Shape and Layout of Crop Marks - [Crop Marks and Figure Layout.](#)"
At this time make a note of the distances between the crop marks specified in the figure at right.

For A4-size material, these are as follows.

Length direction: 210 mm

Width direction: 170 mm

The values you note down here are required when you make the menu settings for sensing crop marks on the CX-24/12.

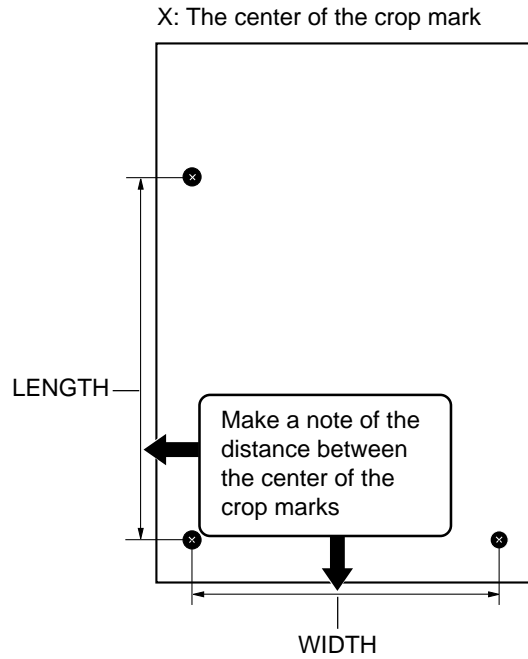

9 Lay out the figure inside the crop marks.

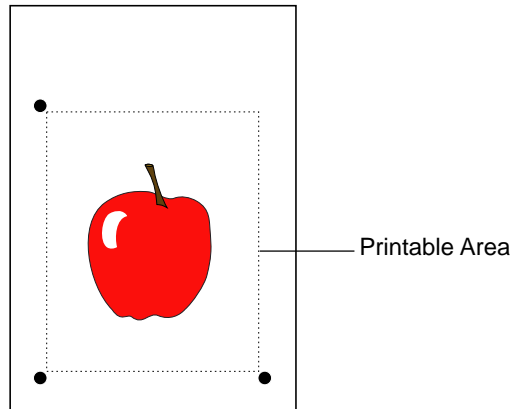

10 From [File] menu, choose [Print] to perform output to the printer you're using.

■ Loading Output Material on the CX-24/12

1 Orient the material so that its long edges are parallel to the material-feed direction of the CX-24/12. Position the crop marks above the blade protector.

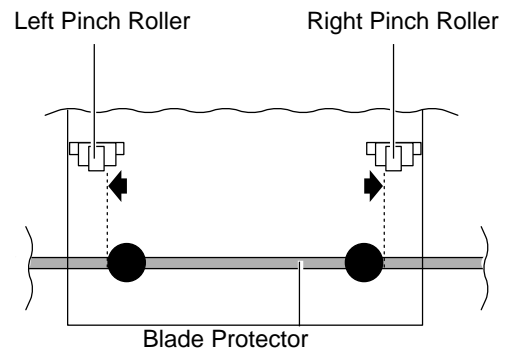

2 Position the pinch rollers outside the crop marks.

3 Raise the sheet loading lever to secure the material in place.

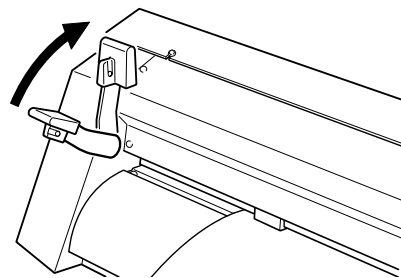

4 Switch on the power.

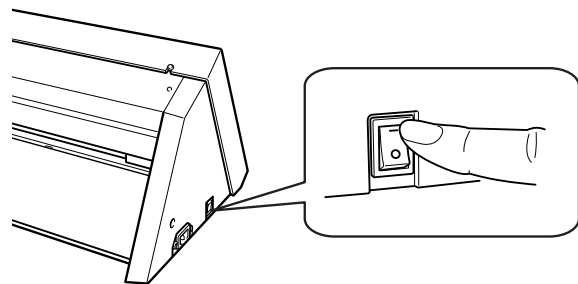

5 At the screen shown at right, press the [MENU/ PARAM] key to move the cursor.

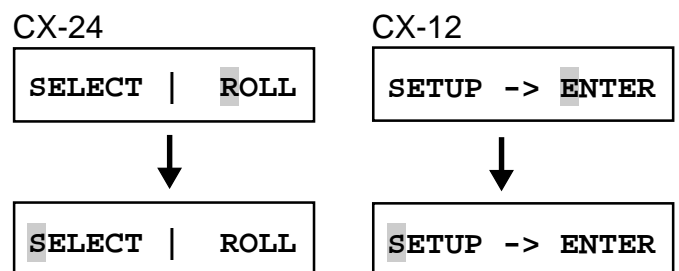

8 Cutting Printed Material

6 Turn the dial to display the setting at right. Press the [MENU/PARAM] key.

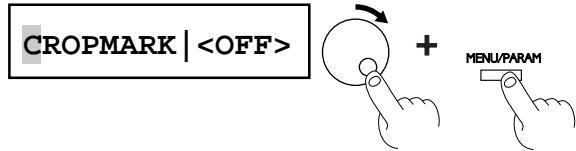

7 Turn the dial to choose [AUTO], then press the [ENTER] key. Turning the dial while in the state shown at right sequentially displays the menus for detecting crop marks.

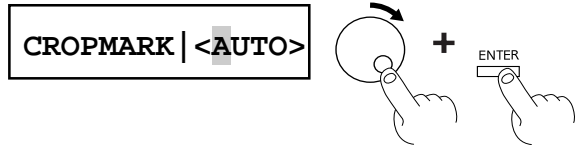

Refer to the following for making the menu settings. For information on how to make the menu settings using the control panel, refer to "4-3 Turning on the Power - ■ Making Menu Settings with the Control Panel."

* The values set at the menus for BASE X, BASE Y, WIDTH, and LENGTH are stored in memory even after the power is switched off. This means that when you use other data that has the crop marks laid out at the same locations, you don't need to redo the settings.

The CX-24/12 detects the centers of the crop marks it reads, and uses these as a reference to set the origin point for cutting.

Specifying the same value as the radius of the crop marks at the menus for BASE X and BASE Y causes the origin point to be set at the location in the figure at right.

In this example, set the values to 5.0 mm (the radius of the crop marks) for each menu setting.

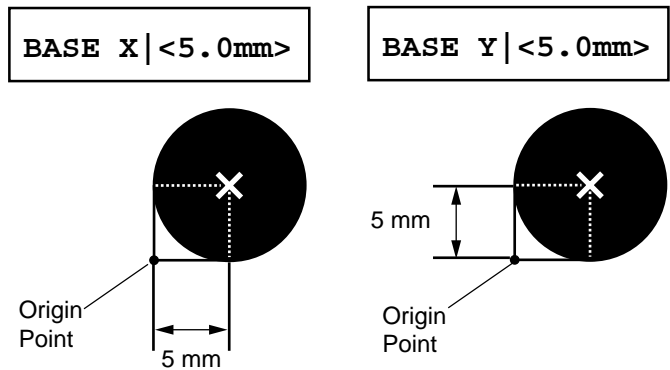

Use the display menus to enter in the CX-24/12 the distances between crop marks (width and length) laid out using the data-creation program.

The distance between two crop marks is detected from the center of one circle to the center of the other. In this example, A4-size material is loaded, so set WIDTH to 170 mm and LENGTH to 210 mm.

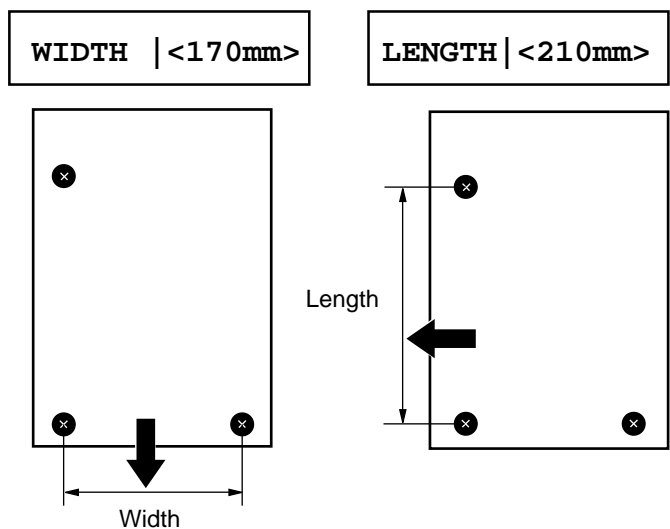

8 After making the menu settings in step 7, turn the dial counterclockwise to display the value shown at right. Press the [MENU/PARAM] key.

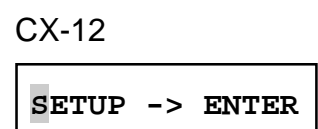
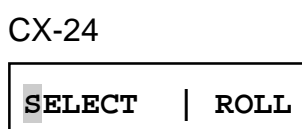

9 For the CX-24
Depending on the type of material loaded, choose [PIECE] or [ROLL], then press the [ENTER] key.

For the CX-12
Press the [ENTER] key.
The cutting carriage moves to the left and detection of the crop marks starts.

CX-24

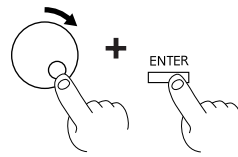
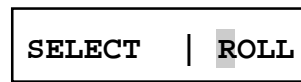

CX-12

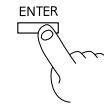
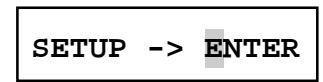

10 During crop-mark detection, the display sequentially shows the messages at right.
When mark detection ends, the message "ALIGN COMPLETED" flashes. When "SETUP | <ON>" appears, data can be received.
If any other message appears, it means that reading of the crop marks failed.
Refer to "8-5 When Crop Marks Cannot Be Read" and check the content of the data and how the material is loaded.

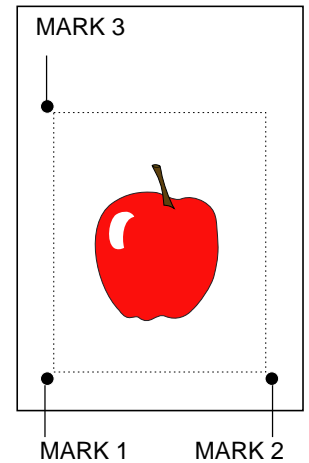
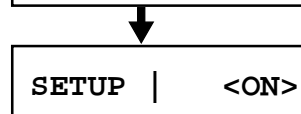
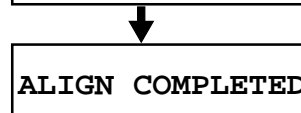
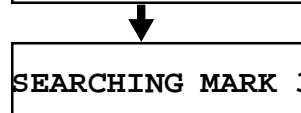
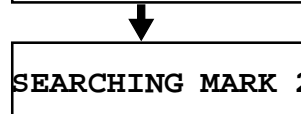
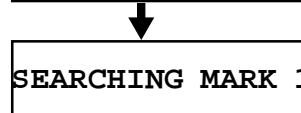

Performing Cutting with the CX-24/12

1 In Illustrator, go to the [File] menu and choose [Print Setup].
The [Print Setup] dialog box appears.

2 Choose the CX-24/12 driver as the printer to use for output.
If you're using the CX-24, choose Roland CAMM1 CX-24.
If you're using the CX-12, choose Roland CAMM1 CX-12.
Click [Properties].

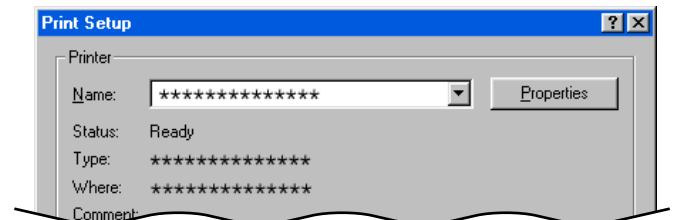

8 Cutting Printed Material

3 At the [Size] tab, specify a size identical to the printed material as the cutting area. Specifying the same size as the printed material makes it easier to visualize the figure laid out on the material and the cutting location. In this example, for [Width], enter "210 mm," and for [Length], enter "297 mm." Click [OK]. You return to the [Print Setup] dialog box.

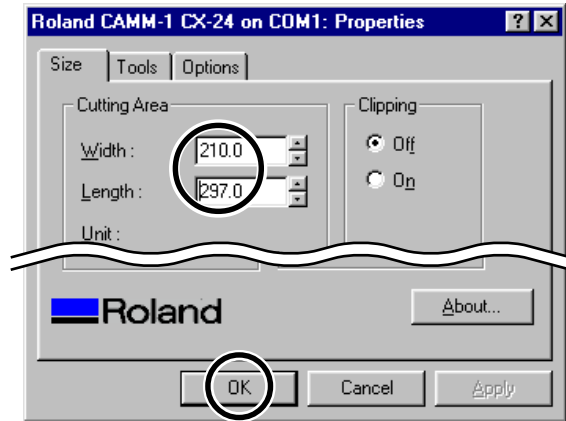

4 Click [OK]. The preview window appears.

5 Move the origin point for the page to match the crop mark you laid out at the lower left in "Creating Data and Printing the Material."

In Illustrator's toolbox, choose the page tool () and move the center of the page tool to the location shown in the figure. The origin point for cutting is set at the same location as on the CX-24/12.

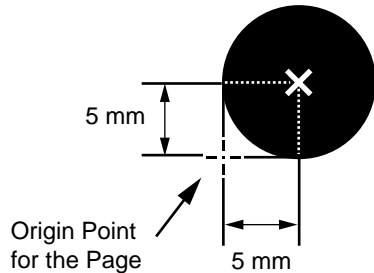

6 Make the line to cut around the figure.

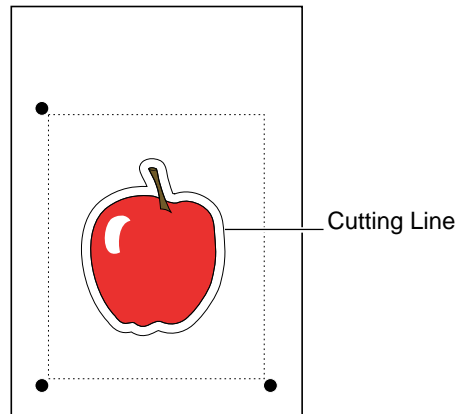

7 Select the line you drew in step 6. In the [Stroke] window, for [Weight], enter [0.01] mm, and specify the line for cutting.

* The method of specifying the line for cutting differs according to the program. If you're using a program other than Illustrator, specifying [Minimum] for the weight may allow you to select the line for cutting.

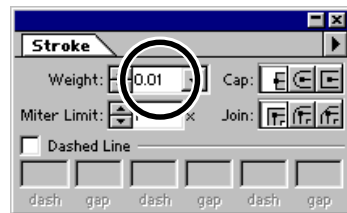

8 From the [File] menu, choose [Print].
The [Print] dialog box appears.

9 Clear the [Bitmap Printing] check box.

10 Click [OK].
The CX-24/12 cuts the data that has the line you specified for cutting.

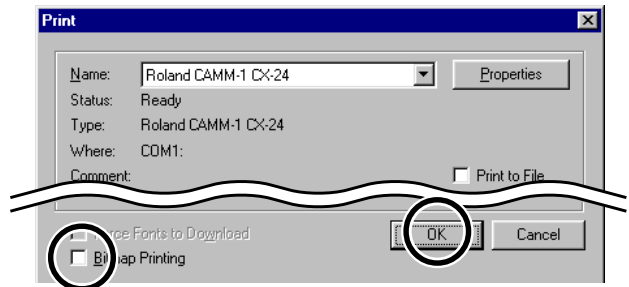

If the program you're using has the following features, they may be handy in laying out crop marks accurately.

- Zoom view
- Grid function
- Snap function
- Ability to specify location and size using numerical values

8-5 When Crop Marks Cannot Be Read

When the CX-24/12 cannot read crop marks, it displays an error message and pauses operation. If this happens, press any key on the CX-24/12's control panel to move the cutting carriage to the right side. Remove the material, check the following matters, then reload the material.

MARK 1 NOT FOUND

Is the location of the material loaded on the CX-24/12 aligned correctly?
Refer to "[8-3 Loading the Material](#)" and load the material correctly.

Is the load material warped upward?
Straighten out the warping of the material so that the material lies along the platen of the CX-24/12.

Is the material solid white in color?
If the material is colored or has patterns, then crop marks cannot be detected.
Also, even if the material is white, detecting crop marks may not be possible if it has a high gloss.

Are the crop marks faint or printed in a color other than black?
Print the crop marks over again, specifying black as the color and a density of 100%.

Are the crop marks of the correct size and shape?
Make each crop mark a circle having a diameter of 10 mm.
For details, see "[8-2 Shape and Layout of Crop Marks.](#)"
Crop marks printed using program-specific functions for creating crop marks cannot be detected by the CX-24/12.

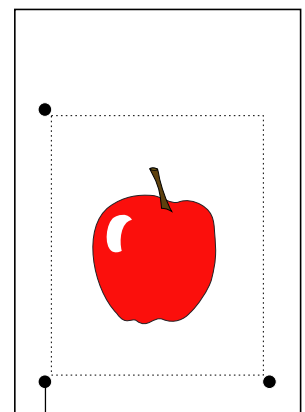

MARK 1

Are the layout locations for the marks correct?

Refer to "8-2 Shape and Layout of Crop Marks" to lay out the crop marks correctly. Even when the laid-out locations in the program are correct, output at the correct locations is not possible if [ROTATE] is set to [ON] for the CAMM-1 driver and at the CX-24/12's menu. Enlarging or reducing the size during printing makes the locations where crop marks are output misaligned.

Is the cutting carriage exposed to direct sunlight or intense indoor lighting?

If the sensors on the cutting carriage are exposed to direct sunlight or indoor lighting, crop marks may fail to be detected. Install the machine where it is not exposed to direct sunlight or indoor lighting.

MARK 2 NOT FOUND

Is the material loaded at an angle?

Are the printing results crooked?
Crop marks cannot be detected when the angle of a line connecting the centerpoints of mark 1 and mark 2 is slanted by 5 degrees or more or is misaligned by 15 mm or more in the material-feed direction. Check the printing results and load the material correctly, referring to "8-3 Loading the Material."

MEDIA MISALIGN

ANGLE TOO BIG

Do the distances between crop marks specified by the program match the distances specified on the CX-24/12?
Make sure the distances between crop marks set in the program and on the CX-24/12 are identical.

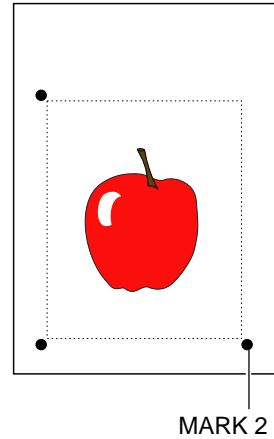

MARK 3 NOT FOUND

Are the crop marks laid out at the correct locations?
If the angle formed by the two lines connecting the centerpoints of the three crop marks is not 90 degree, the crop marks cannot be read. Crop marks cannot be read if the distance between crop marks in the material-feed direction is 500 mm or more. Refer to "8-2 Shape and Layout of Crop Marks" to lay out the crop marks correctly.

WIDTH TOO BIG

ANGLE TOO BIG

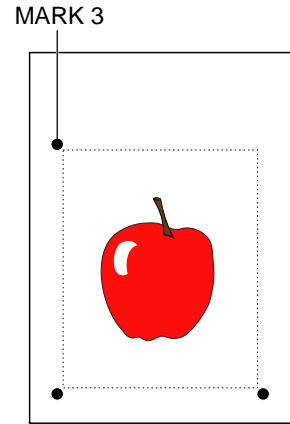

8-6 When the Printing and Cutting Locations Are Misaligned

When the locations of printing and cutting are misaligned even though detection of crop marks by the CX-24/12 ended correctly, one of the following may be the cause.

Was an origin point specified in the program when outputting the data to the CX-24/12?

The origin points specified with the program are different during printing and during cutting. Refer to "8-4 Performing Operations Using Crop Marks - ■ Performing Cutting with the CX-24/12" and align the locations of the origin points specified with the CX-24/12 before you send the cutting data.

Was the size aspect changed between printing and cutting?

Enlarging or reducing the size when printing or when cutting makes it impossible for the crop marks to be read. Perform output at a size identical to the size of the design.

9 About the Blades and Materials

9-1 Blade and Material Combinations

The table below provides information on combinations of materials and blades, cutting conditions, and useful life.

The figures for blade life are only estimates. The conditions described below may not apply all cases.

Before you perform cutting, be sure to carry out a cutting test to check and adjust the quality. (See "[4-7 Performing a Cutting Test.](#)")

If uncut areas remain even when you raise the blade force more than 50 or 60 gf higher than the values shown below, the blade has reached the end of its service life. Replace with a new blade.

Blade	Material	Tool-force	Speed	Amount of cutter blade extension	Life of a blade (General guide)
ZEC-U1005	General Signage Vinyl	50 to 150 gf	40 cm/sec.	0.25 mm (0.01 in.)	8000 m (314960 in.)
ZEC-U5025	General Signage Vinyl	30 to 100 gf	40 cm/sec.	0.25 mm (0.01 in.)	4000 m (157480 in.)
	Fluorescent Vinyl	120 to 200 gf	40 cm/sec.	0.25 mm (0.01 in.)	4000 m (157480 in.)
	Reflective Vinyl	100 to 200 gf	40 cm/sec.	0.25 mm (0.01 in.)	4000 m (157480 in.)
ZEC-U1715	Rubber material for sandblasting stencil	100 to 200 gf	10 cm/sec.	0.25 mm (0.01 in.)	Varies according to material type

* The values for lifespan are intended to serve as a general guide when cutting materials of identical type.

9-2 About the Materials

Acceptable Material Widths

The location of the grit rollers (where the material is held in place by the pinch rollers) differs according to the model. Referring to the figure below, place the material on the grit rollers and check where it can be held in place by the pinch rollers.

CX-24

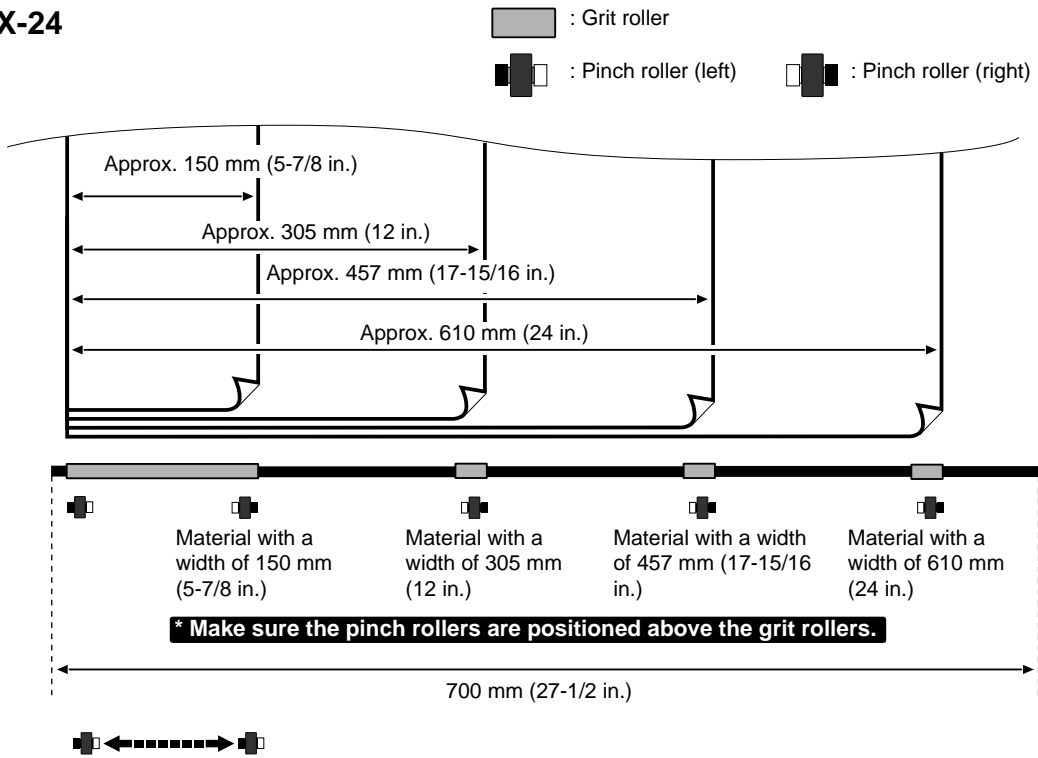

The left-hand pinch roller can be moved within this range.

When loading material with a width other than one indicated above, move the left-hand pinch roller.

CX-12

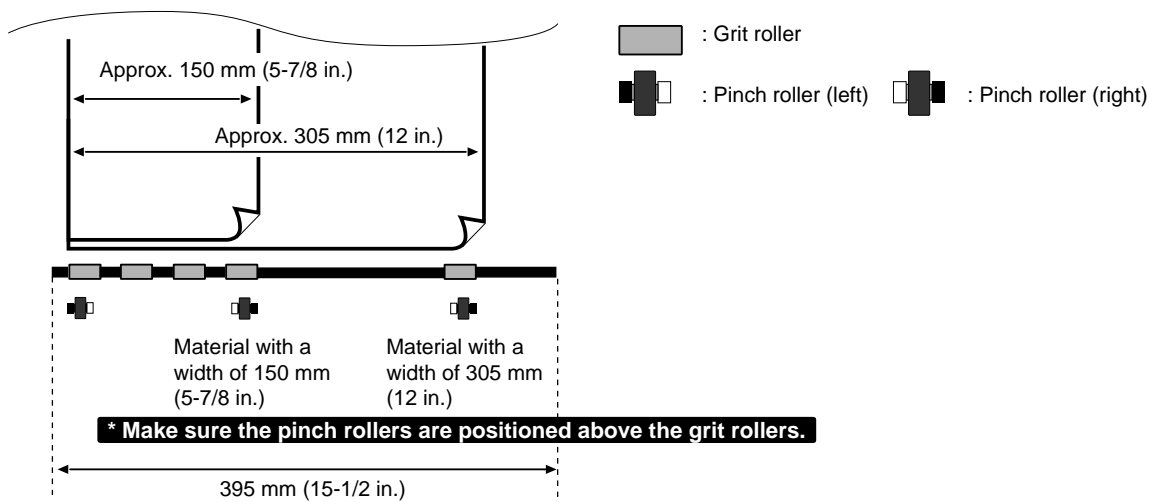

When loading material with a width other than one indicated above, move the left and right pinch rollers to match the width of the material.

■ About the Cutting Area

The cutting area along the horizontal plane (the direction in which the tool carriage moves) is determined by the position of the pinch rollers. The workable area spans the length between the two rollers, minus a margin of about 1 mm (about 0.04 in.) on both sides. If you selected [PIECE] on the CX-24, then when the length of the material is 1,600 mm (63 in.) or more, the CX-24 determines it to be roll material, and sets the length at 24,998 mm (984-1/8 in.).

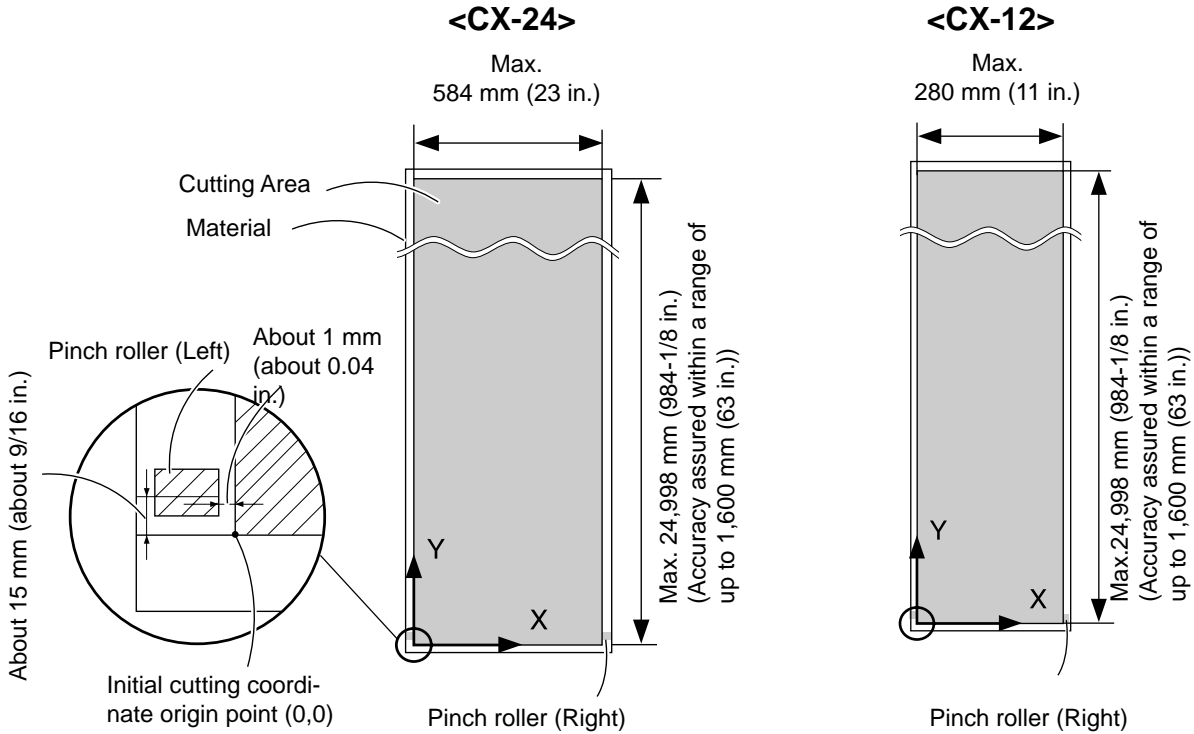

■ When Loading Flat Material

When you're using flat material, material that is at least 70 mm (2-13/16 in.) longer than the vertical size of the cutting data is required. This is the length required for the pinch rollers to feed out the material to the front and rear. Refer to the figure below and ensure margins at the front and rear of the material.

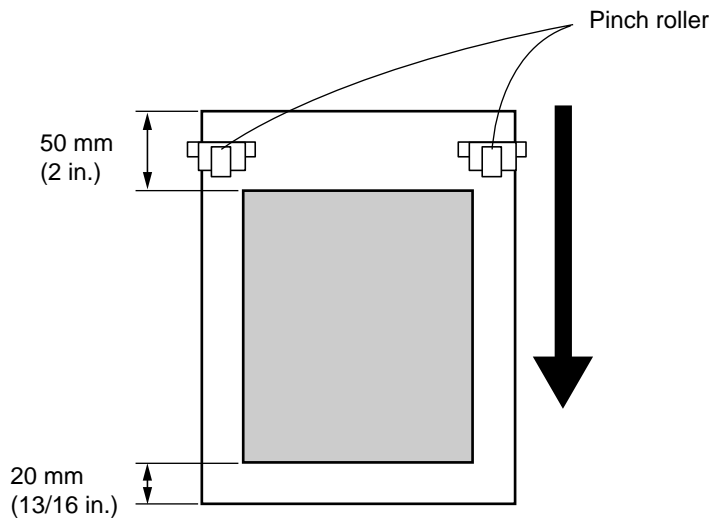

■ A Material with Edge Holes for Sprocket Feed

Material for sprocket-feed use has feed holes along both edges. If the material is loaded with these holes lying over the pinch rollers, material feed cannot be performed correctly. Do not put the pinch rollers on the hole area at the edges.

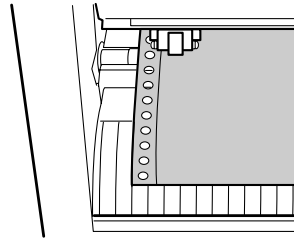

■ Rubber Sandblast Stencils

Use rubber sandblast stencils that meet the conditions shown in the figure at right.

A) Materials with a material thickness of 1 mm (0.04 in.) or less

B) Materials with only carrier paper on both flanks of the material

Position the left and right pinch rollers above the strips of carrier paper.)

C) Materials with carrier paper which is hard enough to withstand material feed

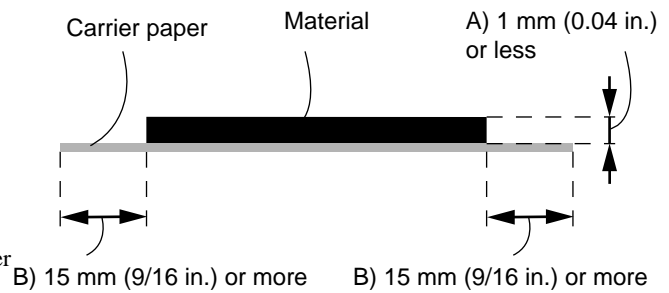

10 Display Menu Descriptions

10-1 How to Read This Chapter

The explanations in this chapter use the following format.

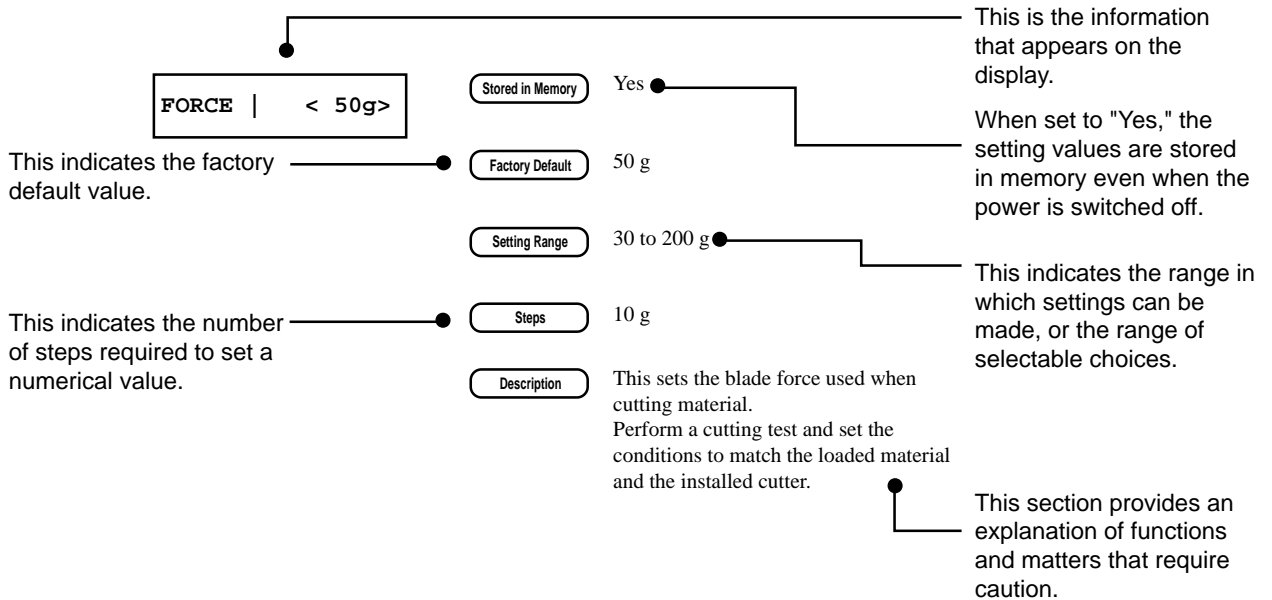

10-2 Display Menu Descriptions

To display the menu settings, press the [MENU/PARAM] key.

For detailed information on how to make menu settings, see "4-3 Turning on the Power - ■ Making Menu Settings with the Control Panel."

SELECT

SELECT | **ROLL**

* Only CX-24

- Stored in Memory** No
- Factory Default** ROLL
- Selection Choices** ROLL, EDGE, PIECE
- Description**

ROLL:
This performs cutting using roll material.

EDGE:
When using roll material, cutting is performed from the front-left edge of the material.

* When the setting for [ROTATE] on the display menu is [ON], cutting is performed from the front-right edge.

PIECE:
This performs cutting using standard-size material or piece material.

CROPMARK

CROPMARK | <OFF>

Stored in Memory Yes

Factory Default OFF

Selection Choices OFF, AUTO

Description This menu sets whether crop marks are read or not. The detailed instructions for cutting by using crop marks are in "[8 Cutting Printed Material](#)".
OFF:
 Select this when you perform cutting only. The CX-24/12 doesn't read the crop marks.
AUTO:
 The three crop marks are read automatically. This makes the correction of width, length, angle and the location of the origin point.

BASE X

BASE X | <5mm>

Stored in Memory Yes

Factory Default 5 mm

Setting Range 0 to 50 mm

Steps 0.1 mm

Description This specifies the distance in x-direction between the center of a crop mark and the origin point. Set the value to the radius of the crop marks specified by the program.

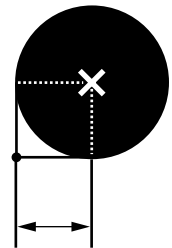

BASE Y

BASE Y | <5mm>

Stored in Memory Yes

Factory Default 5 mm

Setting Range 0 to 50 mm

Steps 0.1 mm

Description This specifies the distance in y-direction between the center of a crop mark and the origin point. Set the value to the radius of the crop marks specified by the program.

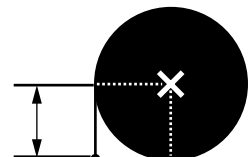

WIDTH

WIDTH | <170mm>

Stored in Memory Yes

Factory Default 170 mm

Setting Range 50 to 610 mm

Steps 1 mm

Description This sets the distance between the right crop mark and the left one shown in the figure at right. Specify the same value as the distance between two crop marks specified by the program.

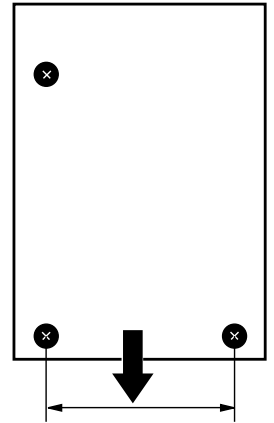

LENGTH

LENGTH | <210mm>

Stored in Memory Yes

Factory Default 210 mm

Setting Range 50 to 500 mm

Steps 1 mm

Description This sets the distance between the upper crop mark and the lower left one shown in the figure at right. Specify the same value as the distance between two crop marks specified by the program.

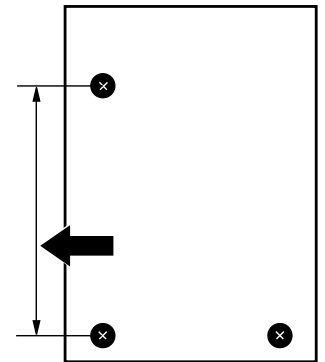

SETUP

SETUP | <ON>

Stored in Memory No

Selection Choices ON, OFF

Description When this is on, cutting data can be received and various menu settings can be made.

FORCE

FORCE | < 50g>

Stored in Memory Yes

Factory Default 50 g

Setting Range 30 to 200 g

Steps 10 g

Description This sets the blade force used when cutting material. Perform a cutting test and set the conditions to match the loaded material and the installed cutter.

SPEED

SPEED | <40cm/s>

Stored in Memory Yes

Factory Default 40 cm/s

Setting Range 1 to 40 cm/s

Steps 1 cm/s when in the range of 1 to 10 cm/s
5 cm/s when in the range of 10 to 40 cm/s

Description This sets the speed used when cutting material. Set this to a suitable value for the loaded material and installed blade.

OFFSET

OFFSET | <0.250>

Stored in Memory Yes

Factory Default 0.250 mm

Selection Choices 0 mm (PEN), 0.175 mm, 0.250 mm, 0.500 mm

Description This sets the amount of offset for the tip of the blade. Set a value that matches the conditions for the blade installed. When using the included test material and blade or equivalent parts, cutting can be performed using the factory-default settings.

AREA

AREA | < 1.0m>

Stored in Memory Yes

Factory Default 1.0 m

Selection Choices -24.9 to 24.9 m

Description This ensures that the material will not come loose during cutting by feeding out the length of material to be cut before actually performing cutting. When performing continuous cutting on the same material, this can also be used to make sure that there is enough remaining material to cut the data that will be sent.

REPLOT

REPLOT | START

Stored in Memory

No

Selection Choices

START, CLEAR

Description

START

This performs cutting using the data in the replot buffer when the [ENTER] key is pressed.

CLEAR

This deletes the data in the replot buffer when the [ENTER] key is pressed.

ROTATE

ROTATE | <OFF>

Stored in Memory

Yes

Factory Default

OFF

Selection Choices

ON, OFF

Description

When set to ON, the origin point is set at the lower right of the material, and the text (or image) is rotated by 90 degrees.

* When rotated, the coordinate axis changes.

The pairs of arrows indicate the positive directions along the X and Y axis

ROTATE: [ON]

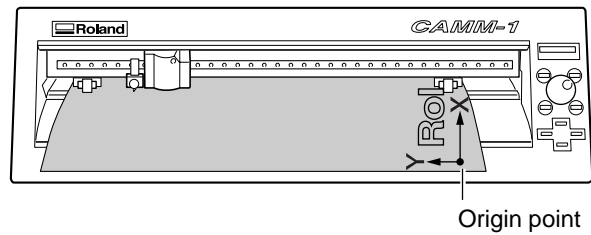

ROTATE: [OFF]

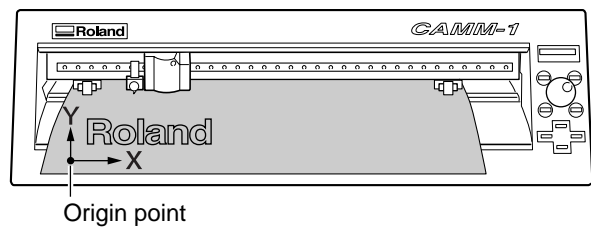

SMOOTH

SMOOTH . | <ON>

Stored in Memory

Yes

Factory Default

ON

Selection Choices

ON, OFF

Description

ON

This cuts smooth curves for circular arcs and the like.

Note that small text and intricate shapes may be cut with rounded corners.

OFF

Choose this if corners become rounded when set to [ON].

WEIGHT	WEIGHT <LIGHT>	Stored in Memory	Yes
		Factory Default	LIGHT
		Selection Choices	LIGHT, HEAVY
		Description	Sets the weight of the material. If material feed is not performed smoothly, set this switch to [HEAVY]. When set to [HEAVY], the upper limit for the cutting speed is set at 10 cm/sec., and the force used to move the material and the blade increases. This should normally be set to [LIGHT].
CALL	CALL <USER1>	Stored in Memory	Yes
		Factory Default	USER1
		Selection Choices	USER1 to 8
		Description	This calls up the setting values stored using [RESTORE].
RESTORE	RESTORE <USER1>	Stored in Memory	Yes
		Factory Default	USER1
		Selection Choices	USER1 to 8
		Description	This stores the setting values for the respective menu items that are now being used. The menu items that you can register are as follows. FORCE, SPEED, OFFSET, and WEIGHT
I/O	I/O <AUTO>	Stored in Memory	Yes You can call up stored setting by using [CALL].
		Factory Default	AUTO
		Selection Choices	AUTO, PARA, SERIAL
		Description	This specifies the type of interface for connection to the computer. AUTO This selects the port automatically. The communication parameters for a serial connection are set according to the settings made on the CX-24/12. If the interface is not recognized correctly when set to AUTO, use the menu to choose the type of interface you're using. PARA (PARALLEL) Choose this when connected to the computer using a parallel cable. SERIAL Choose this when connected to the computer using a serial cable.

#BAUD.	#BAUD. <9600>	Stored in Memory	Yes
		Factory Default	9600
		Selection Choices	9600, 4800
		Description	This sets the communication speed for a serial connection. It is effective only when connected to the computer using a serial cable.
#DATA.	#DATA. <8>	Stored in Memory	Yes
		Factory Default	8
		Selection Choices	8, 7
		Description	This sets the number of data bits for a serial connection. It is effective only when connected to the computer using a serial cable.
#STOP.	#STOP. <1>	Stored in Memory	Yes
		Factory Default	1
		Selection Choices	1, 2
		Description	This sets the number of stop bits for a serial connection. It is effective only when connected to the computer using a serial cable.
#PARITY	#PARITY <NONE>	Stored in Memory	Yes
		Factory Default	NONE
		Selection Choices	NONE, ODD, EVEN
		Description	This sets the type of parity checking for a serial connection. It is effective only when connected to the computer using a serial cable.
#HANDS.	#HANDS. <H-WIRE>	Stored in Memory	Yes
		Factory Default	H-WIRE
		Selection Choices	H-WIRE, XONOFF
		Description	This makes the setting for hardware handshaking (flow control) for a serial connection. It is effective only when connected to the computer using a serial cable.

LANG.

LANG. | < ENGLIS >

Stored in Memory

Yes

Factory Default

ENGLISH

Selection Choices

ENGLIS, ニホンゴ, Deut., FRANÇ, ESPAÑ, ITAL.,PORTUG,

Description

This selects the language for messages on the display. To display this menu, switch on the power while holding down the [MENU/PARAM] key.

UNIT

UNIT | <Metric >

Stored in Memory

Yes

Factory Default

Metric

Selection Choices

Metric, Inch

Description

This selects the unit of measurement for numerical values shown on the display.
To display this menu, switch on the power while holding down the [MENU/PARAM] key, then turn the dial clockwise.

DEMO CUT

DEMO CUT

Description

This menu is for performing checks when the CX-24/12 is not operating correctly.
To display this menu, switch on the power while holding down the [▲] key.

INITIALIZE EEROM

INITIALIZE EEROM

Description

This resets the display menu values to the same settings as their factory defaults.
However, the settings for “LANG.” and “UNIT” are not returned to the factory defaults.
To display this menu, switch on the power while holding down the [ENTER] key.

11 Display Menu Flowchart

To display the setting values for the various menu items, press the [MENU/PARAM] key. For detailed information on how to make menu settings, see "4-3 Turning on the Power - Making Menu Settings with the Control Panel."

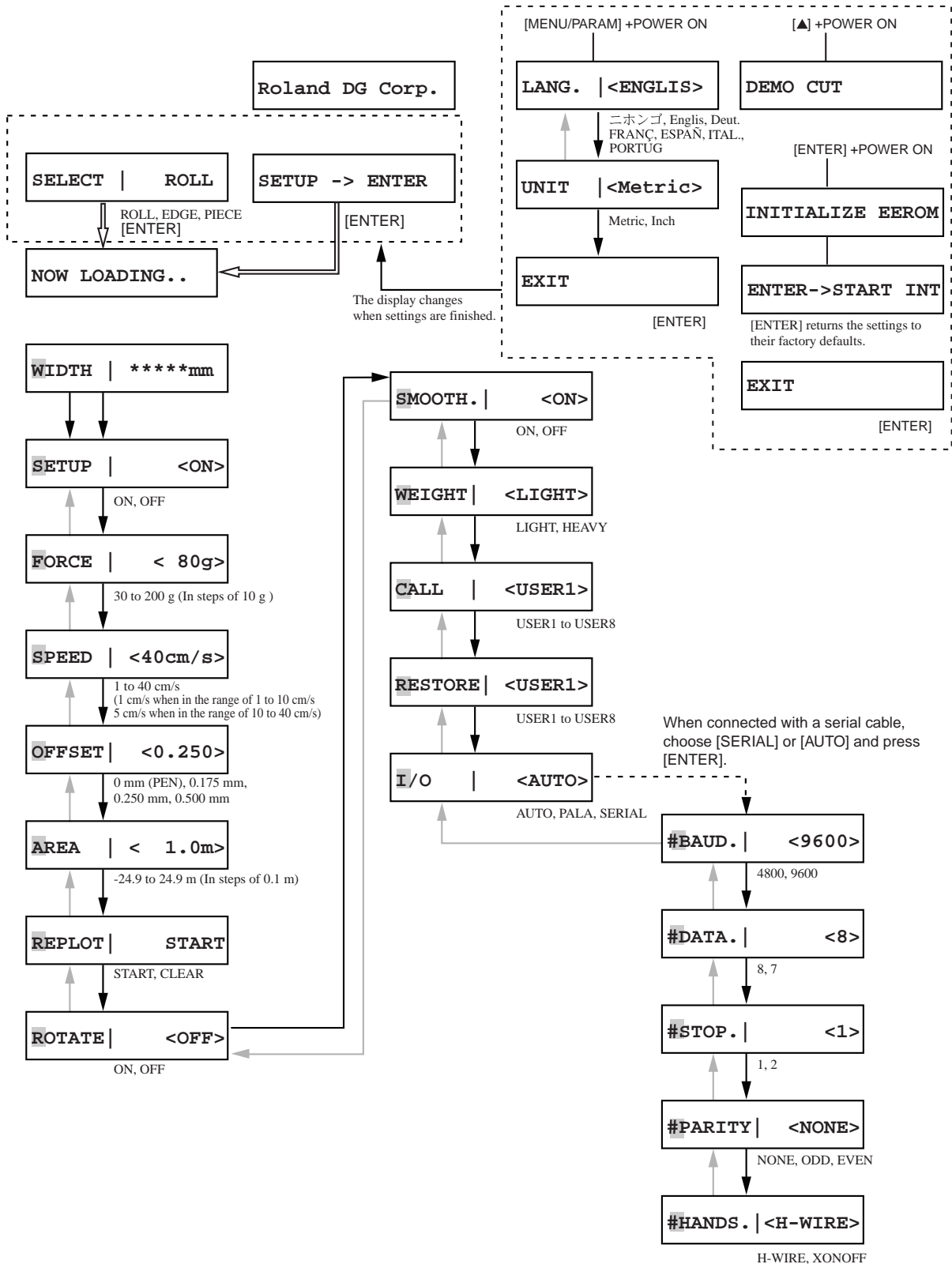

■ Display Menu Flowchart When Using Crop Marks

For detailed information about the menu when using crop marks, refer to "8 Cutting Printed Material", "10 Display Menu Descriptions - CROPMARK".

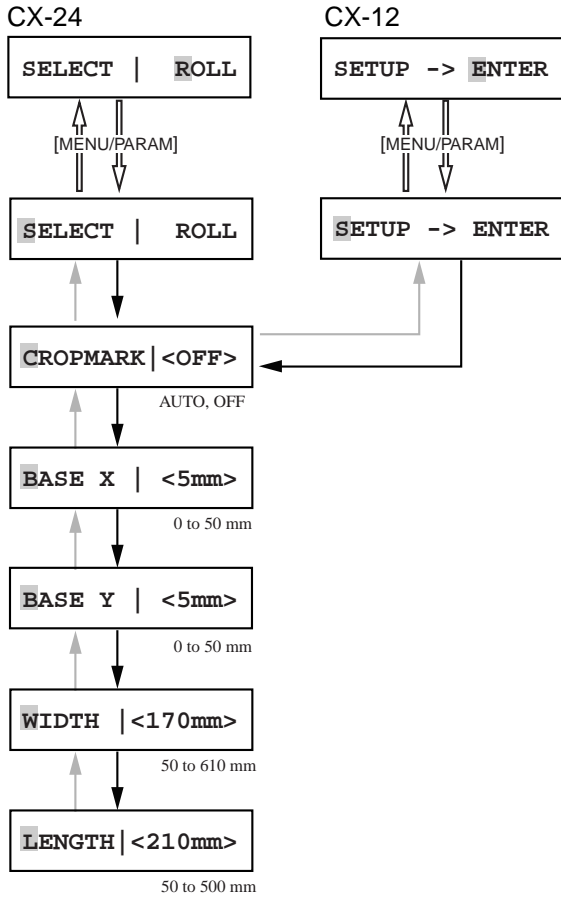

12 What to Do If...

12-1 If the CX-24/12 Doesn't Run...

Is the CX-24/12 power on?
Turn on the power.

Is the CX-24/12 in the setup state?
When the display shows the following message, cutting cannot be performed even when data is sent. When you enable the setup state, cutting starts.

CX-24

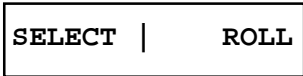

Choose the loaded material, then press the [ENTER] key to enable the setup state.

CX-12

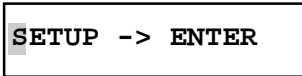

Press the [ENTER] key to enable the setup state.

Has operation been paused?
When the following message appears, operation is paused.
To resume cutting, press the [ENTER] key.



To stop operation

- 1 Halt transmission of cutting instructions from the computer.
- 2 Turn the dial to display the screen shown at right, then press the [ENTER] key.

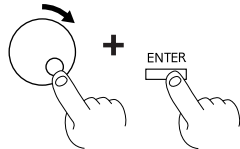

If connected via the serial port, do the communication parameters for the CX-24/12 match those of the computer?
Use the display menu to set communication parameters for the CX-24/12 that match the communication parameters for the computer.

Is the computer set up correctly?
Refer to the documentation for the computer you're using and make the correct settings for the memory switches, interface board, and other communication parameters.

Is the cable used for the connection to the computer connected correctly?
Check the output ports on the CX-24/12 and the computer and reconnect correctly.

Are the computer and the CX-24/12 linked with the right cable?
The type of cable you need is determined by your computer and the program you are using. Even if the computer is the same, running different program may require a different cable. Use the cable specified in your program.

Are the program settings correct? (Using with MS-DOS.)
Specified output device (Select a model name that matches the instruction set. If the instruction set is different, completely different instructions may be sent, resulting in an error.)
Refer to the documentation for the program and make the correct settings for the communication parameters and other values.

12 What to do if...

Has the correct driver selection been made for the application program? (Using with Windows.)

Select the appropriate CX-24/12 driver.

For the CX-24:

[Roland CAMM-1 CX-24]

For the CX-12:

[Roland CAMM-1 CX-12].

Are the settings for the driver program correct? (Using with Windows.)

Make the correct settings for the output port and communication parameters.

12-2 The Material Slips Away from the Pinch Rollers During the Cutting Process

Are the sheet loading levers lowered?

If the sheet loading levers are raised, then make sure the left and right pinch rollers are within the edged of the material and lower the sheet loading levers. (Refer to "[4-2 Loading the Material](#)".)

Is the material loaded in parallel with the grit rollers?

If the front edge of the material is cut at an angle, trim off an excess portion so that the front edge is parallel with the grit rollers, then load the material.

Is the material making contact somewhere while cutting is in progress?

Make sure that the left and right edges of the material do not make contact with the inner surfaces of the CX-24/12 during cutting. Such contact may not only damage the material, but may make normal material feed impossible or cause the material to slip.

When feeding lengthy material, was a check made before cutting to make sure that the material does not slip?

Use the [AREA] display menu to feed out the amount of material to be used (plus a margin of about 0.1 m), and make sure the material does not come loose from the pinch rollers.

Are the pinch rollers damaged or deformed?

If the material comes loose even when it is loaded correctly, the useful life of the pinch rollers has ended.

If this happens, contact your authorized Roland DG Corp. dealer or service center. (Replacement is a charged service operation.)

12-3 Uncut Areas Remain, or Areas Are Not Cleanly Cut

Are the blade and blade holder securely mounted?
Install these so that there is no looseness .

The blade may be broken.
Replace with a new blade.

Is there any buildup of dust or material adhesive on the tip of the blade?
Check if there are any dirty deposits on the blade. If dirty, remove and clean the blade.

Is there any buildup of pieces of material or dust inside the blade holder?
Take off the tip of the blade holder and remove any pieces of material inside.



Is the amount of blade extension correct?
If the setting for the amount of blade compensation is not correct for the blade, corners may be rounded or have horns.
Refer to "4-7 Performing a Cutting Test - [Adjusting the Amount of Blade Extension.](#)"

Are the blade force and cutting speed appropriate for the material being cut?
Perform a cutting test and use the display menu to make the settings for suitable values.
Refer to "4-7 Performing a Cutting Test - [Adjusting the Blade Force.](#)"

Is the blade protector damaged or deformed?
If material is not cut properly even though the CX-24/12 settings are correct and the blade and cutter holder are installed correctly, the blade protector may be damaged. If this happens, contact your authorized Roland DG Corp. dealer or service center. (Replacement is a charged service operation.)

12-4 The Results of Cutting Are Displaced, and Uncut Portions Remain

Is a thick material being used?
When using a thick material, change the display menu setting from "WEIGHT" to "HEAVY."

When performing cutting using roll material, was the amount of material to be cut pulled out before performing cutting.
When the material is pulled out while cutting is being performed, the material may slip or operation may stop due to a motor error.

12-5 Error Messages

Err:Bad Positin

The location of one or more of the pinch rollers is not correct. Press the [ENTER] key to clear the error. Position the pinch rollers appropriately over the grit rollers and reload the material. Refer to "[4-2 Loading the Material](#)."

If this message appears even when you have moved the pinch rollers to appropriate locations, the CX-24/12 may be exposed to direct sunlight or strong indoor lighting. To correct this, switch off the power and move the CX-24/12 to a location that is not exposed to strong light. After moving the unit, switch the power back on.

SHEET UNLOADED

When the machine was put into the setup state, no material was loaded. The material was removed when the machine was in the setup state. The material came loose during cutting. Load the material, then put the machine in the setup state. Press the [ENTER] key to clear the error. Refer to "[4-2 Loading the Material](#)."

DATA OVERFLOW

When [RELOT] was executed, the amount of data sent from the computer exceeded the buffer size of the CX-24/12. Reduce the amount of data, then execute [RELOT]. Refer to "[7 Repeating the Same Cutting](#)."

DATA EMPTY

[RELOT] was executed when there was no data in the buffer. Send the data from the computer, then execute [RELOT]. Refer to "[7 Repeating the Same Cutting](#)."

Origin Error

The CX-24/12 is exposed to direct sunlight or strong indoor lighting, and was not able to perform origin detection immediately after the power was switched on. To correct this, switch off the power and move the CX-24/12 to a location that is not exposed to strong light. Then switch on the power again.

About the error messages displayed when reading crop marks, refer to "[8-5 When Crop Marks Cannot Be Read](#)".

The following error messages are displayed for informational purposes when the data described in "Details" is sent. When one of these error messages appears on the display, sending of data stops and you are not allowed to perform the next operation.

Press the [ENTER] key to clear the error from the display.

Note that even after you clear the error message, the CX-24/12 retains in memory the fact that the error occurred, and so correct cutting may not be possible even if data continues to be sent. To cancel the error, switch the power off and back on.

Er1:Wrong CMD.

Meaning

Appears if an instruction that the CX-24/12 cannot interpret is sent.

Er2:Wrong No.s

Meaning

Appears if the number of parameters differs from the permissible number.

Er3:Out of Range

Meaning

Appears if the value specified for a parameter is out of the permissible range.

Er15:RS-232Err

Meaning

Appears if a framing error, parity error, or overrun error occurs at the time of data reception. The protocol settings for the CX-24/12 must be made correctly in order to match the settings your computer is set to use.)

Er16:BufferFlow

Meaning

Appears if the I/O buffer has overflowed. There is a problem with the connecting cable, or the settings for Handshaking. Make sure you are using a cable appropriate for the computer being used. Also, check that the setting for Handshaking is correct.

Er18:Ind.Error

Meaning

This appears if an unspecified communication error other than communication-related errors 10 through 16 occurs.

13 Instruction Support Chart

A "CAMM-GL III Programmer's Manual" is available for separate purchase for those wishing to create their own programs for this machine. For further information, please contact your authorized Roland dealer or service center.

The list uses marks, each of which means:

○ : Compatible ● : Ignored ✕ : Incompatible

mode 1

Instruction	Compatibility	Instruction	Compatibility	Instruction	Compatibility	Instruction	Compatibility	Instruction	Compatibility
H	○	D	○	M	○	I	○	R	○
L	○	B	○	X	○	P	○	S	○
Q	○	N	○	C	○	E	○	A	○
G	○	K	○						
T	○	^	○						

mode 2

Instruction	Compatibility	Instruction	Compatibility	Instruction	Compatibility	Instruction	Compatibility	Instruction	Compatibility
AA	○	AR	○	CA	○	CI	○	CP	○
CS	○	DF	○	DI	○	DR	○	DT	○
EA	○	ER	○	EW	○	FT	○	IM	○
IN	○	IP	○	IW	○	LB	○	LT	○
OA	○	OC	○	OE	○	OF	○	OH	○
OI	○	OO	○	OP	○	OS	○	OW	○
PA	○	PD	○	PR	○	PT	○	PU	○
RA	○	RR	○	SA	○	SC	○	SI	○
SL	○	SM	○	SR	○	SS	○	TL	○
UC	○	VS	○	WG	○	XT	○	YT	○
WD	●	SP	●						

Instruction in mode 1 and mode 2

Instruction	Compatibility	Instruction	Compatibility	Instruction	Compatibility	Instruction	Compatibility	Instruction	Compatibility
!NR	○	!PG	○	!ST	○	!FS	●		

14 Specifications

	CX-24	CX-12
Driving method	Media-movement method Stepping motor (Micro-step)	
Maximum cutting area	Width: 584 mm (22-15/16 in.) Length: 24,998 mm (984-1/8 in.)	Width: 280 mm (11 in.) Length: 24,998 mm (984-1/8 in.)
Acceptable media widths	50 to 700 mm (1-15/16 to 27-1/2 in.)	50 to 395 mm (1-15/16 to 15-1/2 in.)
Acceptable paper widths	50 to 700 mm (1-15/16 to 27-1/2 in.)	50 mm to 395 mm (1-15/16 to 15-1/2 in.)
Acceptable paper types	High-quality paper	
Tools	Cutters: Special cutter for CAMM-1 series Pens: Water-based fiber-tipped pens, and Thick water-based fiber-tipped pens (options)	
Max. cutting speed	During cutting: 400 mm/sec. (15-11/16 in./sec.) (45-degree direction) (when [HEAVY] is selected on the display menu: 100 mm/sec. (3-7/8 in./sec.))	
Blade force	30 to 200 gf	
Mechanical resolution	0.05 mm/step (0.00197 in./step)	
Software resolution	0.025 mm/step (0.000984 in./step)	
Distance accuracy	Error of less than +/- 0.2% of distance traveled, or 0.1 mm (0.00394 in.), whichever is greater	
Repetition accuracy	0.1 mm (0.00394 in.) or less (Excluding stretching/contraction of the material, and provided that material length is under 1600 mm (62-15/16 in.))	
Alignment accuracy for printing and cutting when loading printed material	±3 mm (0.12 in.) or less with 500 mm (19-5/8 in.) or less of movement distance in the material-feed direction (Excluding the affects of program accuracy and printer accuracy) *1	
Interface	Parallel (Centronics compatible), Serial (RS-232C)	
Buffer size	1 Mbyte (800 Kbyte for replot buffer)	
Instruction system	CAMM-GLIII (mode1 and mode2)	
Switches	Power switch	
Control switches	Dial, TEST, ORIGIN, ▲, ▼, ◀, ▶, ENTER, MENU/PARAM	
Display	Liquid crystal display unit: 16-character by 1 line	
Power consumption	Maximum: 0.9 A /100 to 240 V ± 10 % 50/60 Hz	
Acoustic noise level	[Cutting mode] : less than 70 dB (A) [Standby mode] : less than 40 dB (A) (According to ISO 7779)	
Dimensions	850 mm (W) x 300 mm (D) x 240 mm (H) (33-1/2 in. (W) x 11-13/16 in. (D) x 9-1/2 in. (H))	545 mm (W) x 300 mm (D) x 240 mm (H) (21-1/2 in. (W) x 11-13/16 in. (D) x 9-1/2 in. (H))
Weight	14 kg (30.9 lb.)	10 kg (22 lb.)
Operating temperature	5 to 40°C (41 to 104°F)	
Operating humidity	35 to 80% (non-condensing)	
Accessories	Power Cord x 1, Blade x 1, Blade Holder XD-CH3 (Cutter holder and pin) x 1, Startup Manual x 1, To Ensure Safe Use x1, Roland Software Package CD-ROM x 1, Roller base x 1*2	

- *1 - The printer must be a laser or inkjet printer with a resolution of 720 dpi or higher.
 - No lamination
 - Excludes the effects of slanted movement and of expansion, contraction and warping of the material.

- *2 CX-24 only

Parallel

Standard	In compliance with the specifications of Centronics
Input signals	STROBE (1 BIT), DATA (8 BITS)
Output signals	BUSY (1 BIT), ACK (1 BIT)
Level of input/output signals	TTL level
Transmission method	Asynchronous

Serial

Standard	RS-232C specifications
Transmission method	Asynchronous, duplex data transmission
Transmission speed	4800, 9600 (Selected using panel keys.)
Parity check	Odd, Even, or None (Selected using panel keys.)
Data bits	7 or 8 bits (Selected using panel keys.)
Stop bits	1 or 2 bits (Selected using panel keys.)
Handshake	Hardwire (power on) or XON/XOFF (Selected using panel keys.)

Parallel connector (in compliance with specifications of Centronics)

Signal number	Terminal number	Signal number	Pin Connection
NC	36 18	HIGH*	
HIGH*	35 17	GND	
NC	34 16	GND	
GND	33 15	NC	
HIGH*	32 14	NC	
NC	31 13	HIGH*	
GND	30 12	GND	
	29 11	BUSY	
	28 10	ACK	
	27 9	D7	
	26 8	D6	
	25 7	D5	
	24 6	D4	
	23 5	D3	
	22 4	D2	
	21 3	D1	
	20 2	D0	
	19 1	STROBE	

Serial connector (RS-232C)

Signal number	Terminal number	Signal number	Pin Connection
NC	25 13	NC	
NC	24 12	NC	
NC	23 11	NC	
NC	22 10	NC	
NC	21 9	NC	
DTR	20 8	NC	
NC	19 7	SG	
NC	18 6	DSR	
NC	17 5	CTS	
NC	16 4	RTS	
NC	15 3	RXD	
NC	14 2	TXD	
	1	FG	

Index

A

Acceptable material widths	52
Affix the material	34
Amount of blade extension	28, 67
AREA	58
AUTO	60

B

BASE X	56
BASE Y	56
#BAUD	61
Bit rate	17
Blade and material combinations	51
Blade holder	67
Blade life	51
Blade protector	10, 21, 67
Buffer	39

C

CALL	60
CAMM-1 Driver	14, 30, 31
CLEAR	39, 59
Control panel	23
Crop mark	41
CROPMARK	56
AUTO	46, 56
Display menu flowchart	64
Distance	44, 46
Layout	42, 50
LENGTH	57
Origin point	46, 48, 50
WIDTH	57
Crossover serial cable	13
Cutting area	29, 53
Cutting carriage	10
Cutting test	27

D

Data bit	17
#DATA	61
Dial	11
Display	11
Display menu descriptions	55
Display menu flowchart	63
Driver selection	66

E

EDGE	22, 26, 55
Error messages	68
EVEN	61

F

Flat material	22, 29, 53
Flow control	17, 61
FORCE	58

G

Grit roller	10
Guide line marks	10, 21

H

#HANDS	61
Hardware handshaking	17, 61
HEAVY	60, 67
How to view the display	23

I

I/O	60
Installing	14
Installing blade	18
Instruction support chart	70

K

Knife guide	10, 35
-------------------	--------

L

LIGHT	60
Loading the material	19
Location of the origin point	26

M

Material feed	24
Material sizes	19
[MENU/PARAM] key	11, 23

N

NONE	61
------------	----

O

ODD	61
OFFSET	58
Operation panel	11
[ORIGIN] key	11, 26
Origin point	26

P

Paper media	38
PARA	60
Parallel cable	13
Parallel (Centronics) Input Connector	10
#PARITY	61
Parity checking	17
Pausing cutting operation	32, 65
Pen	38
Performing long cutting	25
PIECE	22, 24, 26, 55
Piece material	20
Pinch roller	10, 66
Plotting	38
Port setting	15
Position key	11

Index

Positioning the grit rollers 20

R

Recutting 40
Removing the material 34
RELOT 39, 59
RESTORE 60
ROLL 22, 26, 55
Roll material 19, 20
Roller base 20
ROTATE 59
Rubber sandblast stencils 54

S

SELECT 55
Self-test 37
SERIAL 60
Serial cable 13
Serial input connector 10
Setting 12
Setting the blade force 28
Settings for the driver 66
SETUP 57
Setup state 22, 65
Sheet loading lever 10, 21, 34
[Size] tab 30
SMOOTH 59
Specifications 71
SPEED 58
Sprocket feed 54
START 59
Stop bit 17
#STOP 61

T

[TEST] key 11, 27
To stop cutting 33
[Tools] tab 30
Turning on the power 22

U

USER 60

W

WEIGHT 60, 67

X

XONOFF 61

