

## Owner's Manual

Thank you, and congratulations on your choice of the Roland Digital Piano FP-5.

### Main Features

#### Stylish, Light, Compact Design

The refined design fits in anywhere; and since it is so lightweight and compact, it's easy to take the instrument with you wherever you go.

#### Authentic Piano Performances

Features high-quality concert grand piano sounds and a Progressive Hammer Action keyboard that gives a more realistic piano touch by providing a heavier feel in the low end and a lighter feel in the upper notes.

In addition, the FP-5 is equipped with three pedal jacks and comes with a half-damper pedal capable of adjusting the depth of the resonance, combining to allow you to enjoy truly authentic piano performances.

#### Wide Variety of Tones For Use in Many Musical Genres

The FP-5 offers not just piano sounds, but over 50 different onboard sounds that can be used in a wide variety of musical styles.

You can also play Drum Sets with the instrument.

Additionally, the high-quality effects allow you to add more richness and expression to the sound.

#### "Tone Wheel Mode" Simulates Creation of Organ Sounds

Now, you can simulate the way organ sounds are created using the harmonic bars. You can turn footages on and off and set their volumes to make fine adjustments in the sound.

#### "Session Partner" Lets You Enjoy Playing with a Session-Like Feel

Enjoy true session-like feel while performing along with a "rhythm" section built upon realistic-sounding "rhythms."

You can specify the "rhythm" chord progression with your left hand, and create original chord progressions as well.

#### Experience a Variety of Performances with Dual and Split Functions

Layer two of the FP-5's many internal tones, play with different tones assigned to the left and right sections of the keyboard, and enjoy many other possibilities in working with Performances.

#### Easy Recording Functions

You can easily record your own performances using simple button operations.

#### Includes USB Connector

Connect your computer to the FP-5's USB connector and exchange MIDI data.

#### High-quality Speaker Provided

Enjoy listening to powerful, moving performances thanks to the high-quality speaker.

Before using this unit, carefully read the sections entitled: "USING THE UNIT SAFELY" and "IMPORTANT NOTES" (p. 2; p. 4). These sections provide important information concerning the proper operation of the unit. Additionally, in order to feel assured that you have gained a good grasp of every feature provided by your new unit, Owner's manual should be read in its entirety. The manual should be saved and kept on hand as a convenient reference.

# USING THE UNIT SAFELY

## INSTRUCTIONS FOR THE PREVENTION OF FIRE, ELECTRIC SHOCK, OR INJURY TO PERSONS

### About ⚠ WARNING and ⚠ CAUTION Notices

<b>⚠ WARNING</b>	Used for instructions intended to alert the user to the risk of death or severe injury should the unit be used improperly.
<b>⚠ CAUTION</b>	Used for instructions intended to alert the user to the risk of injury or material damage should the unit be used improperly. * Material damage refers to damage or other adverse effects caused with respect to the home and all its furnishings, as well to domestic animals or pets.

### About the Symbols

	The ⚠ symbol alerts the user to important instructions or warnings. The specific meaning of the symbol is determined by the design contained within the triangle. In the case of the symbol at left, it is used for general cautions, warnings, or alerts to danger.
	The ⓧ symbol alerts the user to items that must never be carried out (are forbidden). The specific thing that must not be done is indicated by the design contained within the circle. In the case of the symbol at left, it means that the unit must never be disassembled.
	The ● symbol alerts the user to things that must be carried out. The specific thing that must be done is indicated by the design contained within the circle. In the case of the symbol at left, it means that the power-cord plug must be unplugged from the outlet.

### ALWAYS OBSERVE THE FOLLOWING







#### ⚠ WARNING

- Before using this unit, make sure to read the instructions below, and the Owner's Manual.
- Do not open (or modify in any way) the unit or its AC adaptor.
- Do not attempt to repair the unit, or replace parts within it (except when this manual provides specific instructions directing you to do so). Refer all servicing to your retailer, the nearest Roland Service Center, or an authorized Roland distributor, as listed on the "Information" page.
- Never use or store the unit in places that are:
  - Subject to temperature extremes (e.g., direct sunlight in an enclosed vehicle, near a heating duct, on top of heat-generating equipment); or are
  - Damp (e.g., baths, washrooms, on wet floors); or are
  - Humid; or are
  - Exposed to rain; or are
  - Dusty; or are
  - Subject to high levels of vibration.
- This unit should be used only with a rack or stand that is recommended by Roland.
- When using the unit with a rack or stand recommended by Roland, the rack or stand must be carefully placed so it is level and sure to remain stable. If not using a rack or stand, you still need to make sure that any location you choose for placing the unit provides a level surface that will properly support the unit, and keep it from wobbling.











#### ⚠ WARNING

- Be sure to use only the AC adaptor supplied with the unit. Also, make sure the line voltage at the installation matches the input voltage specified on the AC adaptor's body. Other AC adaptors may use a different polarity, or be designed for a different voltage, so their use could result in damage, malfunction, or electric shock.
- Use only the attached power-supply cord. Also, the supplied power cord must not be used with any other device.
- Do not excessively twist or bend the power cord, nor place heavy objects on it. Doing so can damage the cord, producing severed elements and short circuits. Damaged cords are fire and shock hazards!
- This unit, either alone or in combination with an amplifier and headphones or speakers, may be capable of producing sound levels that could cause permanent hearing loss. Do not operate for a long period of time at a high volume level, or at a level that is uncomfortable. If you experience any hearing loss or ringing in the ears, you should immediately stop using the unit, and consult an audiologist.
- Do not allow any objects (e.g., flammable material, coins, pins); or liquids of any kind (water, soft drinks, etc.) to penetrate the unit.

## WARNING

- Immediately turn the power off, remove the AC adaptor from the outlet, and request servicing by your retailer, the nearest Roland Service Center, or an authorized Roland distributor, as listed on the "Information" page when:
  - The AC adaptor, the power-supply cord, or the plug has been damaged; or
  - If smoke or unusual odor occurs
  - Objects have fallen into, or liquid has been spilled onto the unit; or
  - The unit has been exposed to rain (or otherwise has become wet); or
  - The unit does not appear to operate normally or exhibits a marked change in performance.
- In households with small children, an adult should provide supervision until the child is capable of following all the rules essential for the safe operation of the unit.
- Protect the unit from strong impact. (Do not drop it!)
- Do not force the unit's power-supply cord to share an outlet with an unreasonable number of other devices. Be especially careful when using extension cords—the total power used by all devices you have connected to the extension cord's outlet must never exceed the power rating (watts/amperes) for the extension cord. Excessive loads can cause the insulation on the cord to heat up and eventually melt through.
- Before using the unit in a foreign country, consult with your retailer, the nearest Roland Service Center, or an authorized Roland distributor, as listed on the "Information" page.
- DO NOT play a CD-ROM disc on a conventional audio CD player. The resulting sound may be of a level that could cause permanent hearing loss. Damage to speakers or other system components may result.

## CAUTION

- The unit and the AC adaptor should be located so their location or position does not interfere with their proper ventilation.
- This (FP-5) for use only with Roland stand FPS-11A. Use with other stands is capable of resulting in instability causing possible injury.
- Always grasp only the plug on the AC adaptor cord when plugging into, or unplugging from, an outlet or this unit.
- At regular intervals, you should unplug the AC adaptor and clean it by using a dry cloth to wipe all dust and other accumulations away from its prongs. Also, disconnect the power plug from the power outlet whenever the unit is to remain unused for an extended period of time. Any accumulation of dust between the power plug and the power outlet can result in poor insulation and lead to fire.
- Try to prevent cords and cables from becoming entangled. Also, all cords and cables should be placed so they are out of the reach of children.
- Never climb on top of, nor place heavy objects on the unit.
- Never handle the AC adaptor or its plugs with wet hands when plugging into, or unplugging from, an outlet or this unit.
- Before moving the unit, disconnect the AC adaptor and all cords coming from external devices.
- Before cleaning the unit, turn off the power and unplug the AC adaptor from the outlet ( p. 8).
- Whenever you suspect the possibility of lightning in your area, disconnect the AC adaptor from the outlet.
- Should you remove screws for the stand or the music stand, make sure to put them in a safe place out of children's reach, so there is no chance of them being swallowed accidentally.

# IMPORTANT NOTES

In addition to the items listed under “USING THE UNIT SAFELY” on page 2 and 3, please read and observe the following:

## Power Supply

- Do not connect this unit to same electrical outlet that is being used by an electrical appliance that is controlled by an inverter (such as a refrigerator, washing machine, microwave oven, or air conditioner), or that contains a motor. Depending on the way in which the electrical appliance is used, power supply noise may cause this unit to malfunction or may produce audible noise. If it is not practical to use a separate electrical outlet, connect a power supply noise filter between this unit and the electrical outlet.
- The AC adaptor will begin to generate heat after long hours of consecutive use. This is normal, and is not a cause for concern.
- Before connecting this unit to other devices, turn off the power to all units. This will help prevent malfunctions and/or damage to speakers or other devices.

## Placement

- Using the unit near power amplifiers (or other equipment containing large power transformers) may induce hum. To alleviate the problem, change the orientation of this unit; or move it farther away from the source of interference.
- This device may interfere with radio and television reception. Do not use this device in the vicinity of such receivers.
- Noise may be produced if wireless communications devices, such as cell phones, are operated in the vicinity of this unit. Such noise could occur when receiving or initiating a call, or while conversing. Should you experience such problems, you should relocate such wireless devices so they are at a greater distance from this unit, or switch them off.
- Do not expose the unit to direct sunlight, place it near devices that radiate heat, leave it inside an enclosed vehicle, or otherwise subject it to temperature extremes. Excessive heat can deform or discolor the unit.
- When moved from one location to another where the temperature and/or humidity is very different, water droplets (condensation) may form inside the unit. Damage or malfunction may result if you attempt to use the unit in this condition. Therefore, before using the unit, you must allow it to stand for several hours, until the condensation has completely evaporated.
- Do not allow objects to remain on top of the keyboard. This can be the cause of malfunction, such as keys ceasing to produce sound.

## Maintenance

- For everyday cleaning wipe the unit with a soft, dry cloth or one that has been slightly dampened with water. To remove stubborn dirt, use a cloth impregnated with a mild, non-abrasive detergent. Afterwards, be sure to wipe the unit thoroughly with a soft, dry cloth.
- Never use benzine, thinners, alcohol or solvents of any kind, to avoid the possibility of discoloration and/or deformation.

## Additional Precautions

- Please be aware that the contents of memory can be irretrievably lost as a result of a malfunction, or the improper operation of the unit. To protect yourself against the risk of losing important data, we recommend that you periodically save a backup copy of important data you have stored in the unit's memory in another MIDI device (e.g., a sequencer).
- Unfortunately, it may be impossible to restore the contents of data that was stored in another MIDI device (e.g., a sequencer) once it has been lost. Roland Corporation assumes no liability concerning such loss of data.
- Use a reasonable amount of care when using the unit's buttons, sliders, or other controls; and when using its jacks and connectors. Rough handling can lead to malfunctions.
- When connecting / disconnecting all cables, grasp the connector itself—never pull on the cable. This way you will avoid causing shorts, or damage to the cable's internal elements.
- To avoid disturbing your neighbors, try to keep the unit's volume at reasonable levels. You may prefer to use headphones, so you do not need to be concerned about those around you (especially when it is late at night).
- When you need to transport the unit, package it in the box (including padding) that it came in, if possible. Otherwise, you will need to use equivalent packaging materials.
- Use only the specified expression pedal (EV-5; sold separately). By connecting any other expression pedals, you risk causing malfunction and/or damage to the unit.
- Use a cable from Roland to make the connection. If using some other make of connection cable, please note the following precautions.
  - Some connection cables contain resistors. Do not use cables that incorporate resistors for connecting to this unit. The use of such cables can cause the sound level to be extremely low, or impossible to hear. For information on cable specifications, contact the manufacturer of the cable.

## Handling CD-ROMs

- Avoid touching or scratching the shiny underside (encoded surface) of the disc. Damaged or dirty CD-ROM discs may not be read properly. Keep your discs clean using a commercially available CD cleaner.

# Contents

USING THE UNIT SAFELY .....	2
IMPORTANT NOTES .....	4
Panel Descriptions .....	6

## **Before You Play ..... 8**

Making Connections .....	8
Installing the Music Stand .....	8
Connecting Pedals.....	9
Turning the Power On and Off.....	9
Adjusting the Sound's Volume and Brilliance.....	10
Connecting Headphones.....	10

## **Chapter 1 Playing the Keyboard..... 11**

Listening to Demo Songs .....	11
Listening to Internal Songs .....	12
Playing Back All Songs Continuously (All Song Play).....	12
Listening to Each Part Separately.....	13
Performing with a Variety of Sounds .....	14
Simulating the Creation of Organ Tones (Tone Wheel Mode) .....	15
Selecting the Footage.....	17
Changing volume of feet .....	17
Performing With Two Layered Tones (Dual Play) .....	18
Performing With Different Tones in the Left and Right Sides of the Keyboard (Split Play) .....	19
Changing Tone Group and Tone variation.....	20
Changing the Keyboard's Split Point .....	20
Changing the Volume Balance for Dual Play and Split Play .....	21
Changing the Keyboard's Touch .....	22
Adding Reverberation to Sounds (The Reverb Effect).....	23
Changing the Depth of Reverb Effect .....	23
Adding a Variety Effects to the Sound .....	24
Changing the Effect type .....	24
Changing the Depth of Effect.....	26
Adding a Spinning Sound to Organ Tones (Rotary Effect).....	26
Changing the Sound's Pitch in Real Time (Pedal Control) .....	27
Transposing the Key of the Keyboard (Key Transpose).....	28
Using the Metronome.....	29
Changing the Tempo.....	29
Changing the Beat of Metronome .....	30
Changing the Volume .....	30

## **Chapter 2 Playing Along with Rhythms .. 31**

What is Session Partner? .....	31
Performing Along With Session Partner .....	32
Changing the Volume of a Part .....	33
Selecting a Rhythm .....	33
Changing a Rhythm's Tempo .....	34
Selecting a Rhythm's Chord Progression .....	34
Performing With the Chord Progression Specified in the Left Hand (Chord Progression off).....	35
Recording the Chord Progression (Chord Progression).....	36
Storing Settings (Setup).....	37
Selecting Stored Settings.....	37

## **Chapter 3 Recording a Performance ... 38**

Recording a Performance.....	38
Recording a Performance Using Session Partner....	39
Recording Selected Track buttons .....	40
Erasing Recorded Performances .....	41

## **Chapter 4 Other Functions ..... 42**

How to make settings .....	42
Changing How the Pedal Effects Are Applied .....	43
Changing How the Pedals Work .....	43
Changing the Work of the Pedal Control .....	44
Setting the Part to Which Effects Are Added.....	44
Changing the Pitch of the Lower Tone in Octave Steps (Octave Shift) .....	44
Changing the Velocity When the Key Touch Is Set to "Fixed" .....	45
Tuning to Other Instruments' Pitches (Master Tuning).....	45
Adjusting the Tuning (Temperament) .....	45
Changing the Beat Pattern .....	46
Setting the Intro and Ending on or off .....	47
Fixing a Set Chord Progression.....	47
Setting the Root Note of the Chord Progression .....	47
Setting the Chord Display on or off.....	47
Connecting to Audio Equipment.....	48
About the FP-5 Sound Generator.....	48
Connecting to the USB Connector .....	49
Connecting MIDI Devices .....	49
Connectors .....	49
Making the Connections .....	49
How to Enjoy MIDI .....	50
MIDI Settings.....	50
Making the Settings for the USB Driver .....	53
Restoring the settings to the factory condition (Factory Reset) .....	53
Disabling Everything Except Piano Play (Panel Lock).....	53

## **Appendices ..... 54**

Troubleshooting .....	54
Error Messages/Other Messages.....	56
Tone List .....	57
Rhythm Set List .....	59
Rhythm List.....	62
Chord Progression Pattern List.....	63
Chord Fingering List .....	65
Internal Song List .....	69
Settings Stored in the Setup .....	71
Easy Operation List.....	72
MIDI Implementation Chart.....	74
Main Specifications .....	75
Index.....	76

# Panel Descriptions

## Front Panel

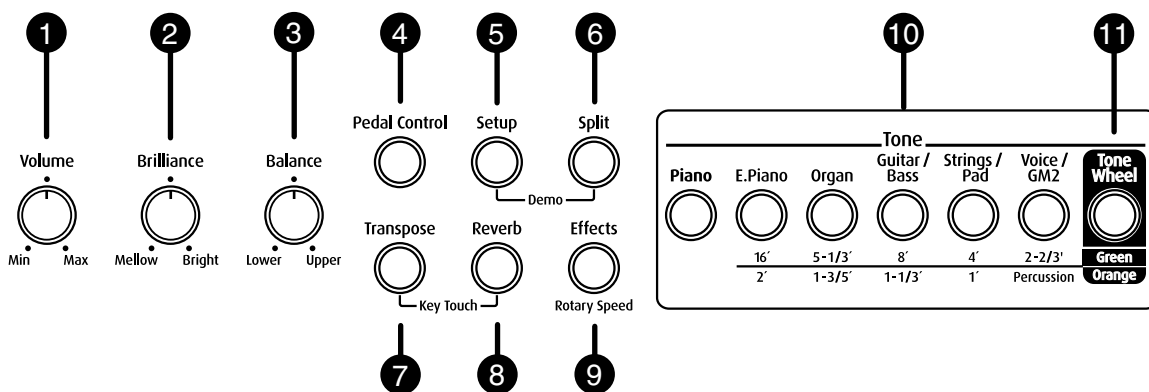

### 1 [Volume] Knob

Adjusts the overall volume level (p. 10).

### 2 [Brilliance] Knob

Adjusts the tone brightness (p. 10).

### 3 [Balance] Knob

Adjusts the volume balance of the Upper and Lower Tones in Dual Play and Split Play (p. 21).

### 4 [Pedal Control] Button

Use the damper pedal to change the sound's pitch (p. 27).

### 5 [Setup] Button

Stores the selected functions and states of the buttons (p. 37).  
Calls up the stored settings (p. 37).

In addition, you can hold down this button while pressing [Split] button to listen demo song (p. 11).

### 6 [Split] Button

Allows you to play different tones in the left and right sides of the keyboard (p. 19).

### 7 [Transpose] Button

Transposes the pitch of the keyboard (p. 28).

By holding down this button and pressing the [Reverb] button, you can change the keyboard's touch sensitivity (p. 22).

### 8 [Reverb] Button

You can use this to add the characteristic reverberation of a concert hall to what you play (p. 23).

### 9 [Effects] Button

Use this to add a variety of different effects to the sound (p. 24).

### 10 Tone Buttons

They are used to choose the kinds of sounds (Tone Groups) played by the keyboard (p. 14).

In addition, this switches the footage on and off in Tone Wheel mode (p. 17).

### 11 [Tone Wheel] Button

Simulate the creation of organ tones in Tone Wheel mode (p. 15).

### 12 Display

Displays information such as the song number, Rhythm number, tempo, beat, and parameter settings values.

### 13 [Variation/Effects] Button

Press this to change the Tone Variation or Effect Type (p. 14, p. 24). Each time you press this button, the Tone Variation and the Effect Type will be displayed alternately.

In addition, you can hold down this button while pressing [Tempo/Rhythm] button to make various different settings (p. 42 to p. 53).

### 14 [Tempo/Rhythm] Button

Press this to change the tempo or Rhythm (p. 29, p. 33).

Each time you press this button, the tempo and the Rhythm will be displayed alternately.

### 15 [-]/[+] Buttons

These two buttons are used to modify the values of a variety of settings.

### 16 [M] (Metronome) Button

Turns the internal metronome on and off (p. 29).

### 17 [Start/Stop] Button

Switches Session Partner start or stop (p. 32).

### 18 [Drums] Button

Turns the Drums part of Session Partner on and off (p. 32).

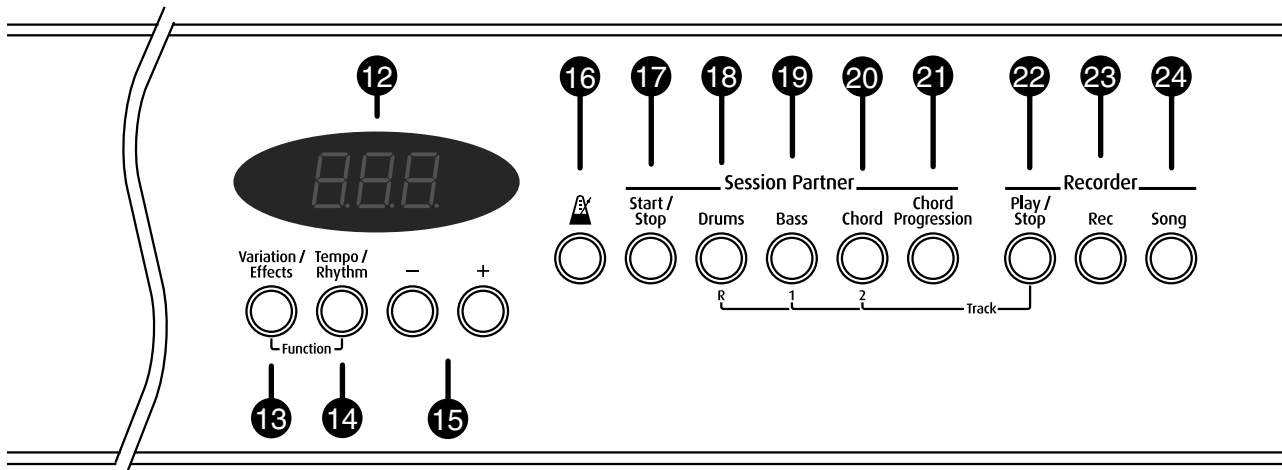

### 19 [Bass] Button

Turns the Bass part of Session Partner on and off (p. 32).

### 20 [Chord] Button

Turns the Chord part of Session Partner on and off (p. 32).

### 21 [Chord Progression] Button

This turns the Session Partner chord progression on and off. When turned off, chords are specified in the left side of the keyboard (p. 35).

### 22 [Play/Stop] Button

Starts and stops playback of internal songs and recorded performances (p. 12).

Used for starting recording of performances (p. 38).

### 23 [Rec] button

Puts the unit in the state whereby it is ready for recording performances (p. 38).

### 24 [Song] Button

For selecting internal songs (p. 12).

## Rear Panel

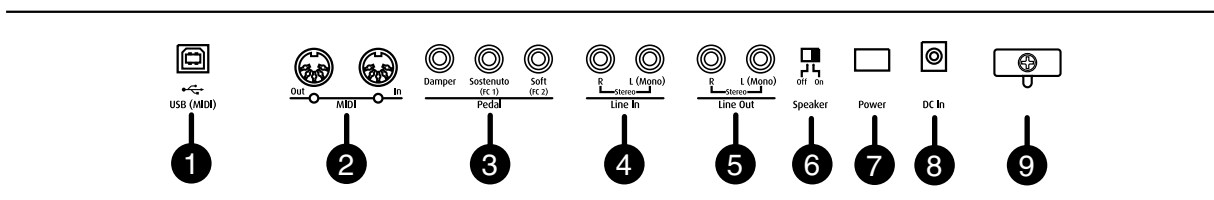

### 1 USB(MIDI) Connector

Use this for connecting a computer to the FP-5 using a USB cable (p. 49).

### 2 MIDI Connectors

Used for connecting external MIDI devices and for sending and receiving MIDI messages (p. 49).

### 3 Pedal Jacks

Accepts connection of the supplied pedal, or other suitable pedals (p. 9).

### 4 Line In Jacks

Provide input of the audio signals. Used for connecting audio equipment and other such devices (p. 48).

### 5 Line Out Jacks

Provide output of the audio signals. Also used for connecting audio equipment and other such devices (p. 48).

These allow you to play sounds from the FP-5 through other audio devices.

### 6 [Speaker] Switch

This switch turns the internal speaker on/off (p. 48).

### 7 [Power] Switch

This switch turns the unit on/off (p. 9).

### 8 DC In Jack

Connect the supplied AC adaptor here (p. 8).

### 9 Cord Hook

Use this to fix in place the cord from the supplied AC adaptor (p. 8).

# Before You Play

## Making Connections

1. Before you begin making connections, confirm the following.

Is the volume level of the FP-5 turned all the way down?

Is the power to the FP-5 turned off?

2. Connect the supplied AC cable to the supplied AC adaptor.

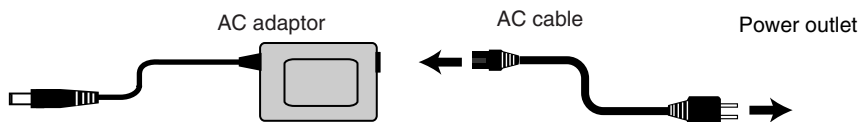

3. Connect the supplied AC adaptor to the FP-5, and then plug its other end into a power outlet.

To prevent the inadvertent disruption of power to your unit (should the plug be pulled out accidentally), and to avoid applying undue stress to the AC adaptor jack, anchor the power cord using the cord hook, as shown in the illustration.

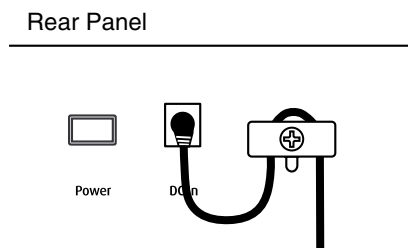

## Installing the Music Stand

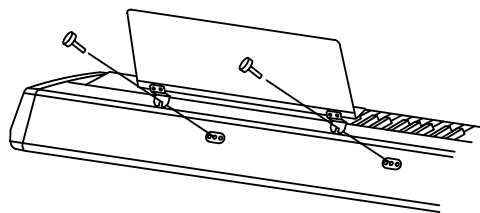

1. Using the supplied screws, attach the music stand to the back of the FP-5 as illustrated.

Be sure to use the supplied screws for attaching the music stand.

Turn the screws clockwise until they're held in place—but don't tighten them yet.

2. Put the music stand between the screws and the FP-5's body.

3. While supporting the music stand with one hand, secure it in place by turning the screws.

\* When attaching the music stand, support it firmly with one hand to make sure that you don't drop it. Be careful, so you don't get your fingers pinched.

4. To remove the music stand, support it with one hand while loosening the screws.

\* After removing the music stand, don't forget to retighten the screws.

### NOTE

Do not apply excessive force to the installed music stand.



## Connecting Pedals

### 1. Connect the pedal included with the FP-5 to one of the Pedal jacks.

When connected to the Damper jack, the pedal can be used as a damper pedal. In addition, it can be set to function as an another works (p. 27, p. 44).

When connected to Sostenuto(FC1) jack, the pedal can be used as a sostenuto pedal. In addition, it can be set to function as an another works (p. 43, p. 52).

When connected to Soft(FC2) jack, the pedal can be used as a soft pedal. In addition, it can be set to function as an another works (p. 43, p. 52).

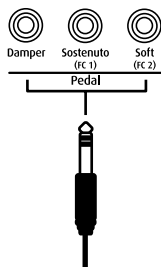

- \* Unplugging a pedal cord from the unit while the power is on may cause the pedal's effect to be applied without stopping. The power of the FP-5 must be turned off before inserting or removing a pedal cord.

### Damper Pedal

Use this pedal to sustain the sound. While the pedal is depressed, long lingering reverberations continue to be added to the sound after you release from the keys.

The pedal included with the FP-5 functions as a half-damper pedal, which allows you to adjust the amount of resonance.

When you depress the damper pedal on an acoustic piano, the sound from the strings that were struck resonates with other strings, adding rich reverberations and broadness to the sound. You can adjust this resonance (sympathetic resonance) when the damper pedal is depressed.

- \* With the pedal connected to the Damper jack, it can be assigned other functions as well. Refer to "Changing the Sound's Pitch in Real Time (Pedal Control)" (p. 27).
- \* Set the switch on the included pedal to "Continuous" when the pedal is connected.

### Sostenuto Pedal

This pedal sustains only the sounds of the keys that were already played when you pressed the pedal.

- \* With the pedal connected to the Sostenuto(FC1) jack, it can be assigned other functions as well. Refer to "Changing How the Pedals Work" (p. 43), "Using the Pedal to Switch Setup (Pedal shift)" (p. 52).

### Soft Pedal

This pedal is used to make the sound softer.

Playing with the soft pedal depressed produces a sound that is not as strong as when otherwise played with the equivalent strength. This is the same function as the left pedal of an acoustic piano.

- \* With the pedal connected to the Soft(FC2) jack, it can be assigned other functions as well. Refer to "Changing How the Pedals Work" (p. 43), "Using the Pedal to Switch Setup (Pedal shift)" (p. 52).
- \* By obtaining a second and third pedal, you can then use three pedals simultaneously. If you wish to purchase the optional pedal (DP series), please contact the dealer where you purchased the FP-5.

## Turning the Power On and Off

- \* Once the connections have been completed, turn on power to your various devices in the order specified. By turning on devices in the wrong order, you risk causing malfunction and/or damage to speakers and other devices.

### ■ Turning On the Power

#### 1. Before you switch on the power, turn the volume down all the way by rotating the [Volume] knob.

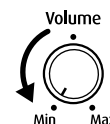

#### 2. Press the [Power] switch on the back of the unit.

The power will turn on, and "FP5" appears in the display.

After a few seconds, the unit becomes operable and playing the keyboard produces sound.

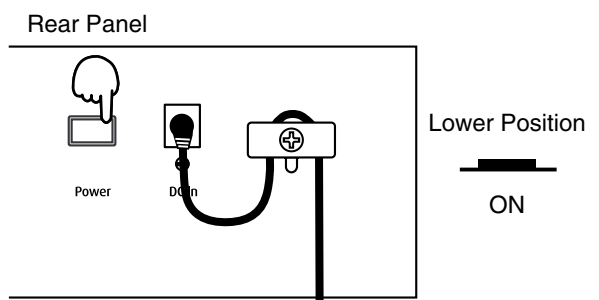

- \* This unit is equipped with a protection circuit. A brief interval (a few seconds) after power up is required before the unit will operate normally.

#### 3. Adjust the volume to obtain the proper volume level.

## Before You Play

### ■ Turning Off the Power

1. Before switching the power off, turn the volume all the way down by rotating the [Volume] knob.

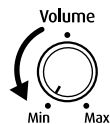

2. Press the [Power] switch on the back of the unit.

The power is switched off.

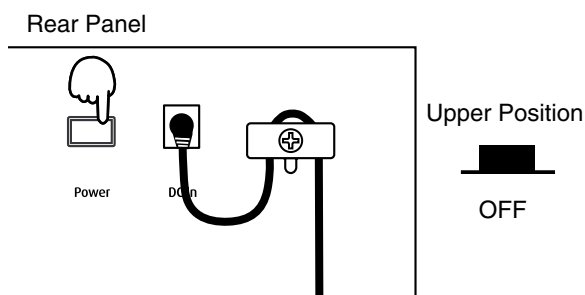

### Adjusting the Sound's Volume and Brilliance

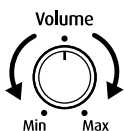

1. Use the [Volume] knob to adjust the overall volume level.

Rotating the knob clockwise increases the volume; counterclockwise rotation decreases it.

2. Use the [Brilliance] knob to adjust the overall sound quality.

Rotating the knob clockwise makes the tone brighter; rotating it counterclockwise makes the sound more subdued.

If the FP-5 is positioned against a wall, you will probably want to rotate the knob more to the left.

### Connecting Headphones

Connecting headphones allows you to enjoy playing anytime, even at night, without concern.

\* Headphones are not included. Consult your Roland dealer if you want to purchase.

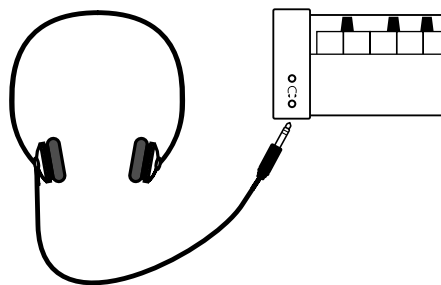

1. Plug the headphones into the Phones jack at the front, on the left side of the piano.

Use the [Volume] knob on the FP-5 to adjust the volume of the headphones.

\* Make sure to use stereo headphones.

### Some Notes on Using Headphones

- To prevent damage to the cord, handle the headphones only by the headset or the plug.
- The headphones may be damaged if the volume is too high when they are plugged in. Lower the volume on the FP-5 before plugging in the headphones.
- To prevent possible auditory damage, loss of hearing, or damage to the headphones, the headphones should not be used at an excessively high volume. Use the headphones at a moderate volume level.

# Chapter 1 Playing the Keyboard

## Listening to Demo Songs

Now, try listening to demo songs.

The FP-5 comes with fifty four demo songs.

The seven Tone buttons, the [Start/Stop] button, and the [Play/Stop] button are each assigned one demo song.

Button	Indication	Composer/Copyright
Piano	Pno	Masaki & Kazuko Hirashita / © 2002 Roland Corporation
E.Piano	E.Pn	© 2002 Roland Corporation
Organ	OrG	© 2002 Roland Corporation
Guitar/Bass	Gtr	Masaki & Kazuko Hirashita / © 2002 Roland Corporation
Strings/Pad	Str	Masaki & Kazuko Hirashita / © 2002 Roland Corporation
Voice/GM2	Sct	© 2002 Roland Corporation
Tone Wheel	t.Or	© 2002 Roland Corporation
Start/Stop	SP	© 2002 Roland Corporation
Play/Stop	SnG	Masaki & Kazuko Hirashita / © 2002 Roland Corporation

### NOTE

All rights reserved.

Unauthorized use of this material for purposes other than private, personal enjoyment is a violation of applicable laws.

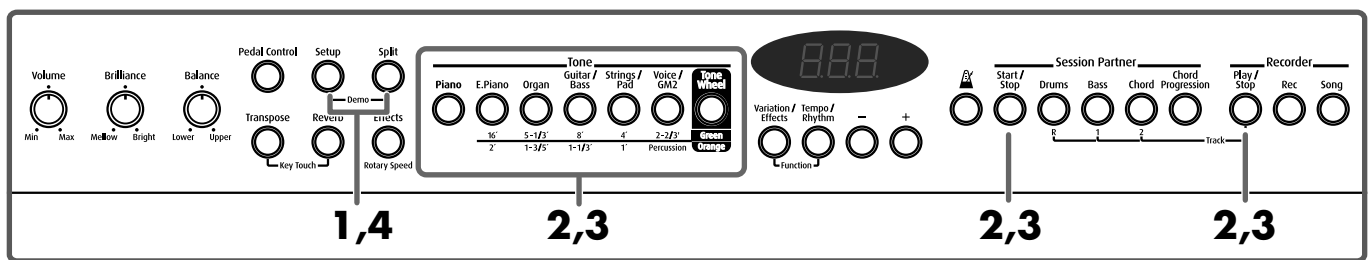

- Hold down the [Setup] button and press the [Split] button. The indicators for the Tone and [Start/Stop] and [Play/Stop] buttons flash in red.

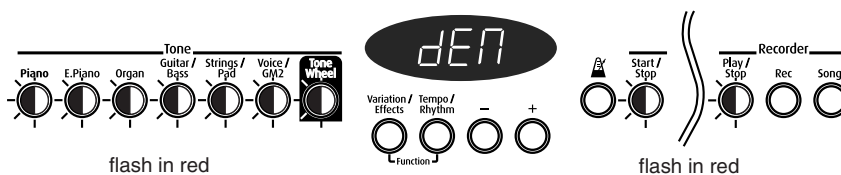

- Press one of the flashing Tone buttons other than the [Setup] or the [Split] button to select the song.

Songs play back continuously. The button for the song currently being played back flashes on and off.

When playback of the last song is reached, playback continues by returning to the first song and playing that again.

- To stop playback, press the flashing button.

- Press the [Setup] button or the [Split] button to exit Demo mode.

The indicators return to their previous state.

### MEMO

The demo song cannot be played back while recorded performance data remains in the FP-5's memory. Press [Rec] button to delete the performance data (p. 13).

### MEMO

Press a button not assigned to a demo song to exit Demo mode.

### NOTE

No MIDI data for the music that is played will be output.

## Chapter 1 Playing the Keyboard

### Listening to Internal Songs

Now, try listening to Internal songs.

The FP-5 comes with sixty five internal songs.

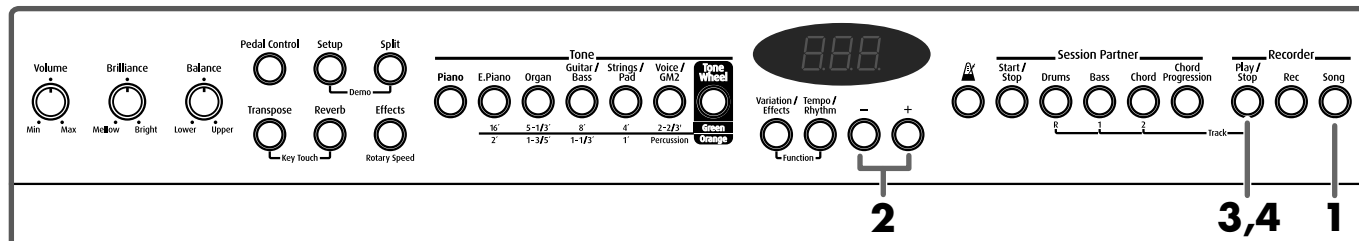

1. Press the [Song] button, getting its indicator to light.

The following appears in the display.



2. Press the [-] or [+] button to select the song.

3. Press the [Play/Stop] button.

The song will begin playing back.

The selected song is played to the end, and then playback stops.

4. To stop playback, press the [Play/Stop] button once more.

The next time you press the [Play/Stop] button, the song that was stopped is played from the beginning.

#### ■ Playing Back All Songs Continuously (All Song Play)

Listening to all of internal songs repeatedly played back in succession is known as “All Song Play.”



For more on internal song names, refer to “Internal Song List” (p. 69).



#### About the Display of the Internal Songs

**USr (User)**—Stores recorded Performances (for more on recording →p. 38).  
When “P.” is added—  
Indicates one of the piano songs

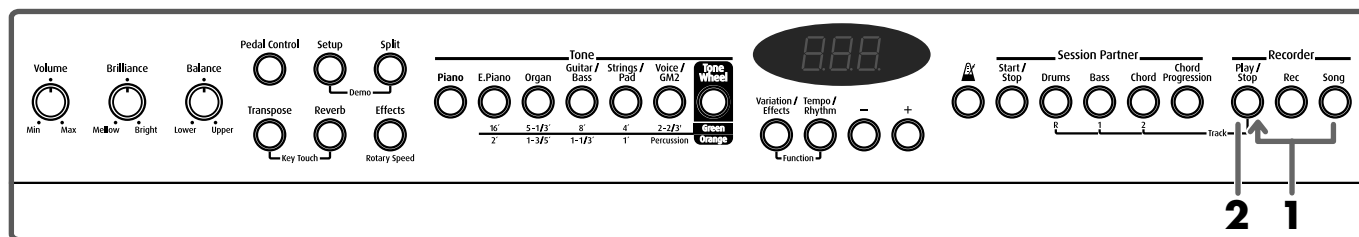

1. Hold down the [Song] button and press the [Play/Stop] button.

Songs play back continuously.

When playback of the last song is reached, playback continues by returning to the first song and playing that again.

2. To stop playback, press the [Play/Stop] button.

All Song Play is exited when the performance is stopped.

The next time you press the [Play/Stop] button, the song that was stopped is played.

**When the following appears in the display**

If there is any performance data stored in the FP-5's memory, the following appears in the display.

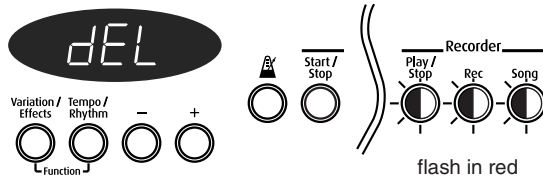

Until you erase the performance data, you cannot play back an internal song.

To erase the performance data and play back the internal song, press the [Rec] button.

If you don't want to erase the song, press the [Play/Stop] or [Song] button.

**■ Listening to Each Part Separately**

With the internal songs, you can select the performance part that is to be played back.

You can also practice each hand separately while playing along with the song.

- 1. Select the song to be played back.**
- 2. Hold down the [Play/Stop] button and press either [Bass (1)] button or [Chord(2)] button to select the part for which you want the sound to not be played.**

The indicator on the selected button goes out.

The performance data is assigned to the Track buttons as shown below.

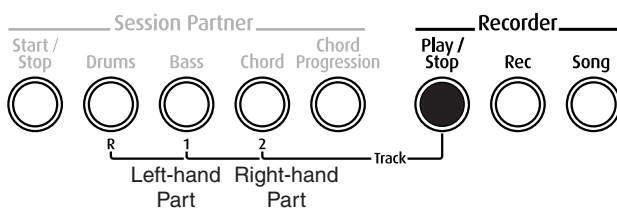

When you release the [Play/Stop] button, the song is played back.

The sound for the performance part selected in Step 2 is not played.

Temporarily preventing the sounds of a specified part from playing is called "muting."

- 3. Hold down the [Play/Stop] button and press the button selected in Step 2.**

The sound of the muted part is then played.

- 4. Press the [Play/Stop] button to stop playback.**



Changing the song cancels the mute setting.

# Performing with a Variety of Sounds

The FP-5 features over 300 different internal sounds, allowing you to enjoy performing with sounds suitable for many different types of music.

These onboard sounds are called “Tones.” The Tones are divided into seven different groups, each of which is assigned to a different Tone button.

The Tone “Grand Piano 1” is selected when the instrument’s power is turned on.



For more on Tones, refer to “Tone List” (p. 57)

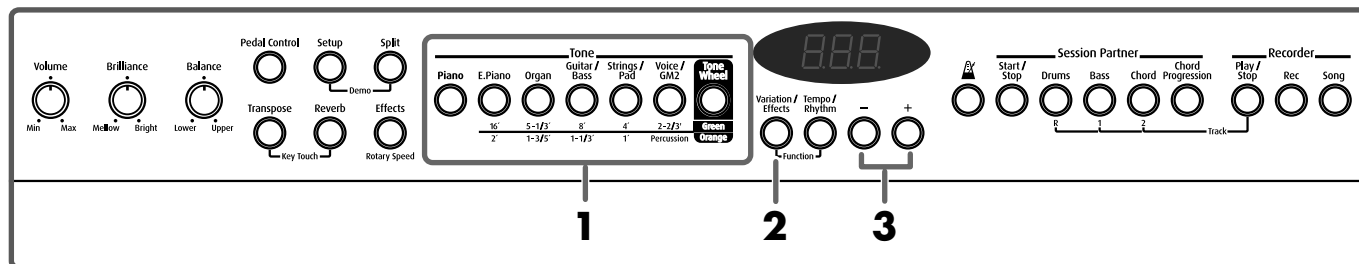

### 1. Press one of the Tone buttons to choose a Tone Group.

You’ll hear the Tone assigned to Tone number 1 in the selected Tone Group. Try fingering the keyboard.

The Tone number appears in the display.



### 2. Press the [Variation/Effects] button, getting its indicator to light in red.

### 3. Press the [-] or [+] button to select a Tone from the Tone Group.

The Tone you’ve selected is heard when you finger the keyboard.

The next time you choose this Tone button, the tone you’ve selected here is played.

## Simulating the Creation of Organ Tones (Tone Wheel Mode)

When any of the “Tone Wheel” Tones is selected, you can perform in “Tone Wheel mode,” in which the creation of organ sounds is simulated.

An organ features nine “harmonic bars” that can be drawn in and out, and by using the bars in different combinations of positions, a variety of different tones can be created. Different “Feet” are assigned to each bar, with the pitches of the sounds being determined by these “Feet.”

You can simulate the creation of tones using the harmonic bars by assigning footages to the Tone buttons.

In Tone Wheel mode, the footages are switched by pressing the [Tone Wheel] button, and a total of nine footages and percussion instruments are assigned to the Tone buttons other than [Piano] button.

### What Are “Feet?”

Feet basically refers to the lengths of pipe used in pipe organs. The length of pipe used to produce the reference pitch (the fundamental) for the keyboard is eight feet. Reducing the pipe to half its length produces a pitch one octave higher; conversely, doubling the pipe length creates a pitch one octave lower. Therefore, a pipe producing a pitch one octave below that of the reference of 8' (eight feet) would be 16'; for one octave above the reference, the pipe would be 4', and to take the pitch up yet another octave it would be shortened to 2'.

On tone wheel organs, in the high range of the keyboard, high-pitched feet are “wrapped around” one octave down.

Folding back the high-frequency portion prevents the high-frequency sounds from being unpleasantly shrill, and folding back the low-frequency portion prevents the sound from becoming “muddy.”

On the FP-5 faithfully simulates this characteristic.

### **NOTE**

When the Tone Wheel is selected, you cannot enable the dual mode (p. 18).

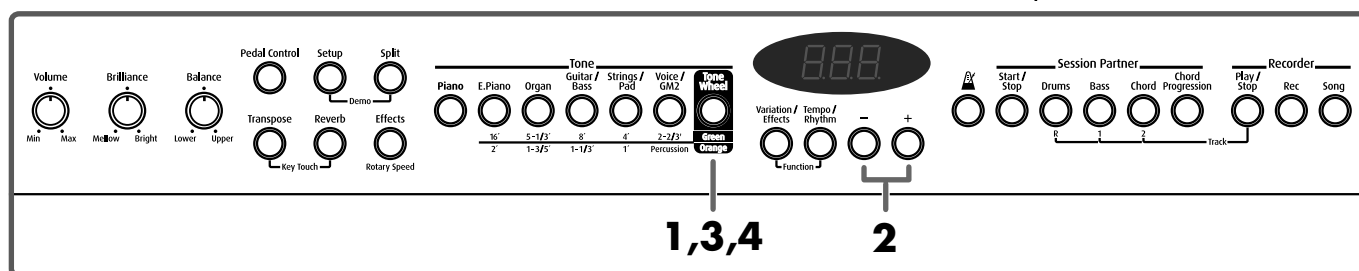

- 1.** Press the [Tone Wheel] button, getting its indicator to light in red.
- 2.** Press the [-] or [+] button to select a Tone.
- 3.** Press the [Tone Wheel] button, getting its indicator to light in green or orange.

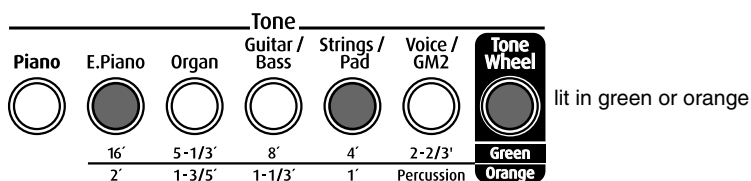

The FP-5 switches to “Tone Wheel mode,” the function is turned on, and the footage buttons flash.



- 4.** To exit Tone Wheel mode, press the [Tone Wheel] button until the button’s light is red.

### About the lighting of the [Tone Wheel] button indicators

The indicators of the [Tone Wheel] buttons indicate the status of the Tone and Feet Group, as shown below.

Indicator	Performance
Lit in red 	“Tone Wheel” tone is selected in the Upper Tone or the Lower Tone.
Lit in green 	The feet of upper footage group in Tone Wheel Mode can be turned on and off.
Lit in orange 	The feet of lower footage group in Tone Wheel Mode can be turned on and off.



When you press the [Piano] button, the FP-5 exits Tone Wheel Mode, regardless of the [Tone Wheel] button’s illumination status.



## ■ Selecting the Footage

1. Press the [Tone Wheel] button to select the upper (button's indicator lights in green) or lower (button's indicator lights in orange) footage group.
2. Press the Tone buttons to turn on and off the different footages.

## ■ Changing volume of feet

The volume on feet can be adjusted, with eight volume levels available.

1. Press the [Tone Wheel] button to select the upper (button's indicator lights in green) or lower (button's indicator lights in orange) footage group.
2. Hold down the Tone button for the footage for which you want to change the volume, and press the [-] or [+] button to adjust the volume.

The volume level of the footage assigned to the button being pressed is displayed.

## About Perc (Percussion)

Perc (Percussion) adds an attack-type sound to the beginning of the note to give the sound more crispness. The attack sound changes according to the value.

Settings	Description
2nd	Percussion sounds at a pitch one octave above that of the key pressed.
3rd	Percussion sounds at a pitch an octave and a fifth above that of the key pressed.

The percussion on tone wheel organs did not apply to all notes that were played. When notes were played legato (smoothly and connectedly), percussion was applied only to the first-played note. When notes were played staccato (articulating each note separately), percussion was applied to all notes. This method is referred to as single trigger algorithm, and is a very important element in organ performance.

On the FP-5 faithfully simulates this characteristic.



The settings changed here are stored to each Tone. Even when you exit from Tone Wheel mode, you can press [Tone Wheel] button to select the Tone with the changed settings.



The Percussion is applied only to the UPPER Tone.



When percussion is on, the 1' pitch will not be produced (p. 15).

# Performing With Two Layered Tones (Dual Play)

You can play two different sounds from a single key at the same time. This method of performance is called “Dual Play.”

### Example: Try Layering Piano and String Tones

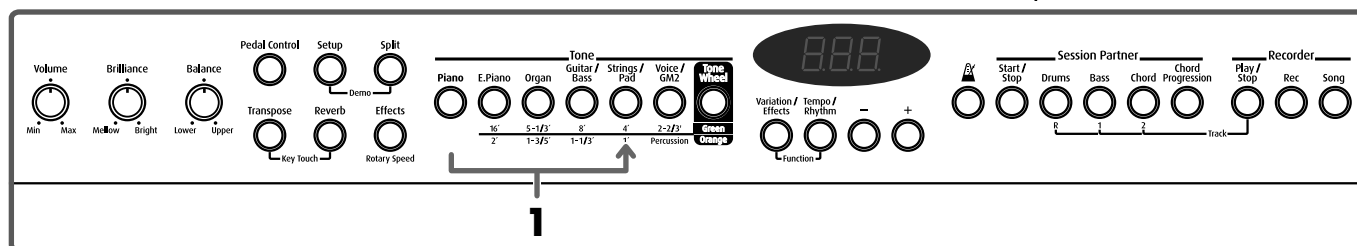

## 1. Hold down the [Piano] button and press the [Strings/Pad] button.

The indicators for both buttons light.

Try fingering the keyboard. Both the piano and string sounds play.

Pressing two Tone buttons at the same time in this manner activates Dual Play.

Of these two selected tones, the one for the Tone button you pressed first is called the “Upper Tone,” and the one for the Tone button you pressed after that is called the “Lower Tone.”

The Tone button’s indicator lights in red for the Upper Tone, and in orange for the Lower Tone.

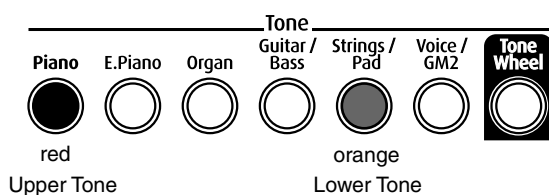

Here, the piano tone is the Upper Tone and the strings tone is the Lower Tone.

## 2. To exit Dual Play, press either Tone button.

Now, only the tone of the button you just pressed is sounded.

### Changing the Tone variations

1. Press the [-] or [+] button to change the Upper Tone.
2. Hold down the Tone button for the Lower Tone, and press the [-] or [+] button to change the Lower Tone.

### MEMO

You can change the pitch of the Lower Tone an octave at a time. Refer to “Changing the Pitch of the Lower Tone in Octave Steps (Octave Shift)” (p. 44).

### MEMO

You can vary the volume-level balance of the two tones. Take a look at “Changing the Volume Balance for Dual Play and Split Play” (p. 21).

### NOTE

When the Tone Wheel is selected, you cannot enable the dual mode (p. 15).

### MEMO

Although when you press the pedal while in Dual Play, the effect is applied to both tones, you can set the FP-5 so that the effect is not applied to the Lower Tone. Refer to “Changing How the Pedal Effects Are Applied” (p. 43).

## Performing With Different Tones in the Left and Right Sides of the Keyboard (Split Play)

Performing with the keyboard divided at a certain key into a left side and a right side is called “Split Play,” and the point at which the keyboard is divided is called the “split point.”

In Split Play, you can have a different tone sound in the left and right sides.

When the instrument is turned on, the split point is set to “F # 3.” The split point key is included in the left side.

While in Split Play, a sound played in the right side is called an “Upper Tone,” and the sound played in the left side is called a “Lower Tone.”

**Example: Let’s try split play with the piano tones.**

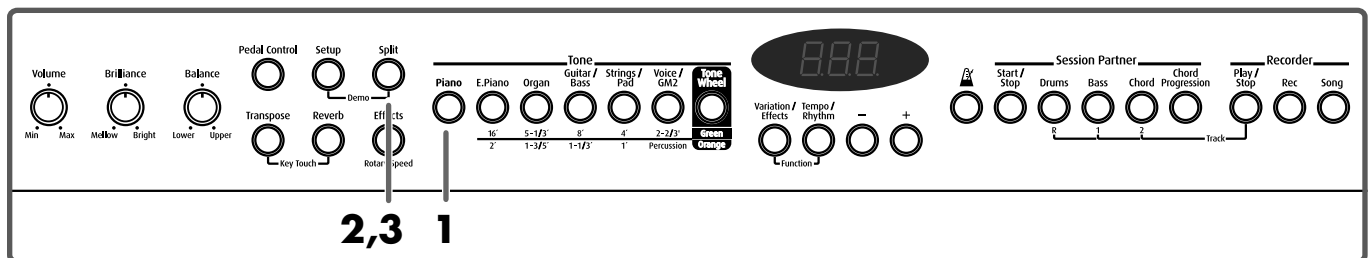

### 1. Press the [Piano] button.

Now, the piano tone is selected.

### 2. Press the [Split] button, getting its indicator to light.

The keyboard is divided into upper and lower sections.

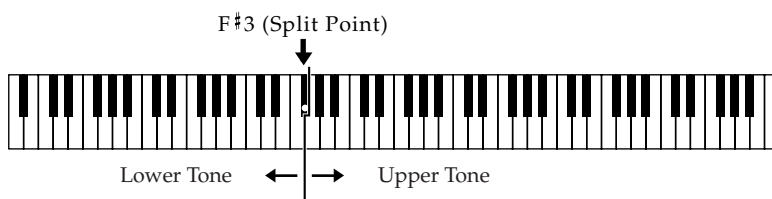

The right-hand section of the keyboard plays piano tone, and the left-hand section plays A. Bass+Ride tone.

You can play a tone for the right side (the Upper Tone) before splitting the keyboard.

The Tone button’s indicator lights in red for the Upper Tone, and in green for the Lower Tone.

### 3. To exit Split Play, press the [Split] button once more.

The [Split] button’s indicator light goes out and the upper tone becomes the tone for the entire keyboard.



You can specify which part is to have priority when the effects assigned to the Upper Tone and Lower Tone differ. Refer to “Setting the Part to Which Effects Are Added” (p. 44).



You can vary the volume-level balance of the two tones. Take a look at “Changing the Volume Balance for Dual Play and Split Play” (p. 21).



When the “Tone Wheel” tone is selected to the Lower Tone, the [Tone Wheel] button’s indicator light in red (p. 16).



When you switch from Dual Play (p. 18) to Split Play, the Upper Tone used in Dual Play is selected as the Upper Tone for Split Play.

## Chapter 1 Playing the Keyboard

### ■ Changing Tone Group and Tone variation.

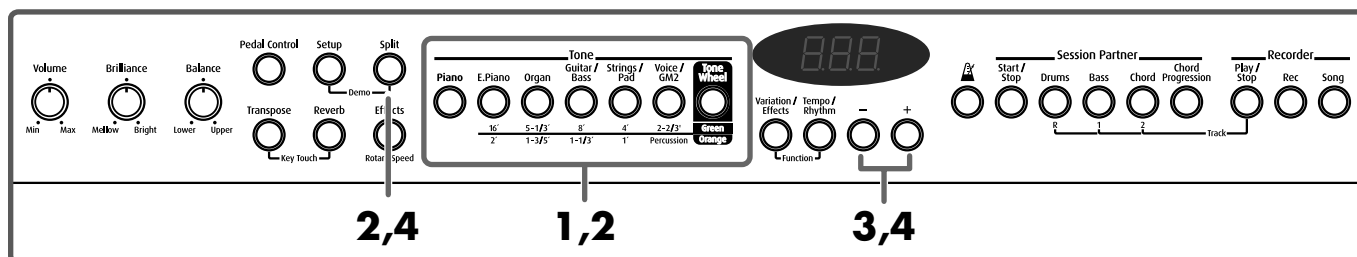

#### Changing the Upper Tone

1. Press the Tone button to choose a Tone Group.
2. Press the [-] and [+] buttons to select the Tones.

#### Changing the Lower Tone

1. Hold down the [Split] button and press the Tone button to choose a Tone Group.
2. Hold down the [Split] button and press the [-] and [+] buttons to select a Tones.

For more on selecting tones, refer to “Performing with a Variety of Sounds” (p. 14).

### ■ Changing the Keyboard’s Split Point

You can change the location where the keyboard is divided (the split point) within the range of B1 through B6.

This is set to “F # 3” when the instrument is turned on.

This setting remains in effect until you turn off the power.

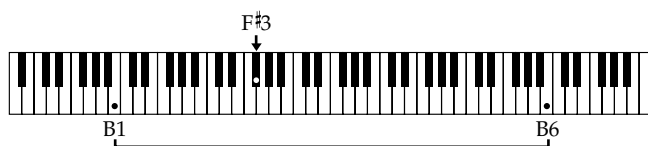

1. Hold down the [Split] button and press a key set as the split point.

The key you pressed becomes the split point, and appears in the display.

The key being used as the split point belongs to the left-hand section of the keyboard.

When you release the [Split] button, you return to the previous screen.



When the tone of the same Tone button is selected for both the Upper and Lower Tones, the indicator for Tone button flash in green while the [Split] button is held down.



You can change the pitch of the Lower Tone an octave at a time. Refer to “Changing the Pitch of the Lower Tone in Octave Steps (Octave Shift)” (p. 44).



The name of the key acting as the split point is indicated in the display, as shown below.

Display	C	d_	d	E_
Letter name	C	D $\flat$	D	E $\flat$
Display	E	F	F $\bar{}$	G
Letter name	E	F	F $\sharp$	G
Display	A_	A	b_	b
Letter name	A $\flat$	A	B $\flat$	B

## Changing the Volume Balance for Dual Play and Split Play

You can change the volume balance of the Upper and Lower Tones in Dual Play (p. 18) and Split Play (p. 19).

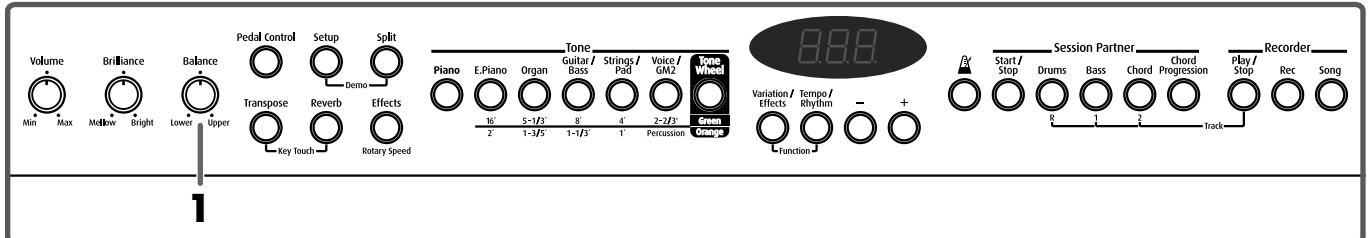

1. Use the [Balance] knob to adjust the volume balance.

### MEMO

You cannot change the volume balance even if you turn the [balance] knob, when Tone Wheel Organs are selected to both the Upper Tone and the Lower Tone.

# Changing the Keyboard's Touch

You can change the touch sensitivity, or response of the keys.

When the instrument is turned on, this is set to “N (Normal).”

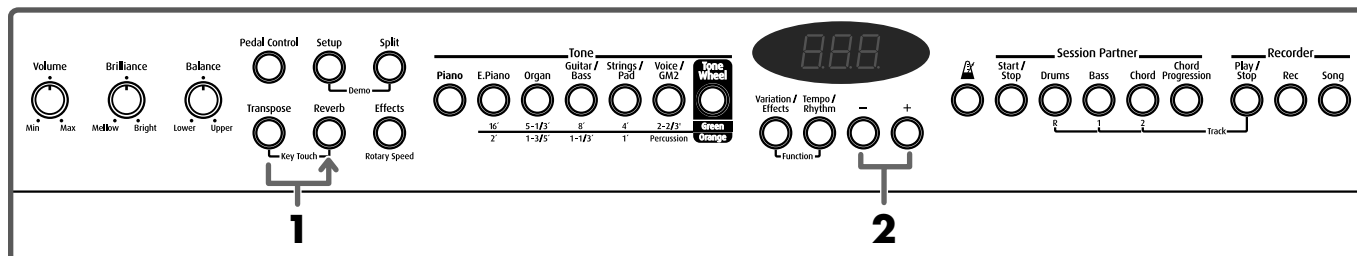

1. Hold down the [Transpose] button and press the [Reverb] button.

The indicators for the [Transpose] and [Reverb] buttons flash in red.



2. Press the [-] or [+] buttons to select the touch.

Indicate	Description
OFF (Fixed)	The sound plays at one set volume, regardless of the force used to play the keys.
-L- (Light)	A light keyboard touch is selected. You can achieve fortissimo (ff) play with a less forceful touch than usual, so the keyboard feels lighter. This setting makes it easy to play, even for children.
 -N-(Normal)	This sets the standard keyboard touch. You can play with the most natural touch. This is the closest to the touch of an acoustic piano.
-H- (Heavy)	Here, a heavy keyboard touch is selected. You have to finger the keyboard more forcefully than usual in order to play fortissimo (ff), so the keyboard touch feels heavier. Dynamic fingering adds even more feeling to what you play.

3. Press the [Transpose] button or the [Reverb] button.

The indicators return to their previous state.

### NOTE

With certain sounds, the touch may not change.

### MEMO

You can set the velocity the sound will have when the keyboard touch is set to “Fixed” (p. 45).

## Adding Reverberation to Sounds (The Reverb Effect)

You can apply a reverb effect to the notes you play on the keyboard. With the reverb effect, you obtain a pleasant reverberation, making it sound as if you were performing in a concert hall or similar space.

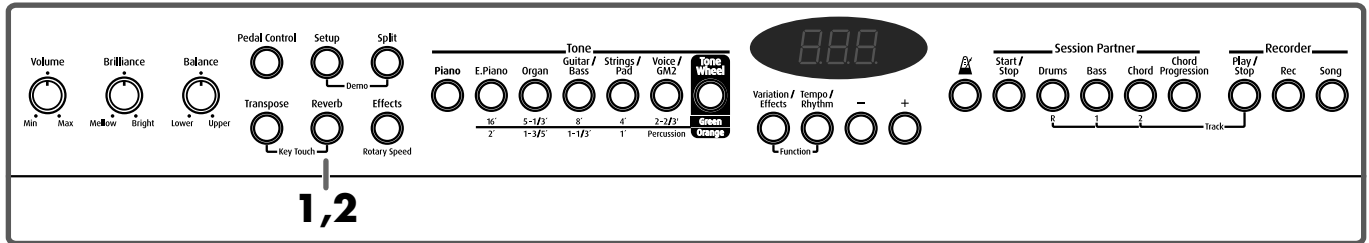

- 1.** Press the [Reverb] button, getting its indicator to light.  
Try fingering the keyboard.  
The reverb effect is applied to the entire tone.
- 2.** To eliminate the Reverb effect, press the [Reverb] button once more, extinguishing the indicator.

### ■ Changing the Depth of Reverb Effect

You can select from ten levels of depth for the reverb effect.

- 1.** Hold down the [Reverb] button and press the [-] or [+] button.

The selected depth for the reverb effect appears in the display.



**NOTE**

You cannot make separate reverb effect depth settings for each individual tone.

**NOTE**

You cannot change reverb effect depth of Session Partner, Demo songs, and Internal song.

### Adding a Variety Effects to the Sound

In addition to reverb, you can apply a variety of changes to the FP-5's sounds.

These are referred to as "effects." With the FP-5, you can select from ten different effect types.

With the factory default settings, effects have been preselected for each tone.

#### NOTE

Effects may not be applied with some of sounds.

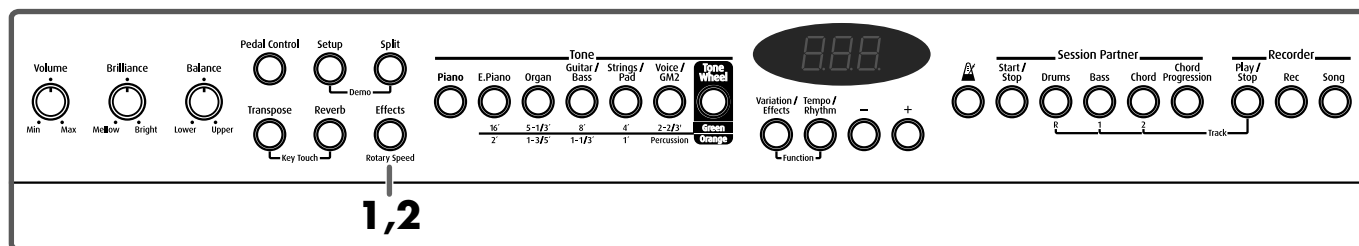

#### 1. Press the [Effects] button, getting its indicator to light.

Try fingering the keyboard.

The effect is applied to the currently selected tone.

#### 2. To remove the effect, press the [Effects] button once more, extinguishing the indicator.

#### ■ Changing the Effect type

#### 1. Press the [Effects] button, getting its indicator to light.

The effect is applied to the currently selected tone.

#### 2. Press the [Variation/Effects] button, getting its indicator to light in orange.

The effect number appears in the display.



#### MEMO

Some tones initially have effect applied. Selecting such a tone makes the [Effects] button's indicator light up automatically.

#### MEMO

You can specify which part is to have priority when the effects assigned to the Upper Tone and Lower Tone differ. Refer to "Setting the Part to Which Effects Are Added" (p. 44).



**3. Press the [-] or [+] button to select the effect.**

You can select from the following.

Indication	Effects	Description
S.rE	SYMPATHETIC RESONANCE	When you depress the damper pedal on an acoustic piano, the sound from the strings that were struck resonates with other strings, adding rich reverberations and broadness to the sound.
Enh	ENHANCER	This controls the overtone structure of the high frequencies, adding sparkle and tightness to the sound.
dLy	DELAY	This effect adds a delay sound like an echo.
Cho	CHORUS	You can give the sound greater dimension, with more fatness and breath.
t.ch	TREMOLO CHORUS	This effect is Chorus effect with added cyclic modulation of volume.
rot	ROTARY	This effect adds spinning sounds similar to the sound of an organ using a rotating speaker of the past.
Pha	PHASER	This effect adds a phase-shifted sound to the direct sound, producing a twisting modulation that creates spaciousness and depth.
FLn	FLANGER	This effect produces a metallic resonance that rises and falls like a jet airplane taking off or landing.
Odr	OVER DRIVE	This effect creates a soft distortion similar to that produced by vacuum tube amplifiers.
dSt	DISTORTION	This effect produces a more intense distortion than Overdrive.

The next time you choose the same tone, the effect type you've selected here is applied.

### ■ Changing the Depth of Effect

You can select from ten levels of depth for the effect.

#### 1. Hold down the [Effects] button and press the [-] or [+] button.

The depth for the effect being applied to the currently selected tone appears in the display.



The next time you choose the same tone, the effect with the depth you've selected here is applied.

### ■ Adding a Spinning Sound to Organ Tones (Rotary Effect)

The Rotary effect is applied to some Organ tones you can select with the [Organ] button, and to the tone of the [Tone Wheel] button. When one of these tones is selected, you can use the [Effects] button to change the speed of the rotary effect.

What the rotary effect does is to add a “spinning” effect similar to the sound of an organ using a rotating speaker.

#### 1. Press the [Organ] button and select the organ tone.

When a tone that has the Rotary effect added is selected, the [Effects] button's indicator flashes or blinks in green.

#### 2. Each time pressing the [Effects] button, switch the speed of the rotary effect between rapid and slow rotation.

When the [Effects] button's indicator flashes in green, a more rapid rotary effect is applied.

When the [Effects] button's indicator blinks in green, a slower rotary effect is applied.

#### NOTE

You cannot change the levels of depth for the rotary effect.

#### MEMO

To prevent the Rotary effect from being applied, select an effect type other than the Rotary effect and then remove the effect.

## Changing the Sound's Pitch in Real Time (Pedal Control)

Connecting the included pedal to the Damper jack allows you to use the pedal to alter the sounds' pitches.

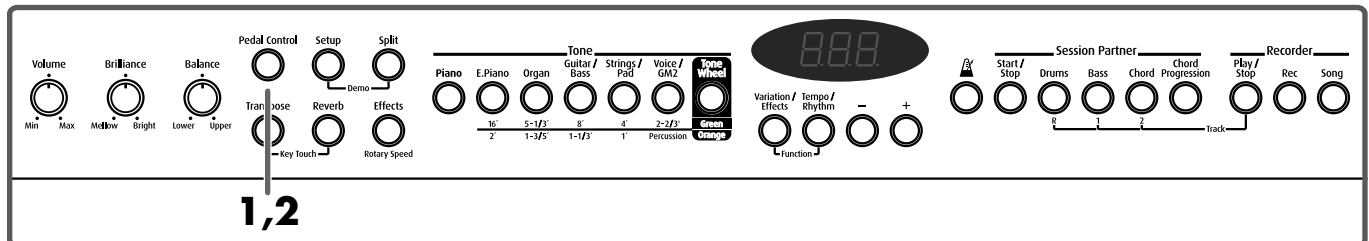

### 1. Hold down the [Pedal Control] button, getting its indicator to light.

Try fingering the keyboard.

When you press the Damper pedal, the pitch gradually rises. With the pedal fully pressed, the pitch is raised two semitones (fixed). The sound returns to its original pitch when you release the pedal. You can adjust how much the pitch is raised by changing the pedal depth.

### 2. To undo the pitch bend effect, press the [Pedal Control] button once more so the button's light goes out.

You can set the Damper pedal to lower the pitch when pressed. You can also assign the modulation effect to the pedal.

Refer to "Changing the Work of the Pedal Control" (p. 44).

### What "Pitch Bend" and "Modulation" Do

The effect that gradually raises or lowers the pitch is known as pitch bend.

The regular, cyclical wavering of the pitch is referred to as modulation or vibrato.

#### NOTE

The damper pedal effect cannot be applied while the [Pedal Control] button is lit.

#### MEMO

The function does not work properly when a pedal (other than expression or half-damper pedal) is used. Additionally, when connecting the included pedal, be sure set the switch on the included pedal to "Continuous."

#### NOTE

With some sounds, the modulation effect may not be applied, or the amount of effect you get may be less or more than what you get with other sounds.

# Transposing the Key of the Keyboard (Key Transpose)

You can transpose the key of a performance without having to shift the position of your fingers on the keyboard. This feature is called “Key Transpose.”

This lets you take a song in a difficult key with lots of sharps (#) and flats (b) and play it in a key with fingering that’s easier for you. This is handy when playing accompaniment to a song, to match what you play to the pitch of the singer’s voice.

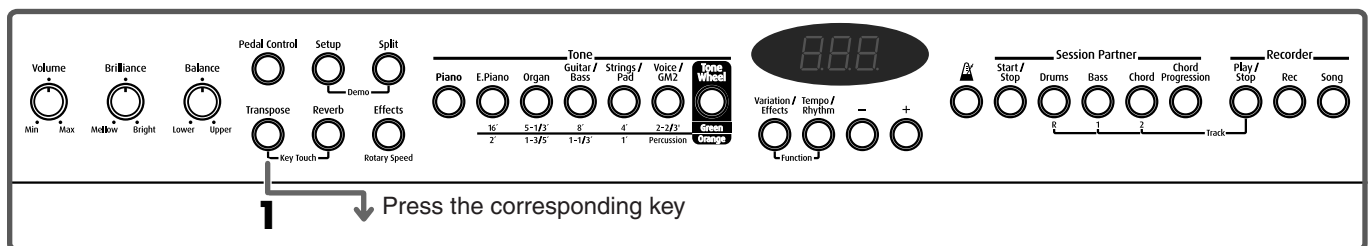

### 1. Hold down the [Transpose] button and press the key corresponding to the tonic of the desired key.

The Key Transpose settings value continues to appear in the display while the [Transpose] button is held down.

With the [Transpose] button held down, you can change the value, even by pressing the [-] or [+] button.

The available range is -6–0–5.

When you release the [Transpose] button, you return to the previous screen.

### Example: Playing a Song in the Key of E Major After Transposition to C Major

Hold down the [Transpose] button and press the E key (since E is the tonic).

Counting from C as a reference point, one moves up four keys, including the black keys, to reach E, thus “4” appears in the display.



By holding down the [Transpose] button and pressing both the [-] and [+] buttons simultaneously, the setting returns to its original value.

## Using the Metronome

Here's how you can make use of the metronome.

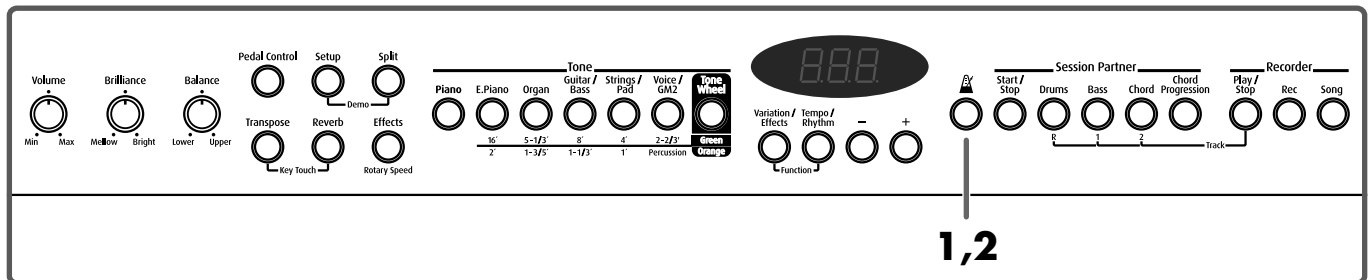

1. Press the [  (Metronome) ] button to have the metronome sound.

The [Tempo/Rhythm] button's indicator flashes in red and green in time with the beat selected at that time. The indicator lights in red on the downbeats, and in green on weak beats.

2. To stop the metronome, press the [  (Metronome) ] button again.

### ■ Changing the Tempo

1. Press the [Tempo/Rhythm] button, getting its indicator to light in red.

The tempo is displayed.

Pressing the [Tempo/Rhythm] button alternately displays the tempo and the currently selected Rhythm number (indicated by an initial "r").



2. Press the [-] or [+] button to adjust the tempo.

### ■ Changing the Beat of Metronome

1. While holding down the [Tempo/Rhythm] button, press the [-] or [+] button to select the beat.

The currently selected beat is displayed.



You can select from the following beats.

Display	Beat	Display	Beat
2.2	2/2	6.4	6/4
0.4	Weak beats only	7.4	7/4
2.4	2/4	3.8	3/8
3.4	3/4	6.8	6/8
4.4	4/4	9.8	9/8
5.4	5/4	12.8	12/8

### ■ Changing the Volume

The volume of the metronome can be adjusted, with ten volume levels available.

This is set to "5" when the instrument is turned on.

1. While holding down the [M] (Metronome) button, press the [-] or [+] button to adjust the volume.

The currently selected metronome volume is displayed.



When you change the rhythm or the Internal song, the beat of metronome is changed.



You cannot change the metronome beat while a song or Rhythm is being played.



You can change the beat pattern of the Metronome. Refer to p. 46.

# Chapter 2 Playing Along with Rhythms

## What is Session Partner?

---

### “Session Partner” Lets You Enjoy Playing with a Session-Like Feel

“Session Partner” is an easy-to-use function that plays accompaniment in a variety of musical styles.

Playing along with this accompaniment, with its realistic sounds, gives you the feel that you are playing live with a band backing you.

For example, playing with “Session Partner” instead of using the metronome always lets you practice the piano with something different.

You can also change the accompaniment as you like to suit whatever you are playing.

By changing the chords and Rhythms, even while playing the same melody, you can easily create all kinds of new arrangements.

We encourage you to enjoy the variety of performance options open to you by using the “Session Partner” feature.

### What You Can Do With “Session Partner”

“Session Partner” lets you mainly do the following things.

- Play piano with a session-like feel along with Rhythms while the chord progression continues automatically (p. 32).
- Play the piano to provide your own accompaniment as you specify chords with the left hand (the left part of the keyboard) (p. 35).
- Enjoy freer piano performances using your own original chord progressions (p. 36).

With “Session Partner,” you select three “rhythms” and add accompaniment, selecting the rhythms by turning the three part buttons on and off.

You can play intros, endings, and fill-ins (short phrases inserted at transition points in the song) by pressing buttons as you play the keyboard.

### What are the FP-5’s “Rhythms?”

The FP-5 features internal “Rhythms” complementing Pops, Jazz, and other various musical genres.

“Rhythms,” or combinations of elements from a musical genre that recreate the mood or signature sound of a particular style, form the foundation of the accompaniment used in “Session Partner.”

A “Rhythm” is composed from the following three items.

- Drum Part
- Bass Part
- Chord Part

You can play each of these Parts by pressing the [Drums], [Bass], and [Chord] buttons.

# Performing Along With Session Partner

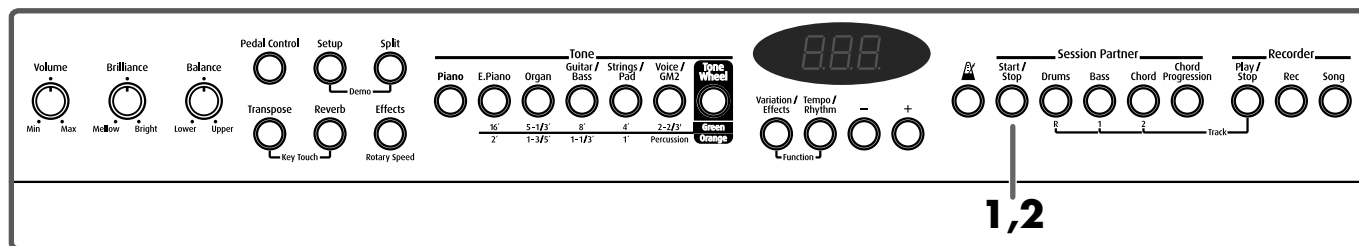

Now, let's try performing along with Session Partner.

Since a wide variety of musical genres is provided, be sure to use a Rhythm that best suits the song you are performing. Please refer to "Selecting a Rhythm" (p. 33).

### 1. Press the [Start/Stop] button.

The [Start/Stop] button's indicator lights in red, and the intro begins to play. After the intro is played, the light's color changes to green.

The chord progression advances automatically, freeing you up to play the melody.

### 2. When you press the [Start/Stop] button once more, the ending is played, and the Rhythm stops.

While the ending is being played, the [Start/Stop] button's indicator lights in red. When the Rhythm stops, the [Start/Stop] button's indicator goes out. Additionally, when the [Start/Stop] button indicator is lit in red, if you then press the [Start/Stop] button once more, you can immediately stop the intro or ending, even when while these are being played.

## Selecting Parts

You can switch corresponding Parts on or off using the [Drums], [Bass], and [Chord] buttons.

When you press a button and extinguish its light, its Part is not played.

\* Some guitar sounds are included in the [Drums] parts.



For more information on the different Rhythm types, refer to the "Rhythm List" (p. 62).



You can set the Chord display on or off (p. 47).



You can also specify the chords to be played in a Rhythm. For details, refer to "Performing With the Chord Progression Specified in the Left Hand (Chord Progression off)" (p. 35).



You can change the chord progression patterns. Refer to the "Selecting a Rhythm's Chord Progression" (p. 34).



You can press the [Start/Stop] button to finish without playing an Intro or Ending. See "Setting the Intro and Ending on or off" (p. 47).



## ■ Changing the Volume of a Part

You can adjust the volume level of individual Parts.

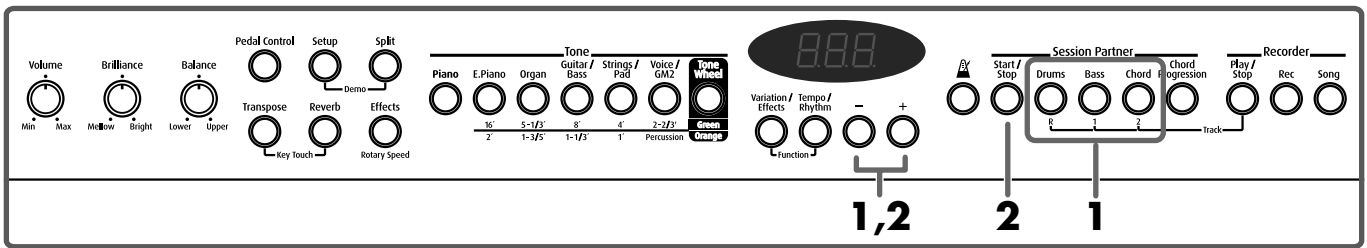

- 1.** While holding down the button for the Part whose volume level you want to change (the [Drums], [Bass], or [Chord] button), press the [-] or [+] button.  
The volume level of the Part whose button you pressed is displayed.
- 2.** If you want to change the volume level for all Parts, hold down the [Start/Stop] button and press the [-] or [+] button.

## Selecting a Rhythm

Now, try changing the Rhythm being performed.

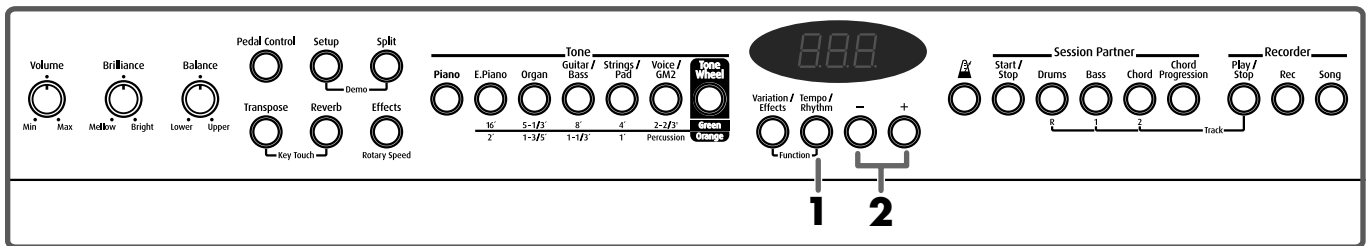

- 1.** Press the [Tempo/Rhythm] button, getting its indicator to light in orange.  
The Rhythm number is displayed.  
Rhythm numbers are indicated by an “r” before the number.



- 2.** Press the [-] or [+] button to select the Rhythm.

## Changing Rhythms As You Perform

If you change Rhythms while a Rhythm is being played, the selected Rhythm begins after the fill-in is played.

### What’s a “Fill In”?

A short improvisational phrase inserted at the bar line is called a “Fill In.”  
The phrase best suited to the selected Rhythm is played.

### Changing a Rhythm's Tempo

The FP-5 has an optimal tempo for each Rhythm.

You can change the tempo of the selected Rhythm.

Furthermore, you can change the tempo as the Rhythm is being played.

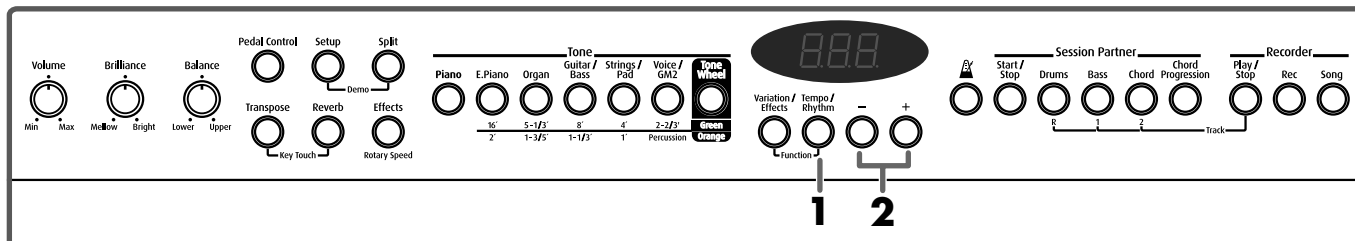

#### 1. Press the [Tempo/Rhythm] button, getting its indicator to light in red.

The tempo is displayed.

Pressing the [Tempo/Rhythm] button alternately displays the tempo and the currently selected Rhythm number (indicated by an initial "r").

#### 2. Press the [+] and [-] buttons to adjust the tempo.

The tempo can be changed within the range from ♩ = 20 ~ 250.

When the [Start/Stop] button is pressed, the Rhythm is played at the selected tempo.

When the tempo is displayed, you can set it to the optimal tempo to appear in the display, then pressing the [-] and [+] buttons at the same time.

### Selecting a Rhythm's Chord Progression

The FP-5 has an optimal chord progression pattern for each Rhythm.

When playing the Chord Part while performing, the chord progression is automatic. You can change the chord progression pattern if you want.

#### 1. Hold down the [Chord Progression] button and press the [-] or [+] button to change the chord progression pattern.

The currently selected chord progression pattern number is displayed.



If you change the Rhythm during Session Partner play, the tempo won't change. At such times, you can set it to the optimal tempo by getting the tempo to appear in the display, then pressing the [-] and [+] buttons at the same time.



For more information on chord progression patterns, refer to the "Chord Progression Pattern List" (p. 63).



Recorded chord progression patterns are saved to "US-" You can select "US-" patterns by pressing the [-] button when pattern number 1 is displayed.



You can change the root note of the first chord. refer to "Setting the Root Note of the Chord Progression" (p. 47).

## Performing With the Chord Progression Specified in the Left Hand (Chord Progression off)

Performing with the keyboard divided at a certain key into a left side and a right side is called “Split Play.”

While in Split Play, you can use the left side to specify chords instead of using it to play the Lower Tone.

**NOTE**

When specifying the chords in the left part of the keyboard, Dual Play (p. 18) is disabled in the right part.

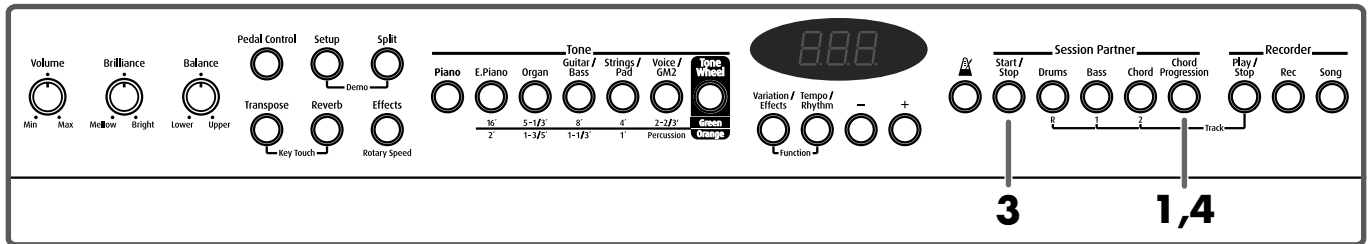

1. Press the [Chord Progression] button, getting its indicator to go out.

The [Split] button’s indicator lights up.

The indicator for the [Start/Stop] button flashes, and the FP-5 is put into standby mode.

2. The chord is specified with a key in the left part of the keyboard, and the Rhythm begins.

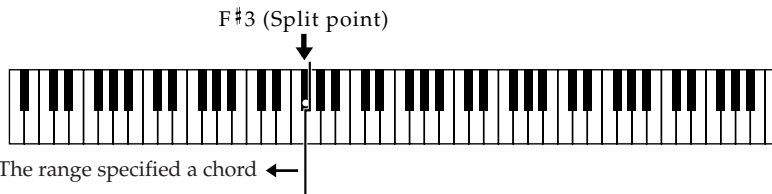

Specify the chord in the left part of the keyboard, and perform the melody in the right side.

It is not necessary to continue holding down the keys for chords in the left side. Even after you release the key, the same chord continues until the next chord is played.

When specifying chords, sounds from the left side of the keyboard are not played.

3. To stop the Rhythm, press the [Start/Stop] button.

After the ending is done, the performance stops.

The indicator for the [Start/Stop] buttons then start flashing, and the FP-5 is put into standby mode.

4. To exit, press the [Chord Progression] button.

**MEMO**

You can specify chords simply with your finger, even without playing the keys for all the chords’ constituent notes. For more information about chord fingering, refer to the “Chord Fingering List” (p. 65).

**MEMO**

The button’s indicator does not go out when you press the [Split] button here. At this point, you can perform with the Lower Tone while specifying chords in the left part of the keyboard. When you press the [Split] button once more, the button’s indicator does go out, and you can perform while specifying chords over the entire keyboard.

**MEMO**

The point at which the keyboard is divided is called the “split point”; you can also change this split point. For more information, take a look at “Changing the Keyboard’s Split Point” (p. 20).

# Recording the Chord Progression (Chord Progression)

You can save a chord progression you've specified using the left-hand section of the keyboard.



You can listen to a wide variety of styles with a favorite chord progression. Refer to "Fixing a Set Chord Progression" (p. 47).

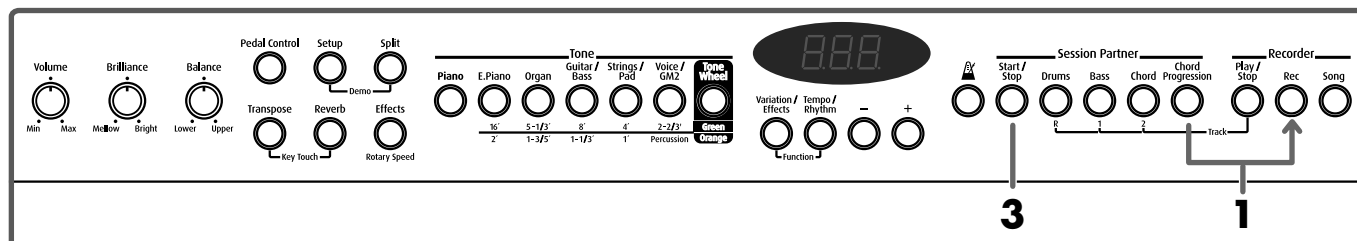

1. Hold down the [Chord Progression] button and press the [Rec] button.

The [Chord Progression] button and the [Rec] buttons' indicator flashes in red, the [Start/Stop] buttons' indicator flashes in orange., and the FP-5 is put into recording standby.

The "UCP (User Chord Progression)" appears in the display.



2. The chord is specified with a key in the left part of the keyboard, and the Rhythm begins.

The chord being played is indicated in the display.

You can store up to sixteen chords.

3. Recording stops when the performance exceeds eight measures or when you press the [Start/Stop] button.

### Changing the Stored Measure Count

You can change the number of measures recorded for the chord progression. This is set to eight measures when the FP-5 is turned on. Measure counts of "4/8/12/16" can be selected.

1. Hold down the [Chord Progression] button and press the [Rec] button.

The "UCP (User Chord Progression)" appears in the display.

2. Press the [-] and [+] button to select measure counts.

3. The chord is specified with a key in the left part of the keyboard, and the Rhythm begins.

4. Press the [Start/Stop] button to stop recording.



Press the [Chord Progression] button or the [Rec] button to exit from recording standby.



Recorded chord progression patterns are saved to

"USR." You can select

"USR." patterns by pressing the [-] button when pattern number 1 is displayed.



The song may not play back correctly if the performance is played with a different beat than the one used in recording the original chord progression.



You can store up to sixteen chords. Regardless of the number of measures set, recording stops when the seventeenth chord is specified.



The recorded chord progression will be discarded as soon as the power is turned off. If you want to keep it, you'll need to save the Setup (p. 37).

## Storing Settings (Setup)

You can save favorite combinations of Tone settings, settings for dual and split play, Session Partner settings, and the like as a “Setup.”

Once saved in this way, you can instantaneously switch the instrument to the desired group of settings simply by calling up the Setup.

You can store up to 7 different Programs.

The recommended settings were stored in the instrument when it shipped from the factory.



The Setup contains stored and unstored settings. Refer to “Settings Stored in the Setup” (p. 71).

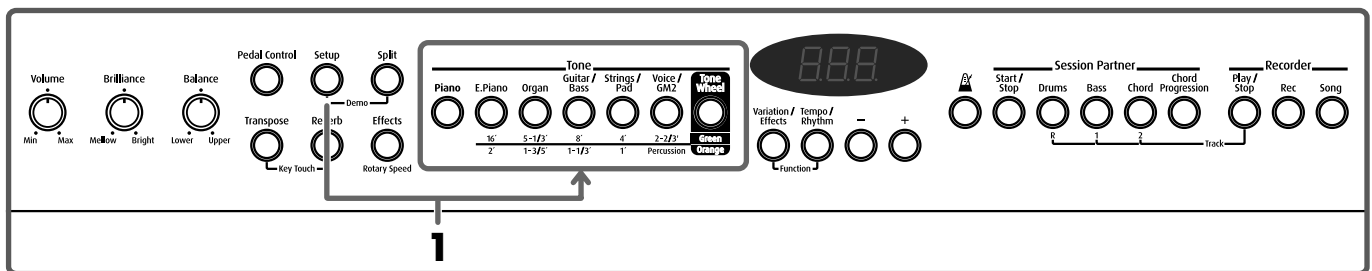

1. Hold down the [Setup] button and press the ether Tone button.

The pressed Tone button and the display flash, and the current settings are stored.

### ■ Selecting Stored Settings

1. Press the [Setup] buttons.

The Tone button’s indicator flashes in green.

2. Press the Tone button to which the settings you want to call up have been stored.

Only the indicator on the selected button flashes in green.

# Chapter 3 Recording a Performance

You can easily record your performances.

You can play back a performance you have recorded to check what and how you played, and play melodies on the keyboard along with prerecorded accompaniment using the Rhythm.

## Notes Regarding Recording

- Only one song can be recorded. With second or later recordings, the previously recorded song is erased as the new material is recorded. When recording a new performance, it is probably a good idea to erase the previously recorded performance first (p. 41).
- Recorded performances are erased when the power is turned off.

## Recording a Performance

This records only what you play on the keyboard, without using the Session Partner.

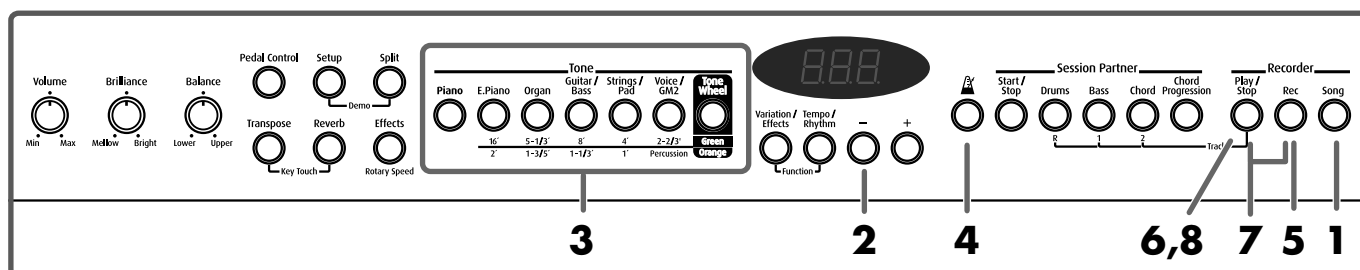

### 1. Press the [Song] button, getting its indicator to light.

The song number appears in the display.

### 2. Press the [-] button to display the "USr."

### 3. Select the Tone to be played (p. 14).

### 4. If necessary, sound the metronome.

While listening the metronome, select the tempo and beat of the song (p. 29).

### 5. Press the [Rec] button.

The [Rec] button's indicator lights, the [Play/Stop] button's indicator begins flashing, and the FP-5 is put into recording standby.

### 6. Press the [Play/Stop] button or play a key on the keyboard to begin recording.

Press the [Play/Stop] button, and after two measures of count sound, recording begins.

Recording starts when you start playing the keyboard (without pressing any button). In this case, a count is not sounded.

### 7. Press the [Rec] button or the [Play/Stop] button to stop recording.

The indicators for the [Rec] and [Play/Stop] buttons are extinguished, and recording stops.



**To Record Without Erasing the Previously Recorded Performance...**

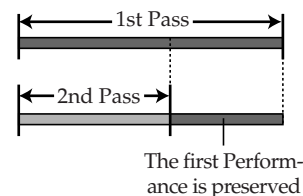

You can save recorded songs to an external sequencer. Refer to p. 49.



During the count-in, the count measure is indicated in the display as "-2" then "-1."



**About "USr" in the Display**

When recording is stopped, the " **USr** " indication changes to " **USr** " in the display. The "." in the display indicates that there is Performance material already recorded.

### Listening to the Recorded Performance

8. Press the [Play/Stop] button.  
Press the [Play/Stop] button again, and playback stops.

### ■ Recording a Performance Using Session Partner

You can also easily record session performances to the session partner.



The demo song cannot be played back while recorded performance data remains in the FP-5's memory. Press [Rec] button to delete the performance data (p. 13).

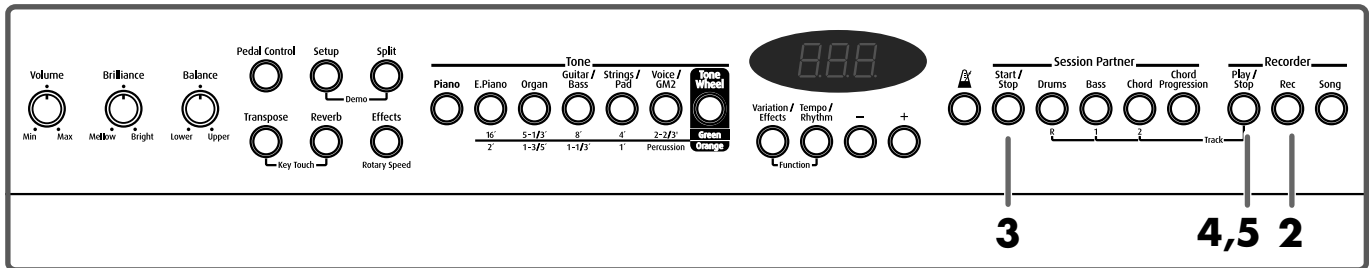

1. Select the Tone or Rhythm to be played (p. 32-p. 36).
2. Press the [Rec] button.  
The [Rec] button's indicator lights up, the [Play/Stop] button's indicator flashes, and the FP-5 is put into recording standby.
3. Recording starts when you begin the performance with Session Partner (p. 32, p. 35).  
The Rhythm starts to play, while simultaneously recording begins.
4. Press the [Play/Stop] button to stop recording.

### Listening to the Recorded Performance

5. Press the [Play/Stop] button.  
Press the [Play/Stop] button again to stop playback.



For more on selecting tone and Rhythm, refer to p. 14 and p. 33.



For more information on the different Rhythm and Chord progression pattern, refer to the "Rhythm List" (p. 62) and "Chord Progression Pattern List" (p. 63).

#### NOTE

If you want to record with the chord progression specified (p. 35), the chord is specified with a key in the left part of the keyboard, and recording begins.

## Chapter 3 Recording a Performance

### ■ Recording Selected Track buttons

FP-5's Recorder has three Track buttons.

When you press the [Rec] button, all Track buttons are set to be recorded, but by selecting Track buttons that are not to be recorded, you can then record only on the specific Track buttons you want.

For example, you can record each hand's performance to different Track buttons, or record over only certain Track buttons in a previously recorded performance.



Only sounds from Drum set tones and Session Partner sounds can be recorded to the [Drums (R)] button.

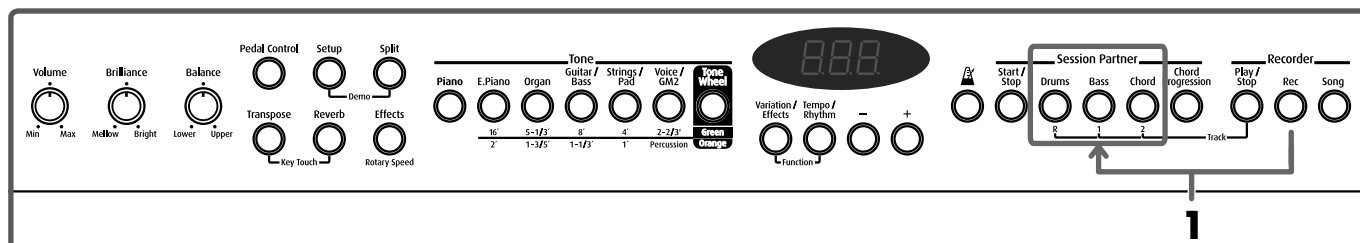

1. While holding down the [Rec] button, and turn off the indicator light for the Track button, whether the [Drums (R)], [Bass (1)], or [Chord (2)] button, for any track not to be recorded.

The [Rec] button's indicator lights up, the [Play/Stop] button's indicator flashes, and the FP-5 is put into recording standby.

With the FP-5 in standby, go on to record the performance according to the procedures as described in "Recording a Performance" (p. 38), "Recording a Performance Using Session Partner" (p. 39), starting from Step 3.

The performance is not recorded only to the Track buttons whose indicator was turned off.

### Recording along with internal songs

You can also record your own performance as you play along with the internal piano songs.

When recording to specific Track buttons, the sounds on the selected Track buttons are not played. For example, you can record what you are playing with your right hand as you listen to the left-hand part.

1. With the [Song], [-] and [+] buttons select the song.
2. Hold down the [Rec] button and turn off the indicator light for the track button of the track you intend not to play yourself.

The [Rec] button's indicator lights up, the [Play/Stop] button's indicator flashes, and the FP-5 is put into recording standby.

3. Press the [Play/Stop] button to start recording.
4. Press the [Rec] or [Play/Stop] button to stop recording.



### About the Lighting of Track Button Indicators

when the [Rec] button is pressed, track button indicate the status of recording, as shown below.

Dark 	Not Recording
Flash in red 	Recording



### Correspondence Between Internal Piano Song Track Buttons and Performance

[1] button: left-hand Part  
[2] button: right-hand Part  
No performance data is assigned to the [R] button.



# Erasing Recorded Performances

You can erase recorded performances.

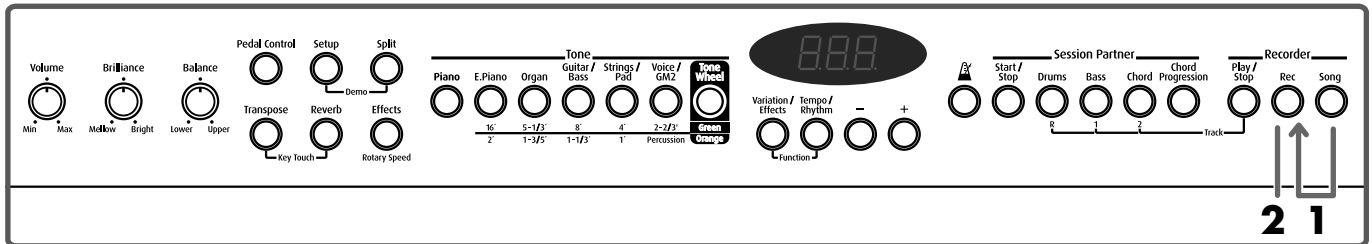

1. Hold down the [Song] button and press the [Rec] button.

A confirmation message appears in the display.

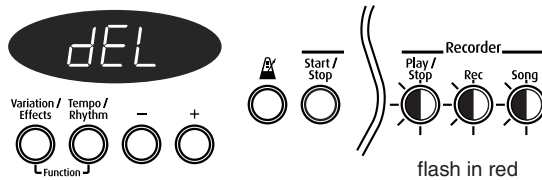

2. Press the [Rec] button.

The recorded performance is erased.

If you do not want to erase the performance, press the [Play/Stop] or [Song] button.

## Correspondence Between Recorded Performance and Track Buttons

A recorded performance will be assigned to the Track buttons as follows.

Track button	Performance recorded
[R]	<ul style="list-style-type: none"> <li>• Session Partner (p. 31)</li> <li>• A performance of drum set tones</li> </ul>
[1]	<ul style="list-style-type: none"> <li>• Lower Tone in Dual play or Split play (p. 18, p. 19)</li> </ul>
[2]	<ul style="list-style-type: none"> <li>• The performance of the entire keyboard (except drum set tones)</li> <li>• Upper Tone in Dual play or Split play (p. 18, p. 19)</li> </ul>

\* You can also record to the [1] button regular keyboard performances in which only the [1] button is specified.

# Chapter 4 Other Functions

You can make a variety of performance- and recording-related settings in “Function Mode.”

## How to make settings

### 1. Hold down the [Variation/Effects] button, and press the [Tempo/rhythm] button.

“Fnc” appears in the display, and the FP-5 switches to Function Mode.

The [Variation/Effects] and [Tempo/Rhythm] buttons flash in green, and the indicators for the button to which the function is assigned flash in red.

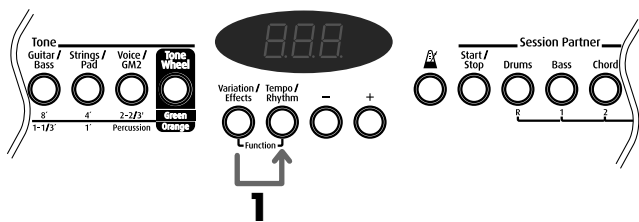

### 2. Press one of the flashing buttons.

The flashing button’s indicator other than the pressed button go out.

Each value is displayed.

While pressing the button, function name is displayed.

### 3. Press the [-] or [+] button or play a key on the keyboard to set.

### 4. Press the [Variation/Effects] or [Tempo/Rhythm] button to exit Function Mode.

The button’s indicator will return to the previous state.

Button	Function	Page
[Pedal Control]	Works of the pedal control	p. 44
[Setup]	Bulk Dump, Pedal Shift, Transferring the program change	p. 52
[Split]	Octave shift	p. 44
[Transpose]	Temperament	p. 45
[Reverb]	Velocity	p. 45
[Effects]	Setting the part to which effects are added	p. 44
[Piano]	Master Tuning	p. 45
[E. Piano]	How the soft pedal(FC2) effects are applied	p. 43
[Organ]	How the sostenuto pedal(FC1) effects are applied	p. 43
[Guitar/Bass]	How the damper pedal effects are applied	p. 43
[Strings/Pad]	Soft pedal(FC2)s work	p. 43
[Voice/GM2]	Sostenuto pedal(FC1)s work	p. 43
[Tone Wheel]	Set USB driver	p. 53
[Metronome]	Metronome beat pattern	p. 46
[Start/Stop]	Setting the Intro and Ending on or off	p. 47
[Bass]	Root note of the chord progression	p. 47
[Chord]	Chord display	p. 47
[Chord Progression]	Fixing a set chord progression	p. 47
[Play/Stop]	MIDI Out mode	p. 51
[Rec]	MIDI send channel settings	p. 50
[Song]	Local Control	p. 50

## Changing How the Pedal Effects Are Applied

When the pedal is pressed in Dual Play (p. 18) or Split Play (p. 19), the pedal's effect is applied to both the Upper Tone and the Lower Tone, but you can change the settings for the tone to which the effect is applied.

Indication	Description
<b>U-L</b>	All enabled
<b>-U-</b>	Applied only to the Upper Tone
<b>-L-</b>	Applied only to the Lower Tone

### ■ How the Soft Pedal(FC2) effects are applied

1. Switch to Function mode, and press the [E.Piano] button.

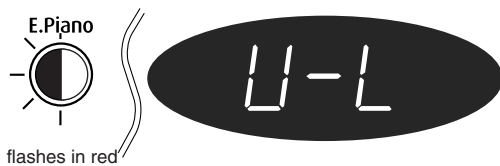

2. Press the [-] or [+] button to select how the pedal effects are to be applied.

### ■ How the Sostenuto Pedal(FC1) effects are applied

1. Switch to Function mode, and press the [Organ] button.
2. Press the [-] or [+] button to select how the pedal effects are to be applied.

### ■ How the Damper Pedal effects are applied

1. Switch to Function mode, then press the [Guitar/Bass] button.
2. Press the [-] or [+] button to select how the pedal effects are to be applied.

## Changing How the Pedals Work

A pedal connected to the Soft(FC2) jack normally functions as a soft pedal (p. 9). A pedal connected to the Sostenuto(FC1) jack normally functions as a sostenuto pedal (p. 9).

It can also be set to function as another works.

You can select from the following ten pedal functions.

\* With certain sounds, the function may not work.

Indication	Description
<b>dnP</b> (Damper)	Sets function to damper pedal.
<b>Sft</b> (Soft)	Sets function to soft pedal.
<b>Stn</b> (Sostenuto)	Sets function to sostenuto pedal.
<b>EPr</b> (Expression)	Allows control of the volume. Connect a separately available expression pedal (EV-5).  * You cannot change volume level of session partner.
<b>r.St</b> (Start/Stop)	Allows control the start/stop of Session Partner by pressing the pedal, instead of pressing the buttons.
<b>L.bS</b> (Leading bass)	Allows control the on/off of leading bass function*. It is turned on while having stepped on the pedal.
<b>EFF</b> (On/Off of Effects)	Effects can be switched on/off by pressing the pedal instead of pressing the [Effects] button. When effect type is rotary, you can control the slow / fast of spinning.
<b>b.uP</b> (Bend Up)	Pitch rises by pressing the pedal
<b>b.dn</b> (Bend Down)	Pitch lowers by pressing the pedal
<b>Mod</b> (Modulation)	Vivato is added by pressing the pedal

#### \* What is the leading bass function?

The function that sounds the lowest note of a fingered chord as the bass tone is called "Leading Bass."

\* Use only the specified expression pedal (EV-5; sold separately).  
By connecting any other expression pedals, you risk causing malfunction and/or damage to the unit.

\* The function may not work properly if a pedal other than the supplied pedal or expression pedal is used.

\* Be sure to switch off the power to the unit before attempting to disconnect or connect a pedal cord.

## Chapter 4 Other Functions

### ■ Works of the Soft Pedal(FC2)

When the instrument is turned on, this is set to function as a soft pedal.

1. Switch to Function mode, and press the [Strings/Pad] button.



2. Press the [-] or [+] button to select the pedal function.

### ■ Works of the Sostenuto Pedal(FC1)

When the instrument is turned on, this is set to function as a sostenuto pedal.

1. Switch to Function mode, and press the [Voice/GM2] button.
2. Press the [-] or [+] button to select the pedal function.

## Changing the Work of the Pedal Control

Connecting the included pedal to the Damper jack allows you to use pedal to alter the sounds' pitches, when you press the [Pedal Control] button to light up.

It can also be set to function as an another works.

1. Switch to Function mode, and press the [Pedal Control] button.

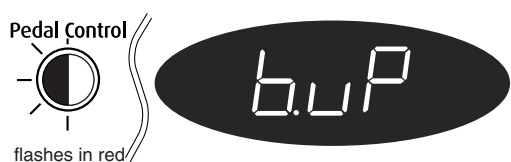

2. Press the [-] or [+] button to select the pedal function.

indication	function	description
<b>b.uP</b>	Bend Up	Pitch rises by pressing the pedal
<b>b.dn</b>	Bend Down	Pitch lowers by pressing the pedal
<b>Mod</b>	Modulation	Vivtrato is added by pressing the pedal

\* The function may not work properly if a pedal other than the supplied pedal or expression pedal is used.

\* Be sure to switch off the power to the unit before attempting to disconnect or connect a pedal cord.

## Setting the Part to Which Effects Are Added

This specifies which part is to have priority when the effects assigned to the Upper Tone and Lower Tone differ in Dual Play or Split Play.

1. Switch to Function mode, and press the [Effects] button.

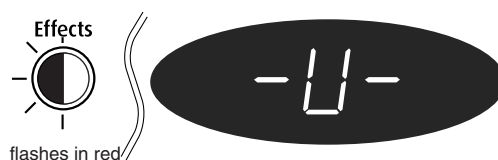

2. Press the [-] or [+] button to select Upper or Lower.

indication	description
<b>-U-</b> (Upper)	Effects are added to the Upper Tone.
<b>-L-</b> (Lower)	Effects are added to the Lower Tone.

→ If same effects are assigned to the Upper Tone and Lower Tone, the same effects are added to both of Tones.

## Changing the Pitch of the Lower Tone in Octave Steps (Octave Shift)

You can change the pitch of the Lower Tone in Dual Play (p. 18) and Split Play (p. 19) an octave at a time.

Altering the pitch in one-octave units in this way is called "Octave Shift."

For example, you can raise the pitch of the Lower Tone to the same pitch of the Upper Tone in Split Play.

1. Switch to Function mode, and press the [Split] button.

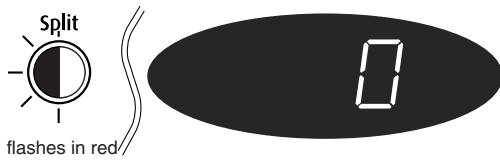

**2. Press the [-] or [+] button to select the pitch.**

The range of available pitch change spans from two octaves higher to two octaves lower.

The pitch is lowered one octave each time the [-] button is pressed, while each press of the [+] button raises the pitch by one octave.

To return to the original pitch, press the [-] and [+] buttons simultaneously.

## Changing the Velocity When the Key Touch Is Set to "Fixed"

This sets the velocity the sound will have when the keyboard touch is set to "Fixed (p. 22)."

**1. Switch to Function mode, and press the [Reverb] button.**

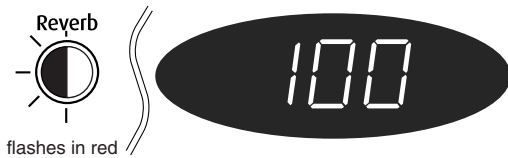

**2. Press the [-] or [+] button to change the velocity.**

You can set this to any value from 1 to 127.

## Tuning to Other Instruments' Pitches (Master Tuning)

When playing ensemble with other instruments and in other such instances, you can match the standard pitch to another instrument.

The standard pitch generally refers to the pitch of the note that's played when you finger the middle A key. For a cleaner ensemble sound while performing with one or more other instruments, ensure that each instrument's basic pitch is in tune with that of the other instruments. This tuning of all the instruments to a standard pitch is called "master tuning."

When the instrument is turned on, the standard pitch is set to "440.0 Hz."

**1. Switch to Function mode, and press the [Piano] button.**



The last three digits of the current standard pitch setting appear in the display.

**2. Press the [-] or [+] button to change the standard pitch.**

You can set the standard pitch anywhere in a range of 415.3 Hz to 466.2 Hz.

The pitch is lowered 0.1 Hz each time the [-] button is pressed. When the button is held down, the pitch drops continuously.

The pitch is raised 0.1 Hz each time the [+] button is pressed. When the button is held down, the pitch rises continuously.

To return to the original pitch, press the [-] and [+] buttons simultaneously.

## Adjusting the Tuning (Temperament)

You can play classical music such as baroque pieces using their original tuning.

Most modern songs are composed and played with the assumption that equal temperament (the most common tuning in use today) will be used, but when classical music was composed, there were a wide variety of other tuning systems in existence. Playing a composition with its original tuning lets you enjoy the sonorities of the chords that the composer originally intended.

**1. Switch to Function mode, and press the [Transpose] button.**

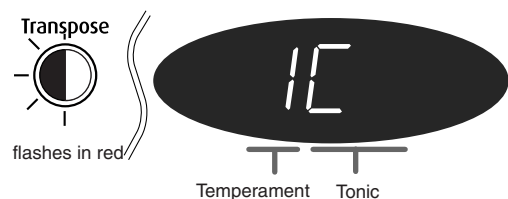

**2. Press the [-] or [+] button to change the temperament.**

## Chapter 4 Other Functions

You can choose from among the seven tunings described below.

	Temperament	Qualities
1	Equal	In this tuning, each octave is divided into twelve equal steps. Every interval produces about the same amount of slight dissonance. This setting is in effect when you turn on the power.
2	Pythagorean	This tuning, devised by the philosopher Pythagoras, eliminates dissonance in fourths and fifths. Dissonance is produced by third-interval chords, but melodies are euphonious.
3	Just Major	This tuning eliminates ambiguities in the fifths and thirds. It is unsuited to playing melodies and cannot be transposed, but is capable of beautiful sonorities.
4	Just Minor	The Just tunings differ from major and minor keys. You can get the same effect with the minor scale as with the major scale.
5	Mean Tone	This scale makes some compromises in just intonation, enabling transposition to other keys.
6	Werckmeister	This temperament combines the Mean Tone and Pythagorean tunings. Performances are possible in all keys (first technique, III).
7	Kirnberger	This is an improvement of the Mean Tone and Just tunings that provides a high degree of freedom of modulation. Performances are possible in all keys (III).

### 3. Press a key corresponding to the keynote.

The display is as follows:

Display	C	d <sub>~</sub>	d	E <sub>~</sub>	E	F	F <sub>~</sub>	G	A <sub>~</sub>	A	b <sub>~</sub>	b
Letter name	C	D <sub>b</sub>	D	E <sub>b</sub>	E	F	F <sub>#</sub>	G	A <sub>b</sub>	A	B <sub>b</sub>	B

When playing with tuning other than equal temperament, you need to specify the keynote for tuning the song to be performed (that is, the note that corresponds to C for a major key or to A for a minor key).

If you choose an equal temperament, there's no need to select a keynote.

\* When performing in ensemble with other instruments, be aware that depending on the key, there may be some shifting of the pitch. Tune the FP-5 to the fundamental pitch of the other instruments.





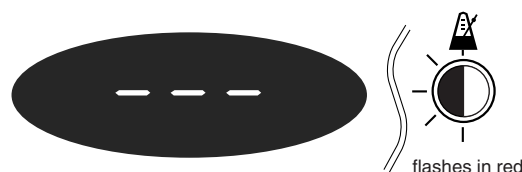

## Changing the Beat Pattern

The metronome usually sounds one beat per quarter note, but you can change the beat pattern to sound, for example, one beat for every dotted quarter note.

1. Switch to Function mode, and press the [  (Metronome) ] button.



2. Press the [-] or [+] button to change the beat division.

Indication	Description
— (Normal)	The metronome sounds in the ordinary way.
2. (  )	Counting starts at the beginning of the measure, in intervals of dotted half-note upbeats.
2 (  )	Counting starts at the beginning of the measure, in intervals of half-note upbeats.
4. (  )	Counting starts at the beginning of the measure, in intervals of dotted quarter-note upbeats.
4 (  )	Counting starts at the beginning of the measure, in intervals of quarter-note upbeats.
8. (  )	Counting starts at the beginning of the measure, in intervals of dotted eighth-note upbeats.
8 (  )	Counting starts at the beginning of the measure, in intervals of eighth-note upbeats.
16 (  )	Counting starts at the beginning of the measure, in intervals of sixteenth-note upbeats.
A1	The metronome plays with a backbeat added to each beat.
A2	Counting is with triplets for each beat.
A3	The added sounds are shuffled.

→ If you select "A1" with a triplet rhythm (6/8, 9/8, 12/8), the additional sound is played in the same way as "A2."

→ Refer to "Using the Metronome" (p. 29).

## Setting the Intro and Ending on or off

This sets session partner Intro and Ending on or off. When set to "Off," pressing [Start/Stop] causes the Intro and Ending not to be played.

1. Switch to Function mode, and press the [Start/Stop] button.



2. Press the [-] or [+] button to set on or off.

<b>ON</b>	Pressing [Start/Stop] causes the Intro and Ending to be played.
<b>OFF</b>	Pressing [Start/Stop] causes the Intro and Ending not to be played.

## Fixing a Set Chord Progression

When changing the Session Partner Rhythm, select whether or not the chord progression is to change along with the Rhythm. The default value when the power is turned on is "ON."

1. Switch to Function mode, and press the [Chord Progression] button.



2. Press the [-] or [+] button to set on or off.

<b>ON</b>	When the rhythm changes, a change to the optimal chord progression is made.
<b>OFF</b>	When the rhythm changes, the chord progression does not change.

## Setting the Root Note of the Chord Progression

This sets the root note of the chord progression.

1. Switch to Function mode, and press the [Bass] button.

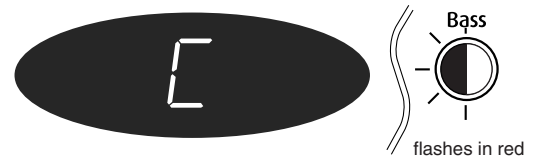

2. Press the key corresponding to the root note of the first chord.

The root is indicated in the display as shown below.

Display	C	d_	d	E_	E	F	F <sup>-</sup>	G	A_	A	b_	b
Letter name	C	D <sup>b</sup>	D	E <sup>b</sup>	E	F	F <sup>#</sup>	G	A <sup>b</sup>	A	B <sup>b</sup>	B

→ You can hold down the [Bass] button and pressing the [-] or [+] button to change the cord progression pattern.

## Setting the Chord Display on or off

This setting determines whether or not the chords are indicated in the display during performances using Session Partner.

1. Switch to Function mode, and press the [Chord] button.



2. Press the [-] or [+] button to set on or off.

<b>ON</b>	Chords are displayed.
<b>OFF</b>	Chords are not displayed.



## Chapter 4 Other Functions

### Connecting to Audio Equipment

You can connect audio devices to play the sound of the FP-5 through the speakers of your audio system, or to record your performance on a tape recorder or other recording device.

When connecting, please use an audio cable with a standard phone plug (sold separately).

#### Connection Examples

\* To prevent malfunction and/or damage to speakers or other devices, always turn down the volume, and turn off the power on all devices before making any connections.

#### Playing the sound of the FP-5 through the speakers of an audio system/Recording the performance of the FP-5 on a recording device

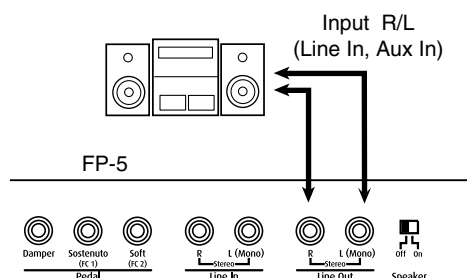

○ Use the following procedure when turning on the power.

1. Set the volume of the FP-5 and of the connected devices to the minimum position.
2. Set the speaker switch to “OFF” located on the rear panel.
3. Turn on the power of the FP-5.
4. Turn on the power of the connected device.
5. Adjust the volume of each device.

#### When Recording FP-5 Performances on a Recording Device

6. Start recording with the connected device.
7. Perform on the FP-5.
8. When the performance ends, stop recording on the connected equipment.

#### Playing the sound of an audio device through the speakers of the FP-5

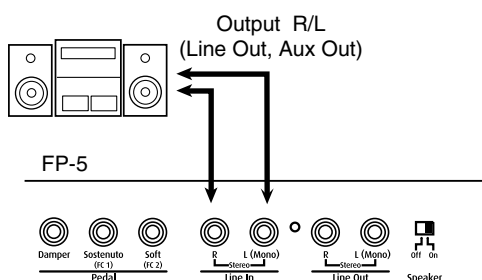

○ Use the following procedure when turning on the power.

1. Set the volume of the FP-5 and of the connected devices to the minimum position.
2. Set the speaker switch to “OFF” located on the rear panel.
3. Turn on the power of the connected device.
4. Turn on the power of the FP-5.
5. Adjust the volume of each device.

#### Turning off the power

1. Set the volume of the FP-5 and of the connected devices to the minimum position.
2. Turn off the power to the FP-5.
3. Turn off the connected equipment.

## About the FP-5 Sound Generator

The FP-5 come equipped with GM2 sound generators.

### General MIDI

The General MIDI is a set of recommendations which seeks to provide a way to go beyond the limitations of proprietary designs, and standardize the MIDI capabilities of sound generating devices. Sound generating devices and music files that meets the General MIDI standard bears the General MIDI logo. Music files bearing the General MIDI logo can be played back using any General MIDI sound generating unit to produce essentially the same musical performance.

### General MIDI 2

The upwardly compatible General MIDI 2 recommendations pick up where the original General MIDI left off, offering enhanced expressive capabilities, and even greater compatibility. Issues that were not covered by the original General MIDI recommendations, such as how sounds are to be edited, and how effects should be handled, have now been precisely defined. Moreover, the available sounds have been expanded. General MIDI 2 compliant sound generators are capable of reliably playing back music files that carry either the General MIDI or General MIDI 2 logo.

In some cases, the conventional form of General MIDI, which does not include the new enhancements, is referred to as “General MIDI 1” as a way of distinguishing it from General MIDI 2.



## Connecting to the USB Connector

You can use a USB connector to connect the FP-5 to your computer. For more details, refer to the separate “USB Installation Guide.”

- \* Connecting your computer to the FP-5 for the first time requires installation of the “USB Driver” (on the included CD-ROM) to the computer. For more details, refer to the separate “USB Installation Manual.”
- \* Only MIDI data can be transmitted using USB.
- \* To prevent malfunction and/or damage to speakers or other devices, always turn down the volume, and turn off the power on all devices before making any connections.
- \* USB cables are not included. Consult your Roland dealer if you need to purchase.
- \* Turn on the power to the FP-5 before starting up MIDI applications on the computer. Do not turn the FP-5 on or off while any MIDI application is running.
- \* Do not connect or disconnect the USB cable while the FP-5’s power is on.
- \* If not using USB, disconnect the USB cable from the FP-5.
- \* If, during the transmission/reception of data, the computer switches to energy-saving mode or suspended mode, or if the FP-5’s power is switched on or off, the computer may freeze, or the FP-5’s operation may become unstable.
- \* When using your computer’s sequencer software to record FP-5 performances, we recommend setting the sequencer software’s Soft Thru to “OFF,” or setting MIDI Out mode (p. 51) to “4.”

## Connecting MIDI Devices

### About MIDI

MIDI stands for “Musical Instrument Digital Interface,” and is a worldwide standard for the exchange of performance data (MIDI messages) and other information among electronic instruments and computers.

The FP-5 features a MIDI connector and a computer connector to allow performance information to be exchanged with external devices. Connecting the keyboard to other devices with these connectors provides you with an even greater variety of ways to use your keyboard.

- \* A separate publication titled “MIDI Implementation” is also available. It provides complete details concerning the way MIDI has been implemented on this unit. If you should require this publication (such as when you intend to carry out byte-level programming), please contact the nearest Roland Service Center or authorized Roland distributor.
- \* MIDI cables are not included. Consult your Roland dealer if you need to purchase.

### Connectors

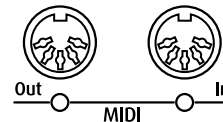

#### MIDI Out Connector

Sends data about what is being played on the keyboard and other performance data.

Connect to the MIDI in connector on the external MIDI device.

#### MIDI In connector

Receives messages sent from external MIDI devices.

Connect to the MIDI Out connector on the external MIDI device.

### Making the Connections

- \* To prevent malfunction and/or damage to speakers or other devices, always turn down the volume, and turn off the power on all devices before making any connections.

- 1. Turn the volume all the way down on the FP-5 and on the device you’re about to connect.**
- 2. Turn off the power to the FP-5 and to the device being connected.**
- 3. Connect a MIDI cable (sold separately) between the MIDI connectors on each device.**
- 4. Switch on the power to the FP-5 and the connected device.**
- 5. Adjust the volume level on the FP-5 and the connected device.**
- 6. You should also set the MIDI settings as needed.**  
Make the settings for the MIDI send and receive channels (p. 50) and for Local On/Off (p. 50).

### ■ How to Enjoy MIDI

#### Recording Data of Performances Played on the FP-5 to a Sequencer\* and Automatically Playing Recorded Performance Data on the FP-5

Connection example:

Connecting to a sequencer (the Roland MT series, etc.)

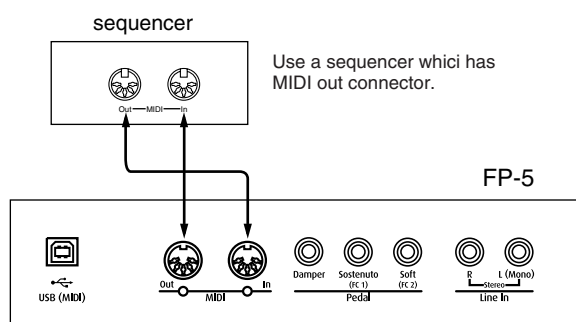

→ When connecting a sequencer, we recommend using it with the settings described below.

- Local Control off (p. 50)
- MIDI Out Mode 4 (p. 51)

When the instrument is turned on, MIDI Out Mode is set to "1."

#### Performing on the FP-5 Using Sounds from Another Sound Module\*

Connection Example: Connecting to a MIDI Sound Module

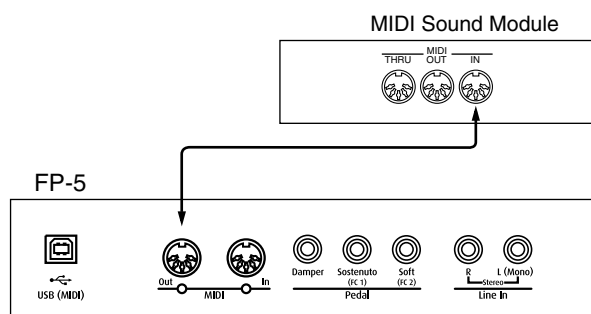

→ When connecting to a MIDI sound module, we recommend using the system with MIDI Out Mode set to "2" (p. 51).

When the instrument is turned on, MIDI Out Mode is set to "1."

#### What is a Sequencer?

A sequencer is a device that records the stream of MIDI messages that is sent out by an instrument. These messages convey all the details of what has occurred while the instrument is played; including the timing of notes, their sound, the force used to play them, and for how long. Afterwards, you can send the recorded MIDI information back to the instrument, and it will play automatically.

#### What is a MIDI Sound Module?

Inside a synthesizer or electronic piano is the section that actually produces sound, known as the sound module. A MIDI sound module produces sounds as the result of MIDI messages sent to it by other devices.

### ■ MIDI Settings

#### MIDI Send Channel Settings

Select the transmission channel of FP-5.

MIDI features sixteen MIDI channels, numbered 1–16. Simply connecting a cable is not enough for communication to take place. The connected devices must be set to use the same MIDI channels. Otherwise, no sound will be produced, and no sounds can be selected.

When the instrument is turned on, this is set to Channel "1." The FP-5 receives messages on all channels, 1–16.

- \* When the keyboard is in dual play, the channel you've set here is transmitted.
- \* When the keyboard is split into left and right sides, the transmission channel for messages from the left-hand side is fixed at "3."

#### 1. Switch to Function mode(p. 42), and press the [Rec] button.

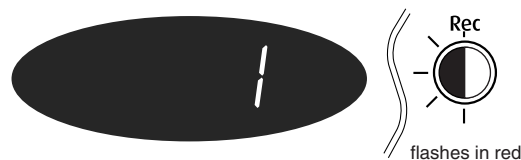

#### 2. Press the [-] or [+] button to select the transmission channel.

Select the transmission channel (1–16) of the FP-5.

#### Switching Local Control On and Off

When connecting a MIDI sequencer, set Local Control to "Off."

When the instrument is turned on, this is set to "On."

As illustrated, information describing what has been played on the keyboard is passed to the internal sound generator over two different routes, (1) and (2). As a result, you hear overlapping or intermittent sounds. To prevent this from happening, route (1) must be severed, by setting the unit to what is known as "Local Off."

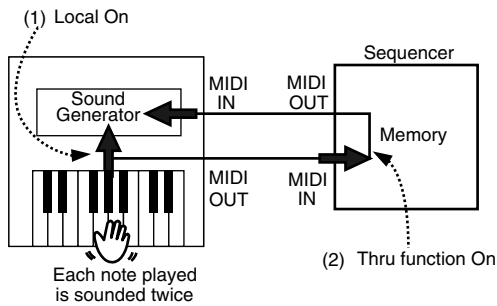

Local Control ON: The keyboard and the internal sound generator are in a linked state.

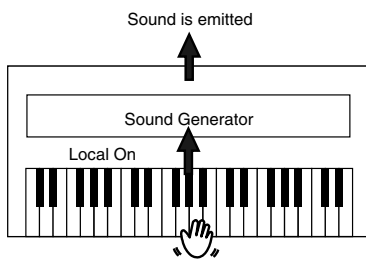

Local Control OFF: The keyboard and the internal sound generator are in an unlinked state. No sound will be produced by the keyboard when it is played.

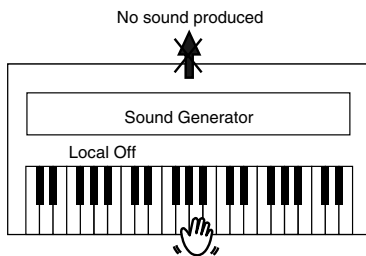

\* When connecting a unit in the Roland MT series, you don't need to switch off Local Control. MT units transmit Local Off messages when their power is switched on. If you first switch on the FP-5, then the MT-series device, Local Control is automatically switched off on the FP-5.

**1. Switch to Function mode, and press the [Song] button.**



**2. Press the [-] or [+] button to switch Local Control on and off.**

## Setting the MIDI Out Mode

By setting the MIDI Out Mode, you can select to have a more suitable (to the external MIDI device) selection of MIDI data be output from the MIDI Out connector when you make tone changes on the FP-5.

Four settings for the MIDI Out Mode are available.

"MIDI Out Mode 1" is the power-up default setting.

Indication	Descriptions
1	<b>MIDI Out Mode 1</b> This setting is suitable for the connection of sequencers. The MIDI information (for example: Bank select, Program Change, Settings of Effects, and so on) is output from the MIDI Out connector when you make a tone change on the FP-5.
2	<b>MIDI Out Mode 2</b> This setting is suited for connecting to a sound module. The MIDI information (for example: Bank select) is not output from the MIDI Out connector when you make a tone change on the FP-5.
3	<b>MIDI Out Mode 3</b> You can transmit performance data recorded with the FP-5. Additionally, the MIDI messages that are output have the same content as those in MIDI Out Mode 1.
4	<b>MIDI Out Mode 4</b> The MIDI messages that are output have the same content as those in MIDI Out Mode 3. However, these are not transmit to FP-5's sound module. Additionally, the local control is switched to off (p. 50).

**1. Switch to Function mode, and press the [Play/ Stop] button.**

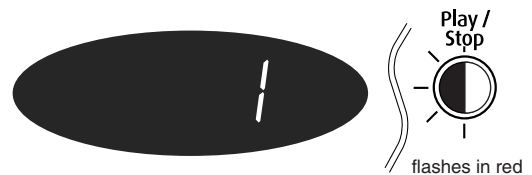

**2. Press the [-] or [+] button to select the MIDI Out Mode.**

## Chapter 4 Other Functions

### Transferring the Program Change message

When a setup is switched, a Program Change message is transmitted.

1. Switch to Function mode, and press the [Setup] button.
2. Hold down the [Setup] button, and press the [-] or [+] button to select bank select MSB, LSB or Program change (PC).



3. Press [-] or [+] button to select the number.
4. Exit Function mode to register the setup to the settings (p. 37).

### Using the Pedal to Switch Setup (Pedal shift)

You can use the pedal which is connected to the sostenuto(FC1) jack or the soft(FC2) jack as a dedicated switch for selecting Setup in order.

1. Switch to Function mode, and press the [Setup] button.
2. Hold down the [Setup] button, and press the [-] or [+] button so "Sft" is displayed.



3. Press the [-] or [+] button to select pedal setting.

Indication	description
OFF	You can use a function assigned to the sostenuto(FC1) pedal and the soft(FC2) pedal.
FC1	The sostenuto(FC1) pedal is dedicated to switching Setup. The function assigned to the sostenuto(FC1) pedal cannot to be used.
FC2	The soft(FC2) pedal is dedicated to switching Setup. The function assigned to the soft(FC2) pedal cannot to be used.

### Transferring the FP-5's Settings to an External MIDI Device (Bulk Dump)

You can transfer the contents of FP-5's Setup settings to an external MIDI device. This operation is called "bulk dump."

1. Use a MIDI cable (optional) to connect the FP-5's MIDI OUT connector to the MIDI IN connector on an external sequencer, or use a USB cable to connect the computer.
2. Switch to Function mode, and press the [Setup] button.
3. Hold down the [Setup] button, and press the [-] or [+] button to select bank select.  
"dnP" is displayed, and the [Play/Stop] button's indicator begin flashes.



4. Put the external sequencer in record mode.
5. Press [Play/Stop] to transmit the settings.  
After the transmitting is finished, "dnP" is appeared in display.
6. Stop the external sequencer.

## Making the Settings for the USB Driver

If you intend to connect to a computer using the USB connector, you need to make the following setting before you make the connection.

1. Switch to Function mode, and press the [Tone Wheel] button.

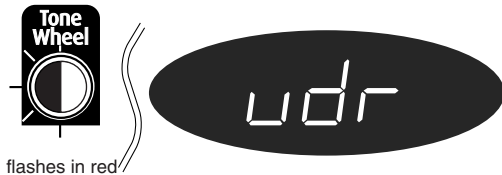

2. Press the [-] or [+] buttons to select the driver.

Indication	Description
<b>vdr</b> (Vender)	Select this when using the supplied driver with a USB connection.
<b>GEN</b> (Generic)	Select this when using a generic USB driver included with the OS with a USB connection.

## Restoring the settings to the factory condition (Factory Reset)

The settings stored in the FP-5 can be returned to their factory settings.

\* Executing "Factory Reset" results in deletion of the Settings. If you want to keep any data you have stored, use the "Bulk Dump" operation to save the data to an external sequencer (p. 52).

1. Turn the volume to the minimum, and press the [Power] switch to turn off the power.
2. Hold down the [Pedal control] button, and press the [Power] switch to turn on the power. Continue pressing the button until "Fct" appears in the display.



After "Fct" is displayed, the screen and buttons go back to normal.

## Disabling Everything Except Piano Play (Panel Lock)

The "Panel Lock" function locks the FP-5 in a state where only piano performance can be used, and all buttons will be disabled. This prevents the settings from being inadvertently modified even if children press the buttons accidentally.

1. Turn the volume to the minimum, and press the [Power] switch to turn off the power.
2. Hold down the [Piano] button and press the [Power] switch to turn on the power.

Then, continue to hold down these two buttons by following display will appear.

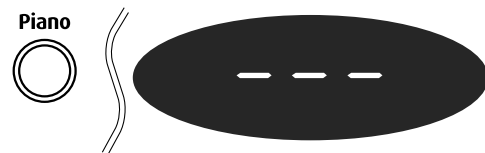

3. Adjust the volume. When you play the keyboard, the grand piano sound will be heard. It cannot be changed to another tone.
4. To defeat the Panel Lock function, turn the volume down to the minimum, and turn on the power once again.

# Troubleshooting

Case	Cause/What to do
No Power	Is the power cord properly connected? (p. 8)
No Sound	Is the volume level of the FP-5 (p. 10) or connected device turned all the way down?
	Are headphones plugged in? Has a plug remained connected to the Phones jack? (p. 10)
	Is the Speaker switch to "ON"? (p. 7)
	Is Local Off selected? When Local Control is set to OFF, no sound is produced by playing the keyboard. Set Local Control to "ON"(p. 50).
	Is the MIDI Out mode set to "4"? (p. 51)
No Sound (With a MIDI Device Connected)	Is the power to all devices turned on? (p. 48)
	Is the MIDI cable connected and plugged in correctly? (p. 49)
	Does the MIDI channel match the connected instrument? (p. 50)
No Sound From the Left Side	Is the [Chord Progression] button's indicator off? (p. 35) No sound from the left side is produced if the [Chord Progression] button's indicator is off while the Session Partner is playing.
The Volume of the Keyboard is Too Low	Is the volume balance turned all the way down? (p. 21)
Two Sounds are Produced When the Keyboard is Played	Is the FP-5 in Dual Play? (p. 18)
	When the FP-5 is connected to an external sequencer, set it to the Local OFF mode (p. 50). Alternatively, set SOFT THRU on the sequencer to "OFF."
Not All Sounds Are Played	The FP-5 has a maximum polyphony of 64 voices. When playing together with a song or Rhythm along with heavy use of the damper pedal, the performance data may exceed the number of available voices, and as a result, some notes or sounds played on the keyboard may not sound.
The accompaniment sounds when the keys are played	Is the [Chord Progression] button's indicator on? (p. 35) When the [Chord Progression] button's indicator is on, the Session Partner begins if you finger a keyboard.

Case	Cause/What to do
The Keyboard or Song Register or Pitch is Off	Have you set Transpose? (p. 28)
	Are the settings for the Temperament (p. 45) correct?
	Is the setting for Master Tuning correct? (p. 45)
	Is the [Pedal Control] button's indicator on? When the [Pedal Control] button is illuminated, pitch bend is applied with the damper pedal. Press the [Pedal Control] button, getting its indicator goes out.
Rhythm Does Not Sound	Is the volume balance for the Rhythm turned all the way down? (p. 33)
Song Doesn't Play Back	Does "dEL" appear in the display? (p. 13) The internal songs cannot be played back while recorded performance data remains in the FP-5's memory. Try playing back the song after deleting the performance data.
Only the Sound of a Particular Instrument in a Song Does Not Play	Is Track Mute on? (p. 13) If the button's light is out when you hold down the [Play/Stop] button, the music on that track is not heard. Press the track button so the light is illuminated.
Cannot Record	Have you selected which of the Track Buttons to be recorded? (p. 40)
Tempo of Recorded Song or Metronome is Off	When you select for recording an internal song that features tempo changes, the tempos of Performances recorded on other tracks are altered along with these changes. In addition, the Metronome tempo is also changed the same way.
Recorded Performance is Erased	Performances that have been recorded are erased when the power for the FP-5 is turned off. Once erased, Performances cannot be recovered.
The [Split] button's light won't go out	Is the [Chord Progression] button's indicator off? (p. 35)

Case	Cause/What to do
Pedal Has No Effect, or Effect "Sticks"	Is the pedal connected correctly? Connect the pedal securely to the Pedal jack (p. 9).
	Are you using a pedal made by another manufacturer? Use the pedal included with the FP-5 or an optional DP Series or similar pedal.
	Unplugging a pedal cord from the unit while the power is on may cause the pedal's effect to be applied nonstop. Be sure to switch off the power to the unit before attempting to disconnect or connect a pedal cord (p. 9).
	Is the [Pedal Control] button's indicator on? When the [Pedal Control] button's indicator is on, a damper pedal cannot be used for its original function (p. 27).
	Once it's been assigned as a setup switch, a soft pedal or sostenuto pedal cannot be used for its original function (p. 52).
Effects Not Applied	When the part to which the effects are applied is assigned to the Lower Tone, the effects are then not applied to the Upper Tone (p. 44).
Reverb Remains Even After Reverb is Lifted	As the FP-5 piano sounds faithfully reproduce the depth and reverberation of actual acoustic pianos, reverberation may still be audible even after the reverb effect is removed from sounds.
Sound Suddenly Changes at Key in Upper Octaves	With the acoustic piano settings, sounds in the upper 1 1/2-octave range are extended to the end regardless of the damper pedal actions. The tone is also different in this range. Roland's pianos faithfully reproduce the sonic qualities of acoustic pianos. Furthermore, you can use the instrument's Key Transpose setting to change that range over which the damper pedal has no effect.

Case	Cause/What to do
High-Pitched Whine is Produced	When listening through headphones: Certain piano tones that feature vibrant, sparking sounds contain a large high-frequency component, which may make it appear that a metallic reverberation has been applied. This faithfully reproduces the characteristics of acoustic pianos, and does not indicate any malfunction. Since this reverberation becomes particularly audible when supplemented by heavy reverb, you may be able to diminish the problem by reducing the amount of reverb applied to the sound. When listening through speakers: Here, a different cause (such as resonance produced by the FP-5) would be suspect. Consult your Roland dealer or nearest Roland Service Center.
Low End Sounds Are Strange/Have a Rattling Sound	When listening through speakers: Playing at loud volumes may cause instruments near the FP-5 to resonate. Resonation can also occur with fluorescent light tubes, glass doors, and other objects. In particular, this problem occurs more easily when the bass component is increased, and when the sound is played at higher volumes. Use the following measures to suppress such resonance. - Place speakers so they are 10–15 cm from walls and other surfaces. - Reduce the volume. - Move the speakers away from any resonating objects. - Check to make sure that the screws holding the music stand in place are not loose. When listening through headphones: The cause lies somewhere else. Consult your Roland dealer or nearest Roland Service Center.
The volume level of the instrument connected to Line In Jack is too low	Could you be using a connection cable that contains a resistor? Use a connection cable that does not contain a resistor.

# Error Messages/Other Messages

Display	Meaning
USr	User. Stores recorded Performances (p. 12, p. 38).
Usr.	The "." in the display indicates that there is Performance material already recorded (p. 12, p. 38).
P.	Piano song number (p. 12).
r.	Rhythm number (p. 33).
dEL	This appears when you attempt to delete a recorded song (p. 41). Additionally, this appears after recording a song when you try to select another song (p. 13).
SUP	This appears when you store setting to set up, or select stored settings (p. 37).
dnP	Bulk Dump. This appears when you transfer the FP-5's settings to an external sequencer (p. 52).
Fct	Factory Reset. This appears when you restore the settings to the factory condition (p. 53).
E.32	The amount of performance information is too large, and further recording is not possible.
E.40	Too much MIDI data was sent from the external MIDI instrument at one time, and the unit could not process the data. Reduce the amount of MIDI data being sent to the FP-5.
E.41	A problem such as a loose MIDI cable or computer cable occurred. Make sure the MIDI cables and computer cables are correctly hooked up.
E.51	A system error has occurred. Try performing the procedure over again. Should this message continue to appear even after repeated attempts, please consult the nearest Roland Service Center.

\* Error messages are indicated by an "E." before the number

When the Error message appears, the [-] and [+] button indicators flashes in red.

Press the [-] or [+] button, and you can cancel the error message.



# Tone List

→ "Performing with a Variety of Sounds" (p. 14)

## Piano

---

- 1 Grand Piano 1
- 2 Piano+Strings
- 3 Grand Piano 2
- 4 Piano+Pad
- 5 Rock Piano
- 6 Mellow Piano
- 7 Honky-tonk
- 8 Harpsichord

## E.Piano

---

- 1 Pop E.Piano
- 2 Stage E.Piano
- 3 60's E.Piano
- 4 70's E.Piano
- 5 E.Grand
- 6 FM E.Piano 1
- 7 FM E.Piano 2
- 8 Clav.
- 9 Vibraphone
- 10 Morning Lite

## Organ

---

- 1 Jazz Organ
- 2 Mellow Bars
- 3 Rock Organ
- 4 Purple Spin
- 5 Lower Organ
- 6 Ballad Organ
- 7 60's Organ
- 8 Church Organ 1
- 9 Church Organ 2
- 10 Nason Flute

## Guitar/Bass

---

- 1 Steel Gtr
- 2 Nylon Gtr
- 3 Jazz Guitar
- 4 Blusey OD
- 5 Acoustic Bass
- 6 A.Bass+Ride
- 7 Finger Bass
- 8 Slap Bass
- 9 Synth Bass
- 10 Vox Bass

## Strings/Pad

---

- 1 Rich Strings
- 2 Velo Strings
- 3 Fat Strings
- 4 Synth Strings
- 5 Synth Pad 1
- 6 Synth Pad 2
- 7 Glasswaves
- 8 Orchestra
- 9 Voyager Brass

## Voice/GM2

---

- 1 Jazz Scat
- 2 Choir
- 3 Beauty Vox
- 4 Voice Oohs
- 5 Holy Voice
- 6 Tenor Sax
- 7 Flute

## Rhythm

→ "Rhythm Set List" (p. 59)

- 8 Pop Drum Set
- 9 Jazz Drum Set
- 10 Voice Drum Set
- 11 House Drum Set
- 12 GM2 STANDARD
- 13 GM2 ROOM
- 14 GM2 POWER
- 15 GM2 ELECTRIC
- 16 GM2 ANALOG
- 17 GM2 JAZZ
- 18 GM2 BRUSH
- 19 GM2 ORCHESTRA
- 20 GM2 SFX

## GM2

- 21 Piano 1
- 22 Piano 1 (wide)
- 23 Piano 1 (dark)
- 24 Piano 2
- 25 Piano 2 (wide)
- 26 Piano 3
- 27 Piano 3 (wide)
- 28 Honky-tonk 1
- 29 Honky-tonk 2
- 30 E.Piano 1
- 31 St.Soft EP
- 32 FM+SA EP
- 33 60's E.Piano
- 34 E.Piano 2
- 35 Detuned EP 2
- 36 St.FM EP
- 37 EP Legend
- 38 EP Phase
- 39 Harpsichord
- 40 Coupled Hps.
- 41 Harpsi (wide)
- 42 Harpsi (key Off)
- 43 Clav.
- 44 Pulse Clav
- 45 Celesta
- 46 Glockenspiel
- 47 Music Box
- 48 Vibraphone
- 49 Vibraphone (wide)
- 50 Marimba
- 51 Marimba (wide)
- 52 Xylophone
- 53 Tubular-bell
- 54 Church Bell
- 55 Carillon
- 56 Santur
- 57 Organ 1
- 58 Trem. Organ
- 59 60's Organ
- 60 70's E.Organ
- 61 Organ 2
- 62 Chorus Or.2
- 63 Perc. Organ
- 64 Organ 3
- 65 Church Org.1
- 66 Church Org.2
- 67 Church Org.3
- 68 Reed Organ
- 69 Puff Organ
- 70 Accordion Fr
- 71 Accordion It



# Rhythm Set List

	Pop Drum Set	Jazz Drum Set	Vox Drum Set	House Drum Set
21	R&B Snare	R&B Snare	R&B Snare	R&B Snare
22	Rock Snare 2	Pop Snare 3	Rock Snare 2	Rock Snare 2
23	Rock Snare 2	Pop Snare 3	Rock Snare 2	Rock Snare 2
24	Pop Snare 3	Pop Snare 3	Pop Snare 3	Pop Snare 3
25	Pop Snare Ghost	Pop Snare Ghost	Pop Snare Ghost	Pop Snare Ghost
26	Pop Snare 3	Pop Snare 3	Pop Snare 3	Pop Snare 3
27	Finger Snap	Finger Snap	Finger Snap	Finger Snap
28	707 Claps	707 Claps	707 Claps	707 Claps
29	Hand Clap	Hand Clap	Hand Clap	Hand Clap
30	Hand Clap2	Hand Clap2	Hand Clap2	Hand Clap2
31	Hand Clap	Hand Clap	Hand Clap	Hand Clap
32	Pop Pedal HH [EXC1]	Pop Pedal HH [EXC1]	Pop Pedal HH	Pop Pedal HH [EXC1]
33	Hand Clap	Hand Clap	Hand Clap	Hand Clap
34	Pop Snare Ghost	Pop Snare Ghost	Vox Dut	Pop Snare Ghost
35	Pop Kick	Pop Kick	Vox Dom	808 Kick 2
C2	Pop Kick	Pop Kick	Vox Tuush	909 BD 2
37	Rock Side Stick	Jazz Brsh Swirl 1	Vox Hehho	808 Rimshot
38	Pop Snare 1	Jazz Snare 2	Vox Doyear	DRS Dregg
39	Pop Snare Ghost	Jazz Brsh Swirl 2	Vox Thu!	Hand Clap
40	Pop Snare 2	Jazz Snare 2	Vox That	707 Claps
41	Pop Low Tom Flm	Jazz Low Tom Flm	Vox Aahhh	Room Tom 5
42	Pop CHH 1 [EXC1]	Pop CHH 1 [EXC1]	Vox Tu	909 CHH [EXC1]
43	Pop Low Tom	Jazz Low Tom	Vox Dooh	Room Tom 5
44	Pop CHH 2 [EXC1]	Pop CHH 2 [EXC1]	Vox Ptu	808 CHH 2 [EXC1]
45	Pop Mid Tom Flm	Jazz Mid Tom Flm	Vox Down	Room Tom 6
46	Pop OHH [EXC1]	Pop OHH [EXC1]	Vox Pa	909 OHH [EXC1]
47	Pop Mid Tom	Jazz Mid Tom	Vox Bom	Room Tom 6
C3	Pop High Tom Flm	Jazz High Tom Flm	Vox Toear	Room Tom 2
49	Pop Crash Cymbal 1	Jazz Crash Cymbal 1	Vox Aahhu	Pop Crash Cymbal 1
50	Pop High Tom	Jazz High Tom	Vox Toya	Room Tom 2
51	Pop Ride Cymbal 1	NewJzRide1	Vox Thu	Pop Ride Cymbal 1
52	Pop Crash Cymbal 2	Jazz Crash Cymbal 2	Vox Cheey	ReverseCymb1
53	Pop Ride Bell	NewJzRide1	Vox Cymm	Pop Ride Bell
54	Tambourine	Tambourine	Vox Tub	Tambourine
55	Splash Cymbal	Splash Cymbal	Vox Pruru	Splash Cymbal
56	Cha Cha Cowbell	Cha Cha Cowbell	Vox Tut	808 Cowbell
57	Pop Crash Cymbal 3	Jazz Crash Cymbal 3	Vox Tyun	Pop Crash Cymbal 3
58	Vibraslap	Vibraslap	Vox Tdum	Vibraslap
59	Pop Ride Cymbal 2	Pop Ride Cymbal 2	Vox Afahhhh	Pop Ride Cymbal 2
C4	High Bongo 2	High Bongo 2	High Bongo 2	808 High Bongo
61	Low Bongo 2	Low Bongo 2	Low Bongo 2	808 Low Bongo
62	Mute Conga	Mute Conga	Mute Conga	808 High Conga
63	High Conga 2	High Conga 2	High Conga 2	808 Mid Conga
64	Low Conga 2	Low Conga 2	Low Conga 2	808 Low Conga
65	High Timbale 2	High Timbale 2	High Timbale 2	High Timbale 2
66	Low Timbale 2	Low Timbale 2	Low Timbale 2	Low Timbale 2
67	High Agogo	High Agogo	High Agogo	High Agogo
68	Low Agogo	Low Agogo	Low Agogo	Low Agogo
69	Shaker 3	Shaker 3	Shaker 3	Shaker 3
70	Shaker 4	Shaker 4	Shaker 4	Shaker 4
71	ShortWhistle [EXC2]	ShortWhistle [EXC2]	ShortWhistle [EXC2]	ShortWhistle [EXC2]
C5	Long Whistle [EXC2]	Long Whistle [EXC2]	Long Whistle [EXC2]	Long Whistle [EXC2]
73	Short Guiro [EXC3]	Short Guiro [EXC3]	Short Guiro [EXC3]	Short Guiro [EXC3]
74	Long Guiro [EXC3]	Long Guiro [EXC3]	Long Guiro [EXC3]	Long Guiro [EXC3]
75	Claves	Claves	Claves	808 Claves
76	High Wood Block	High Wood Block	High Wood Block	High Wood Block
77	Low Wood Block	Low Wood Block	Low Wood Block	Low Wood Block
78	Mute Cuica [EXC4]	Mute Cuica [EXC4]	Mute Cuica [EXC4]	Mute Cuica [EXC4]
79	Open Cuica [EXC4]	Open Cuica [EXC4]	Open Cuica [EXC5]	Open Cuica [EXC4]
80	Mute Triangl [EXC5]	Mute Triangl [EXC5]	Mute Triangl [EXC5]	Mute Triangl [EXC5]
81	Open Triangl [EXC5]	Open Triangl [EXC5]	Open Triangl [EXC5]	Open Triangl [EXC5]
82	808 Maracas	808 Maracas	808 Maracas	808 Maracas
83	Jingle Bell	Jingle Bell	Jingle Bell	Jingle Bell
C6	Bar Chimes	Bar Chimes	Bar Chimes	Bar Chimes
85	Castanets	Castanets	Castanets	Castanets
86	Mute Surdo [EXC6]	Mute Surdo [EXC6]	Mute Surdo [EXC6]	Mute Surdo [EXC6]
87	Open Surdo [EXC6]	Open Surdo [EXC6]	Open Surdo [EXC6]	Open Surdo [EXC6]
88	-----	-----	-----	-----
89	Flamenco Hi-Timbale	Flamenco Hi-Timbale	Flamenco Hi-Timbale	Flamenco Hi-Timbale
90	Flamenco Lo-Timbale	Flamenco Lo-Timbale	Flamenco Lo-Timbale	Flamenco Lo-Timbale
91	Flamenco Tmbl Flam	Flamenco Tmbl Flam	Flamenco Tmbl Flam	Flamenco Tmbl Flam
92	Shaker 1	Shaker 1	Shaker 1	Shaker 1
93	Shaker 2	Shaker 2	Shaker 2	Shaker 2
94	Low Bongo Mute	Low Bongo Mute	Low Bongo Mute	Low Bongo Mute
95	Cabasa Up	Cabasa Up	Cabasa Up	Cabasa Up
C7	Cabasa Down	Cabasa Down	Cabasa Down	Cabasa Down
97	-----	-----	-----	-----
98	-----	-----	-----	-----
99	-----	-----	-----	-----
100	Flamenco Hand Clap	Flamenco Hand Clap	Flamenco Hand Clap	Flamenco Hand Clap
101	Flamenco Hand Clap	Flamenco Hand Clap	Flamenco Hand Clap	Flamenco Hand Clap
102	Bongo Cowbell	Bongo Cowbell	Bongo Cowbell	Bongo Cowbell
103	-----	-----	-----	-----
104	Bongo Cowbell	Bongo Cowbell	Bongo Cowbell	Bongo Cowbell
105	Wah Gtr Noise 1	Wah Gtr Noise 1	Wah Gtr Noise 1	Wah Gtr Noise 1
106	Wah Gtr Noise 2	Wah Gtr Noise 2	Wah Gtr Noise 2	Wah Gtr Noise 2
107	Wah Gtr Noise 3	Wah Gtr Noise 3	Wah Gtr Noise 3	Wah Gtr Noise 3
C8	Wah Gtr Noise 4	Wah Gtr Noise 4	Wah Gtr Noise 4	Wah Gtr Noise 4

\*-----: No sound.

\*[EXC]: will not sound simultaneously with other percussion instruments of the same number.

# Tone List

	GM2 Standard Set	GM2 Room Set	GM2 Power Set	GM2 Electric Set	GM2 Analog Set
21	----	----	----	----	----
22	----	----	----	----	----
23	----	----	----	----	----
24	----	----	----	----	----
25	----	----	----	----	----
26	----	----	----	----	----
27	High-Q	High-Q	High-Q	High-Q	High-Q
28	Slap	Slap	Slap	Slap	Slap
29	ScratchPush [EXC7]	ScratchPush [EXC7]	ScratchPush [EXC7]	ScratchPush [EXC7]	ScratchPush [EXC7]
30	ScratchPull [EXC7]	ScratchPull [EXC7]	ScratchPull [EXC7]	ScratchPull [EXC7]	ScratchPull [EXC7]
31	Sticks	Sticks	Sticks	Sticks	Sticks
32	SquareClick	SquareClick	SquareClick	SquareClick	SquareClick
33	Mtrnm.Click	Mtrnm.Click	Mtrnm.Click	Mtrnm.Click	Mtrnm.Click
34	Mtrnm. Bell	Mtrnm. Bell	Mtrnm. Bell	Mtrnm. Bell	Mtrnm. Bell
35	Jazz Kick 1	Mix Kick	Standard KK1	Power Kick1	808 Kick 2
C2 36	Mix Kick	Standard KK1	Power Kick1	Elec Kick 1	808 Kick 1
37	Rock Side Stick	Rock Side Stick	Rock Side Stick	Rock Side Stick	808 Rimshot
38	Standard SN1	Room SN1	Dance Snare1	Elec. Snare	808 Snare 1
39	Hand Clap	Hand Clap	Hand Clap	Hand Clap	Hand Clap
40	Standard SN2	Room SN2	Elec Snare 4	Elec Snare 2	808 Tom 6
41	Real Tom 6	Room Tom 5	Room Tom 5	Synth Drum 2	808 Tom 2
42	Close HiHat2 [EXC1]	Close HiHat2 [EXC1]	Close HiHat2 [EXC1]	Close HiHat2 [EXC1]	808 CHH [EXC1]
43	Real Tom 6	Room Tom 6	Room Tom 6	Synth Drum 2	808 Tom 2
44	Pedal HiHat2 [EXC1]	Pedal HiHat2 [EXC1]	Pedal HiHat2 [EXC1]	Pedal HiHat2 [EXC1]	808 CHH 1 [EXC1]
45	Real Tom 4	Room Tom 2	Room Tom 2	Synth Drum 2	808 Tom 2
46	Open HiHat2 [EXC1]	Open HiHat2 [EXC1]	Open HiHat2 [EXC1]	Open HiHat2 [EXC1]	808 OHH 2 [EXC1]
47	Real Tom 4	Room Tom 2	Room Tom 2	Synth Drum 2	808 Tom 2
C3 48	Real Tom 1	Rock Tom 1	Rock Tom 1	Synth Drum 2	808 Tom 2
49	Crash Cym.1	Crash Cym.1	Crash Cym.1	Crash Cym.1	808 Crash
50	Real Tom 1	Rock Tom 1	Rock Tom 1	Synth Drum 2	808 Tom 2
51	Ride Cymbal	Ride Cymbal	Ride Cymbal	Ride Cymbal	Ride Cymbal
52	ChinaCymbal	ChinaCymbal	ChinaCymbal	ReverseCymbal	ChinaCymbal
53	Ride Bell	Ride Bell	Ride Bell	Ride Bell	Ride Bell
54	Tambourine	Tambourine	Tambourine	Tambourine	Tambourine
55	Splash Cym.	Splash Cym.	Splash Cym.	Splash Cym.	Splash Cym.
56	Cowbell	Cowbell	Cowbell	Cowbell	808 Cowbell
57	Crash Cym.2	Crash Cym.2	Crash Cym.2	Crash Cym.2	Crash Cym.2
58	Vibraslap	Vibraslap	Vibraslap	Vibraslap	Vibraslap
59	Ride Cymbal4	Ride Cymbal4	Ride Cymbal4	Ride Cymbal4	Ride Cymbal4
C4 60	Bongo High	Bongo High	Bongo High	Bongo High	Bongo High
61	Bongo Lo	Bongo Lo	Bongo Lo	Bongo Lo	Bongo Lo
62	Mute H.Conga	Mute H.Conga	Mute H.Conga	Mute H.Conga	808 High Conga
63	High Conga 2	High Conga 2	High Conga 2	High Conga 2	808 Mid Conga
64	Low Conga 2	Low Conga 2	Low Conga 2	Low Conga 2	808 Low Conga
65	High Timbale 2	High Timbale 2	High Timbale 2	High Timbale 2	High Timbale 2
66	Low Timbale 2	Low Timbale 2	Low Timbale 2	Low Timbale 2	Low Timbale 2
67	High Agogo	High Agogo	High Agogo	High Agogo	High Agogo
68	Low Agogo	Low Agogo	Low Agogo	Low Agogo	Low Agogo
69	Cabasa	Cabasa	Cabasa	Cabasa	Cabasa
70	Maracas	Maracas	Maracas	Maracas	808 maracas 2
71	ShortWhistle [EXC2]	ShortWhistle [EXC2]	ShortWhistle [EXC2]	ShortWhistle [EXC2]	ShortWhistle [EXC2]
C5 72	Long Whistle [EXC2]	Long Whistle [EXC2]	Long Whistle [EXC2]	Long Whistle [EXC2]	Long Whistle [EXC2]
73	Short Guiro [EXC3]	Short Guiro [EXC3]	Short Guiro [EXC3]	Short Guiro [EXC3]	Short Guiro [EXC3]
74	Long Guiro [EXC3]	Long Guiro [EXC3]	Long Guiro [EXC3]	Long Guiro [EXC3]	Long Guiro [EXC3]
75	Claves	Claves	Claves	Claves	Claves
76	High Wood Block	High Wood Block	High Wood Block	High Wood Block	High Wood Block
77	Low Wood Block	Low Wood Block	Low Wood Block	Low Wood Block	Low Wood Block
78	Mute Cuica [EXC4]	Mute Cuica [EXC4]	Mute Cuica [EXC4]	Mute Cuica [EXC4]	Mute Cuica [EXC4]
79	Open Cuica [EXC4]	Open Cuica [EXC4]	Open Cuica [EXC4]	Open Cuica [EXC4]	Open Cuica [EXC4]
80	Mute Triangl [EXC5]	Mute Triangl [EXC5]	Mute Triangl [EXC5]	Mute Triangl [EXC5]	Mute Triangl [EXC5]
81	Open Triangl [EXC5]	Open Triangl [EXC5]	Open Triangl [EXC5]	Open Triangl [EXC5]	Open Triangl [EXC5]
82	Shaker 3	Shaker 3	Shaker 3	Shaker 3	Shaker 3
83	Jingle Bell	Jingle Bell	Jingle Bell	Jingle Bell	Jingle Bell
C6 84	Bar Chimes	Bar Chimes	Bar Chimes	Bar Chimes	Bar Chimes
85	Castanets	Castanets	Castanets	Castanets	Castanets
86	Mute Surdo [EXC6]	Mute Surdo [EXC6]	Mute Surdo [EXC6]	Mute Surdo [EXC6]	Mute Surdo [EXC6]
87	Open Surdo [EXC6]	Open Surdo [EXC6]	Open Surdo [EXC6]	Open Surdo [EXC6]	Open Surdo [EXC6]
88	----	----	----	----	----
89	----	----	----	----	----
90	----	----	----	----	----
91	----	----	----	----	----
92	----	----	----	----	----
93	----	----	----	----	----
94	----	----	----	----	----
95	Cabasa Up	Cabasa Up	Cabasa Up	Cabasa Up	Cabasa Up
C7 96	Cabasa Down	Cabasa Down	Cabasa Down	Cabasa Down	Cabasa Down
97	----	----	----	----	----
98	----	----	----	----	----
99	----	----	----	----	----
100	----	----	----	----	----
101	----	----	----	----	----
102	----	----	----	----	----
103	----	----	----	----	----
104	----	----	----	----	----
105	Wah Gtr Noise 1	Wah Gtr Noise 1	Wah Gtr Noise 1	Wah Gtr Noise 1	Wah Gtr Noise 1
106	Wah Gtr Noise 2	Wah Gtr Noise 2	Wah Gtr Noise 2	Wah Gtr Noise 2	Wah Gtr Noise 2
107	Wah Gtr Noise 3	Wah Gtr Noise 3	Wah Gtr Noise 3	Wah Gtr Noise 3	Wah Gtr Noise 3
C8 108	Wah Gtr Noise 4	Wah Gtr Noise 4	Wah Gtr Noise 4	Wah Gtr Noise 4	Wah Gtr Noise 4

\*----: No sound.

\*[EXC]: will not sound simultaneously with other percussion instruments of the same number.

	GM2 Jazz Set	GM2 Brush Set	GM2 Orchestra Set	GM2 SFX Set
21	----	----	----	----
22	----	----	----	----
23	----	----	----	----
24	----	----	----	----
25	----	----	----	----
26	----	----	----	----
27	High-Q	High-Q	Close HiHat2 [EXC1]	----
28	Slap	Slap	Pedal HiHat2 [EXC1]	----
29	ScratchPush [EXC7]	ScratchPush [EXC7]	Open HiHat2 [EXC1]	----
30	ScratchPull [EXC7]	ScratchPull [EXC7]	Ride Cymbal4	----
31	Sticks	Sticks	Sticks	----
32	SquareClick	SquareClick	SquareClick	----
33	Mtrnm.Click	Mtrnm.Click	Mtrnm.Click	----
34	Mtrnm. Bell	Mtrnm. Bell	Mtrnm. Bell	----
35	Mix Kick	Mix Kick	Concert BD	----
C2 36	Jazz Kick 1	Jazz Kick 1	Mix Kick	----
37	Rock Side Stick	Rock Side Stick	Rock Side Stick	----
38	Standard SN3	Brush Swirl	Concert Snr	----
39	Hand Clap	Brush Slap1	Castanets	High-Q
40	Elec Snare 5	Brush Swirl	Concert Snr	Slap
41	Real Tom 6	Brush Tom 2	Timpani F	ScratchPush [EXC7]
42	Close HiHat2 [EXC1]	Pop CHH 1 [EXC1]	Timpani F#	ScratchPull [EXC7]
43	Real Tom 6	Brush Tom 2	Timpani G	Sticks
44	Pedal HiHat2 [EXC1]	Pop CHH 2 [EXC1]	Timpani G#	SquareClick
45	Real Tom 4	Brush Tom 2	Timpani A	Mtrnm.Click
46	Open HiHat2 [EXC1]	Pop OHH [EXC1]	Timpani A#	Mtrnm. Bell
47	Real Tom 4	Brush Tom 2	Timpani B	Gt.FretNoiz
C3 48	Real Tom 1	Crash Cym.2	Timpani C	Gt.CutNoise (Up)
49	Crash Cym.1	Crash Cym.3	Timpani C#	Gt.CutNoise (Down)
50	Real Tom 1	Brush Tom 2	Timpani D	String Slap
51	Ride Cymbal	NewJzRide1	Timpani D#	Fl.KeyClick
52	ChinaCymbal	ChinaCymbal	Timpani E	Laughing
53	Ride Bell	NewJzRide1	Timpani F	Screaming
54	Tambourine	Tambourine	Timpani F	Punch
55	Splash Cym.	Splash Cym.	Splash Cym.	Heart Beat
56	Cowbell	Cowbell	Cowbell	Footsteps 1
57	Crash Cym.2	Crash Cym.2	Con.Cymbal2	Footsteps 2
58	Vibraslap	Vibraslap	Vibraslap	Applause
59	Ride Cymbal4	Ride Cymbal4	Concert Cym.	Creaking
C4 60	Bongo High	Bongo High	Bongo High	Door
61	Bongo Lo	Bongo Lo	Bongo Lo	Scratch
62	Mute H.Conga	Mute H.Conga	Mute H.Conga	Wind Chimes
63	High Conga 2	High Conga 2	High Conga 2	Car-Engine
64	Low Conga 2	Low Conga 2	Low Conga 2	Car-Stop
65	High Timbale 2	High Timbale 2	High Timbale 2	Car-Pass
66	Low Timbale 2	Low Timbale 2	Low Timbale 2	Car-Crash
67	High Agogo	High Agogo	High Agogo	Siren
68	Low Agogo	Low Agogo	Low Agogo	Train
69	Cabasa	Cabasa	Cabasa	Jetplane
70	Maracas	Maracas	Maracas	Helicopter
71	ShortWhistle [EXC2]	ShortWhistle [EXC2]	ShortWhistle [EXC2]	Starship
C5 72	Long Whistle [EXC2]	Long Whistle [EXC2]	Long Whistle [EXC2]	Gun Shot
73	Short Guiro [EXC3]	Short Guiro [EXC3]	Short Guiro [EXC3]	Machine Gun
74	Long Guiro [EXC3]	Long Guiro [EXC3]	Long Guiro [EXC3]	Lasergun
75	Claves	Claves	Claves	Explosion
76	High Wood Block	High Wood Block	High Wood Block	Dog
77	Low Wood Block	Low Wood Block	Low Wood Block	HorseGallop
78	Mute Cuica [EXC4]	Mute Cuica [EXC4]	Mute Cuica [EXC4]	Bird
79	Open Cuica [EXC4]	Open Cuica [EXC4]	Open Cuica [EXC4]	Rain
80	Mute Triangl [EXC5]	Mute Triangl [EXC5]	Mute Triangl [EXC5]	Thunder
81	Open Triangl [EXC5]	Open Triangl [EXC5]	Open Triangl [EXC5]	Wind
82	Shaker 3	Shaker 3	Shaker 3	Seashore
83	Jingle Bell	Jingle Bell	Jingle Bell	Stream
C6 84	Bar Chimes	Bar Chimes	Bar Chimes	Bubble
85	Castanets	Castanets	Castanets	----
86	Mute Surdo [EXC6]	Mute Surdo [EXC6]	Mute Surdo [EXC6]	----
87	Open Surdo [EXC6]	Open Surdo [EXC6]	Open Surdo [EXC6]	----
88	----	----	Applause	----
89	----	----	----	----
90	----	----	----	----
91	----	----	----	----
92	----	----	----	----
93	----	----	----	----
94	----	----	----	----
95	Cabasa Up	Cabasa Up	Cabasa Up	----
C7 96	Cabasa Down	Cabasa Down	Cabasa Down	----
97	----	----	----	----
98	----	----	----	----
99	----	----	----	----
100	----	----	----	----
101	----	----	----	----
102	----	----	----	----
103	----	----	----	----
104	----	----	----	----
105	Wah Gtr Noise 1	Wah Gtr Noise 1	Wah Gtr Noise 1	Wah Gtr Noise 1
106	Wah Gtr Noise 2	Wah Gtr Noise 2	Wah Gtr Noise 2	Wah Gtr Noise 2
107	Wah Gtr Noise 3	Wah Gtr Noise 3	Wah Gtr Noise 3	Wah Gtr Noise 3
C8 108	Wah Gtr Noise 4	Wah Gtr Noise 4	Wah Gtr Noise 4	Wah Gtr Noise 4

\*-----: No sound.

\*[EXC]: will not sound simultaneously with other percussion instruments of the same number.

# Rhythm List

→ "Selecting a Rhythm's Chord Progression" (p. 34)

No.	Genre	Chord Progression Pattern No.	Beat
r.1	Pop	11	4/4
r.2		12	
r.3	Hip Pop	13	4/4
r.4		14	
r.5	Guitar Funk	15	4/4
r.6		16	
r.7	Ballad	17	4/4
r.8		18	
r.9	Fast Jazz	19	4/4
r.10		20	
r.11	Jazz	21	4/4
r.12		22	
r.13	Cutting Guitar	23	4/4
r.14		24	
r.15	Fusion	25	4/4
r.16		26	
r.17	70's Soul	27	4/4
r.18		28	
r.19	Contemporary	29	4/4
r.20		30	
r.21	Medium Pop	31	4/4
r.22		32	
r.23	Street Pop	33	4/4
r.24		34	
r.25	808 Pop	35	4/4
r.26		36	
r.27	Piano Pop	37	4/4
r.28		38	
r.29	Guitar Pop	39	4/4
r.30		40	
r.31	Country Pop	41	4/4
r.32		42	
r.33	Shuffle	43	4/4
r.34		44	
r.35	Smooth Pop	45	4/4
r.36		46	
r.37	8 beat Rock	47	4/4
r.38		48	
r.39	16 beat Rock	49	4/4
r.40		50	

No.	Genre	Chord Progression Pattern No.	Beat
r.41	Gospel	51	6/8
r.42		52	
r.43	Gospel Shout	53	4/4
r.44		54	
r.45	Honky Pop	55	4/4
r.46		56	
r.47	Boogie	57	4/4
r.48		58	
r.49	Double Time Feel	59	4/4
r.50		60	
r.51	Scat Swing	61	4/4
r.52		62	
r.53	Piano Jazz	63	4/4
r.54		64	
r.55	Piano Ballad	65	4/4
r.56		66	
r.57	E.Piano Ballad	67	4/4
r.58		68	
r.59	R&B Ballad	69	4/4
r.60		70	
r.61	808 Ballad	71	4/4
r.62		72	
r.63	New Age Ballad	73	4/4
r.64		74	
r.65	6/8 Ballad	75	6/8
r.66		76	
r.67	Mambo	77	3/4
r.68		78	
r.69	Latin	79	3/4
r.70		80	
r.71	Latin Pop	81	4/4
r.72		82	
r.73	Bossa Nova	83	4/4
r.74		84	
r.75	Beguine	85	4/4
r.76		86	
r.77	Jazz Waltz	87	3/4
r.78		88	
r.79	Piano Waltz	89	3/4
r.80		90	

# Chord Progression Pattern List

\* It is the Chord Progression Pattern List by each measure. These are basic chord progression pattern from No. 1 to No. 10, and these are suitable chord progression for the internal rhythm from No. 11 to No. 90.

No.	Rhythm No.	Chord Progression															
		1	2	3	4	5	6	7	8	9	10	11	12	13	14	15	16
1	—	C	Am	Dm7	G7	C	Am	Dm7	G7								
2	—	Am	G	F	E7	Am	G	F	E7								
3	—	CM7	Am7	Dm7	G7	CM7											
4	—	Dm7	G7	CM7	Am7	Dm7	G7	CM7	A7								
5	—	C	Bm7	Em7	Am	F	G	Csus4	C								
6	—	Dm7	G7	CM7	FM7	Bm7♭5	E7	Am7	A7								
7	—	C7	F7	C7		F7		C7		G7	F7	C7	G7				
8	—	CM7		Cdim		Dm9	G7	CM7	Dm9	CM7		Cdim		Dm9	G7	CM7	
9	—	C		Am7		Dm7		G7sus4									
10	—	C	C/B	Am	Am/G	F	G	C									
11	r. 1	C	Gm7	FM7	B♭7	C	Gm7	F	F/G								
12	r. 2	FM9	F/G	C	Am7	FM9	F/G	B♭7	F/G								
13	r. 3	C	B♭	C	Gm7	C	B♭	C	Gm7								
14	r. 4	C	G7	C	G7	C	G7	C	B♭								
15	r. 5	C	Am7	Dm7	G7	C	Am7	Dm7	G7								
16	r. 6	FM7		CM7	Am7	FM7	Fm7	F/G									
17	r. 7	C		Gm7		C		Gm7									
18	r. 8	F	G7	C	C7	F	G7	Am	F/G								
19	r. 9	F	C7	Am7	C7	F7	B♭7	F/C	C7								
20	r.10	A7		D7		G7		C7									
21	r.11	C6		Dm7	G7	Dm7	G7	C6		Am	Am9	Dm7		G(11)		C6	F/G
22	r.12	C6		Dm7	G7	Dm7	G7	C6		Am	A♭aug	Dm7		G(11)		C6	
23	r.13	Am7	D7	Am7	D7	Am7	D7	Am7	F/G								
24	r.14	C		Am7		C		F/G									
25	r.15	CM9	A♭M7	CM9	A♭M7	CM9	A♭M7	FM9	F/G								
26	r.16	A♭M9		B♭9		A♭M9		B♭9									
27	r.17	CM9		Am9		CM9		Am9		FM9		G6					
28	r.18	FM9	G6	FM9	G6	FM9	G6	FM9	G6	CM9		F/G					
29	r.19	C		FM7		C		F/G									
30	r.20	Dm7	G7	C	Am7	Dm7	G7	C									
31	r.21	C		G		G7		C	C7	F		C	Am7	Dm7	G	C	C7
32	r.22	FM7		G		FM7		G		FM7		G	G7	C			F/G
33	r.23	C	G7	A♭	F	C	G7	A♭	F								
34	r.24	C	G7	E♭	D7	C	G7	E♭	G7								
35	r.25	Am7	D7	Am7	D7	Gm7	C7	Gm7	E7♯9								
36	r.26	Am7	D7sus4	Am7	D7	FM7	E7♯9	Am7	B♭M7								
37	r.27	C		Am		C		Am									
38	r.28	FM7	C	FM7	C	E♭	C	G7	G7								
39	r.29	CM7		Am7		Dm7		G7									
40	r.30	C		F		Dm		G		C		F		G		C	
41	r.31	C	Am	C	Am	C	Am	F	G								
42	r.32	C	G	F	G	C	G	F	G7								
43	r.33	C				F7sus4	F7	G7sus4	G7								
44	r.34	FM7	G7	C		FM7	G7	C									
45	r.35	Cm	CmM7	Cm7	F7	Cm	A♭7	G7									

# Chord Progression Pattern List

No.	Rhyt hm No.	Chord Progression															
		1	2	3	4	5	6	7	8	9	10	11	12	13	14	15	16
46	r.36	Cm	CmM7	Cm7	F7	A♭7	G7	Cm	F7								
47	r.37	C		G		C		G									
48	r.38	F	Am	G7	Dm7	F	Am7	G7									
49	r.39	D	C/D	G/D	B♭/D	D	C/D	G/D	B♭/D								
50	r.40	F♯m7	Bm	D	C♯7	F♯m7	Bm	G	A7								
51	r.41	C		Fm7		C	C♯dim	Dm7	G7								
52	r.42	F	F♯dim	C/G	A7	D7		G7									
53	r.43	C								F	C	F	C	F	C	G7	
54	r.44	C						C7		G		F7		G7		F7	G7
55	r.45	C				F		G									
56	r.46	F		C		F		G									
57	r.47	A7	D7	A7		D7		A7		E7	D7	A7	E7				
58	r.48	C	F	C	C7	F7		C	A7	D7	G7	C	G7				
59	r.49	C			C7	F		C		G7	F7	C	G7				
60	r.50	C	F	C	C7	F7		C	A7	D7	G7	C	G7				
61	r.51	C		F		C		F									
62	r.52	Em7	A7♭9	Dm7	G7	Em7	C♯dim	Dm7	G7								
63	r.53	CM9		F/G		CM9	C9	FM9	F/G								
64	r.54	FM9	F/G	CM9	Am9	Dm7♭5	G7♭9	CM7	F/G								
65	r.55	C	F	C	F	C	F	C	F/G								
66	r.56	F	C	F	C	F	C	Dm7	F/G								
67	r.57	CM7	C♯dim	Dm7	G7	CM7	C♯dim	Dm7	G7								
68	r.58	FM7	G7	CM7		FM7	G7	C	C7								
69	r.59	Cm7	Fm7	Cm7	Fm7	Cm7	Fm7	Cm7	Fm7								
70	r.60	Ddim	G7♭9	Ddim	G7♭9	Ddim	G7♭9	Ddim	G7♭9								
71	r.61	Gm		Am7♭5	D7	Gm		Am7♭5	D7								
72	r.62	E♭6	D7	Gm7	C7	E♭M7	D7	Gm									
73	r.63	C	Dm	Dm7/G	C	F	Em7	E♭	D								
74	r.64	C	Bm7	Em9	A7	Am	D7	Dm9	G7sus4								
75	r.65	C	Am	F	G	C	Am	F	G								
76	r.66	F		Em		Dm		C		Em		Am		F		F/G	G7
77	r.67	C	G7		C		G7		C								
78	r.68	F	C	G7	C7	F	C	G7	C								
79	r.69	Am	E7	Am	E7	Am	E7	Dm7	E7								
80	r.70	Am	E7	Am	E7	Dm7	G7	Bm7	E7								
81	r.71	DM7		CM7		F♯m9	F9	Em9	E♭9								
82	r.72	DM7	C♯m7♭5	Bm7	Am7	GM7	Fm7♭5	Em9	A7								
83	r.73	C		D6		Dm7	G7	C									
84	r.74	F	Fm	C		F	Fm	G7sus4	G7								
85	r.75	C						G		G7		G		G7		C	
86	r.76	C		G7		G7		C				G7		Dm7	G7	C	
87	r.77	Fm7	B♭7	Fm7	B♭7	Fm7	B♭7	D♭7	C7	Fm7	B♭7	Fm7	B♭7	Fm7	B♭7	C7	Fm
88	r.78	B♭m7	E♭7	A♭	D♭	F♯	B	Gm7♭5	C7								
89	r.79	C		CM7		C7		F				CM7	C♯dim	Dm7	Fm	C	
90	r.80	Dm	D♯dim	Em7	A7	Dm7	G7	C									



# Chord Fingering List





























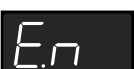















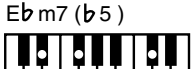

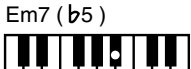

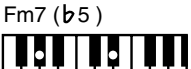

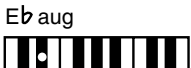











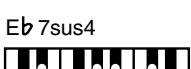

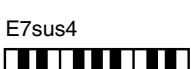

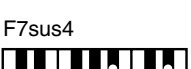







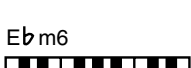

● symbol: indicates the constituent notes of chords.

★ symbol: Chords shown with an "★" can be played by pressing just the key marked with the "★".

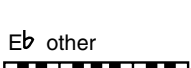
→ "Performing With the Chord Progression Specified in the Left Hand (Chord Progression off)" (p. 35)

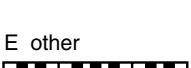
C  [C]	C# / Db  [d]	D  [d]
CM7  [Cn7]	C#M7 / DbM7  [dn7]	DM7  [dn7]
C7  [C7]	C#7 / Db7  [d7]	D7  [d7]
Cm  [Cn]	C#m / Dbm  [dn]	Dm  [dn]
Cm7  [Cn7]	C#7m / Db7m  [dn7]	Dm7  [dn7]
Cdim  [Cdn]	C#dim / Dbdim  [ddn]	Ddim  [ddn]
Cm7 (b5)  [C7-]	C#m7(b5) / Dbm7(b5)  [d7-]	Dm7 (b5)  [d7-]
Caug  [Caug]	C#aug / Dbaug  [daug]	Daug  [daug]
Csus4  [Cv4]	C#sus4 / Db#sus4  [dv4]	Dsus4  [dv4]
C7sus4  [Cv7]	C#7sus4 / Db7sus4  [dv7]	D7sus4  [dv7]
C6  [C6]	C#6 / Db6  [d6]	D6  [d6]
Cm6  [Cn6]	C#m6 / Dbm6  [dn6]	Dm6  [dn6]
C other  [C--]	C# other / Db other  [d--]	D other  [d--]

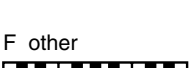
# Chord Fingering List

E <sup>b</sup>	 	E	 	F	 
E <sup>b</sup> M7	 	EM7	 	FM7	 
E <sup>b</sup> 7	 	E7	 	F7	 
E <sup>b</sup> m	 	Em	 	Fm	 
E <sup>b</sup> m7	 	Em7	 	Fm7	 
E <sup>b</sup> dim	 	Edim	 	Fdim	 
E <sup>b</sup> m7(b5)	 	Em7(b5)	 	Fm7(b5)	 
E <sup>b</sup> aug	 	Eaug	 	Faug	 
E <sup>b</sup> sus4	 	Esus4	 	Fsus4	 
E <sup>b</sup> 7sus4	 	E7sus4	 	F7sus4	 
E <sup>b</sup> 6	 	E6	 	F6	 
E <sup>b</sup> m6	 	Em6	 	Fm6	 
E <sup>b</sup> other	 	E other	 	F other	 

F# / Gb



G



Ab



F#M7 / GbM7



GM7



AbM7



F#7 / Gb7



G7



Ab7



F#m / Gbm



Gm



Abm



F#m7 / Gbm7



Gm7



Abm7



F#dim / Gbdim



Gdim



Abdim



F#m7(b5) / Gbm7 (b5)



Gm7 (b5)



Abm7 (b5)



F#aug / Gbaug



Gaug



Abaug



F#sus4 / Gbsus4



Gsus4



Ab sus4



F#7sus4 / Gb7sus4



G7sus4



Ab7sus4



F#6 / Gb6



G6



Ab6



F#m6 / Gbm6



Gm6



Abm6



F# other / Gb other





























G other

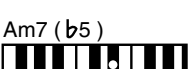
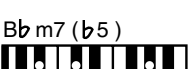
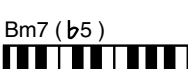

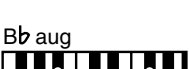
Ab other

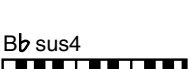
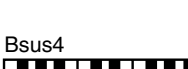
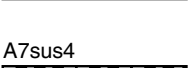

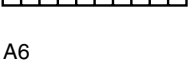
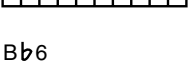
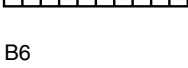
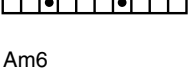
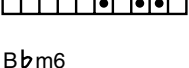
# Chord Fingering List

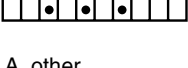
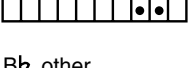
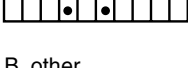
A  A	Bb  b	B  b
AM7  A77	Bb M7  b77	BM7  b77
A7  A 7	Bb 7  b 7	B7  b 7
Am  An	Bb m  bn	Bm  bn
Am7  An7	Bb m7  bn7	Bm7  bn7
Adim  Adn	Bb dim  bdn	Bdim  bdn
Am7 (b5)  A7-	Bb m7 (b5)  b7-	Bm7 (b5)  b7-
Aaug  A2G	Bb aug  b2G	Baug  b2G
Asus4  Au4	Bb sus4  bu4	Bsus4  bu4
A7sus4  Au7	Bb 7sus4  bu7	B7sus4  bu7
A6  A 6	Bb 6  b 6	B6  b 6
Am6  An6	Bb m6  bn6	Bm6  bn6
A other  A--	Bb other  b--	B other  b--

# Internal Song List

→ "Listening to Demo Songs" (p. 11)

Song No.	Song Name	Composer	Copyright
d. 1	Late Night Chopin	F. Chopin/ Arranged by John Maul	© 2002 Roland Corporation
d. 2	L'éveil del l'amour	Masashi & Kazuko Hirashita	© 2000 Roland Corporation
d. 3	Fly Free	J. Maul	© 1998 Roland Corporation
d. 4	Paganini Boogie Variation: Jazz Variation Based on "Caprice No. 24 in A Minor"	N. Paganini/ Arranged by John Maul	© 1998 Roland Corporation
d. 5	Hungarian Rag: Hungarian Dance No. 5 Ragtime Arrangement For Solo Piano	J. Brahms/ Arranged by John Maul	© 1996 Roland Corporation
d. 6	Sonate für Klavier No. 15	W. A. Mozart	© 1996 Roland Corporation
d. 7	Liebesträume III	F. Liszt	© 2001 Roland Corporation
d. 8	Étude, op.10-3	F. Chopin	© 2001 Roland Corporation
d. 9	Je te veux	E. Satie	© 1997 Roland Corporation
d. 10	Valse, op.64-1	F. Chopin	© 2001 Roland Corporation
d. 11	Golliwog's Cake walk	C. Debussy	© 1995 Roland Corporation
d. 12	Fantaisie-Impromptu	F. Chopin	© 2001 Roland Corporation
d. 13	1ère Arabesque	C. Debussy	© 1995 Roland Corporation
d. 14	An der schönen, blauen Donau	J. Strauss	© 1996 Roland Corporation
d. 15	Auf Flügeln des Gesanges	F. Mendelsshon	© 1996 Roland Corporation
d. 16	Mazurka No.5	F. Chopin	© 1995 Roland Corporation
d. 17	1ère Gymnopédie	E. Satie	© 1997 Roland Corporation
d. 18	Étude, op.25-1	F. Chopin	© 1995 Roland Corporation
d. 19	Clair de Lune	C. Debussy	© 1998 Roland Corporation
d. 20	Étude, op.10-5	F. Chopin	© 2001 Roland Corporation
d. 21	Doctor Gradus ad Parnassum	C. Debussy	© 1995 Roland Corporation
d. 22	Grande Valse Brillante	F. Chopin	© 1995 Roland Corporation
d. 23	La prière d'une Vierge	T. Badarzewska	© 1996 Roland Corporation
d. 24	Course en Troïka	P. Tchaikovsky	© 1996 Roland Corporation
d. 25	To The Spring	E. Grieg	© 1996 Roland Corporation
d. 26	Valse, op.64-2	F. Chopin	© 1996 Roland Corporation
d. 27	Radetzky Marsch	J. Strauss	© 1996 Roland Corporation
d. 28	Träumerei	R. Schumann	© 1996 Roland Corporation
d. 29	Moments Musicaux III	F. Schubert	© 1996 Roland Corporation
d. 30	Prélude, op.28-15	F. Chopin	© 1996 Roland Corporation
d. 31	The harmonious blacksmith	G. Handel	© 1996 Roland Corporation
d. 32	Ungarische Tänze V	J. Brahms	© 1996 Roland Corporation

## Internal Song List

Song No.	Song Name	Composer	Copyright
d. 33	Türkischer Marsch (Beethoven)	L. v. Beethoven	© 1996 Roland Corporation
d. 34	Nocturne No.2	F. Chopin	© 1996 Roland Corporation
d. 35	Frühlingslied	F. Mendelsshon	© 1996 Roland Corporation
d. 36	Präludium	J. S. Bach	© 1996 Roland Corporation
d. 37	Jägerlied	F. Mendelsshon	© 1996 Roland Corporation
d. 38	Menuet Antique	M. Ravel	© 1996 Roland Corporation
d. 39	Für Elise	L. v. Beethoven	© 1996 Roland Corporation
d. 40	Türkischer Marsch (Mozart)	W. A. Mozart	© 1996 Roland Corporation
d. 41	Ständchen	F. Schubert	© 1996 Roland Corporation
d. 42	Humoreske	A. Dvorjak	© 1996 Roland Corporation
d. 43	Blumenlied	G. Lange	© 1996 Roland Corporation
d. 44	Alpenglöckchen	T. Oesten	© 1996 Roland Corporation
d. 45	Menuett G dur (Beethoven)	L. v. Beethoven	© 1996 Roland Corporation
d. 46	Venezianisches Gondellied	F. Mendelsshon	© 1996 Roland Corporation
d. 47	Alpenabendröte	T. Oesten	© 1996 Roland Corporation
d. 48	Farewell to the Piano	L. v. Beethoven	© 1996 Roland Corporation
d. 49	Brautchor	W. Wagner	© 1996 Roland Corporation
d. 50	Battle of Waterloo	W. Anderson	© 1996 Roland Corporation
d. 51	Wiener Marsch	C. Czerny	© 1996 Roland Corporation
d. 52	Le Coucou	L. C. Daquin	© 1996 Roland Corporation
d. 53	Menuett G dur (Bach)	J. S. Bach	© 1992 Roland Corporation
d. 54	Spinnerlied	A. Ellmenreich	© 1996 Roland Corporation
d. 55	Gavotte	F. Gossec	© 1996 Roland Corporation
d. 56	Heidenröslein	G. Lange	© 1996 Roland Corporation
d. 57	Zigeuner Tanz	H. Lichner	© 1996 Roland Corporation
d. 58	La Cinquantaine	G. Marie	© 1996 Roland Corporation
d. 59	Csikos Post	H. Necke	© 1996 Roland Corporation
d. 60	Dolly's Dreaming Awakening	T. Oesten	© 1996 Roland Corporation
d. 61	La Violette	L. Streabbog	© 1996 Roland Corporation
d. 62	Fröhlicher Landmann	R. Schumann	© 1996 Roland Corporation
d. 63	Sonatine op.36-1 (Clementi)	M. Clementi	© 1996 Roland Corporation
d. 64	Sonatine op.20-1 (Kuhlau)	F. Kuhlau	© 1996 Roland Corporation
d. 65	Sonatine No.5 (Beethoven)	L. v. Beethoven	© 1996 Roland Corporation

\* All rights reserved. Unauthorized use of this material for purposes other than private, personal enjoyment is a violation of applicable laws.

\* No MIDI data for the music that is played will be output.

# Settings Stored in the Setup

## ■ Stored Settings

settings	page
The Tone which is selected in the Upper Tone or the Lower Tone	p. 14 to p. 19
The Tone number which is assigned to each Tone button	p. 14
Settings for dual and split play	p. 18 to p. 20
The volume balance for dual and split play	p. 21
Keyboard's touch	p. 22
The velocity when the keyboard touch is set to "Fixed"	p. 45
Reverb switch's on or off, and the depth of reverb	p. 23
The effect type and the depth of effects	p. 24
Pedal control's on or off	p. 27
Works of Pedal control	p. 44
Key transpose's on or off, and its value	p. 28
Session partoner's settings (*1)	p. 32 to p. 36, p. 47
How the pedal effects are applied	p. 43
Pedals work	p. 43
Setting the part to which effects are applied	p. 44
Octave shift	p. 44
MIDI send channel settings	p. 50
Transferring the program number	p. 52

## ■ Not Stored Settings

settings	page
Recorded performance	p. 38 to p. 40
Master tuning	p. 45
Metronome settings	p. 14, p. 46
Temperament	p. 45
Local control	p. 50
MIDI Out mode	p. 51
Pedal Shift	p. 52
USB Driver settings (*2)	p. 53
Panel lock	p. 53

\*1 Only the settings related to the selected tone or rhythm are stored.

\*2 Though not stored in the Setup, the EP-5 remembers the settings even while its power is turned off.

# Easy Operation List

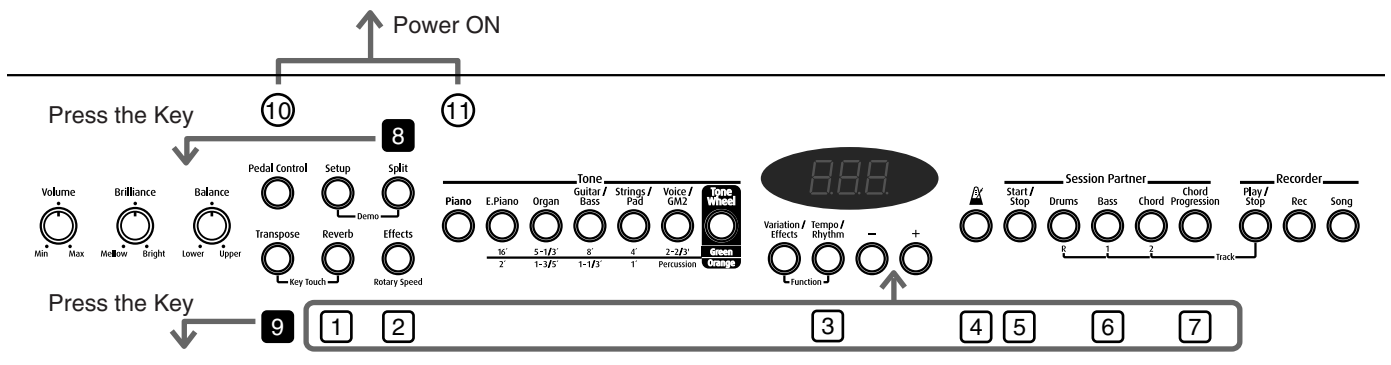

No.	You want to	Buttons	Page
	Switch to Function mode	[Variation/Effects] + [Tempo/Rhythm]	p. 42
	Key Touch	[Transpose] + [Reverb]	p. 22
	Demo	[Setup] + [Split]	p. 11
	All Song Play	[Song] + [Play/Stop]	p. 12
	Storing settings to Setup	[Setup] + Tone	p. 37
	Recording Chord Progression	[Chord Progression] + [Rec]	p. 36
	Erasing the recorded performance	[Song] + [Rec]	p. 41
	Selecting the Lower Tone in Split play	[Split] + Tone	p. 20
Hold down the [□] button and press the [-] or [+] button.			
No.	You want to	Buttons	Page
1	Depth of the Reverb effect	[Reverb] + [-] [+]	p. 23
2	Depth of the Effect	[Effects] + [-] [+]	p. 26
3	Beat of metronome	[Tempo/Rhythm] + [-] [+]	p. 30
4	Volume level of metronome	[Metronome] + [-] [+]	p. 30
5	Volume level of Session Partner	[Start/Stop] + [-] [+]	p. 33
6	Volume level of individual parts	[Drums], [Bass], [Chord] + [-] [+]	p. 33
7	Selecting a Chord Progression Pattern	[Chord Progression] + [-] [+]	p. 34
Hold down the [■] button and press the key.			
8	Split Point	[Split] + key	p. 20
9	Key Transpose	[Transpose] + key	p. 28
Hold down the [○] button and press the [Power] switch.			
10	Factory Reset	[Pedal Control] + Power ON	p. 53
11	Panel Lock	[Piano] + Power ON	p. 53



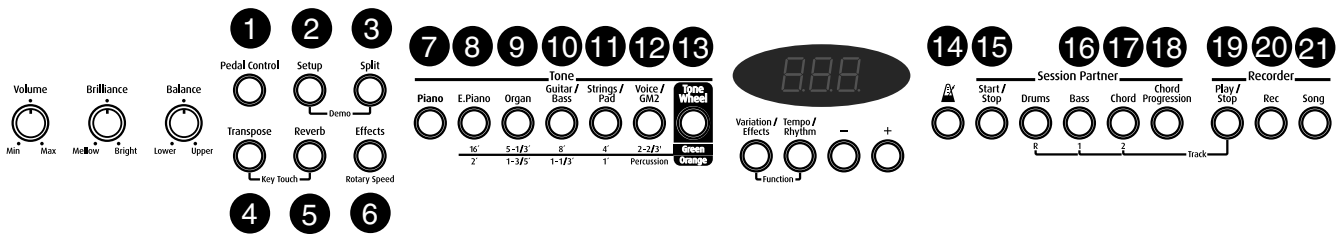

Function mode			
No.	You want to	Buttons	Page
1	Work of the Pedal Control	[Pedal Control]	p. 44
2	Bulk dump, Pedal Shift, Transferring the Program Change	[Setup]	p. 52
3	Octave shift	[Split]	p. 44
4	Temperament	[Transpose]	p. 45
5	Changing the Velocity when the Key Touch is set to "Fixed"	[Reverb]	p. 45
6	Setting the Part to which Effects are added	[Effects]	p. 44
7	Master Tuning	[Piano]	p. 45
8	How the Soft Pedal(FC2) effects are applied	[E.Piano]	p. 43
9	How the Sostenuto Pedal(FC1) effects are applied	[Organ]	p. 43
10	How the Damper Pedal effects are applied	[Guitar/Bass]	p. 43
11	Soft Pedal(FC2)s Work	[Strings/Pad]	p. 44
12	Sostenuto Pedal(FC1)s Work	[Voice/GM2]	p. 44
13	USB Driver	[Song] + [Rec]	p. 53
14	Metronome beat pattern	[  (Metronome)]	p. 46
15	Setting the Intro and Ending ON or OFF	[Start/Stop]	p. 47
16	Root Note of the Chord Progression	[Bass]	p. 47
17	Setting the Chord Display ON or OFF	[Chord]	p. 47
18	Fixing a set Chord Progression	[Chord Progression]	p. 47
19	MIDI Out mode	[Play/Stop]	p. 51
20	MIDI send channel settings	[Rec]	p. 50
21	Local Control	[Song]	p. 50



# Main Specifications

## <Keyboard>

88 keys (progressive hammer action keyboard)

## Touch Sensitivity

Light/Normal/Heavy/Fixed (adjustable velocity)

## Keyboard Mode

Whole

Dual

Split (adjustable split point)

## <Sound Generator>

Conforms to General MIDI 2 System

## Max. Polyphony

64 voices

## Tones

Tones: 7 groups 64 variations (include 6 Tone Wheel Organ and 4 Drum Sets)

GM2 Tones: 256 + 9 Drum Sets

## Effects

Reverb

Multi Effects (10 Types)

## Transposition

-6 to +5 (semitone steps)

## Temperament

7 types, selectable tonic

## Master Tuning

415.3 Hz to 466.2 Hz (0.1 Hz Step)

## <Session Partner>

## Rhythms

80 Rhythms

## Chord Progression

Automatic or input with keyboard

User Programmable

## <Recorder>

Metronome

Beat: 2/2, 0/4, 2/4, 3/4, 4/4, 5/4, 6/4, 7/4, 3/8, 6/8, 9/8, 12/8

Volume: 10 levels

Pattern: 11 patterns

## Tracks

3 tracks (only Rhythm sound can be recorded to Track [R] button.)

## Song

1 song

## Tempo

Quarter note = 20 to 250

## Resolution

120 ticks per quarter note

## <Others>

## Setup

7

## Internal Songs

Demo songs: 9

Piano songs: 65

## Speakers

10 cm x 2

## Rated Power Output

10 W x 2

## Display

7-segment, 3-digit LED

## Connectors

Line Out jacks (L/Mono, R)

Line In jacks (L/Mono, R)

Phones jack (front panel) x 2 (stereo miniature phone type)

USB connector (MIDI)

MIDI connectors (In/Out)

Pedal jacks (Damper, Soft\*, Sostenuto\*)

\* Assignable

DC In Jack

## Power Supply

DC 12 V (AC adaptor)

## Power Consumption

35 W

## Dimensions

FP-5 (Without the music stand) :

1,308 (W) x 360 (D) x 128(H) mm

51-1/2 (W) x 14-3/16 (D) x 5-1/16 (H) inches

FP-5 + FPS-11A (With the music stand) :

1,308 (W) x 394 (D) x 920(H) mm

51-1/2 (W) x 15-9/16 (D) x 36-1/4 (H) inches

## Weights

FP-5: 21.5 kg / 47 lbs 7 oz

FPS-11A: 7.3 kg / 16 lbs 2 oz

Music Stand: 0.6 kg / 1 lbs 6 oz

Total: 29.4 kg / 64 lbs 14 oz

## Accessories

Owner's manual

USB Installation guide

CD-ROM (Roland Digital Piano USB Driver)

AC adaptor

AC cord

Music Stand / 2 screws for the music stand

Pedal (DP-8)

## Options

Keyboard Stand (FPS-11A)

Pedal (DP-2/8)

Expression Pedal (EV-5)

MIDI Implementation

\* In the interest of product improvement, the specifications and/or appearance of this unit are subject to change without prior notice.

# Index

- A**
- AC adaptor ..... 8
  - AC cable ..... 8
  - All Song Play ..... 12
- B**
- Balance knob ..... 21
  - Bass button ..... 32–33, 40, 47
  - Beat
    - Metronome ..... 30
  - Bend Down ..... 43–44
  - Bend Up ..... 43–44
  - Brilliance knob ..... 10
  - Bulk Dump ..... 52
- C**
- Chord button ..... 32–33, 40, 47
  - Chord Fingering List ..... 65
  - Chord Progression
    - Automatically ..... 32
    - Fixing ..... 47
    - Recording ..... 36
    - Root Note ..... 47
    - Selecting pattern ..... 34
    - Specifying the chords ..... 35
  - Chord Progression button ..... 34–36, 47
  - Chord Progression off ..... 35
  - Chord Progression Pattern List ..... 62
  - Connecting
    - Audio Equipment ..... 48
    - MIDI ..... 49
    - Power ..... 8
    - USB ..... 49
  - cord hook ..... 8
- D**
- Damper jack ..... 9, 27, 44
  - Damper Pedal ..... 9, 43
  - Demo Song ..... 11
  - Display ..... 56
  - Drums button ..... 32–33, 40
  - Dual Play ..... 18
- E**
- E.Piano button ..... 43
  - Easy Operation List ..... 72
  - Effects ..... 24, 43
  - Effects button ..... 24, 44
  - Ending ..... 32, 47
  - Erasing ..... 41
  - Expression ..... 43
- F**
- Factory Reset ..... 53
  - Feet ..... 15
  - Fill In ..... 33
  - Function Mode ..... 42
- G**
- General MIDI ..... 48
  - General MIDI 2 ..... 48
  - Guitar/Bass button ..... 43
- H**
- Headphones ..... 10
- I**
- Including pedal ..... 9
  - Internal Song
    - Recording ..... 40
  - Internal Song List ..... 69
  - Intro ..... 32, 47
- K**
- Key Transpose ..... 28
  - Keyboard Touch ..... 22, 45
- L**
- Leading bass ..... 43
  - Local Control ..... 50
  - Lower Tone ..... 18–19
- M**
- Master Tuning ..... 45
  - Messages ..... 56
  - Metronome ..... 29
    - Beat Pattern ..... 46
    - Volume ..... 30
  - Metronome button ..... 29–30, 46
  - MIDI ..... 49
  - MIDI Out Mode ..... 51
  - MIDI Send Channel ..... 50
  - MIDI Sound Module ..... 50
  - Modulation ..... 27, 43–44
  - Music Stand ..... 8
  - Muting ..... 13

- O**
- Octave Shift ..... 44
  - Organ button ..... 43
- P**
- Panel Lock ..... 53
  - Pedal ..... 9
    - Effects ..... 43
    - Works ..... 43–44
  - Pedal Control ..... 27, 44
  - Pedal Control button ..... 27, 44, 53
  - Pedal Shift ..... 52
  - Phones ..... 10
  - Piano button ..... 45, 53
  - Pitch ..... 45
  - Pitch Bend ..... 27
  - Play/Stop button ..... 39, 51
  - Playback
    - All Songs ..... 12
    - demo song ..... 11
    - Each part separately ..... 13
    - Internal song ..... 12
  - Power ..... 9
  - Program Change ..... 52
- R**
- Rec button ..... 38–41, 50
  - Recording ..... 38
    - Along with internal songs ..... 40
    - Performance using Session Partner ..... 39
    - Selected Tracks ..... 40
  - Reverb button ..... 23, 45
  - Reverb Effect ..... 23
  - Rhythm ..... 31
    - selecting ..... 33
  - Rhythm List ..... 62
  - Rotary Effect ..... 26
- S**
- Sequencer ..... 50
  - Session Partner ..... 31–32, 47
  - Setup ..... 37
  - Setup button ..... 37, 52
  - Soft Pedal ..... 9, 43–44
  - Soft(FC2) jack ..... 9, 43
  - Song button ..... 12, 38, 41, 51
  - Sostenuto Pedal ..... 9, 43–44
  - Sostenuto(FC1) jack ..... 9, 43
  - Split button ..... 19, 44
  - Split Play ..... 19
  - Split Point ..... 20
  - Standard pitch ..... 45
  - Start/Stop button ..... 32, 47
  - Start/Stop of Session Partner ..... 43
  - Strings/Pad button ..... 44
  - Sympathetic Resonance ..... 9, 25
- T**
- Temperament ..... 46
  - Tempo
    - Metronome ..... 29
    - Rhythm ..... 34
  - Tempo/Rhythm button ..... 29, 33
  - Tone ..... 14
  - Tone button ..... 14, 37
  - Tone group ..... 14
  - Tone List ..... 57
  - Tone Wheel button ..... 16, 53
  - Tone Wheel Mode ..... 15
  - Touch sensitivity ..... 22
  - Track Button ..... 13, 40
    - Recording ..... 40–41
  - Transpose ..... 28
  - Transpose button ..... 22, 28, 45
  - Troubleshooting ..... 54
  - Tuning ..... 45
- U**
- Upper Tone ..... 18–19
  - USB ..... 53
  - USr ..... 38
- V**
- Variation/Effects button ..... 14, 24
  - Velocity ..... 45
  - Voice/GM2 button ..... 44
  - Volume
    - Metronome ..... 30
    - part ..... 33
  - Volume Balance
    - Lower Tone and Upper Tone ..... 21
  - Volume knob ..... 9–10
  - volume level ..... 10

# Information

When you need repair service, call your nearest Roland Service Center or authorized Roland distributor in your country as shown below.

## AFRICA

### EGYPT

**Al Fanny Trading Office**  
9, EBN Hagar A1 Askalany Street,  
ARD El Golf, Heliopolis,  
Cairo 11341, EGYPT  
TEL: 20-2-417-1828

### REUNION

**Maison FO - YAM Marcel**  
25 Rue Jules Hermann,  
Chaudron - BP79 97 491  
Ste Clotilde Cedex,  
REUNION ISLAND  
TEL: (0262) 218-429

### SOUTH AFRICA

**That Other Music Shop(PTY)Ltd.**  
11 Melle St., Braamfontein,  
Johannesburg,  
SOUTH AFRICA  
TEL: (011) 403 4105  
FAX: (011) 403 1234

**Paul Bothner(PTY)Ltd.**  
17 Werdmuller Centre,  
Main Road, Claremont 7708  
SOUTH AFRICA  
TEL: (021) 674 4030

## ASIA

### CHINA

**Roland Shanghai Electronics Co.,Ltd.**  
5F. No.1500 Pingliang Road  
Shanghai 200090, CHINA  
TEL: (021) 5580-0800

**Roland Shanghai Electronics Co.,Ltd.**  
(BEIJING OFFICE)  
10F. No.18 3 Section Anhuaxili  
Chaoyang District Beijing  
100011 CHINA  
TEL: (010) 6426-5050

**Roland Shanghai Electronics Co.,Ltd.**  
(GUANGZHOU OFFICE)  
2/F., No.30 Si You Nan Er Jie  
Yi Xiang, Wu Yang Xin Cheng,  
Guangzhou 510600, CHINA  
TEL: (020) 8736-0428

### HONG KONG

**Tom Lee Music Co., Ltd.**  
Service Division  
22-32 Pun Shan Street, Tsuen  
Wan, New Territories,  
HONG KONG  
TEL: 2415 0911

**Parsons Music Ltd.**  
8th Floor, Railway Plaza, 39  
Chatham Road South, T.S.T,  
Kowloon, HONG KONG  
TEL: 2333 1863

### INDIA

**Rivera Digitec (India) Pvt. Ltd.**  
409, Nirman Kendra  
Mahalaxmi Flats Compound  
Off. Dr. Edwin Moses Road,  
Mumbai-400011, INDIA  
TEL: (022) 2493 9051

### INDONESIA

**PT Citra IntiRama**  
Jl. Cideng Timur No. 15J-150  
Jakarta Pusat  
INDONESIA  
TEL: (021) 6324170

### KOREA

**Cosmos Corporation**  
1461-9, Seocho-Dong,  
Seocho Ku, Seoul, KOREA  
TEL: (02) 3486-8855

### MALAYSIA

**Roland Asia Pacific Sdn. Bhd.**  
45-1, Block C2, Jalan PJU 1/39,  
Dataran Prima, 47301 Petaling  
Jaya, Selangor, MALAYSIA  
TEL: (03) 7805-3263

## PHILIPPINES

**G.A. Yupangco & Co. Inc.**  
339 Gil J. Puyat Avenue  
Makati, Metro Manila 1200,  
PHILIPPINES  
TEL: (02) 899 9801

## SINGAPORE

**SWEE LEE MUSIC COMPANY PTE. LTD.**  
150 Sims Drive,  
SINGAPORE 387381  
TEL: 6846-3676

**CRISTOFORI MUSIC PTE LTD**  
Blk 3014, Bedok Industrial Park E,  
#02-2148, SINGAPORE 489980  
TEL: 6243-9555

## TAIWAN

**ROLAND TAIWAN ENTERPRISE CO., LTD.**  
Room 5, 9fl. No. 112 Chung  
Shan N.Road Sec.2, Taipei,  
TAIWAN, R.O.C.  
TEL: (02) 2561 3339

## THAILAND

**Theera Music Co., Ltd.**  
330 Vergm NakornKasem, Soi 2,  
Bangkok 10100, THAILAND  
TEL: (02) 2248821

## VIETNAM

**Saigon Music Suite DP-8**  
40 Ba Huyen Thanh Quan Street  
Hochiminh City, VIETNAM  
TEL: (08) 930-1969

## AUSTRALIA/NEW ZEALAND

**AUSTRALIA/NEW ZEALAND Roland Corporation Australia Pty.,Ltd.**  
38 Campbell Avenue  
Dee Why West. NSW 2099  
AUSTRALIA

For Australia  
Tel: (02) 9982 8266  
For New Zealand  
Tel: (09) 3098 715

## CENTRAL/LATIN AMERICA

### ARGENTINA

**Instrumentos Musicales S.A.**  
Av.Santa Fe 2055  
(1123) Buenos Aires  
ARGENTINA  
TEL: (011) 4508-2700

### BARBADOS

**A&B Music Supplies LTD**  
12 Webster Industrial Park  
Wildey, St.Michael, Barbados  
TEL: (246)430-1100

### BRAZIL

**Roland Brasil Ltda.**  
Rua San Jose, 780 Sala B  
Parque Industrial San Jose  
Cotia - Sao Paulo - SP, BRAZIL  
TEL: (011) 4615 5666

### CHILE

**Comercial Fancy II S.A.**  
Rut.: 96.919.420-1  
Nataaniel Cox #739, 4th Floor  
Santiago - Centro, CHILE  
TEL: (02) 688-9540

### COLOMBIA

**Centro Musical Ltda.**  
Cra 43 B No 25 A 41 Bododega 9  
Medellin, Colombia  
TEL: (574)3812529

## COSTA RICA

**JUAN BANSBACH Instrumentos Musicales**  
Ave.1. Calle 11, Apartado 10237,  
San Jose, COSTA RICA  
TEL: 258-0211

## CURACAO

**Zeelandia Music Center Inc.**  
Orionweg 30  
Curacao, Netherland Antilles  
TEL:(305)5926866

## DOMINICAN REPUBLIC

**Instrumentos Fernando Giraldez**  
Calle Proyecto Central No.3  
Ens.La Esperilla  
Santo Domingo,  
Dominican Republic  
TEL:(809) 683 0305

## ECUADOR

**Mas Musica**  
Rumichaca 822 y Zaruma  
Guayaquil - Ecuador  
TEL:(593-4)2302364

## EL SALVADOR

**OMNI MUSIC**  
75 Avenida Norte y Final  
Alameda Juan Pablo II,  
Edificio No.4010 San Salvador,  
EL SALVADOR  
TEL: 262-0788

## GUATEMALA

**Casa Instrumental**  
Calzada Roosevelt 34-01, zona 11  
Ciudad de Guatemala  
Guatemala  
TEL:(502) 599-2888

## HONDURAS

**Almacen Pajaro Azul S.A. de C.V.**  
BO.Paz Barahona  
3 Ave.11 Calle S.O  
San Pedro Sula, Honduras  
TEL: (504) 553-2029

## MARTINIQUE

**Musique & Son**  
Z.I.Les Mangle  
97232 Le Lamantin  
Martinique F.W.I.  
TEL: 596 596 426860

## Gigamusic SARKL

10 Rte De La Folie  
97200 Fort De France  
Martinique F.W.I.  
TEL: 596 596 715222

## MEXICO

**Casa Veerkamp, s.a. de c.v.**  
Av. Toluca No. 323, Col. Olivar  
de los Padres 01780 Mexico  
D.F. MEXICO  
TEL: (55) 5668-6699

## NICARAGUA

**Bansbach Instrumentos Musicales Nicaragua**  
Altamira D'Este Calle Principal  
de la Farmacia 5ta.Avenida  
1 Cuadra al Lago.#503  
Managua, Nicaragua  
TEL: (505)277-2557

## PANAMA

**SUPRO MUNDIAL, S.A.**  
Boulevard Andrews, Albrook,  
Panama City, REP. DE  
PANAMA  
TEL: 315-0101

## PARAGUAY

**Distribuidora De Instrumentos Musicales**  
J.E. Olear y ESQ. Manduvira  
Asuncion PARAGUAY  
TEL: (595) 21 492147

## PERU

**Audionet**  
Distribuciones Musicales SAC  
Juan Pablo 530  
Miraflores  
Lima - Peru  
TEL: (511) 4461388

## TRINIDAD

**AMR Ltd**  
Ground Floor  
Maritime Plaza  
Barataria Trinidad W.I.  
TEL: (868)638 6385

## URUGUAY

**Todo Musica S.A.**  
Francisco Acuna de Figueroa  
1771  
C.P.: 11.800  
Montevideo, URUGUAY  
TEL: (02) 924-2335

## VENEZUELA

**Instrumentos Musicales Allegro,C.A.**  
Av.las industrias edf.Guitar  
import  
#7 zona Industrial de Turumo  
Caracas, Venezuela  
TEL: (212) 244-1122

## EUROPE

### AUSTRIA

**Roland Elektronische Musikinstrumente HmbH.**  
Austrian Office  
Eduard-Bodem-Gasse 8,  
A-6020 Innsbruck, AUSTRIA  
TEL: (0512) 26 44 260

**BELGIUM/FRANCE/HOLLAND/LUXEMBOURG**  
Roland Central Europe N.V.  
Houtstraat 3, B-2260, Oevel  
(Westerlo) BELGIUM  
TEL: (014) 575811

**CZECH REP.**  
K-AUDIO  
Kardasovska 626,  
CZ-198 00 Praha 9,  
CZECH REP.  
TEL: (2) 666 10529

### DENMARK

**Roland Scandinavia A/S**  
Nordhavnsvej 7, Postbox 880,  
DK-2100 Copenhagen  
DENMARK  
TEL: 3916 6200

### FINLAND

**Roland Scandinavia As, Filial Finland**  
Elanontie 5  
FIN-01510 Vantaa, FINLAND  
TEL: (09) 68 24 020

### GERMANY

**Roland Elektronische Musikinstrumente HmbH.**  
Oststrasse 96, 22844  
Norderstedt, GERMANY  
TEL: (040) 52 60090

### GREECE

**STOLLAS S.A.**  
Music Sound Light  
155, New National Road  
Patras 26442, GREECE  
TEL: 2610 435400

### HUNGARY

**Roland East Europe Ltd.**  
Warehouse Area 'DEPO' Pf.83  
H-2046 Torokbalint,  
HUNGARY  
TEL: (23) 511011

### IRELAND

**Roland Ireland**  
G2 Calmount Park, Calmount  
Avenue, Dublin 12  
Republic of IRELAND  
TEL: (01) 4294444

### ITALY

**Roland Italy S. p. a.**  
Viale delle Industrie 8,  
20020 Arese, Milano, ITALY  
TEL: (02) 937-78300

## NORWAY

**Roland Scandinavia Avd.**  
Kontor Norge  
Lilleakerveien 2 Postboks 95  
Lilleaker N-0216 Oslo  
NORWAY  
TEL: 2273 0074

## POLAND

**MX MUSIC SP.Z.O.O.**  
UL. Gibraltarska 4,  
PL-03664 Warszawa POLAND  
TEL: (022) 679 44 19

## PORTUGAL

**Roland Iberia, S.L.**  
Portugal Office  
Cais das Pedras, 8/9-1 Dto  
4050-465, Porto, PORTUGAL  
TEL: 22 608 00 60

## ROMANIA

**FBS LINES**  
Piata Libertatii 1,  
535500 Gheorgheni,  
ROMANIA  
TEL: (266) 364 609

## RUSSIA

**MuTek**  
3-Bogatyrskaya Str. 1.k.1  
107 564 Moscow, RUSSIA  
TEL: (095) 169 5043

## SPAIN

**Roland Iberia, S.L.**  
Paseo Garcia Faria, 33-35  
08005 Barcelona SPAIN  
TEL: 93 493 91 00

## SWEDEN

**Roland Scandinavia A/S**  
SWEDISH SALES OFFICE  
Danvik Center 28, 2 tr.  
S-131 30 Nacka SWEDEN  
TEL: (0)8 702 00 20

## SWITZERLAND

**Roland (Switzerland) AG**  
Landstrasse 5, Postfach,  
CH-4452 Itingen,  
SWITZERLAND  
TEL: (061) 927-8383

## UKRAINE

**TIC-TAC**  
Mira Str. 19/108  
P.O. Box 180  
295400 Munkachevo,  
UKRAINE  
TEL: (03131) 414-40

## UNITED KINGDOM

**Roland (U.K.) Ltd.**  
Atlantic Close, Swansea  
Enterprise Park, SWANSEA  
SA7 9FJ,  
UNITED KINGDOM  
TEL: (01792) 702701

## MIDDLE EAST

### BAHRAIN

**Moon Stores**  
No.16, Bab Al Bahrain Avenue,  
P.O.Box 247, Manama 304,  
State of BAHRAIN  
TEL: 17 211 005

### CYPRUS

**Radex Sound Equipment Ltd.**  
17, Diagorou Street, Nicosia,  
CYPRUS  
TEL: (022) 66-9426

### IRAN

**MOCO INC.**  
No.41 Nike St., Dr.Shariyati Ave.,  
Roberoye Cerahe Mirdamad  
Tehran, IRAN  
TEL: (021) 285-4169

### ISRAEL

**Halilit P. Greenspoon & Sons Ltd.**  
8 Retzif Ha'aliya Hashnya St.  
Tel-Aviv-Yafo ISRAEL  
TEL: (03) 6823666

## JORDAN

**AMMAN Trading Agency**  
245 Prince Mohammad St.,  
Amman 1118, JORDAN  
TEL: (06) 464-1200

## KUWAIT

**EASA HUSAIN AL-YOUSIFI & SONS CO.**  
Abdullah Salem Street,  
Safat, KUWAIT  
TEL: 243-6399

## LEBANON

**Chahine S.A.L.**  
Gerge Zeidan St., Chahine  
Bldg., Achrafieh, P.O.Box: 16-  
5857  
Beirut, LEBANON  
TEL: (01) 20-1441

## OMAN

**TALENTZ CENTRE L.L.C.**  
P.O. BOX 37, MUSCAT,  
POSTAL CODE 113  
TEL: 931-3705

## QATAR

**Al Emadi Co. (Badie Studio & Stores)**  
P.O. Box 62, Doha, QATAR  
TEL: 4423-554

## SAUDI ARABIA

**aDawlah Universal Electronics APL**  
Corniche Road, Aldossary  
Bldg., 1st Floor, Alkhobar,  
SAUDI ARABIA

P.O.Box 2154, Alkhobar 31952  
SAUDI ARABIA  
TEL: (03) 898 2081

## SYRIA

**Technical Light & Sound Center**  
Rawda, Abdul Qader Jazairi St.  
Bldg. No. 21, P.O.BOX 13520,  
Damascus, SYRIA  
TEL: (011) 223-5384

## TURKEY

**Ant Muzik Aletleri Ithalat Ve Ihracat Ltd Sti**  
Siraselviler Caddesi  
Siraselviler Pasaji No:74/20  
Taksim - Istanbul, TURKEY  
TEL: (0212) 2449624

## U.A.E.

**Zak Electronics & Musical Instruments Co. L.L.C.**  
Zabeel Road, Al Sherooq Bldg.,  
No. 14, Grand Floor, Dubai,  
U.A.E.  
TEL: (04) 3360715

## NORTH AMERICA

### CANADA

**Roland Canada Music Ltd. (Head Office)**  
5480 Parkwood Way  
Richmond B. C., V6V 2M4  
CANADA  
TEL: (604) 270 6626

### Roland Canada Music Ltd. (Toronto Office)

170 Admiral Boulevard  
Mississauga On L5T 2N6  
CANADA  
TEL: (905) 362 9707

### U. S. A.

**Roland Corporation U.S.**  
5100 S. Eastern Avenue  
Los Angeles, CA 90040-2938,  
U. S. A.  
TEL: (323) 890 3700



This product complies with the requirements of European Directive 89/336/EEC.

For EU Countries

## FEDERAL COMMUNICATIONS COMMISSION RADIO FREQUENCY INTERFERENCE STATEMENT

For the USA

This equipment has been tested and found to comply with the limits for a Class B digital device, pursuant to Part 15 of the FCC Rules. These limits are designed to provide reasonable protection against harmful interference in a residential installation. This equipment generates, uses, and can radiate radio frequency energy and, if not installed and used in accordance with the instructions, may cause harmful interference to radio communications. However, there is no guarantee that interference will not occur in a particular installation. If this equipment does cause harmful interference to radio or television reception, which can be determined by turning the equipment off and on, the user is encouraged to try to correct the interference by one or more of the following measures:

- Reorient or relocate the receiving antenna.
- Increase the separation between the equipment and receiver.
- Connect the equipment into an outlet on a circuit different from that to which the receiver is connected.
- Consult the dealer or an experienced radio/TV technician for help.

This device complies with Part 15 of the FCC Rules. Operation is subject to the following two conditions:

- (1) This device may not cause harmful interference, and
- (2) This device must accept any interference received, including interference that may cause undesired operation.

Unauthorized changes or modification to this system can void the users authority to operate this equipment.  
This equipment requires shielded interface cables in order to meet FCC class B Limit.

For Canada

### NOTICE

This Class B digital apparatus meets all requirements of the Canadian Interference-Causing Equipment Regulations.

### AVIS

Cet appareil numérique de la classe B respecte toutes les exigences du Règlement sur le matériel brouilleur du Canada.

This owner's manual is printed on recycled paper.

**Roland Corporation**

03124823

'05-2-7N