

D I G I T A L
P I A N O **DP-970**

Owner's Manual

Thank you, and congratulations on your choice of the Roland Digital Piano DP-970.

Assembling the DP-970	☞	p. 8
Before You Start Playing	☞	p. 12
Enjoying the Internal Songs	☞	p. 15
Playing the Keyboard	☞	p. 19
Contents	☞	p. 6
Index	☞	p. 56

Before using this unit, carefully read the sections entitled: "USING THE UNIT SAFELY" (p. 3, 4) and "IMPORTANT NOTES" (p. 5, 6). These sections provide important information concerning the proper operation of the unit. Additionally, in order to feel assured that you have gained a good grasp of every feature provided by your new unit, Owner's manual should be read in its entirety. The manual should be saved and kept on hand as a convenient reference.

Copyright © 2005 ROLAND CORPORATION

All rights reserved. No part of this publication may be reproduced in any form without the written permission of ROLAND CORPORATION.

For the U.K.

IMPORTANT: THE WIRES IN THIS MAINS LEAD ARE COLOURED IN ACCORDANCE WITH THE FOLLOWING CODE.



BLUE: NEUTRAL
BROWN: LIVE

As the colours of the wires in the mains lead of this apparatus may not correspond with the coloured markings identifying the terminals in your plug, proceed as follows:
The wire which is coloured BLUE must be connected to the terminal which is marked with the letter N or coloured BLACK.
The wire which is coloured BROWN must be connected to the terminal which is marked with the letter L or coloured RED.
Under no circumstances must either of the above wires be connected to the earth terminal of a three pin plug.



USING THE UNIT SAFELY

INSTRUCTIONS FOR THE PREVENTION OF FIRE, ELECTRIC SHOCK, OR INJURY TO PERSONS

About ⚠ WARNING and ⚠ CAUTION Notices









 WARNING	Used for instructions intended to alert the user to the risk of death or severe injury should the unit be used improperly.
 CAUTION	Used for instructions intended to alert the user to the risk of injury or material damage should the unit be used improperly. * Material damage refers to damage or other adverse effects caused with respect to the home and all its furnishings, as well to domestic animals or pets.

About the Symbols





	The ⚠ symbol alerts the user to important instructions or warnings. The specific meaning of the symbol is determined by the design contained within the triangle. In the case of the symbol at left, it is used for general cautions, warnings, or alerts to danger.
	The ⊘ symbol alerts the user to items that must never be carried out (are forbidden). The specific thing that must not be done is indicated by the design contained within the circle. In the case of the symbol at left, it means that the unit must never be disassembled.
	The ● symbol alerts the user to things that must be carried out. The specific thing that must be done is indicated by the design contained within the circle. In the case of the symbol at left, it means that the power-cord plug must be unplugged from the outlet.

ALWAYS OBSERVE THE FOLLOWING

⚠ WARNING

- Before using this unit, make sure to read the instructions below, and the Owner's Manual. 
- Do not open (or modify in any way) the unit or its AC adaptor. 
- Do not attempt to repair the unit, or replace parts within it (except when this manual provides specific instructions directing you to do so). Refer all servicing to your retailer, the nearest Roland Service Center, or an authorized Roland distributor, as listed on the "Information" page. 
- Never use or store the unit in places that are:
 - Subject to temperature extremes (e.g., direct sunlight in an enclosed vehicle, near a heating duct, on top of heat-generating equipment); or are 
 - Damp (e.g., baths, washrooms, on wet floors); or are 
 - Humid; or are
 - Exposed to rain; or are
 - Dusty; or are
 - Subject to high levels of vibration.
- Make sure you always have the unit placed so it is level and sure to remain stable. Never place it on stands that could wobble, or on inclined surfaces. 
- Be sure to use only the AC adaptor supplied with the unit. Also, make sure the line voltage at the installation matches the input voltage specified on the AC adaptor's body. Other AC adaptors may use a different polarity, or be designed for a different voltage, so their use could result in damage, malfunction, or electric shock. 
- Use only the attached power-supply cord. Also, the supplied power cord must not be used with any other device. 

⚠ WARNING

- Do not excessively twist or bend the power cord, nor place heavy objects on it. Doing so can damage the cord, producing severed elements and short circuits. Damaged cords are fire and shock hazards! 
- This unit, either alone or in combination with an amplifier and headphones or speakers, may be capable of producing sound levels that could cause permanent hearing loss. Do not operate for a long period of time at a high volume level, or at a level that is uncomfortable. If you experience any hearing loss or ringing in the ears, you should immediately stop using the unit, and consult an audiologist. 
- Do not allow any objects (e.g., flammable material, coins, pins); or liquids of any kind (water, soft drinks, etc.) to penetrate the unit. 

- Immediately turn the power off, remove the AC adaptor from the outlet, and request servicing by your retailer, the nearest Roland Service Center, or an authorized Roland distributor, as listed on the "Information" page when:
 - The AC adaptor, the power-supply cord, or the plug has been damaged; or
 - If smoke or unusual odor occurs
 - Objects have fallen into, or liquid has been spilled onto the unit; or
 - The unit has been exposed to rain (or otherwise has become wet); or
 - The unit does not appear to operate normally or exhibits a marked change in performance.
- In households with small children, an adult should provide supervision until the child is capable of following all the rules essential for the safe operation of the unit. 

⚠ WARNING

- Protect the unit from strong impact. (Do not drop it!) 

- Do not force the unit's power-supply cord to share an outlet with an unreasonable number of other devices. Be especially careful when using extension cords—the total power used by all devices you have connected to the extension cord's outlet must never exceed the power rating (watts/amperes) for the extension cord. Excessive loads can cause the insulation on the cord to heat up and eventually melt through. 

- Before using the unit in a foreign country, consult with your retailer, the nearest Roland Service Center, or an authorized Roland distributor, as listed on the "Information" page. 

⚠ CAUTION

- The unit and the AC adaptor should be located so their location or position does not interfere with their proper ventilation. 

- Always grasp only the plug on the AC adaptor cord when plugging into, or unplugging from, an outlet or this unit. 

- At regular intervals, you should unplug the AC adaptor and clean it by using a dry cloth to wipe all dust and other accumulations away from its prongs. Also, disconnect the power plug from the power outlet whenever the unit is to remain unused for an extended period of time. Any accumulation of dust between the power plug and the power outlet can result in poor insulation and lead to fire. 

- Try to prevent cords and cables from becoming entangled. Also, all cords and cables should be placed so they are out of the reach of children. 

- Never climb on top of, nor place heavy objects on the unit. 

- Never handle the AC adaptor or its plugs with wet hands when plugging into, or unplugging from, an outlet or this unit. 

- If you need to move the instrument, take note of the precautions listed below. At least two persons are required to safely lift and move the unit. It should be handled carefully, all the while keeping it level. Make sure to have a firm grip, to protect yourself from injury and the instrument from damage. 
 - Check to make sure the screws securing the unit to the stand have not become loose. Fasten them again securely whenever you notice any loosening.
 - Disconnect the power cord.
 - Disconnect all cords coming from external devices.
 - Close the lid.

- Before cleaning the unit, turn off the power and unplug the AC adaptor from the outlet (p. 12). 

- Whenever you suspect the possibility of lightning in your area, disconnect the AC adaptor from the outlet. 

- Be careful when opening/closing the lid so you do not get your fingers pinched (p. 12). Adult supervision is recommended whenever small children use the unit. 

- Keep any ground terminal screw, and wing nut you may remove and the included screws of stand, and cord clamp in a safe place out of children's reach, so there is no chance of them being swallowed accidentally. 

IMPORTANT NOTES

In addition to the items listed under “USING THE UNIT SAFELY” on pages 3–4, please read and observe the following:

Power Supply

- Do not connect this unit to same electrical outlet that is being used by an electrical appliance that is controlled by an inverter (such as a refrigerator, washing machine, microwave oven, or air conditioner), or that contains a motor. Depending on the way in which the electrical appliance is used, power supply noise may cause this unit to malfunction or may produce audible noise. If it is not practical to use a separate electrical outlet, connect a power supply noise filter between this unit and the electrical outlet.
- The AC adaptor will begin to generate heat after long hours of consecutive use. This is normal, and is not a cause for concern.
- Before connecting this unit to other devices, turn off the power to all units. This will help prevent malfunctions and/or damage to speakers or other devices.

Placement

- Using the unit near power amplifiers (or other equipment containing large power transformers) may induce hum. To alleviate the problem, change the orientation of this unit; or move it farther away from the source of interference.
- This device may interfere with radio and television reception. Do not use this device in the vicinity of such receivers.
- Noise may be produced if wireless communications devices, such as cell phones, are operated in the vicinity of this unit. Such noise could occur when receiving or initiating a call, or while conversing. Should you experience such problems, you should relocate such wireless devices so they are at a greater distance from this unit, or switch them off.
- Do not expose the unit to direct sunlight, place it near devices that radiate heat, leave it inside an enclosed vehicle, or otherwise subject it to temperature extremes. Also, do not allow lighting devices that normally are used while their light source is very close to the unit (such as a piano light), or powerful spotlights to shine upon the same area of the unit for extended periods of time. Excessive heat can deform or discolor the unit.
- When moved from one location to another where the temperature and/or humidity is very different, water droplets (condensation) may form inside the unit. Damage or malfunction may result if you attempt to use the unit in this condition. Therefore, before using the unit, you must allow it to stand for several hours, until the condensation has completely evaporated.
- Do not allow rubber, vinyl, or similar materials to remain on the unit for long periods of time. Such objects can discolor or otherwise harmfully affect the finish.
- Do not allow objects to remain on top of the keyboard. This can be the cause of malfunction, such as keys ceasing to produce sound.
- Do not paste stickers, decals, or the like to this instrument. Peeling such matter off the instrument may damage the exterior finish.

Maintenance

- To clean the unit, use a dry, soft cloth; or one that is slightly dampened. Try to wipe the entire surface using an equal amount of strength, moving the cloth along with the grain of the wood. Rubbing too hard in the same area can damage the finish.
- Never use benzine, thinners, alcohol or solvents of any kind, to avoid the possibility of discoloration and/or deformation.

Repairs and Data

- Please be aware that all data contained in the unit’s memory may be lost when the unit is sent for repairs. Important data should always be backed up in another MIDI device (e.g., a sequencer), or written down on paper (when possible). During repairs, due care is taken to avoid the loss of data. However, in certain cases (such as when circuitry related to memory itself is out of order), we regret that it may not be possible to restore the data, and Roland assumes no liability concerning such loss of data.

Additional Precautions

- Please be aware that the contents of memory can be irretrievably lost as a result of a malfunction, or the improper operation of the unit. To protect yourself against the risk of losing important data, we recommend that you periodically save a backup copy of important data you have stored in the unit’s memory in another MIDI device (e.g., a sequencer).
- Unfortunately, it may be impossible to restore the contents of data that was stored in another MIDI device (e.g., a sequencer) once it has been lost. Roland Corporation assumes no liability concerning such loss of data.
- Use a reasonable amount of care when using the unit’s buttons, sliders, or other controls; and when using its jacks and connectors. Rough handling can lead to malfunctions.
- Never strike or apply strong pressure to the display.
- When connecting / disconnecting all cables, grasp the connector itself—never pull on the cable. This way you will avoid causing shorts, or damage to the cable’s internal elements.
- To avoid disturbing your neighbors, try to keep the unit’s volume at reasonable levels. You may prefer to use headphones, so you do not need to be concerned about those around you (especially when it is late at night).
- When you need to transport the unit, pack it in shock-absorbent material. Transporting the unit without doing so can cause it to become scratched or damaged, and could lead to malfunction.
- Do not apply undue force to the music stand while it is in use.
- Some connection cables contain resistors. Do not use cables that incorporate resistors for connecting to this unit. The use of such cables can cause the sound level to be extremely low, or impossible to hear. For information on cable specifications, contact the manufacturer of the cable.

Contents

USING THE UNIT SAFELY.....	3
IMPORTANT NOTES.....	5
Introduction.....	7
Main Features.....	7
Checking the Included Items.....	7
Assembling the DP-970.....	8
Check the Parts.....	8
Assembly Procedure.....	8
Panel Descriptions.....	10
Front Panel.....	10
Rear Panel.....	11
Before You Start Playing.....	12
Connecting the Pedal Cord.....	12
Connecting the AC Adaptor.....	12
Opening and Closing the Lid.....	12
Opening the Lid.....	12
Closing the Lid.....	13
Connecting Headphones.....	13
Using the Headphones Hook.....	14
Turning the Power On and Off.....	14
Adjusting the Sound's Volume and Brilliance.....	14
About the Pedals.....	14
Chapter 1.	
Enjoying the Internal Songs and Demo.....	15
Listening to Internal Songs.....	15
Playing Back All Songs Continuously (All Song Play).....	15
Selecting a Song and Playing It.....	15
Listening to the Demo Songs.....	17
Playing Back the Tone Demo Songs.....	17
Listening to a Demo of the Functions.....	18
Chapter 2. Performance.....	19
Performing with a Variety of Sounds.....	19
Adjusting the Keyboard Touch (Key Touch).....	20
Adding a Sense of Depth to the Sound (3D).....	21
Adding Liveliness to the Sound (Dynamic Emphasis).....	22
Applying Effects to the Sound.....	23
Adding Reverberation to the Sound (Reverb).....	23
Changing the depth of the reverb effect.....	23
Transposing the Key of the Keyboard (Transpose).....	24
Splitting the Keyboard Into Two Sections for Four-Hand Performances (Twin Piano Mode).....	25
Playing Two Sounds Together (Dual Play).....	26
Adjusting the Volume Balance in Dual Play (Dual Balance).....	26
Playing Different Tones with the Left and Right Hands (Split Play).....	27
Changing the Keyboard's Split Point.....	28
Using Metronome.....	29
Sounding the Metronome.....	29
Changing the Metronome Volume.....	30
Chapter 3.	
Playing Along with the Internal Songs.....	31
Changing the Tempo.....	31
Adding a Count-in to Match the Timing (Count-In).....	31
Playing Each Hand Separately.....	32
Chapter 4. Recording Your Performance.....	33
Notes Regarding Recording.....	33
Recording a New Song.....	34
Recording Along with a Song.....	35
Recording the Right-Hand and Left-Hand Parts Separately.....	36
Erasing Recorded Performances.....	38
Erasing a Performance from the Specified Track.....	38
Erasing a Song.....	38
Saving Recorded Songs Even with the Power Turned Off (Song Backup).....	39
Deleting backed up songs.....	39
Chapter 5. Changing Various Settings.....	40
Changing the Damper Pedal's Resonance.....	40
Making Detailed Settings (Function).....	40
Tuning to Other Instruments' Pitches (Master Tuning).....	41
Changing the Temperament.....	41
Setting the Tuning Curve (Stretch Tuning).....	42
Applying the Damper Pedal to the Left-hand Keyboard Area.....	42
Changing How 3D is Applied (3D Mode).....	43
Preventing the Settings from Changing During Performance.....	43
Disabling Everything Except Piano Play (Panel Lock).....	43
Disabling the Buttons When Using a Tone Other Than Piano (Tone Lock).....	43
Getting the Master Tune Setting To Be Remembered While the Power Is Turned Off.....	44
Using the V-LINK function.....	44
Chapter 6. Connecting External Devices.....	45
Connecting to Audio Equipment.....	45
Connecting to a Computer.....	45
Connecting MIDI Devices.....	46
What's MIDI?.....	46
Making MIDI-related Settings.....	46
MIDI Send Channel Settings.....	46
Switching Local Control on and Off.....	47
Transmitting a Performance You Recorded.....	47
Appendices.....	48
Troubleshooting.....	48
Error Messages/Other Messages.....	49
Tone List.....	50
Internal Song List.....	51
Easy Operation List.....	53
MIDI Implementation Chart.....	54
Main Specifications.....	55
Index.....	56

Introduction

Congratulations on your choice of the Roland Digital Piano DP-970.

In order to enjoy reliable performance of your new keyboard for many years to come, please take the time to read through this manual in its entirety.

Main Features

Refined Wood Grain Finish, Compact Design

The simple design and light wood grain finish is at home both in the living room as well as in the children's room. When its lid (which descends slowly and smoothly) is closed, the instrument presents a clean, flat look.

And its compact design, with a depth of only about 300 millimeters, allows it to fit in perfectly with other furniture.

Piano Tones with Rich Resonance and Broad Expression

Featuring a piano sound generator that employs stereo sampling and accurately reproduces the true sound of the piano, even down to the sound of the hammers striking the strings, this instrument provides a high-quality, concert grand piano sound.

With 64-voice polyphony, the sound generator handles the most robust performances with ease, even performances during which the pedals are used extensively.

This instrument also reproduces the concert grand piano's sonic depth (3D) along with improved clarity and power (Dynamic Emphasis).

Authentic Piano Performances

High-quality concert grand piano tones, along with a keyboard that offers a more realistic piano touch by providing a heavier feel in the low end and a lighter feel in the upper notes, combine to let you enjoy truly authentic piano performances.

The Soft pedal, Sostenuto pedal, and Damper pedal are securely attached to the piano, ensuring precision nuance in performances.

Practice Functions to Support Great Musicianship

The instrument includes not only a metronome but also a "Two-Track Recorder," which lets you record and check what you practice, along with a variety of other piano lesson features that are possible only with a digital piano.

66 Piano Songs Built-In

The 66 internal songs, featuring primarily classical pieces, also include compositions you can use for listening enjoyment as well as for lessons.

High-Performance Two-Box Speaker Construction

The lateral speaker box features two independent left and right speaker boxes, providing superior volume and sonic quality beyond what one would expect for this class of instrument.

The speakers can also be directed rearward if conditions require.

Perform in Comfort, Even with Headphones

A special effect is applied when headphones are used allowing you to listen to sounds comfortably and without getting fatigued. In addition, the DP-970 also features a panel lamp that lights to indicate when headphones are connected and a headphone hook on which to place the headphones when they are not in use.

Checking the Included Items

Check to see if you have all of the items that normally are supplied with the DP-970.

If any items are missing, please contact the dealer where you purchased this unit.

DP-970 (For installing the DP-970, refer to p. 8)

- Side Board right
- Side Board left
- Speaker Box
- Pedal Board
- Stabilizer x 2
 - Stabilizer screw x 6
- Attachment screw x 8

Cord Clamp x 4

AC Adaptor (DC 9V), Power Cord

Headphones hook

Owner's manual (this document)

Assembling the DP-970



Make sure that another person is on hand to help with the assembly and setup. To move the piano, lift it carefully—all the while keeping it level. Be very careful, when you assemble and move the piano, to make sure that you do not drop it on your hands or feet. Should you remove screws, cord clamps, or stabilizer, make sure to put them in a safe place out of children's reach, so there is no chance of them being swallowed accidentally.

Check the Parts

Before you begin assembling the DP-970, check that all the parts were supplied. You will also need to have a Phillips screwdriver.

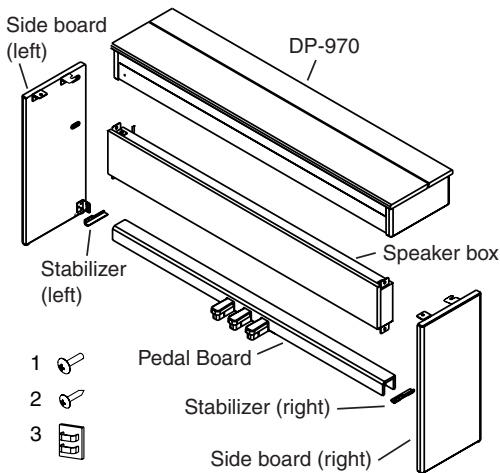

- 1: Attachment screw (M6 x 20mm) x 8
- 2: Stabilizer screw (M4 x 16mm) x 6
- 3: Cord clamp x 4

MEMO

The speaker box can also be installed so that it faces toward the rear instead of toward the front. Having the speaker box face out the rear of the instrument allows the speakers to be directed toward listeners when the back of the instrument faces the audience.

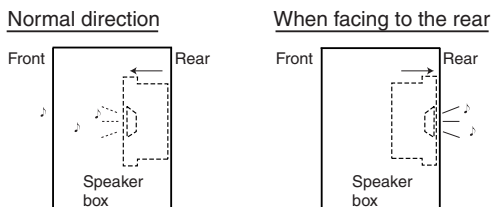

Assembly Procedure

- At first, assemble the entire unit in a temporary fashion, without really tightening the screws. Then, after checking the overall alignment of the boards (and gently shifting certain parts where necessary), go around and tightly fasten each of the screws.
- Be careful when assembling the DP-970, so as to avoid scratching the side boards.

When securing the screws, lay the entire unit sideways with the rear side of the DP-970 at the bottom.

1. Secure the left side board to the speaker box with the attachment screws (in two places). Attach so that the speaker cord at the rear of the speaker box is directed to the right.
2. Secure the right side board to the speaker box with the attachment screws (in two places).

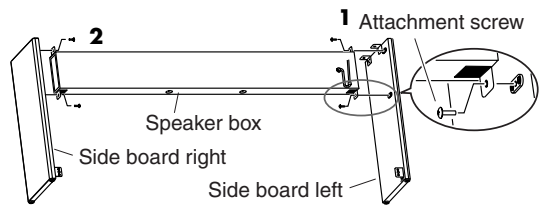

3. Set the stabilizer in the holes in the side boards (in six places).

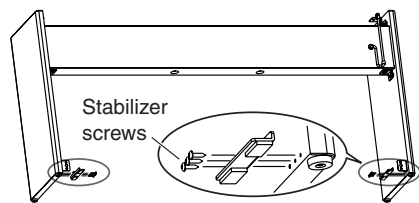

Take care not to attach the left and right stabilizer to the wrong sides.

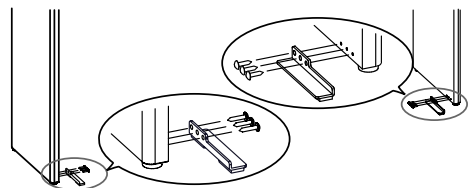

4. Raise the entire assembly. When standing the assembled unit up, grasp near the speaker box, and gently raise the assembly.

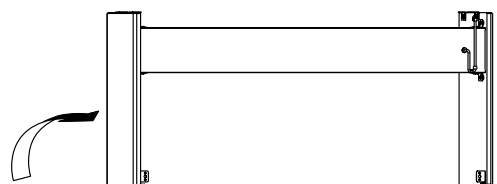

5. Put the Pedal Board on the stabilizer.

When putting the Pedal Board on the stabilizer, first loosen the attachment screws securing the speaker box to the side boards.

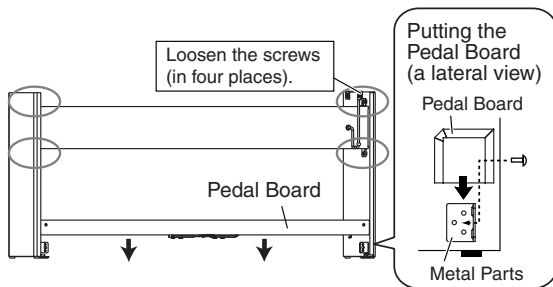

6. Secure the Pedal Board to the side boards with the attachment screws (in two places).

Re-tighten the screws loosened in Step 5.

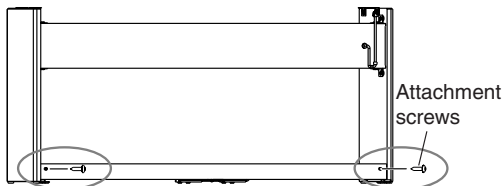

To stabilize the pedals

Temporarily loosen the screws that fasten the pedal board. Step on the pedal, and after verifying that the pedal is in firm contact with the floor, re-tighten the attachment screws firmly.

7. Align the protruding screws (one each at right and left) on the bottom of the piano with the openings in the metal fittings on the side board, then slide the piano forward until the screws are held in place.

* When handling the piano, firmly grasp it at the front and back. Be careful, so you do not get your fingers pinched. Place the keyboard so that it is centered, both front to back and left to right.

8. Fasten the piano to the stand with the attachment screw (one each for the right and left).

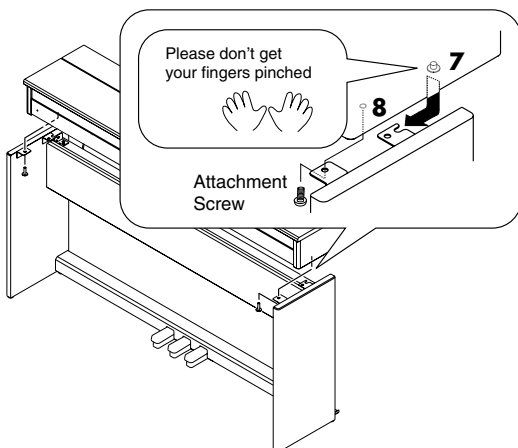

9. Connect the speaker cord extending from the rear of the speaker box to the DP-970's speaker connector.

Press the speaker cord completely into the connector so that it is securely fastened.

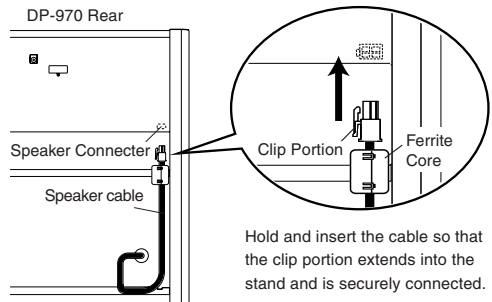

* Use the speaker cable with the ferrite core left attached to the cable. The DP-970 cannot be used with the ferrite core removed.

10. Connect the pedal cords to the Pedal jack.

11. As necessary, affix cord clamps as shown in the diagram to fasten the pedal cord.

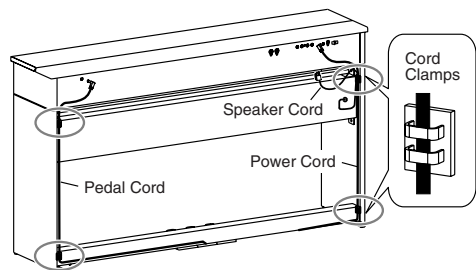

When Moving the Instrument

Disconnect the AC cord and cables from the DP-970. Then lift the piano while keeping it level, and move it with care, so that you do not drop it on your feet, or get your hands caught. Check the stability of the pedal, and make adjustments as necessary.

When Disassembling

Disassemble the unit by carrying out assembly Steps 1-11 in reverse order.

When Changing the Orientation of the Speaker Box

Be sure to completely disassemble the unit, change the speaker box orientation, then reassemble it.

Panel Descriptions

Front Panel

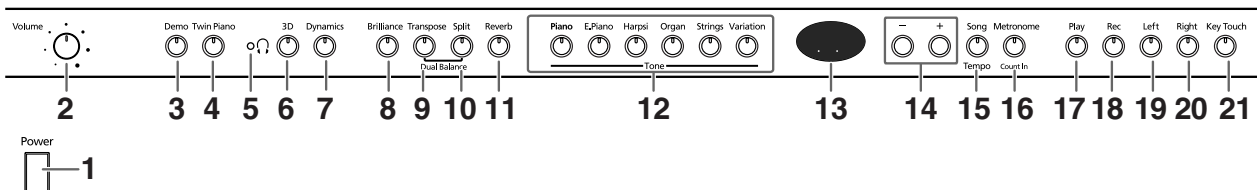

1 [Power] switch

Turns the power on/off (p. 14).

2 [Volume] knob

Adjusts the overall volume level (p. 14).

3 [Demo] button

You can listen to a demo of the instrument's tones as well as a demo of the various functions (p. 17).

4 [Twin Piano] button

You can divide the keyboard into two separate sections, allowing two people to perform in the same registers (p. 25).

5 [🎧 (Headphones)] indicator

This indicator lights up when headphones are connected to the headphones jack (p. 17).

6 [3D] button

Adds a sense of depth to the sound (p. 21).

7 [Dynamics] button

You can add liveliness to the sound to give it superb clarity and distinctness (p. 22).

8 [Brilliance] button

Adjusts the tone brightness (p. 14).

9 [Transpose] button

Transposes the pitch of the keyboard (p. 24).

10 [Split] button

Divides the keyboard into right-hand and left-hand areas, allowing you to play a different sound in each area (p. 27). By holding down this button and the [Reverb] button, and pressing other specified button, you can make settings for various functions (p. 40–p. 44, p. 46–p. 47).

11 [Reverb] button

Adds reverberation to the sound (p. 23).

12 Tone buttons

They are used to choose the kinds of tones (tone groups) played by the keyboard (p. 19).

13 Display

The display indicates values for various settings, including the tone variation, song number, and tempo. Usually these will appear as in the figure above.

14 [-] [+] buttons

Allow you to select the value of various settings. Pressing both the [-] and [+] buttons simultaneously returns the setting of a particular item or function to its original value.

15 [Song/Tempo] button

Used to select from the internal songs (p. 15, p. 31). Each time you press this button, the song number and the tempo will be displayed alternately. While the song number is displayed, the button indicator will light in red. While the tempo is displayed, it will light in green.

16 [Metronome/Count In] button

Turns the metronome on/off (p. 29). Also featured is the count-in sound, which can be played before the song starts, allowing you to begin playing with the song with perfect timing (p. 31).

Recorder

17 [Play] button

Starts and stops playback of internal songs and recorded performances (p. 15, p. 35). Also starts/stops recording of a performance (p. 34–p. 36).

18 [Rec] button

Puts the DP-970 in recording-standby mode (p. 33–p. 38).

19 [Left] button

Plays back or records a performance separately for each hand (p. 32, p. 35–p. 38). The left-hand performances of the internal songs are assigned to this button.

20 [Right] button

Plays back or records a performance separately for each hand (p. 32, p. 35–p. 38). The right-hand performances of the internal songs are assigned to this button.

21 [Key Touch] button

Modifies the playing feel of the keyboard (p. 20).

Rear Panel

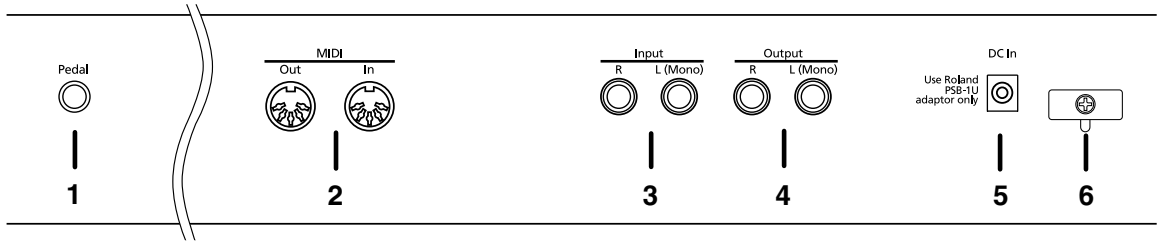

1 Pedal jack

Connect the pedal cord of the pedal board to this jack (p. 12).

2 MIDI Out/In connectors

Connect to external MIDI devices to exchange performance data (p. 46).

3 Input jacks

These jacks can be connected to another sound generating device or an audio device, so that the sound of that device will be output from the DP-970's speakers (p. 45).

4 Output jacks

Allows you to output the piano's sound to sound reinforcement equipment to obtain a more powerful sound. These can also be connected to a tape recorder or other recording device to record a performance (p. 45).

5 DC in jack

Connect the supplied AC adaptor here.

6 Cord hook

Use this to fix in place the cord from the supplied AC adaptor (p. 12).

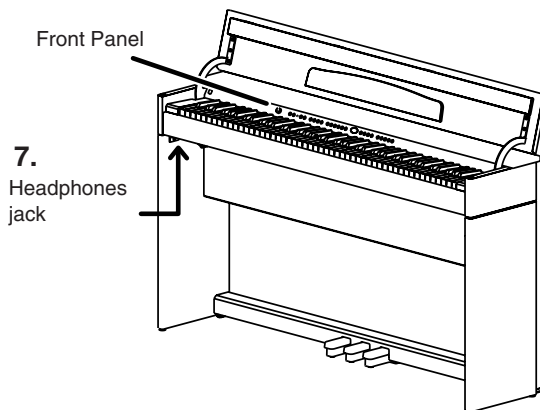

7 Headphones jacks

A set of headphones can be connected here (p. 13).

8 Speaker jacks

Connect the speaker cord of the speaker box to this jack (p. 9).

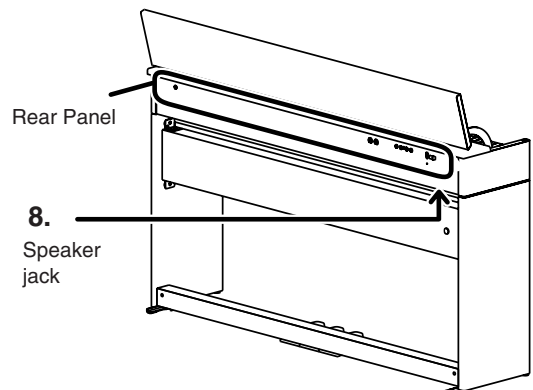

Before You Start Playing

Connecting the Pedal Cord

1. Connect the pedal cord to the Pedal jack on the rear panel of DP-970, at the rear.

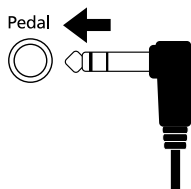

Connecting the AC Adaptor

NOTE

To prevent malfunction and/or damage to speakers or other devices, always turn down the volume, and turn off the power on all devices before making any connections.

1. Connect the supplied AC adaptor and AC cord.



2. Connect the AC adaptor to the DC In jack on the rear panel.
3. As shown in the diagram, loop the AC adaptor cord around the cord hook to fasten it in place.

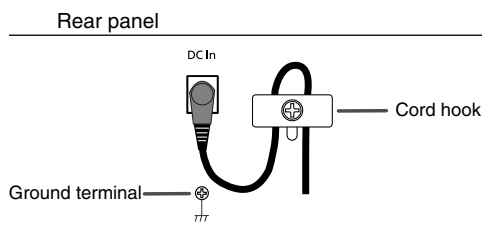

4. Plug the Power cord into a power outlet.

If necessary, secure the AC adaptor cord with the cord clamps (p. 9).

NOTE

To prevent the inadvertent disruption of power to your unit (should the plug be pulled out accidentally), and to avoid applying undue stress to the AC adaptor jack, anchor the power cord using the cord hook, as shown in the illustration above.

Even if the cord is fastened, strong tension applied to the cord may cause it to be damaged or broken. Be careful not to pull the cord accidentally, or to apply strong pressure to it.

NOTE

Depending on the circumstances of a particular setup, you may experience a discomforting sensation, or perceive that the surface feels gritty to the touch when you touch this device or the metal portions of other objects connected to it. This is due to an infinitesimal electrical charge, which is absolutely harmless. However, if you are concerned about this, connect the ground terminal (see figure) with an external ground. When the unit is grounded, a slight hum may occur, depending on the particulars of your installation. If you are unsure of the connection method, contact the nearest Roland Service Center, or an authorized Roland distributor, as listed on the "Information" page.

Unsuitable places for connection

- Water pipes (may result in shock or electrocution)
- Gas pipes (may result in fire or explosion)
- Telephone-line ground or lightning rod (may be dangerous in the event of lightning)

Opening and Closing the Lid

NOTE

Always use two hands to open and close the lid. Although the DP-970's lid is designed to close slowly and gently when it is released, the lid immediately closes if it has been opened only slightly. Take care not to allow your fingers to become pinched by the lid.

Opening the Lid

1. Grasp and lift the lid with both hands.

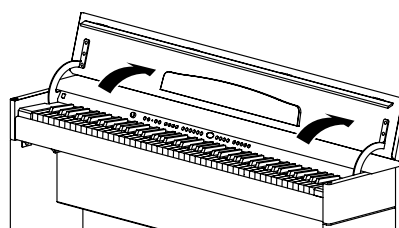

2. Close the blind and open the music rest as shown in the figure.

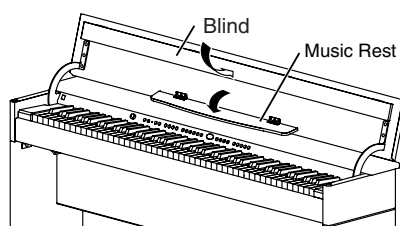

■ Closing the Lid

1. When closing the lid, be sure to close the music rest and open the blind.

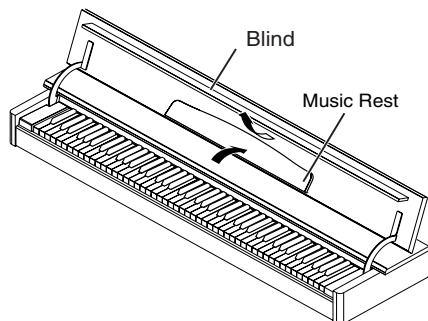

2. Grasp and gently lower the lid with both hands.

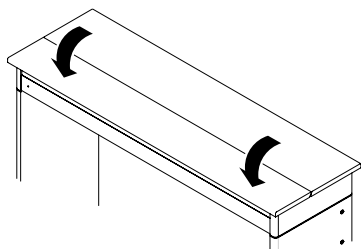

NOTE

Adult supervision is recommended whenever small children use the unit.

NOTE

If you need to move the piano, make sure the lid is closed first to prevent accidents. In addition, do not hold onto the lid when moving or setting up the instrument.

NOTE

When opening and closing the lid, take care not to allow your fingers to become pinched in the gap.

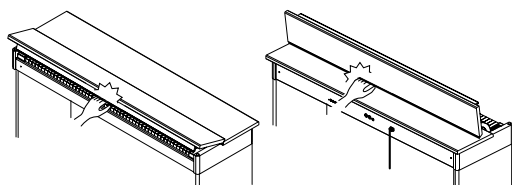

Connecting Headphones

The DP-970 has two jacks for plugging in headphones. This allows two people to listen through headphones simultaneously, making it very useful for lessons and when performing piano pieces for four hands. Additionally, this allows you to play without having to worry about bothering others around you, even at night.

If using only one pair of headphones, you can connect them to either of the two headphone jacks.

Plug the headphones into the Headphones jack located at the bottom left of the piano.

When headphones are connected, the [Headphones] indicator (p. 10) lights up, and sounds stop playing from the speakers of the DP-970.

The headphones volume is adjusted by the [Volume] knob (p. 14) of the DP-970.

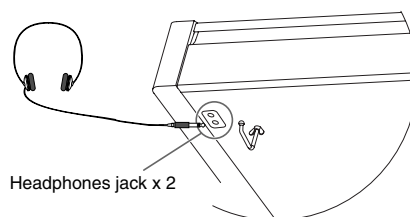

NOTE

Use Stereo headphones.

Some notes on using headphones

- To prevent damage to the cord, handle the headphones only by the headset or the plug.
- Connecting the headphones when the volume of connected equipment is turned up may result in damage to the headphones. Lower the volume on the DP-970 before plugging in the headphones.
- Listening at excessively high volume levels will not only damage the headphones, but may also cause hearing loss. Use the headphones at a moderate volume level.

Before You Start Playing

■ Using the Headphones Hook

Whenever you are not using the headphones, you can hang them on the headphones hook at the lower left of the DP-970.

Attaching the Headphones Hook

Press and twist the headphones hook included with the DP-970 into the hole in the bottom of the DP-970 (refer to the figure below). Turn the wing nut of headphones hook to secure the headphone hook.

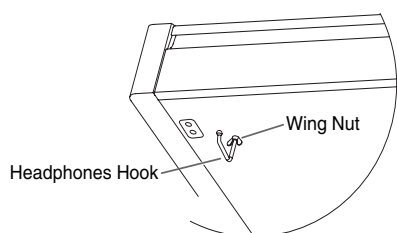

Turning the Power On and Off

NOTE

Once the connections have been completed, turn on power to your various devices in the order specified. By turning on devices in the wrong order, you risk causing malfunction and/or damage to speakers and other devices.

To turn the power on, turn the [Volume] knob all the way down, and then press the [Power] switch.

The power will turn on, and the following display will appear.



After a few seconds, you will be able to play the keyboard to produce sound.

Use the [Volume] knob to adjust the volume.

NOTE

This unit is equipped with a protection circuit. A brief interval (a few seconds) after power up is required before the unit will operate normally.

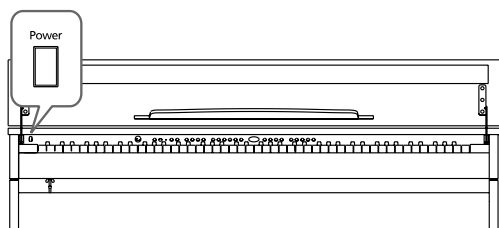

To turn the power off, turn the [Volume] knob all the way to the left, and press the [Power] switch.

Adjusting the Sound's Volume and Brilliance

Turn the [Volume] knob to adjust the overall volume.

Press the [Brilliance] button to adjust the brightness of the sound.

Select one of the three available settings to obtain the desired brilliance.

[Brilliance] button's indicator	Off	Lit in red	Lit in green
Brilliance	Medium	Mellow	Bright



About the Pedals

The pedals have the following functions, and are used mainly for piano performance.

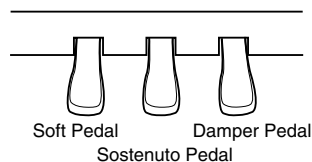

Damper pedal (right pedal)

While this pedal is pressed, notes will be sustained even after you take your fingers off the keys.

On an acoustic piano, holding down the damper pedal will allow the remaining strings to resonate in sympathy with the sounds that you played from the keyboard, adding a rich resonance.

The DP-970 simulates this damper resonance.

→ You can change the amount of resonance applied with the damper pedal. Please refer to "Changing the Damper Pedal's Resonance" (p. 40).

Sostenuto pedal (center pedal)

This pedal sustains only the sounds of the keys that were already played when you pressed the pedal.

Soft pedal (left pedal)

When you hold down this pedal and play the keyboard, the sound will have a softer tone.

Chapter 1. Enjoying the Internal Songs and Demo

Listening to Internal Songs

The DP-970 comes with 66 piano songs onboard.

■ Playing Back All Songs Continuously (All Song Play)

The internal songs can be played back consecutively.



“Chapter 3. Playing Along with the Internal Songs” (p. 31)

“Internal Song List” (p. 51)

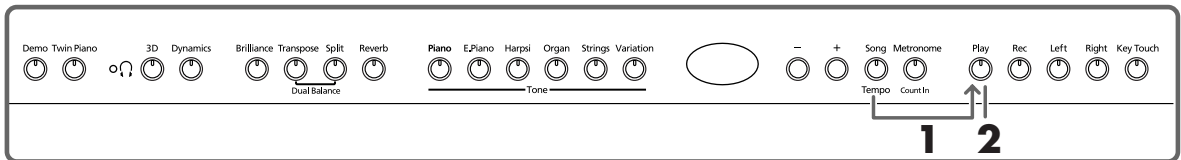

1 Hold down the [Song/Tempo] button, and press the [Play] button.

The [Song/Tempo] button's indicator will light in red, the [Play] button's indicator will blink, and the songs will play back successively, starting with the currently selected song.

The song number appears in the display for several seconds.



You can press the [-] or [+] button to select the song that you want to play back. When all songs have been played, playback will return to the first song and resume.

Stopping the playback

2 Press the [Play] button.

Playback will stop.

■ Selecting a Song and Playing It

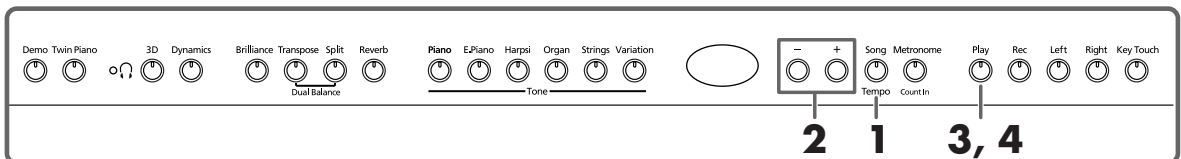

Choosing the song to play back

1 Press the [Song/Tempo] button, getting its indicator to light in red.

The song number appears in the display for several seconds.



2 Press the [-] or [+] button to select a song.

Holding down the button causes the numbers to change continuously.



When you play back an internal song, the reverb effect will automatically be turned on (the button's indicator lights).

Playing back

3 Press the [Play] button.

The button's indicator will light, and the selected song will play.

Stopping the playback

4 Press the [Play] button.

The button's indicator goes out, and playback stops.

The next time you press the [Play] button, the song that was stopped is played from the beginning.

■ About the display for the internal songs

Display	Descriptions
S. U	Songs saved with Song Backup (p. 39).
USr (user)	The location where you can record your performance. (For details on recording → p. 34)
Numbers with a "S."	Internal songs.

* You can select "S.U" when executing Song Backup.
Select "USr" then press the [-] button.

Listening to the Demo Songs

You can listen to various demo songs, including those demonstrating the piano and other tones, as well as the function applied to the piano tones.

■ Playing Back the Tone Demo Songs

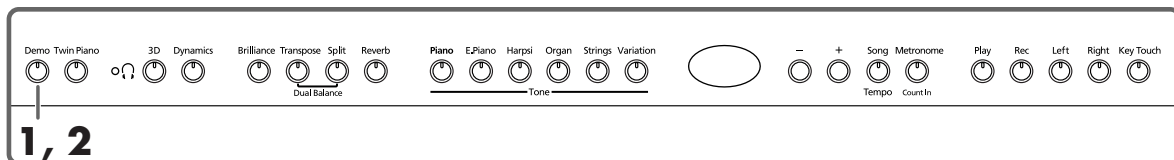

1 Press the [Demo] button.

The button's indicator flashes, and playback of the tone demo songs starts.



When playback of the last song is finished, playback then returns to the first song.

When you press any of the tone buttons, or the [Twin Piano] button, or the [Split] button while the [Demo] button is flashing, the demo song corresponding to that button is played.

Button assigned tone demo	Demo content	Composer	Copyright
[Piano]	Piano tone demo songs	Adrian Scott	© 2005 Roland Corporation
[E. Piano]	E. Piano tone and Vibraphone tone demo songs		
[Harpsi]	Harpsichord tone demo songs		
[Organ]	Organ tone demo songs		
[Strings]	Strings tone and Jazz scat tone demo songs		
[Twin Piano]	Demo songs using the Twin Piano function (p. 25)		
[Split]	Demo songs using the Split function (p. 27)		



No data for the music that is played will be output from MIDI OUT.

Stopping the Tone Demo Songs

2 Press the [Demo] button.

The [Demo] button's indicator goes off, and the demo quits.

Chapter 1. Enjoying the Internal Songs and Demo

■ Listening to a Demo of the Functions

You can listen to the demo of the functions that can be applied to the piano tones.

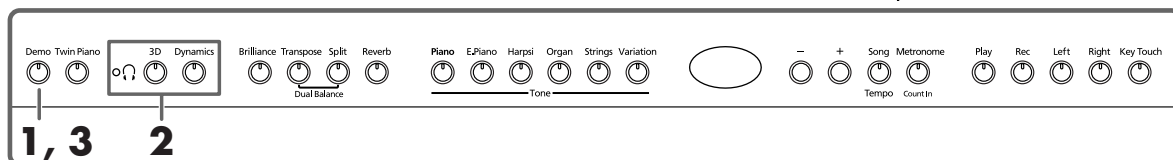

1 Press the [Demo] button.

The button's indicator flashes, and playback of the demo of the function starts.

2 Press any of the following buttons.

Button assigned function demo	Demo content	Page
[3D]	3D demo	p. 21
[Dynamics]	Dynamic Emphasis demo	p. 22

When a button is pressed, the demo assigned to the button is played. Two versions of the demo will be played—one includes the function provided by the button you've pressed, the other doesn't.



Stopping the Demo of the Functions

3 Press the [Demo] button.

The [Demo] button's indicator goes off, and the demo quits.



When you press the button pressed in Step 2, you can switch between demos both with the function switched on and off.

Chapter 2. Performance

Performing with a Variety of Sounds

The DP-970 contains 20 different internal tones. The tones are organized into five tone groups, which are assigned to the Tone buttons.

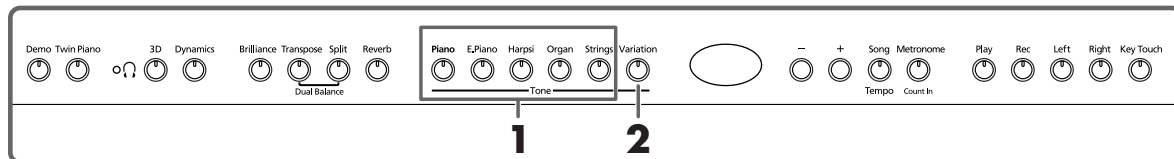

Selecting a tone group

- 1 Press any **Tone** button.

The indicator of the button you pressed will light.

When you play the keyboard, you will hear a sound in the selected tone group.

Selecting variation tones

- 2 Press the [**Variation**] button.

Four different tones (numbered 1–4) are assigned to each Tone button. Use the [**Variation**] button to select among them.

Each time you press the [**Variation**] button, the button's indicator will change color, and the four sounds will be selected successively.

Tone number	1	2	3	4
[Variation] button's indicator	Dark	Red	Green	Orange

Some of the number 3 and 4 tones form pairs, which can be layered and sounded together.

The tone you've selected is heard when you finger the keyboard.



For more details, refer to "Tone List" (p. 50).



When Dual play (p. 26) or Split play (p. 27) is used, only sound number 1 or 2 can be selected. If you use Dual play or Split play with a Tone button for which tone number 3 or 4 is selected, tone number 1 will be selected for that Tone button.

Adjusting the Keyboard Touch (Key Touch)

You can adjust the touch (playing feel) of the keyboard.

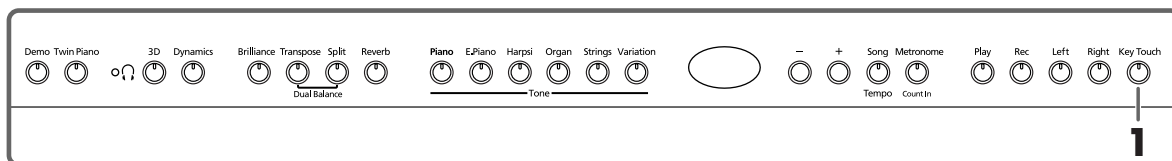

1 Press the [Key Touch] button.

The button's indicator will light, and the feel of the keyboard will change.

Each time you press the [Key Touch] button, the button's indicator will change color, and the feel of the keyboard will change.

Indicator	Settings	
OFF	Medium	This allows you to play using the most natural touch. This is the closest to the touch of an acoustic piano.
Red	Heavy	Fortissimo (ff) cannot be produced unless you play more strongly than usual, making the keyboard feel heavier. Dynamic fingering adds even more feeling to what you play.
Green	Light	Fortissimo (ff) can be produced by playing less strongly than usual, making the keyboard feel lighter. This setting makes it easy to play, even for children.
Orange	Fixed	Sounds at a fixed volume, regardless of your keyboard playing strength.

Adding a Sense of Depth to the Sound (3D)

The DP-970 includes a “3D” function that allows you to get sounds that have a sense of depth like you get by playing an acoustic grand piano. This feature creates an ambience that makes it seem you are seated in front of a grand piano as you perform.

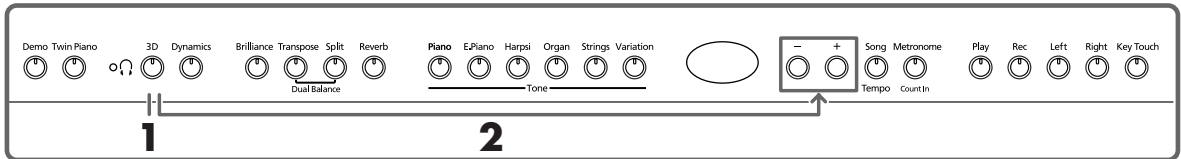

1 Press the [3D] button, getting its indicator to light.

The 3D function is switched on, giving the sound a greater sense of depth.

To cancel the 3D function, press the [3D] button once more so its illumination is turned off.

Adding the Right Sense of Depth for Headphones (3D)

You can achieve the kind of sonic depth produced with a grand piano through headphones as well. Using this function gives you the natural-sounding reverberation and depth of sound that an acoustic grand piano provides.

Changing the 3D Settings

2 Hold down the [3D] button, and press the [-] or [+] button.

You can adjust the sense of depth to any of four levels.

A greater sense of depth is produced as the value is increased.



MEMO

The [] (Headphones) indicator lights up when headphones are connected.

MEMO

With the 3D function, the method used in adding depth to the sound changes depending on whether or not headphones are connected. You can change this setting. For more details, refer to “3D mode (p. 43).”

MEMO

When you continue holding the [3D] button, the currently specified settings will be displayed.

Adding Liveliness to the Sound (Dynamic Emphasis)

You can add liveliness to the sound to give it superb clarity and distinctness.

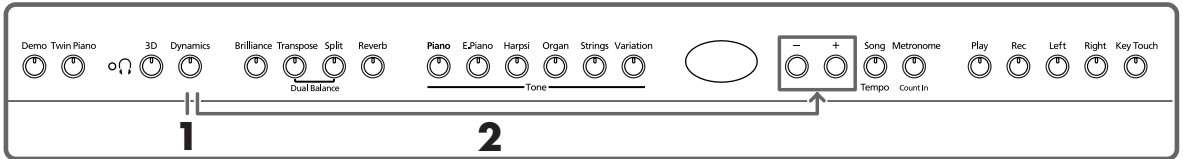

1 Press the [Dynamics] button, getting its indicator to light.

The Dynamic Emphasis function is switched on, enlivening the sound.

To cancel the Dynamic Emphasis function, press the [Dynamics] button once more so its illumination is turned off.

Changing the Dynamic Emphasis Settings

2 Hold down the [Dynamics] button, and press the [-] or [+] button.



Display	Description
1	Creates a sound with boosted bass and treble.
2	Produces a sound with chords in the low registers that are clear and distinct.
3	Creates a sound with boosted bass.

MEMO

When you continue holding the [Dynamics] button, the currently specified settings will be displayed.

Applying Effects to the Sound

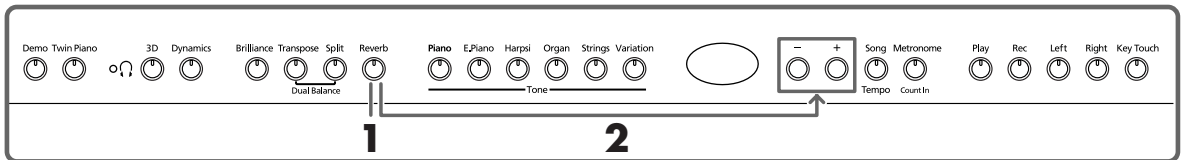

■ Adding Reverberation to the Sound (Reverb)

By applying the reverb effect you can produce a pleasant reverberation, making it sound as though you were performing in a concert hall.

1 Press the [Reverb] button.

The button's indicator will light, and a reverb effect will be applied to the sound.

To cancel the reverb effect, press the [Reverb] button, getting its indicator to go dark.

■ Changing the depth of the reverb effect

The amount (depth) of the reverb effect can be set to any of eight levels.

2 Hold down the [Reverb] button and press the [-] or [+] button.

The currently specified value will be displayed.

Higher values will produce a deeper effect.



MEMO

When you play back an internal song, the reverb effect will automatically be turned on (the button's indicator lights).

MEMO

When the power is turned on, reverb is set to "4."

MEMO

When you hold down the [Reverb] button, the currently specified reverb depth value will be displayed.

Transposing the Key of the Keyboard (Transpose)

By using the “Transpose function,” you can transpose your performance without changing the notes you play. For example, even if the song is in a difficult key with numerous sharps (\sharp) or flats (\flat), you can transpose it to a key that is easier for you to play.

When accompanying a vocalist, you can easily transpose the pitch to a range that is comfortable for the singer, while still playing the notes as written (i.e., with the same fingering positions).

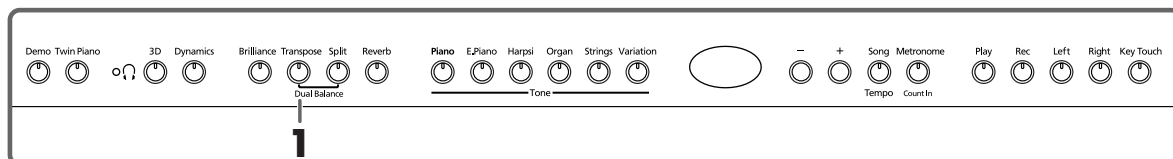

1 Continue to hold down the [Transpose] button, and press a note to indicate the tonic of the key to which you want to transpose.

The button’s indicator will light, and the keyboard will be transposed.

You can also transpose by holding down the [Transpose] button and pressing the [-] or [+] button.

If you hold down the [Transpose] button and press the [-] and [+] buttons simultaneously, the setting will return to the original value (0).

This can be set in a range of -6–0–5 (semitone steps).

For example, if you want the E pitch to sound when you play the C key, hold down the [Transpose] button and press the E key.

Counting from C as a reference point, one moves up four keys, including the black keys, to reach E, thus “4” appears in the display.

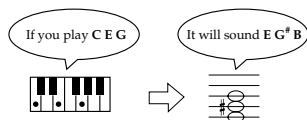

When the transpose value is set to “0,” the button’s indicator will remain dark even if you press the [Transpose] button.

To cancel the transpose function, press the [Transpose] button, extinguishing its indicator.

When you press the [Transpose] button once again, getting its indicator to light, the keyboard will be transposed to the note you specified here.

MEMO

When you hold down the [Transpose] button, the currently specified value will be displayed.

MEMO

This setting returns to the original value (0) when you turn off the power.

Splitting the Keyboard Into Two Sections for Four-Hand Performances (Twin Piano Mode)

You can divide the keyboard into two separate sections, allowing two people to perform in the same registers.

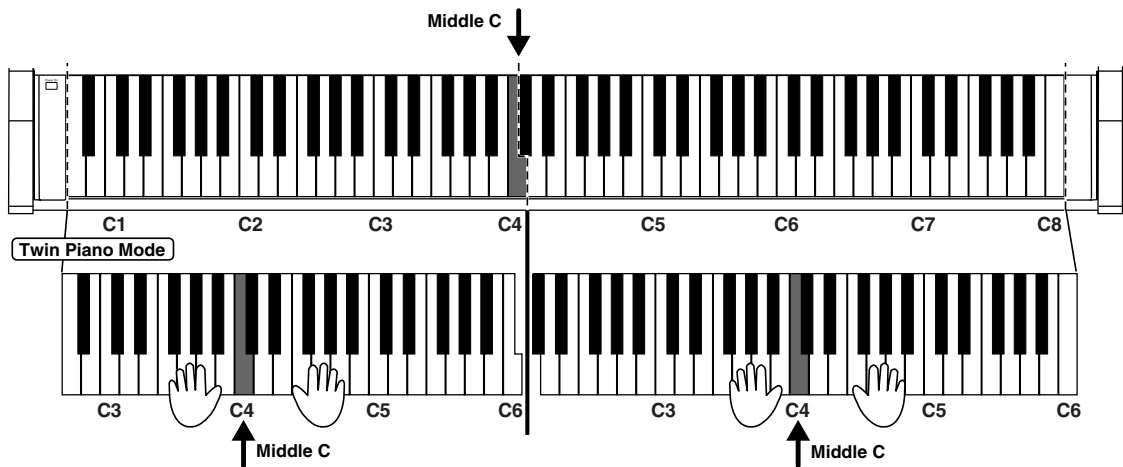

1 Press the [Twin Piano] button.

The [Twin Piano] button and the [Split] button's indicator will blink.

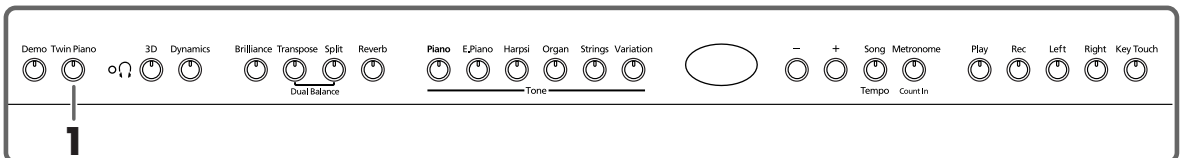

The following occur when Twin Piano Mode is switched on:

- The keyboard is divided into two separate sections, and the pitch changes.
- The grand piano tone is sounded by both the left and right sections of the keyboard, and the same effect settings are used for both.
- The right pedal now functions as the damper pedal for the right keyboard section, and the left pedal functions as the damper pedal for the left keyboard section.
- The center pedal now functions as the Sostenuto pedal for the right keyboard section.
- If recording is in progress or the instrument is in recording standby, recording is stopped or recording standby is cancelled. The [Rec] button is disabled while Twin Piano Mode is active.
- If the Split function happens to be on, it is switched off.

2 To exit the function, press the [Twin Piano] button.



The Damper Resonance function is disabled while Twin Piano Mode is active.



Tones and effects can be switched while Twin Piano Mode is active. In that case, the same tone or effect is set for both the left and right sections.

Playing Two Sounds Together (Dual Play)

Simultaneously playing two tones when one key is pressed is called “Dual play.”

- 1 Simultaneously press the two Tone buttons that you want to play together.

The indicator of the button you pressed will light.

When you play the keyboard, the tones of the two Tone buttons you selected will sound simultaneously.

To cancel Dual play, press any Tone button.

To change the tone of the right button of the two selected tones

Press the [Variation] button.

Dual play now features the tone of the left side’s tone button along with the newly selected tone.

To change the tone of the left button of the two selected tones

Cancel the Dual play, and then re-select the tone.

■ Adjusting the Volume Balance in Dual Play (Dual Balance)

You can change the volume balance between the two layered sounds in Dual play.

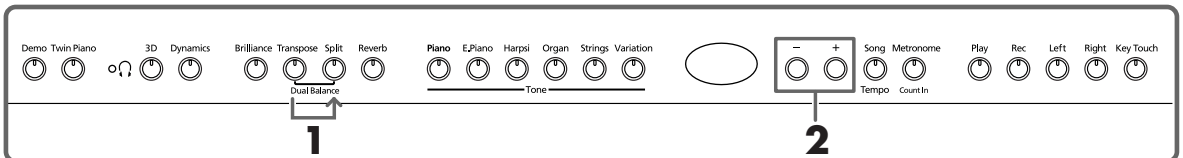

- 1 Hold down the [Transpose] button and press the [Split] button.

The indicators of the buttons you pressed will blink.

The current volume balance appears in the display.

- 2 Press the [-] or [+] button to change the value.

The volume balance changes.

To return to the original volume balance, press the [-] and [+] buttons simultaneously.



Volume of the left button tone Volume of the right button tone

Press the [Transpose] or [Split] button, and the buttons’ indicator will return to the previous state.



When Dual play is used, the [Variation] button’s indicator will light to indicate the selection of the right button of the two selected tones.



When Dual play is used, only sound number 1 or 2 can be selected.

If you use Dual play with a Tone button for which tone number 3 or 4 is selected, tone number 1 will be selected for that Tone button.



This setting returns to the original value when you turn off the power.

Playing Different Tones with the Left and Right Hands (Split Play)

Dividing the keyboard into right-hand and left-hand areas, then playing different sounds in each is called “Split play.” The boundary key is called the “split point.”

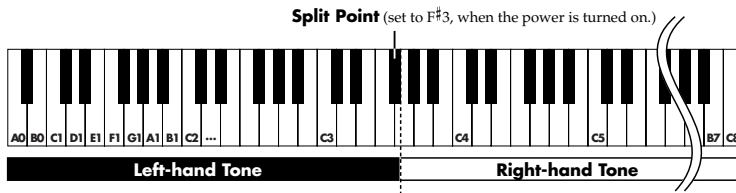

The split point key is included in the left-hand keyboard area.



In Split play, the damper pedal will be applied only to the right-hand area of the keyboard. If you want the damper pedal to be applied to the left-hand area, refer to “Applying the Damper Pedal to the Left-hand Keyboard Area” (p. 42).

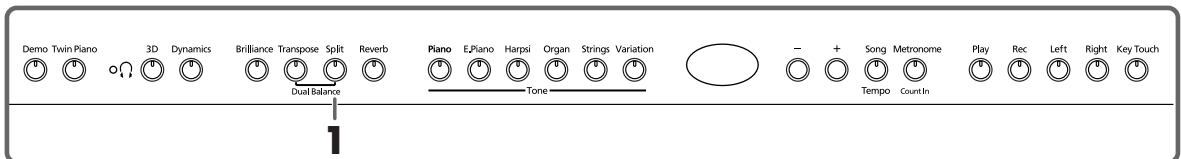

1 Press the [Split] button.

The button’s indicator will light.

The keyboard is divided into right-hand and left-hand areas.

The tone played on the right side is the tone in use before the [Split] button is pressed, while the bass tone is played on the left side.

To cancel Split play, press the [Split] button, getting its indicator to go dark.

Changing tone played by the left hand

Press the [Variation] button.

Each time you press the [Variation] button, the button’s indicator will change color, and the left-hand tone will change.

Some tones assign the tone that had been selected before you pressed the [Split] button to the left hand area of the keyboard.

Changing tone played by the right hand

Press the Tone button.

The tone of the right-hand area will change. A tone that is a suitable match for the right-hand tone will be selected for the left-hand area.

If you want to change the variation for the right-hand tone, cancel Split play and then re-select the tone.



When using Dual play, press the [Split] button

The right hand will play the tone of the left button of Dual play, and the left hand will play a suitable match for the right-hand tone.



When Split play is used, only tone numbers 1 or 2 can be selected.

If you use Split play with a Tone button for which tone numbers 3 or 4 selected, tone number 1 will be selected for that Tone button.



For information about the tones that can be selected for the left hand section, refer to the “Tone List” (p. 50).



The selected left hand tone is remembered for each Tone button. When you turn off the power, it will return to the original setting.

■ Changing the Keyboard's Split Point

You can change the location where the keyboard is divided (the split point) within the range of B1 through B6.

- 1** While continuing to hold the [Split] button, press the key that you want to specify as the split point.

The key you pressed becomes the split point, and belongs to the left-hand section of the keyboard.

You can also change the setting by pressing the [-] or [+] button while continuing to hold down the [Split] button.

If you hold down the [Split] button and simultaneously press the [-] and [+] buttons, the setting will return to its original value (F#3).



MEMO

The setting is at "F#3" when the piano is powered up.

MEMO

The split point key is displayed as follows.

Display	C	C ⁻	d	E ₋
Letter name	C	C#	D	E _b
Display	E	F	F ⁻	G
Letter name	E	F	F#	G
Display	A ₋	A	b ₋	b
Letter name	A _b	A	B _b	B

MEMO

When you continue holding the [Split] button, the currently specified split point will be displayed.

Using Metronome

■ Sounding the Metronome

The DP-970 features a built-in metronome.

While a song plays back, the metronome will sound at the tempo and time signature (Beat) of that song.

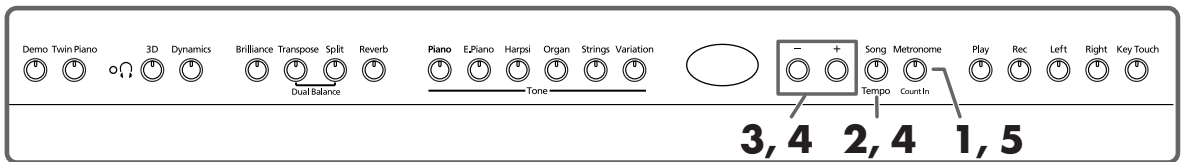

Sounding the metronome

- 1 Press the [Metronome/Count In] button.

The metronome will sound.

The button flashes in red and green in time with the beat selected at that time. The button lights in red on the downbeats, and in green on weak beats.

Changing the tempo

- 2 Press the [Song/Tempo] button; the button's indicator lights in green.
- 3 Press the [-] or [+] button to adjust the tempo.

Changing the beat of metronome

- 4 Hold down the [Song/Tempo] button, and press the [-] or [+] button.

The currently selected beat will be displayed.

If you hold down the [Song/Tempo] button and press the [-] or [+] button, the beat will change.

If you hold down the [Song/Tempo] button and press the [-] and [+] buttons simultaneously, the beat will go back to what it was before you changed it.



Display	beat	Display	beat
2.2	2/2	6.4	6/4
0.4	Only weak beats	7.4	7/4
2.4	2/4	3.8	3/8
3.4	3/4	6.8	6/8
4.4	4/4	9.8	9/8
5.4	5/4	12.8	12/8

NOTE

It is not possible to change the beat during song playback or recording.

MEMO

When you hold down the [Song/Tempo] button, the currently specified metronome beat will be displayed.

MEMO

Correspondence between beat and tempo display

Beat	Tempo Value
2/2	♩ = 10–125
x/4	♩ = 20–250
x/8	♩ = 40–500

Chapter 2. Performance

Stopping the metronome

- 5 Once again press the [Metronome/Count In] button, getting the button to go dark.

The metronome will stop.

■ Changing the Metronome Volume

The volume of the metronome can be adjusted, with nine volume levels available.

- 1 Hold down the [Metronome/Count In] button and press the [-] or [+] button.

The currently specified volume will be displayed.

Continue to hold down the [Metronome/Count In] button, and press the [-] or [+] button to sound the metronome, and change the volume.



MEMO

This is set to "4" when the instrument is turned on.

MEMO

When you hold down the [Metronome/Count In] button, the currently specified metronome volume will be displayed.

NOTE

When the metronome volume is set to "0," the metronome sound does not play.

Chapter 3. Playing Along with the Internal Songs

Here's how you can play along with the internal songs.

You can slow down the playback tempo of the song, or play back each hand separately.

Before you try playing the song, listen to it several times to get a general feel for the song.

For details on operation, refer to "Selecting a Song and Playing It" (p. 15).

Changing the Tempo

If the song has a rapid tempo, you can slow down the tempo so that you can practice it more easily. It is effective to gradually raise the tempo as you practice.



If you turn on the metronome while the song plays back, the metronome will sound at the beat and tempo of the song.



Some of the internal songs have tempos that change during the song.

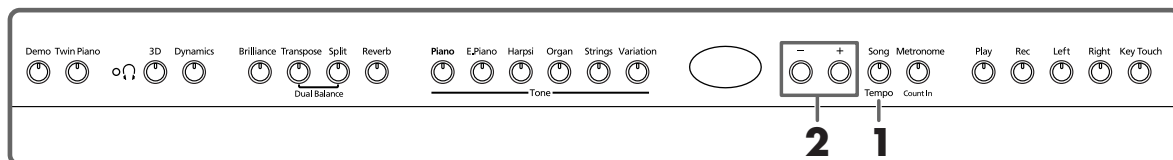

First select the song that you want to play back (p. 15).

1 Press the [Song/Tempo] button, getting its indicator to light in green.

The tempo appears in the display.

Each time you press the [Song/Tempo] button, the tempo and the currently selected song number (prefixed by "S.") will be displayed alternately.

While the tempo is displayed, the [Song/Tempo] button indicator will light in green.

While the song number is displayed, it will light in red.

2 Press the [-] or [+] button to adjust the tempo.

The tempo can be adjusted in a range of ♩=20–250.

You can also change the tempo during playback.

Pressing the [+] button once increases the tempo by one unit. Holding down the button increases the tempo continuously.

Pressing the [-] button once decreases the tempo by one unit. Holding down the button makes the tempo change (slow down) continuously.

If you press the [-] and [+] buttons simultaneously, you will return to the basic tempo of the song (the tempo before you modified it).

■ Adding a Count-in to Match the Timing (Count-In)

When you're playing along with a song, you can make sure that your playing is in time with the song by sounding a count before the song starts playing.

Sounding a "count sound" leading up to playback of a song is called "Count-In."

On the DP-970, if you playback a song while the metronome is sounding, two measures of lead-in count will be heard at the beginning of the song.



Correspondence between beat and tempo display

Beat	Tempo Value
2/2	♩=10–125
x/4	♩=20–250
x/8	♩=40–500



Indication of the tempo during song playback

While the song is playing, the initial tempo of the song will continue to be displayed, regardless of tempo changes during the song.



For more about the display for the internal songs, refer to p. 16.



During the count-in, the count measure is indicated in the display as "-2" then "-1."



"Sounding the Metronome" (p. 29)

Playing Each Hand Separately

The internal songs have different parts recorded to the left-hand and right-hand performances.

When playing back internal songs, you can select the parts to be played.

Left-hand performances are assigned to the [Left] button, and right-hand performances are assigned to the [Right] button.

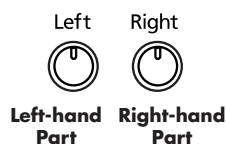

Here's how to practice each hand separately along with the song.

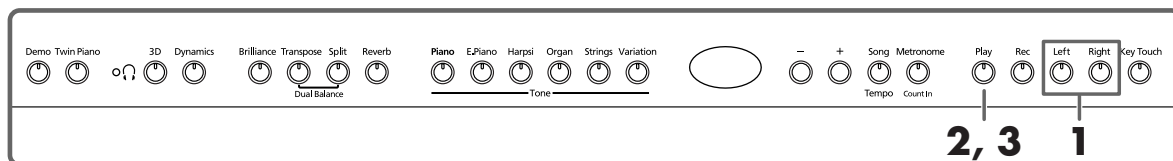

First select the song that you want to play back (p. 15).

Selecting the part that you yourself will play

1 Press the [Left] or [Right] button.

The indicator of the button you've pressed goes out, and the sound of the selected part will no longer be heard.

For example, if you want to practice the right hand, press the [Right] button and get its indicator to go dark. When you play back the song, the right-hand performance will not sound.

Playing back a song

2 Press the [Play] button, getting its indicator to light.

The song will begin playing back. The part you selected in step 1 will not sound.

Practice your right-hand performance along with the left-hand playback.

Once again press the button you selected in step 1. The button's indicator will light, and the sound will be heard once again.

You can also mute and resume the sound of the parts by pressing the [Left] button or [Right] button even while the song is playing.

Stopping the song

3 Press the [Play] button.

The song will stop.

Chapter 4. Recording Your Performance

You can easily record your performances.

A recorded performance can be played back to hear your own playing, or to add additional parts.

The following types of recording can be done using the DP-970.

- Recording just your own keyboard performance
(→ “Recording a New Song” p. 34)
- Recording along with an internal song (→ “Recording Along with a Song” p. 35)
- Recording each hand separately (→ “Recording the Right-Hand and Left-Hand Parts Separately” p. 36)

■ Notes Regarding Recording

- Only one song can be recorded.
- Recorded performances are normally deleted when you turn off the power to the DP-970, but you can use the Song Backup function (p. 39) to have the recorded performance be retained even while the power is turned off.
- You can also record performances to external audio devices as well as save performance data onto floppy disks or other media using an external MIDI device. For details, refer to “Chapter 6. Connecting External Devices” (p. 45).

If you see the following...

If you attempt to record using a different internal song when a performance has already been recorded, the following will appear, and the indicators of [Rec] button will blink.



If it is OK to erase the performance, press the [Rec] button.

If you do not want to erase the performance, press the [Play] button.

Recording Songs Starting with Pickups

Use the following method to record songs that start with pickup beats (where the song begins on a beat other than the first beat of the measure).

1. Press the [Play] button in Step 6 of “Recording a New Song” on the next page.

After a two-measure count-in, recording begins.

No recording takes place while the count sound is playing, even if the keys are played.

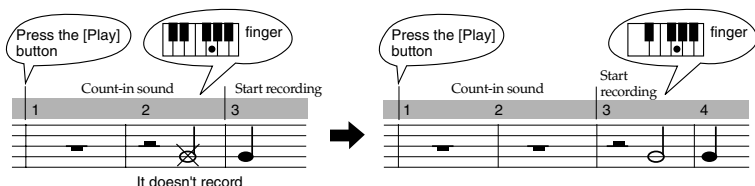

2. Start performing once recording begins.
3. After the performance is finished, press the [Play] or [Rec] button.

Recording a New Song

Record only the keyboard performance without playing along with an internal song.

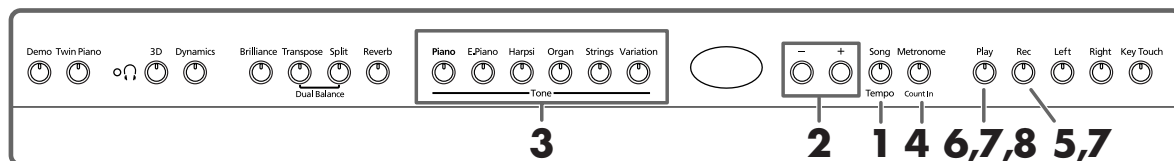

Recording settings (select “USr”)

- 1** Press the [Song/Tempo] button, getting its indicator to light in red.
The song number appears in the display for several seconds.
- 2** Press [-] and [+] buttons simultaneously.
“USr” appears in the display.

Specifying the tone and tempo for recording

- 3** Select the tone that you want to play (p. 19).
- 4** If necessary, turn on the metronome.
Sound the metronome while you set the tempo and beat of the song (p. 29).
- 5** Press the [Rec] button.
The [Rec] button’s indicator will light, the [Play] button’s indicator will blink, and you will be in recording-standby mode.

Start recording

- 6** Recording will start when you either press the [Play] button or play the keyboard.
Two measures of the count sound are played, and the recording begins.
Note that recording will also begin as soon as you play anything on the keyboard, even if you do not press the [Play] button. There is no count sound played when you start in this manner.
When recording begins, the [Play] button and [Rec] button indicators will light.
Go ahead and perform on the keyboard.

Stop recording

- 7** Press the [Play] or [Rec] button.
Recording will stop, and the indicators for the [Play] and [Rec] buttons will go dark.

Play back the recorded performance

- 8** Press the [Play] button.
You will hear the recorded performance.
Once again press the [Play] button, and playback will stop.

NOTE

If you layer a newly recorded performance without erasing the recorded song, the song tempo and beat will be stored with the settings that were recorded first.

MEMO

About the “USr” display

When you stop recording, the “USr” display will change to “USr.”
The “.” in the lower right of the display indicates that there is already a recorded performance.

MEMO

Refer to the previous page if recording a song that starts with pickup beats (where the song begins on a beat other than the first beat of the measure).

MEMO

If you record without specifying the recording track, the performance will be recorded to the [Left] button. If you want to record the right and left hands separately on separate recording tracks, refer to “Recording the Right-Hand and Left-Hand Parts Separately” (p. 36).

Recording Along with a Song

You can record a performance that you play along with an internal song.

Using the [Left] or [Right] buttons, you can perform and record just the right-hand part of a song while listening to the left-hand playback of an internal song.

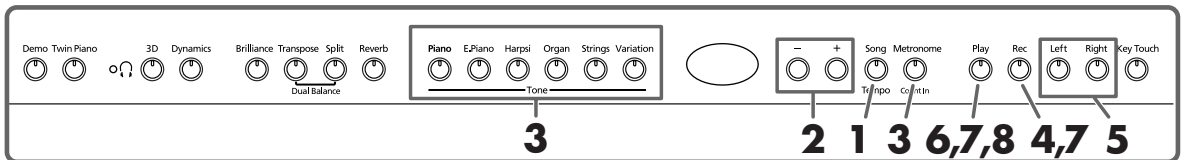

Selecting the song to record

- 1 Press the [Song/Tempo] button, getting its indicator to light in red.

The display will indicate the song number for several seconds.

- 2 Use the [-] or [+] button to select the song that you want to play.

- 3 As necessary, set the tone, metronome, and tempo (p. 29).

- 4 Press the [Rec] button.

The [Rec] button's indicator will light.

Selecting the track to record

- 5 Press the [Left] or [Right] button.

When you want to record the left-hand performance, press the [Left] button; to record that of the right hand, press the [Right] button.

The indicators of the button you pressed and of the [Play] button will blink, and the DP-970 enters recording-standby mode.

Starting to record

- 6 Press the [Play] button.

Recording begins after two measures of count sound.

Play along with the song.

Stop recording

- 7 Press the [Play] or [Rec] button.

Recording will stop, and the indicators for the [Play] and [Rec] buttons will go dark.

The recorded performance is stored in "USr (User)."

Play back the recorded performance

- 8 Press the [Play] button.

You will hear the recorded performance.

Once again press the [Play] button, and playback will stop.



If "dEL" appears in the display, refer to p. 33.

Recording the Right-Hand and Left-Hand Parts Separately

You can use the DP-970's recorder to record the right-hand and left-hand parts separately.

You can also specify individual parts to record to when you want to do a recording over again.

Press the [Left] or [Right] button to specify the part to be recorded.

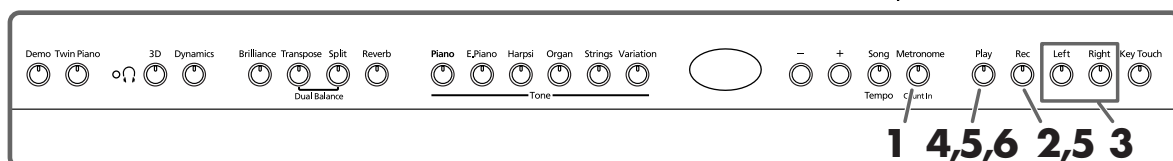
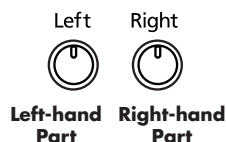

As described in steps **1** and **2** of “Recording a New Song” (p. 34), select “USr” before you continue. When layering recordings with internal songs, select the internal song as described in steps **1** and **2** of “Selecting a Song and Playing It” (p. 15).

1 As necessary, turn on the metronome (p. 29).

2 Press the [Rec] button.

The [Rec] button's indicator will light.

The indicator on the button for the part to which a performance has been recorded will light.

The indicator on the button for the part which is about to be recorded will flash.

Selecting the track to record

3 Press the [Left] or [Right] button to select the track that you want to record.

The indicator of the button you pressed will blink, and the DP-970 enters recording-standby mode.

Start recording

4 Press the [Play] button.

Two measures of the count sound are played, and the recording begins. Go ahead and perform on the keyboard.

Note that recording will also begin as soon as you play anything on the keyboard, even if you do not press the [Play] button. There is no count sound played when you start in this manner.

NOTE

If you layer on a newly recorded performance without erasing the recorded song, the song tempo, beat, and metronome settings of the original recording will be stored along with the new recording.

MEMO

The track buttons allow you to record to either the [Left] or the [Right] button, one at a time.

Stop recording

5 Press the [Play] or [Rec] button.

Recording stops, and the indicators for the [Play] and [Rec] buttons go out.

The performance of the specified part has been recorded.

To record the performance of the other part, go back to Step 2 and repeat the procedure from there.

You can listen to the performance you recorded already while you record.

Play back the recorded performance

6 Press the [Play] button.

You will hear the recorded performance.

Press the [Play] button once again, and playback will stop.

Erasing Recorded Performances

You can erase a recorded performance.

■ Erasing a Performance from the Specified Track

You can select a recorded track and erase it.

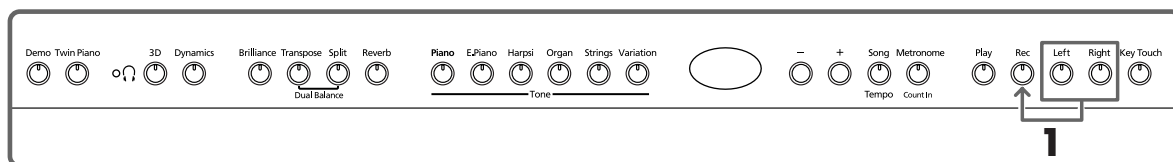

- 1 Hold down either the [Left] or [Right] button and press the [Rec] button.

The indicator of the button you pressed will go dark, and the performance of the selected track will be erased.

■ Erasing a Song

You can erase a song you've recorded.

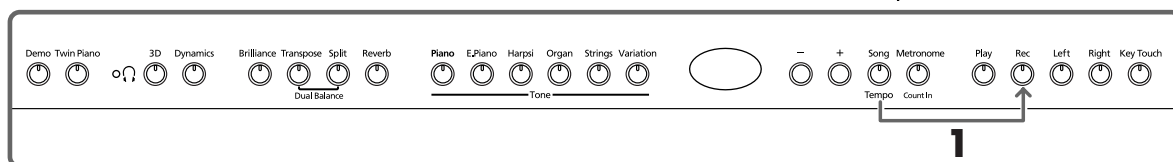

- 1 Hold down the [Song/Tempo] button and press the [Rec] button.

The following display will appear, and the indicators of the [Rec] and [Play] button will blink.



If you decide not to erase the performance, press the [Play] button.

- 2 Once again press the [Rec] button.

The recorded performance is erased.

Saving Recorded Songs Even with the Power Turned Off (Song Backup)

Normally, any songs you have recorded are deleted when you turn off the power to the DP-970. However, if you wish, you can have such recorded songs be saved even while the power is turned off. This function is called “Song Backup.”

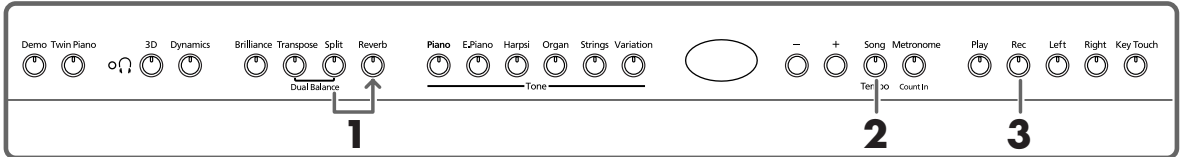

1 Hold down the [Split] button, and press the [Reverb] button.

The DP-970 switches to the function mode.

2 Press the [Song/Tempo] button.

The button's indicator flashes.

The following appears in the display.



3 Press the [Rec] button.

The display flashes, and Song Backup is executed.

When Song Backup is finished, the display and buttons return to their normal appearance.

MEMO

You can select and play songs that have been backed up in the same way as you do with the internal songs (p. 15). Songs that have been backed up are indicated in the display as shown below.



■ Deleting backed up songs

* You can delete backed up songs only when you have no songs recorded.

1 Hold down the [Split] button, and press the [Reverb] button.

The DP-970 switches to the function mode.

2 Press the [Song/Tempo] button.

The following appears in the display.



To cancel the procedure, press the [Split] button or the [Reverb] button.

3 Press the [Rec] button.

The backed up song is deleted.

The display and buttons return to their normal appearance.

Chapter 5. Changing Various Settings

Changing the Damper Pedal's Resonance

On an acoustic piano, depressing the damper pedal makes the notes you play resonate with other strings, adding rich reverberations and fatness to the sound. The damper pedal on the DP-970 recreates this resonance (damper resonance) when depressed.

You can select from eight levels of depth for the resonant sound (resonance level).

This is set to "5" when the instrument is turned on.

* This setting is enabled only with the piano tones. You cannot set this for other tones.

1. Hold down the [Brilliance] button, and press the [-] or [+] button.

When you continue holding the [Brilliance] button, the currently specified value will be displayed.

Larger values will produce a deeper effect.



Making Detailed Settings (Function)

You can make performance-related settings such as tuning and temperament.

How to enter function mode

1. Hold down the [Split] button, and press the [Reverb] button.







The DP-970 switches to the function mode.







The indicators for the [Split] and [Reverb] buttons and the button to which the function is assigned start flashing.

Setting the various functions

2. Press the button to which the desired function is assigned.

The indicators for pressed button, [Split] button, and [Reverb] button flash.

Button	Function	Page
[3D]	3D Mode 	p. 43
[Piano]	Master Tuning 	p. 41
[E. Piano]	Temperament 	p. 41
[Harpsi]	Stretch Tuning 	p. 42
[Organ]	Applying the damper pedal to the left-hand keyboard area 	p. 42
[Strings]	MIDI send channel 	p. 46

Button	Function	Page
[Variation]	Local Control 	p. 47
[Song/ Tempo]	Song Backup  Deleting Backed Up Songs 	p. 44
[Metronome/ Count In]	Saving the master tune setting 	p. 44
[Play]	Transmitting a recorded performance 	p. 47
[Right]	V-LINK 	p. 44

For details on each function, refer to the explanations below.

3. Press the [-] or [+] button to change the value.

If you press the [-] and [+] buttons simultaneously, the value will return to the power-up default setting.

The procedure differs from that for Song Backup.

For more details, refer to p. 39.

How to exit function mode

4. Press the [Split] or [Reverb] button.

The button's indicator will return to the previous state.

■ Tuning to Other Instruments' Pitches (Master Tuning)

In situations such as when playing ensemble with other instruments, you can tune the DP-970's standard pitch to the pitch of another instrument. The standard pitch generally refers to the pitch of the note that's played when you finger the middle A key.

1. Hold down the [Split] button, and press the [Reverb] button.

The DP-970 switches to the function mode.

2. Press the [Piano] button.



The last three digits are indicated in the display. "440.0 Hz" is indicated in the figure above.

Value 415.3 Hz–440.0 Hz–466.2 Hz

Power-up default setting 440.0 Hz

This setting remains in effect until you turn off the power.

→ If you want to have the settings remain stored even while the power is turned off, refer to "Getting the Master Tune Setting To Be Remembered While the Power Is Turned Off" (p. 44).

■ Changing the Temperament

You can play classical styles such as Baroque using historic temperaments (tuning methods).

Today, compositions are generally created with equal temperament in mind and are played using equal temperament. However in past ages of classical music, a variety of temperaments were used. Playing a composition with its original tuning lets you enjoy the sonorities of the chords that the composer originally intended.

1. Hold down the [Split] button, and press the [Reverb] button.

The DP-970 switches to the function mode.

2. Press the [E.Piano] button.

The following appears in the display.

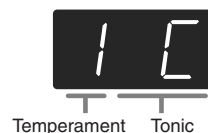

You can choose from among the seven temperaments described below.

Chapter 5. Changing Various Settings

Display	Temperament	Qualities
1	Equal	In this tuning, each octave is divided into twelve equal steps. Every interval produces about the same amount of slight dissonance.
2	Pythagorean	This tuning, devised by the philosopher Pythagoras, eliminates dissonance in fourths and fifths. Dissonance is produced by third-interval chords, but melodies are euphonious.
3	Just Major	This tuning eliminates ambiguities in the fifths and thirds. It is unsuited to playing melodies and cannot be transposed, but is capable of beautiful sonorities.
4	Just Minor	The Just tunings differ from major and minor keys. You can get the same effect with the minor scale as with the major scale.
5	Mean Tone	This scale makes some compromises in just intonation, enabling transposition to other keys.
6	Werckmeister	This temperament combines the Mean Tone and Pythagorean tunings. Performances are possible in all keys (first technique, III).
7	Kirnberger	This is an improvement of the Mean Tone and Just tunings that provides a high degree of freedom of modulation. Performances are possible in all keys (III).

Power-up default setting 1 C

Tonic

When playing with tuning other than equal temperament, you need to specify the tonic note for tuning the song to be performed (that is, the note that corresponds to C for a major key or to A for a minor key).

While hold down **the [E. Piano] button**, and press **a note** to specify the desired tonic key.

The tonic note you specify will be displayed as follows.

Display	C	C ⁻	d	E ₋	E	F	F ⁻	G	A ₋	A	b ₋	b
Letter name	C	C [#]	D	E ^b	E	F	F [#]	G	A ^b	A	B ^b	B

If you choose an equal temperament, there's no need to select a tonic note.

* If you record with a temperament other than equal temperament selected, and then want to play back that performance, use this setting to select the same temperament for playback as the temperament you used when recording.

* When performing in ensemble with other instruments, be aware that depending on the key, there may be some shifting of the pitch. Tune the DP-970 to the fundamental pitch of the other instruments.

■ Setting the Tuning Curve (Stretch Tuning)

A piano is generally tuned to a pitch with a lower bass range and a higher treble range than equal temperament. This special tuning method for pianos is called "Stretch Tuning."

1. Hold down the [Split] button, and press the [Reverb] button.

The DP-970 switches to the function mode.

2. Press the [Harpsi] button.

The button's indicator flashes.

The following appears in the display.



Display	Descriptions
OFF	This is the standard tuning curve. This is the right choice when using Dual play (p. 26), or when playing in ensemble with other instruments.
On	This tuning curve expands the bass and treble ends somewhat. It is suitable for performances such as piano solos. This setting is in effect when you turn on the power.

Power-up default setting On

* This effect works only with the piano tones.

■ Applying the Damper Pedal to the Left-hand Keyboard Area

When you are using Split play (p. 27), you can apply the damper pedal effect to the sound played by the left-hand keyboard range.

1. Hold down the [Split] button, and press the [Reverb] button.

The DP-970 switches to the function mode.

2. Press the [Organ] button.

The following appears in the display.



Display	Descriptions
On	The damper pedal effect will be applied to the sound of the left and right hand keyboard area.
OFF	The damper pedal effect will not be applied to the sound of the left-hand keyboard area.

Power-up default setting OFF

■ Changing How 3D is Applied (3D Mode)

The method used in applying the 3D function’s sense of depth changes according to whether or not headphones are connected.

You can change this setting.

1. Hold down the [Split] button, and press the [Reverb] button.

The DP-970 switches to the function mode.

2. Press the [3D] button.

The following appears in the display.



Display	Descriptions
1	When the headphones are connected, the depth effect is optimized for headphones, and when no headphones are connected, the optimal depth for speakers is applied.
2	The optimal depth for speakers is used, regardless of whether or not headphones are connected. 3D is also applied to the sound output from the Output jacks, making this convenient when you want to play through speakers connected to the Output jacks.
3	The optimal depth for headphones is used, regardless of whether or not headphones are connected.

Power-up default setting 1

Preventing the Settings from Changing During Performance

■ Disabling Everything Except Piano Play (Panel Lock)

The “Panel Lock” function locks the DP-970 in a state where only piano performance can be used, and all buttons will be disabled. This prevents the settings from being inadvertently modified even if children press the buttons accidentally. In the Panel Lock state, only the grand piano sound can be played.

1. Turn the volume to the minimum, and press the [Power] switch to turn off the power.
2. Hold down the [Piano] button and press the [Power] switch to turn on the power. Continue holding down the [Piano] button until following appears in the display.



All buttons are disabled.

3. Adjust the volume.

When you play the keyboard, the grand piano sound will be heard. To defeat the Panel Lock function, turn the volume down to the minimum, and turn on the power once again.

■ Disabling the Buttons When Using a Tone Other Than Piano (Tone Lock)

Even when using Tones other than the Piano, you can set the instrument so all of its buttons are disabled (the settings in effect at that time will be maintained).

1. Hold down the [Demo] button and press the [Key Touch] button.

Continue holding down the [Demo] button and the [Key Touch] button until following appears in the display.



The song or the metronome sound that is playing will stop.

All buttons are disabled while the instrument is set like this.

To cancel the Tone Lock function, once again hold down the [Demo] button while you press the [Key Touch] button. Alternatively, you can lower the instrument’s volume all the way and switch its power off. Then, turn it on again.

Getting the Master Tune Setting To Be Remembered While the Power Is Turned Off

Normally, the Master Tune setting reverts to the default value when the power is turned off. However, you can set the DP-970 so that the Master Tune value is retained even while the power is turned off.

1. Hold down the [Split] button, and press the [Reverb] button.

The DP-970 switches to the function mode.

2. Press the [Metronome/Count In] button.

The button's indicator flashes.

The following appears in the display.



3. Press the [Rec] button.

The Master Tune setting is saved.

When Memory Backup is finished, the display and buttons return to their normal appearance.

→ To return the Master Tune value to the initial setting, set the value to "440.0 Hz" in the Master Tune settings screen (p. 41; set the value so that "40.0" is indicated in the display), then carry out Steps 1-3.

Using the V-LINK function

Connecting the DP-970 to a V-LINK compatible image device allows you to control the images with the DP-970.

V-LINK

V-LINK (**V-LINK**) is a function that allows music and images to be performed together. By using MIDI to connect two or more V-LINK compatible devices, you can easily enjoy a wide range of visual effects that are linked to the expressive elements of a music performance.

How to Use the V-LINK

1. Hold down the [Split] button, and press the [Reverb] button.

The DP-970 switches to the function mode.

2. Press the [Right] button.

The button's indicator flashes.

The following appears in the display.



Display	Descriptions
OFF	The V-LINK function is switched off.
On	The V-LINK function is switched on. You can control images using the twelve keys at the left end of the keyboard.

Power-up default setting OFF

3. Press the [-] and [+] buttons to switch the V-LINK function on and off.

You can control images using the twelve keys at the left end of the keyboard.

While V-LINK is switched on, the following will appear in the display.



* While V-LINK is switched on, no sound is produced when you press any of the twelve keys at the left end of the keyboard.

How to exit function mode

4. Press the [Split] or [Reverb] button.

The button's indicator returns to its original state.

Chapter 6. Connecting External Devices

Connecting to Audio Equipment

You can connect audio devices to play the sound of the DP-970 through the speakers of your audio system, or to record your performance on a tape recorder or other recording device.

When connecting, please use an audio cable with a standard phone plug (sold separately).

Connection Examples

- * To prevent malfunction and/or damage to speakers or other devices, always turn down the volume, and turn off the power on all devices before making any connections.

Playing the sound of the DP-970 through the speakers of an audio system/Recording the performance of the DP-970 on a recording device

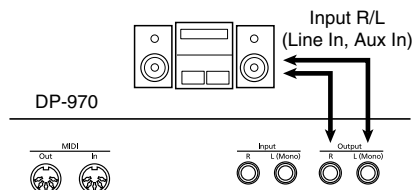

○ Use the following procedure when turning on the power.

1. Turn on the power of the DP-970.
2. Turn on the power of the connected device.
3. Adjust the volume of each device.

→ You can adjust the volume of a connected sound device with the DP-970.

When Recording DP-970 Performances on a Recording Device

4. Start recording with the connected device.
5. Perform on the DP-970.
6. When the performance ends, stop recording on the connected equipment.

○ Turning off the power

1. Set the volume of the DP-970 and of the connected devices to the minimum position.
2. Turn off the connected equipment.
3. Turn off the power to the DP-970.

Playing the sound of an audio device through the speakers of the DP-970

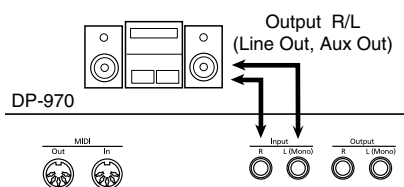

- * When connection cables with resistors are used, the volume level of equipment connected to the inputs (input jacks) may be below. If this happens, use connection cables that do not contain resistors.

○ Use the following procedure when turning on the power.

1. Turn on the power of the connected device.
2. Turn on the power of the DP-970.
3. Adjust the volume of each device.

* You cannot use the DP-970 to adjust the volume of the connected sound generating device.

○ Turning off the power

1. Set the volume of the DP-970 and of the connected devices to the minimum position.
2. Turn off the power to the DP-970.
3. Turn off the connected equipment.

Connecting to a Computer

You can use a USB MIDI interface cable (sold separately) to connect the DP-970 to your computer.

If the DP-970 is connected to a computer in which sequencer software is installed, a song you've recorded on the DP-970 can be saved on your computer.

Connection Examples

- * To prevent malfunction and/or damage to speakers or other devices, always turn down the volume, and turn off the power on all devices before making any connections.

- * In order to make connections to your computer, you must install "MIDI driver" software on your computer. For details, refer to the owner's manual for your MIDI interface.

Use a USB MIDI interface cable to connect the USB connector of your computer to the MIDI connectors of the DP-970.

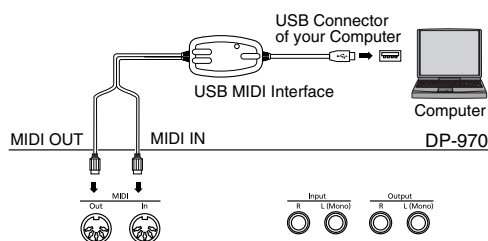

Connecting MIDI Devices

By connecting an external MIDI device and exchanging performance data, you can control the performances on one device from the other. For instance, you can output sound from the other instrument or switch tones on the other instrument.

■ What's MIDI?

MIDI stands for Musical Instrument Digital Interface, an international standard which allows performance information to be communicated among electronic musical instruments and computers.

The DP-970 provides MIDI connectors, which allow performance data to be exchanged with external devices. When these connectors are used to connect the DP-970 to external devices, an even wider range of possibilities becomes available.

→ For details on MIDI functionality and operations, refer to MIDI implementation. You can download the MIDI implementation from <http://www.roland.com/>

Connection Examples

* To prevent malfunction and/or damage to speakers or other devices, always turn down the volume, and turn off the power on all devices before making any connections.

Playing the DP-970 from a MIDI sequencer/ Recording an DP-970 performance on a MIDI sequencer

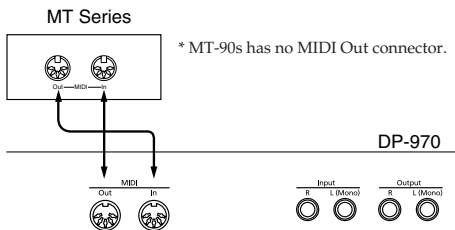

* Set Local Off if you have connected the DP-970 to a MIDI sequencer. Refer to "Switching Local Control on and Off" (p. 47). Also set your MIDI sequencer to MIDI Thru mode (so that messages received at MIDI IN will be re-transmitted without change from MIDI OUT). For details, refer to the owner's manual of your MIDI sequencer.

Perform on the DP-970 to play a MIDI sound generator

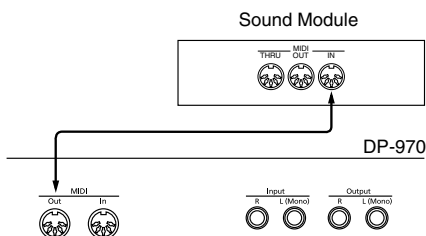

Making MIDI-related Settings

Here's how you can set the transmit channel and other MIDI-related settings.

How to enter function mode

1. Hold down the [Split] button and press the [Reverb] button.

The DP-970 switches to the function mode.

The indicators for the [Split] and [Reverb] buttons and the button to which the function is assigned start flashing.

Setting various functions

2. Press the button to which the desired function is assigned.

The indicators for pressed button, [Split] button, and [Reverb] button flash.

For details on the contents of each function, refer to the explanations that follow.

3. Press the [-] or [+] button to change the value.

If you press the [-] and [+] buttons simultaneously, the setting will return to the original value.

How to exit function mode

4. Press either the [Split] button or the [Reverb] button.

The button's indicator will return to the previous state.

■ MIDI Send Channel Settings

MIDI features sixteen MIDI channels, numbered 1–16. Simply connecting a cable is not enough for communication to take place. The connected devices must be set to use the same MIDI channels. Otherwise, no sound will be produced, and no sounds can be selected.

* The DP-970 receives all channels 1–16.

1. Hold down the [Split] button, and press the [Reverb] button.

The DP-970 switches to the function mode.

2. Press the [Strings] button.

The following appears in the display.



Value	1–16
Power-up default setting	1

■ Switching Local Control on and Off

When connecting a MIDI sequencer, set Local Control to “OFF.”

As illustrated, information describing what has been played on the keyboard is passed to the internal sound generator over two different routes, (1) and (2). As a result, you hear overlapping or intermittent sounds. To prevent this from happening, route (1) must be severed, by setting the unit to what is known as “Local Off.”

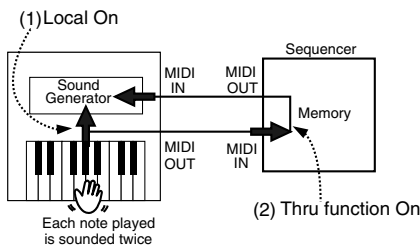

Local Control ON: The keyboard and the internal sound generator are in a linked state.

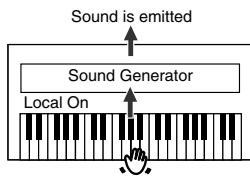

Local Control OFF: The keyboard and the internal sound generator are in an unlinked state. No sound will be produced by the keyboard when it is played.

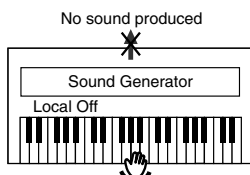

* When a Roland MT series instrument is connected, it is not necessary to make the Local Off setting. MT units transmit Local Off messages when their power is switched on. If you turn on the power in the order of the DP-970 → MT series, Local Off will be set automatically.

1. Hold down the [Split] button, and press the [Reverb] button.

The DP-970 switches to the function mode.

2. Press the [Variation] button.

The following appears in the display.



Display	Descriptions
On	Instrument is set to Local On.
OFF	Instrument is set to Local Off.

Power-up default setting On

■ Transmitting a Performance You Recorded

If you want to transmit a performance recorded on the DP-970 to an external MIDI device or computer, turn this setting “On.” If this is “OFF,” the data will not be transmitted.

1. Hold down the [Split] button, and press the [Reverb] button.

The DP-970 switches to the function mode.

2. Press the [Play] button.

The following appears in the display.



Display	Descriptions
On	Recorded performance is transmitted to external device.
OFF	Recorded performance is not transmitted to external device.

Power-up default setting OFF

Connection Examples

Saving Recorded Performances to a MIDI Sequencer, Such As One From the MT Series (Except the MT-90s)

Set the external MIDI sequencer’s MIDI THRU setting to OFF. For details, refer to the owner’s manual for your MIDI sequencer.

1. Connect a MIDI sequencer such as the MT series (p. 46).
2. Record the performance on the DP-970 (p. 33).
3. Set this setting to “On.”
4. Start recording with the connected MIDI sequencer.
5. Start playback of the recorded song on the DP-970.
6. When playback ends, stop recording with the connected MIDI sequencer.
7. Use a connected MIDI sequencer to save the data on a floppy disk or other media.

Troubleshooting

If you think there's a problem, read this first.

Case	Cause/Remedy
The power doesn't come on	Is the AC adaptor connected and plugged in correctly? (p. 12)
The button doesn't work	Is the panel locked? (p. 43) Is the Tone locked? (p. 43) Turn the power off, then back on.
No sound is heard	Is the volume level of the DP-970 turned all the way down? (p. 14)
	Are headphones plugged in and headphones indicator lights up? (p. 13) Has a plug remained connected to the Phones jack? When headphones are connected, the keyboard's speaker stops playing.
	Is Local Off selected? When Local Control is set to OFF, no sound is produced by playing the keyboard. Set Local Control to "On" (p. 47).
	Is V-LINK switched on? While V-LINK is switched on, no sound is produced when you press any of the twelve keys at the left end of the keyboard (p. 44).
No sound is heard (when a MIDI instrument is connected)	Have all devices been switched on?
	Are the MIDI cables connected correctly?
	Does the MIDI channel match the connected instrument? (p. 46)
Sounds are heard twice (doubled) when the keyboard is played	Is the DP-970 in Dual play? (p. 26)
	When the DP-970 is connected to an external sequencer, set it to the Local OFF mode (p. 47). Alternatively, the sequencer could be set so its MIDI Thru feature is OFF.
The tone has changed in the Split or Dual play	If you use Dual play or Split play with a Tone button for which tone number 3 or 4 is selected, tone number 1 will be selected for that Tone button (p. 19).
	Some tones assign the tone that had been selected before you pressed the [Split] button to the left hand area of the keyboard. Please refer to "Tone List" (p. 50).
Tone doesn't change	Is the panel locked? (p. 43) Is the Tone locked? (p. 43) Turn the power off, then back on.
	Are the indicators for the [Split] and [Reverb] buttons flashing? Setting of functions is in progress. Press the [Split] or [Reverb] button to exit function mode (p. 40, p. 46).

Case	Cause/Remedy
Not all played notes are sounded	The maximum number of notes that the DP-970 can play simultaneously is 64. Frequent use of the damper pedal when playing along with a song may result in performance data with too many notes, causing some notes to drop out.
The tuning or pitch of the keyboard or song is off	Have you set Transpose? (p. 24)
	Are the settings for the "Temperament" and "Stretch Tuning" correct? (p. 41) Is the setting for the "Master Tuning" correct? (p. 41)
Song doesn't play back/ Only the sound of a particular instrument in a song does not play	Are the indicator for the Track buttons ([Left] and [Right] buttons) extinguished? (p. 32) If the button indicator is out, the music on that track is not heard. Press the track button so the indicator is illuminated.
Can't record	Has one of the track buttons for recording been selected? (p. 33–p. 36)
Tempo of recorded song or metronome is off	If you select an internal song in which the tempo changes during the song, and then record, the tempo will change in the same way for the performances. The tempo of the metronome will also change in the same way.
	If you record additional material without erasing the previously recorded song, the song will be recorded at the first-recorded tempo. Please erase the previously recorded song before you re-record (p. 38).
The recorded performance has disappeared	Any performance that has been recorded is deleted when the power to the DP-970 is turned off. A performance cannot be restored once it's been deleted. If you do not want a performance to be deleted, use Song Backup (p. 39).
Depressing a pedal has no effect, or the pedal effect doesn't stop	Is the pedal connected correctly? Make sure the pedal cord is securely connected to the pedal jack on the rear of the unit (p. 12).
The volume level of the instrument connected to Input jacks is too low	Could you be using a connection cable that contains a resistor? Use a connection cable that does not contain a resistor.
Reverberation still audible even with Reverb turned off	Since the DP-970's piano sounds accurately reproduce the depth and reverberation of the original acoustic piano, you may find that reverberation is audible when the 3D is enabled. If you want to eliminate the reverberation, turn off the 3D function (p. 21).

Case	Cause/Remedy
In the upper range, the sound changes abruptly beyond a certain key	On an acoustic piano, notes in the upper one and a half octaves of the keyboard continue to sound until they decay naturally, regardless of the damper pedal. There is a difference in the timbre as well. Roland pianos faithfully simulate such characteristics of the acoustic piano. On the DP-970, the range that is unaffected by the damper pedal will change depending on the Key Transpose setting.
A High-pitched whine is produced	When listening through headphones: Some of the more flamboyant and effervescent piano tones feature an ample high-end component, which may make the sound appear to have metallic reverberation added. Since this reverberation becomes particularly audible when supplemented by heavy reverb, you may be able to diminish the problem by reducing the amount of reverb applied to the sound. When listening through speakers: Here, a different cause (such as resonance produced by the DP-970) would be suspect. Consult your Roland dealer or nearest Roland Service Center.

Case	Cause/Remedy
The bass range sounds odd, or there is a vibrating resonance	When listening through speakers: Playing at loud volumes may cause instruments near the DP-970 to resonate. Resonance can also occur with fluorescent light tubes, glass doors, and other objects. In particular, this problem occurs more easily when the bass component is increased, and when the sound is played at higher volumes. Use the following measures to suppress such resonance. <ul style="list-style-type: none"> • Place speakers so they are 10–15 cm from walls and other surfaces. • Reduce the volume. • Move the speakers away from any resonating objects. When listening through headphones: Here, a different cause would be suspect. Consult your Roland dealer or nearest Roland Service Center.

Error Messages/Other Messages

Display	Meaning
S. U	Indicates the song has been backed up.
USr	User Song. Stores recorded performances (p. 34).
USr.	The "." in the display indicates that there is performance material already recorded (p. 34).
S.	Internal song number (p. 15).
PU	This appears when a song with a pickup (a song that does not start on the first beat) is played back.
dEL	This appears when you attempt to delete a recorded song (p. 33, p. 38).
E.32	The amount of performance information is too large, and further recording is not possible.
E.41	A problem such as a loose MIDI cable occurred. Make sure the MIDI cables are correctly hooked up.
V-LINK	V-LINK function is On (p. 44).

* Error messages are indicated by an "E." before the number. Press any button, and you can cancel the error message.

Tone List

		[Split] Off	[Split] On		
Button name	[Variation]	Tone	[Variation] Dark	[Variation] Red	[Variation] Green
[Piano]	Dark	Grand Piano	Grand Piano / Acoustic Bass	Grand Piano / Acoustic Bass + Cymbal	Grand Piano / Strings
	Red	Mellow Piano	Mellow Piano / Acoustic Bass	Mellow Piano / Acoustic Bass + Cymbal	Mellow Piano / Strings
	Green	Piano + Strings			
	Orange	Piano + Choir			
[E. Piano]	Dark	Electric Piano1	Electric Piano1 / Electric Bass	Electric Piano1 / Acoustic Bass	Electric Piano1 / Strings
	Red	Electric Piano2	Electric Piano2 / Electric Bass	Electric Piano2 / Acoustic Bass	Electric Piano2 / Strings
	Green	Vibraphone			
	Orange	Electric Piano + Choir			
[Harpsi]	Dark	Harpsichord	Harpsichord / Strings	Harpsichord / Organ Flute	Harpsichord / Acoustic Bass
	Red	Coupled Harpsichord	Coupled Harpsichord / Strings	Coupled Harpsichord / Organ Flute	Coupled Harpsichord / Acoustic Bass
	Green	Harpsichord + Strings			
	Orange	Harpsichord + Choir			
[Organ]	Dark	Church Organ 1	Church Organ 1 / Organ Bass	Church Organ 1 / Strings	Church Organ 1 / Choir
	Red	Organ Flute	OrganFlute / Organ Bass	OrganFlute / Strings	OrganFlute / Choir
	Green	Rotary Organ			
	Orange	Church Organ 2			
[Strings]	Dark	Slow Strings	Strings / Pizzicato	Slow Strings / Choir	Flute / Slow Strings
	Red	Jazz Scat	Jazz Scat / Voice Bass	Jazz Scat / Acoustic Bass	Jazz Scat / Choir
	Green	Strings			
	Orange	Choir			

* A+B: simultaneously playing two tones

You can change the volume balance between the two tones, refer to "Adjusting the Volume Balance in Dual Play (Dual Balance)" (p. 26).

A/B: A, the right-hand tone; and B, the left-hand tone in Split play

Internal Song List

Song No.	Song Name	Composer	Copyright
S. 1	La Fille aux Cheveux de Lin	C. Debussy	© 2004 Roland Corporation
S. 2	Late Night Chopin	F. Chopin/ Arranged by John Maul	© 2002 Roland Corporation
S. 3	Fly Free	John Maul	© 1998 Roland Corporation
S. 4	L'éveil del l'amour	Masashi & Kazuko Hirashita	© 2000 Roland Corporation
S. 5	Sonate für Klavier No. 15	W. A. Mozart	© 1996 Roland Corporation
S. 6	Liebesträume III	F. Liszt	© 2001 Roland Corporation
S. 7	Étude, op.10-3	F. Chopin	© 2001 Roland Corporation
S. 8	Je te veux	E. Satie	© 1997 Roland Corporation
S. 9	Valse, op.64-1	F. Chopin	© 2001 Roland Corporation
S. 10	Golliwog's Cake walk	C. Debussy	© 1995 Roland Corporation
S. 11	Fantaisie-Impromptu	F. Chopin	© 2001 Roland Corporation
S. 12	Iére Arabesque	C. Debussy	© 1995 Roland Corporation
S. 13	An der schönen, blauen Donau	J. Strauss (II)	© 1996 Roland Corporation
S. 14	Auf Flügeln des Gesanges	F. Mendelsshon	© 1996 Roland Corporation
S. 15	Mazurka No.5	F. Chopin	© 1995 Roland Corporation
S. 16	Ière Gymnopédie	E. Satie	© 1997 Roland Corporation
S. 17	Étude, op.25-1	F. Chopin	© 1995 Roland Corporation
S. 18	Clair de Lune	C. Debussy	© 1998 Roland Corporation
S. 19	Étude, op.10-5	F. Chopin	© 2001 Roland Corporation
S. 20	Doctor Gradus ad Parnassum	C. Debussy	© 1995 Roland Corporation
S. 21	Grande Valse Brillante	F. Chopin	© 1995 Roland Corporation
S. 22	La prière d'une Vierge	T. Badarzewska	© 1996 Roland Corporation
S. 23	Course en Troïka	P. Tchaikovsky	© 1996 Roland Corporation
S. 24	To The Spring	E. Grieg	© 1996 Roland Corporation
S. 25	Valse, op.64-2	F. Chopin	© 1996 Roland Corporation
S. 26	Radetzky Marsch	J. Strauss (I)	© 1996 Roland Corporation
S. 27	Träumerei	R. Schumann	© 1996 Roland Corporation
S. 28	Moments Musicaux III	F. Schubert	© 1996 Roland Corporation
S. 29	Prélude, op.28-15	F. Chopin	© 1996 Roland Corporation
S. 30	The harmonious blacksmith	G. Handel	© 1996 Roland Corporation
S. 31	Ungarische Tänze V	J. Brähms	© 1996 Roland Corporation
S. 32	Türkischer Marsch	L. v. Beethoven	© 1996 Roland Corporation
S. 33	Nocturne No.2	F. Chopin	© 1996 Roland Corporation
S. 34	Frühlingslied	F. Mendelsshon	© 1996 Roland Corporation
S. 35	Präludium	J. S. Bach	© 1996 Roland Corporation
S. 36	Jägerlied	F. Mendelsshon	© 1996 Roland Corporation
S. 37	Menuet Antique	M. Ravel	© 1996 Roland Corporation
S. 38	Für Elise	L. v. Beethoven	© 1996 Roland Corporation
S. 39	Türkischer Marsch	W. A. Mozart	© 1996 Roland Corporation
S. 40	Ständchen	F. Schubert	© 1996 Roland Corporation
S. 41	Humoreske	A. Dvořák	© 1996 Roland Corporation

Internal Song List

Song No.	Song Name	Composer	Copyright
S. 42	Blumenlied	G. Lange	© 1996 Roland Corporation
S. 43	Alpenglöckchen	T. Oesten	© 1996 Roland Corporation
S. 44	Menuett G dur	L. v. Beethoven	© 1996 Roland Corporation
S. 45	Venezianisches Gondellied	F. Mendelsshon	© 1996 Roland Corporation
S. 46	Alpenabendröte	T. Oesten	© 1996 Roland Corporation
S. 47	Farewell to the Piano	L. v. Beethoven	© 1996 Roland Corporation
S. 48	Brautchor	R. Wagner	© 1996 Roland Corporation
S. 49	Battle of Waterloo	W. Anderson	© 1996 Roland Corporation
S. 50	Wiener Marsch	C. Czerny	© 1996 Roland Corporation
S. 51	Le Coucou	L. C. Daquin	© 1996 Roland Corporation
S. 52	Menuett G dur	J. S. Bach	© 1992 Roland Corporation
S. 53	Spinnerlied	A. Ellmenreich	© 1996 Roland Corporation
S. 54	Gavotte	F. Gossec	© 1996 Roland Corporation
S. 55	Heidenröslein	G. Lange	© 1996 Roland Corporation
S. 56	Zigeuner Tanz	H. Lichner	© 1996 Roland Corporation
S. 57	La Cinquantaine	G. Marie	© 1996 Roland Corporation
S. 58	Csikos Post	H. Necke	© 1996 Roland Corporation
S. 59	Dolly's Dreaming Awakening	T. Oesten	© 1996 Roland Corporation
S. 60	La Violette	L. Streabbog	© 1996 Roland Corporation
S. 61	Fröhlicher Landmann	R. Schumann	© 1996 Roland Corporation
S. 62	Sonatine op.36-1	M. Clementi	© 1996 Roland Corporation
S. 63	Sonatine op.20-1	F. Kuhlau	© 1996 Roland Corporation
S. 64	Sonatine No.5	L. v. Beethoven	© 1996 Roland Corporation
S. 65	Hungarian Rag: Hungarian Dance No. 5 Ragtime Arrangement For Solo Piano	J. Brahms/ Arranged by John Maul	© 1996 Roland Corporation
S. 66	Paganini Boogie: Jazz Variation Based on "Caprice No. 24 in A Minor"	N. Paganini/ Arranged by John Maul	© 1998 Roland Corporation

* All rights reserved. Unauthorized use of this material for purposes other than private, personal enjoyment is a violation of applicable laws.

Easy Operation List

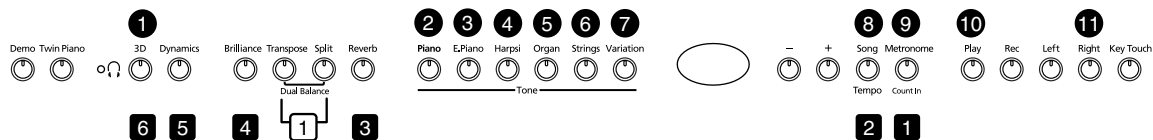

No.	You want to	Buttons	Page
Press the [Split] and [Reverb] buttons simultaneously, and press the [●] button.			
1	3D Mode	[Split]+ [Reverb] → [3D]	p. 43
2	Master Tuning	[Split]+ [Reverb] → [Piano]	p. 41
3	Selecting a temperament Specifying the keynote	[Split]+ [Reverb] → [E. Piano] → [E. Piano] + key	p. 41
4	Stretch tuning	[Split]+ [Reverb] → [Harpsi]	p. 42
5	Applying the damper pedal to the left-hand keyboard area	[Split]+ [Reverb] → [Organ]	p. 42
6	MIDI send channel settings	[Split]+ [Reverb] → [Strings]	p. 46
7	Local Control	[Split]+ [Reverb] → [Variation]	p. 47
8	Song Backup	[Split]+ [Reverb] → [Song/Tempo]	p. 39
9	Saving the Master Tune setting	[Split]+ [Reverb] → [Metronome/Count In]	p. 44
10	Transmitting a recorded performance	[Split]+ [Reverb] → [Play]	p. 47
11	V-LINK	[Split]+ [Reverb] → [Right]	p. 44
Press the [□] button, and press the [-] or [+] button.			
1	Dual Balance	[Transpose] + [Split] → [-][+]	p. 26
Hold down the [■] button and press the [-] or [+] button.			
1	Metronome volume	[Metronome/Count In] + [-] [+]	p. 30
2	Beat of metronome	[Song/Tempo] + [-] [+]	p. 29
3	Depth of the Reverb effect	[Reverb] + [-] [+]	p. 23
4	Damper pedal's resonance level	[Brilliance] + [-] [+]	p. 40
5	Dynamic Emphasis setting	[Dynamics] + [-] [+]	p. 22
6	3D setting	[3D] + [-] [+]	p. 21 p. 21
Hold down the [Split] or [Transpose] button and press the key.			
	Split Point	[Split] + key	p. 28
	Key Transpose	[Transpose] + key	p. 24

MIDI Implementation Chart

Function...		Transmitted	Recognized	Remarks
Basic Channel	Default Changed	1 1-16	1 1-16	
Mode	Default Messages Altered	Mode 3 x *****	Mode 3 x	
Note Number :	True Voice	15-113 *****	0-127 15-113	
Velocity	Note ON Note OFF	O x 8n v=64	O x	
After Touch	Key's Ch's	x x	x x	
Pitch Bend		x	x	
Control Change	6, 38 7 11 64 66 67 91 100, 101	O x x O O O O O	O O O O O O O O	Data entry Volume Expression Hold 1 Sostenuto Soft Effect 1 (Reverb) RPN LSB, MSB
Prog Change	: True Number	O (0...117) *****	O (0-127) 0...117	
System Exclusive		O	O	
System Common	: Song Pos : Song Sel : Tune	x x x	x x x	
System Real Time	: Clock : Commands	x x	x x	
Aux Message	: All sound off : Reset all controllers : Local Control : All Notes OFF : Active Sense : Reset	x x x x O x	x O O O (123-127) O x	
Notes				

Mode 1 : OMNI ON, POLY Mode 2 : OMNI ON, MONO
 Mode 3 : OMNI OFF, POLY Mode 4 : OMNI OFF, MONO

O : Yes
 X : No

Main Specifications

Keyboard	
Keyboard	88 keys (Progressive Hammer Action Keyboard)
Touch Sensitivity	Touch: Light, Medium, Heavy, Fixed
Keyboard Modes	Whole, Dual (volume balance adjustable), Split (split point adjustable), Twin Piano
Sound Source	
Max. Polyphony	64 voices
Tones	5 groups 20 variations
Temperament	7 types, tonic selectable
Stretched Tuning	2 types
Master Tuning	415.3 Hz–466.2 Hz (adjustable in increments of 0.1 Hz)
Transpose	Key Transpose (-6–+5 in semitones)
Effects	3D (4 levels), Dynamics (3 type), Reverb (8 levels), Chorus (for E. Piano only), Damper Resonance (for Piano only, 8 levels)
Metronome	
Beat	2/2, 0/4, 2/4, 3/4, 4/4, 5/4, 6/4, 7/4, 3/8, 6/8, 9/8, 12/8
Volume	9 levels
Recorder	
Tracks	2 tracks
Song	1 song
Note Storage	Approx. 5,000 notes
Tempo	Quarter note = 20–250
Resolution	96 ticks per quarter note
Control	Play/Stop, Rec, Tempo, All Song Play, Track Select
Preset Songs	66 songs + 13 Tone Demo Songs
Others	
Rated Power Output	7 W x 2
Speakers	12 cm x 2
Display	Beat LED 7 segments, 3 characters LED Headphones indicator
Control	Volume, Brilliance (3 steps)
Pedals	Damper, Soft, Sostenuto
Other Functions	Panel Lock, Tone Lock
Connectors	Output jacks (L/Mono, R), Input jacks (L/Mono, R), Headphones jack x 2 (Stereo), MIDI connectors (In, Out)
Power Supply	DC 9 V
Power Consumption	23 W
Dimensions (including piano stand)	1,398 (W) x 344 (D) x 781 (H) mm / 55-1/16 (W) x 13-9/16 (D) x 30-3/4 (H) inches (With lid closed) 1,398 (W) x 339 (D) x 974 (H) mm / 55-1/16 (W) x 13-3/8 (D) x 38-3/8 (H) inches (With lid open)
Weights (including piano stand)	47 kg / 103 lbs 10oz
Accessories	Owner's manual, AC Adaptor, Power Cord (for connecting AC Adaptor), Headphones Hook

* In the interest of product improvement, the specifications and/or appearance of this unit are subject to change without prior notice.

Index

Numerics

3D	21
[3D] button	10, 21, 40, 43

A

AC Adaptor	12
All Song Play	15
Assemble	8
Audio Equipment	45

B

Backup	39
Beat	29
[Brilliance] button	40
[Brilliance] knob	14

C

Computer	45
Count-In	31

D

Damper pedal	14, 42
Resonance	40
Damper Resonance	14, 40
Demo	
Demo of the Functions	18
Tone Demo	17
[Demo] button	10, 17–18, 43
Dual Balance	26
Dual Play	26
Dynamic Emphasis	22
[Dynamics] button	10, 22

E

[E. Piano] button	40
[E.Piano] button	41
Easy Operation List	53
Effects (Reverb)	23
Erase	38
Error Messages	49

F

Function	40
MIDI-related Settings	46

G

Grand Space	21
-------------------	----

H

[Harpsi] button	40, 42
Headphones	13
Headphones Hook	14
[Headphones] indicator	10
Headphones jack	13

I

Internal Song	15
---------------------	----

K

Key Touch	20
[Key Touch] button	10, 20, 43

L

[Left] button	10
Local Control	47

M

Master Tuning	41
Metronome	29
Volume	30
[Metronome/ Count In] button	41
[Metronome/Count In] button	10, 29, 44
MIDI	46
MIDI channel	46
MIDI Devices	46
Music rest	13

O

[Organ] button	40, 42
----------------------	--------

P

Panel Lock	43
Pedal	14
Pedal cord	12
Pedal jack	12
[Piano] button	40–41, 43
Play	
All Songs Continuously	15
Along with the internal songs	31
Each Hand	32
Selecting a song	15
[Play] button	10, 15, 32, 41, 47
Power	14
[Power] switch	10, 14

R

[Rec] button	10, 34–36
Record	33
Along with a Song	35
Backup	39
Each Hand	36
Erasing Performances	38
New Song	34
Songs Starting with Pickups	33
Reverb	23
Depth	23
[Reverb] button	23, 40
[Right] button	10, 41, 44

S

Soft pedal	14
Song Backup	39
[Song/ Tempo] button	41
[Song/Tempo] button	10, 15, 31, 34–35
Songs Starting with Pickup Beats	33
Sostenuto pedal	14
[Split] button	10, 27, 40
Split Play	27
Split Point	28
Stretch Tuning	42
[Strings] button	40, 46

T

Temperament	41
Tempo	29, 31
Tone	19
Tone button	19
Tone Group	19
Tone Lock	43
Transpose	24
[Transpose] button	10, 24
Troubleshooting	48
Tuning Curve	42
[Twin Piano] button	10, 25
Twin Piano Mode	25

V

[Variation] button	19, 41, 47
Variation tone	19
V-LINK	44
Volume	
Metronome	30
[Volume] knob	10, 14

Information

When you need repair service, call your nearest Roland Service Center or authorized Roland distributor in your country as shown below.

AFRICA

EGYPT

Al Fanny Trading Office
9, EBN Hagar A1 Askalany
Street,
ARD El Golf, Heliopolis,
Cairo 11341, EGYPT
TEL: 20-2-417-1828

REUNION

Maison FO - YAM Marcel
25 Rue Jules Hermann,
Chaudron - BP79 97 491
Ste Clotilde Cedex,
REUNION ISLAND
TEL: (0262) 218-429

SOUTH AFRICA

T.O.M.S. Sound & Music
(PTY)Ltd.
2 ASTRON ROAD DENVER
JOHANNESBURG ZA 2195,
SOUTH AFRICA
TEL: (011)417 3400
FAX: (011)417 3462

Paul Bothner(PTY)Ltd.
Royal Cape Park, Unit 24
Londonderry Road, Ottery 7800
Cape Town, SOUTH AFRICA
TEL: (021) 799 4900

ASIA

CHINA

Roland Shanghai Electronics
Co.,Ltd.
5F, No.1500 Pingliang Road
Shanghai 200090, CHINA
TEL: (021) 5580-0800

Roland Shanghai Electronics
Co.,Ltd.
(BEIJING OFFICE)
10F, No.18 3 Section Anhuaxili
Chaoyang District Beijing
100011 CHINA
TEL: (010) 6426-5050

HONG KONG

Tom Lee Music Co., Ltd.
Service Division
22-32 Pun Shan Street, Tsuen
Wan, New Territories,
HONG KONG
TEL: 2415 0911

PARSONS MUSIC LTD.

8th Floor, Railway Plaza, 39
Chatham Road South, T.S.T.,
Kowloon, HONG KONG
TEL: 2333 1863

INDIA

Rivera Digitec (India) Pvt. Ltd.
409, Nirman Kendra
Mahalaxmi Flats Compound
Off. Dr. Edwin Moses Road,
Mumbai-400011, INDIA
TEL: (022) 2493 9051

INDONESIA

PT Citra Inti Rama
Jl. Cideng Timur No. 15J-150
Jakarta Pusat
INDONESIA
TEL: (021) 6324170

KOREA

Cosmos Corporation
1461-9, Seocho-Dong,
Seocho Ku, Seoul, KOREA
TEL: (02) 3486-8855

MALAYSIA

Roland Asia Pacific Sdn. Bhd.
45-1, Block C2, Jalan PJU 1/39,
Dataran Prima, 47301 Petaling
Jaya, Selangor, MALAYSIA
TEL: (03) 7805-3263

PHILIPPINES

G.A. Yupango & Co. Inc.
339 Gil J. Puyat Avenue
Makati, Metro Manila 1200,
PHILIPPINES
TEL: (02) 899 9801

SINGAPORE

SWEET LEE MUSIC
COMPANY PTE. LTD.
150 Sims Drive,
SINGAPORE 387381
TEL: 6846-3676

TAIWAN

ROLAND TAIWAN
ENTERPRISE CO., LTD.
Room 5, 9fl. No. 112 Chung
Shan N.Road Sec.2, Taipei,
TAIWAN, R.O.C.
TEL: (02) 2561 3339

THAILAND

Theora Music Co., Ltd.
330 Soi Verng NakornKasem,
New Road, Sumpantawongse,
Bangkok 10100, THAILAND
TEL: (02) 224-8821

AUSTRALIA/ NEW ZEALAND

AUSTRALIA/ NEW ZEALAND

Roland Corporation
Australia Pty.,Ltd.
38 Campbell Avenue
Dee Why West. NSW 2099
AUSTRALIA

For Australia
Tel: (02) 9982 8266
For New Zealand
Tel: (09) 3098 715

CENTRAL/LATIN AMERICA

ARGENTINA

Instrumentos Musicales S.A.
Av.Santa Fe 2055
(1123) Buenos Aires
ARGENTINA
TEL: (011) 4508-2700

BARBADOS

A&B Music Supplies LTD
12 Webster Industrial Park
Wildely, St.Michael, Barbados
TEL: (246)430-1100

BRAZIL

Roland Brasil Ltda.
Rua San Jose, 780 Sala B
Parque Industrial San Jose
Cotia - Sao Paulo - SP, BRAZIL
TEL: (011) 4615 5666

CHILE

Commercial Fancy II S.A.
Rut.: 96.919.420-1
Nataaniel Cox #739, 4th Floor
Santiago - Centro, CHILE
TEL: (02) 688-9540

COLOMBIA

Centro Musical Ltda.
Cra 43 B No 25 A 41 Bododega 9
Medellin, Colombia
TEL: (574)3812529

COSTA RICA

JUAN BANSBACH INSTRUMENTOS
MUSICALES
Ave.1. Calle 11, Apartado
10237,
San Jose, COSTA RICA
TEL: 258-0211

CURACAO

Zeeeland Music Center Inc.
Orionweg 30
Curacao, Netherland Antilles
TEL:(305)5926866

DOMINICAN REPUBLIC

Instrumentos Fernando Giraldez
Calle Proyecto Central No.3
Ens. La Esperilla
Santo Domingo,
Dominican Republic
TEL:(809) 683 0305

ECUADOR

Mas Musica
75 Avenida Norte y Zaruma
Guayaquil - Ecuador
TEL:(593-4)2302364

EL SALVADOR

OMNI MUSIC
75 Avenida Norte y Final
Alameda Juan Pablo II,
Edificio No.4010 San Salvador,
EL SALVADOR
TEL: 262-0788

GUATEMALA

Casa Instrumental
Calzada Roosevelt 34-01,zona 11
Ciudad de Guatemala
Guatemala
TEL:(502) 599-2888

HONDURAS

Almacen Pajaro Azul S.A. de CV.
BO.Paz Barahona
3 Ave.11 Calle S.O
San Pedro Sula, Honduras
TEL: (504) 553-2029

MARTINIQUE

Musique & Son
Z.I.Les Mangle
97232 Le Lamantin
Martinique F.W.I.
TEL: 596 596 426860

Gigamusik SARL
10 Rte De La Folie
97200 Fort De France
Martinique F.W.I.
TEL: 596 596 715222

MEXICO

Casa Veerkamp, s.a. de cv.
Av. Toluca No. 323, Col. Olivar
de los Padres 01780 Mexico
D.F. MEXICO
TEL: (55) 5668-6699

NICARAGUA

Bansbach Instrumentos
Musicales Nicaragua
Altamira D'Este Calle Principal
de la Farmacia 5ta.Avenida
1 Cuadra al Lago.#503
Managua, Nicaragua
TEL: (505)277-2557

PANAMA

SUPRO MUNDIAL, S.A.
Boulevard Andrews, Albrook,
Panama City, REP. DE
PANAMA
TEL: 315-0101

PARAGUAY

Distribuidora De
Instrumentos Musicales
J.E. Olear y ESQ. Manduvira
Asuncion PARAGUAY
TEL: (595) 21 492147

PERU

Audionet
Distribuciones Musicales SAC
Juan Fanning 530
Miraflores
Lima - Peru
TEL: (511) 4461388

TRINIDAD

AMR Ltd
Ground Floor
Maritime Plaza
Barataria Trinidad W.I.
TEL: (868) 638 6385

URUGUAY

Todo Musica S.A.
Francisco Acuna de Figueroa
1771
C.P.: 11.800
Montevideo, URUGUAY
TEL: (02) 924-2335

VENEZUELA

Instrumentos Musicales
Allegra,C.A.
Av.las industrias edf.Guitar
import
#7 zona Industrial de Turumo
Caracas, Venezuela
TEL: (212) 244-1122

EUROPE

AUSTRIA

Roland Elektronische
Musikinstrumente HmbH.
Austrian Office
Eduard-Bodem-Gasse 8,
A-6020 Innsbruck, AUSTRIA
TEL: (0512) 26 44 260

BELGIUM/FRANCE/ HOLLAND/ LUXEMBOURG

Roland Central Europe N.V.
Houtstraat 3, B-2260, Oevel
(Westerlo) BELGIUM
TEL: (014) 575811

CROATIA

ART-CENTAR
Degenova 3.
HR - 10000 Zagreb
TEL: (1) 466 8493

CZECH REP.

CZECH REPUBLIC
DISTRIBUTOR s.r.o.
Votárova 247/16
CZ - 180 00 PRAHA 8,
CZECH REP.
TEL: (2) 830 20270

DENMARK

Roland Scandinavia A/S
Nordhavnsvej 7, Postbox 880,
DK-2100 Copenhagen
DENMARK
TEL: 3916 6200

FINLAND

Roland Scandinavia AS, Filial
Finland
Elannontie 5
FIN-01510 Vantaa, FINLAND
TEL: (09) 68 24 020

GERMANY

Roland Elektronische
Musikinstrumente HmbH.
Oststrasse 96, 22844
Norderstedt, GERMANY
TEL: (040) 52 60090

GREECE/CYPRUS

STOLLAS S.A.
Music Sound Light
155, New National Road
Patras 26442, GREECE
TEL: 2610 435400

HUNGARY

Roland East Europe Ltd.
Warehouse Area 'DEPO' Pf.83
H-2046 Torokbalint,
HUNGARY
TEL: (23) 511011

IRELAND

Roland Ireland
G2 Calmount Park, Calmount
Avenue, Dublin 12
Republic of IRELAND
TEL: (01) 4299444

ITALY

Roland Italy S. p. a.
Viale delle Industrie 8,
20020 Arese, Milano, ITALY
TEL: (02) 937-78300

NORWAY

Roland Scandinavia Avd.
Kontor Norge
Lilleakerveien 2 Postboks 95
Lilleaker N-0216 Oslo
NORWAY
TEL: 2273 0074

POLAND

ROLAND POLSKA SP. Z O.O.
UL. Gibraltarska 4.
PL-03 664 Warszawa
POLAND
TEL: (022) 679 4419

PORTUGAL

Roland Iberia, S.L.
Portugal Office
Cais das Pedras, 8/9-1 Dto
4050-465, Porto, PORTUGAL
TEL: 22 608 00 60

ROMANIA

FBS LINES
Piata Libertatii 1,
535000 Gheorgheni,
ROMANIA
TEL: (266) 364 609

RUSSIA

MuTek
Dorozhnaya ul.3,korp.6
117 545 Moscow, RUSSIA
TEL: (095) 981-4967

SLOVAKIA

DAN Acoustic s.r.o.
Povazská 18,
SK - 940 01 Nové Zámky
TEL: (035) 6424 330

SPAIN

Roland Iberia, S.L.
Paseo Garcia Faria, 33-35
08005 Barcelona SPAIN
TEL: 93 493 91 00

SWEDEN

Roland Scandinavia A/S
SWEDISH SALES OFFICE
Danvik Center 28, 2 tr.
S-131 30 Nacka SWEDEN
TEL: (08) 702 00 20

SWITZERLAND

Roland (Switzerland) AG
Landstrasse 5, Postfach,
CH-4452 Itingen,
SWITZERLAND
TEL: (061) 927-8383

UKRAINE

EURHYTHMICS Ltd.
P.O.Box: 37-a
Nedecy Str. 30
UA - 89600 Mukachevo,
UKRAINE
TEL: (03131) 414-40

UNITED KINGDOM

Roland (U.K.) Ltd.
Atlantic Close, Swansea
Enterprise Park, SWANSEA
SA7 9JF,
UNITED KINGDOM
TEL: (01792) 702701

MIDDLE EAST

BAHRAIN

Moon Stores
No.16, Bab Al Bahrain Avenue,
P.O.Box 247, Manama 304,
State of BAHRAIN
TEL: 17 211 005

IRAN

MOCO INC.
No.401 Nike St., Dr.Shariyati Ave.,
Roberoye Cerahe Mirdamad
Tehran, IRAN
TEL: (021) 285-4169

ISRAEL

Halilit P. Greenspoon & Sons
Ltd.
8 Retzif Ha'aliya Hashnya St.
Tel-Aviv-Yafo ISRAEL
TEL: (03) 6823666

JORDAN

MUSIC HOUSE CO. LTD.
FREDDY FOR MUSIC
P. O. Box 922846
Amman 11192 JORDAN
TEL: (06) 5692696

KUWAIT

EASA HUSAIN AL-YOUSIFI
& SONS CO.
Abdullah Salem Street,
Safat, KUWAIT
TEL: 243-6399

LEBANON

Chahine S.A.L.
Gerge Zeidan St., Chahine
Bldg., Achrafieh, P.O.Box: 16-
5857
Beirut, LEBANON
TEL: (01) 20-1441

OMAN

TALENTZ CENTRE L.L.C.
Malatan House No.1
Al Noor Street, Ruwi
SULTANATE OF OMAN
TEL: 2478 3443

QATAR

Al Emadi Co. (Badie Studio &
Stores)
P.O. Box 62, Doha, QATAR
TEL: 4423-554

SAUDI ARABIA

aDawlah Universal
Electronics APL
Corniche Road, Aldossary
Bldg., 1st Floor, Alkhobar,
SAUDI ARABIA

P.O.Box 2154, Alkhobar 31952
SAUDI ARABIA
TEL: (03) 898 2081

SYRIA

Technical Light & Sound
Center
Rawda, Abdul Qader Jazairi St.
Bldg. No. 21, P.O.Box 13520,
Damascus, SYRIA
TEL: (011) 223-5384

TURKEY

ZUHAL DIS TICARET A.S.
Galip Dede Cad. No.37
Beyoglu - Istanbul / TURKEY
TEL: (0212) 249 85 10

U.A.E.

Zak Electronics & Musical
Instruments Co. L.L.C.
Zabeel Road, Al Sherouq Bldg.,
No. 14, Grand Floor, Dubai,
U.A.E.
TEL: (04) 3360715

NORTH AMERICA

CANADA

Roland Canada Ltd.
(Head Office)
5480 Parkwood Way
Richmond B. C., V6V 2M4
CANADA
TEL: (604) 270 6626

Roland Canada Ltd.

(Toronto Office)
170 Admiral Boulevard
Mississauga On L5T 2N6
CANADA
TEL: (905) 362 9707

U. S. A.

Roland Corporation U.S.
5100 S. Eastern Avenue
Los Angeles, CA 90040-2938,
U. S. A.
TEL: (323) 890 3700



This product complies with the requirements of European Directive 89/336/EEC.

For EU Countries

FEDERAL COMMUNICATIONS COMMISSION RADIO FREQUENCY INTERFERENCE STATEMENT

This equipment has been tested and found to comply with the limits for a Class B digital device, pursuant to Part 15 of the FCC Rules. These limits are designed to provide reasonable protection against harmful interference in a residential installation. This equipment generates, uses, and can radiate radio frequency energy and, if not installed and used in accordance with the instructions, may cause harmful interference to radio communications. However, there is no guarantee that interference will not occur in a particular installation. If this equipment does cause harmful interference to radio or television reception, which can be determined by turning the equipment off and on, the user is encouraged to try to correct the interference by one or more of the following measures:

- Reorient or relocate the receiving antenna.
- Increase the separation between the equipment and receiver.
- Connect the equipment into an outlet on a circuit different from that to which the receiver is connected.
- Consult the dealer or an experienced radio/TV technician for help.

This device complies with Part 15 of the FCC Rules. Operation is subject to the following two conditions:

- (1) This device may not cause harmful interference, and
- (2) This device must accept any interference received, including interference that may cause undesired operation.

Unauthorized changes or modification to this system can void the users authority to operate this equipment. This equipment requires shielded interface cables in order to meet FCC class B Limit.

For the USA

NOTICE

This Class B digital apparatus meets all requirements of the Canadian Interference-Causing Equipment Regulations.

AVIS

Cet appareil numérique de la classe B respecte toutes les exigences du Règlement sur le matériel brouilleur du Canada.

For Canada



This product must be disposed of separately
at your local waste recycling centre.
Do not dispose of in household waste bin.



04016689

07-02-4N