



Convertible Speaker Dock

RF-HV3



Convertible Speaker Dock

Contents

Important safety instructions	3
Features.....	4
Package contents	4
Top	4
Back	5
Remote control.....	6
Power LED indicator	7
Setting up your dock.....	8
Connecting power	8
Installing remote control batteries	9
Using your convertible speaker dock.....	10
Docking an iPod or iPhone	10
Using landscape mode	12
Troubleshooting	14
Specifications	14
Compatibility (iPod & iPhone).....	14
Legal notices	15
One-year limited warranty	16

Important safety instructions

Note to reviewers: The following is the standard Best Buy safety instructions. Please review and let us know what items to delete. We can add addition items if required.

- 1 Read these instructions.
- 2 Keep these instructions.
- 3 Heed all warnings.
- 4 Follow all instructions.
- 5 Do not use this apparatus near water.
- 6 Clean only with a dry cloth.
- 7 Do not block any ventilation openings. Install in accordance with the manufacturer's instructions.
- 8 Do not install near any heat sources such as radiators, heat registers, stoves, or other apparatus (including amplifiers) that produce heat.
- 9 Do not defeat the safety purpose of the polarized or grounding-type plug. A polarized plug has two blades with one wider than the other. A grounding type plug has two blades and a third grounding prong. The wide blade or the third prong are provided for your safety. If the provided plug does not fit into your outlet, consult an electrician for replacement of the obsolete outlet.
- 10 Protect the power cord from being walked on or pinched particularly at plugs, convenience receptacles, and the point where they exit from the apparatus.
- 11 Only use attachments/accessories specified by the manufacturer.
- 12 Use only with the cart, stand, tripod, bracket, or table specified by the manufacturer, or sold with the apparatus. When a cart is used, use caution when moving the cart/apparatus combination to avoid injury from tip-over.
- 13 Unplug this apparatus during lightning storms or when unused for long periods of time.
- 14 Refer all servicing to qualified service personnel. Servicing is required when the apparatus has been damaged in any way, such as power-supply cord or plug is damaged, liquid has been spilled or objects have fallen into the apparatus, the apparatus has been exposed to rain or moisture, does not operate normally, or has been dropped.
- 15 To reduce the risk of fire or electric shock, do not expose this device to rain, moisture, dripping, or splashing, and no objects filled with liquids, such as vases, shall be placed on it.



- 16 An apparatus with a three-prong, grounding-type plug is a Class I apparatus, which needs to be grounded to prevent possible electric shock. Make sure that you connect this Class I device to a grounding-type, three-prong outlet.
- 17 The wall plug is the disconnecting device. The plug must remain readily operable.
- 18 Batteries should not be exposed to excessive heat such as sunshine, fire, or the like.

Caution: Danger of explosion if battery is incorrectly replaced. Replace only with the same or equivalent type.

Features

- Certified iPod connector installed for iPods and iPhones
- Charges iPods and iPhones when docked
- Digital volume control
- 3.5mm type line-in jack for use with other music players

Package contents

- Convertible speaker dock
- Seven dock adapters for iPods and iPhones
- AC adapter
- IR remote control
- *Quick Setup Guide*

Top

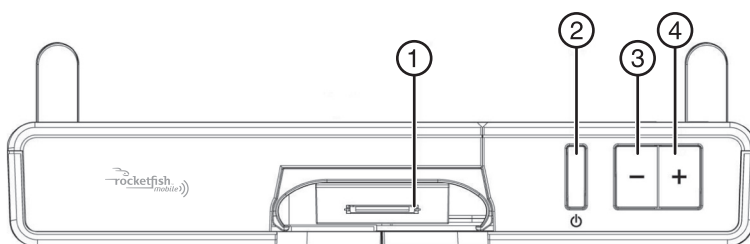

#	Component	Description
1	iPhone dock	Insert your iPhone into this dock.
2	⏻ (power button)	Press to turn the speakers on or off.
3	- (volume down)	Press to decrease the speaker volume.
4	+ (volume up)	Press to increase the speaker volume.

Back

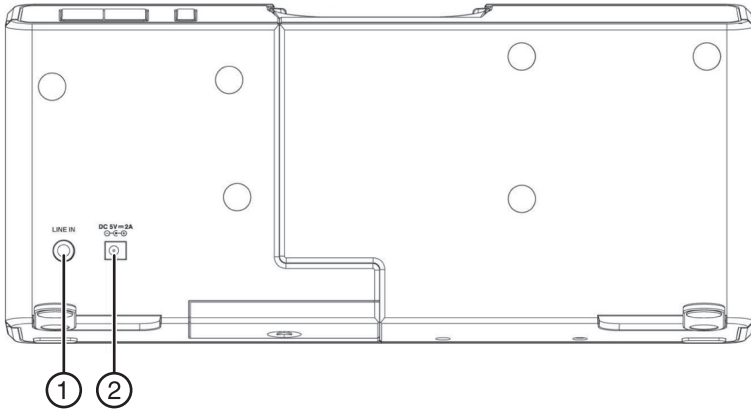

#	Component	Description
1	LINE IN jack	Plug an external audio device into this 3.5mm jack. Note: If you have a device connected to this jack, it takes priority over an iPod inserted into the iPod dock. To listen to the iPod, unplug the device connected to the LINE IN jack.
2	DC IN jack	Plug the AC adapter into this jack and into a power outlet.

Remote control

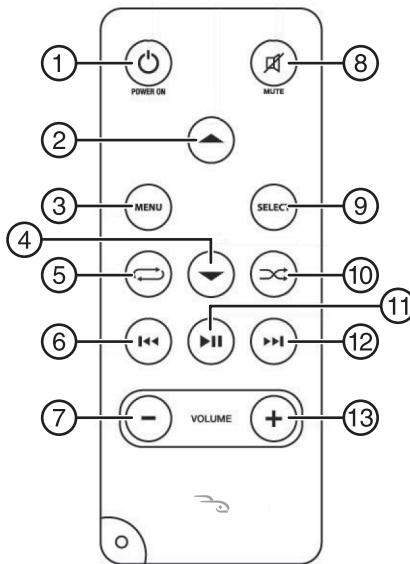

#	Button	Description
1	POWER ON	Press to turn the speakers on or off.
2		Press to navigate up in a docked iPod or iPhone menu.
3	MENU	Press to open or close a docked iPod or iPhone menu.
4		Press to navigate down in a docked iPod or iPhone menu.
5	(repeat)	Press to repeat the current audio track. Press twice to repeat the entire album or playlist. Press three times to turn off the repeat option.
6	(previous)	Press to skip to the previous file. Press and hold to search backwards through an audio or video file on a docked iPod or iPhone.
7	VOLUME-	Press to decrease the speaker volume.
8	(mute)	Press to turn off the speaker volume. Press again to turn on the speaker volume.
9	SELECT	Press to make a selection on a docked iPod or iPhone.
10	(shuffle)	Press to play files on a docked iPod in random order. Press again to turn off the shuffle option.
11	(play/pause)	Press to play or pause a file on a docked iPod or iPhone.
12	(next)	Press to skip to the next file. Press and hold to search forwards through an audio or video file on a docked iPod or iPhone.
13	VOLUME+	Press to increase speaker volume.

Power LED indicator

Your speaker dock has a power LED indicator on the top.

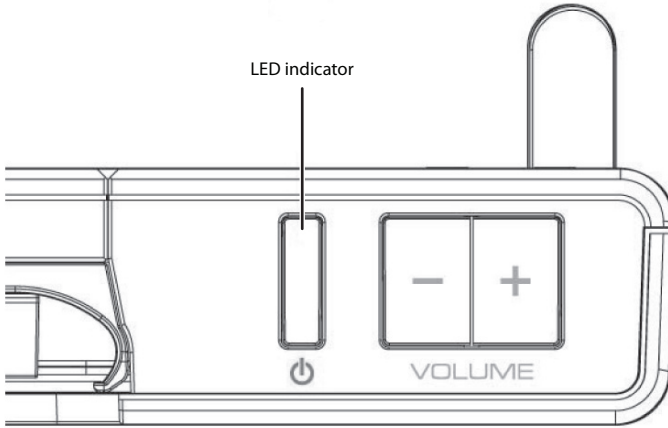

LED state	Description
Off	Your dock is in standby mode. Warning: When your dock is in standby mode, power is still flowing into it. To disconnect all power, unplug the AC adapter and remove the batteries.
On	Your dock is tuned on.
Blinking	Speakers are muted.

Setting up your dock

Connecting power

You can use the AC adapter or batteries to power your dock.

To connect the AC adapter:

- Plug the AC adapter into the DC 5V jack on the back of your dock and into a power outlet.

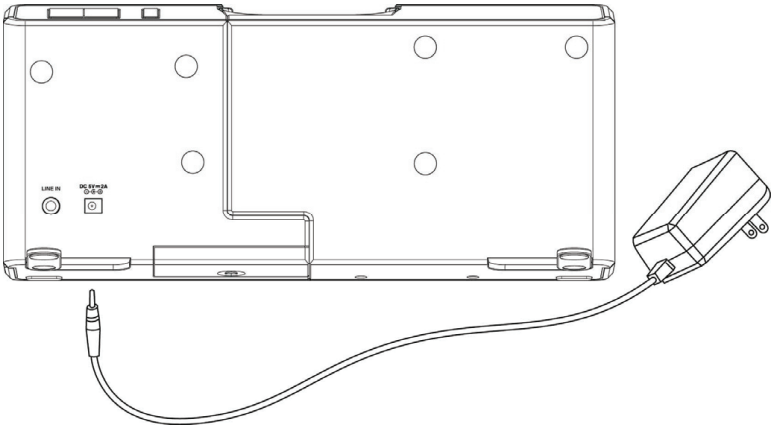

To install batteries:

- 1 Remove the battery compartment cover on the bottom of your dock.

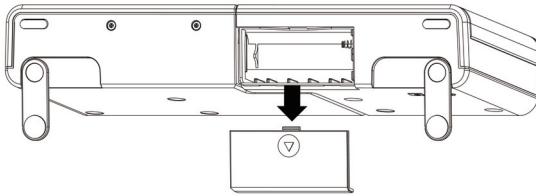

- 2 Insert four AAA batteries (not included) into the battery compartment. Make sure that the + and – symbols on the batteries align with the + and – symbols inside the battery compartment.

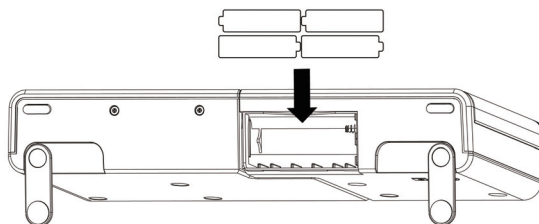

- 3 Replace the battery compartment cover.

*Note: When you operate **your dock** on battery power, it does not charge a docked iPod or iPhone.*

Installing remote control batteries

To install remote control batteries:

- 1 Slide the battery compartment cover to open the battery compartment.

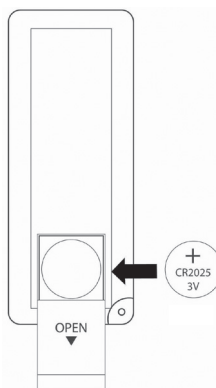

- 2 Insert a CR2025 3V battery (provided) into the battery compartment with the + side up.
- 3 Slide the battery compartment cover back into place to close the battery compartment.

Using your convertible speaker dock

Docking an iPod or iPhone





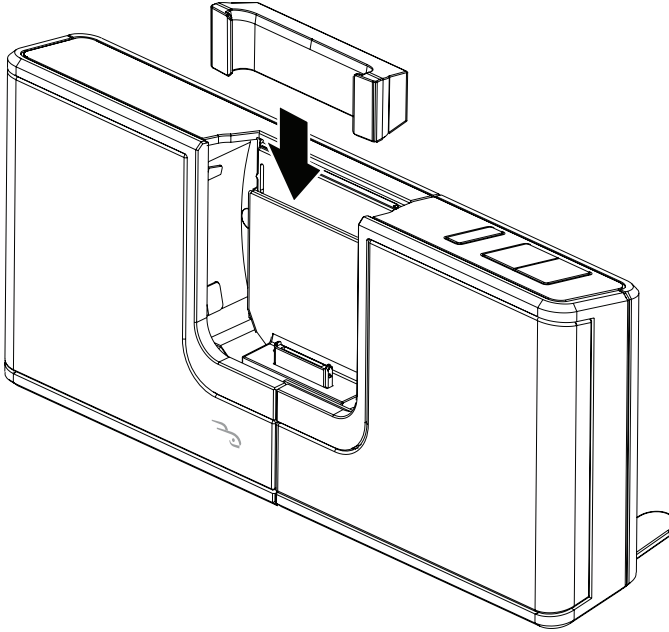

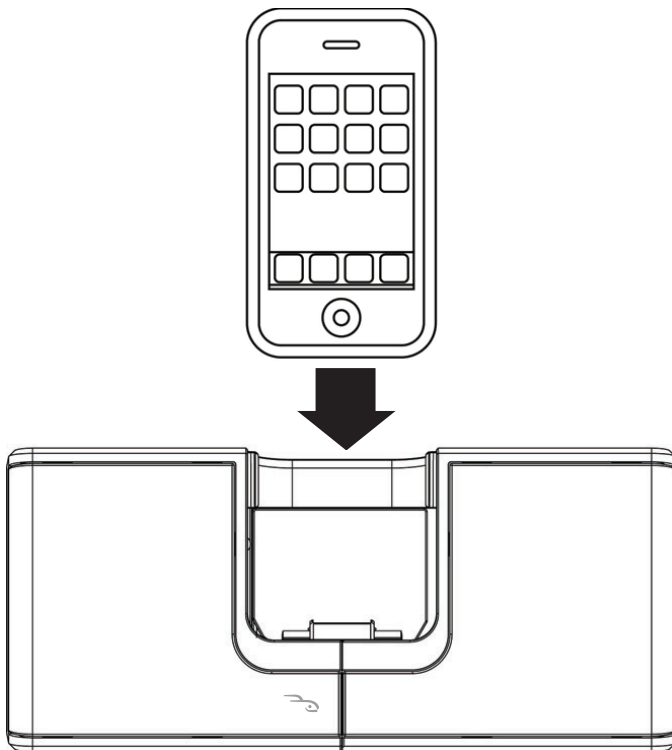

To dock an iPhone or iPod:



- 1 Select and insert the correct adapter for your iPhone or iPod. Each adapter is labeled with the specific device it is used for.



- 2 Insert your iPhone or iPod into the dock.



- 3 Press  to turn on your dock speakers.
- 4 Press  on the remote control or on the docked iPhone or iPod to start playing a music or video file.
- 5 To control playback:
 - Press  to pause or resume playback.
 - Press  to turn off the speaker sound. Press again to turn the sound back on.
 - Press  or  to go to the previous or next file.
 - Press and hold  or  to search backward or forward in a file.
 - Press  (repeat) once to repeat the current file. Press twice to repeat the entire album or playlist. Press three times to turn off the repeat feature.

- Press  (shuffle) to play files randomly. Press again to turn off the shuffle feature.
- 6 Press  to turn off your dock speakers.

Using landscape mode

To use landscape mode:

- 1 Select and insert the correct adapter for your iPhone or iPod. Each adapter is labeled with the specific device it is used for.
- 2 Insert your iPhone or iPod into the dock.

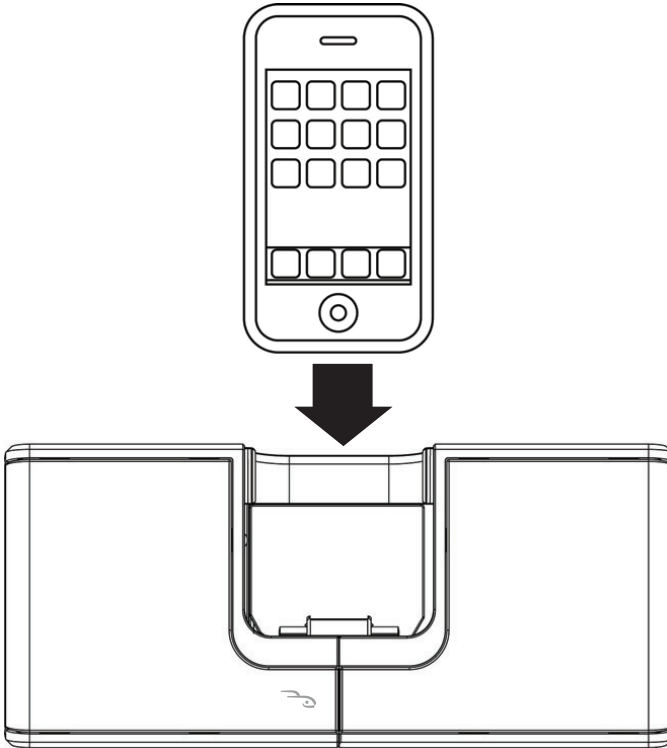

- 3 Pull out on the speakers to extend them.

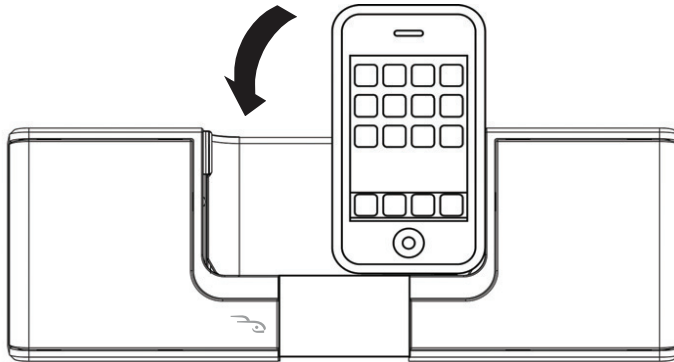

- 4 Rotate your iPod or iPhone to the left to use it in landscape mode.

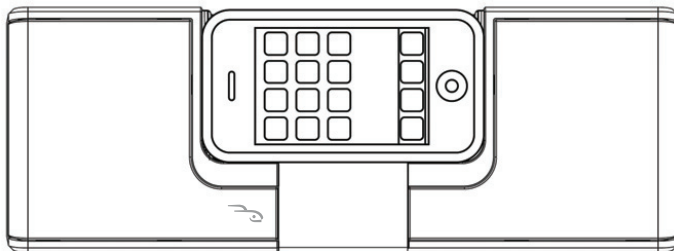

Troubleshooting

Problem	Solution
Sound is not clear or there is no sound	Make sure that the iPod or iPhone is inserted correctly and that you are using the correct adapter. If you have connected a device to the LINE IN jack, make sure that it is securely connected to the jack.
No power	Make sure that the AC adapter is connected securely and correctly. If you are using batteries to power your iPod dock, make sure that the batteries are installed correctly. If the batteries are depleted, change the batteries.
Sound is too low or too distorted	Press the VOLUME – button to turn down the volume. You may need to turn down the volume on the docked iPod or iPhone.
Too much distortion	If you are using batteries, the battery charge may be low. Replace the batteries.
Cannot exit standby mode when playing music from an iPod	Make sure that there is no cable connected to the LINE IN jack.
Battery life is too short	Remove the batteries from the battery compartment when your iPod dock is not in use.
Cannot control the iPod dock using the remote control	Make sure that a battery is installed in the remote control. Make sure that there is no obstacle between the remote control and your iPod dock. Replace the remote control battery.
iPod menu navigation does not work correctly	Make sure that you iPod or iPhone is not in landscape mode.

Specifications

- Total 6W output (3W / channel)
- Mid range (40 mm) per satellite
- Distortion: $\leq 10\%$
- S/N ratio: $>65\text{dB}@1\text{W}$
- Frequency response: 200Hz - 16k Hz
- Provided AC: 5VDC @ 2A

Compatibility (iPod & iPhone)

- iPod ^{1st} touch
- iPod ^{2nd} touch
- iPod Classic (80G and 120G version only)
- iPod ^{4th} nano
- iPod ^{3rd} nano
- iPod ^{2nd} nano
- iPhone 2G
- iPhone 3G
- iPhone 3Gs

Legal notices

FCC Part 15

This device complies with Part 15 of the FCC Rules. Operation of this product is subject to the following two conditions: (1) this device may not cause harmful interference, and (2) this device must accept any interference received, including interference that may cause undesired operation.

This equipment has been tested and found to comply within the limits for a class B digital device, pursuant to Part 15 of the FCC Rules. These limits are designed to provide reasonable protection against harmful interference in a residential installation. This equipment generates, uses, and can radiate radio frequency energy and, if not installed and used in accordance with the instructions, may cause harmful interference to radio communications. However, there is no guarantee that interference will not occur in a particular installation. If this equipment does cause harmful interference to radio or television reception, which can be determined by turning the equipment off and on, the user is encouraged to try to correct the interference by one or more of the following measures:

- Reorient or relocate the receiving antenna.
- Increase the separation between the equipment and receiver.
- Connect the equipment into an outlet on a circuit different from that to which the receiver is connected.
- Consult the dealer or an experienced radio/TV technician for help.

FCC warning

Changes or modifications not expressly approved by the party responsible for compliance with the FCC Rules could void the user's authority to operate this equipment.

Canada ICES-003 statement

This Class B digital apparatus complies with Canadian ICES-003.

One-year limited warranty

Rocketfish Products ("Rocketfish") warrants to you, the original purchaser of this new **RF-HV3** ("Product"), that the Product shall be free of defects in the original manufacture of the material or workmanship for one (1) year from the purchase of the Product ("Warranty Period"). This Product must be purchased from an authorized dealer of Rocketfish brand products and packaged with this warranty statement. This warranty does not cover refurbished Product. If you notify Rocketfish during the Warranty Period of a defect covered by this warranty that requires service, terms of this warranty apply.

How long does the coverage last?

The Warranty Period lasts for one year (365 days), beginning on the date you purchased the Product. The purchase date is printed on the receipt you received with the product.

What does this warranty cover?

During the Warranty Period, if the original manufacture of the material or workmanship of the Product is determined to be defective by an authorized Rocketfish repair center or store personnel, Rocketfish will (at its sole option): (1) repair the Product with new or rebuilt parts; or (2) replace the Product at no charge with new or rebuilt comparable products or parts. Products and parts replaced under this warranty become the property of Rocketfish and are not returned to you. If service of Products and parts are required after the Warranty Period expires, you must pay all labor and parts charges. This warranty lasts as long as you own your Rocketfish Product during the Warranty Period. Warranty coverage terminates if you sell or otherwise transfer the Product.

How to obtain warranty service?

If you purchased the Product at a retail store location, take your original receipt and the Product to the store you purchased it from. Make sure that you place the Product in its original packaging or packaging that provides the same amount of protection as the original packaging. If you purchased the Product from an online web site, mail your original receipt and the Product to the address listed on the web site. Make sure that you put the Product in its original packaging or packaging that provides the same amount of protection as the original packaging.

Where is the warranty valid?

This warranty is valid only to the original purchaser of the Product in the United States, Canada, and Mexico.

What does the warranty not cover?

This warranty does not cover:

- Customer instruction
- Installation
- Set up adjustments
- Cosmetic damage
- Damage due to acts of God, such as lightning strikes
- Accident
- Misuse
- Abuse
- Negligence
- Commercial use
- Modification of any part of the Product, including the antenna

This warranty also does not cover:

- Damage due to incorrect operation or maintenance

- Connection to an incorrect voltage supply
- Attempted repair by anyone other than a facility authorized by Rocketfish to service the Product
- Products sold as is or with all faults
- Consumables, such as fuses or batteries
- Products where the factory applied serial number has been altered or removed

REPAIR REPLACEMENT AS PROVIDED UNDER THIS WARRANTY IS YOUR EXCLUSIVE REMEDY. ROCKETFISH SHALL NOT BE LIABLE FOR ANY INCIDENTAL OR CONSEQUENTIAL DAMAGES FOR THE BREACH OF ANY EXPRESS OR IMPLIED WARRANTY ON THIS PRODUCT, INCLUDING, BUT NOT LIMITED TO, LOST DATA, LOSS OF USE OF YOUR PRODUCT, LOST BUSINESS OR LOST PROFITS. ROCKETFISH PRODUCTS MAKES NO OTHER EXPRESS WARRANTIES WITH RESPECT TO THE PRODUCT, ALL EXPRESS AND IMPLIED WARRANTIES FOR THE PRODUCT, INCLUDING, BUT NOT LIMITED TO, ANY IMPLIED WARRANTIES OF AND CONDITIONS OF MERCHANTABILITY AND FITNESS FOR A PARTICULAR PURPOSE, ARE LIMITED IN DURATION TO THE WARRANTY PERIOD SET FORTH ABOVE AND NO WARRANTIES, WHETHER EXPRESS OR IMPLIED, WILL APPLY AFTER THE WARRANTY PERIOD. SOME STATES, PROVINCES AND JURISDICTIONS DO NOT ALLOW LIMITATIONS ON HOW LONG AN IMPLIED WARRANTY LASTS, SO THE ABOVE LIMITATION MAY NOT APPLY TO YOU. THIS WARRANTY GIVES YOU SPECIFIC LEGAL RIGHTS, AND YOU MAY ALSO HAVE OTHER RIGHTS, WHICH VARY FROM STATE TO STATE OR PROVINCE TO PROVINCE.

Contact Rocketfish:

For customer service please call 1-800-620-2790

www.rocketfishproducts.com

Distributed by Best Buy Purchasing, LLC

7601 Penn Avenue South, Richfield, Minnesota, U.S.A. 55423-3645

© 2009 Best Buy Enterprise Services, Inc.

All rights reserved. ROCKETFISH is a trademark of Best Buy Enterprise Services, Inc. Registered in some countries. All other products and brand names are trademarks of their respective owners.



www.rocketfishproducts.com (800) 620-2790

Distributed by Best Buy Purchasing, LLC

7601 Penn Avenue South, Richfield, MN 55423-3645 USA

© 2009 Best Buy Enterprise Services, Inc.

All rights reserved. ROCKETFISH is a trademark of Best Buy Enterprise Services, Inc.
All other products and brand names are trademarks of their respective owners.