

Installation and Maintenance

IV

**Octel 200 and Octel 300
Message Servers**

**Installation and Maintenance Manual
Serenade 2.0 and Serenade 3.0**

July 1998

**Lucent Technologies
Octel Messaging Division
1001 Murphy Ranch Road
Milpitas, CA 95035-7912 USA**

Lucent Technologies
Bell Labs Innovations



Your comments are welcome. They can assist us in improving our products. Please address your comments to techpubs@octel.com or to the EMG Technical Publications Manager at

Lucent Technologies
Octel Messaging Division (OMD)
1001 Murphy Ranch Road
Milpitas, CA 95035-7912
USA
408-324-2000
www.octel.com

This manual contains confidential and proprietary information of Octel Communications Corporation, a subsidiary of Lucent Technologies and is protected by the copyright laws of the United States, international copyright treaties, and all other applicable national laws. Any unauthorized use, reproduction, or transfer of any information in this manual is strictly prohibited. © Copyright 1998 by Octel Communications Corporation, a subsidiary of Lucent Technologies. (subject to limited distribution and restricted disclosure). All Rights Reserved.

This manual contains information regarding technology that is protected under one or more of the following United States patents: Nos. 4,371,752; 4,580,012; 4,580,016; 4,581,486; 4,585,906; 4,602,129; 4,640,991; 4,652,700; 4,757,525; 4,471,807; 4,747,124, 4,783,796, and others; certain foreign patents, and other pending United States and foreign patents.

Restricted Rights Notice

Use, duplication, or disclosure by the United States Government is subject to restrictions as set forth in subparagraphs (c) (1) of the Commercial Computer Software – Restricted Rights clause at FAR Section 52.227-19 and restrictions set forth in the accompanying end user agreement, or (c)(1)(ii) of the Rights in Technical Data and Computer Software clause at DFARS Section 252.227-7013, whichever is applicable. Unpublished – rights reserved under the copyright laws of the United States. Lucent Technologies Octel Messaging Division (OMD), 1001 Murphy Ranch Road, Milpitas, CA 95035-7912, USA.

All trademarks identified by the ™ or ® symbol are trademarks or registered trademarks, respectively, of Octel Communications Corporation, a subsidiary of Lucent Technologies. All other trademarks belong to their respective owners.

This 3-volume Installation and Maintenance Manual supports the Octel 200 and Octel 300.

Part Number PB60014-01

July 1998
Printed in USA



Printed on recycled paper

COMPLIANCE STATEMENTS

FCC PART 68 NOTICE TO USERS

This equipment complies with Part 68 of the FCC rules. On the back of this equipment is a label that contains, among other information, the FCC registration number and ringer equivalence number (REN) for this equipment. If requested, this information must be provided to the telephone company.

The REN is used to determine the quantity of devices that can be connected to the telephone line. Excessive RENs on the telephone line may result in the device not ringing in response to an incoming call. In most but not all areas, the sum of the RENs should not exceed five(5.0). To be certain of the number of devices that may be connected to the line, as determined by the total RENs contact the telephone company for the maximum REN in your area.

If this equipment causes harm to the telephone network, the telephone, the telephone company will notify you in advance that temporary discontinuance of service may be required. If advance notice is not practical, the telephone company will notify the customer as soon as possible. Also, you will be advised of your right to file a complaint with the FCC.

The telephone company may make changes in its facilities, equipment, operations, or procedures that could affect the operation of the equipment. If this happens, the telephone company will provide advance notice in order for you to make the necessary modifications in order to maintain uninterrupted service.

If trouble is experienced with the equipment, please contact:

- Technical Assistance Center (TAC) The TAC supports distributors, GBS customers, and direct field service engineers in the United States of America.

408-922-1822

If the trouble is causing harm to the network, the telephone company may request that you remove the equipment from the network until the problem is resolved.

Repairs should be performed by Octel Communications Corporation or an authorized representative of Octel Communications Corporation or the warranty or service agreement could be void.

This equipment cannot be used on telephone company-provided coin service.

Connection to Party Line Service is subject to state tariffs.

TELEPHONE CONSUMER PROTECTION ACT OF 1991

The Telephone Consumer Protection Act of 1991 makes it unlawful for any person to use a computer or other electronic device to send any message via a telephone facsimile machine unless such message clearly contains, in a margin at the top or bottom of each transmitted page or on the first page of the transmission, the date and time it is sent and an identification of the business, other entity, or individual sending the message and the telephone number of the sending machine or such business, other entity, or individual.

ADJUNCTS — KX and PX DEVICES

If the O200 or O300 is to be used with a leased system, permission of the owner should be requested before its connection. The O200 / O300 when using either the APIC or NPIC is intended only for connection to a registered PBX and never directly to the network.

WARNING — FCC PART 15 COMPLIANCE

This equipment has been tested and found to comply with the limits for a Class A digital device pursuant to Part 15 FCC Rules. These limits are designed to provide reasonable protection against harmful interference when this equipment is operated in a commercial environment. This equipment generates, uses, and can radiate radio frequency energy and, if not installed and used in accordance with the instruction manual, may cause harmful interference to radio communications. Operation of this equipment in a residential area is likely to cause harmful interference, in which case the user will be required to correct the interference at his/her own expense. Any changes or modifications to this equipment not expressly approved by Octel Communications Corporation may void compliance with FCC requirements and the user's authority to operate the equipment.

UNITED KINGDOM REQUIREMENTS AND INSTRUCTIONS FOR USE

Introduction

The Octel Overture 300 message server is a 32 to 128 port voice messaging system and the Octel Overture 200 message server is a 4 to 64 port voice messaging system. When installed at a customer's site, the message server attaches to the extension lines of a PABX or directly to the public network via Direct Exchange Lines.

This document section describes certain operation requirements which must be complied with in the United Kingdom to allow connection of the message server to a PABX or directly to the public network.

► CAUTION ◀

Failure to comply to the requirements described in this document may invalidate the compliance of the apparatus, thus prohibiting its connection to the network in the United Kingdom.

► CAUTION ◀

The approval of this apparatus will be invalidated if it is used with internal software not formally accepted by BABT. The internal software is not accessible or alterable by the user.

► NOTICE ◀

There are no user serviceable parts, or user controls, in the system enclosure.

► NOTICE ◀

Interconnection directly, or by way of other apparatus, of Octel Overture 200 ports or Octel Overture 300 ports with ports which do not comply with the requirements of BS6301 may produce hazardous conditions on the BT network. Advice should be obtained from a competent engineer before such a connection is made.

► NOTICE ◀

When network addresses (telephone numbers) are manually entered into the system for auto-calling, care should be exercised to ensure that the addresses are correct

► NOTICE ◀

This apparatus is not to be used for making calls to the BT emergency service.

Ringer Equivalence

Under normal operating conditions, this apparatus is not meant to form part of a multiple installation; the port interfaces are the sole termination of the line. Additional apparatus, BT or otherwise, must not be connected between this equipment and the PABX line or public network.

Functions

The Octel Overture 200 and the Octel Overture 300 message servers have the following functions.

- Automatically answers calls redirected on no answer or busy conditions.
- Interrogates the caller for any messages.
- Stores the message.
- Forwards the message as and when appropriate.
- When connected to a PBX, the ability to answer and transfer a call.
- The option to place outgoing calls (through a PBX, or directly into the public network) for the purpose of delivering messages.

And the following outcalling functions.

- The system operator can store predetermined numbers to be dialed for outcalls within the message server. These numbers include pauses to allow for secondary proceed indications.
- The message server automatically schedules multiple call repeat attempts as required for unsuccessful outcalls. The times between calls and the number of repeat attempts conform to the requirements of the appropriate UK specifications.
- The message server is suitable for connection to a PABX that returns secondary proceed indication through the use of dialing pauses, as described above. For PABXs that do not return secondary proceed indication, the pauses are not used.

Pay Phones

The Octel Overture 200 and the Octel Overture 300 message servers are not suitable as an extension to a pay phone.

Keys

When the message server is in operation, and is not being serviced by maintenance personnel, the key to the enclosure shall be removed to prevent user (operator) access.

Outcall Configuration Requirements

The Octel Overture 200 and the Octel Overture 300 message servers have the capability to outcall via the PABX or directly to the public network via Direct Exchange Lines. The message server uses multi-frequency dialing. Loop disconnect dialing is not supported.

► CAUTION ◀

Failure to comply to the requirements described in this document may invalidate the compliance of the apparatus, thus prohibiting its connection to the network in the United Kingdom.

System Parameters

The following System Parameters are particular to the requirements for the UK. The installation engineer must verify that these parameters have the following assignments:

Number	System Parameter Name	Value
68	NET:REMOTE DELIVERY ATTEMPT LIMIT	20
69	NET:REMOTE DELAY BEFORE RETRY (MINUTES)	10

- ☞ Delays in dialing strings (D character) between the PABX access code and the rest of the digits must be between 3.5 and 8 seconds. Set D character timing in System Parameter 28 — “D” CHARACTER DELAY TIME.

INFORMATION Table Indices

The following INFORMATION Table indices are particular to the requirements for the UK. The installation engineer must verify that these indices have the following assignments:

Number	Information Table Index Name	Value
15	OFFSITE SPEAK TIMES	4
16	OFFSITE SPEAK DELAY	5

The values for INFORMATION Table Indices 15 and 16 must be set so that the total offhook time is less than 60 seconds. The above values meet that specification.

CANADIAN USER INFORMATION

Industry Canada Certification No. 883-4105A

NOTICE

The Industry Canada label identifies certified equipment. This certification means that the equipment meets certain telecommunications network protective, operational, and safety requirements. Industry Canada does not guarantee the equipment will operate to the user's satisfaction.

Before installing this equipment, users should ensure that it is permissible to be connected to the facilities of the local telecommunications company. The equipment must also be installed using an acceptable method of connection. In some cases, the company's inside wiring associated with a single line individual service may be extended by means of a certified connector assembly (telephone extension cord). The customer should be aware that compliance with the above conditions may not prevent degradation of service in some situations. Communication cables provided by the user to connect to the telecommunications network must be not less than 26 AWG copper.

Repairs should be performed by Octel Communications Corporation or an authorized representative of Octel Communications Corporation or the warranty or service agreement could be void. In the event that this equipment malfunctions, the telecommunications company may request that the equipment be disconnected.

Users should ensure for their own protection that the electrical ground connections of the power utility, telephone lines, and internal metallic water pipe system, if present, are connected together. This precaution may be particularly important in rural areas.

CAUTION

Users should not attempt to make such connections themselves, but should contact the appropriate electric inspection authority, or electrician, as appropriate. The equipment is installed by trained personnel.

The **Load Number** (LN) assigned to each terminal device denotes the percentage of the total load to be connected to a telephone loop which is used by the device, to prevent overloading. The termination on a loop may consist of any combination of devices subject only to the requirement that the total of the Load Numbers of all the devices does not exceed 100.

The load number of this product O200 / O300 is 19.

CANADIAN EMC STATEMENT

This Class A digital apparatus meets all the requirements of the Canadian Interference-Causing Equipment Regulations (ICES).

Industrie Canada:

Cet appareil numérique de la classe A respecte toutes les exigences du Règlement sur le matériel brouilleur du Canada (ICES).

AVIS: L'étiquette de L'Industrie Canada identifie le matériel homologué. Cette étiquette certifie que le matériel est conforme à certaines normes de protection, d'exploitation et de sécurité des réseaux de télécommunications. Industrie Canada n'assure toutefois pas que le matériel fonctionnera à la satisfaction de l'utilisateur.

Avant d'installer ce matériel, l'utilisateur doit s'assurer qu'il est permis de le raccorder aux installations de l'entreprise locale de télécommunication. Le matériel doit également être installé en suivant une méthode acceptée de raccordement. L'abonné ne doit pas oublier qu'il est possible que la conformité aux conditions énoncées ci-dessous n'empêchent pas la dégradation du service dans certaines situations.

Les réparations de matériel homologué doivent être effectuées par un centre d'entretien canadien autorisé désigné par le fournisseur. La compagnie de télécommunications peut demander à l'utilisateur de débrancher un appareil à la suite de réparations ou de modifications effectuées par l'utilisateur ou à cause de mauvais fonctionnement.

Pour sa propre protection, l'utilisateur doit s'assurer que tous les fils de mise à terre de la source d'énergie électrique, les lignes téléphoniques et les canalisations d'eau métalliques, s'il y en a, sont raccordées ensemble. Cette précaution est particulièrement importante dans les régions rurales.

AVERTISSEMENT: L'utilisateur ne doit pas tenter de faire ces raccordements de lui-même; il doit avoir recours à un service d'inspection des installations électriques, ou à un électricien, selon le cas.

La câble de télécommunications qui sont fournis par l'utilisateur ne doivent pas être inférieurs à 26 AWG de cuivre.

L'**Indice de Charge (IC)** assigné à chaque dispositif terminal indique, pour éviter toute surcharge, le pourcentage de la charge totale qui peut être raccordée à un circuit téléphonique bouclé utilisé par ce dispositif. La terminaison du circuit bouclé peut être constituée de n'importe quelle combinaison de dispositifs, pourvu que la somme des indices de charge de l'ensemble des dispositifs ne dépasse pas 100.

L'indice de charge de ce produit O200 / O300 est 19.

Octel Overture 200/300 Installation and Maintenance Manual

Installation & Maintenance volume

Table of Contents

Chapter 1 INSTALL

1.1	Understanding the INSTALL Program	1-1
1.2	Using INSTALL	1-4
1.3	Answering Questions in INSTALL	1-7
1.4	Answering Questions About Other Telephone Systems	1-24
1.5	Exiting Before the INSTALL is Complete	1-26

Chapter 2 Hardware

2.1	Hardware	2-1
-----	----------------	-----

Chapter 3 Preparing the Phone System

3.1	How the Octel Overture 200/300 Works with the Phone System	3-1
3.2	Determining Necessary Changes	3-5
3.3	Changes to Central Office Trunking	3-6
3.4	Phone System Configuration	3-8
3.5	Implementing the Octel Overture 200/300 on PBXs without DIL Feature	3-12

Chapter 4 Installation

4.1	Receiving the Equipment	4-1
4.2	Installation Requirements	4-4
4.3	PBX Preparation	4-15
4.4	Terminal Communications	4-16
4.5	Pin Assignments for Message Server Cards and Ports	4-21
4.6	Communicating with the Message Server	4-35
4.7	Octel Overture 200/300 Hardware Installation	4-37
4.8	Rack Mount Installation, Octel Overture 300	4-40
4.9	Software Installation	4-44
4.10	Connecting the Phone System to the Octel Overture 200/300	4-45
4.11	Octel Overture 200/300 Testing	4-50
4.12	Testing the Installation and Telephone Changes	4-58

Table of Contents (continued)

Chapter 5 Reports

5.1	Overview	5-1
5.2	Listing and Clearing Reports	5-2
5.3	System Performance Report	5-5
5.4	Network Traffic Report	5-16
5.5	User Message Statistics	5-21
5.6	User Calling Statistics	5-23
5.7	Disk Usage Report	5-25
5.8	Port Statistics	5-27
5.9	Mailbox Usage	5-31
5.10	User Status Detail	5-32
5.11	Integration Calling Statistics	5-33
5.12	System Performance by COS	5-35

Chapter 6 Maintenance Commands

6.1	Command Summary	6-1
6.2	Diagnostics	6-17
6.3	Application Delays	6-43
6.4	Message Block and Message Purge	6-52

Chapter 7 LOG Commands

7.1	LOG Command	7-1
7.2	Call Processing Trace (CPT)	7-5
7.3	Call Detail Record Log	7-22
7.4	Namesend Activity Trace Log	7-40
7.5	Moves, Add, and Changes Log	7-43
7.6	Server Activity Trace Log	7-50
Appendix A	Call-Processing Trace Activities	7A-1

Chapter 8 System Errors and Traffic Pegs

8.1	Boot ROM Diagnostics	8-1
8.2	Hardware Errors	8-4
8.3	Traffic Peg Count Table	8-37

Chapter 9 Hardware Replacement

9.1	Hardware Maintenance and Diagrams	9-1
9.2	Hardware Replacement Guidelines	9-12
9.3	Message Server Assembly Descriptions and Part Numbers	9-56

Table of Contents

(continued)

Chapter 10 Digital Trunk Interface Card (DTIC)

10.1	Digital Trunk Interface Card (DTIC) Overview	10-1
10.2	How to Configure the DTIC	10-3
10.3	Troubleshooting and Maintenance	10-10

Chapter 11 LAN Card

11.1	Overview	11-1
11.2	Installing and Configuring the LAN Card	11-2
11.3	Testing the LAN Card	11-6
11.4	Taking the LAN Card Out of Service	11-10
Appendix A	Internet Addressing	11A-1
Appendix B	Simple Network Management Protocol (SNMP)	11B-1
Appendix C	Octel Private MIB	11C-1

Chapter 12 Procedures

12.1	Electronic Feature Delivery	12-1
12.2	Floppy Diskette Backup Procedures	12-3
12.3	Floppy Diskette Restore Procedures	12-22
12.4	Floppy Directory	12-39
12.5	Errors	12-40
12.6	Hard Disk Procedures	12-41
12.7	Adding Languages	12-71

Octel Overture 200/300 Installation and Maintenance Manual

Installation & Maintenance volume

Table of Contents — Figures

Chapter 1 INSTALL

1-1	Order of Questions and Associated Tables in the INSTALL Program	1-2
-----	---	-----

Chapter 2 Hardware

2-1	Octel Overture 200 Cabinet Shelf Structure, From the Front	2-4
2-2	Octel Overture 200 Cabinet, Inside Front View	2-5
2-3	Octel Overture 200 Cabinet, Rear View	2-6
2-4	Octel Overture 200 Cabinet, Inside Rear View	2-7
2-5	Octel Overture 300 Cabinet Shelf Structure, From the Front	2-10
2-6	Octel Overture 300 Cabinet, Inside Front View	2-11
2-7	Octel Overture 300 Cabinet, Rear View	2-12
2-8	Octel Overture 300 Cabinet, Inside Rear View	2-13

Chapter 3 Preparing the Phone System

3-1	Octel Overture 200/300 Connection to Phone System	3-1
3-2	All Incoming Lines Directed to the Octel Overture 200/300	3-3
3-3	Incoming Calls Split Between Console and the Octel Overture 200/300	3-3
3-4	Sample Agency Letter for PE Changes	3-7
3-5	Service Provider Letter	3-11
3-6	Directing Incoming Calls to the Octel Overture 200/300 When the PBX Does Not Offer a DIL Feature ..	3-12

Chapter 4 Installation

4-1	Octel Overture 200 Floor Plan for Installation in the US, Canada and Mexico	4-6
4-2	Octel Overture 300 Floor Plan for Installation for the US, Canada, and Mexico	4-7
4-3	Octel Overture 200 Direct-Connect Installation	4-12
4-4	Octel Overture 300 Direct-Connect Installation	4-13
4-5	Diagram of the Field Wiring for -48-Vdc Powered Octel Overture 200	4-14
4-6	First and Second RS-232C Serial-Port Cable Pinouts for Connection to Terminal Equipment (DTE) ...	4-17
4-7	Octel Overture 200/300 to External Modem Pinouts	4-18
4-8	50-Pin Male Telco Connector Pinouts	4-21
4-9	Octel Overture 200/300 Cabinet Installed in 19-Inch Rack	4-40
4-10	Typical Octel Overture 200/300 Connections	4-45
4-11	Connector Block	4-47
4-12	Example of Server-to-Block Connections	4-48

Chapter 6 Maintenance Commands

6-1	Alarm Test Flow	6-38
6-2	Sequence Used by the Octel Overture 200/300 To Screen Calls	6-44
6-3	Ring/No Answer Tone-Timing Failure	6-47

Table of Contents — Figures (continued)

Chapter 8 System Errors and Traffic Pegs

8-1	Traffic Peg Count Table	8-57
-----	-------------------------	------

Chapter 9 Hardware Replacement

9-1	Shelf Structure in the Octel Overture 200	9-3
9-2	Inside Front View of Octel Overture 200	9-4
9-3	Octel Overture 200 Cabinet Rear View	9-5
9-4	Inside Rear View of Octel Overture 200	9-6
9-5	Shelf Structure of Octel Overture 300	9-8
9-6	Inside Front View of Octel Overture 300	9-9
9-7	Rear View of Octel Overture 300	9-10
9-8	Inside Rear View of Octel Overture 300	9-11
9-9	Card Cage Showing a Printed Circuit Assembly and an Option Control Chip	9-13
9-10	LED Placement on the LAN Card	9-18
9-11	DTIC–E1 Kit Installation for the Octel Overture 200	9-22
9-12	DTIC–E1 Kit Installation for the Octel Overture 300	9-22
9-13	Fax Application Processor	9-23
9-14	120–ohm DTIC–E1 Adapter	9-23
9-15	Fax Application Processor Replacement	9-24
9-16	Octel Overture 200 Hard-Disk-Drive Assembly	9-26
9-17	Octel Overture 300 Hard-Disk-Drive Assembly	9-26
9-18	Octel Overture 300 Floppy-Disk-Drive Assembly	9-28
9-19	Octel Overture 200 Power Supply Unit	9-30
9-20	Octel Overture 300 Power Supply Assembly	9-31
9-21	Motherboard Assembly	9-36
9-22	A.C. Backplane Power Harness Installation for Octel Overture 200	9-41
9-23	D.C. Backplane Power Harness Installation for Octel Overture 200	9-42
9-24	Power-Filter Assembly for 120-Vac and 240-Vac Domestic Octel Overture 300	9-43
9-25	Power-Filter Assembly for 240-Vac International Octel Overture 300	9-44
9-26	Power-Filter Assembly for 48-Vdc Octel Overture 300	9-45
9-27	Octel Overture 300 Disk-Drive Backplanes	9-46
9-28	Cutaway View of the Load-Resistor Assembly	9-48
9-29	Field Wiring for –48-Vdc Powered Octel Overture 300	9-51
9-30	Option Control Chip (OCC) Assembly	9-54
9-31	Location of Option Control Chip (OCC) in the Octel Overture 200/300	9-54

Chapter 10 Digital Trunk Interface Card (DTIC)

10-1	DTIC Component Layout	10-2
------	-----------------------	------

Octel Overture 200/300 Installation and Maintenance Manual

Installation & Maintenance volume

Table of Contents — Tables

Chapter 2 Hardware

2-1	Octel Overture 200/300 Subsystems	2-14
2-2	Octel Overture 200 Subsystems	2-17
2-3	Octel Overture 300 Subsystems	2-18
2-4	Power Supply Unit d.c. Voltages	2-23

Chapter 3 Preparing the Phone System

3-1	PBX Features to Direct Trunks to the Octel Overture 200/300	3-10
-----	---	------

Chapter 4 Installation

4-1	Input Circuit Current at Nominal Operating Line Voltage	4-5
4-2	Input Power Requirements	4-9
4-3	Equipment Provided by Distributor	4-14
4-4	DCE Pinouts for Cable Connections Between the RS-232C Terminal and the Octel Overture 200/300 ..	4-17
4-5	Pinouts for External Modem Connections	4-18
4-6	Power Supply Output Rating and Acceptable Operating Ranges	4-38
4-7	66M4-4W Connector Block Designators	4-49

Chapter 6 Maintenance Commands

6-1	FINDMBOX Messages and Descriptions	6-24
6-2	Abbreviations for Channel/Port State	6-35
6-3	Application Delays for Cadence Recognition, for Determining Tone On/Tone Off	6-54

Chapter 7 LOG Commands

7-1	Trace Activity Types	7-7
7-2	Transaction Type Descriptions	7-23
7-3	Descriptions of the CDR Status That Can Be Logged	7-24
7-4	Information Logged by Transaction Type	7-35
7-5	Call Detail Record Size by Transaction Type	7-36
7-6	Namesend Activity Types	7-40
7-7	Event and Aux Activities in Namesend Activity Log	7-42
7-8	SAT Log Activity Types	7-51

Chapter 8 System Errors and Traffic Pegs

8-1	Boot ROM Diagnostic Errors	8-2
8-2	Hardware Error Types and Remedies	8-6

Chapter 11 LAN Card

11-1	LED Activity on the LAN Card	11-5
11-2	CD and CU for LAN — Messages and Descriptions	11-12

INTRODUCTION

*Do I really have to read all this?
or
What's this manual all about, and how do I use it?*

Read on. The answer to the first question is **no**; not right now. The answer to the second question is in the pages that follow.

Welcome to the Octel Overture 200/300 Installation and Maintenance Manual (I&M)

The Octel Overture 200/300 System Administrator's Manual and the Octel Overture 200/300 Installation and Maintenance Manual (I&M) contain information about the Octel Overture 200 and the Octel Overture 300 message servers (Octel Overture 200/300).

 The I&M manual is **not** designed to be used as a standalone reference manual. Together, the SAM and I&M are the complete reference for the Octel Overture 200/300 message servers.

The Octel Overture 200/300 SAM & I&M volumes are designed to be used by people performing a variety of job functions at various stages of learning about and implementing Octel Overture 200/300 message servers. Some volumes educate, while others serve as a reference.

The manuals is not designed to be read straight through, or used only in reference to a question about Octel Overture 200/300 message servers. Instead, it offers a structure from which to approach Octel Overture 200/300 message servers — a sequence which closely parallels the process of discovery, assessment, design, and strategic implementation. It also suggests guidelines for directing readers to the chapters that will benefit them the most, based on their interests, job functions, and customer needs.

This introduction is divided into the following segments that explain aspects of the manuals.

- Conventions
- Volume description
- Chapters to read by job function
- Product Description* chapter descriptions

Conventions

The conventions used in this manual are described below.

Text	This typeface represents normal text in this manual.
-------------	--

Common terms	The term Octel Overture 200/300 is used throughout this manual to refer the Octel Overture 200 and the Octel Overture 300 message server.
---------------------	--

The term **VMX 5000/1000** is used to refer to the VMX 5000 and the VMX 1000.

The term **PBX** is used to refer to Private Automatic Branch Exchange, key telephone systems, and Centrex telephone service and key telephone systems.

Refer to the System Administrator's Manual, *Product Description* volume, Glossary, for a complete list of terms and definitions used in this manual.

Quick Reference Guide (QRG)

The Quick Reference Guide (QRG) appears at the beginning of certain chapters and summarizes commands and key points that are discussed in more detail within the chapter.

Octel Overture 200/300 screen sample

Octel Overture 200/300 screens are represented in the following type face and are surrounded by a gray box:

```
-----SYSTEM SOFTWARE  RELEASE S.X.X.X  (MM/DD/YY)-----  
DAY MM/DD HH:MM:SS YYYY NAME ID:XXXXXX S/N:XXXXX PBX:XX
```

User entries within screens

Commands entered from a terminal are represented in this type:

```
@INSTAL
```

PBX screens

This partial screen is a sample of the type face and format used to represent PBX screens:

```
Page 3 of 3  
  
STATION  
  
DISPLAY BUTTON ASSIGNMENTS
```

Keys on the telephone key pad and all terminals

Keys that are entered from a telephone key pad or terminal function keys are represented within a box.

An example of a telephone key pad entry is: 9

An example of a key on a terminal is: Escape

Executing commands

Octel Overture 200/300 commands are executed by pressing either the `Return` key or the `Enter` key, depending on which key is available on the terminal. `Enter` is used throughout this manual and is interchangeable with `Return`.

Octel Overture 200/300 prompts

When text represents a prompt spoken by the Octel Overture 200/300, it is printed in italics and enclosed in quotes.

“Thank you. Just a moment.”

Notes

This is the format for a note.

☞ Please refer to the *Configuration* volume, User Table chapter.

The following lists the chapters in each of the three volumes in the Installation and Maintenance Manual.

Installation and Maintenance Volume

INSTALL

Hardware

Preparing the Phone System

Installation

Reports

Maintenance Commands

LOG Commands

System Errors and Traffic Pegs

Hardware Replacement

DTIC Card

LAN Card

Procedures

Integration Volume

Standard DTMF Integration

Adaptive Integration

Enhanced DTMF In-band Integration

Centrex SMDI/SMSI

NEC NEAX-2400

Northern Telecom SL-1

AT&T (ATTIC Integration)

Definity G3

System 75/Definity G1

System 85/Definity G2

ROLM
 CBX
 9751 Model 30/80
Cortelco Millenium
Mitel
 SX-200 Digital
 SX-200/SX-100 Analog
 SX-2000
Meridian 1
AT&T APIC Integration
 Definity G3
 System 75/Definity G1
 System 85/Definity G2
Northern Telecom NPIC Integration

Networking

Networking
Analog Networking
 Remote Analog Networking (Voicenet, OctelNet, and AMIS)
 Collocated Analog Networking
Digital Networking (Remote and Domain)
Network Name Confirmation
Location Table
Numbering Plan Table
Route Table
Configuration Forms

Chapters to Read by Job Function

Now, instead of reading the System Administrator's Manual and Installation and Maintenance Manual straight through, turn to the chapter that fits your needs, your job function, or your level of expertise with Octel Overture 200/300 message servers. Refer to the following charts.

System Administrator's Manual

Chapter	Sales	Configuration	Implementation	Installation	Service/ Maintenance
Product Description					
General Description	✓	✓	✓		
Implementation	✓	✓	✓	✓	
Introducing the Message Server	✓	✓	✓	✓	✓
Integration	✓	✓	✓	✓	✓
Reports	✓	✓	✓	✓	✓
Troubleshooting Commands				✓	✓
LOG Commands				✓	✓
System Errors and Traffic Pegs				✓	✓
Floppy Backup and Restore				✓	✓
Feature Description					
Customizing System-Wide Features	✓	✓	✓	✓	
Mailbox Features	✓	✓	✓	✓	
Fax Mail Plus	✓	✓	✓	✓	✓
Networking	✓	✓	✓	✓	✓
Single Digit Menus	✓	✓	✓	✓	
Incoming Call Restriction	✓	✓	✓	✓	
Call Queuing	✓	✓	✓	✓	
OctelForms	✓	✓	✓	✓	
Multilingual Prompts	✓	✓	✓	✓	
LAN Backup and Restore	✓	✓	✓	✓	✓
VMX 5000 User Interface	✓	✓	✓	✓	✓
Configuration		✓	✓	✓	

Installation and Maintenance Manual

Installation & Maintenance

INSTALL		✓	✓	✓	
Hardware	✓	✓	✓	✓	✓
Preparing the Phone System		✓	✓	✓	✓
Installation		✓	✓	✓	✓
Reports	✓	✓	✓	✓	✓
Maintenance Commands				✓	✓
LOG Commands				✓	✓
System Errors and Traffic Pegs				✓	✓
Hardware Replacement				✓	✓
DTIC Card		✓		✓	✓
LAN Card		✓		✓	✓
Procedures				✓	✓
Integration	✓	✓	✓	✓	✓
Networking	✓	✓	✓	✓	✓

Chapter Description

The Octel Overture™ 200/300 Installation and Maintenance Manual, *Installation and Maintenance* volume, contains information about preparing for an Octel Overture 200/300 installation, and monitoring and maintaining the Octel Overture 200/300 after installation. The following is a brief summary of each chapter within the *Installation and Maintenance* volume. Voice 200, Voice 300, and Voice 250-i

Chapter 1 INSTALL	The Install chapter provides instructions about using the INSTALL program to install a new Octel Overture 200/300 message server and reinstall an existing system. Voice 200, Voice 300, and Voice 250-i
Chapter 2 HARDWARE	This chapter discusses the Octel Overture 200/300 architecture. Included are an overview of the hardware, description of Octel Overture 200 and Octel Overture 300 Voice 200, Voice 300, and Voice 250-i subsystems, and diagrams of the systems.
Chapter 3 PREPARING THE PHONE SYSTEM	Octel Overture 200/300 installation requires special attention to the telephone system. This chapter includes topics such as how to identify changes to the Central Office Public Exchange trunking, and how to make the required changes to the phone system. Sample letters to the Central Office Public Exchange and PBX service provider are included to ensure smooth changes and transition to a new system.
Chapter 4 INSTALLATION	This chapter provides detailed instructions and procedures for installing an Octel Overture 200/300. The entire process is presented, from receiving and inspecting to the step-by-step testing of an installed system.
Chapter 5 REPORTS	This chapter describes the Octel Overture 200/300 reports. The reports are valuable tools that allow service personnel to monitor Octel Overture 200/300 performance in both stand-alone and networked environments. Each report is discussed in detail. This section also discusses how to generate the reports and clear the data.
Chapter 6 MAINTENANCE COMMANDS	This chapter describes the maintenance commands and diagnostics tests.
Chapter 7 LOG COMMANDS	This chapter describes the LOG commands including LOG, Call Processing Trace and Call Detail Record.
Chapter 8 SYSTEM ERRORS AND TRAFFIC PEGS	This chapter describes boot ROM, hardware errors and traffic pegs.
Chapter 9 HARDWARE REPLACEMENT	This chapter describes the preventive maintenance requirements for Octel Overture 200/300 message servers and the hardware replacement procedures and lists the system components and part numbers.
Chapter 10 DTIC CARD	This chapter describes the Digital Trunk Interface Card (DTIC) used for the DPNSS-ACULAB integration. The DTIC is a 30-port line card

designed to interface an Octel Overture 200/300 to E1 (European) trunks. The chapter explains how to configure, troubleshoot, and maintain the DTIC. The DTIC is applicable only to specific Octel channels in Europe and is available only through those channels.

**Chapter 11
LAN CARD**

This chapter describes the LAN card and includes details about hardware, installation, configuration, maintenance, and troubleshooting. The LAN card is necessary for Digital Networking, LAN Backup and Restore, or the Gateway Link feature.

**Chapter 12
PROCEDURES**

This chapter explains the Octel Overture 200/300 procedures. Included are procedures for backing up, archiving, restoring, recovering and maintaining the software and configuration database.

1 INSTALL

Chapter Contents

1.1	Understanding the INSTALL Program	1-1
1.2	Using INSTALL	1-4
	Entering the INSTALL Program	1-4
	Exiting the INSTALL Program	1-5
	Modifying Tables While Using INSTALL	1-5
	+ Auto-Increment, USER Table Input Aid	1-6
	Adding Mailboxes in Ranges, USER Table Input Aid	1-6
1.3	Answering Questions in INSTALL	1-7
1.4	Answering Questions About Other Telephone Systems	1-24
1.5	Exiting Before the INSTALL is Complete	1-26
	Restarting INSTALL	1-26
	Exiting and Continuing	1-27
	Reinstalling an Installed Octel Overture 200/300	1-27

Figure

1-1	Order of Questions and Associated Tables in the INSTALL Program	1-2
-----	---	-----

Quick Reference Guide

INSTALL Program

	Command	Description
Enter INSTALL	@INSTA	Used to install a new Octel Overture 200/300.
Reinstall	@INSTA	Reinstall an existing system. Clears tables and messages. Choices for preloading tables include: ALL TABLES, USER, DISTRIBUTION LIST, and COS Tables.
Enter UPDATE program while in the INSTALL program	: . A (table name) : . D (table name) : . M (table name) : . L (table name)	Allows you to enter the UPDATE program to list, add, modify, or delete information in various tables during an installation. Useful, for example, when you have forgotten to add a Company Greeting mailbox to the USER Table and you are trying to enter that mailbox into the INFORMATION Table.
Exit before complete	: . E	Saves all information up to this point. When INSTALL is resumed, the program resumes.

The @ prompt is the operating system prompt displayed by the Octel Overture 200/300.

The : prompt is the INSTALL prompt.

The . prompt is the UPDATE prompt.

1.1 UNDERSTANDING THE INSTALL PROGRAM

Use the INSTALL program to establish server parameters when you are installing the system. The INSTALL program displays messages and questions on the terminal. Respond to the questions by using the keyboard. Press the key to enter the data after you have completed each entry (on some terminals, this key is marked .

Some questions, such as “What is the PBX manufacturer?” are followed by a list of choices. Enter the number corresponding to your choice. If the answer needed is not on the list, choose OTHER or NONE as appropriate.

Some questions, such as “What is the company’s name?” require an answer to be typed rather than selected from a list. The program specifies a minimum and maximum number of characters allowed for the response. For example, the company name can be one to eight characters long.

The INSTALL program requires a response to each question. In some cases, you can press without entering data, and INSTALL records a default answer. Default answers, often the most commonly chosen answer to a question, are indicated in the following way:

A terminal window with a rounded rectangular border containing the text: "Do you wish to set the system DATE and TIME? (Y/N, empty line = N)".

```
Do you wish to set the system DATE and TIME? (Y/N, empty line = N)
```

The default answer for this question is N. If you press without pressing a letter, the screen shows an empty line, and INSTALL records an N.

Figure 1-1 shows the order in which information is requested when using the INSTALL program.

INSTALL Questions

1. a)

Manufacturer	SP 3a
Model	SP 3b

For each manufacturer and model, specific system parameters are supplied from the Serenade database. These vary, depending upon the telephone system and installation. A few examples follow:

b) Installation name SP 1
 c) System ID number SP 2
 e) Alarm number SP 31
 f) Forward string SP 45
 Cancel forward string SP 46
 g) Minimum length for security codes SP 144
 h) Default mailbox security code SP 105

FLASH TIME, ms.	SP 9
TRANSFER INIT reconnect-RNA reconnect-BUSY transfer complete	SP 13
ALTERNATE XFER reconnect-RNA reconnect-BUSY transfer complete	SP 16
PBX INIT CODE	SP 33

2.

USER MBX,EXT,COS or MBX,COS (if mbx = ext)

You must include all company-greeting mailboxes, intercept mailboxes, distribution-list pilot numbers, extended mailboxes (pilot and members), flexible menu mailboxes, and system users (mailboxes with extensions and mailboxes only).

3.

SLOTS Card, Port, Ext, COS, Mode, Outcall, Test

Enter the COS, even if you have not assigned the correct attributes. Attributes can be added or deleted in the UPDATE program.

4.

NETWORK ROUTES Route, Drop, Access
--

5.

NETWORK LOCATION Location Name, Protocol, Digital Networking
--

6.

NETWORK NUMBERING Location Name, Access, Additional Digits

Figure 1-1 Order of Questions and Associated Tables in the INSTALL Program

INSTALL Questions (continued)

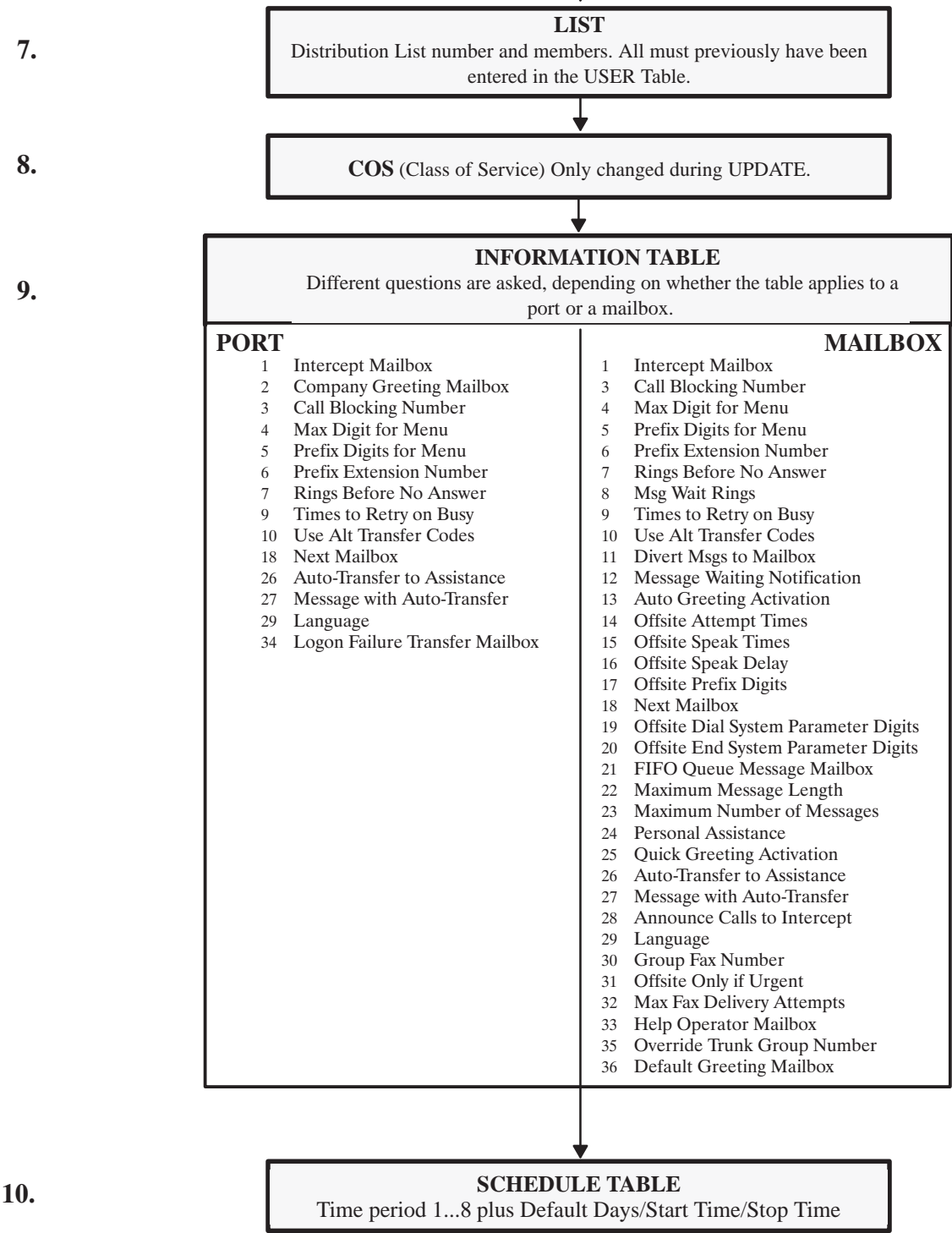

Figure 1-1 Order of Questions and Associated Tables in the INSTALL Program (continued)

1.2 USING INSTALL

The customer's specific configuration needs should be determined and a configuration package completed before the installation begins. Use the configuration package to answer each question in the INSTALL program. A blank configuration package can be found at the end of the Understanding Configuration chapter in the *Configuration* volume.

Follow the directions in the *Installation and Maintenance* volume, Installation chapter, Connecting Terminals section, to connect your terminal to the Octel Overture™ 200/300 message server.

Entering the INSTALL Program

Enter the maintenance-level password to access the message-server database. If this is a new installation and the password has not been changed, enter the maintenance-level password set by the manufacturer.



Caution!

You should change the manufacturer password to ensure the security of the server. Refer to the *Configuration* volume, Understanding Configuration chapter, Assuring Security section.

At the @ prompt, on the terminal, type INSTA or INSTAL and press Enter. The terminal displays the following messages:

```
@INSTA
-----  SYSTEM INSTALLATION DIALOG  -----
DAY MM/DD/YYYY HH:MM:SS  SYSTEMNAME  ID:XXXXX  S/N:XXXXXX  PBX:00
```

INSTALL then identifies the type of installation.

- New installation.
INSTALL question 1 follows.
- Installation is in progress.
INSTALL can continue, or it can start over.
- Message server has previously been installed.
To reinstall the message server, you must enter the maintenance password to initiate the reinstall.
The reinstall begins by erasing all stored information and messages. Do not use reinstall unless you are prepared to lose messages.

Exiting the INSTALL Program

When the program is completed, INSTALL displays the following prompts:

```

WARNING: FOR PROPER OPERATION SYSTEM MUST BE RESTARTED AFTER INSTALL!

INSTALL COMPLETE.

WAIT... DONE.

SAVE configuration to a DISKETTE? ( Y/N , empty line = N ).
:

DAY   MM/DD   HH:MM:SS   YYYY   NAME           ID:   S/N:   PBX:
-----   SYSTEM INSTALLATION COMPLETED   -----

```

Answer Y to copy all the data onto the configuration diskette as a backup. The Octel Overture 200/300 must be reloaded after the INSTALL is complete.

To exit before you have completed the INSTALL program, at the colon (:) type:

```
.E 
```

When you type (.E) to exit, the portion of the completed configuration is saved to the hard disk. You can continue the INSTALL later, from where you left off, or you can start the INSTALL over. Refer to the Starting INSTALL Over section or the Exiting and Continuing section of this chapter.

Modifying Tables While Using INSTALL

While using the INSTALL program, you can access the UPDATE program to list, add, modify, or delete information in the configuration tables.

The INSTALL program displays a colon (:) when it is waiting for a response. At the colon, type a dot (.), which is the UPDATE prompt, then an L (list), an A (add), an M (modify), or a D (delete), followed by the name of the table you want to alter. For example,

```
:.A USER
```

The INSTALL program activates the UPDATE program. Alter the tables as necessary. To exit UPDATE, press at the colon. The INSTALL program resumes.

+ Auto-Increment, USER Table Input Aid

When entering a sequence of mailboxes into the USER Table, the auto-increment input aid allows you to enter a + after the COS to automatically increment to the next sequential mailbox/extension number. If the extension field is N, only the mailbox number is incremented. The COS is not changed. Auto-increment does not cross over to a new first digit. If it is attempted, the Octel Overture 200/300 prompts

```
SORRY, ("+" ) AUTO-INCREMENT CAN'T CROSS FIRSTDIGIT BOUNDARY.
```

For example, to enter a sequence of mailbox numbers one by one, enter the mailbox, extension, COS, and +. The next line displays the mailbox and COS, copied from the previous range, increasing the number by one. To continue increasing, type a + after the COS. Press to go to the next mailbox. To stop incrementing the numbers, do not enter the +, just press . The next line will have no information in it, and the next mailbox may be entered.

The extension number does not need to match the mailbox number to use auto-increment. If mailbox and extension numbers do not match, be sure the extension number is supposed to be incremented, as well as the mailbox number. If not, do not use auto-increment.

This example shows how to enter mailbox information using auto-increment. The bold characters are what was entered.

```
:4500,4501,0+
:4501,4502,0+
:4502,4503,0
:4700,N,1
:4800,N,5
```

Adding Mailboxes in Ranges, USER Table Input Aid

To add mailboxes in the USER Table in ranges, enter the first and last mailbox numbers, the first extension number, and common COS. The mailbox and extension numbers are incremented by one, and the COS remains the same for all entries.

This example shows how to enter mailbox information in ranges.

```
:4500-4599,4600,0
```

For this example, mailboxes 4500–4599, with corresponding extension numbers 4600–4699, each with COS 0, are added to the USER Table.

 Mailbox and extension numbers **cannot** cross a first digit boundary. Auto-increment cannot be used when adding in ranges.

1.3 ANSWERING QUESTIONS IN INSTALL

During INSTALL, refer to the customer's completed configuration package. The configuration package supplies you with the information you need to answer the questions.

After entering the INSTALL program, if this is a new installation, the message server asks whether the date and time should be set as shown. The INSTALL questions follow.

```

@INSTA

----- SYSTEM INSTALLATION DIALOG -----
DAY MM/DD/YYYY HH:MM:SS   SYSTEMNAME ID:XXXXX S/N:XXXXXX PBX:00

NEW CONFIGURATION INSTALLATION.

Do you wish to set the system DATE and TIME? (Y/N, empty line = N)
:Y
Current DATE and TIME:
DAY MM/DD/YYYY HH:MM
Enter new DATE and TIME as: DAY MM/DD/YY HH:MM
or empty line for no change.
MOD:DAY   MM/DD/YYYY   HH:MM
DATE and TIME set to:
MON MM/DD/YYYY HH:MM

Is this correct? (Y/N, empty line = N):Y

All Messages older than this Date will be deleted.
Are you sure: (Y/N, empty line = N):

```

1. SYSTEM PARAMETERS

Question 1 is a series of questions that modify specific system parameters; the information entered is automatically transferred into the SYSTEM PARAMETER Table.

Question 1. a) displays a list of telephone manufacturers from which to select.

Enter the number corresponding to the manufacturer's name, and press . After you have selected the telephone manufacturer's number, the model numbers for that manufacturer are listed. Select the appropriate number for that model telephone system.

```

1. SYSTEM PARAMETERS.
a) Select the MANUFACTURER-NUMBER of your telephone system
   from the following list.
   0 - OTHER          1 - ITT
   2 - TIE
   .
   .
:x [manufacturer number]
Select the MODEL-NUMBER of your telephone system
from the following list.

0 - OTHER
.
.

```

- ☞ If the telephone manufacturer is not listed, enter 0 for Other and press **Enter**. If 0 for Other is selected, specific questions about the other telephone system are asked, before continuing with question 1.b). Refer to the Answering Questions About Other Telephone Systems section in this chapter, for an explanation of these questions.

After the telephone system model number has been selected, the next questions ask whether the DTMFINT and TONEDET Tables should be reset. These questions are displayed even if the PBX selected does not require the DTMFINT or TONEDET Tables. For both DTMFINT and TONEDET Tables, the default or empty line is YES. Therefore, if you are installing a server **that does not require** the DTMFINT or TONEDET Table, enter N.

```
Do you wish to RESET DTMFINT TABLE to FACTORY-DEFAULTS for
this PBX? (If "YES" , ALL current values will be LOST!)
( Y/N, empty line = Y ):
LOADING CONFIGURATION DATA...DONE
Do you wish to RESET TONEDET TABLE to FACTORY-DEFAULTS for
this PBX? (If "YES" , ALL current values will be LOST!)
( Y/N, empty line = Y ):
```

Question 1. b) asks for the company name.

```
b) What is the name of the company at which this system
is being installed? (1-8 characters).
:
```

This name is used for internal reports. Up to eight characters can be entered; use the entire name or an abbreviation of the name.

Question 1. c) asks for the system ID number.

```
c) What is the SYSTEM ID number? (1-6 digits).
:
```

The serial number of the message server can be used as the system ID number. The serial number is printed on the message server/UL label located at the lower rear of the cabinet. It is important that a different number be used for each Octel Overture 200/300. This number is used to distinguish among Octel Overture 200/300 message servers and to identify the message server when an alarm call is made.

Question 1. e) asks for the telephone number of the person who should receive alarm calls.

```
e) What extension or phone number should be called when an ALARM
is encountered? (If this is an outside call, precede it with
the EXTERNAL ACCESS CODE and an Expect-Dial-Tone, where necessary.)
( 1-20 chars. May include: 0-9,*,#, D=DELAY, E=EXPECT-DIAL-TONE
empty Line = NONE )
```

If something goes wrong with the message server, it can call and report the problem. This can be an on- or off-premise number. Include access codes, if necessary. Enter a D for a delay after any access codes you might use. (The length of the delay is determined by System Parameter 28.) Enter an E for “expect dial tone.” **Do not** use any spaces.

Question 1. f) asks for the string of numbers to be dialed for the forwarding string and the cancel-forwarding string when the message server is reloading or finished reloading.

```
f)  What is the forwarding string, including destination extension,
    to be dialed when the system is reloading and cannot accept calls?
    (May include: 0-9,*,#, D=DELAY, E=EXPECT DIAL TONE, or F=FLASH,
    1-12 chars, empty line = NONE          )
    :
    What is the cancel-forwarding string, to be dialed when the system
    has finished reloading and is ready to accept calls?
    (May include: 0-9,*,#, D=DELAY, E=EXPECT DIAL TONE, or F=FLASH,
    1-12 chars, empty line = NONE          )
    :
```

While the Octel Overture 200/300 is reloading after a power failure, the ports can be forwarded to an alternate answering point. Enter the code that causes incoming calls to ring at the alternate answering location. If NONE is entered, all ports remain off hook (busy) when the message server is loading or reloading.

The second part of this question asks for the cancel-forwarding number to be entered, which allows a return to the Octel Overture 200/300 when the server is again operational.

Question 1. g) asks for the minimum length for all mailbox security codes.

```
g)  Enter the minimum length for all security codes.
    (0-10, empty line = 0 )
    :
```

The answer to this question defines the value for System Parameter 144 — MINIMUM LENGTH FOR SECURITY CODES. The maximum length for a security code is 10 digits.

 If this is changed after the initial installation, existing security codes with fewer digits are not affected until the mailbox holder changes the security code.

Question 1. h) asks for the default security code for mailboxes that logon using a mailbox number.

```
h)  For mailboxes which logon via MAILBOX number (NO port/trunk cos attr 106)
    enter the DEFAULT SECURITY CODE.
    Note: This code will apply to all mailboxes which do not have a security
    code defined.
    (xx -10 digits, empty line = NONE          )
    :
```

If question 1. g) is configured, all new mailboxes must have a security code of the minimum length or longer. The security code entered is the value defined for System Parameter 105 — DEFAULT SECURITY CODE FOR MAILBOXES. This security code remains on each mailbox until a user logs on to the mailbox and changes it.

 The User ID Logon is not configured in the INSTALL program. Refer to the *Feature Description* volume, Customizing System-Wide Features chapter, Mailbox Logon section.

 XX is the value defined in question 1. g) for System Parameter 144. A default security code must be set if the minimum length is greater than zero.

The security code assigned through this INSTALL question can be changed or deleted through System Parameter 105. If the value of this parameter is modified, any existing mailboxes that already have the default security code are automatically assigned the new default security code.

2. USER

```

2. USER.
Enter each user's MAILBOX, EXTENSION, and COS. Enter as:
(Mailbox=1-8 digits, Name=1-20 characters)
Extension=1-8 digits, COS=0-254, Enter NONE if desired for EXTENSION.
Enter "+" after COS to automatically increment:
MAILBOX, and EXTENSION.
Also, enter any mailboxes to be used as DISTRIBUTION LISTS.
To add users in a range, enter as:
MAILBOX1-MAILBOX2,EXTENSION,COS.
Enter empty line when done.
:2001-2019,2001,10
NOTE: MAILBOXES with first digit "2" are 4 digits long.
:
Do you wish to add more users? (Y/N, empty line = Y)
:N

```

For each user, enter a mailbox number, extension number, and COS, separated only by commas. If System Parameter 212 — USER I.D. LENGTH, is configured, enter the user ID number after the mailbox number. Do not enter any spaces. Press after each line. Enter the numbers carefully to avoid errors. You can correct mistakes later by using the MODIFY command in the UPDATE program.

Define every mailbox, including individual mailboxes, information-only mailboxes, greeting mailboxes, and distribution-list pilot numbers. Make sure to enter intercept mailboxes (numbers sent when a caller does nothing or presses for assistance.)

 In the INSTALL program, you can define users without the COS being created first in UPDATE.

When adding multiple users that have the same COS, you can add them in a range. Refer to the Adding Mailboxes in Ranges, USER Table Input Aid section in this chapter. You cannot cross mailbox or extension first-digit boundaries when adding users in a range.

When adding a sequence of mailbox numbers one by one, you can enter a + after the COS to automatically increment to the next sequential mailbox number. Refer to the + Auto-Increment, USER Table Input Aid section in this chapter.

After each mailbox is entered, a colon (:) is displayed, indicating that the next mailbox can be entered.

Press at the colon when you are finished entering mailboxes. The message server prompts Do you wish to add more users? Enter N. The INSTALL program goes to the next question.

If you press before finishing, the Octel Overture 200/300 asks whether you want to exit the USER Table. Simply respond NO to return to the USER Table. Mailboxes may also be added later using UPDATE.

3. SLOTS

The SLOTS Table contains information about each line card slot, integration card slot, and applications card slot. The SLOTS Table allows each line card and integration card to be configured individually. Enter the slot number and the type of card to be installed.

```
.3. SLOTS
Enter SLOT NUMBER to INSTALL
INS:1
  6 -LIC4          2 -SLIC          8 -ACP
  7 -DAC4          3 -RIC           17-FAX4
 10-LIC8          4 -ATTIC         16-FAX8
 11-TLC8          13-SIC8          22-LAN
 18-LIC4I
  5 -MTEL
 23-DTC17-E1
 26-DLC16
 50-PICROLM
 51-PICATT
 52-PICNT
 33-ILIC12FR
 34-ILIC12UK
 35-ILIC12JP
 37-ILIC12GR
Enter Card Type.
SLOT 1 : 6
```

 When the configuration information for a port is the same information entered for the previous port, only the extension number of the port need be entered, followed by . The information for the remainder of the line is automatically entered.

Different cards can be configured within a single Octel Overture 200/300. The EntryWorks ACP card can only be configured in slot 7 for the Octel Overture 200 and in slot 12 for the Octel Overture 300.

 The dialog for configuring a telemarketing line card (TLC) is similar to the dialog for configuring a line interface card (LIC).

After you enter the card type for DLC16, ILC12, and PIC, enter the LSTTAB Table to be referenced.

```
.SLOT 1:51
Enter LSPTAB table to be referenced for this slot.
0-DEFAULT
1-ILC12_FR.
2-ILC12_GE
3-DLC16_US
4-DLC16_AU
5-DLC16_GE
6-ILC12_US
7-DLC16_FR
8-TI
9-MD110-E1
10-DLC16_UK
11-ILC12_UK
12-DLC16_90
(Empty line = 0)
```

```
MOD:
Should this card be:
      (1 - PRIMARY
      2 - SECONDARY
      3 - TERTIARY
      N - no      ) sync receiver of the master clock?
(1-3, N. Empty line = N):
```

When you install a PIC card, you must configure the system-clock (master clock) sync source. Refer to the *Configuration* volume, Slots Table chapter, for information about the LSPTAB Table and the master clock configuration.

The following examples show the dialog for configuring the different cards. Refer to the *Configuration* volume, Slots Table chapter, Using UPDATE section, for information about configuring the card types.

Direct Access Card (DAC)

```
SLOT 2:7
Enter information for each PORT.
Enter as: EXTENSION NUMBER connected to each port (1-8 digits),
CLASS-OF-SERVICE (0-254), SIGNALLING (DTMF, Rotary),
TRUNK TYPE (Wink, Immed, Delay, Loop, Ground).
1 : 333,254,DTMF,DELAY
```

Integration Card

```

SLOT 4 :5
  Enter information for each PORT.
  Enter as: EXTENSION NUMBER connected to each port (1-8 digits),
  CLASS-OF-SERVICE (0-254), ANSWER MODE (AX, CX, MX), USE PORT FOR
  MESSAGE WAITING AND NETWORK OUTCALLING (Y/N), TEST CHANNEL (Y/N)

1 :334,250,AX,N,N
2 :
  Configure Integration (1-4=Msg Waiting Link):1
  Enter empty line when done.
INS:

```

Integration cards installed in the message server must be the same. Integration cards can be installed in Slots A1 through A6 for the Octel Overture 200. For the Octel Overture 300, most integration cards can be configured in any slot not used for line cards. ATTIC integration cards and SIC8 cards cannot go in slot 12 of the Octel Overture 300.

Except for the AT&T System 75/Definity G1, and the G3 ATTIC integrations, each port can be allocated to only one integration unit. Refer to the *Integration* volume for additional details about the specific integration you are configuring.

The fax application processor card can be installed in any unoccupied slot in the Octel Overture 200/300 cabinet. The following is an example of the dialog for configuring a fax application processor.

```

.SLOT 8:17
  Enter information for each PORT.
  Enter as: CLASS-OF-SERVICE ( 0-254 ), TEST CHANNEL (Y/N).
1:126,N
2:126,N

```

4. NETWORK ROUTES

5. NETWORK LOCATIONS

6. NET NUMBERING PLAN

Questions 4, 5, and 6 pertain to collocated message servers and multilocation networking. For information about configuring networking, refer to the *Networking* volume.

```

4. NETWORK ROUTES.
Enter the name for each NETWORK ROUTE, whether the route can be
dropped upon reconnect to caller, and the ACCESS DIGITS to be dialed.
ENTER AS:
ROUTE NAME (1-6 chars), DROP (Y or N), ACCESSDIG (1-29 digits)
ACCESS DIGITS may include: 0-9,*,# or any of the following:
    D - delay.
    E - wait for DIAL TONE here.
    N - wait for DIAL-UP OCC DIAL TONE here.
    P - dial PUBLIC NETWORK NUMBER here.
    T - dial TIE NETWORK NUMBER here.
Enter empty line when done.
:33,N,456
:

5. NETWORK LOCATIONS.
Enter requested information for all NETWORK LOCATIONS.
Enter new LOCATION NAME. (1-6 chars)      Enter empty line when done.
:(location name)

Does (location name) have a SYSTEM? (Y/N, empty line = Y)
:

```

Press after each question to continue.

 If you are installing a single-cabinet message server without remote networking, press to skip to question 7. DISTRIBUTION LISTS.

If the (location name) **does not have** a SYSTEM, the next question is as follows:

```

Does (location name) have the same PBX type as SELF? (PBX type)
(Y/N, empty line = N) (If "YES", will do CALL-PROGRESS-DETECTION.)
:

```

If the (location name) **does have** a SYSTEM, enter the protocol to use, as follows:

```

Enter the PROTOCOL to use with (location name) (1,2,3,4,5,empty line =3)

```

If the above question is answered with 2, refer to the *Networking* volume, Analog Networking chapter and Location Table chapter.

If the above question is answered with 4 for AMIS Analog networking, refer to the *Networking* volume, Analog Networking chapter and Location Table chapter.

If the above question is answered with 5, refer to the *Networking* volume, Analog Networking chapter and Location Table chapter.

Is (location name) located on the same PBX as this system? (Y/N, empty line = N)
:

Enter ROUTE NAMES for up to three ROUTE CHOICES to (location name) .

1:

2:

3:

Enter PUBLIC NETWORK NUMBER (PNN) to call (location name) .

(May include: 0-9,*,#, D=DELAY, E=EXPECT DIAL TONE, or Cn.

1-12 chars, empty line = NONE)

:

Enter TIE NETWORK NUMBER (TNN) to call (location name) .

(May include: 0-9,*,#, D=DELAY, E=EXPECT DIAL TONE, or Cn.

1-7 chars, empty line = NONE)

:

Is (location name) accessible over the DIGITAL NETWORK? (Y/N, empty line = N)

:

If the above question is answered Y for Digital Networking, refer to the *Networking* volume, Digital Networking chapter.

6. NET NUMBERING PLAN.

Enter NUMBERING PLAN information for each NETWORK LOCATION.

Enter as:

LOCATION NAME, INITIAL DIGITS (1-8 digits), NET MAILBOX LENGTH (1-16),

NUM OF DIGITS TO STRIP(0-15)., NUM OF DIGITS TO STRIP FROM SELF(0-8)

Enter empty line when done.

7. LISTS

Question 7 is used to create System Distribution Lists.

```

7. DISTRIBUTION LISTS.
   Enter the LIST NUMBER. (1-16 digits).
   This Number must already exist as a mailbox in the USER table.
   Then enter each mailbox to be added to the list.(1-16 digits).
   If the list exists, new mailboxes will be appended to existing ones.
   Enter empty line when done.
   Enter DISTRIBUTION LIST NUMBER.
ADD:4000
WARNING: MESSAGES IF ANY IN MAILBOX WILL BE LOST!
ARE YOU SURE (Y/N) ? (Y/N, EMPTY LINE = N):Y

NEW DISTRIBUTION LIST.
Enter each MAILBOX or RANGE to be added to this list.

```

During INSTALL, you can create system distribution lists and add member addresses. The distribution list number and member numbers must already exist as a mailbox in the USER Table.

If distribution lists are not being added during INSTALL, press . You can add them later, through the UPDATE program.

8. COS

COS tables are not configured during the INSTALL program. When INSTALL is complete, enter the UPDATE program and add attributes to the COS numbers that were defined for each port and mailbox defined in the USER Table in question 2. Refer to the *Configuration* volume, COS chapter.

```

8. COS.
   UPDATE if necessary when INSTALL is complete.

```

9. INFORMATION TABLES

Question 9 lists the INFORMATION Table indexes for either port or mailbox configuration.

```

9. INFORMATION TABLES.
   Enter the INFORMATION TABLE number to be added. (1-255)
   Enter empty line when done.
   :254
   Is TABLE 254 for a PORT/TRUNK? (If NO, it's for a MAILBOX.)
   (Y/N, empty line = N)
   :Y

   To COPY an existing INFORMATION TABLE, enter the TABLE NUMBER.
   (1-255, empty line = NONE)

```

Define at least one port and one mailbox INFORMATION Table, because a default INFORMATION Table **must be** entered for every SCHEDULE Table (Question 10).

The Octel Overture 200/300 obtains data from the INFORMATION Tables to determine how each port and mailbox process the calls. The COS for each port and mailbox points the Octel Overture 200/300 to the SCHEDULE Table to determine which INFORMATION Table to use.

When adding an INFORMATION Table, be sure to answer the first question accurately — IS TABLE X FOR A PORT/TRUNK? (If NO, it's for a Mailbox.) This is important because the subsequent questions are different for ports/trunks and mailboxes. For consistency and clarity, number port INFORMATION Tables from 255, descending, and mailbox INFORMATION Tables from 1, ascending.

Port INFORMATION Table Indexes

The following indexes are applicable to port INFORMATION Tables. Refer to the *Configuration* volume, Information Table chapter, for details about each index.

- Index 1.** Each port/trunk INFORMATION Table must have an intercept position. The mailbox must already exist in the USER Table.

```
1. INTERCEPT MAILBOX
   (1-8 digits )
   :
```

- Index 2.** A company greeting mailbox can be configured. If a mailbox number is not entered, the manufacturer's recorded generic greeting is used.

```
2. COMPANY GREETING MAILBOX (1-8 digits, N = NONE, empty line = NONE )
   :
```

- Index 3.** The following index appears if the Incoming Call Restriction option is installed.

```
3. CALL BLOCKING NUMBER (0-255, 0 = NONE, empty line = NONE)
   :
```

- Indexes 4 and 5.** The following indexes appear if the Single Digit Menus option is installed. Index 5 is not listed if index 4 is NONE.

```
4. MAX DIGIT FOR MENU (0-8, 0 = NONE, empty line = NONE)
   :
```

```
5. PREFIX DIGIT FOR MENU (1-7 DIGITS, N = NONE, empty line = NONE)
   :XX
   WARNING: The following MAILBOXES must exist in the USER TABLE or in a
   COLOCATED cabinet:
```

- **Indexes 6, 7, 9, 10, and 18.** The following five indexes are listed.

```

6.  PRE EXTENSION DIGITS
    (1-12 digits; may include: 0-9, *, #, D=DELAY, E= EXPECT-DIAL-TONE,
    N = NONE, empty line = NONE )
    (When caller dials EXTENSION that is not a defined MAILBOX.)
    :

7.  RINGS BEFORE NO ANSWER  (3-20, empty line = 4 )
    (When caller dials EXTENSION that is not a defined MAILBOX.)
    :

9.  TIMES TO RETRY ON BUSY  (0-40, empty line = NONE)
    (When caller dials EXTENSION that is not a defined MAILBOX.)
    :

10. USE ALT TRANSFER CODES  (Y/N, empty line = N)
    (When caller dials EXTENSION that is not a defined MAILBOX.)
    :

18. NEXT MAILBOX           (1-8 digits, N = NONE, empty line = NONE )
    :
```

- **Indexes 26 and 27.** The following indexes are used with Personal Assistance, Adaptive Integration, and with the DID/E&M Trunk Interface Module. Index 27 is not listed if index 26 is N.

```

26. AUTOTRANSFER TO ASSIST  (Y/N, empty line = N)
    :
27. MSG WITH AUTO TRANSFER  (Y/N, empty line = N)
    :
```

- **Index 29.** The following index appears if the Multilingual Prompts option is installed. The languages shown in index 29 depend on current settings. The following is an example where English and Spanish are currently installed.

```

29. LANGUAGE: 0= NONE
              1= ENGL US--V  VERSION  8D
              2= SPANISH    VERSION  8D
    (0-2, empty line = 0)
```

- **Index 34.** When index 34 is configured, callers are transferred to assistance instead of being disconnected if their attempts to log on are unsuccessful.

```

34. LOGON FAILURE XFER MAILBOX  (1-8 digits, N = NONE, empty line = NONE )
    :
```

After index 34 is answered, the port INFORMATION Table is complete, as shown.

```

--- INFORMATION TABLE 254 COMPLETE ---

Enter the INFORMATION TABLE number to be added. (1-255)

Enter empty line when done.

```

Mailbox INFORMATION Table Indexes

The following indexes are applicable to the mailbox INFORMATION Table. Refer to the *Configuration* volume, Information Table chapter, for details about each index.

- Index 1.** If an intercept mailbox is not defined for a mailbox, the call defaults to the Intercept Mailbox defined for the port or trunk on which the call came in.

```

1. INTERCEPT MAILBOX If none, uses PORT/TRUNK info.
   (1-8 digits, N = NONE, empty line = NONE )
   :

```

- Index 3.** The following index appears if the Incoming Call Restriction option is installed.

```

3. CALL BLOCKING NUMBER (0-255, 0 = NONE, empty line = NONE)
   :

```

- Indexes 4 and 5.** The following indexes appear if the Single Digit Menu option is installed. Index 5 is not listed if index 4 is NONE.

```

4. MAX DIGIT FOR MENU (0-8, 0 = NONE, empty line = NONE)
   :

```

```

5. PREFIX DIGIT FOR MENU (1-7 DIGITS, N = NONE, empty line = NONE)
   :XX
   WARNING: The following MAILBOXES must exist in the USER Table:

```

- ❑ **Indexes 6 through 13.** The following indexes are listed.

```

6.  PRE EXTENSION DIGITS
    (1-12 digits; may include: 0-9, *, #, D=DELAY, E= EXPECT-DIAL-TONE,
    N = NONE, empty line = NONE      )
    :

7.  RINGS BEFORE NO ANSWER   (3-20, empty line = 4   )
    :

8.  MSG WAITING RINGS       (3-20, empty line = 4   )
    :

9.  TIMES TO RETRY ON BUSY   (0-40, empty line = NONE)
    :

10. USE ALT TRANSFER CODE    (Y/N, empty line = N)
    :

11. DIVERT MSG TO MAILBOX    (1-8 digits, N = NONE, empty line = NONE )
    :

12. MSG WAITING NOTIF       (Y/N, empty line = Y)
    :

13. AUTO GREETING ACTIVATION (Y/N, empty line = N)
    :

```

- ❑ **Index 14.** The following index is only listed if index 12 is Y.

```

14. OFFSITE ATTEMPT TIMES   (0-255, empty line = NONE)
    :

```

- ❑ **Indexes 15, 16, and 17.** The following indexes are not listed if index 14 is 0.

```

15. OFFSITE SPEAK TIMES     (0-8, empty line = 3)
    :

16. OFFSITE SPEAK DELAY     (1-32 seconds, empty line = 5)
    :

17. OFFSITE PREFIX DIGITS
    (1-12 digits; may include: 0-9,*,#, D=DELAY, E=EXPECT-DIAL-TONE,
    N=NONE, empty line=NONE)
    :

```

- ❑ **Index 18.** The following index is listed.

```

18. NEXT MAILBOX           (1-8 digits, N = NONE, empty line = NONE )
    :

```

- ❑ **Indexes 19 and 20.** If the answer to index 18 is 0, indexes 19 and 20 are not listed. When index 20 is yes, the digit string to be dialed must be configured in System Parameter 259.

```

19. OFFSITE DIAL SYSP DIGS      (Y/N, empty line = N)
   :
20. OFFSITE END SYSP DIGS      (Y/N, empty line = N)
   :

```

- ❑ **Index 21.** The following index appears if Call Queuing is installed.

```

21. FIFO QUEUE MSG MAILBOX     (1-8 digits, N = NONE, empty line = NONE)
   :
22. MAXIMUM MSG LENGTH         (1-180 minutes, empty line = 6 minutes)
   :

```

```

23.  MAX NUMBER OF MSGS       (1-60, empty line = 32 )
   :
24.  PERSONAL ASSISTANCE       (Y/N, empty line = N)
   :

```

- ❑ **Index 25.** The following index appears if Adaptive Integration is installed.

```

25. QUICK GREETING ACTIV (Y/N, empty line = N)
   :
26. AUTOTRANSFER TO ASSIST (Y/N, empty line = N)
   :
27. MSG WITH AUTO TRANSFER (Y/N, empty line = N)
   :
28. ANNOUNCE CALLS TO INT (Y/N, empty line = N)
   :

```

- ❑ **Index 29.** This index appears if Multilingual Prompts is installed. The languages shown in Question 29 depend on current settings. The following is an example where English and Spanish are currently installed.

```

29.  LANGUAGE: 0= NONE
           1= ENGL US--V  VERSION  8D
           2= SPANISH    VERSION  8D
(0-2, empty line = 0)

```

- ❑ **Indexes 30 and 32.** These indexes appear if Fax Mail Plus is installed. For index 30, enter the digits of the telephone number for the designated group fax delivery machine.

```
30.GROUP FAX NUMBER
  (1-32 digits, may include: 0-9, *, #, D=DELAY, E=EXPECT-DIAL-TONE,
   empty line = NONE
   )
ADD:
```

- ❑ **Index 31.** Enter YES in the following item to provide for offsite/pager outcalling to be made only for urgent messages. The default is NO.

```
31. OFFSITE ONLY IF URGENT (Y/N, empty line N)
ADD:
```

```
32. MAX FAX DELIV ATTEMPTS
  (0-255, 0=USE SYSTEM PARAMETER 209, 255=UNLIMITED, empty line=SYSP 209)
ADD:
```

- ❑ **Indexes 33, 35, and 36.** Index 33 is operational only if the 5000 User Interface feature is installed.

```
33.  HELP OPERATOR MAILBOX      (1-8 digits, N = NONE, empty line = NONE )
    :
35.  OVERRIDE TRUNK GROUP NUMBER (1-8 digits, N = NONE, empty line = NONE)
    :
36.  DEFAULT GREETING MAILBOX   (1-8 digits, N = NONE, empty line = NONE)
    :
```

After index 36 is answered, the mailbox INFORMATION Table is complete, as shown.

```
--- INFORMATION TABLE 1 COMPLETE ---

Enter the INFORMATION TABLE number to be added. (1-255)

Enter empty line when done.
```

10. SCHEDULE TABLES

Enter a SCHEDULE Table for each COS entered for the user mailboxes defined in Question 2. The message server automatically requests a schedule for each COS number entered. Enter the appropriate times, days, and INFORMATION Table numbers for each SCHEDULE Table time period displayed. When finished with the time periods, enter an INFORMATION Table to be used for the default times.

```

10. SCHEDULE TABLE.

- - - SCHEDULE FOR COS 10 - - -

TIME PERIOD 1:
Enter INFORMATION TABLE number to use. (1-255)
Enter empty line when done.
:
Enter applicable WEEKDAYS as: SU,MO,TU,WE,TH,FR,SA,HOL
(Empty line = MO,TU,WE,TH,FR)
:
Enter START time as: HOURS (00-23): MINUTES (00-59)
(Empty line = 00:00)
:
Enter STOP time as: HOURS (00-23): MINUTES (00-59)
(Empty line = 23:59)
:
TIME PERIOD 2:
Enter INFORMATION TABLE number to use. (1-255)
Enter empty line when done.
:

```

When you are finished entering all time periods for the SCHEDULE Table, press at the colon. The message server prompts for the default INFORMATION Table number.

```

Enter the DEFAULT INFORMATION TABLE number to use outside the
TIME PERIODS specified for COS 10 . (1-255)

```

```

INSTALL COMPLETE.

WAIT... DONE.

SAVE configuration to a DISKETTE? ( Y/N , empty line = N ).
:

WARNING: FOR PROPER OPERATION SYSTEM MUST BE RESTARTED AFTER INSTALL!

DAY MM/DD/YYYY HH:MM:SS  SYSTEMNAME      ID:XXXXXX  S/N:XXXXXX  PBX:00

-----      SYSTEM INSTALLATION COMPLETED      -----
@

```

Save the configuration on your backup configuration diskette. Leave the diskette in the disk drive.

The Octel Overture 200/300 must be reloaded for to operate correctly. To reload the Octel Overture 200/300, at the @ prompt, enter

```
RESTA 2 
```

After the message server has reloaded, it is recommended that you enter the UPDATE program and use the LIST command to review the answers you just entered. You might also need to change some of the system parameter values. Refer to the *Configuration* volume, System Parameter Table chapter, in this volume.

Use the UPDATE program to modify system parameters and to set COS Attributes.

1.4 ANSWERING QUESTIONS ABOUT OTHER TELEPHONE SYSTEMS

The INSTALL program asks the following questions when your telephone system manufacturer or PBX model number is not listed in question 1.a).

Please answer the following questions for your telephone system:

How do you TRANSFER a call to another EXTENSION?
 (May include: 0-9,*,#, D=DELAY, E=EXPECT DIAL TONE, or F=FLASH,
 1-8 chars, empty line = NONE)
 :FE

Enter the sequence of events when transferring a call before you enter the destination extension number. For example, if the sequence is “flash,” wait for a dial tone, then enter the extension number, type FE. (If the telephone hookswitch is pressed momentarily, that is considered a flash.)

Enter the sequence of events for a reconnection to the original caller.

How do you RE-CONNECT to the caller if the EXTENSION doesn't answer?
 (May include: 0-9,*,#, D=DELAY, E=EXPECT DIAL TONE, or F=FLASH,
 1-8 chars, empty line = NONE)
 :F

This is usually similar to transferring a call. For example, if FE is entered for a transfer, an F (flash) is probably used for a reconnection.

Type the digits, if any, required to complete a transfer. If there are none, press .

What digits, if any, are dialed before HANG-UP to COMPLETE a transfer?
 (May include: 0-9,*,#, D=DELAY, E=EXPECT DIAL TONE, or F=FLASH,
 1-8 chars, empty line = NONE)
 :

A ringback is the sound you hear in the receiver when the telephone you are calling is ringing. The standard ringback is one ring, alternating with silence. A double-interrupted ringback is two short rings, and then silence. Enter Y for double ringback.

Does this telephone system give DOUBLE-INTERRUPTED RINGBACK
 (Y/N, Empty line =N)
 :Y

Some PBX systems may require a digit sequence to be dialed so that system extensions get assigned to the incoming call group.
What digits, if any, should be dialed on all PORTS upon POWER-UP?
(May include: 0-9,*,#, D=DELAY, E=EXPECT DIAL TONE, or F=FLASH,
1-8 chars, Empty line = E)
:

End of telephone system specific questions.

At this point, the INSTALL program continues with question 1.b), Company Name. Refer to the Answering Questions in INSTALL section.

1.5 EXITING BEFORE THE INSTALL IS COMPLETE

There are two ways that you can leave and reaccess the INSTALL program, shown in the following examples. The first example shows what to do if you make a mistake during INSTALL and, instead of correcting it, you choose to exit and start over. The second example shows what to do if you are interrupted during INSTALL and choose to stop temporarily and continue later.

Restarting INSTALL

If you make a serious mistake, and you don't want to fix it later, you can leave the program and start over. At the point you wish to exit the program, type `.E` at the colon (`:`) prompt. The following example, starting at question 1.c), shows how.

```
c) What is the SYSTEM ID number? (1-6 digits).
   :555

d) How many (Overture 200/300) ports will be used? (1-8, empty line = 4)
   :.E

EXITING INSTALL

WAIT...DONE.

-----SYSTEM INSTALLATION SUSPENDED-----

@
```

When you want to return to the INSTALL program, type `INSTA` at the `@` prompt, as shown:

```
@INSTA

-----SYSTEM INSTALLATION DIALOG
MON   MM/DD   HH:MM:SS   YYYY   SYSTEM NAME   ID:000

You have an installation already in progress.
Do you wish to start over with a NEW INSTALLATION?
(Y/N, empty line = NO, continue installation in progress)
:Y

CLEARING ALL TABLES...DONE.
INITIALIZING ALL USER DIRECTORIES...DONE.

1.SYSTEM PARAMETERS.
a)Select the MANUFACTURER NUMBER ..... etc.
```

All the information entered earlier has been cleared. Begin again with the first question. Refer to the Answering Questions in INSTALL section.

Exiting and Continuing

If you start INSTALL and are interrupted, you can leave the program and continue later at the point where you left off. The following example, starting at question 1.c), shows how.

```

c) What is the SYSTEM ID number? (1-6 digits).
   :555

d) How many (Overture 200/300) ports will be used? (1-8, empty line = 4)
   :.E

EXITING INSTALL

WAIT...DONE

-----SYSTEM INSTALLATION SUSPENDED-----
@

```

Later, when you want to continue, type INSTA at the @ prompt, as shown.

```

@INSTA

-----SYSTEM CONFIGURATION DIALOG-----
DAY    MM/DD    HH:MM:SS    YYYY    SYSTEM NAME    ID:000

You have an installation already in progress.
Do you wish to start over with a NEW INSTALLATION?
(Y/N, Empty line = NO, continue installation in progress)
:
d)How many ports will be used? (1-8, empty line = 4)
:

```

Begin entering data where you left off.

Reinstalling an Installed Octel Overture 200/300

After the Octel Overture 200/300 is installed, situations could arise that warrant a reinstallation of the message server such as the following:

- The PBX has been replaced.
- There were errors during INSTALL. (Instituting a reinstallation might be more time-efficient than correcting major errors.)
- The server has been upgraded to a larger disk.

During a reinstallation, you can use the following options to:

- Reinstall the Octel Overture 200/300, answering every question in the INSTALL program.
- Preload all the configuration tables from the backup configuration diskette.
- Preload the specific range of tables.

Enter INSTA at the @ prompt. If you enter Y to reinstall the message server, the message server prompts for a password. Enter the maintenance level password. If you do not enter a password or you enter an incorrect password, the INSTALL program is aborted.

```

@INSTA

----- SYSTEM INSTALLATION DIALOG -----
DAY MM/DD HH:MM:SS YYYY SYSTEM NAME ID:000 S/N:000000 PBX:00

SYSTEM HAS ALREADY BEEN INSTALLED.
Do you wish to RE-INSTALL? (Y/N, empty line = N)
<<IF YES, ALL TABLES WILL BE CLEARED AND USER MESSAGES WILL BE LOST>>
:Y
PASSWORD:
CLEARING ALL TABLES...DONE.
INITIALIZING ALL USER DIRECTORIES...DONE.

```

All the information entered earlier during the INSTALL is cleared. The message server prompts you to preload any configuration tables from the backup configuration diskette.

```

Do you wish to PRE-LOAD any tables from a previous INSTALL
from your DISKETTE? (Y/N, empty line = N)
:

```

If you answer N, none of the database tables are loaded. The reinstallation begins with the first INSTALL question. Refer to the Answering Questions in INSTALL section.

If tables should be preloaded, enter Y and insert the configuration-backup diskette in the message server drive. The message server asks if all tables should be preloaded.

```

Insert desired DISKETTE in drive. Press RETURN when ready...

PRE-LOAD ALL configuration tables?
:Y

```

If you answer Y, the Octel Overture 200/300 preloads all of the system configuration tables. If you answer N, the Octel Overture 200/300 responds with the following:

```

PRE-LOAD USERS, DIST. LIST, COS, SCHEDULE, INFO., HOLIDAY and NAMES tables?

```

If you answer Y, these tables are preloaded. If you answer N, no tables are preloaded.

Answering Y To Preload All Tables

When preloading, all configuration tables are loaded. However, if a feature has not been purchased for the message server, that table is not used.

```

@INSTA

SYSTEM HAS ALREADY BEEN INSTALLED.
Do you wish to RE-INSTALL? (Y/N, empty line = N)
<<IF YES, ALL TABLES WILL BE CLEARED AND USER MESSAGES WILL BE LOST>>
:Y
PASSWORD:
CLEARING ALL TABLES...DONE.
INITIALIZING ALL USER DIRECTORIES...DONE.
Do you wish to PRE-LOAD any tables from a previous INSTALL
from your DISKETTE? (Y/N, empty line = N)
:Y
Insert desired DISKETTE in drive. Press RETURN when ready...

PRE-LOAD ALL configuration tables?
:Y

Table PRELOAD COMPLETE.

1. SYSTEM PARAMETERS.
   Table PRE-LOADED from disk. UPDATE if necessary when INSTALL is complete.
2. USER.
   Table PRE-LOADED from disk. UPDATE if necessary when INSTALL is complete.
3. SLOTS.
   Table PRE-LOADED from disk. UPDATE if necessary when INSTALL is complete.
4. NETWORK ROUTES.
   Table PRE-LOADED from disk. UPDATE if necessary when INSTALL is complete.
5. NETWORK LOCATIONS.
   Table PRE-LOADED from disk. UPDATE if necessary when INSTALL is complete.
6. NETWORK NUMBERING PLAN.
   Table PRE-LOADED from disk. UPDATE if necessary when INSTALL is complete.
7. DISTRIBUTION LISTS.
   Table PRE-LOADED from disk. UPDATE if necessary when INSTALL is complete.
8. COS.
   Table PRE-LOADED from disk. UPDATE if necessary when INSTALL is complete.
9. INFORMATION Tables.
   Table PRE-LOADED from disk. UPDATE if necessary when INSTALL is complete.
10. SCHEDULE Table.
    Table PRE-LOADED from disk. UPDATE if necessary when INSTALL is complete.

WARNING: FOR PROPER OPERATION SYSTEM MUST BE RESTARTED AFTER INSTALL:

INSTALL COMPLETE.

WAIT...DONE.

SAVE configuration to a DISKETTE? (Y/N, empty line = N).
:Y

```

You must reload the Octel Overture 200/300 for it to operate correctly. At the @ prompt, enter RESTA 2. Make all UPDATE modifications after the message server has rebooted.

Answering N To Preload All Tables

When you answer N, no tables are preloaded.

```

@INSTA

SYSTEM HAS ALREADY BEEN INSTALLED.
Do you wish to RE-INSTALL? (Y/N, empty line = N)
<<IF YES, ALL Tables WILL BE CLEARED AND USER MESSAGES WILL BE LOST>>
:Y
PASSWORD
CLEARING ALL Tables...Done.
INITIALIZING ALL USER DIRECTORIES...DONE.
Do you wish to PRE-LOAD any tables from a previous INSTALL
from your DISKETTE? (Y/N, empty line = N)
:Y
Insert desired DISKETTE in drive. Press RETURN when ready...

PRE-LOAD ALL configuration tables?
:N

RE-LOAD USERS, DIST. LIST, COS, SCHEDULE, INFO., HOLIDAY and NAMES tables?
:Y

PRE-LOAD NETWORKING Tables (ROUTE, LOCATION, and ACCESS)?
:N

Table PRE-LOAD COMPLETE.

1.  SYSTEM PARAMETERS.

```

The message server continues with the regular installation questions until it reaches 2. USER.

```

2.  USER
    Table PRE-LOADED from disk. UPDATE if necessary when INSTALL is complete.

```

```

3.  SLOTS.

```

```

4.  NETWORK ROUTES

```

The following questions appear the same as in a regular installation.

```

5.  NETWORK LOCATIONS.
6.  NETWORK NUMBERING PLAN.

```

7. DISTRIBUTION LISTS.
Table PRE-LOADED from disk. UPDATE if necessary when INSTALL is complete.
8. COS.
Table PRE-LOADED from disk. UPDATE if necessary when INSTALL is complete.
9. INFORMATION TABLES.
Table PRE-LOADED from disk. UPDATE if necessary when INSTALL is complete.
10. SCHEDULE TABLES.
Table PRE-LOADED from disk. UPDATE if necessary when INSTALL is complete.

Continue with the questions as shown in INSTALL, until this message appears:

```

WARNING: FOR PROPER OPERATION SYSTEM MUST BE RESTARTED AFTER INSTALL!

INSTALL COMPLETE.

WAIT...DONE.

SAVE configuration to a DISKETTE? (Y/N, empty line = N).

:Y

DAY MM/DD HH:MM:SS YYYY SYSTEM NAME ID:000000 S/N:000000 PBX:00
- - - - - SYSTEM INSTALLATION COMPLETED - - - - -

```

For correct operation, you must reload the Octel Overture 200/300 after INSTALL. At the @ prompt, type

RESTA 2

2

HARDWARE

Chapter Contents

2.1	Hardware	2-1
	Octel Overture 200/300 Cabinets	2-1
	Octel Overture 200 Cabinet	2-2
	Octel Overture 300 Cabinet	2-8
	Subsystem Configurations	2-14
	Line Interface Cards	2-18
	Telemarketing Line Card (TLC)	2-19
	Direct Access Card (DAC)	2-19
	EntryWorks ACP Card	2-19
	Fax Application Processor	2-20
	LAN Card	2-20
	Integration Cards	2-20
	Voice Control Unit (VCU)	2-21
	Central Processing Unit (CPU)	2-22
	Power Supply Unit (PSU)	2-22
	Motherboard	2-23
	Option Control Chip (OCC)	2-24
	Works for Serenade Hard Disk	2-25
	Octel Overture 300 Load/Backup Device	2-25
	Hard Disk Drives	2-25

Figures

2-1	Octel Overture 200 Cabinet Shelf Structure, From the Front	2-4
2-2	Octel Overture 200 Cabinet, Inside Front View	2-5
2-3	Octel Overture 200 Cabinet, Rear View	2-6
2-4	Octel Overture 200 Cabinet, Inside Rear View	2-7
2-5	Octel Overture 300 Cabinet Shelf Structure, From the Front	2-10
2-6	Octel Overture 300 Cabinet, Inside Front View	2-11
2-7	Octel Overture 300 Cabinet, Rear View	2-12
2-8	Octel Overture 300 Cabinet, Inside Rear View	2-13

2

HARDWARE

Tables

2-1	Octel Overture 200/300 Subsystems	2-14
2-2	Octel Overture 200 Subsystems	2-17
2-3	Octel Overture 300 Subsystems	2-18
2-4	Power Supply Unit d.c. Voltages	2-23

Quick Reference Guide

Hardware

Octel Overture 200 Message Server Specifications

Mailboxes	Up to 5,000 per cabinet With Capacity On Demand, mailboxes are purchased as required.
Messages	Maximum number: 60 per mailbox, configurable by COS Maximum length: 3.0 hours, configurable by COS
Capacity (per cabinet)	
Voice Storage	Up to 540 hours per cabinet. With Capacity On Demand, storage hours are purchased as required.
Redundant Voice Storage	Up to 270 hours, optional
Redundant System Storage	Standard with multiple-disk message servers
Ports	Up to 64 ports. With Capacity On Demand, ports are purchased as required.
Maximum Cabinets per System	10 (with Collocated Analog Networking)
Classes of Service (COS)	255
Cabinet Specifications	
Cabinet Dimensions	
Height	24.8 inches (63.0 cm)
Width	13.0 inches (33.0 cm)
Depth	19.5 inches (49.5 cm)
Cabinet Weight	100 pounds (45.4 kg) maximum, depending on configuration
Air Intake	150 cfm
Air Filter	Washable, installed in door
Cable Access	Rear
Service Access	Front, locked door

Quick Reference Guide

Hardware

Octel Overture 200 Message Server Specifications (continued)

Electrical Requirements

120-Vac System	90–132 Vac
Voltage Range	47–63 Hz
Frequency	500 watts
Maximum Power	

230-Vac System	180–260 Vac
Voltage Range	47–63 Hz
Frequency	500 watts
Maximum Power	

–48-Vdc System	42–60 Vdc
Voltage Range	500 watts
Maximum Power	

Remote Alarm

Alarm Relay	
Closures	2 (Major, Minor)
Rating	0.5 A at 48 Vdc
Access	Rear, DB9 connector
Alarm Callout	Automatic Callout to configurable service number
Alarm Types	Major Alarm, Minor Alarm
Temperature Alarm	At Alarm Temperatures <50F or >122F (<10C or >50C)

Environmental Requirements

Temperature	
Operating (Sea Level)	50F (10C) to 104F (40C)
Nonoperating	–50F (–10C) to 129F (54C)
Gradient, Operating	18F (10C) per hour, maximum
Gradient, Nonoperating	36F (20C) per hour, maximum
Humidity, Operating	20–80%, noncondensing
Atmosphere, Particulate Matter	80 micrograms per cubic millimeter (max)
Corrosive Gases	<10 ppm

Quick Reference Guide

Hardware

Octel Overture 200 Message Server Specifications (continued)

Environmental Requirements (continued)

Altitude	-200 to 10,000 feet (-61 to 3,048 meters)
Operating	-200 to 40,000 feet (-61 to 12,192 meters)
Nonoperating, transit	-200 to 10,000 feet (-61 to 3,048 meters)
Nonoperating, storage	

Vibration, operational at 22–500 Hz	0.1 g
--	-------

Installation Environment	Equipment room or office
---------------------------------	--------------------------

Flooring	No special requirements
-----------------	-------------------------

Cabinet Clearance	22 inches (55.9 cm)
Front	6 inches (15.2 cm)
Rear	1 inch (2.5 cm)
Sides	1 inch (2.5 cm)
Top	

Heat Dissipation	Maximum 500 watts (1706 Btu per hour) per cabinet, each cooled with two internal, 4-inch (10.2-cm) fans
-------------------------	---

Interfaces

Telephone Ports	2-wire, 2500-type; 2-wire, DID-type, optional
------------------------	---

Port Connector	50-pin telco, four ports per connector with 4-port LIC, eight ports per connector with 8-port LIC, twelve ports per connector with 12-port ILC12, and sixteen ports per connector with 16-port DLC16, rear access, and sixteen ports per DAC I/O panel (four-port DAC)
-----------------------	--

System Serial Port	RS-232C, auto-baud-rate select, DB25, 300–19,200 bps
---------------------------	--

RS-232C Integration Port	RS-232C, 1200 bps, DB25
---------------------------------	-------------------------

Internal Modem	300/1200/2400 baud; Bell 103/212A and CCITT V.22/CCITT V.22 bis, one per cabinet, accessible from any telephony port
-----------------------	--

Works Serial Ports	Four RS-232C (2 DB9, 2 DB25) ports, rear access
---------------------------	---

Alarm Relay	DB9, rear access
--------------------	------------------

Quick Reference Guide

Hardware

Octel Overture 200 Message Server Specifications (continued)

Routine Maintenance

Air Filter Cleaning	At least yearly
Fan Inspection	At least yearly

System Protection

Overtemperature Shutdown

Disk Drive Spin Down	<41F or >131F (<5C or >55C), automatic recovery
Power Supply Shutdown	158F (70C), circuit breaker trip, manual recovery

Power Supply Unit Protection

Circuit Fuse

120-Vac systems	10 A
230-Vac systems	5 A
DC systems	15 A

Overcurrent	Four d.c. outputs, over current protection, automatic recovery
Overvoltage	Power supply shut off
Overtemperature	Power supply shut off, automatic recovery

System Adjustments

Cabinet Adjustments	Levelers
Internal Adjustments	None

Time-of-Day Clock

Accuracy	± 1 min/mo, at 77F / 25C
Battery Hold Time	>1 year, at 77F / 25C
Battery Life	10 years, at 77F / 25C

Quick Reference Guide

Hardware

Octel Overture 300 Message Server Specifications

Mailboxes	Up to 10,000 per cabinet. With Capacity On Demand, mailboxes purchased as required
Messages	
Maximum Number	60 per mailbox, configurable by COS
Maximum Length	3.0 hours, configurable by COS
Capacity (per cabinet)	
Voice Storage	Up to 1085 hours per cabinet. With Capacity On Demand, storage hours purchased as required
Redundant Voice Storage	Up to 542 hours, optional
Redundant System Storage	Standard with multiple-disk systems
Ports	Up to 128 ports. With Capacity On Demand, ports purchased as required
Maximum Cabinets per System	10 (with Collocated Analog Networking)
Classes of Service (COS)	255
Cabinet Specifications	
Cabinet Dimensions	
Height	37.5 inches (95.3 cm)
Width	17.5 inches (44.5 cm)
Depth	19.5 inches (49.5 cm)
Cabinet Weight	220 pounds (100 kg) maximum, depending on configuration
Air Intake	300 cfm
Air Filter	Washable, installed in door
Cable Access	Rear
Service Access	Front, locked door
Rack Mount	19-inch (48.3 cm), optional

Quick Reference Guide

Hardware

Octel Overture 300 Message Server Specifications (continued)

Electrical Requirements

120-Vac System	
Voltage Range	90–132 Vac
Frequency	47–63 Hz
Maximum Power	1000 watts
230-Vac System	
Voltage Range	180–260 Vac
Frequency	47–63 Hz
Maximum Power	1000 watts
–48-Vdc System	
Voltage Range	42–60 Vdc
Maximum Power	1000 watts

Remote Alarm

Alarm Relay Closures	2 (Major, Minor)
Rating	0.5 A at 48 Vdc
Access	Rear, DB9 connector
Alarm Callout	Automatic Callout to configurable service number
Alarm Types	Major Alarm Minor Alarm
Temperature Alarm	At Alarm Temperatures <50F or >122F (<10C or >50C)

Environmental Requirements

Temperature	
Operating (Sea Level)	50F (10C) to 104F (40C)
Nonoperating	–50F (–10C) to 129F (54C)
Gradient, Operating	18F (10C) per hour, maximum
Gradient, Nonoperating	36F (20C) per hour, maximum
Humidity, Operating	20–80%, noncondensing
Atmosphere, Particulate Matter	80 micrograms per cubic millimeter (max)
Corrosive Gases	<10 ppm

Quick Reference Guide

Hardware

Octel Overture 300 Message Server Specifications (continued)

Environmental Requirements (continued)

Altitude	
Operating	-200 to 10,000 feet (-61 to 3,048 meters)
Nonoperating, in transit	-200 to 40,000 feet (-61 to 12,192 meters)
Nonoperating, in storage	-200 to 10,000 feet (-61 to 3,048 meters)

Vibration, operational at 22–500 Hz	0.1 g
--	-------

Installation Environment	Equipment room or office
---------------------------------	--------------------------

Flooring	No special requirements
-----------------	-------------------------

Cabinet Clearance

Front	22 inches (55.9 cm)
Rear	6 inches (15.2 cm)
Sides	1 inch (2.5 cm)
Top	1 inch (2.5 cm)

Heat Dissipation	Maximum 1,000 watts (3412 Btu per hour) per cabinet, each cooled with four internal, 4-inch (10.2-cm) fans
-------------------------	--

Interfaces

Telephone Ports	2-wire, 2500-type; 2-wire, DID-type, optional
------------------------	---

Port Connector	50-pin telco, four ports per connector with 4-port LIC, eight ports per connector with 8-port LIC, twelve ports per connector with 12-port ILC12, and sixteen ports per connector with 16-port DLC16, rear access; and sixteen ports per DAC I/O panel (four-port DAC)
-----------------------	--

Serial Port	RS-232C, auto-baud-rate select, DB25, 300–19,200 bps
--------------------	--

RS-232C Integration Port	RS-232C, 1200 bps, DB25
---------------------------------	-------------------------

Internal Modem	300/1200/2400 baud; Bell 103/212A and CCITT V.22/CCITT V.22bis, one per cabinet, accessible from any telephony port
-----------------------	---

Works Serial Ports	Four RS-232C (2 DB9, 2 DB25) ports, rear access
---------------------------	---

Alarm Relay	DB9, rear access
--------------------	------------------

Quick Reference Guide

Hardware

Octel Overture 300 Message Server Specifications (continued)

Routine Maintenance

Air Filter Cleaning	At least yearly
Fan Inspection	At least yearly

System Protection

Overtemperature Shutdown

Disk Drive Spin Down	<41F or >131F (<5C or >55C), automatic recovery
Power Supply Shutdown	158F (70C), circuit breaker trip, manual recovery

Power Supply Unit Protection

Circuit Breaker	System overcurrent trip, manual recovery
Overcurrent	All six d.c. outputs, automatic recovery
Overvoltage	All six d.c. outputs, circuit breaker trip, manual recovery
Overtemperature	Circuit breaker trip, manual recovery

System Adjustments

Cabinet Adjustments	Levelers
Internal Adjustments	None

Time of Day Clock

Accuracy	± 1 min/mo, at 77F / 25C
Battery Hold Time	>1 year, at 77F / 25C
Battery Life	10 years, at 77F / 25C

2.1 HARDWARE

The Hardware chapter discusses the Octel Overture™ 200 and Octel Overture 300 message-server architecture. Except where noted, the information is the same for both message servers.

Octel Overture 200/300 Cabinets

Octel Overture 200/300 cabinets are designed to allow all normal maintenance to be performed from the front. All message server cabling is connected at the rear of the cabinet. No side access is necessary.

The message server door should be closed and locked when access is not required. The door can be removed, as needed.

The following connection points are found on the rear of an Octel Overture 200/300 message server:

- System terminal port
- Alarm port
- 50-pin telco connectors
- RS-232C connectors

System Terminal Ports

The system terminal port is an RS-232C port used to communicate with the Octel Overture 200/300 for message server configuration, error reporting, and other system maintenance. Two parallel connectors to the system terminal port are located on the cabinet, one in the front (SP1) and one in the rear (J1). Connection can be made to **only** one of these connectors at a time. If a terminal is to remain with the message server permanently, use the rear connector. If a terminal is to be connected temporarily, use the front connector. The front cabinet door must be open to use the front connection.

The system terminal port supports any ASCII send/receive serial terminal. Refer to the Installation chapter, Connecting Terminals section, in this volume.

System Alarm Port

Major and minor alarm relays provide alarms for hardware errors. A dry-relay contact closure is provided for the major and minor alarms. Refer to the Installation chapter, Connecting Terminals section, of this manual for the pinout configuration for the alarm relays.

Relay controls are connected to the alarm relay port at the rear of the cabinet. The alarm relays are located on the CPU board. Any hardware error closes the minor alarm relay. Any alarm call also closes the major alarm relay. Refer to the Maintenance Commands chapter, Alarm Test section, in this volume.

If power fails, both relays close the contacts. Both relays remain closed during power restoration until the software boot process opens the relays. However, if there was an alarm condition before the power failure or an alarm condition arises during the boot process, the relays remain closed until the hardware errors are cleared.

I/O Panel

Telco connectors with 50-pins, on the I/O panel, are used to connect cables from the various Octel Overture 200/300 line interface cards (LIC), telemarketing cards (TLC), direct access cards (DAC), and integration cards to the PBX.

RS-232C Connectors

RS-232 connectors are used for terminal communication. J2 is used for RS-232C integration.

Octel Overture 200 Cabinet

Each Octel Overture 200 cabinet is shipped fully assembled. The cabinet specifications are as follows:

Height:	24.8 inches (63.0 cm)
Width:	13.0 inches (33.0 cm)
Depth:	19.5 inches (49.5 cm)
Weight:	100 pounds (45.4 kg) maximum
Clearances	
Front:	22 inches (56 cm)
Rear:	6 inches (15 cm)
Side:	1 inch (2.5 cm)
Top:	1 inch (2.5 cm)

The Octel Overture 200 outer metal enclosure contains two shelves, with slots for various configurations of disk drives and system cards. Figure 2-1 through Figure 2-4 show various views and component locations for the Octel Overture 200 message server.

Shelf A

Shelf A contains 10 card slots, with slots A8–A10 reserved for the voice control unit (VCU) in slot A8, the central processing unit (CPU) in slot A9, and the power supply unit (PSU) in slot A10. The card slots in shelf A of the Octel Overture 200 cabinet could contain the following.

Slot Number(s)	Card Type/Other
A1–A6	LIC, TLC, DAC, or integration cards
A1–A7	Fax card
A5–A7	LAN card
A7	EntryWorks ACP card
A8	VCU
A9	CPU
A10	(PSU, which includes the floppy disk load device)

The Octel Overture 200 can be configured with 4-port, 8-port, or 16-port line cards, in any combination, to a maximum of 64 ports.

Refer to the *Configuration* volume, Slots Table chapter, for information about configuring the slots.

Shelf B

Shelf B contains a slot for a Works for Serenade disk drive and three slots for system/voice disk drives. The disk drive usage by slot number is as follows:

Slot Number	Type of Disk Drive Installed
B1	Works for Serenade disk drive
B2, B3	System/voice disk drives (data and voice storage)
B4	Voice disk drive

The system/voice and voice disk drives are loaded into the slots in the following order: B2, B3, B4. A single-drive message server has a system/voice drive installed in slot B2; a two-drive message server has system/voice drives installed in slots B2 and B3; a three-drive message server has system/voice drives installed in slots B2 and B3 and a voice drive installed in slot B4.

Other Components

Two fans are located at the rear of the cabinet.

The washable air filter is located inside the front door of the cabinet. Air intake is from the front, and air exhaust is from the rear of the cabinet.

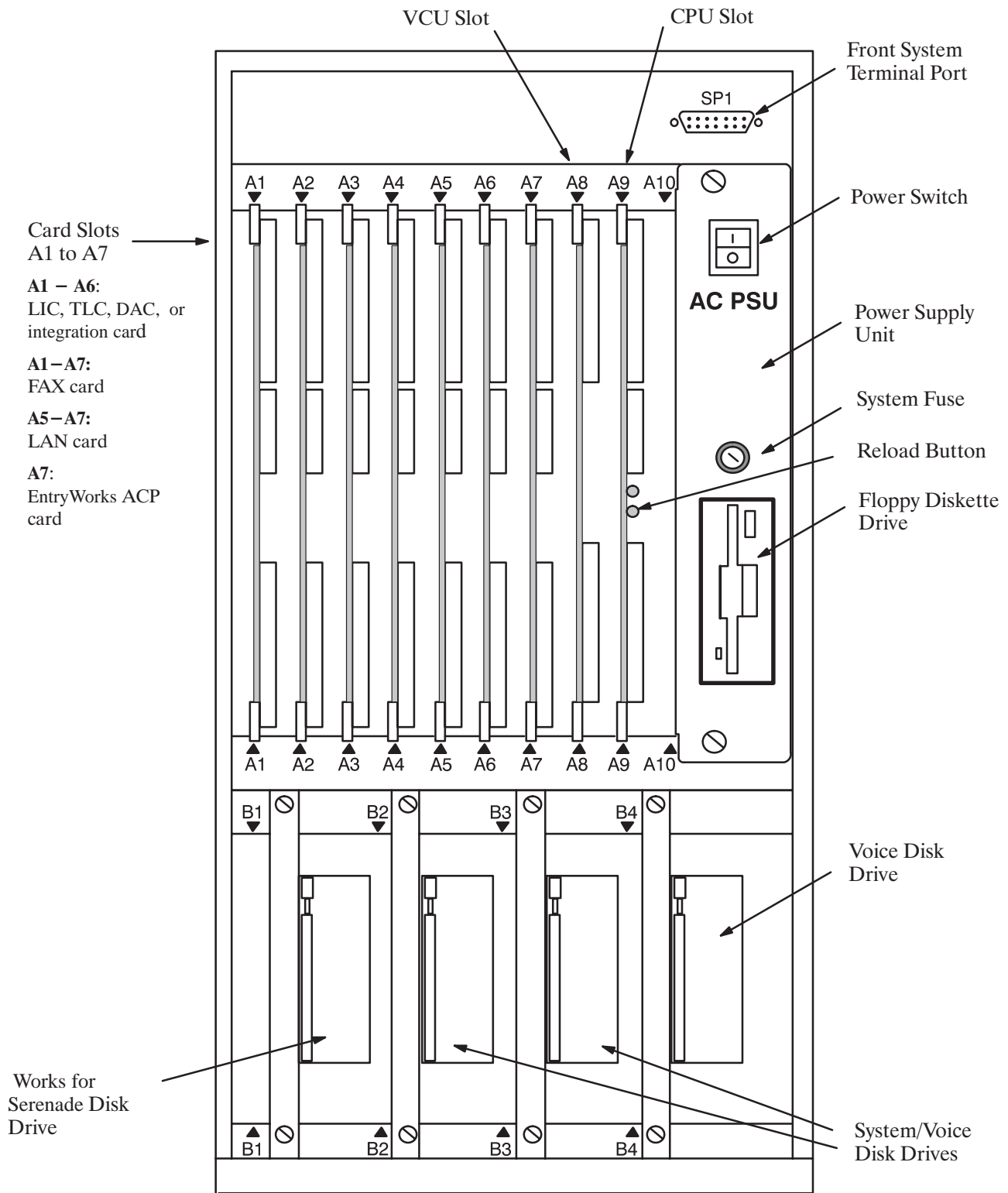

Figure 2-1 Octel Overture 200 Cabinet Shelf Structure, From the Front

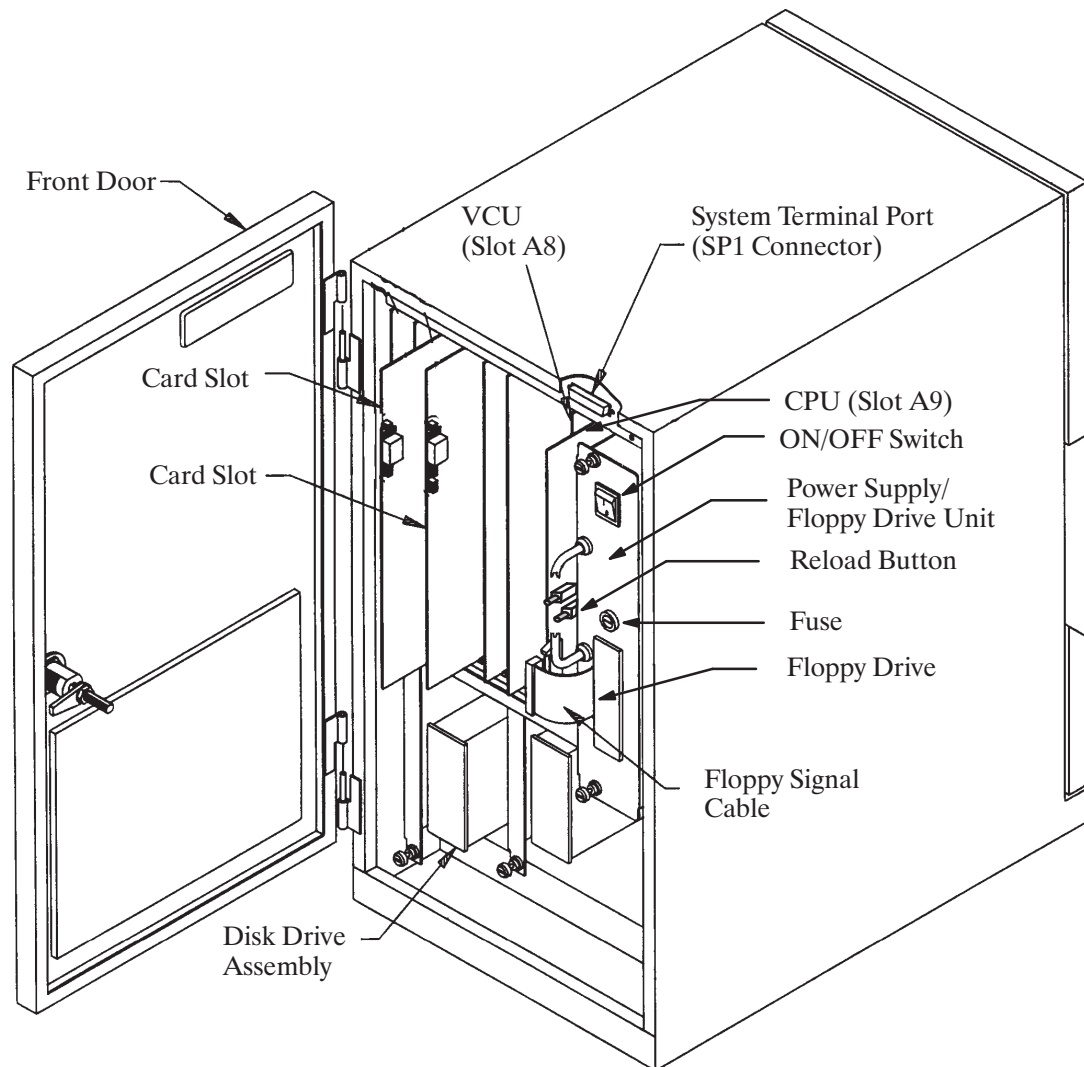

Figure 2-2 Octel Overture 200 Cabinet, Inside Front View

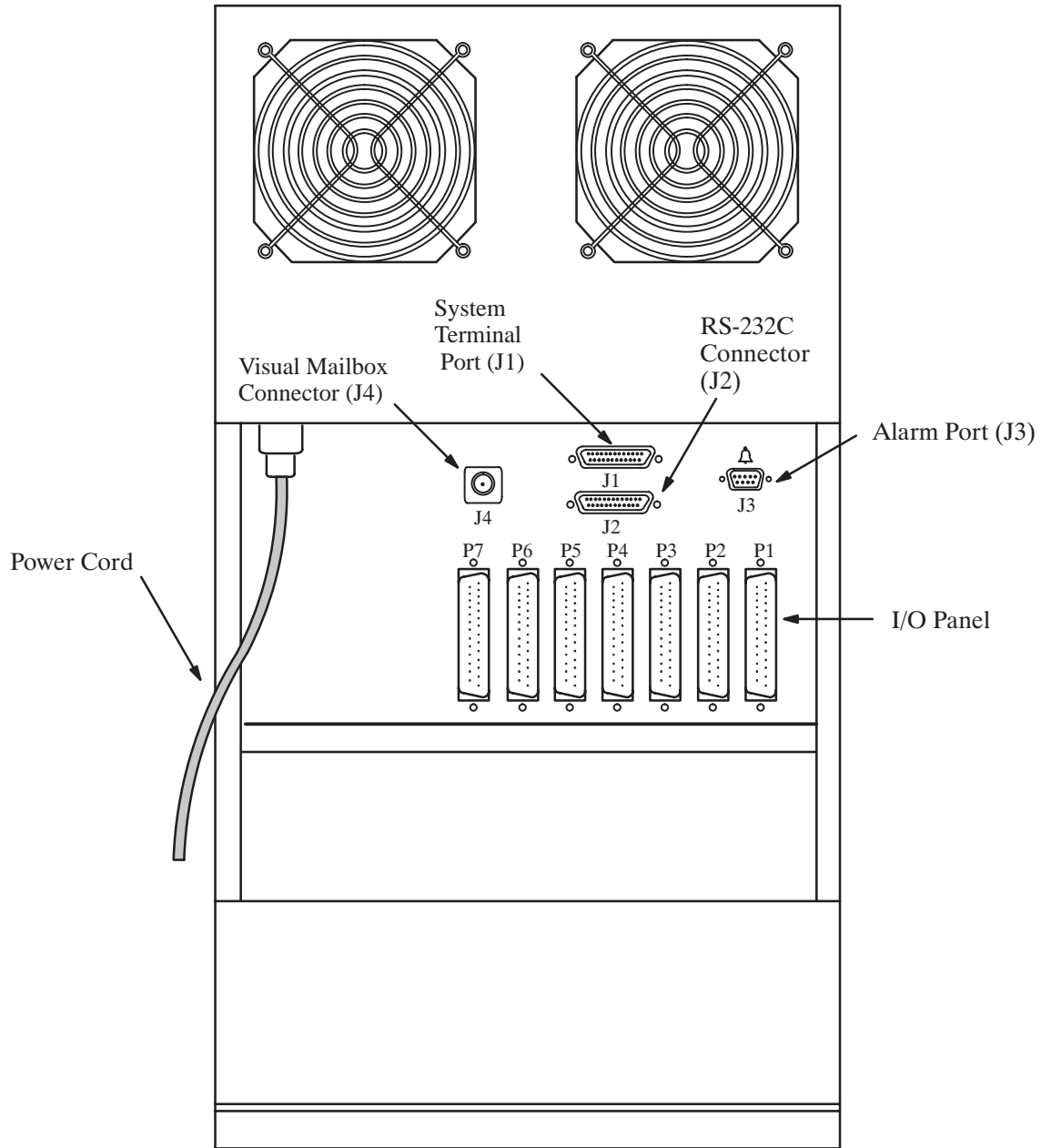

Figure 2-3 Octel Overture 200 Cabinet, Rear View

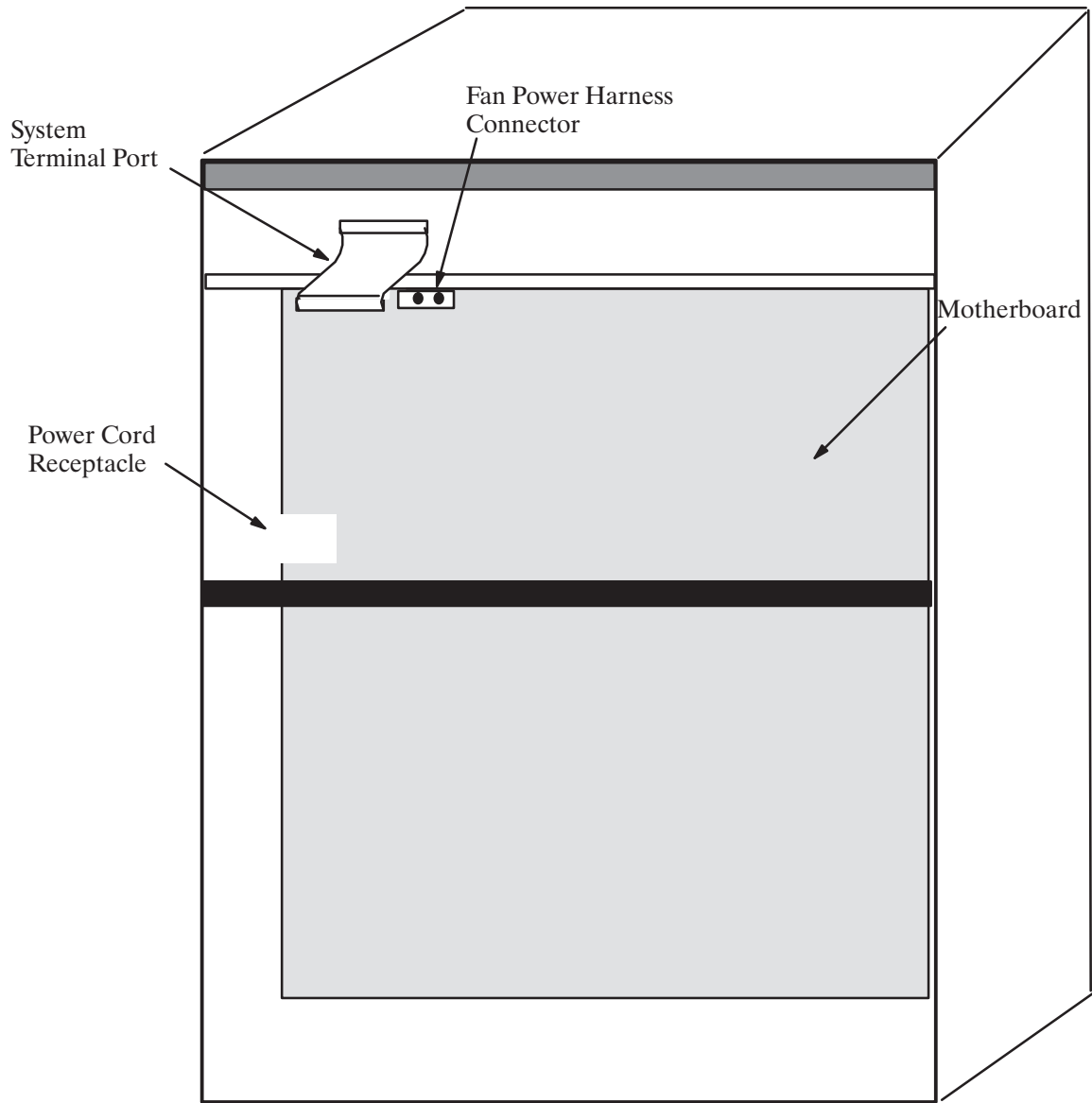

Figure 2-4 Octel Overture 200 Cabinet, Inside Rear View

Octel Overture 300 Cabinet

Each Octel Overture 300 message server is shipped fully assembled. The cabinet specifications are as follows:

Height:	37.5 inches (95.3 cm)
Width:	17.5 inches (44.5 cm)
Depth:	19.5 inches (49.5 cm)
Weight:	220 pounds (100 kg) maximum
Clearances	
Front:	22 inches (55.9 cm)
Rear:	6 inches (15.2 cm)
Side:	1 inch (2.5 cm)
Top:	none

The power line filter is located at the rear of the cabinet. The a.c. system power cord plugs into the power line filter. The power line filter prevents electromagnetic interference (EMI), from entering the primary power lines. Some chassis disassembly is required to replace the power line filter. The voltage rating of the power line filter must agree with the input voltage rating of the power supply unit (PSU).

 In -48 Vdc message servers, the power cord is integral with the power line filter.

The outer metal enclosure contains three shelves, with slots for various configurations of disk drives and system cards. Figure 2-5 through Figure 2-8 show various views and component locations for the Octel Overture 300 message server.

Shelf A

Shelf A contains 15 card slots, with card slots A13–A15 reserved for the voice control unit (VCU) in slot A13, the central processing unit (CPU) in slot A14, and the power supply unit (PSU) in slot A15. The card slots in shelf A of the Octel Overture 300 cabinet could contain the following.

Slot Number(s)	Card Type/Other
A1–A11	LIC, TLC, DAC, or integration cards
A1–A12	Fax card
A10–A12	LAN card
A12	EntryWorks ACP card
A13	VCU
A14	CPU
A15	PSU

Refer to the *Configuration* volume, Slots Table, for information about configuring the slots.

Shelves B and C

The slots in shelves B and C allow various configurations of Octel Overture 300 hard disk drives and contain the message server's load/backup device. The disk drive usage by slot number is as follows:

Slot Number	Type of Disk Drive Installed
Shelf B	
B1	Reserved for future use
B2	Works for Serenade disk drive
B3–B4	System/voice disk drives (data and voice storage)
B5	Load/backup device
Shelf C	
C1–C4	Voice disk drives (voice storage only)

The system/voice and voice disk drives are loaded into the slots in the following order: B3, B4, C1, C2, C3, and C4. A single-drive message server has a system/voice drive installed in slot B3; a two-drive message server has system/voice drives installed in slots B3 and B4; a three-drive message server has system/voice drives installed in slots B3 and B4 and a voice drive installed in slot C1; and so forth..

The Octel Overture 300 can be configured with 4-port, 8-port, or 16-port line cards, in any combination of line cards, to a maximum of 128 ports. Refer to the *General Description* volume, Product Description chapter, General Sizing Consideration and Capacity section, for additional information.

Other Components

The washable air filter is inside the front door of the cabinet. The air intake is from the front, and air exhaust is from the rear and top.

Octel Overture 300 Fan Tray

Four fans are located on a slide-out fan tray in the center of the cabinet, between shelves A and B. The fan tray is a plug-in fan assembly used for system cooling. The fan assembly is accessible from the front of the cabinet.

The four fans draw air through the front door air filter, and they exhaust from the top rear and top sides of the cabinet. The fans use 12 volts and are powered from the +12 VM output of the PSU. The fans are not sensitive to the input power to the cabinet.

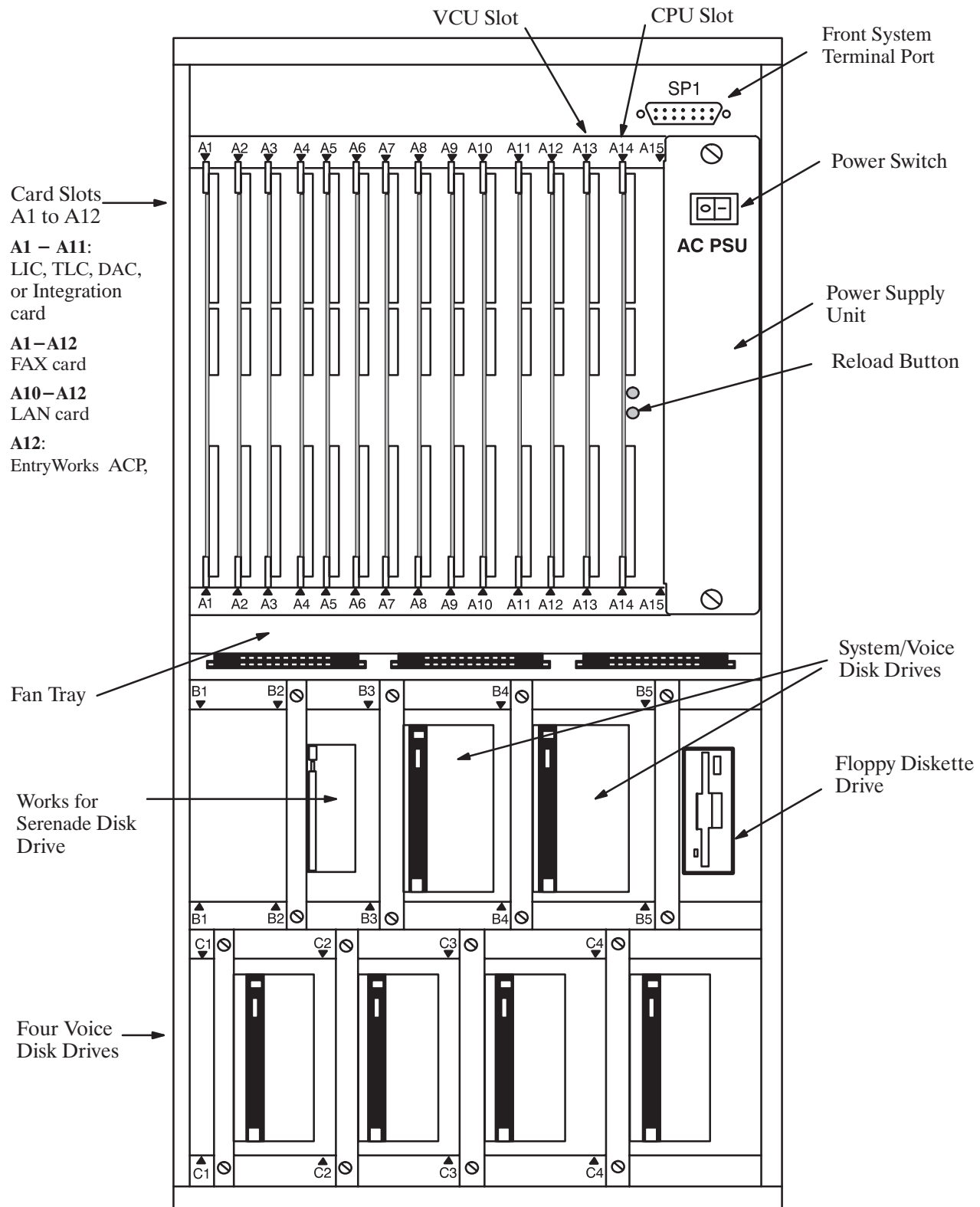

Figure 2-5 Octel Overture 300 Cabinet Shelf Structure, From the Front

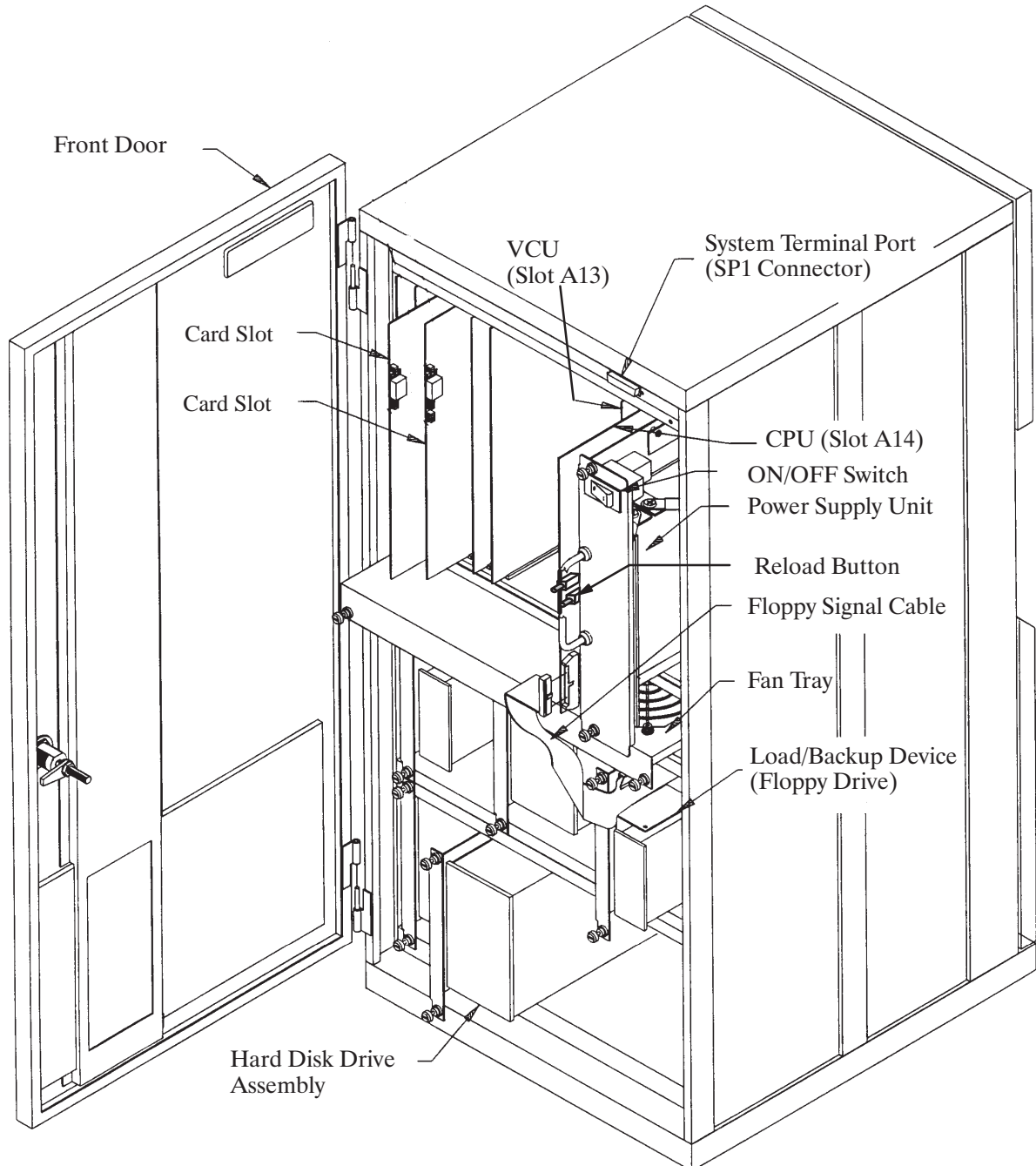

Figure 2-6 Octel Overture 300 Cabinet, Inside Front View

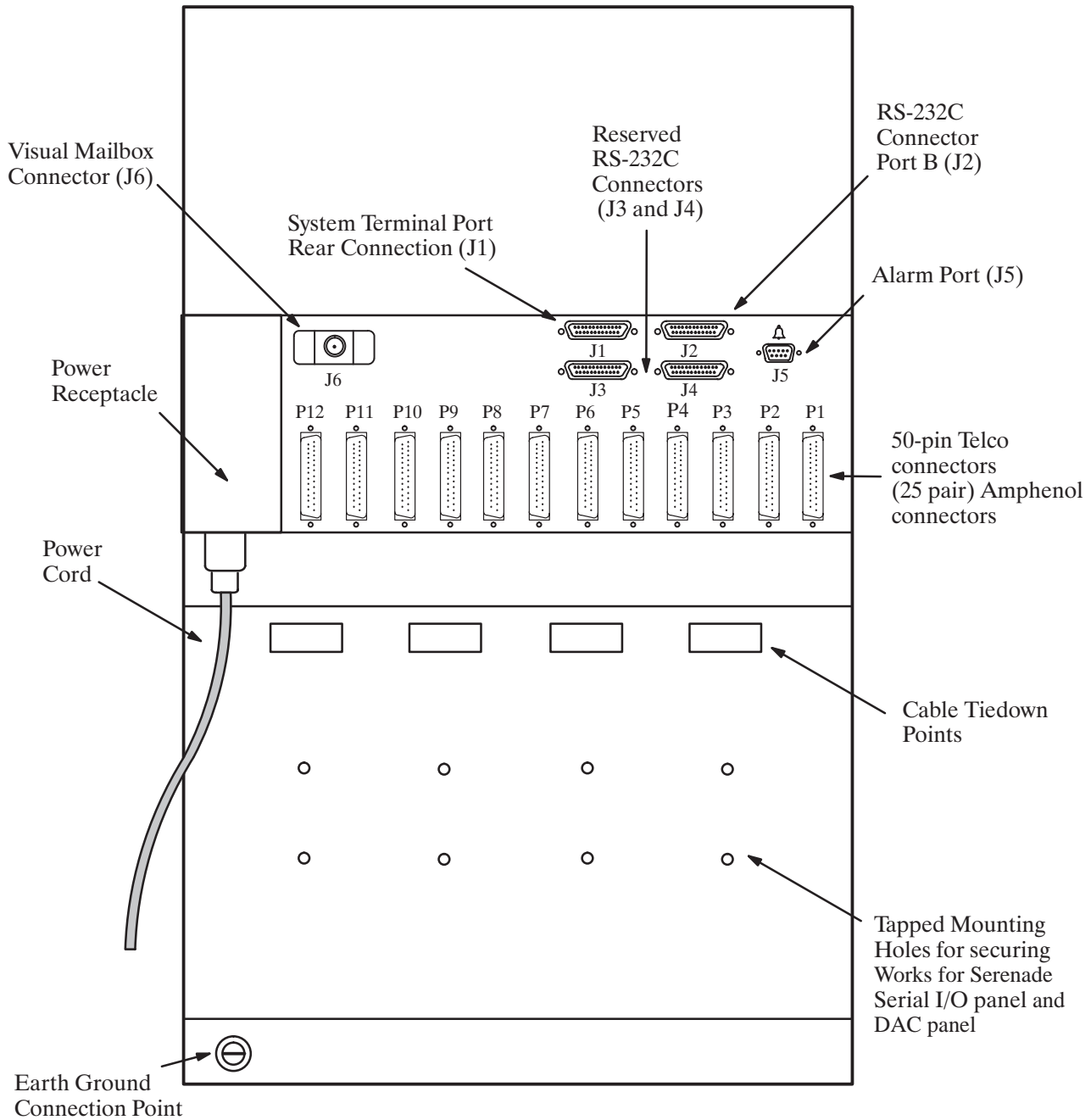

Figure 2-7 Octel Overture 300 Cabinet, Rear View

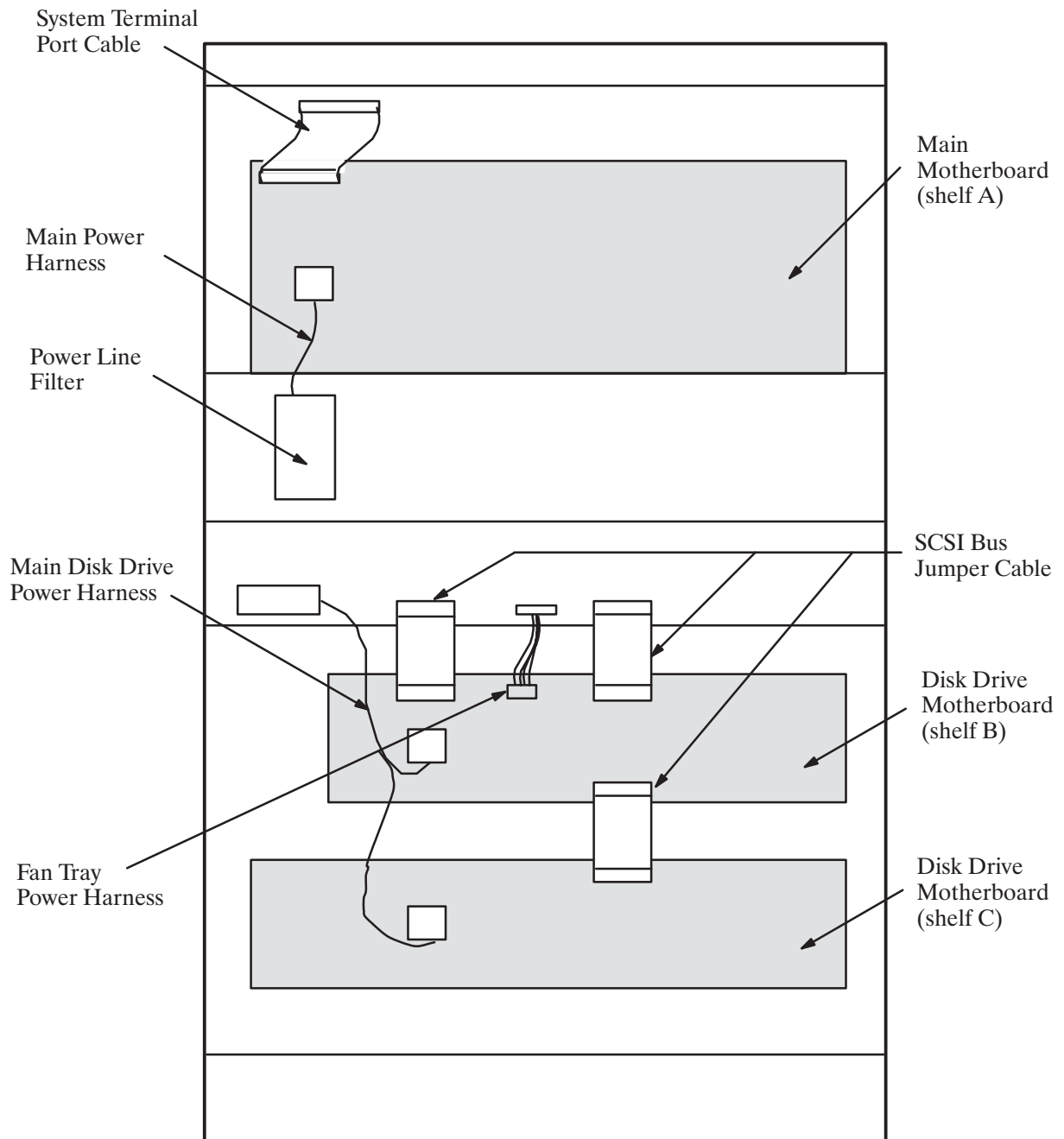

Figure 2-8 Octel Overture 300 Cabinet, Inside Rear View

Subsystem Configurations

The following tables list each subsystem name, abbreviation, part number, and a brief description. Table 2-1 lists subsystems that are interchangeable between the Octel Overture 200 and the Octel Overture 300 message server. Table 2-2 lists subsystems for the Octel Overture 200 message server and Table 2-3 lists subsystems for the Octel Overture 300 message server. Following the last table are more complete descriptions of the subsystems.

Table 2-1 Octel Overture 200/300 Subsystems

Subsystem Configurations	Part Number	Description
STORAGE		
500-MB Storage Drive Overture 200 – 37/46 hours* Overture 300 – 31/46 hours*	740-6632-002	Capacity on Demand (COD), 0 hour drives. SCSI hard disk drives for storage of voice messages, prompts, system configuration data, and software.
1.0-GB Storage Drive Overture 200 – 87/96 hours* Overture 300 – 81/96 hours*	740-6631-002	
2.0-GB Storage Drive Overture 200 – 176/185 hours* Overture 300 – 170/185 hours*	740-6633-002	* The capacity is for message server overhead and one language (slots 1 and 2) and full capacity (slots 3–6). Subtract 1.2 hours for each additional language.
LINE INTERFACE CARDS (LIC)		
United States, Canada, Mexico	300-6002-001	4-port, two-wire, loopstart telephone line interface card (LIC4); 4 ports authorized.
	300-6032-001	8-port, two-wire, loopstart telephone line interface card (LIC8); 8 ports authorized.
	300-6054-001	16-port, loopstart telephone line interface card (LIC16); 0 ports authorized.
United Kingdom	300-6002-002	4-port, two-wire, loopstart telephone line interface card; 4 ports authorized.
	300-6032-002	8-port, two-wire, loopstart telephone line interface card; 8 ports authorized.
	300-6056-002	12-port, loopstart telephone line interface card (LIC12); 0 ports authorized.
	300-6054-002	16-port, telephone line interface card; 0 ports authorized.
France, Belgium	300-6044-001	4-port, two-wire, loopstart telephone line interface card; 4 ports authorized.
	300-6054-017	16-port, loopstart telephone line interface card (LIC16); 0 ports authorized.

Table 2-1 Octel Overture 200/300 Subsystems (continued)

Subsystem Configurations	Part Number	Description
Germany	300-6044-005	4-port, two-wire, loopstart telephone line interface card; 4 ports authorized.
	300-6054-013	16-port, loopstart telephone line interface card (DLC16); 0 ports authorized.
Netherlands	300-6002-009	4-port, two-wire, loopstart telephone line interface card; 4 ports authorized.
	300-6032-009	8-port, two-wire, loopstart telephone line interface card; 8 ports authorized.
	300-6054-009	16-port, loopstart telephone line interface card (DLC16); 0 ports authorized.
New Zealand, Australia	300-6002-011	4-port, two-wire, loopstart telephone line interface card; 4 ports authorized.
	300-6032-011	8-port, two-wire, loopstart telephone line interface card; 8 ports authorized.
	300-6054-011	16-port, loopstart telephone line interface card (DLC16); 0 ports authorized.
Direct Access Card (DAC)	300-6027-001	4-port, two-wire, loopstart telephone line interface card. This card allows direct connection of incoming DID or outgoing PBX trunks.
New Zealand, Australia Direct Access Card	300-6027-011	4-port, two-wire, loopstart telephone line interface card. This card allows direct connection of incoming DID or outgoing PBX trunks.
Fax Application Processor (Fax card)	300-6037-002	4-channel fax processor that supports communication with CCITT Group 3 fax machines and operates at transmission rates of up to 9600 baud.
	300-6037-003	8-channel fax processor that supports communication with CCITT Group 3 fax machines and operates at transmission rates of up to 9600 baud.
LAN Card	300-6049-001	Used for Digital Networking, LAN Backup and Restore, and Gateway Link. Interfaces with the Octel Overture 200/300 by means of a 10BaseT Ethernet interface.
Works for Serenade ACP card	300-6019-002	Processor for Works for Serenade flow control language. Includes host interface and ACP SCSI disk drive control.

Table 2-1 Octel Overture 200/300 Subsystems (continued)

Subsystem Configurations	Part Number	Description
Telemarketing Line Card (TLC)	300-6032-003	8-port, two-wire, loopstart telephone line interface card. Octel Overture 200/300 allows recording by the first port of a TLC only if the TLC is in slot 1.
United Kingdom Telemarketing Line Card	300-6032-004	8-port, two-wire, loopstart telephone line interface card. Octel Overture 200/300 allows recording by the first port of a TLC only if the TLC is in slot 1.
Netherlands Telemarketing Line Card	300-6032-010	8-port, two-wire, loopstart telephone line interface card. Octel Overture 200/300 allows recording by the first port of a TLC only if the TLC is in slot 1.
New Zealand, Australia Telemarketing Line Card	300-6032-012	8-port, two-wire, loopstart telephone line interface card. Octel Overture 200/300 allows recording by the first port of a TLC only if the TLC is in slot 1.
AT&T Integration Card (ATTIC)	300-6018-001	Digital interface card to the AT&T System 75, System 85, and Definity PBXs. This connection provides Adaptive Integration features.
ROLM Integration Card (RIC)	300-6025-001	Digital interface card to the ROLM 8000, 9000, and 9751 PBXs. This connection provides Adaptive Integration features.
Northern Telecom SL-1 Integration Card (SLIC)	300-6009-001	Digital interface card to the Northern Telecom SL-1 and Meridian 1 PBXs. This connection provides Adaptive Integration features.
Mitel Integration Card (MIC)	300-6020-001	Digital interface card to the Mitel SX-200 Digital, SX-100/SX-200 Analog, SX-2000, and SG PBXs.
Serial Integration Card for the Meridian (SIC8)	300-6040-001	Digital interface card to the Northern Telecom Meridian 1 PBX. This connection provides Adaptive Integration features.
APIC Integration Card for AT&T Systems	300-6058-003	12-port interface card to the AT&T System 75, System 85, and Definity PBX; 0 ports authorized.
NPIC Integration Card for Northern Telecom Systems	300-6058-004	16-port interface card to the Northern Telecom Meridian 1 and Meridian SL-1 PBX; 0 ports authorized.
Voice Control Unit (VCU)	300-6001-004	File system manager, SCSI bus control, and voice bus control.
Central Processing Unit (CPU)	300-6039-003	Central control processor that runs call processing software.

Table 2-1 Octel Overture 200/300 Subsystems

Subsystem Configurations	Part Number	Description
Works for Serenade Hard Disk Drive	740-6248-001	SCSI hard disk drive for storage of Works for Serenade programs and databases.
Works for Serenade Serial I/O Cable	520-6007-001	Cable connecting the EntryWorks ACP board to the Works for Serenade serial I/O panel.
Works for Serenade External Modem	SA10194-03	Dedicated external modem for remote access to the Works for Serenade subsystem.
Works for Serenade Modem Cable	SA10187-01	Cable between the Works for Serenade modem and the serial I/O panel.
Option Control Chip (OCC)	FK90087	Contains information about the software options the Octel Overture 200/300 is equipped with.

Table 2-2 Octel Overture 200 Subsystems

Subsystem Configurations	Part Number	Description
Motherboard (MB)	740-6503-001	Backplane board for interconnecting system modules and system power distribution.
Power Supply Units (PSU)		Power conversion from system input power to four regulated, d.c. voltages. The load/backup device is part of the PSU.
90-132 VAC	740-6504-001	
180-260 VAC	740-6505-001	
42-60 VDC	740-6506-001	
Works for Serenade Serial I/O Panel	740-6037-002	Rear-mount RS-232C connector panel.
DC Inlet Box	740-6537-002	Inlet box for d.c. powered systems.
Fan Panel Assembly	740-6502-002	System cooling fans.
Air Filter	840-6507-001	Washable air filter.

Table 2-3 Octel Overture 300 Subsystems

Subsystem Configurations	Part Number	Description
Load/Backup Device, Floppy Disk Drive	740-6010-001	Removable media drive for system configuration backup, and software and prompt loading during an upgrade.
Motherboards (MB) Shelf A Shelf B Shelf C	740-6003-001 300-6006-001 300-6005-001	Backplane boards for interconnecting system modules and system power distribution.
Power Supply Unit (PSU) 90–132 Vac 180–260 Vac 42–60 Vdc	740-6016-001 740-6017-001 740-6027-001	Power conversion from system input power to six regulated d.c. voltages.
Fan Tray Assembly	740-6002-001	System cooling fans.
Air Filter	840-6013-001	Washable air filter.
Works for Serenade Serial I/O Panel	740-6043-002	Rear mount RS-232C connector panel.
DAC Power Supply Assembly	740-6050-001	Provides 48 Vdc to DAC I/O panel.
DAC I/O Panel	740-6051-002	Concentrates lines from up to four DAC boards into connector.

Line Interface Cards

Line interface cards (LIC) provide a computer-controlled interface to the PBX extensions. The different types of line cards used in the Octel Overture 200/300 configuration are as follows:

- LIC4
- LIC8
- DLC16
- ILC12

Each 4-, 8-, 12 or 16-port line card connects to PBX extensions through a 25-pair cable. The 4-port and 8-port LICs are based on the original D.I.A.L. software technology. The DLC16 and ILC12 cards are based on the digital signal processing (DSP) technology to interface with analog ports.

The LIC4, LIC8, and DLC16 are FCC part 68 registered. The LIC4, LIC8, DLC16, and ILC12 are BABT-approved for use in the United Kingdom.

Each LIC contains the necessary circuitry for ring detection, dial tone detection, and signal power measurement, allowing automatic gain control from 0 dB to 24 dB of gain for recording messages. The LIC contains a yellow LED for each port, which indicates port activity.

In the Octel Overture 200, line cards can occupy slots A1 through A6.

In the Octel Overture 300, line cards can occupy slots A1 through A11.

Telemarketing Line Card (TLC)

The telemarketing line card is an 8-port line card. It differs from the LIC, because only the first port of the TLC located in slot A1 can be used for recording. The seven remaining ports of the TLC in slot one are play-only ports. All other TLC ports in the message server are play-only ports. When recording is attempted on other ports, the Octel Overture 200/300 prompts *“Messages may not be recorded at this time. No storage is available.”*

The first TLC must be installed in slot A1. Standard line cards can be installed in slots beyond the TLC cards. The TLC is FCC part 68 registered.

In the Octel Overture 200, the TLC can occupy slots A1 through A6.

In the Octel Overture 300, the TLC can occupy slots A1 through A11.

Direct Access Card (DAC)

The direct access card (DAC) is an optional, 4-port interface card. When used in place of the standard LIC, the DAC allows the direct connection of incoming DID or outgoing PBX trunks. The DAC requires an external -48-Vdc PSU and a rear-mounted DID I/O panel.

In the Octel Overture 200, the DAC can occupy slots A1 through A6.

In the Octel Overture 300, the DAC can occupy slots A1 through A11.

EntryWorks ACP Card

The EntryWorks ACP card is the application control processor for the Works for Serenade flow control language. It includes the host interface and the ACP SCSI disk drive control.

In the Octel Overture 200, the EntryWorks ACP must occupy slot A7.

In the Octel Overture 300, the EntryWorks ACP must occupy slot A12.

EntryWorks also requires the following:

- EntryWorks disk drive
- EntryWorks serial I/O panel and cable
- EntryWorks external modem and cable

Fax Application Processor

The fax application processor is a fax card that transmits and receives fax messages for the Fax Mail Plus feature. The fax processor contains one or two 4-channel fax daughter boards and supports up to eight simultaneous fax transactions when both daughter boards are installed. It supports communication with CCITT Group 3 fax machines. The fax channels operate at transmission rates up to 9600 baud.

In the Octel Overture 200, the fax card can occupy slots A1 through A7. The total number of fax channels cannot exceed the number of voice ports.

In the Octel Overture 300, the fax card can occupy slots A1 through A12. The total number of fax channels cannot exceed the number of voice ports.

LAN Card

The LAN card is required for both Remote and Domain Digital Networking, the LAN Backup and Restore feature, and Gateway Link applications. The card interfaces with the Octel Overture 200/300 by means of a 10BaseT Ethernet interface.

In the Octel Overture 200, the LAN card can occupy slots A5 through A7.

In the Octel Overture 300, the LAN card can occupy slots A10 through A12.

Integration Cards

Integration cards are used with certain PBX integrations that utilize proprietary digital links. Four types of integration cards are available:

- AT&T (ATTIC), ROLM (RIC), Northern Telecom SL-1 (SLIC) integration card. Each integration card is divided into two integration units; each integration unit supports two integration links.
- PIC integration cards with COD ports
- MIC integration cards
- SIC8 integration cards

In the Octel Overture 200, integration cards can occupy slots A1–A6.

In the Octel Overture 300, most integration cards can occupy slots A1–A11.

AT&T Integration Card (ATTIC)

The AT&T Integration Card (ATTIC) is used with AT&T System 75, System 85, and Definity integrations. Refer to the *Integration* volume, AT&T System Adaptive Integration.

ROLM Integration Card (RIC)

The ROLM Integration Card (RIC) is used with ROLM integrations. Refer to the *Integration* volume, ROLM Adaptive Integration chapter.

Northern Telecom SL-1 Integration Card (SLIC)

The Northern Telecom SL-1 Integration Card (SLIC) is used with Northern Telecom SL-1 and Meridian 1 integrations. Refer to the *Integration* volume, SL-1 Adaptive Integration chapter.

PIC Integration Card for AT&T (APIC)

The APIC Integration Card is used with AT&T System 75, System 85, and Definity PBX integrations. With APIC, the integration and line card functionality are combined on each port. The APIC card is a 12-port COD card. The ports can be purchased in increments. Refer to the *Integration* volume, AT&T System Adaptive Integration With APIC chapter.

PIC Integration Card for Northern Telecom (NPIC)

The NPIC Integration Card is used with Northern Telecom Meridian 1 or Meridian SL-1 PBX integrations. With NPIC, the integration and line card functionality are combined on each port. The NPIC card is a 16-port COD card. The ports can be purchased in increments. Refer to the *Integration* volume, Northern Telecom Adaptive Integration With NPIC chapter.

Mitel Integration Card (MIC)

The Mitel Integration Card (MIC) is used with Mitel SX-200 Digital, SX-100/SX-200 Analog and SX-2000 S and SG integrations. Refer to the *Integration* volume, Mitel Adaptive Integration chapter.

Serial Integration Card for the Meridian 1 (SIC8)

The Serial Integration Card (SIC8) is used with Northern Telecom Meridian 1 PBX integrations. Refer to the *Integration* volume, Meridian 1 Adaptive Integration chapter.

Voice Control Unit (VCU)

The Voice Control Unit (VCU) manages the system/voice and voice disk drives. The VCU is responsible for manipulating and controlling all voice data files. It controls the loopstart line interface cards and preprocesses events from the LICs before passing the events to the CPU.

On the Octel Overture 200, the VCU is located in slot A8 and manages the system/voice and voice disk drives in slots B2, B3, and B4.

On the Octel Overture 300, the VCU is located in slot A14 and manages the system/voice and voice disk drives in slots B3, B4, and C1-C4.

Central Processing Unit (CPU)

The central processing unit (CPU) is the master control unit for the Octel Overture 200/300. The CPU controls the VCU and the optional integration cards. The CPU contains four serial I/O ports.

The first serial port is shared between the internal modem and the system terminal port, which is accessed at the rear connector J1 or the front connector SP1. As a modem port, the first serial port can be connected to any telephone port under system software control. The internal modem is a Bell 103A-compatible (300 baud)/Bell 212A and CCITT V.22-compatible (1200 baud)/CCITT V.22 bis-compatible (2400 baud) modem and RS-232C serial connection.

The second port can either communicate with the optional DID/E&M Trunk Interface via an RS-232C cable or be used for RS-232C adaptive integration for message waiting and passing call information from some PBXs. Refer to the *Integration* volume, Adaptive Integration chapter.

On the Octel Overture 200, the CPU is located in slot A9. The CPU provides relay closure contacts for major and minor alarms on J3.

On the Octel Overture 300, the third and fourth ports, accessed through J3 and J4, are reserved for future use. The CPU provides relay closure contacts for major and minor alarms on J5.

The CPU also contains the following:

- On the Octel Overture 200, a floppy disk controller controls the floppy disk residing in the PSU.
- On the Octel Overture 300, a floppy disk controller controls the floppy disk residing in slot B5.
- The message-server time-of-day clock is backed up by battery. The battery can keep the clock running for up to 1 week if the power fails.
- The message-server TDM crosspoint switch controls the TDM bus.
- An Analog-to-digital converter (A to D) monitors message-server voltages and temperature.

Power Supply Unit (PSU)

The power supply unit (PSU) is a plug-in unit with three nominal input voltages available for the PSU:

90–132 Vac (110 Vac nominal)
180–260 Vac (230 Vac nominal)
42–60 Vdc (–48 Vdc nominal)

A PSU with the correct input voltage must be used. Do not install or remove the PSU with the circuit breaker in the ON position.

On the Octel Overture 200, the PSU is located in slot A10. The message server input voltage is displayed near the power cord socket at the rear of the cabinet and on the PSU.

On the Octel Overture 300, the PSU is located in slot A15. The message server input voltage is displayed on the power line filter at the rear of the cabinet.

For the Octel Overture 300, refer to the Installation chapter, Installation Requirements section, for instructions to install an Octel Overture 300 powered by a –48-Vdc PSU. Refer to the Hardware Replacement, Power Supply Unit section, in this manual for instructions about removing and installing a PSU.

The PSU provides regulated d.c. voltages. The voltages are shown in Table 2-4.

Table 2-4 Power Supply Unit d.c. Voltages

Name	Nominal d.c. Voltage	Function
+5 V	5 volts	Digital logic power
+5 VC	5 volts	Analog circuit power
+12 VM	12 volts	Fan and disk drive motor power
+12 VC	12 volts	Analog circuit power
-12 VC	-12 volts	Analog circuit power
-5 VC	-5 volts	Analog circuit power

The PSU provides the system power fail signal. This signal is activated if the message-server input voltage drops out of operational range. The power fail signal interrupts the CPU as a warning of loss of primary power, allowing controlled shutdown of the Octel Overture 200/300.

On the Octel Overture 200, the PSU provides a protective fuse for primary power production. This fuse is opened when a primary overcurrent occurs. The PSU contains a spare fuse.

On the Octel Overture 200, the +5-volt PSU is sensed at the center of the motherboard. Each regulated voltage of the PSU includes overvoltage and overcurrent protection. The PSU also includes overtemperature protection.

On the Octel Overture 300, the PSU provides the message server reset signal. This signal is activated at power up and resets all boards in the message server. The PSU provides a protective circuit breaker for primary power. This circuit breaker also acts as the message server power switch. The circuit breaker is tripped for primary overcurrent, power supply overtemperature, and secondary overvoltage.

On the Octel Overture 300, the +5-volt PSU is sensed at the center of the shelf A motherboard. The +12-volt fan and drive motor power is sensed at the SCSI motherboard B and SCSI motherboard C. Each regulated voltage of the PSU includes overvoltage and overcurrent. The PSU also includes overtemperature protection. In the case of an overtemperature occurrence, the circuit breaker opens.

Motherboard

The Octel Overture 200 has one motherboard. The Octel Overture 300 has three motherboards, one each for shelves A, B, and C.

Octel Overture 200/300 Motherboard

The motherboard is installed in the rear of the cabinet and distributes d.c. power to the cards, disks, and fans.

The motherboard includes signal interconnections from slots A1 through A7 on shelf A to the rear connectors P1 through P7, respectively. These connectors are used for external circuit connections to cards installed in the respective slots. For example, a line card installed in slot A1 connects to tip-and-ring circuits of a telephone network through rear connector P1.

The motherboard includes signaling for two separate SCSI buses on shelf B: the system/voice SCSI bus and the Works for Serenade SCSI bus. The system/voice SCSI bus interconnects slots B2 through B4. The Works for Serenade SCSI bus connects to slot B1. The motherboard includes an ID signal field for each slot. This ID field is used by the plug-in disk assemblies for SCSI bus ID selection.

The message server motherboard provides the reset signal. This signal is activated when the power is turned on, which resets all boards in the message server.

Octel Overture 300 Motherboards

Shelf A Motherboard

The main motherboard is installed in shelf A and distributes d.c. power to shelf A cards.

The shelf A motherboard includes signal interconnections from slots A1 through A12 to connectors P1 through P12, respectively. These connectors are used for external circuit connections to cards installed in the respective slots. For example, a line card installed in slot A1 connects to tip-and-ring circuits of a telephone network through connector P1.

Shelf B Motherboard

The shelf B motherboard includes signaling for two separate SCSI buses: the system/voice SCSI bus and the Works for Serenade SCSI bus. The system/voice SCSI bus interconnects slots B3 through B5. The Works for Serenade SCSI bus interconnects slots B1 and B2. This motherboard distributes +5-volt and +12-volt power to slots B1 through B5. It includes an ID signal field for each slot. This ID field is used by the plug-in disk assemblies for SCSI bus ID selection.

Slot B5 is used for the load/backup device and includes SCSI bus signal connections and power connections. In the case of a floppy device installed in this slot, only power is provided from the motherboard to the floppy device. The floppy device does not use the SCSI connection.

The shelf B motherboard provides a +12-volt power connection to the fan tray.

Shelf C Motherboard

The shelf C motherboard provides a system/voice SCSI bus connection, power distribution, and ID signals to disk assemblies installed in slots C1 through C4.

Option Control Chip (OCC)

The Option Control Chip (OCC) is located on the motherboard, directly behind the PSU.

 For the Octel Overture 300, the OCC is on the shelf A motherboard.

The OCC contains information about the message-server configuration, the number of voice and fax mailboxes authorized, and the feature options the Octel Overture 200/300 is equipped with.

The OCC must always remain with the message server it was purchased for. If the motherboard must be replaced, the OCC must be transferred from the old motherboard to the replacement motherboard. Refer to the Hardware Replacement, Option Control Chip Replacement section, in this manual.

Works for Serenade Hard Disk

The EntryWorks hard disk is a SCSI-technology hard disk. It is used to store EntryWorks programs and databases.

In the Octel Overture 200, the EntryWorks hard disk occupies slot B1.

In the Octel Overture 300, the EntryWorks hard disk occupies slot B2.

Octel Overture 300 Load/Backup Device

The load/backup device is the floppy-disk drive, which permits online backup storage of critical message server configuration information and software. It also offers a rapid and reliable means of copying new software to the hard disk. The floppy-disk drive is also used to restore a message server to normal operation when replacing the hard disk.

The floppy-disk drive is connected to the CPU by a cable to the front of the CPU.

Hard Disk Drives

Disk assemblies are plug-in, random access, read/write magnetic hard-disk assemblies, requiring no adjustments or jumper configurations.

The Octel Overture 200/300 cabinet uses SCSI technology hard-disk drives that interface to a single SCSI bus. This bus is controlled by the VCU. Disk drives are used for two functions:

- System/Voice** disks store the operating message server programs, voice prompts, configuration information, and voice messages. A portion of a system/voice disk is reserved for system software, configuration data, and prompts. The remainder of the drive is used for voice message storage.
- Voice storage** disks store only voice messages.

Depending on capacity and redundancy requirements, each Octel Overture 200/300 contains one or more hard-disk drives.

- The Octel Overture 200 message servers can contain from one to three hard-disk drives in slots B2, B3, and B4.
- The Octel Overture 300 message servers can contain from one to six hard-disk drives in slots B3, B4, C1, C2, C3, and C4.

The first disk drive is always a system/voice disk. If a second disk is installed, it is also a system/voice disk. If additional disk drives are installed, they are voice disks **only**.

The maximum disk storage for an Octel Overture 200 message server is 540 hours of voice storage.

The maximum disk storage for an Octel Overture 300 message server is 1085 hours of voice storage.

Disk-storage space for recorded messages, names, greetings, redundancy and feature applications is purchased in 5-hour increments. Storage hours are upgraded by Octel Customer Administration.

Disk Redundancy

Hot Standby redundancy of all system software, configuration data, and prompts is automatically provided when a second system disk is installed. Hot Standby redundancy is not available when only one system disk is installed.

Optional software enhancements offer redundancy for names, greetings, and messages for any message server containing two or more disk drives. When Names and Greetings Redundancy and Message Redundancy are installed, names, greetings, and messages are made redundant in the following manner:

- In message servers containing two disk drives, the redundancy is on the second drive.
- In message servers containing more than two disk drives, the redundancy is on any drive, spread out over all equipped drives.

Refer to the *Feature Description* volume, Hard Disk Redundancy chapter.

3

PREPARING THE PHONE SYSTEM

Chapter Contents

3.1	How the Octel Overture 200/300 Works with the Phone System	3-1
	Interfaced Installations	3-1
	Integrated Installations	3-2
	Answering Incoming Calls	3-3
	Acting as a Message Center	3-4
	Using the DID/E&M Trunk Interface	3-4
3.2	Determining Necessary Changes	3-5
3.3	Changes to Central Office Trunking	3-6
	Additional Trunking	3-6
	Splitting Trunk Groups	3-6
	DID Trunks: Using the DID/E&M Trunk Interface	3-6
	Ordering PE Trunking Changes	3-7
3.4	Phone System Configuration	3-8
	Port Extensions	3-8
	Called Extensions	3-9
	Trunks	3-9
	Trunk Redirection	3-9
	Trunk Selection	3-10
	Ordering Phone System Changes	3-10
3.5	Implementing the Octel Overture 200/300 on PBXs without DIL Feature	3-12
	Upgrade the PBX to a Feature Package Offering the DIL Feature	3-13
	Use DID Numbers	3-13
	Place the Console in Night Mode	3-13
	Arrange for Trunks to Call Divert to the Octel Overture 200/300 Ports	3-13

Figures

3-1	Octel Overture 200/300 Connection to Phone System	3-1
3-2	All Incoming Lines Directed to the Octel Overture 200/300	3-3
3-3	Incoming Calls Split Between Console and the Octel Overture 200/300	3-3
3-4	Sample Agency Letter for PE Changes	3-7
3-5	Service Provider Letter	3-11
3-6	Directing Incoming Calls to the Octel Overture 200/300 When the PBX Does Not Offer a DIL Feature ..	3-12

Table

3-1	PBX Features to Direct Trunks to the Octel Overture 200/300	3-10
-----	---	------

3.1 HOW THE OCTEL OVERTURE 200/300 WORKS WITH THE PHONE SYSTEM

The Octel Overture™ 200/300 message servers work with PBXs, Centrex, most hybrids, and some key systems. The Octel Overture 200/300 is configured with its voice ports connected to the phone system as a series of DTMF touchtone single line analog extensions (touchtone sets). In the PBX, these extensions are programmed to receive an incoming call, to place outgoing calls (within the PBX for message waiting and also outside the PBX for offsite paging and alarm calls), to place calls on hold, transfer calls, and reconnect if the called party does not answer. This configuration is referred to as “behind the switch” because the ports are on the extension side, not the trunk side, as illustrated in Figure 3-1.

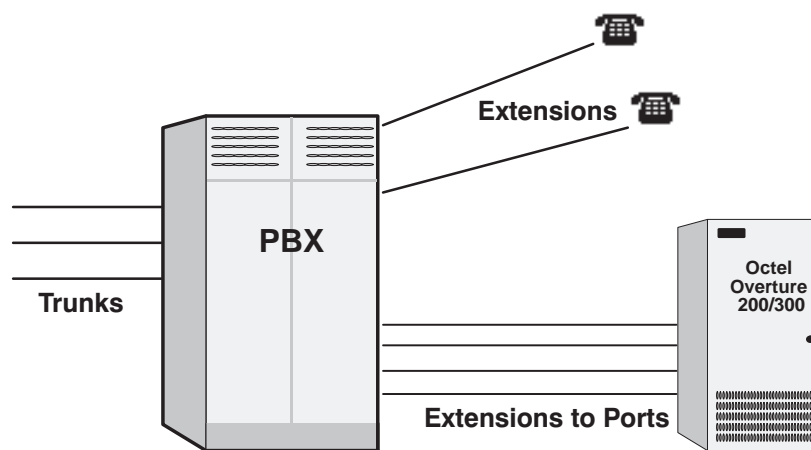

Figure 3-1 Octel Overture 200/300 Connection to Phone System

For convenience, this manual uses the terms “phone system” and “PBX” to refer to any telephone system that works with the Octel Overture 200/300.

This chapter discusses Octel Overture 200/300 connection to the phone system, the changes required, and how to order them. It assumes familiarity with some PBX concepts.

Changes need to be made to the phone system for Octel Overture 200/300 message servers. Some are changes to the PBX; others are done in the Public Exchange (PE). This may require lead time. Work with the client to determine who will make the changes and how long they will take. Prepare a schedule so that everyone knows who is doing what and the date each item is required.

Interfaced Installations

Each Octel Overture 200/300 port is connected to a touchtone single-line, touchtone PBX extension. A 25-pair cable connects the Octel Overture 200/300 line card to the PBX extension. A PBX extension connected to a Octel Overture 200/300 port is referred to as a port extension.

In order for the Octel Overture 200/300 to extend calls correctly, each port extension must be configured in the PBX to receive calls, place them on hold, initiate, transfer, and reconnect calls.

An Octel Overture 200/300 port is in use during the entire time it takes to answer a call, dial the extension the caller entered, and connect the caller to the requested extension. The port is then free to handle another call. When the called extension is busy or does not answer, the Octel Overture 200/300 port remains occupied while calling another extension or taking a message. An Octel Overture 200/300 port is in use when employees are listening to or sending messages.

Port extensions answering with the same company greeting and answering mode are placed in a hunting arrangement within the PBX. The hunt group may be circular or linear (terminal) according to the requirements of each particular PBX. This assures that callers are answered by the first available port.

The mode (AX, CX, or MX) of the port determines how calls are answered by the Octel Overture 200/300. Refer to the *Configuration* volume, Slots Table chapter.

Integrated Installations

Different methods are used to integrate a telephone system with the Octel Overture 200/300. In some cases, a combination of these methods may be used for full integration.

Integration is the ability of the telephone system to provide the Octel Overture 200/300 with information that identifies the extension number a call was intended for and, in some cases, the extension number from where the call originated.

In-band Integration

In-band integration is the ability of a telephone system to send DTMF tones that identify the extension number for a forwarded call to the port extension answering the call. In-band signalling may include the condition (busy, ring-no-answer, or direct) for the call. In certain installations, DTMF tones may be used to turn ON or OFF message waiting indicators to indicate when a mailbox has new messages.

RS-232C Integrations

RS-232C integrations include the Bell Operating Company's (BOC) Simplified Message Desk Interface (SMDI) and those that are similar to it. The SMDI or RS-232C interface provides the directory number, or PBX extension number of the called extension from which an incoming call was forwarded, to the message desk. If the call originated in the same PE or PBX, the directory number or extension number is sent to the message desk.

The condition or reason the call was forwarded to the message desk, as well as the port or member of the hunt group the call is being sent to, is included in the call record. Message waiting indication may be turned ON or OFF over RS-232C connections for most installations.

Octel Overture 200/300 Proprietary Card Integrations

Octel has developed proprietary line cards that function similarly to digital display telephones for several different PBXs. The Octel Overture 200/300 reads the proprietary line cards to determine the extension and the condition for the call, and then answers the call with the appropriate greeting or response.

Once the extension and condition for the forwarded call is known, an analog port answers the call and provides all remaining messaging functions. The proprietary line cards are used to turn ON or OFF message waiting indicators in most of the proprietary integrations.

Answering Incoming Calls

The Octel Overture 200/300 can answer all or a portion of a company's incoming calls. Through the PBX programming, trunks can be directed to the Octel Overture 200/300 hunt group instead of the operator through a PBX feature. This feature, often called DIL (Direct In Lines), allows trunks to be directed to a specific extension or hunt group instead of the console.

The PBX may be set up to direct all or only some incoming trunks to the Octel Overture 200/300. For example, the main company number may be answered by the attendant, while a second trunk group, with a different listed directory number, can be directed to the Octel Overture 200/300. Ports answering incoming calls are configured in AX mode.

Figure 3-2 is a block diagram of the Octel Overture 200/300 connected to the phone system where all incoming lines are directed to it. Arrows denote hunting.

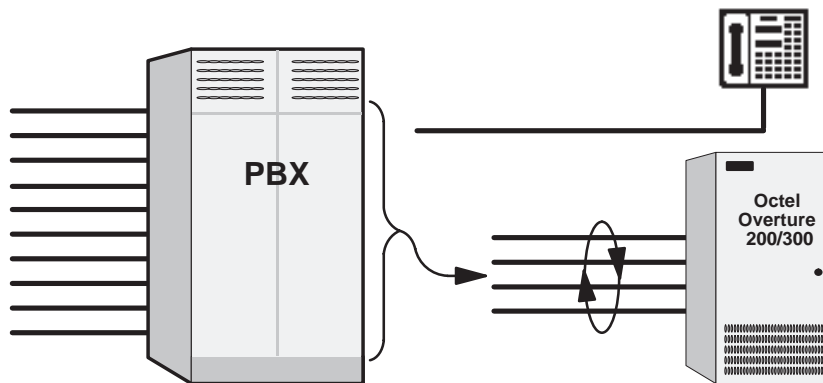

Figure 3-2 All Incoming Lines Directed to the Octel Overture 200/300

Figure 3-3 is a block diagram of the Octel Overture 200/300 connected to a phone system that has incoming lines split between the console and the Octel Overture 200/300. Arrows denote hunting.

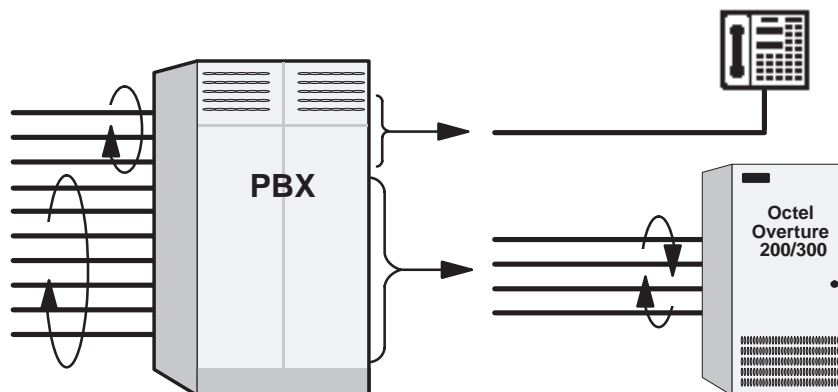

Figure 3-3 Incoming Calls Split Between Console and the Octel Overture 200/300

Acting as a Message Center

The Octel Overture 200/300 can also be set up to answer forwarded calls and act as a message center. For example, a company with a service providerCentrex service already has a means of getting calls directly to an extension. When the extension is busy or does not answer, the extension can be forwarded to an Octel Overture 200/300 hunt group to take a message. Ports receiving forwarded calls are configured in CX mode. The Octel Overture 200/300 does not attempt to call the extension number entered by the caller but immediately goes to that extension's mailbox and offers to take a message.

The attendant may also extend callers to a port to allow them to leave a voice message. This port is configured as MX mode. As with CX mode, it does not call the extension number entered but goes to that extension's mailbox and offers to take a message.

Using the DID/E&M Trunk Interface

DID and E&M trunks are wired through the DID/E&M Trunk Interface so that it can monitor the progress of those calls. If appropriate, the interface diverts the call to the Octel Overture 200/300 for call coverage. The DID/E&M Trunk Interface and the Octel Overture 200/300 communicate via an RS-232C serial link. Ports receiving calls from the DID/E&M Trunk Interface can be in any mode. The Octel Overture 200/300 handles the call based upon information sent by the DID/E&M Trunk Interface module. Refer to the *DID/E&M Trunk Interface Installation and Maintenance* manual for more information about how the DID/E&M Trunk Interface works.

3.2 DETERMINING NECESSARY CHANGES

Octel suggests that you perform a survey of the existing phone system during the initial phase of the implementation process. From the descriptions of the application(s), decisions are made about how the Octel Overture 200/300 should be used. Refer to the *Product Description* volume, Implementation chapter, for a list of questions to ask during the survey.

Use the results of the survey and the type of application to determine the necessary changes. Schedule and track these changes using the checklist found in the Installation chapter, Testing the Installation and Telephone Changes section.

For convenience, Public Exchange (PE) trunk changes are separate from PBX changes. The following sections discuss changes that may be required and guidelines for ordering the changes for both PE trunking and the PBX.

3.3 CHANGES TO CENTRAL OFFICE TRUNKING

Public Exchange (PE) changes may be needed to

- Add trunking capability.
- Change the order of trunk hunting.
- Create new trunk hunting groups.
- Add, change, or delete 800 services.
- Add, change, or delete DID or Centrex services.
- Split the hunt group (directory listed number), allowing some trunks to be directed to the console and some to Octel Overture 200/300.

Additional Trunking

The specific number of PBX lines and trunks depends on the number of ports and the desired trunking arrangement.

Although the Octel Overture 200/300 port drops off after it transfers a call, the PE trunk is still occupied during the entire call. When you decide how many trunks to direct to the Octel Overture 200/300, remember each trunk is occupied from the time the call is placed until the caller hangs up. As a result, the Octel Overture 200/300 can answer incoming calls from more trunks than it has ports.

Determine how many trunks to direct to the Octel Overture 200/300 by using PBX traffic data and the traffic engineering tables. The tables are designed to help decide how to use the Octel Overture 200/300 most effectively for a given situation. After collecting the traffic data, it may be necessary to order changes from the telephone company to add or alter the number of trunks.

Splitting Trunk Groups

If one two-way trunk group will be separated into two or more groups, the rotary hunting of the trunks must be changed.

The Octel Overture 200/300 handles only incoming calls. If the trunks that the Octel Overture 200/300 answers are two-way trunks (also used for outgoing calls), make sure that sufficient trunks are available for both incoming and outgoing calls. Additional trunks or changes to the type of trunks may be advisable. For information on Direct Access Cards, refer to the *Direct Access Card (DAC) Reference Manual*.

DID Trunks: Using the DID/E&M Trunk Interface

The DID/E&M Trunk Interface monitors and intercepts DID/E&M calls. These trunks **do not** get directed, via the DIL feature, to the Octel Overture 200/300 hunt group.

DID/E&M trunks using the DID/E&M Trunk Interface must be rewired to route through the DID/E&M Trunk Interface module. Coordinate the installation with PE personnel to prevent the PE from busying out the trunks. No changes are necessary to the DID trunk equipment or DID programming in the PBX. Refer to the *DID/E&M Trunk Interface Installation and Maintenance* manual for more detailed information.

Ordering PE Trunking Changes

Contact the customer about making arrangements for changes in trunking. Typically, these changes require significant lead time. The PE requires an agency letter from the customer authorizing you to act on their behalf.

Figure 3-4 is a sample agency letter you may want to use.

DATE:

TO: All concerned operating telephone companies and other
common carriers

ATTENTION: Supervisor

On this date we have entered into a contractual agreement with **(the Octel Overture 200/300 supplier)** to be our communications representative relating to all voice grade telecommunication needs. This agreement is for an indefinite period.

(The Octel Overture 200/300 supplier) may order connection and disconnection of telephone-company provided services and equipment. We hereby acknowledge that **(the Octel Overture 200/300 supplier)** may obligate us for installation and other charges that may appear on our telephone bill.

This authorization does not preclude our ability to act on our own behalf as necessary.

Please contact **(contact name)** of **(the Octel Overture 200/300 supplier)** at **(address, phone number, and extension)** if you have any questions.

(Customer's Name)
(TITLE)
(COMPANY)

Figure 3-4 Sample Agency Letter for PE Changes

3.4 PHONE SYSTEM CONFIGURATION

Changes may be required to the following:

- The Octel Overture 200/300 port extensions
- Called extensions
- Trunks
 - Redirection
 - Selection

Additional equipment may be required before these changes can be made. Most changes are to the PBX database.

Port Extensions

Connect and configure the port extensions using the following steps:

1. Designate one touchtone, single-line, touchtone extension for each Octel Overture 200/300 port. Additional PBX line circuits may be required.
2. Terminate each of these extensions to a 66M connector block, or equivalent. Clearly mark each termination point with the extension number.
3. Assign a PBX class of service to these extensions permitting them to
 - Initiate calls
 - Receive (incoming) calls
 - Place calls on hold
 - Transfer calls
 - Forward calls
4. Remove any type of call waiting features from the Octel Overture 200/300 port extensions.

 If configuring ports for outcalling to network locations for off-site message notification or for off-site alarm calls, make sure the port extensions are **not restricted** from making calls to these locations (e.g., toll restriction).

System speed dial commonly can override toll restriction. For security reasons, it may be desirable to toll restrict the Octel Overture 200/300 ports to local calls and have the ports use the PBX system speed dial for long distance outcalls.

5. Set up a hunt group for each group of port extensions configured to answer in the same way (company greeting, intercept position, mode). Where possible, make these circular hunt groups.

 In cases where the PBX queues calls to a busy hunt group and no overflow position can be defined, you may want to set up a “terminal” hunt group with the attendant, if possible, or other PBX intercept position as the last member of the hunt. When all the ports are busy, calls hunt to this last member of the group for answer.

6. Record the pilot number for each hunt group. Depending on the PBX type, the pilot number may be either
 - A phantom number with no actual extension appearance
 - The first extension of the hunt group
7. Make the hunt group number easy to enter and easy to remember, since employees use this number to access the Octel Overture 200/300. Some phone systems permit single-digit access to hunt groups. For example, employees need only press **5** to reach the Octel Overture 200/300.
8. Determine how to set up a fail-safe answering position based upon features available for the PBX type. This may be either programmed in the PBX as an overflow situation or by call forwarding the hunt group pilot or member extensions. If none of these are permitted, refer to item 5 (above).

 When the DID/E&M Trunk Interface sends calls to the Octel Overture 200/300 hunt group, this group should not forward when busy. The DID/E&M Trunk Interface directs the calls to the Octel Overture 200/300. If the DID/E&M Trunk Interface receives a busy signal from the Octel Overture 200/300, it redirects the call to the extension configured as the attendant. If the group should overflow for non-DID/E&M Trunk Interface calls, this may require two hunt groups with the same members, one of which overflows and another that does not. (Setting up two hunt groups with the same members is not possible on all PBXs.)

Called Extensions

Because the Octel Overture 200/300 provides call coverage for busy extensions, any type of call waiting* feature provided by the PBX is not required. Remove this feature from the PBX configuration for extensions called through the Octel Overture 200/300. PBX call waiting can mislead the second caller, who hears that the extension doesn't answer instead of hearing the true busy status.

Remove any system call forwarding for call coverage (to a message center, etc.).

Trunks

Possible changes to the PBX trunk programming include redirecting trunks to the Octel Overture 200/300 and assuring any trunking changes do not affect the selection of trunks for outgoing calls. No changes need to be made to the DID trunking or programming in the PBX.

Trunk Redirection

Trunks are directed to the Octel Overture 200/300 via a PBX feature. Many PBX manufacturers call this feature DIL, Direct In Lines, or DIT, Direct In Trunks. Table 3-1 lists several PBX manufacturers and the name of that feature for their phone systems. If the phone system does not provide a DIL-type feature, refer to the Implementing PBXs Without DIL Feature section in this chapter.

* When a busy extension receives a second call, notification of the second call is given by a tone that indicates a call is waiting. The busy extension may ignore the tone or place the first call on hold to answer the second. The notification tone is only heard by the called person and the caller hears ringing instead of a busy tone.

Table 3-1 PBX Features to Direct Trunks to the Octel Overture 200/300

PBX Manufacturer and Model	Name of Feature
AT&T	
All but Horizon and AT&T System 25	DDC (Direct Department Calling)
Horizon and AT&T System 25	DGC (Direct Group Calling)
ROLM	DEDICATED
FUJITSU/American Telecom Focus	QUASI-DID
NORTHERN TELECOM SL-1	AUTO-TERMINATE

If the phone system you are working with is not mentioned here, and you are trying to determine the appropriate feature, first look for DIL, the most commonly used name.

If you can talk with someone familiar with the phone system, describe the feature (i.e., “ability to direct a trunk or group of trunks to a specific extension or hunt group rather than being directed to an attendant console for answer”). They should be able to supply the name of the feature for that phone system.

The DID/E&M Trunk Interface unit monitors and intercepts DID calls. Consequently, these trunks are **not** directed by the DIL feature to the hunt group.

Trunk Selection

With some phone systems, incoming calls hunt from the beginning of a trunk group (trunk 1, trunk 2,...) for an available trunk, while outgoing calls hunt in reverse order (trunk 10, trunk 9, ...). Others specify the first and second preference trunk groups for both incoming and outgoing calls. If a large two way trunk group is to be split, reexamine the PBX programming for outgoing trunk selection and determine the trunk group to use for outgoing calls.

Ordering Phone System Changes

If your company is not the PBX provider, order changes from the PBX vendor on behalf of the customer. Provide a Service Provider Letter (Figure 3-5) to the PBX vendor indicating the changes needed to the PBX for the Octel Overture 200/300, and schedule the changes. If possible, try to use that PBX’s terminology when requesting these changes. You may also want to provide them with information from this chapter. Review the previous sections of this chapter for information to fill in the blanks. Read over the letter and in particular, the footnotes. Depending upon the application, portions of the letter may need to be expanded upon or deleted.

The vendor may require your Overture 200/300 registration information:

FCC Registration	0.7A
Ringer Equivalence	25-pair cable
PBX Interface	meets FCC Part 68
Line card	meets FCC Part 15, Class A
The unit	UL1459
UL Registration	

Dear **(PBX-Vendor Name)**:

This letter confirms the service order and tentative installation of the Overture 200/300 for our mutual customer, **(company name)**.

The following items are pertinent to this order:

1. Extension changes. These changes need to be completed by **(date)**. The **(manufacturer/model type switch)** is to be configured as follows:
 - a. Terminate **(number)** single-line extension on **(number)** in the telephone equipment room. Be sure the customer has enough spare ports on extension card(s) to support these. Please label these jacks with the assigned extension numbers.
 - b. The single-line extensions are to have the following class of service features:
 - Extensions must be able to initiate, receive, transfer, and forward calls.
 - No call waiting features associated with any extensions.
 - No toll restrictions on **(all/specified)** extensions.
 - c. The single-line extensions should be placed in a circular hunt group. Please make the pilot number easy to enter and remember.
 - d. In the event all members of the hunt group are busy, subsequent calls should be forwarded to **(PBX console attendant/defined extension)**. Define the last hunt number as an overflow extension.
1. Trunk redirection. The following (or attached) list of trunks needs to be directed via the **(name of DIL feature)** of the **(manufacturer name)** PBX to the hunt group pilot number.

<p>Where multiple trunk groups exist, specify the trunks for each hunt group:</p> <p>For example: Hunt group #1</p> <p>Hunt group #2</p>	<p>Trunks: 555-3700 555-3701 555-3702 555-3703 1-800-337-1100 1-800-337-1101</p>
--	--

Cut-over of these trunks to the Overture 200/300 is scheduled to begin (time am/pm) on (date). Any programming of the **(name of the DIL feature)** must be ready by then.

Thank you for your cooperation. If you have any questions, please feel free to call me at **(phone number and extension)**.

Sincerely,

(NAME)
(TITLE)

Tailor this section to the customer's needs. If trunk cut-over is staggered, include schedule in this letter. If a PBX representative needs to be on-site for this cut-over, arrange a mutually convenient time with the PBX vendor.

Or other location where the unit is to be placed. Refer also to the environmental requirements in INSTALLATION, Installation Requirements in this manual.

*If more than one hunt group is required, specify the number of extensions for each hunt group.
For example:
hunt group #1 = 6 extensions
hunt group #2 = 2 extensions.*

This information may not be available for all PBXs. If you want this call forwarding, however, be sure to include the number if it's available.

Figure 3-5 Service Provider Letter

3.5 IMPLEMENTING THE OCTEL OVERTURE 200/300 ON PBXS WITHOUT DIL FEATURE

You may encounter a PBX with an older feature package that does not provide the DIL feature. The PBXs most frequently encountered without DIL are AT&T Dimension PBXs with Feature Packages (FP) 2, 3, 4, 5, and 7.

 This feature on the Dimension is called DDC for Direct Department Calling. It is only available in FP 8, 10, 12, and 15.

If the customer's Dimension does not have FP8 or later or it is a phone system that does not have a DIL feature, there are several alternatives for directing trunks to the Octel Overture 200/300 ports for answer:

- Upgrade the PBX to a feature package offering the DIL feature
- Use DID numbers
- Place the console in night mode
- Use call diverters to switch calls to the Octel Overture 200/300 ports

Not all these alternatives may be feasible for a given situation. The following discusses each in detail.

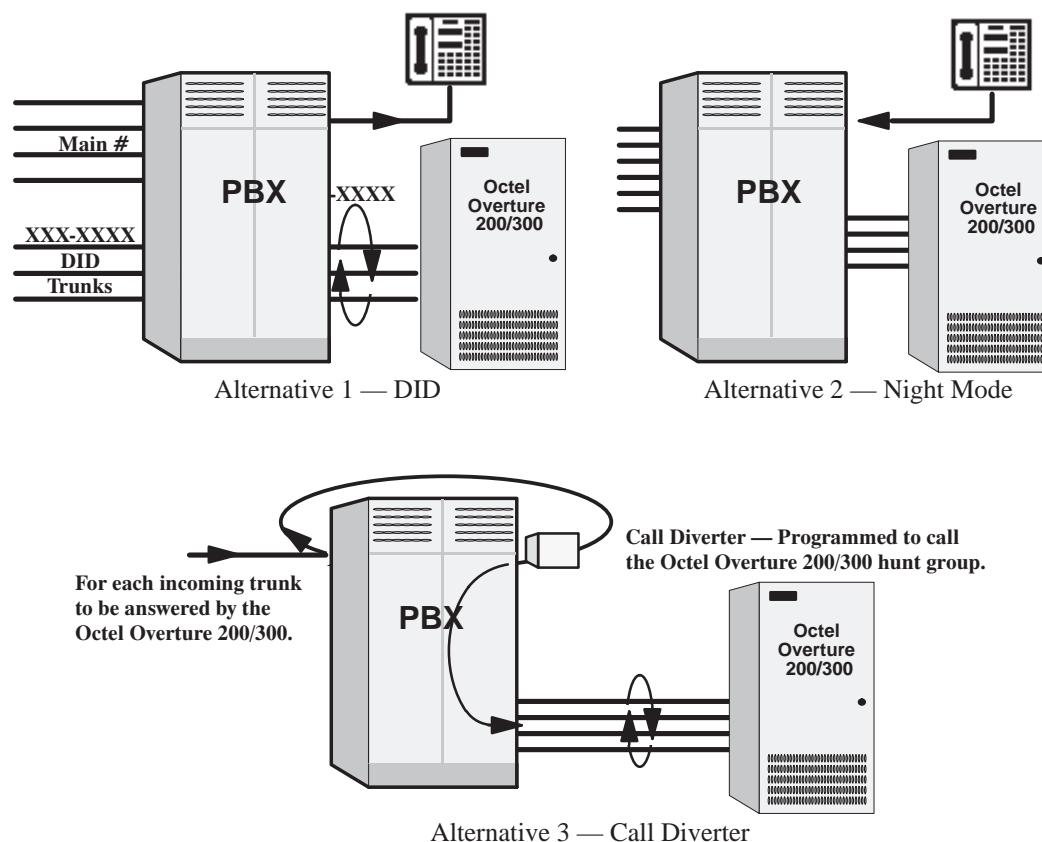

Figure 3-6 Directing Incoming Calls to the Octel Overture 200/300 When the PBX Does Not Offer a DIL Feature

Upgrade the PBX to a Feature Package Offering the DIL Feature

Depending on the customer's current version, this may not be economically feasible. This is the most straightforward solution, but possibly not the most practical.

Use DID Numbers

Some customers may already have a block of DID numbers but do not wish to pay for DID numbers and trunks for all employees. Callers may be given a number that is a DID extension answered by the Octel Overture 200/300. This is especially suitable where a second number (not the main company number) is to be established for company employees, friends, family, and frequent callers to call to reach extensions or receive information. Refer to Figure 3-6.

Again, in this way the Octel Overture 200/300 can answer a DID number. However, 800 service or main company numbers cannot be answered this way. Due to the cost of installing DID, this may only be attractive to companies that already have DID.

Place the Console in Night Mode

If the PBX does not have the DIL feature, placing the console in night mode usually may be used to direct **all** incoming trunks to a certain extension (such as the Octel Overture 200/300 hunt group). Refer to Figure 3-6. However, once the console has been placed in night mode, it may not be used. Callers requiring assistance (through the Octel Overture 200/300) to a multibutton key set for answering. This solution is most practical for

- Smaller companies having a single console and willing to direct all trunks to the Octel Overture 200/300.
- Companies using only Octel Overture 200/300 to answer after hours and on weekends.

Since the console cannot be used, callers who are toll restricted cannot get an outside line from the operator.

Arrange for Trunks to Call Divert to the Octel Overture 200/300 Ports

When only some trunks are to be answered by the Octel Overture 200/300 (ruling out console Night Mode), these trunks can be removed from the PBX and terminated on call diverters that are connected to PBX extensions. Refer to Figure 3-6. These call diverters are programmed to call the Octel Overture 200/300 hunt group. The call diverter answers the trunk and calls (through the PBX) the hunt group number. The appropriate number of ports, as well as one additional extension per trunk to be diverted to the Octel Overture 200/300, are required.

The call diverter that operates satisfactorily in this situation is the BUSCOM 2008-RD manufactured by MetroTel. Because this diverter ordinarily allows remote turn-off by pressing a **#** key, it requires a modification.

4

INSTALLATION

Chapter Contents

4.1	Receiving the Equipment	4-1
	Inspecting for Shipping Damage	4-1
	Unpacking the Cabinet	4-1
	Reshipping	4-2
	Moving the Equipment On-Site	4-3
4.2	Installation Requirements	4-4
	Site Requirements	4-4
	Power Requirements	4-4
	Isolation Transformer	4-9
	Uninterruptible Power Supply	4-10
	Installing the Octel Overture 200/300 With –48-Vdc Power Supply Unit	4-10
	Cabinet Requirements	4-14
	Distributor-Supplied Equipment	4-14
4.3	PBX Preparation	4-15
4.4	Terminal Communications	4-16
	Terminal/Teleprinter Installation	4-16
	Compatible Terminals	4-16
	Cable Connections Between the RS-232C Terminal and the Octel Overture 200/300	4-16
	Connections Between an External Modem and the Octel Overture 200/300	4-17
	Connecting to the Internal Modem	4-19
4.5	Pin Assignments for Message Server Cards and Ports	4-21
	Four-Port Line-Interface Card, ROLM Integration Card, and Mitel Integration Card	4-22
	Eight-Port Line-Interface Card and Telemarketing Line Card	4-23
	16-Port Line-Interface Card (DLC16) and the PBX Integration Cards for	
	Northern Telecom (NPIC)	4-24
	12-Port International Line-Interface Card	4-25
	DTIC Pin Assignment	4-26
	Northern Telecom SL-1 Integration Card	4-27
	AT&T Integration Card (ATTIC)	4-28
	Serial Integration Card for the Meridian 1 (SIC8)	4-29
	APIC Integration Card	4-30
	SIC8 I/O Panel Pinouts	4-31
	Direct-Access Card (DAC)	4-32
	Direct-Access Card I/O Panel DP EXT Connector	4-33
	Direct-Access Card I/O Panel Power Connector	4-33
	External Alarm Port	4-34
4.6	Communicating with the Message server	4-35
	Local Access	4-35
	Remote Access	4-36
	Automatic Terminal Logout	4-36

4

INSTALLATION

Chapter Contents (continued)

4.7	Octel Overture 200/300 Hardware Installation	4-37
	Powering Up	4-37
	Measuring d.c. Voltages	4-37
	Connecting the Terminal	4-38
	Starting Up the System	4-38
4.8	Rack Mount Installation, Octel Overture 300	4-40
	Preinstallation	4-41
	Installation	4-41
	Removal	4-42
4.9	Software Installation	4-44
	Using INSTALL — Entering the Configuration Database	4-44
	Using UPDATE	4-44
4.10	Connecting the Phone System to the Octel Overture 200/300	4-45
	Connection Overview	4-45
	Verifying the Equipment	4-45
	Connector Blocks	4-46
	Wiring	4-47
4.11	Octel Overture 200/300 Testing	4-50
4.12	Testing the Installation and Telephone Changes	4-58

4

INSTALLATION

Figures

4-1	Octel Overture 200 Floor Plan for Installation in the US, Canada and Mexico	4-6
4-2	Octel Overture 300 Floor Plan for Installation for the US, Canada, and Mexico	4-7
4-3	Octel Overture 200 Direct-Connect Installation	4-12
4-4	Octel Overture 300 Direct-Connect Installation	4-13
4-5	Diagram of the Field Wiring for –48-Vdc Powered Octel Overture 200	4-14
4-6	First and Second RS-232C Serial-Port Cable Pinouts for Connection to Terminal Equipment (DTE)	4-17
4-7	Octel Overture 200/300 to External Modem Pinouts	4-18
4-8	50-Pin Male Telco Connector Pinouts	4-21
4-9	Octel Overture 200/300 Cabinet Installed in 19-Inch Rack	4-40
4-10	Typical Octel Overture 200/300 Connections	4-45
4-11	Connector Block	4-47
4-12	Example of Server-to-Block Connections	4-48

Tables

4-1	Input Circuit Current at Nominal Operating Line Voltage	4-5
4-2	Input Power Requirements	4-9
4-3	Equipment Provided by Distributor	4-14
4-4	DCE Pinouts for Cable Connections Between the RS-232C Terminal and the Octel Overture 200/300	4-17
4-5	Pinouts for External Modem Connections	4-18
4-6	Power Supply Output Rating and Acceptable Operating Ranges	4-38
4-7	66M4-4W Connector Block Designators	4-49

4.1 RECEIVING THE EQUIPMENT

The following paragraphs provide procedures for unpacking, inspecting, inventorying, and reshipping the Octel Overture™ 200/300.

The server is shipped in the customer-ordered configuration. All PCAs, power supplies, and disk drives are installed in the cabinet. Depending on the options ordered with the server (such as Works for Serenade or DAC), some additional assembly of the server might be required. Refer to specific sections in this chapter about any options for assembly instructions. Each server is shipped on a pallet, protected by foam inserts, and covered by a cardboard box.

Weights at maximum configurations are as follows:

- ❑ 120 pounds (54 kg) for the Octel Overture 200
- ❑ 200 pounds (90 kg) for the Octel Overture 300

Inspecting for Shipping Damage

Before accepting delivery of an Octel Overture 200/300 from the carrier, inspect the tilt-watch indicators, located on the left front center and the right side center of the carton. Also inspect the cardboard carton. If the tilt-watch is tripped or the carton has external damage, notify the carrier immediately, and submit a damage report to the carrier and to Octel Communications. In the event of equipment damage, negotiate claims directly with the carrier.

Unpacking the Cabinet

Do not take the server off the shipping pallet unless the unpacking is being done at the installation site.



Make sure that you have at least two people to remove the server from the pallet. Because of the weight of the server, it could be damaged or a person could be injured.

1. Remove the plastic clips securing the cardboard carton to the shipping pallet. Squeeze the center of the clip, lift it, and pull it away from the carton.
2. Remove the cardboard carton by lifting it straight up.
3. Remove the foam insert from the top of the server.
4. Remove the bag from the top of the server. The bag contains the front-door key, power cord, and message-server documents.
5. Inspect the server visually for physical damage.
6. Use a 7/16 inch wrench to remove the four brackets that secure the server to the pallet. The brackets are located at the base of the server.

7. Unlock and open the front door. It is recommended that the front door be removed before moving the cabinet from the pallet.
8. Lift the cabinet straight up, until the stabilizer legs have cleared the server. Lift the server off the pallet toward the pallet opening at the front of the server.
9. Place the server in its permanent location.
10. Replace the front door.
11. When the Octel Overture 200/300 is installed, adjust the levelers until the top of the server is level and does not wobble. No special tools are required to adjust the leveling, although a bubble level is recommended for this purpose.
12. Collect and save all packing material, cartons, foam inserts, shipping pallet, etc., as they can be reused to ship the server back to Octel if any shipping damage was incurred.

Reshipping

If the Octel Overture 200/300 is to be reshipped from your location, use the original shipping carton, and perform the following:

1. Verify that all server assemblies are secure.
 - a. All boards must be seated and secured with locking ejectors.
 - b. All captive fasteners on the disk drive, power supply, and fan assemblies must be secured to the cabinet with a flat-blade screwdriver.
2. Remove cabinet front door by opening the door and pulling it straight up, until it is free of the two hinges.
3. Remove the front pallet section and place the server on the shipping pallet. This **must** be performed by two people.
4. Replace and lock the front door.
5. Resecure the front pallet section against the front door, using two pallet bolts.
6. Replace the plastic bag over the cabinet.
7. Secure the cabinet to the pallet using new tie straps.
8. Replace the door key and power supply cord in the documentation bag and tape the bag to the top of the cabinet.
9. Replace the foam insert, then the cardboard container.
10. Tape the top of the cardboard carton closed and secure it to the pallet with new strapping material.



Do not transport the Octel Overture 200/300 message server unless it is secured on the shipping pallet in the vertical, upright position.

Moving the Equipment On-Site

Before moving the server, verify the status of the new site:

- Is the input power ready?
- Is it the same as the input power required for the Octel Overture 200/300?
- Is the installation location ready?
- Are the telephone extensions ready to be hooked up?

Move the Octel Overture 200/300 server in the vertical, upright position on the shipping pallet. Be careful and always remember that the Octel Overture 200/300 is delicate electronic equipment.

4.2 INSTALLATION REQUIREMENTS

Installing the Octel Overture 200/300 involves the following:

- Connecting PBX extensions to Octel Overture 200/300 ports
- Connecting power to the cabinet
- Installing the configuration database
- Updating the database for both the Octel Overture 200/300 and the PBX
- Dedicating trunks in the PBX to the Octel Overture 200/300 hunt or distribution group
- Testing

Installation personnel should be familiar with the data format and change procedures of the PBX. For further explanation, refer to the Preparing the Phone System chapter in this volume.

Site Requirements

Install the Octel Overture 200/300 in a dust-free location. Keep the Octel Overture 200/300 separate from other equipment that might produce heat, generate strong magnetic fields, or produce vibration.

If space and environment permit, install the Octel Overture 200/300 in the telephone equipment room. Place the cabinet to permit front access and ventilation on all sides. The air filter cleaning and replacement schedule depends on the local environment.

Figure 4-1 is a floor plan for installing the Octel Overture 200 in the United States, Canada, and Mexico. Figure 4-2 is a floor plan for installing the Octel Overture 300 in the United States, Canada, and Mexico.

Power Requirements

The Octel Overture 200/300 should receive power from a dedicated, separate circuit. If this is not possible, make sure that the circuit is free of large motorized equipment, such as copy machines.

The power circuit must be compatible with the input voltage and frequency rating of the Octel Overture 200/300. The power circuit must have adequate current rating and be protected by a circuit breaker. Check the voltage rating marked on the power-line filter where the power cord connects to the Octel Overture 200/300. The voltage rating indicates the input current rating for the Octel Overture 200/300. Table 4-1 indicates the input circuit current that is to be supplied by a dedicated branch circuit.

Table 4-1 Input Circuit Current at Nominal Operating Line Voltage

Input Voltage Range	Frequency Range	Rated Input Current	
		Octel Overture 200	Octel Overture 300
120 Vac	50–60 Hz	6 A	10 A
240 Vac	50–60 Hz	3 A	6 A
–48 Vdc	dc	10 A	15 A

In the United States, the 120-Vac wall sockets are rated at 10 amperes and use a NEMA 5–15P plug rated for 15 amperes. Octel recommends the use of a standard a.c. branch circuit rated at 15 amperes to comply with the normal United States wiring practices.

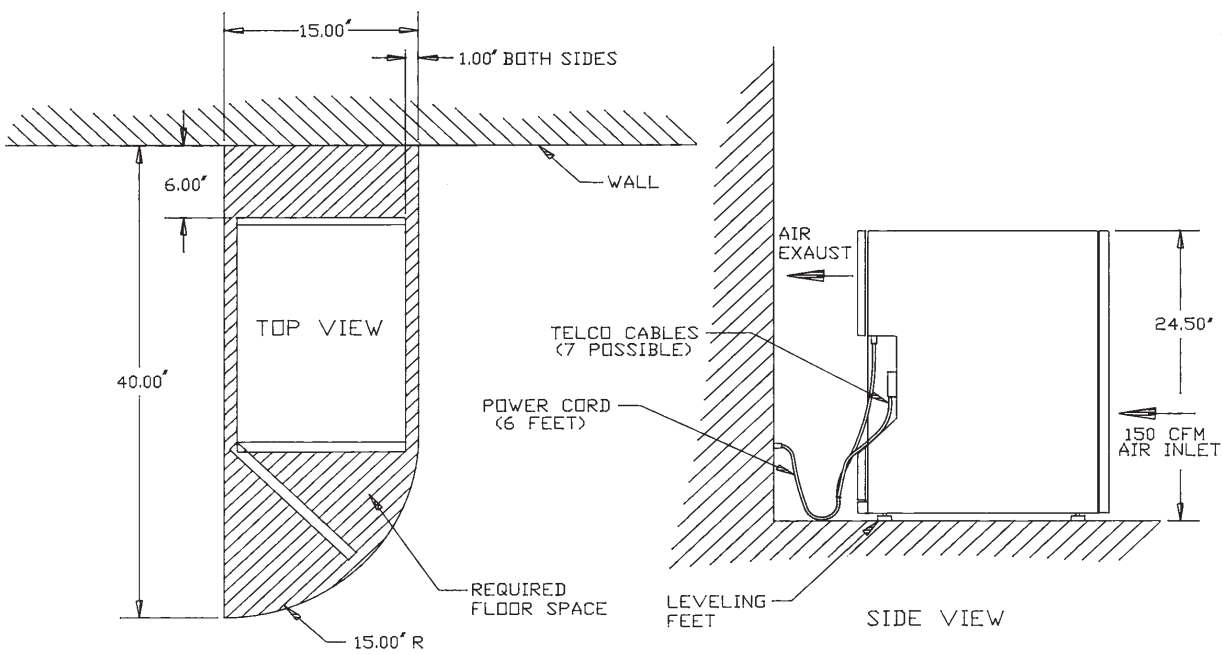

Service Access

- Rear access for system cabling
- Front access for service of field
- Side access not required

Acceptable Environment

- Equipment room
- Office environment

Maximum Heat Dissipation

- 1706 BTU/hr

	NOMINAL VOLTAGE	PLUG TYPE
USA	120 VAC	NEMA 5-15P
USA	240 VAC	NEMA 6-15P
International	Country Specific - 48 VDC	Country specific Permanently wired

Figure 4-1 Octel Overture 200 Floor Plan for Installation in the US, Canada and Mexico

Figure 4-2 Octel Overture 300 Floor Plan for Installation for the US, Canada, and Mexico

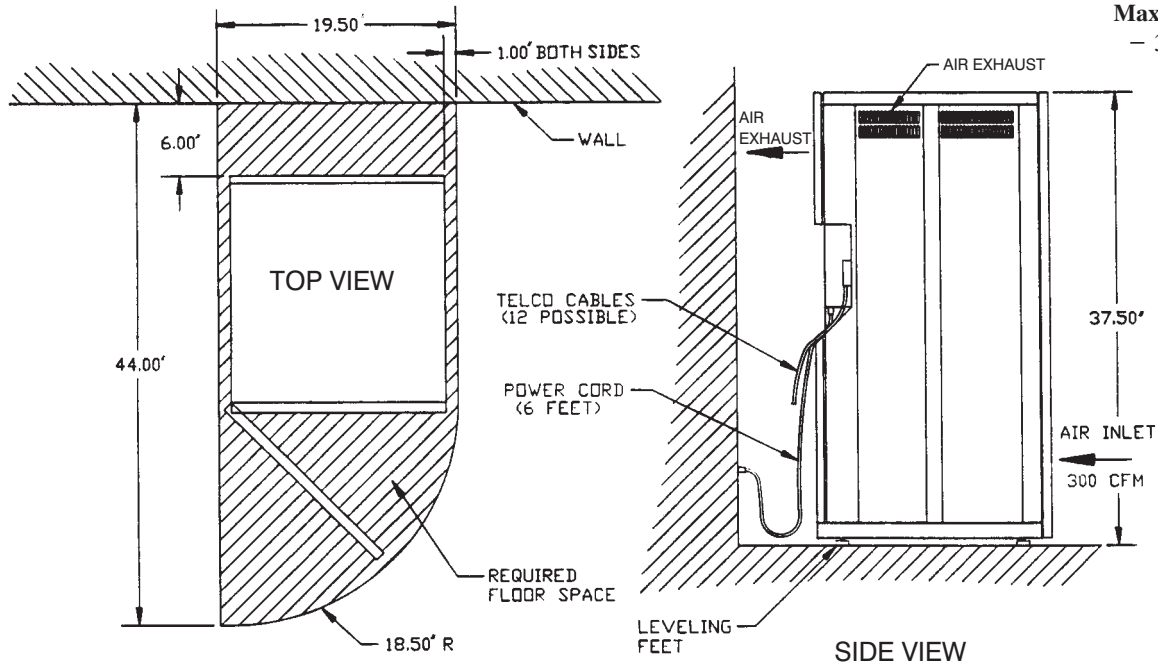

Service Access

- Rear access for system cabling
- Front access for service of field
- Side access not required

Acceptable Environment

- Equipment room
- Office environment

Maximum Heat Dissipation

- 3412 BTU/hr

	NOMINAL VOLTAGE	PLUG TYPE
USA	120 VAC	NEMA 5-15P
USA	240 VAC	NEMA 6-15P
International	Country Specific - 48 VDC	Country specific Permanently wired

**IMPORTANT SAFETY INSTRUCTIONS FOR A.C. POWERED SYSTEMS
SAVE THESE INSTRUCTIONS**

To conform to the safety agency grounding requirements, use the power cord provided. This power cord complies with the following UL requirement:

“An equipment grounding conductor that is not smaller in size than the ungrounded branch-circuit supply conductors, is to be installed as part of the circuit that supplies the product or system. Bare, covered or insulated grounding conductors are acceptable. Individually covered or insulated equipment grounding conductors shall have a continuous outer finish that is either green, or green with one or more yellow stripes. The equipment grounding conductor is to be connected to ground at the service equipment.”

Verify that the wall power outlet conforms to the following UL requirement:

“The attachment-plug receptacles in the vicinity of the product or system are all to be of a grounding type, and the equipment grounding conductors serving these receptacles are to be connected to earth ground at the service equipment.”

Refer to Table 4-1 for the input-circuit current capacity that is to be supplied for a dedicated circuit.

Use the following guidelines for calculating the input power requirements of an Octel Overture 200/300.

If the Octel Overture 200/300 is powered by an a.c. uninterruptible power supply (UPS) or a –48 Vdc source, the input power requirement should be calculated to ensure that the correct-capacity power source is chosen. The power requirements depend on the message server’s configuration, because a fully populated cabinet requires more power than a minimally configured cabinet. The size of the a.c. UPS or d.c. source must be chosen to match the maximum size configuration expected for each installation.

1. Calculate the exact message-server configuration, including all known growth plans.
2. Determine the total power consumption (in watts) of the configuration, using the values in Table 4-2.
3. If the message server is to be powered by an a.c. UPS, multiply the total power consumption figure by 1.5 to determine its volt-ampere requirements.
4. The total power consumption and volt-ampere requirements should be rounded up to the next multiple of 50, before being used to choose an a.c. UPS or –48 Vdc source.

Table 4-2 Input Power Requirements

Component	Power Consumption (watts)	
	Octel Overture 200	Octel Overture 300
Base cabinet	125	150
4-port line card	10	10
8-port line card	15	15
16-port line card	15	15
Fax Application Processor	30	30
LAN card	20	20
Voice/system disk drive	25	25
Works for Serenade™ disk	20	20
EntryWorks ACP card	20	20

 The base cabinet includes VCU, CPU, floppy-disk drive, fans, and PSU. All voice/system disk drives require the same amount of power, regardless of their storage capacity.

The following example for an Octel Overture 300 message server shows the calculation of the input power requirements for an 8-port message server, equipped with two 4-port line cards, one integration card, and two voice/system disk drives:

Base cabinet	150 W
Two 4-port line cards	20 W
One integration card	10 W
Two voice/system disk drives	50 W
Total input power	<u>230 W</u>
Total volt-ampere rating (1.5 x 230)	345 VA

Round the total-input power value and the total volt-ampere rating up to the next multiple of 50, producing the values to be used to select a suitable power source:

Total continuous input power requirement is 250 watts and 350 VA

Isolation Transformer

For installation sites that could experience power-line transients from lightning or power switching, the use of an isolation transformer is recommended. A dedicated isolation transformer must be rated at the following:

- 750 VA or greater is required for the Octel Overture 200.
- 1 kVA or greater is required for the Octel Overture 300.

Contact Octel for isolation transformers that have been tested and qualified for use with Octel Overture 200/300.

Uninterruptible Power Supply

If an uninterruptible power supply (UPS) is used, depending on the configuration of the Octel Overture 200/300, a UPS must be rated up to the following:

- 750 VA is required for the Octel Overture 200.
- 1 kW (1400 VA) is required for the Octel Overture 300.

Contact Octel for a UPS that has been tested and qualified for use with the Octel Overture 200/300.

Installing the Octel Overture 200/300 With –48-Vdc Power Supply Unit

The –48-Vdc powered server does not include a power cord. A terminal block is provided on the back of the cabinet for field wiring to the d.c. power source. The installation must be performed as described below, to comply with National Electrical Code (NEC) and UL regulations. In addition, use only those materials mentioned, because they must also be controlled. Field-wiring material is not included with the server, but it can be obtained from a local hardware store or qualified electrician.

List of Materials

The following materials are required for the installation:

- 1/2-inch diameter conduit.
- UL-approved, insulated, stranded wire to run through the conduit. Three separate wires must be connected; therefore, use three different wire colors. The grounding conductor insulation should be green and yellow.
 - The wire size for the Octel Overture 200 must be 12-gauge (3 mm²).
 - The wire size for the Octel Overture 300 must be 10-gauge (5 mm²).

The d.c. version of the Octel Overture 200/300 must be field-wired and connected to a branch circuit equipped with a branch-circuit overcurrent-protection device, set at the following:

- 20 A maximum, 60 Vdc for the Octel Overture 200.
- 25 A maximum, 60 Vdc for the Octel Overture 300.

 The conduit and the UL-approved, insulated stranded wire can be obtained preassembled.

- Six forked, crimp-on terminals with upturned ends for the wire size and a #10 screw.
- Conduit strain relief to fit a 1.10-inch-diameter hole in the sheet metal.

Installation Procedure

Perform the following steps to install the message server with a –48-Vdc power supply:

1. Place the Octel Overture 200/300 near the –48-Vdc power source.
2. Turn OFF the power to the d.c. power-source outlet to which the Octel Overture 200/300 will be connected.
3. Open the front door of the cabinet and verify that the power switch on the Power Supply Unit is in the OFF position.
4. Remove the two screws attaching the cover to the d.c. filter assembly, as shown in Figure 4-3 (Octel Overture 200) or Figure 4-4 (Octel Overture 300) and remove the cover.
5. Connect the Octel Overture 200/300 to the power source as shown in Figure 4-3 or Figure 4-4 and Figure 4-5. Connect the positive pole of the power source to the terminal-block position marked “+” and the negative pole to the position marked “–”.
6. Connect the earth-ground conductor from a suitable building ground to the ground stud next to the terminal block on the cabinet (refer to Figure 4-3 or Figure 4-4 and Figure 4-5).
7. Secure the cover to the d.c. filter assembly with the two screws removed in step 4.
8. Turn ON the power to the d.c. power-source outlet where the Octel Overture 200/300 has been connected.
9. Turn ON the power switch located on the power supply unit in the Octel Overture 200/300 cabinet, and verify proper operation, as discussed in the Octel Overture 200/300 Testing section in this chapter.

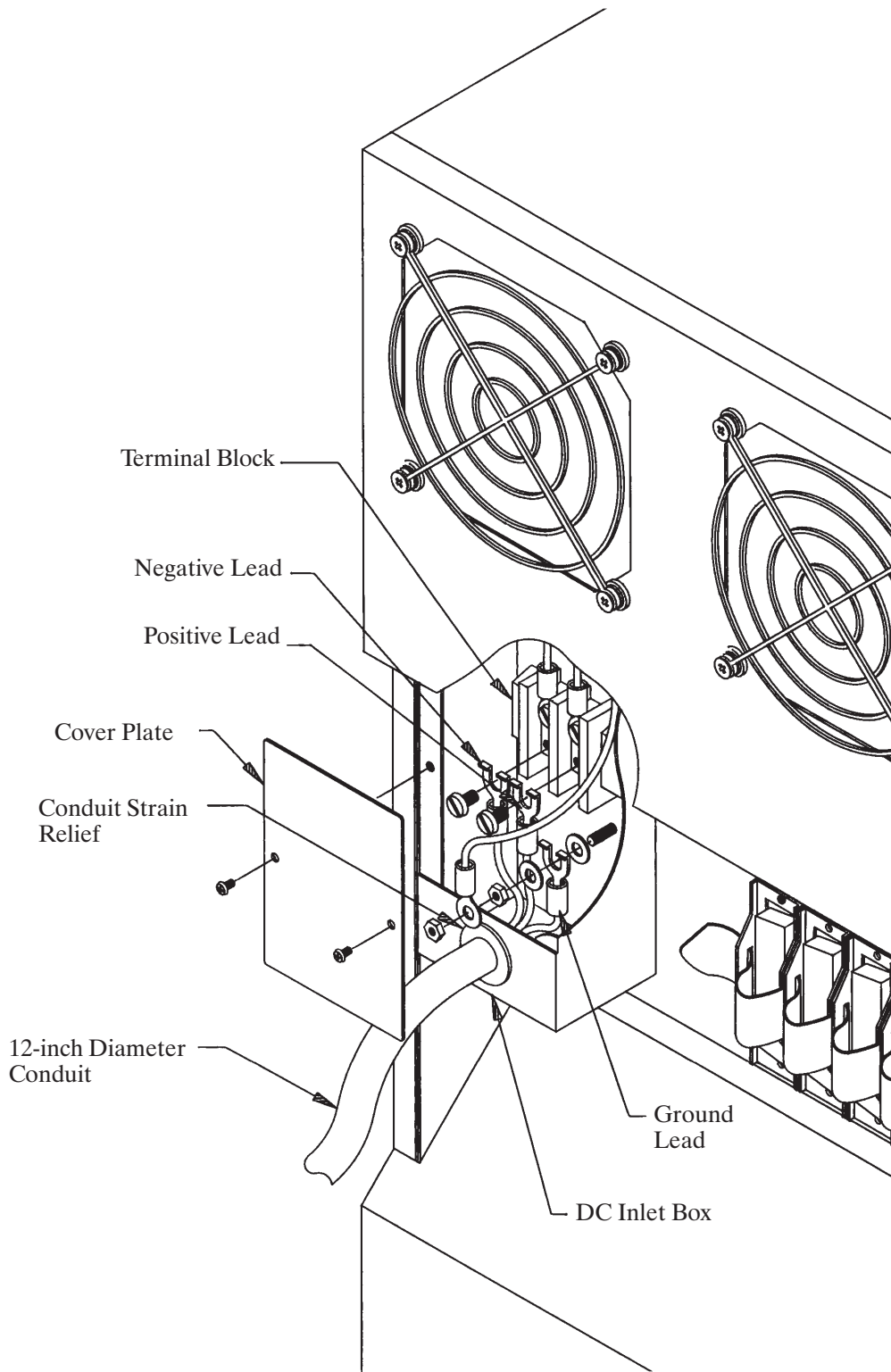

Figure 4-3 Octel Overture 200 Direct-Connect Installation

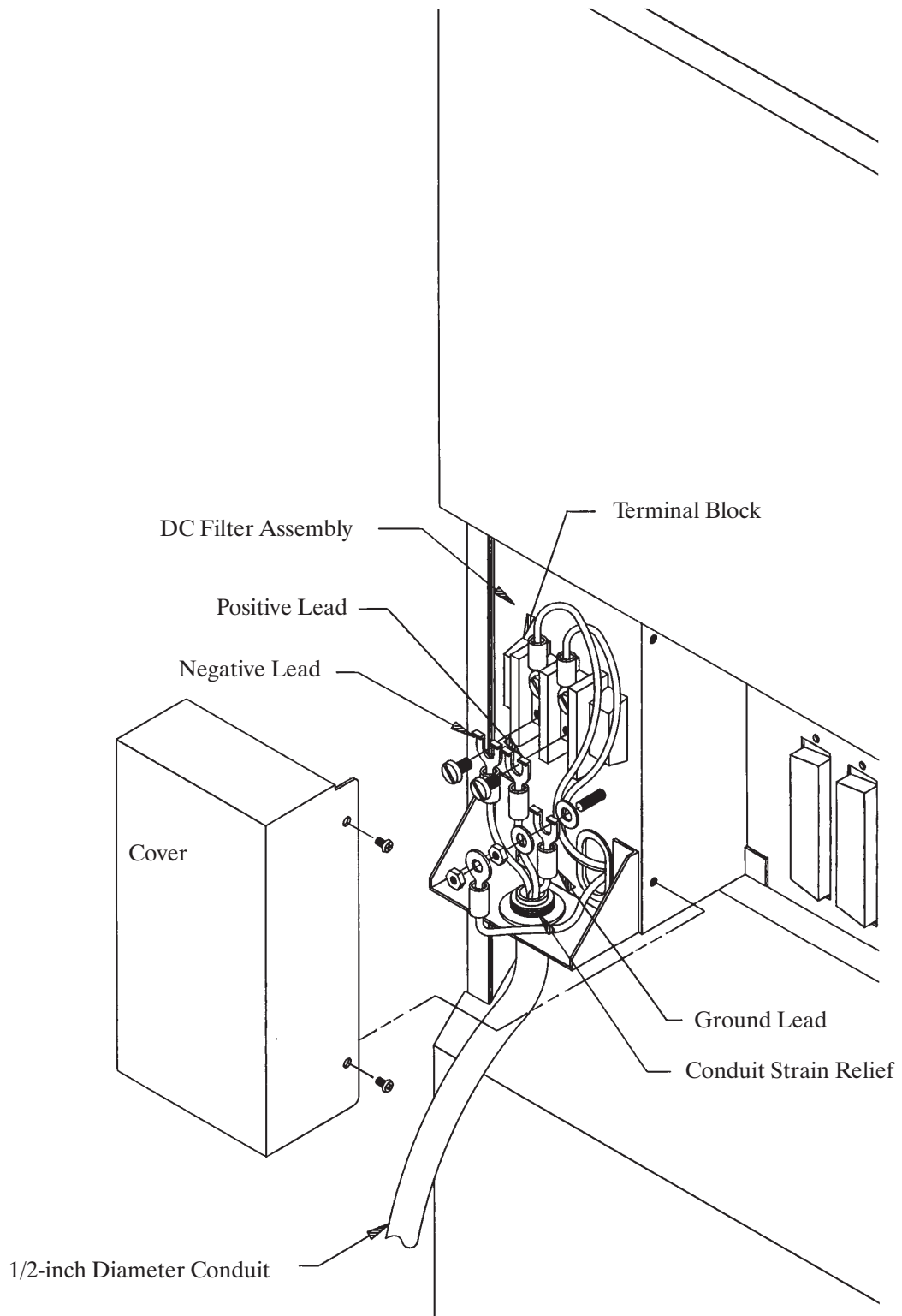

Figure 4-4 Octel Overture 300 Direct-Connect Installation

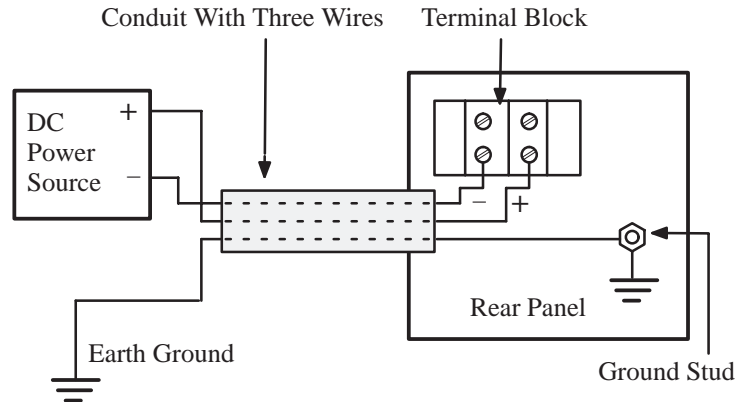

Figure 4-5 Diagram of the Field Wiring for -48-Vdc Powered Octel Overture 200

Cabinet Requirements

When you install the Octel Overture 200/300, adjust the levelers until the top of the cabinet is level, and the cabinet does not rock. A bubble level is recommended for this purpose. No special tools are required to adjust the leveling feet.

Distributor-Supplied Equipment

Each Octel Overture 200/300 line card is connected to the PBX with a 25-pair cable. Supply one cable for each line card. Make sure that the male/female connectors are long enough to reach between the Octel Overture 200/300 and the PBX extension jack, without undue stretching or tension.

The Octel Overture 200/300 can be connected to punchdown blocks with a 25-pair cable and then be jumpered to the PBX or Central Office lines. The Octel Overture 200/300 can also use 25-pair cable to connect to a breakout adapter that provides standard modular connectors.

A terminal, used for software installation and update, must be available at the customer site. During installation, use an RS-232C cable to connect the terminal to the Octel Overture 200/300. This terminal can be connected to the SP1 connector located in the front of the cabinet or at J1 in the rear of the cabinet. If the terminal is to be permanently installed with the message server, connect it to J1. If the terminal is only used temporarily during installation and maintenance, connect it to SP1. A printer is useful for making a hard copy of the software configuration.

Table 4-3 lists the equipment provided by the distributor. Refer to the Octel Overture 200/300 Testing section in this chapter for additional equipment needed for testing.

Table 4-3 Equipment Provided by Distributor

Item	Quantity
ASCII terminal (CRT or printer)	1
RS-232C cable for terminal or printer	1

4.3 PBX PREPARATION

Before continuing with the installation, ensure that the appropriate PBX changes have been made and tested. Instructions for preparing the PBX for the installation of the Octel Overture 200/300 are provided in the Preparing the Phone System chapter of this manual. Refer to that chapter for the following:

- Changing the PBX database
- Setting up hunt groups
- Directing trunks to the Octel Overture 200/300

4.4 TERMINAL COMMUNICATIONS

The Octel Overture 200/300 is designed to work with any ASCII send/receive serial terminal/teleprinter that meets RS-232C specifications.

Terminal/Teleprinter Installation

Octel recommends that the maximum distance between the terminal and the Octel Overture 200/300 is no more than 50 feet, which is the length of a standard RS-232C cable.

The Octel Overture 200/300 uses even parity, 7 data bits, 1 stop bit, and XON/XOFF protocol.

Compatible Terminals

The following terminals can be connected to the Octel Overture 200/300:

- TI Silent 700 or 703
- Hazeltine Model 1410
- Hewlett-Packard Models 2621A/P, 2631A
- Lear Siegler Model ADM-3A
- Wyse Model WY-50
- TeleVideo Terminal Model 950
- Panasonic KXD-11
- Falco 5500e, 500e
- Configuration Applications Terminal (CAT) (no procedures provided)

Connect the terminal/teleprinter to the system-terminal port. Two connections to the system-terminal port allow for convenient access: the front connection (SP1) for temporary access and the rear connection (J1) for permanent access. Octel recommends that the terminal/teleprinter have the capability to make a hard-copy printout.

Cable Connections Between the RS-232C Terminal and the Octel Overture 200/300

The system-terminal port (SP1 or J1) and Port B (J2) use standard 25-pin (DB25) RS-232C connectors (female), with the DCE pinouts listed in Table 4-4. Figure 4-6 is a diagram of these pinouts. On the Octel Overture 300, ports C and D (J3 and J4) are reserved for future use. They use the same pinouts as listed in Table 4-4 and shown in Figure 4-6.

Table 4-4 DCE Pinouts for Cable Connections Between the RS-232C Terminal and the Octel Overture 200/300

Pin	EIA/CKT	Signal Function
1	AA	Protective ground
2	BA	Transmit data (TX)
3	BB	Receive data (RX)
4	CA	Request to send (RTS)
5	CB	Clear to send (CTS)
7	AB	Signal ground
8	CF	Receive-line signal detector (DCD)
20	CD	Data terminal ready (DTR)

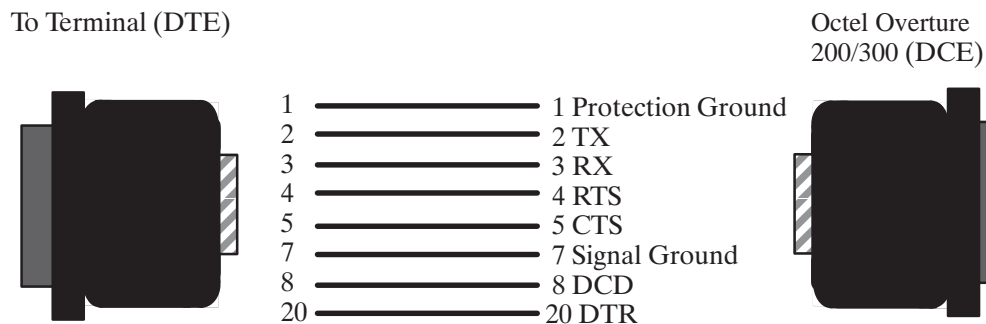

Figure 4-6 First and Second RS-232C Serial-Port Cable Pinouts for Connection to Terminal Equipment (DTE)

For correct operation, DTR (pin 20) must be asserted TRUE by the terminal. RTS (pin 4) must be exerted TRUE by the terminal when the terminal is able to accept data, or pin 4 must be left open.

If the terminal/teleprinter equipment has **pins 1 and 7** connected together, **intermittent problems** with the Octel Overture 200/300 might occur. Terminal/teleprinters requiring Data Set Ready (DSR) could require that pins 6 and 8 be connected together, or pins 8 and 20 connected together at the terminal end of the RS-232C cable. If you have a problem with or question about your terminal/teleprinter, call Octel technical support.

Connections Between an External Modem and the Octel Overture 200/300

You can use an external modem if a dedicated modem connection is required or if a modem with a baud rate different from the Octel Overture 200/300 internal modem is required. You can use a modem that supports standard baud rates (300 to 9600 baud) connected to the system-terminal port. Table 4-5 lists the pinouts for an external modem connection. Figure 4-7 is a diagram of external modem pinouts.

Table 4-5 Pinouts for External Modem Connections

Modem Pin Number	Octel Overture 200/300 Pin Number	Modem Signal Name/Function	Octel Overture 200/300 Name/Function
2	3	Transmit data	Receive data
3	2	Receive data	Transmit data
5	4	CTS	RTS
4	5	RTS	CTS
7	7	Signal ground	Signal ground
8	20	DCD	DTR
20	8	DTR	DCD

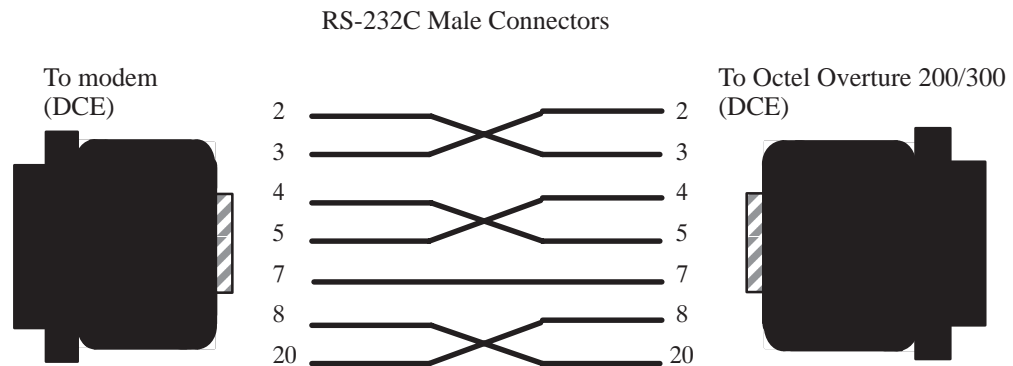

Figure 4-7 Octel Overture 200/300 to External Modem Pinouts

The Octel Overture 200/300 requires pin 4 (RTS) to be TRUE or left open and pin 20, Data Terminal Ready (DTR), to be TRUE. The modem must provide DCD (pin 8) and CTS (pin 5) at the modem connector; that is, DTR (pin 20) and RTS (pin 4) at the Octel Overture 200/300 connector.

Other considerations are as follows:

- The modem must drop DCD with the loss of carrier. If service is interrupted and the modem does not drop DCD, subsequent callers can reestablish the connection without requiring a security code.
- Auto-answer must be enabled to allow technical support personnel to connect to the modem without on-site intervention.
- Octel recommends forcing DTR high. This is required to maintain the connection with the message server, if a restart or reload is required. If DTR is not forced high, the connection is lost when the message server is restarted.

Cable the modem to either the front or rear system-terminal port. Test that the modem is correctly configured. If you have a problem or question connecting your modem, call Octel technical support.



Incorrect connection of the external modem can result in unauthorized access. Verify that the cabling and modem are installed correctly, and that the modem setup is tested. Refer to the Octel Overture 200/300 Support Note FI80048-01 for additional information.

Once the modem connection is established, press **Enter** until the password prompt appears, and follow the procedures in the Communicating with the Message Server section of this chapter.

Connecting to the Internal Modem

The Octel Overture 200/300 has an internal 300/1200/2400-baud modem. The internal modem can be connected either by entering **# # # 5** when the Octel Overture 200/300 answers or through a modem-access mailbox.

Connecting to the Internal Modem Using **# # # 5**

Connect the message server to the internal modem, as follows:

1. Call the Octel Overture 200/300.
2. When the Octel Overture 200/300 answers, enter **# # # 5**.
3. After you hear the high-pitched tone, enter the code to connect to the modem (ATD). The code can vary, depending on the interface and modem manufacturer. If you do not hear a high-pitched tone, repeat steps 1 and 2.
4. Hang up the receiver if step 3 was successful.

The Octel Overture 200/300 automatically adjusts to the modem's baud rate, which must be 300, 1200, or 2400 baud.

Modem-Access Mailboxes

To provide additional system security, access to the internal modem can be restricted to specific modem-access mailboxes.

To create a modem-access mailbox, assign COS Attribute 118 — PROVIDE MODEM TONE WHEN MAILBOX IS CALLED, and Attribute 3 — ASK FOR SECURITY CODE BEFORE CALLING EXTENSION, to the mailbox COS. The mailbox should have a security code assigned before attribute 3 is added.

To use **# # # 5** to block access to a modem, set System Parameter 223 — DISABLE ###5 ACCESS TO THE MODEM, to YES.

After the modem-access mailbox is created, perform the following steps to connect to the internal modem through the modem-access mailbox:

1. Call the Octel Overture 200/300.
2. When the company greeting plays, enter the mailbox number of the modem-access mailbox.

3. If attribute 3 is assigned to the mailbox COS, enter the security code.
4. After the high-pitched tone, enter the code to connect to the modem (ATD). The code can vary, depending on the interface and modem manufacturer. If you do not hear a high-pitched tone, repeat steps 1 through 3.
5. Hang up the receiver if step 4 was successful.

The Octel Overture 200/300 automatically adjusts to the modem's baud rate, which must be 300, 1200, or 2400 baud.

4.5 PIN ASSIGNMENTS FOR MESSAGE SERVER CARDS AND PORTS

Connectors P1 through P12 use a 50-pin male telco connector with the pin arrangement shown in Figure 4-8.

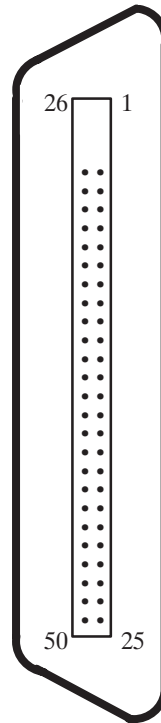

Figure 4-8 50-Pin Male Telco Connector Pinouts

The following sections contain tables showing the pin assignments for the following:

- Line-interface card (LIC4, LIC8, DLC16, and ILC12)
- Digital trunk interface card (DTIC)
- Telemarketing line card (TLC)
- ROLM integration card (RIC)
- Northern Telecom SL-1 integration card (SLIC)
- AT&T integration card (ATTIC)
- Mitel integration card (MIC)
- Serial integration card for the Meridian 1 (SIC8)
- AT&T PBX integration card (APIC)
- Northern Telecom PBX integration card (NPIC)
- Direct-access card (DAC)
- Direct-access card I/O panel J5 connector
- Direct-access card I/O panel power connector (P8)
- External-alarm port (J3 for Octel Overture 200 and J5 for Octel Overture 300)

Four-Port Line-Interface Card, ROLM Integration Card, and Mitel Integration Card

The following pin assignments are for the four-port line-interface card (LIC4), the ROLM integration card (RIC), and the Mitel integration card (MIC), as they appear on the rear 50-pin telco connector. If an LIC is installed in slot A1, it uses 50-pin telco connector P1; if it is installed in slot A2, it uses connector P2, etc.

50-Pin Number	Signal Function	50-Pin Number	Signal Function
1	RING1	26	TIP1
2		27	
3		28	
4	RING2	29	TIP2
5		30	
6		31	
7	RING3	32	TIP3
8		33	
9		34	
10	RING4	35	TIP4
11		36	
12		37	
13		38	
14		39	
15		40	
16		41	
17		42	
18		43	
19		44	
20		45	
21		46	
22		47	
23		48	
24		49	
25		50	

Eight-Port Line-Interface Card and Telemarketing Line Card

The following pin assignments are for the eight-port line-interface card (LIC8) and the Telemarketing Line Card (TLC), as they appear on the rear 50-pin telco connector. If an LIC or TLC is installed in slot A1, it uses 50-pin telco connector P1; if it is installed in slot A2, it uses connector P2, etc.

50-Pin Number	Signal Function	50-Pin Number	Signal Function
1	RING1	26	TIP1
2		27	
3		28	
4	RING2	29	TIP2
5		30	
6		31	
7	RING3	32	TIP3
8		33	
9		34	
10	RING4	35	TIP4
11		36	
12		37	
13	RING5	38	TIP5
14		39	
15		40	
16	RING6	41	TIP6
17		42	
18		43	
19	RING7	44	TIP7
20		45	
21		46	
22	RING8	47	TIP8
23		48	
24		49	
25		50	

16-Port Line-Interface Card (DLC16) and the PBX Integration Cards for Northern Telecom (NPIC)

The following pin assignments are for the 16-port line-interface card (DLC16) and the Northern Telecom PBX integration card (NPIC) as they appear on the rear 50-pin telco connector.

50-Pin Number	Signal Function	50-Pin Number	Signal Function
1	RING1	26	TIP1
2	RING2	27	TIP2
3	RING3	28	TIP3
4	RING4	29	TIP4
5	RING5	30	TIP5
6	RING6	31	TIP6
7	RING7	32	TIP7
8	RING8	33	TIP8
9	RING9	34	TIP9
10	RING10	35	TIP10
11	RING11	36	TIP11
12	RING12	37	TIP12
13	RING13	38	TIP13
14	RING14	39	TIP14
15	RING15	40	TIP15
16	RING16	41	TIP16
17		42	
18		43	
19		44	
20		45	
21		46	
22		47	
23		48	
24		49	
25		50	

12-Port International Line-Interface Card

The following pin assignments are for the 12-port international line-interface card (ILC12) as they appear on the rear 50-pin telco connector.

50-Pin Number	Signal Function	50-Pin Number	Signal Function
1	RING1	26	TIP1
2	RING2	27	TIP2
3	RING3	28	TIP3
4	RING4	29	TIP4
5	RING5	30	TIP5
6	RING6	31	TIP6
7	RING7	32	TIP7
8	RING8	33	TIP8
9	RING9	34	TIP9
10	RING10	35	TIP10
11	RING11	36	TIP11
12	RING12	37	TIP12
13		38	
14		39	
15		40	
16		41	
17		42	
18		43	
19		44	
20		45	
21		46	
22		47	
23		48	
24		49	
25		50	

DTIC Pin Assignment

The following pin assignments are for the Digital Trunk Interface Card (DTIC) as they appear on the rear 50-pin telco connector.

50-Pin Number	Signal Function	50-Pin Number	Signal Function
1	TXRING	26	TXTIP
2		27	
3		28	
4	TXRING	29	TXRING
5		30	
6		31	
7	RXRING	32	RXTIP
8		33	
9		34	
10	RXRING	35	RXRING
11		36	
12		37	
13		38	
14		39	
15		40	
16		41	
17		42	
18		43	
19		44	
20		45	
21		46	
22		47	
23		48	
24		49	
25		50	

Northern Telecom SL-1 Integration Card

The following pin assignments are for the Northern Telecom SL-1 integration card (SLIC) as they appear on the rear 50-pin telco connector. If a SLIC card is installed in slot A9, it uses 50-pin telco connector P9; if it is installed in slot A10, it uses connector P10, etc.

50-Pin Number	Signal Function	50-Pin Number	Signal Function
1	AVDR1	26	AVDT1
2	SIGR1	27	SIGT1
3		28	
4	AVDR2	29	AVDT2
5	SIGR2	30	SIGT2
6		31	
7	AVDR3	32	AVDT3
8	SIGR3	33	SIGT3
9		34	
10	AVDR4	35	AVDT4
11	SIGR4	36	SIGT4
12		37	
13		38	
14		39	
15		40	
16		41	
17		42	
18		43	
19		44	
20		45	
21		46	
22		47	
23		48	
24		49	
25		50	

AT&T Integration Card (ATTIC)

The following pin assignments are for the AT&T integration card (ATTIC) as they appear on the rear 50-pin telco connector. If an ATTIC card is installed in slot A9, it uses 50-pin telco connector P9; if it is installed in slot A10, it uses connector P10, etc.

50-Pin Number	Signal Function	50-Pin Number	Signal Function
1		26	
2	TXR1	27	TXT1
3	PXR1	28	PXT1
4		29	
5	TXR2	30	TXT2
6	PXR2	31	PXT2
7		32	
8	TXR3	33	TXT3
9	PXR3	34	PXT3
10		35	
11	TXR4	36	TXT4
12	PXR4	37	PXT4
13		38	
14		39	
15		40	
16		41	
17		42	
18		43	
19		44	
20		45	
21		46	
22		47	
23		48	
24		49	
25		50	

Serial Integration Card for the Meridian 1 (SIC8)

The following pin assignments are for the serial integration card (SIC8) for the Meridian 1 as they appear on the rear 50-pin telco connector. If an SIC8 card is installed in slot A9, it uses 50-pin telco connector P9; if it is installed in slot A10, it uses connector P10, etc.

50-Pin Number	Signal Function	Signal Name	50-Pin Number	Signal Function	Signal Name
1	GND	I/O (35)	26	TXD3	I/O (36)
2	TXD1	I/O (18)	27	RXD3	I/O (19)
3	RXD1	I/O (1)	28	RTS3	I/O (2)
4	RTS1	I/O (37)	29	CTS3	I/O (38)
5	CTS1	I/O (20)	30	DSR3	I/O (21)
6	DSR1	I/O (3)	31	DCD3	I/O (4)
7	DCD1	I/O (39)	32	DTR3	I/O (40)
8	DTR1	I/O (22)	33	GND	I/O (23)
9	GND	I/O (5)	34	TXD4	I/O (6)
10	TXD2	I/O (41)	35	RXD4	I/O (42)
11	RXD2	I/O (24)	36	RTS4	I/O (25)
12	RTS2	I/O (7)	37	CTS4	I/O (8)
13	CTS2	I/O (43)	38	DSR4	I/O (44)
14	DSR2	I/O (26)	39	DCD4	I/O (27)
15	DCD2	I/O (9)	40	DTR4	I/O (10)
16	DTR2	I/O (35)	41	GND	I/O (46)
17	GND	I/O (28)	42	TXD7	I/O (29)
18	TXD5	I/O (11)	43	RXD7	I/O (12)
19	RXD5	I/O (47)	44	DSR7	I/O (48)
20	DSR5	I/O (30)	45	DTR7	I/O (31)
21	DTR5	I/O (13)	46	TXD8	I/O (14)
22	TXD6	I/O (49)	47	RXD8	I/O (50)
23	RXD6	I/O (32)	48	DSR8	I/O (33)
24	DSR6	I/O (15)	49	DTR8	I/O (16)
25	DTR6	I/O (34)	50	GND	I/O (51)

APIC Integration Card

The following pin assignments are for the AT&T APIC card as they appear on the rear 50-pin telco connector. If an APIC card is installed in slot A9, it uses 50-pin telco connector P9; if it is installed in slot A10, it uses connector P10, etc.

☞ “TX” signals are from the APIC to the PBX. “PX” signals are from the PBX to the APIC.

50-Pin Number	Signal Function	50-Pin Number	Signal Function
1	TX RING 1	26	TX TIP 1
2	PX RING 1	27	PX TIP 1
3	TX RING 2	28	TX TIP 2
4	PX RING 2	29	PX TIP 2
5	TX RING 3	30	TX TIP 3
6	PX RING 3	31	PX TIP 3
7	TX RING 4	32	TX TIP 4
8	PX RING 4	33	PX TIP 4
9	TX RING 5	34	TX TIP 5
10	PX RING 5	35	PX TIP 5
11	TX RING 6	36	TX TIP 6
12	PX RING 6	37	PX TIP 6
13	TX RING 7	38	TX TIP 7
14	PX RING 7	39	PX TIP 7
15	TX RING 8	40	TX TIP 8
16	PX RING 8	41	PX TIP 8
17	TX RING 9	42	TX TIP 9
18	PX RING 9	43	PX TIP 9
19	TX RING 10	44	TX TIP 10
20	PX RING 10	45	PX TIP 10
21	TX RING 11	46	TX TIP 11
22	PX RING 11	47	PX TIP 11
23	TX RING 12	48	TX TIP 12
24	PX RING 12	49	PX TIP 12
25	(no connection)	50	(no connection)

SIC8 I/O Panel Pinouts

The following pin assignments are on the SIC8 I/O panel for port 1 (DB 26 connector).

50-Pin Number	Signal Function	I/O Line
1	GND	
2	TXD1	LI/O (18)
3	RXD1	LI/O (1)
4	RTS1	LI/O (37)
5	CTS1	LI/O (20)
6	DSR1	LI/O (3)
7	GND	
8	DCD1	LI/O (39)
9	GND	
10	N/C	
11	N/C	
12	N/C	
13	N/C	
14	N/C	
15	N/C	
16	N/C	
17	N/C	
18	N/C	
19	N/C	
20	DTR1	LI/O (22)
21	N/C	
22	N/C	
23	N/C	
24	N/C	
25	N/C	

Direct-Access Card (DAC)

The following pin assignments are for the direct-access Card (DAC) as they appear on the rear 50-pin telco connector. If a DAC is installed in slot A1, it uses 50-pin telco connector P1; if it is installed in slot A2, it uses connector P2, etc.

50-Pin Number	Signal Function	50-Pin Number	Signal Function
1	RING1	26	TIP1
2		27	
3		28	
4	RING2	29	TIP2
5		30	
6	-48V1	31	GND1
7	RING3	32	TIP3
8		33	
9		34	
10	RING4	35	TIP4
11		36	
12	-48V2	37	GND2
13		38	
14		39	
15		40	
16		41	
17		42	
18	-48V3	43	GND3
19		44	
20		45	
21		46	
22		47	
23		48	
24	-48V4	49	GND4
25		50	

Direct-Access Card I/O Panel DP EXT Connector

The following pin assignments are on the DP EXT connector for the DAC I/O panel. DP EXT is a 50-pin telco connector.

50-Pin Number	Signal Function	50-Pin Number	Signal Function
1	1RING1	26	1TIP1
2	1RING2	27	1TIP2
3	1RING3	28	1TIP3
4	1RING4	29	1TIP4
5	2RING1	30	2TIP1
6	2RING2	31	2TIP2
7	2RING3	32	2TIP3
8	2RING4	33	2TIP4
9	3RING1	34	3TIP1
10	3RING2	35	3TIP2
11	3RING3	36	3TIP3
12	3RING4	37	3TIP4
13	4RING1	38	4TIP1
14	4RING2	39	4TIP2
15	4RING3	40	4TIP3
16	4RING4	41	4TIP4
17		42	
18		43	
19		44	
20		45	
21		46	
22		47	
23		48	
24		49	
25		50	

Direct-Access Card I/O Panel Power Connector

The following pin assignments are for the DAC I/O panel power connector:

Pin	Function
1	GND
2	-48 Vdc

External Alarm Port

The external alarm port uses a 9-pin DB9 female connector with the following pin arrangement:



Front View DB9 Male Connector

- Use connector J3 for the Octel Overture 200.
- Use connector J5 for the Octel Overture 300.

The external-alarm connector pin assignments are as follows:

AJ1 and AJ2 Connector Pin Assignments

Pin Number	Signal Function
1	Relay A, Pin 1
2	Relay B, Pin 1
3	LINK
4	GND
5	GND
6	Relay A, Pin 2
7	Relay B, Pin 2
8	LINK
9	GND

Relay A is the major alarm relay. Relay B is the minor alarm relay. A relay is open when there is no alarm. When a relay is closed, it indicates an alarm condition.

With power removed from the cabinet, both Relay A and Relay B are in the closed position (normally closed), indicating an alarm condition.

Pins 3 and 8 are linked together to provide a loop. You can use this as a confirmation that an alarm cable is installed. Pins 4, 5, and 9 are connected to cabinet ground. These pins can be jumpered to a relay contact, if closure to ground is required.

Both Relay A and Relay B are rated at

- 48 Vdc maximum
- 0.5 A maximum

The link loop is rated at

- 12 Vdc maximum
- 200 mA maximum

4.6 COMMUNICATING WITH THE MESSAGE SERVER

The Octel Overture 200/300 indicates it is ready to receive commands or other input by displaying a prompt character. The actual prompt character displayed indicates whether you are at the operating system level or within the INSTALL or UPDATE programs. The prompt characters are as follows:

Prompt	System Level	Action
@	Operating system	Ready to accept commands
:	INSTALL program	Waiting for input
.	UPDATE program	Waiting for input

To enter an Octel Overture 200/300 command, type the command at the prompt, and press . This key is labeled on some terminals.

Examples of the commands are provided in the *Configuration* volume, and in this volume in the Maintenance Commands chapter.

Remote access is not available until after the database has been installed. The terminal can only be connected directly to the Octel Overture 200/300 via RS-232C cable.

Local Access

When locally connected, proceed as follows:

1. Connect the terminal to either the front or rear connector of the system-terminal port.
2. Turn the terminal ON. Set the baud rate by pressing until the password prompt appears.
3. When the password prompt is displayed, enter the password, and press .

Default passwords for new servers are created by the manufacturer. For the report, administrative, and maintenance levels, the default passwords are REPORT, ADMIN, and MAINT, respectively. For security, create new server passwords as soon as possible. Refer to the Maintenance chapter, Miscellaneous Commands section, for information about setting passwords.

4. The operating system @ prompt appears.

Remote Access

After the database has been installed, the Octel Overture 200/300 can be remotely accessed. Call the Octel Overture 200/300 from a Bell 103A/212A/CCITT V.22/CCITT V.22 bis compatible modem-equipped terminal. When you hear the company greeting, access the modem by entering `# # # 5`, or access the modem through a modem-access mailbox, if it is used. The message server responds with a high-pitched tone. Connect your modem. The Octel Overture 200/300 header should appear shortly. Proceed as if directly connected.

Automatic Terminal Logout

The message server is automatically logged off if there is no activity within the time specified in System Parameter 286 — `TERMINAL INACTIVITY LOGOUT TIMER (MINUTES)`. The default is 3 minutes, but the inactivity length can be configured for up to 15 minutes. Refer to the *Configuration* volume, `SYSTEM PARAMETER` Table chapter.

Inactivity logout does not occur when the system administrator is in the midst of a noninteractive command, for example running a List Trace. This could take several minutes to complete.

4.7 OCTEL OVERTURE 200/300 HARDWARE INSTALLATION

The physical installation of the message server begins by connecting the printer to the Octel Overture 200/300, applying power, and observing the Octel Overture 200/300 self-test.

Powering Up

Connect the Octel Overture 200/300 power cord to the dedicated power circuit and turn the cabinet power switch to ON.

The LEDs on each circuit board are ON or OFF according to the following sequence after power up or reset:

1. Diagnostic Phase (red LED ON, green LED OFF)

After power up or reset, each circuit board executes its diagnostic self-test. While the self-test is being performed, the red LED is ON and the green LED is OFF. A diagnostic self-test can take up to five minutes.

2. Software Download Phase (red LED ON, green LED ON)

If a circuit board's diagnostic self-test is successful, the green LED is turned ON. If the green LED does not come on within five minutes after power up or reset, replace the circuit board.

3. Operational Phase (red LED OFF, green LED ON)

The downloaded operational software turns OFF the red LED, indicating that the circuit board is operational.

4. Activity LED (yellow LED ON or OFF)

The yellow LED indicates activity. The meaning of the yellow LED is circuit board dependent.

Measuring d.c. Voltages

The a.c. and d.c. wiring is prewired to connectors that are automatically engaged when the power supply is installed. There are no power-supply adjustments. Use a digital voltmeter to measure the system d.c. voltages at the voltage test points on the front edge of the CPU board. Measure between Test Point 1, ground (use a common probe lead), and other test points to determine whether the voltages are in range. Refer to Table 4-6; if any voltage is out of range, replace the power supply.

Table 4-6 Power Supply Output Rating and Acceptable Operating Ranges

Test Point	Nominal Voltage	Acceptable Operating Range (Vdc)
8	Ground	...
7	-5 VC	-4.50 to -5.50
6	+5 VC	4.50 to 5.50
5	+12 VM	11.40 to 12.60
4	-12 V	-10.80 to -13.20
3	+12 V	10.80 to 13.20
2	+5 V	4.75 to 5.25
1	Ground	...

Connecting the Terminal

Connect the terminal to the RS-232C connector marked J1 in the rear of the cabinet or to SP1.

When the Octel Overture 200/300 is initially powered up or restarted, you must establish the system baud rate to print diagnostic messages. Refer to the following section.

If the system baud rate has already been established, the system header displays. Otherwise, press repeatedly (until the password prompt appears) to establish the baud rate.

Starting Up the System

When the Octel Overture 200/300 is loaded or reloaded, the CPU and VCU execute a Boot ROM diagnostic. This section describes the results of this diagnostic.

Turn ON your terminal and set the baud rate to any of the valid rates (300, 600, 1200, 2400, 4800, 9600, or 19200). At any of these baud rates, the Octel Overture 200/300 will print or display the diagnostic status. Turn ON the power to the server.

Immediately following power up, press repeatedly to establish the baud rate. If the baud rate is not established at this time, the system header and diagnostic messages will not print.

The terminal displays:

```

CPU                               Model 300-6004-001                Rev XX
486                                                             12MB

Testing Processor...PASSED
Testing System Voltage/Temp...PASSED
Testing ROM Checksum...PASSED
.
.
.

Testing COMPLETED
Booting from SCSI file XBOOT.IM
Image loaded
Loading Image from Hard Disk
.
.
Image loaded

----- SYSTEM SOFTWARE  RELEASE S.X.X.X-2 (MM/DD/YY) -----
Copyright (c) 199x Octel Communications Corp. All Rights Reserved.
DAY MM/DD/YY HH:MM:SS YYYY (SYSTEM NAME)  ID:000 S/N:000000 PBX:00
(MODEM ENABLED)  LAST LOGIN: 00/00 00:00
@WAITING FOR VCU READY
LOADING VCU WITH FILE H:VCU
VCU STARTED
RUNNING DISK REBUILD...REBUILD DONE
INITIALIZING PORTS...PORT INITIALIZATION DONE

```

When the message server is reset using either the Power Up procedure or CPU reset switch, the LEDs on the PCAs should respond as described in the Powering Up section. If the diagnostics are not successful, the Octel Overture 200/300 restarts the test routine. If a problem is found, the terminal displays a specific error type. Refer to the System Errors and Traffic Pegs chapter, Hardware Errors section, to interpret the error code and select the maintenance action required.

Wait for the operating system to load and the diagnostic self-testing to finish. If the tests were completed successfully, the Octel Overture 200/300 displays `INITIALIZING PORTS...PORT INITIALIZATION DONE`. Proceed to the software installation.

4.8 RACK MOUNT INSTALLATION, OCTEL OVERTURE 300

The Octel Overture 300 can be installed in a 19-inch rack. Figure 4-9 illustrates a rack-mount installation.

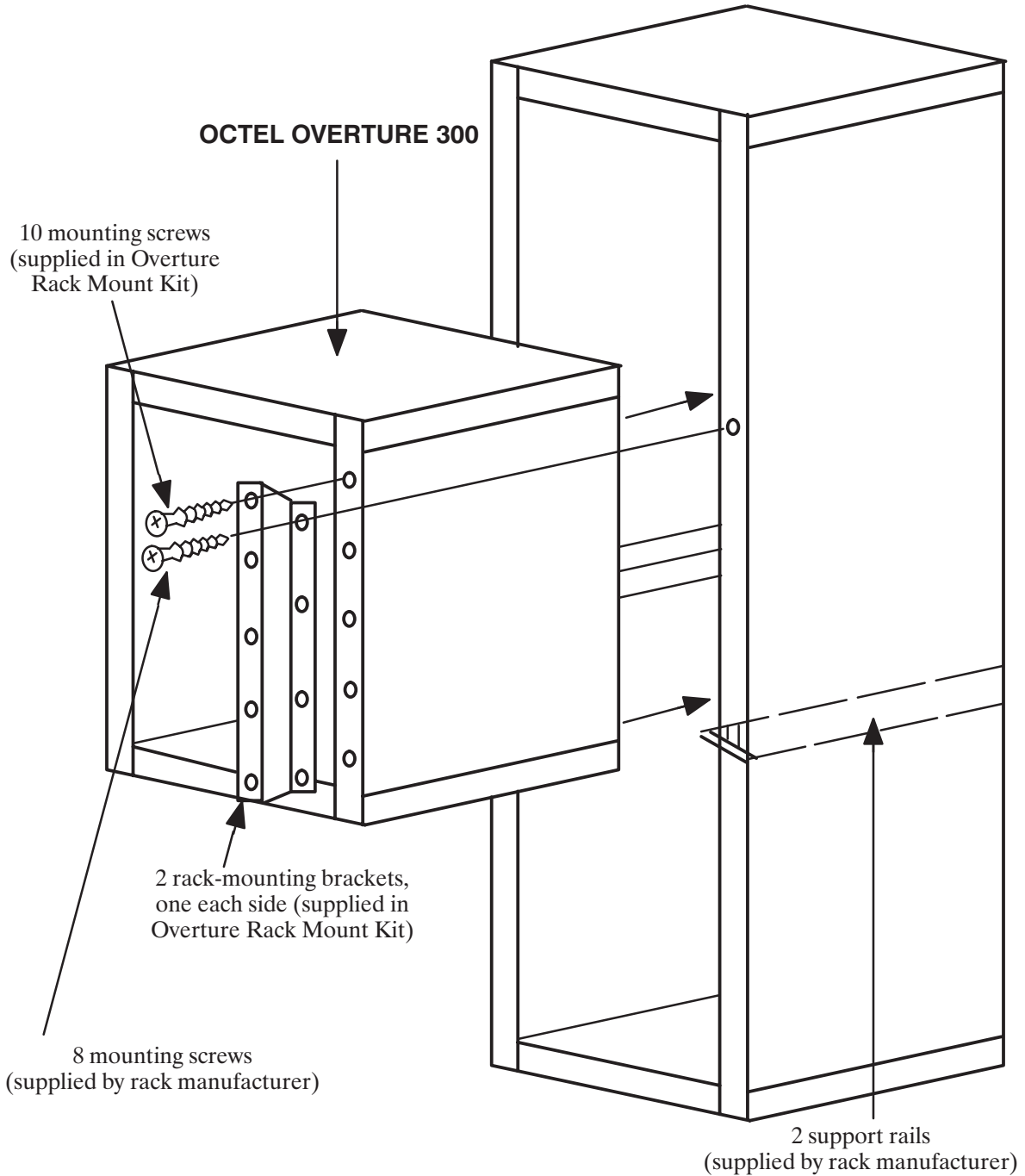

Figure 4-9 Octel Overture 200/300 Cabinet Installed in 19-Inch Rack

Preinstallation

Determine whether the rack to be used is of a suitable size and strength to hold the Octel Overture 300. At maximum configuration, the server can weigh as much as 220 pounds and might be too heavy for some racks. Make sure that the rack is structurally sound before and after the server is installed. Remove any rack casters, as they make the rack less stable. To increase stability further, you might need to bolt the rack to the floor or provide some other means of support.

Obtain support rails from the rack manufacturer. Install the rails in the rack to support the weight of the server. Unless the rack has threaded holes in vertical mounting rails, the rack manufacturer must also provide speed nuts and rack-mounting screws for securing the front of the server to the rack.

If the Octel Overture 300 is currently in service, make sure that all cables connected to the back of the server are long enough to reach the server when it is mounted in the rack.

The front and back of the rack must remain open to ensure proper air flow through the server. Mount the server low enough in the rack so that any service person can easily service the server while standing on the floor.

The following equipment and tools are required:

Quantity	Description
1	Octel Overture 300 message server
1	Rack mount kit, Part No. 740-6036-001, which includes two mounting brackets and 10 mounting screws
1	19-inch rack
2	Support rails, rated for at least 220 pounds
8	Rack-mounting screws
8	Speed nuts, if required
1	Phillips screwdriver

Installation

Use the following steps to install the Octel Overture 300 in a rack:

1. Open and remove the front door of the server.
2. Put on an antistatic wrist strap. Connect it to an unpainted portion of the cabinet.
3. Make sure that the power to the Octel Overture 300 is turned OFF.
4. Remove the power-supply unit, fan tray, and all disk drives to reduce the weight of the cabinet and to protect the disk drives from damage. Refer to the Hardware Replacement chapter, Hardware Removal section, for instructions about removing assemblies. Make sure to note the slot position of all disk drives, because they must be replaced in the same slots. You do not need to remove PCAs in slots A1 through A14.

5. If the message server has been in service, disconnect all cables from the rear of the cabinet. Make sure to note the cable positions, because they must be reconnected exactly as they were.
6. Install the rack-mounting brackets to the front vertical flanges of the Octel Overture 300 cabinet with the screws provided, using a Phillips screwdriver. Refer to Figure 4-9.
7. Determine the location of the Octel Overture 300 in the rack, and install the support rails from the rack manufacturer appropriately.
8. Using a tape measure, determine where the speed nuts provided by the manufacturer should clip on the rack vertical rails to line up with the holes in the Octel Overture 300 rack-mounting brackets.

 The preceding step is not necessary if the rack has threaded holes in the vertical mounting rails.
9. Two people are needed to insert the cabinet into the rack. Lift the partially empty cabinet onto the support rails in the rack. You might need to remove the leveling feet on the bottom of the cabinet, so that the cabinet can sit correctly on the support rails.
10. Secure the cabinet to the rack using the mounting screws provided by the rack manufacturer.
11. Install all assemblies removed in step 4, and secure them to the cabinet. Refer to the Hardware Replacement chapter for instructions about installing assemblies.
12. If the message server has been in service, install all cables in the back of the cabinet as they were before beginning this procedure. If not, follow the additional installation procedures in the Connecting the Phone System to the Octel Overture 300 section of this chapter.
13. Turn on the power to the message server, and test its operation. Refer to the Octel Overture 300 Testing section in this chapter.
14. Replace and lock the front door of the cabinet.

Removal

To remove the Octel Overture 300 from a vertical rack, perform the following steps:

1. Open and remove the front door of the cabinet.
2. Put on an antistatic wrist strap. Connect it to an unpainted portion of the cabinet.
3. Make sure that the Octel Overture 300 is turned OFF.
4. Remove the power-supply unit, fan tray, and all disk drives to reduce the weight of the cabinet and to protect the disk drives from damage. Refer to the Hardware Replacement chapter for instructions about removing assemblies. Make sure to note the slot position of all disk drives, because they must be replaced in the same slots. You do not need to remove PCAs in slots A1 through A14.
5. If the message server has been in service, disconnect all cables from the rear of the cabinet. Make sure to note the cable positions, because they might need to be reconnected exactly as they were.
6. Two people are needed to remove the cabinet from the rack. Lift the partially empty cabinet out of the rack, and place it on the floor.
7. Install all assemblies removed in step 4, and secure them to the cabinet. Refer to the Hardware Replacement chapter for instructions about installing assemblies.
8. Remove the rack-mount hardware.

9. If the Octel Overture 300 is to be shipped, refer to the Receiving the Equipment, Reshipping section, in this chapter.
10. If the Octel Overture 300 is to be returned to service, install all cables at the back of the cabinet as they were before beginning this procedure.
11. Turn ON the power to the server and test the message server's operation. Refer to the Octel Overture 300 Testing section in this chapter.
12. Replace and lock the front door to the cabinet.

4.9 SOFTWARE INSTALLATION

System parameters and customer-provided information are entered in the message-server memory through a terminal and a two-part configuration program. Use the INSTALL program to enter information for new installations; use the UPDATE program for verification and to change the configuration database. This section is an overview of the software installation. Detailed directions for all steps are found in the *Configuration* volume.

Using INSTALL — Entering the Configuration Database

After the operating system has been loaded and the self-test completed, the Octel Overture 200/300 is ready for you to enter the password. After a valid password is entered, begin the INSTALL program. At the @ prompt, type

```
INSTA 
```

When prompted, enter data as described in the *Configuration* volume to define the database.

Answer Y when the Octel Overture 200/300 asks whether you want to save the configuration to diskette. Follow the Octel Overture 200/300 directions to insert the configuration diskette in the floppy-disk drive.

Using UPDATE

Use the UPDATE program for verifying and modifying the configuration database, as described in the following two sections.

Verifying the Configuration Database

After you finish the message server configuration, the terminal again displays the @ prompt. To get a printout of the database, enter the UPDATE program. At the @ prompt, type

```
UP 
```

The terminal displays the dot (.) prompt. At the dot, type

```
L ALL
```

Check the printout with the configuration forms and verify that the data is correct. If correct, exit from the program by typing

```
E
```

If any of the data is incorrect, follow the instructions in the *Configuration* volume when changing the database. When any changes are made in the configuration database, always save the information on a diskette when exiting the UPDATE program. Answer Y when the Octel Overture 200/300 asks whether you want to save the configuration to diskette.

Modifying the Configuration Database

You can modify, add, or delete message-server configuration data. When the terminal or teleprinter displays the @ prompt, type UP and press to access the UPDATE program. At the dot (.) prompt, you can enter an UPDATE command. Refer to the *Configuration* volume, UPDATE Table chapter, Understanding Update section.

4.10 CONNECTING THE PHONE SYSTEM TO THE OCTEL OVERTURE 200/300

After you have verified that both the message server and the PBX are configured correctly, you must connect the Octel Overture 200/300 to the PBX.

Connection Overview

The Octel Overture 200/300 installation involves connecting 25-pair cables from the rear of the Octel Overture 200/300 to a 66M4-4W connector block, which is mounted on a backboard. Each 25-pair cable supports one slot on the Octel Overture 200/300. The Octel Overture 200/300 is then connected with jumper wire to the PBX.

It is recommended that the PBX extensions to be associated with the Octel Overture 200/300 be terminated on a 66M connector block, or equivalent, for ease of installation and fault isolation, as shown in Figure 4-10.

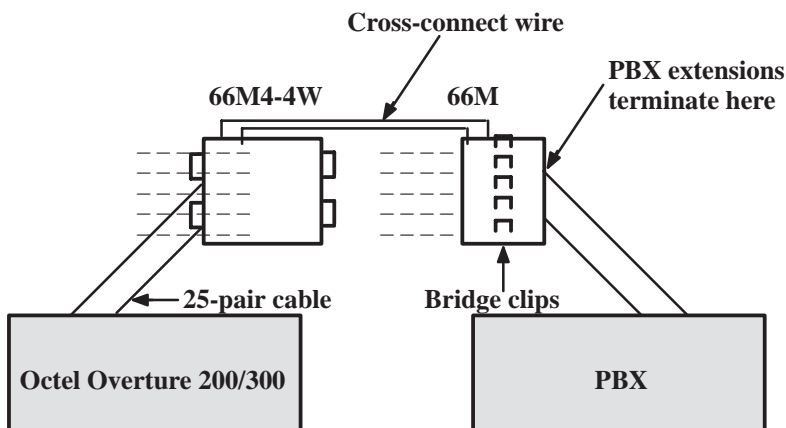

Figure 4-10 Typical Octel Overture 200/300 Connections

Verifying the Equipment

The following equipment is required for installation of the Octel Overture 200/300:

- PBX extensions associated with the Octel Overture 200/300, to be terminated on a 66M connector block, or equivalent
- Octel Overture 200/300 installation kit
- DAC installation kit, Part No. 740-6045-001, if installing DAC

Each kit installs four DAC slots. To determine the number of DAC installation kits to order, divide the total number of DAC slots by four. The kit contains the following:

- One DAC I/O Panel Assembly, Part No. 740-6051-001
- One d.c. Power Supply Assembly, Part No. 740-6050-001

☞ The short 50-pin cable is not included in the installation kit. Order the cable separately, one cable for each slot.

Each line card installation kit, Part No. 740-6034-001, installs four line-card slots. To determine the number of line-card installation kits to order, divide the total number of line-card slots by four. The kit contains the following:

- ☐ One 66M4-4W connector block, Part No. PJ86001-01
- ☐ Four 10-foot cables with male-to-female 25-pair connectors, Part No. SA10079-02
- ☐ Two self-tap 10 x 5/8 PH sheet-metal screws, Part No. HH53024-01

A line-card installation kit is required if you are installing an integration card for the Octel Overture 200/300.

☞ For more information about the installation of an integration card, refer to the appropriate chapter in the *Integration* volume. For information about installing the EntryWorks ACP card, refer to the Works for Serenade documentation.

Connector Blocks

Figure 4-11 shows the connector block that is to be used to add wiring for the Octel Overture 200/300. The block is supplied in the installation kit. The connector block has 50 separate punchdown contacts in each column, with each column wired to an amphenol connector at the side of the block. Column A is wired to jack 1, column B to jack 2, etc.

Mount the block to the backboard in the location that you have specified. Mounting screws are provided when the block is ordered. Mount the block with the word “TOP” (embossed in the plastic, located at the upper left side of the block) facing up (refer to Figure 4-11).

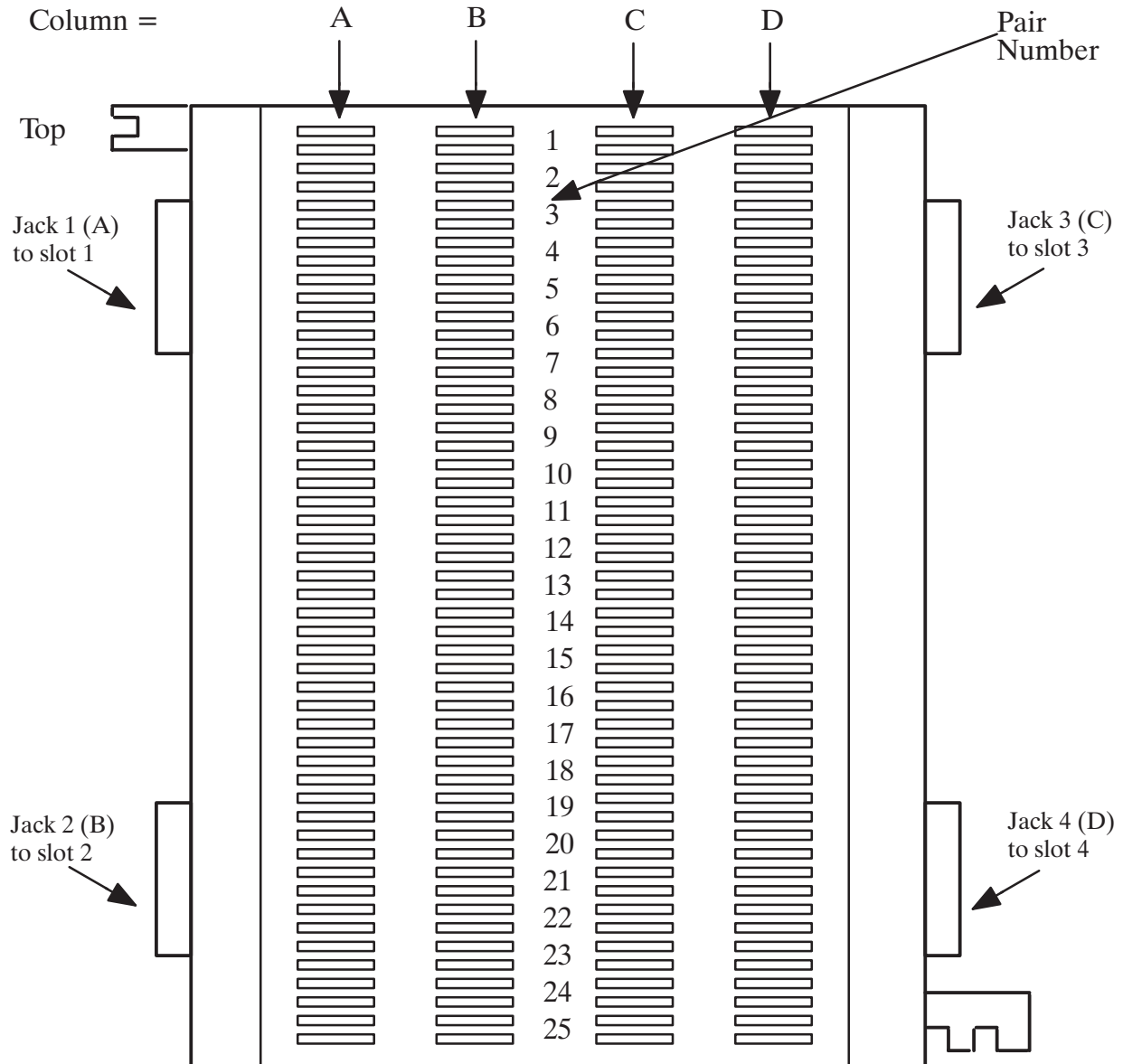

Figure 4-11 Connector Block

Wiring

In most cases, the existing wiring is not consistent in its placement of the connections. To isolate faults quickly, it is recommended that the slots be connected in numerical order, allowing for known or anticipated expansion. At least, make sure that the slot and port numbers can be translated to extension numbers that are meaningful to the servicing technician.

Figure 4-12 is an example of a 16-port message server that requires one connector block and four 25-pair cables. From the rear of the cabinet, connect the first 25-pair cable from P1 to jack position 1 of the 66M4-4W connector block, or column A; connect the second 25-pair cable from P2 to jack position 2, or column B; etc.

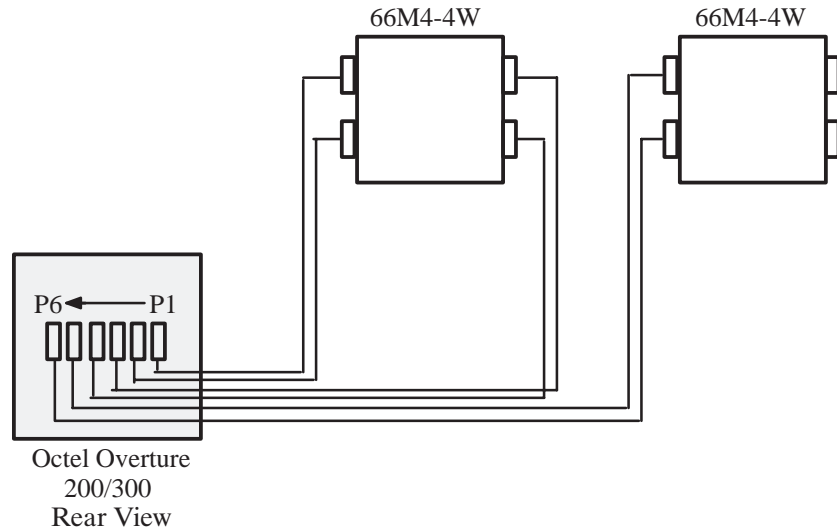

Figure 4-12 Example of Server-to-Block Connections

For maximum configuration, three connector blocks and twelve 25-pair cables are required.

The actual wiring (cross-connections from the 66M4-4W connector block to the 66M block, or equivalent), can be made in any manner consistent with good telephony practices. Follow these two guidelines when punching down wires to ensure correct installation:

- ❑ **Do not** touch the pins on the connector block with your fingers or with dirty tools. The pins could oxidize and open after a few months.
- ❑ Tip is always above ring on the block when a pair is punched down. Refer Table 4-7, M4-4W Connector-Block Designators.

Table 4-7 66M4-4W Connector Block Designators

#	PR Wire#	Cable Color	Column											
			A	Slot	Port	B	Slot	Port	C	Slot	Port	D	Slot	Port
1	26	WHT-BLU	TA1	1	1	TB1	2	1	TC1	3	1	TD1	4	1
	1	BLU-WHT	RA1	1	1	RB1	2	1	RC1	3	1	RD1	4	1
2	27	WHT-ORG	TA2			TB2			TC2			TD2		
	2	ORG-WHT	RA2			RB2			RC2			RD2		
3	28	WHT-GRN	TA3			TB3			TC3			TD3		
	3	GRN-WHT	RA3			RB3			RC3			RD3		
4	29	WHT-BRN	TA4	1	2	TB4	2	2	TC4	3	2	TD4	4	2
	4	BRN-WHT	RA4	1	2	RB4	2	2	RC4	3	2	RD4	4	2
5	30	WHT-SLT	TA5			TB5			TC5			TD5		
	5	SLT-WHT	RA5			RB5			RC5			RD5		
6	31	RED-BLU	TA6			TB6			TC6			TD6		
	6	BLU-RED	RA6			RB6			RC6			RD6		
7	32	RED-ORG	TA7	1	3	TB7	2	3	TC7	3	3	TD7	4	3
	7	ORG-RED	RA7	1	3	RB7	2	3	RC7	3	3	RD7	4	3
8	33	RED-GRN	TA8			TB8			TC8			TD8		
	8	GRN-RED	RA8			RB8			RC8			RD8		
9	34	RED-BRN	TA9			TB9			TC9			TD9		
	9	BRN-RED	RA9			RB9			RC9			RD9		
10	35	RED-SLT	TA10	1	4	TB10	2	4	TC10	3	4	TD10	4	4
	10	SLT-RED	RA10	1	4	RB10	2	4	RC10	3	4	RD10	4	4
11	36	BLK-BLU	TA11			TB11			TC11			TD11		
	11	BLU-BLK	RA11			RB11			RC11			RD11		
12	37	BLK-ORG	TA12			TB12			TC12			TD12		
	12	ORG-BLK	RA12			RB12			RC12			RD12		
13	38	BLK-GRN	TA13	1	5	TB13	2	5	TC13	3	5	TD13	4	5
	13	GRN-BLK	RA13	1	5	RB13	2	5	RC13	3	5	RD13	4	5
14	39	BLK-BRN	TA14			TB14			TC14			TD14		
	14	BRN-BLK	RA14			RB14			RC14			RD14		
15	40	BLK-SLT	TA15			TB15			TC15			TD15		
	15	SLT-BLK	RA15			RB15			RC15			RD15		
16	41	YEL-BLU	TA16	1	6	TB16	2	6	TC16	3	6	TD16	4	6
	16	BLU-YEL	RA16	1	6	RB16	2	6	RC16	3	6	RD16	4	6
17	42	YEL-ORG	TA17			TB17			TC17			TD17		
	17	ORG-YEL	RA17			RB17			RC17			RD17		
18	43	YEL-GRN	TA18			TB18			TC18			TD18		
	18	GRN-YEL	RA18			RB18			RC18			RD18		
19	44	YEL-BRN	TA19	1	7	TB19	2	7	TC19	3	7	TD19	4	7
	19	BRN-YEL	RA19	1	7	RB19	2	7	RC19	3	7	RD19	4	7
20	45	YEL-SLT	TA20			TB20			TC20			TD20		
	20	SLT-YEL	RA20			RB20			RC20			RD20		
21	46	VIO-BLU	TA21			TB21			TC21			TD21		
	21	BLU-VIO	RA21			RB21			RC21			RD21		
22	47	VIO-ORG	TA22	1	8	TB22	2	8	TC22	3	8	TD22	4	8
	22	ORG-VIO	RA22	1	8	RB22	2	8	RC22	3	8	RD22	4	8
23	48	VIO-GRN	TA23			TB23			TC23			TD23		
	23	GRN-VIO	RA23			RB23			RC23			RD23		
24	49	VIO-BRN	TA24			TB24			TC24			TD24		
	24	BRN-VIO	RA24			RB24			RC24			RD24		
25	50	VIO-SLT	NOT											
	25	SLT-VIO	USED											

4.11 OCTEL OVERTURE 200/300 TESTING

The Octel Overture 200/300 should always be checked for proper operation after the configuration database is installed or changes are made. In addition to the message-server test, other tests should be made before the Octel Overture 200/300 is connected. These tests are described in this section. The tests require the following equipment:

- ❑ Three touchtone telephones; label the telephones as telephone A, telephone B, and telephone C
- ❑ One terminal, directly connected to the Octel Overture 200/300, SP1 or J1, with an RS-232C cable
- ❑ One hard copy of the configuration database
- ❑ Two extensions for testing, connected to RJ11 jacks (in addition to the extension associated with the Octel Overture 200/300)
- ❑ One modular adapter, Arminger 8-position modular adapter, Part No. AA-2560A, or equivalent, is recommended

☞ These tests assume that no other calls are being made to the Octel Overture 200/300. If calls are received, the port status could become confusing and might affect the test results.

Operational Test To Verify Dial Tone on PBX Extensions

Verify that dial tone is present on each PBX extension associated with the Octel Overture 200/300, as follows:

1. Disconnect the 25-pair cables from the back of the Octel Overture 200/300.
2. Connect the modular adapter to the 25-pair cable associated with slot one.
3. Connect a touch-tone single-line telephone to the first jack position of the adapter.

☞ Only the first four jack positions of the modular adapter are used for each cable.

4. Go off-hook. Is dial tone present?

YES ➤ Continue for all extensions and cables, for each slot configured in the message server. Proceed to the test in the next section.

NO ➤ Determine the cause and correct the problem before continuing.

Extension Number Check

Verify that the PBX extension numbers match the Octel Overture 200/300 SLOTS Table, as follows:

1. Refer to the configuration database listing, specifically to the SLOTS Table.
2. Connect the telephone labeled B to the modular-adapter position associated with port 1.
3. Connect the telephones labeled A and C to the two test telephone RJ11 jacks.
4. From telephone A, enter the extension number associated with telephone B.
5. Does telephone B ring?

YES ➤ Answer the call, verify the circuit quality, and move telephone B to the next Octel Overture 200/300 RJ11. Continue the procedure until all extensions are tested, then proceed to the test in the next section.

NO ➤ Determine the cause and correct the problem before continuing.

PBX Functional Test

Verify that each Octel Overture 200/300 port extension can initiate a transfer by doing a hookswitch flash and a transfer code or just a hookswitch flash, before entering an extension number. Also, verify that you can reconnect to the caller when the extension called is not answered or busy. Perform the following steps:

1. Connect telephone B to the modular-adaptor position associated with port 1 of the Octel Overture 200/300.
2. From telephone A, call the extension number associated with telephone B.
3. Answer telephone B, and perform a hookswitch flash.
4. Does the PBX provide a stutter or solid dial tone after the hookswitch flash?
 - YES ▶ If either tone is present, continue to step 5
 - NO ▶ Stop and correct the problem before continuing.
5. Enter the transfer initiate code, if any, then enter the extension number associated with telephone C.
6. After several ringbacks, perform a hookswitch flash and reconnect code, if required, to reconnect to telephone A.
7. Did telephone C stop ringing? Were you get reconnected to telephone A, which was on hold?
 - YES ▶ Connect telephone B to the next Octel Overture 200/300 port extension and continue until the extensions for each port are tested.
 - NO ▶ Determine the cause and correct the problem before continuing.
8. Make telephone C busy by taking it off-hook. Then repeat the test, starting with step 1 and calling a busy extension instead of the ring-no-answer extension.

 The extension number connected to telephone C should start with the same first digit as those configured in the USER Table.

Test for Calls to the Intercept Extension (Attendant)

Verify that each extension can transfer a call to the intercept extension (attendant), as follows:

1. Connect telephone B to the modular-adaptor position associated with port 1 of the Octel Overture 200/300.
2. From telephone A, call the extension number associated with telephone B.
3. Answer telephone B, and perform a hookswitch flash and enter the transfer code, if required. Press (or the attendant's extension number), then hang up telephone B.
4. Did telephone A connect with the operator?
 - YES ▶ Continue test for all extensions, then proceed to the test in the next section.
 - NO ▶ Determine the cause and correct the problem before continuing.

 Some PBXs do not allow a blind (unscreened) transfer to an attendant. If this is the case, do not assign Attribute 15 — TRANSFER TO A RINGING EXTENSION, to the COS for this mailbox.

When all Octel Overture 200/300 port extensions pass these tests, proceed by connecting the 25-pair cables to the Octel Overture 200/300 and test the message server for standard operation. **The Octel Overture 200/300 must initialize each of the PBX ports. To verify that all the ports are initialized, at the @ prompt, type PS.**

All ports should return IDL.

Test for Call to a Ring-No-Answer Extension

 The extension to be called must have a valid first digit (a mailbox with this first digit must already exist in the USER Table) or be entered in the USER Table as a mailbox (mailbox number same as the extension number and a COS).

Verify that the Octel Overture 200/300 correctly handles a ring-no-answer (RNA) call.

1. From telephone A, call the extension associated with port 1.
2. Did the Octel Overture 200/300 answer with the correct company greeting (a custom greeting or the generic greeting)?
 - YES ◆ Continue.
 - NO ◆ Determine the cause and correct the problem before continuing.
3. Enter the extension number for telephone C.
4. Did the Octel Overture 200/300 respond with the prompt: “*Thank you, just a moment . . .*” (Primary Answer Mode example)?
 - YES ◆ Continue.
 - NO ◆ Determine the cause and correct the problem before continuing.
5. After a predetermined interval (defined by the entry in the INFORMATION Table for ringbacks before no answer), does the message server reconnect and speak the prompt “*Extension XXX doesn’t answer. Please leave a message at the tone, or enter another extension number, or press zero for assistance*”?

 If the mailbox has not been entered in the USER Table, the Octel Overture 200/300 does not offer to take a message.

- YES ◆ Press , then hang up.
 - NO ◆ Determine the cause and correct the problem before continuing.
6. Repeat the test for each Octel Overture 200/300 port.

Test for Calls to a Busy Extension

Verify that the Octel Overture 200/300 properly handles a call directed to a busy extension.

1. From telephone A, call the extension associated with port 1.
2. Did the Octel Overture 200/300 answer with the correct company greeting?
 - YES ◆ Continue.
 - NO ◆ Determine the cause and correct the problem before continuing.

3. Make sure that telephone C is busy by taking it off-hook. Enter the extension number for telephone C.
4. Did the Octel Overture 200/300 respond with the prompt *“Thank you, just a moment . . .”* (primary answer mode example)?
 - YES ◆ Continue.
 - NO ◆ Determine the cause and correct the problem before continuing.
5. After a short interval, does the message server reconnect and speak the prompt *“Extension XXX is busy. Please leave a message at the tone, or enter another extension number, or press zero for assistance”*?
 - YES ◆ Press , then hang up.
 - NO ◆ Determine the cause and correct the problem before continuing.
6. Repeat the test for each Octel Overture 200/300 port.

Hunt Group Operation Test

Verify the hunting sequence, as follows:

 The terminal command `PS` displays the current status of each Octel Overture 200/300 port. A three-character abbreviation denotes the state of each port. Refer to the Maintenance Commands chapter for more information about using the `PS` command and the meaning of the states.

1. From the system level `@` prompt, enter `PS`.
2. Does the port status show the `IDL` state for all positions? If not, determine the cause and correct the problem before continuing.
 - a. Some ports may be in the `TST` (test) state momentarily, because of online diagnostics. If a port is in the `TST` state, enter `PS` several times, before deciding whether the port is in trouble or self-test is running. Self-test runs every 5 minutes; if a problem is encountered, it is entered in the Hardware Error Table.
 - b. If other calls are being made into the Octel Overture 200/300, all ports might not be idle. If they are not all idle, check to see whether anyone else is calling.

If the terminal is connected remotely, one of the ports shows the modem as `MOD`.

3. From telephone A, enter the extension number or access code associated with the Octel Overture 200/300 hunt group.
4. Does the Octel Overture 200/300 answer correctly? If not, determine the cause and correct the problem before continuing.
5. From the terminal, enter `PS`.

 The port status should show the port in `WFD` (wait for digits) state when an incoming call is answered.

6. Did the correct port answer, based upon how the PBX is programmed for hunting groups?
 - YES ◆ Continue.
 - NO ◆ Determine the cause and correct the problem before continuing.
7. From telephone A, press and hang up after the message server says *“good-bye.”*

8. Busy out the PBX extension identified in step 6 above.
9. Continue the process from step 3 until all ports have been busied out.

Testing Fail-Safe Operation

The fail-safe port operation test comprises the all-ports-busy condition and the ring-no-answer condition.

All Ports Busy

Perform the following steps for the all-ports-busy test:

1. While all ports are busied out, use telephone A to enter the extension number or access code of the hunt group.
2. Does the call overflow to the correct answering extension as determined for fail-safe operation?
 - YES ➤ Continue.
 - NO ➤ Determine the cause and correct the problem before continuing.

 Some PBXs might not support hunt-group overflow; in which case, the caller could experience a ring no-answer condition until a port is available to accept the call.
3. Remove the busy condition from all Octel Overture 200/300 port PBX extensions.

Port Ring-No-Answer

Perform the following steps for the port ring-no-answer test:

1. Disconnect the 25-pair cables associated with the Octel Overture 200/300.
2. From telephone A, enter the hunt-group extension number or access code associated with the extensions connected to the Octel Overture 200/300.
3. Is the call diverted to the correct alternate answer point when the Octel Overture 200/300 does not answer?
 - YES ➤ Continue.
 - NO ➤ Determine the cause and correct the problem before continuing.
4. Reconnect the modular line cords.
5. From the terminal, enter `TE C 1`. The Octel Overture 200/300 should respond, showing that each port is forwarded until all ports have been forwarded.
6. Enter `PS` to verify that all ports are in the FWD (forwarded) state.
7. From telephone A, enter the hunt-group extension number or access code.
8. Is the call forwarded to the correct position as specified in the call forwarding string (System Parameter 45 — SYSTEM RELOAD FORWARD STRING)?
 - YES ➤ Continue.
 - NO ➤ Determine the cause and correct before continuing.
9. From the terminal, enter `TE C 2` to cancel call forwarding. The Octel Overture 200/300 should respond with `ALL PORTS INITIALIZED`.

10. From telephone A, enter the hunt-group extension number or access code.
11. Does the Octel Overture 200/300 answer correctly?
 - YES ▶ Continue.
 - NO ▶ Determine the cause and correct before continuing.
12. Enter PS at the terminal.
13. Verify that all ports are in the IDL state and that the cancel forwarding string (System Parameter 46 — SYSTEM RELOAD CANCEL FORWARD STRING) is correct. If any ports still show FWD, use TE C 2 x, where x is the port number, to cancel forwarding. If cancel forwarding does not work, determine the cause and correct it before continuing.

Test to Verify Trunk To Octel Overture 200/300 Operation

1. From the terminal, enter the PS command.
2. Does the port status show all ports in the IDL state?
 - YES ▶ Continue.
 - NO ▶ Determine the cause and correct the problem before continuing.
3. From telephone A, call outside the PBX and back in on trunks dedicated to the hunt group.
4. Does the Octel Overture 200/300 answer correctly?
 - YES ▶ Continue.
 - NO ▶ Determine the cause and correct the problem before continuing.
5. From the terminal, enter the PS command.
6. Does the port that answered show WFD state?
 - YES ▶ Continue.
 - NO ▶ Determine the cause and correct the problem before continuing.
7. From telephone A, enter the extension number associated with telephone C. The Octel Overture 200/300 responds with “*Thank you, just a moment.*”
8. Does telephone C ring?
 - YES ▶ Continue.
 - NO ▶ Determine the cause and correct the problem before continuing.
9. Enter the PS command. Port status should show port 1 in the AIC (assisted incoming call/automated attendant) state.
10. Answer telephone C. Does the Octel Overture 200/300 say “*Beep, beep, beep...Connecting*” and transfer the incoming trunk to telephone C?
 - YES ▶ Continue.
 - NO ▶ Determine the cause and correct the problem before continuing.
11. From the terminal, enter the PS command, and verify that the port state is IDL.
12. Busy-out the port that answered.

13. Repeat the procedure from step 3 for all ports, until all ports are busied out. Verify that calls can be placed through the Octel Overture 200/300 from each port.
14. From telephone A, call out and back in on a trunk dedicated to the hunt group.
15. Does the call overflow to the correct destination?
 - YES ◆ Continue.
 - NO ◆ Determine the cause and correct the problem before continuing.

☞ Some PBXs might not support overflow, in which case a ring-no-answer condition could be encountered.
16. Remove the busy condition from all Octel Overture 200/300 port extensions.
17. Repeat steps 3 through 13 except call an extension that does not answer, and then repeat it by calling a busy extension.

Test to Verify Trunks

1. From telephone A, call outside the PBX and back in on the first trunk dedicated to the Octel Overture 200/300.
2. Does the Octel Overture 200/300 answer correctly?
 - YES ◆ Continue.
 - NO ◆ Determine the cause and correct the problem before continuing.
3. Repeat the procedure from step 1 for each trunk, until all hunts have been tested. Verify that each trunk is answered by the Octel Overture 200/300 with the correct greeting.

☞ Toll-free service lines can be tested individually, even if they are bands from other areas, by using the “plant test” number. Get these from the PE (Public Exchange) if you do not know them.

Test for Calls to the Intercept Extension

Verify that the Octel Overture 200/300 can transfer a call to the intercept position (attendant) when the caller does nothing or presses , as follows:

1. From telephone A, call the extension associated with port 1.
2. Does the Octel Overture 200/300 answer correctly?
 - YES ◆ Continue.
 - NO ◆ Determine the cause and correct the problem before continuing.
3. Listen to the complete company greeting. Do nothing, let the Octel Overture 200/300 time out, and transfer the call to the attendant (do not enter any digits).
4. Did you reach the attendant?
 - YES ◆ Continue for all ports.
 - NO ◆ Determine the cause and correct the problem before continuing.
5. Repeat the procedure except press instead of waiting for a timeout.

6. From telephone A, call out and back in on a trunk dedicated to the hunt group. When the Octel Overture 200/300 answers, let the message server time out.
7. Does the Octel Overture 200/300 transfer the call to the intercept position?
 - YES ▶ Continue.
 - NO ▶ Determine the cause and correct the problem before continuing.

Message Waiting Test

1. From telephone A, call out and back in on a trunk dedicated to a Octel Overture 200/300 port.
2. Does the Octel Overture 200/300 answer correctly?
 - YES ▶ Continue.
 - NO ▶ Determine the cause and correct the problem before continuing.
3. Make sure that telephone C is busy, by taking it off-hook. Enter the extension number associated with telephone C.
4. After a predetermined interval, the Octel Overture 200/300 should reconnect, and at telephone A you should hear, *“Extension XXX is busy. Please leave a message at the tone, or enter another extension number, or press zero for assistance.”*
5. Leave a test message for telephone C.
 - ☞ A message is not delivered to a mailbox unless it is at least 4.5 seconds long. The mailbox must be entered in the USER Table for the Octel Overture 200/300 to offer to take a message.
6. The Octel Overture 200/300 should now initiate a message-waiting-notification call (ASAP message waiting) to the extension associated with telephone C.
 - ☞ If all ports are allowed to make outcalls, the call is not attempted when three-fourths or more of the ports are being used. Also, for message waiting, INFORMATION Table Index 12 — MESSAGE WAITING NOTIFICATION, must be set to Y.
7. Does the Octel Overture 200/300 call the extension associated with telephone C?
 - YES ▶ Continue.
 - NO ▶ Determine the cause and correct the problem before continuing.
8. Answer telephone C. The Octel Overture 200/300 should respond with *“Extension XXX has X messages. Ready,”* or *“Extension XXX has X messages. Please enter your security code.”*
9. Enter the security code, if asked, and press **5** to Listen to the test message.
10. Does the message sound clear?
 - YES ▶ Continue.
 - NO ▶ Determine the cause and correct the problem before continuing.
11. Press **3** to Erase the message, then press **9** to exit the mailbox. Does the Octel Overture 200/300 respond with *“X messages will be erased”* ?
 - YES ▶ Press **9** to exit the message server. The Octel Overture 200/300 should respond with *“good-bye.”*
 - NO ▶ Determine the cause and correct the problem.

4.12 TESTING THE INSTALLATION AND TELEPHONE CHANGES

Use the following checklist to help track any installation and telephone changes, as follows:

- Use the “See Chapter” column for reference to the appropriate chapter in the *Installation and Maintenance* volume for further information.
- Enter the name of the person who is responsible for tracking an installation task in the “Person Responsible” column.
- Enter the date the installation task is to be completed in the “Scheduled” column.
- Enter the final completion date in the “Completed” column.

Installation Task	See Chapter	Person Responsible	Scheduled	Completed
<p>Receiving the Equipment</p> <p>___ Inspect for damage</p> <p> ___ Carton</p> <p> ___ Server</p> <p> ___ ac/dc cables secure</p> <p> ___ Printed circuit cards</p> <p>___ Reshipping procedures</p>	Installation			
<p>Preinstallation</p> <p>___ Environment</p> <p> ___ Dust free (Y/N)</p> <p> ___ Away from large motors (Y/N)</p> <p> ___ Server accessible (Y/N)</p> <p>___ Power</p> <p> ___ Dedicated fuse or breaker</p> <p> ___ Dedicated 115-Vac 60-Hz receptacle</p> <p>___ Other required equipment available</p> <p> ___ Modular line cord</p> <p> ___ RJ11 jacks or equivalent</p> <p> ___ CAT or other ASCII terminal</p> <p> ___ Phillips screwdriver</p> <p> ___ RS-232C interface cable</p>	Installation			

Installation Task	See Chapter	Person Responsible	Scheduled	Completed
<p>PBX Preparation</p> <p><input type="checkbox"/> Survey telephone system (Y/N)</p> <p><input type="checkbox"/> Additional touch-tone extensions (as required)</p> <p><input type="checkbox"/> Install and label the Octel Overture 200/300 ports</p> <p><input type="checkbox"/> PBX COS changes for the Octel Overture 200/300 port extensions</p> <p><input type="checkbox"/> Forwarding</p> <p><input type="checkbox"/> Off-site calls, no call restriction</p> <p><input type="checkbox"/> Remove call waiting features</p> <p><input type="checkbox"/> Permitted to transfer, hold, reconnect</p> <p>Overflow for RNA/busy</p> <p><input type="checkbox"/> Hunt Group 1</p> <p><input type="checkbox"/> Hunt Group 2</p> <p><input type="checkbox"/> Hunt Group 3</p>	Preparing the Phone System			
<p>Hardware Installation</p> <p><input type="checkbox"/> Communicating with the message server</p> <p><input type="checkbox"/> Octel Overture 200/300 installation</p> <p><input type="checkbox"/> Configuration installation</p> <p><input type="checkbox"/> Connecting the PBX to the Octel Overture 200/300</p>	Installation			
<p>Testing</p> <p><input type="checkbox"/> Tools and equipment</p> <p><input type="checkbox"/> Three touch-tone single line telephones</p> <p><input type="checkbox"/> CAT or other ASCII terminal and teleprinter</p> <p><input type="checkbox"/> Database hardcopy</p> <p><input type="checkbox"/> Two test extensions</p>	Installation			

Installation Task	See Chapter	Person Responsible	Scheduled	Completed
<p>Pass/Fail Tests</p> <p>Step Description</p> <p>___ 1. Pre-operation test of message server</p> <p>___ 2. Extension number check</p> <p>___ 3. PBX function</p> <p>___ 4. Call to intercept/attendant PBX</p> <p>___ 5. Ring-no-answer extension</p> <p>___ 6. Busy extension</p> <p>___ 7. Hunt Group operation</p> <p>___ 8. Fail-safe operation</p> <p>___ 9. Trunk to the Octel Overture 200/300 operation</p> <p>___ 10. Verifying trunks</p> <p>___ 11. Intercept extension (the Octel Overture 200/300)</p> <p>___ 12. Message waiting</p>	<p>Installation</p>			
<p>Trunks</p> <p>___ Quantity to the Octel Overture 200/300</p> <p> Dedicate to hunt group(s)</p> <p> ___ Group 1</p> <p> ___ Group 2</p> <p> ___ Group 3</p> <p>___ No extension restriction, if applicable</p> <p>___ Trunk-to-trunk capability (Y/N)</p> <p>___ Trunk queuing (Y/N)</p> <p> ___ incoming only</p> <p> ___ two-way</p> <p>___ Central Office changes</p> <p>___ Hunt Group</p> <p> ___ contains the Octel Overture 200/300 extension</p> <p> ___ circular hunting</p> <p> ___ overflow (Y/N)</p> <p> ___ trunks dedicated (circle one)</p> <p> DDC, UCD, DIL, Dedicated</p>	<p>Preparing The Phone System</p>			

5

REPORTS

Chapter Contents

5.1	Overview	5-1
5.2	Listing and Clearing Reports	5-2
	Listing a Report	5-2
	Listing User Statistics (Selections 3 or 4)	5-3
	Clearing a Report	5-4
5.3	System Performance Report	5-5
	Call Summary	5-7
	Message Summary	5-11
	Digital Network Performance Report	5-13
5.4	Network Traffic Report	5-16
	To Location	5-17
	Message Delivery	5-17
	Names Directory	5-18
	Network Access Totals	5-18
	Feature Use Totals	5-18
	Digital Network Traffic Report	5-19
5.5	User Message Statistics	5-21
	Messaging Statistics	5-21
5.6	User Calling Statistics	5-23
	Call Processing Statistics	5-23
5.7	Disk Usage Report	5-25
	Total System Message Storage	5-25
	Total of Minutes	5-26
	Storage Capacity Based on Message Type	5-26
5.8	Port Statistics	5-27
	Individual Port Statistics	5-29
	Port Group Statistics	5-29
	All Port Statistics	5-30
5.9	Mailbox Usage	5-31
5.10	User Status Detail	5-32
5.11	Integration Calling Statistics	5-33
5.12	System Performance by COS	5-35
	Caller's Initial Action	5-35
	Subsequent Actions	5-37

Quick Reference Guide

Reports

	Command	Additional Information
List Report	@L R	Shows reports that can be listed. Individual reports are shown below. System Parameter 72 determines maximum lines per page for reports.
Clear Report	@C R	Produces a listing of reports that can be cleared. Options are: 1=System Performance and Port Statistic 2=Network Traffic 3=User Call and Message Statistics. The following reports are cleared: User Message, User Calling and Mailbox Usage, User Status Detail, and Integration Calling Statistics
INDIVIDUAL REPORTS		
System Performance	1	When clearing this report, the Traffic Peg Count Table is set to zero. The Port Statistics are cleared as well. Information pertains to incoming calls, subsequent actions, progress of calls, and mailbox information.
	1 D	Lists the Digital Network Performance Report.
Network Traffic	2	For collocated and networked message servers. Information pertains to route statistics, message delivery, network access totals, and feature use.
	2 D	Lists the Network Traffic Report for digital information only.
User Message Statistics	3	Includes current messages, messages left after various conditions, logon, and date cleared.
User Calling Statistics	4	Includes incoming calls, subsequent calls, calls abandoned, and date cleared.
Disk Usage	5	Provides statistics about the amount of voice and fax message storage currently used on the message server.
Port Statistics	6	Information pertains to individual, group, fax channel information, and all port statistics. This report is cleared when the System Performance report is cleared.

Quick Reference Guide

Reports

	Command	Additional Information
Mailbox Usage	7	Shows mailbox usage time. Usage includes logon time and access time.
User Status Detail	8	Shows status information on mailbox access and time durations associated with individual mailbox usage.
Integration Calling Statistics	9	Shows information about the type of non-integrated or integrated calls a mailbox receives.
System Performance by COS	10	Provides call and message statistics for ports/trunks by COS.

5.1 OVERVIEW

Reports provide statistics on the operation and usage of the Octel Overture™ 200/300 message server and give owners the ability to monitor various operational aspects of the Octel Overture 200/300. Reports may be accessed at any time through the system's administration terminal.

The Octel Overture 200/300 offers reports that provide both system-wide and mailbox statistics. Information is collected and stored for ten reports.

1. System Performance
2. Network Traffic
3. User Message Statistics
4. User Calling Statistics
5. Disk Usage
6. Port Statistics
7. Mailbox Usage
8. User Status Detail
9. Integration Calling Statistics
10. System Performance by COS

5.2 LISTING AND CLEARING REPORTS

Information is collected and stored in various internal tables. The information accumulates until the report is cleared. Reports can be listed without affecting the accumulated data. Once the command to clear a report is entered, the values are reset to zero and resume accumulating.

Most reports show only the date they are run. At the top of reports 1, 2, 6 and 10 are two dates. The “from” date and time indicate when the table was last cleared. The “to” date and time indicate when the report was last printed. It is recommended that reports be listed and cleared on a regular basis. The reports can display individual values up to 65535.

- ☞ Beginning with Serenade Release 3.0, the following reports can display individual values up to 999,999.
- System Performance
 - Digital Network Performance
 - Network Traffic
 - Digital Network Activity
 - Disk Usage
 - Port Statistics
 - Integration Calling Statistics
 - System Performance by COS

For a report showing the attributes associated with the COS Table, SCHEDULE Table, and all INFORMATION Tables defined in the SCHEDULE Table, refer to the *Configuration* volume, COS chapter, Using UPDATE chapter, for the LIST PROFILE command.

- ☞ This chapter describes all reports except the DID/E&M Trunk Interface report, which is detailed in *DID/E&M Trunk Interface Installation and Maintenance Manual*. For information about Direct Access Cards, refer to the *Direct Access Card (DAC) Installation and Maintenance Manual*.

Listing a Report

Reports are printed by selecting from the LIST REPORT menu. At the prompt @ enter

LIST REPORT, or L R

@LR

1. SYSTEM PERFORMANCE.
2. NETWORK TRAFFIC.
3. USER MESSAGE STATISTICS.
4. USER CALLING STATISTICS.
5. DISK USAGE.
6. PORT STATISTICS.
7. MAILBOX USAGE.
8. USER STATUS DETAIL.
9. INTEGRATION CALLING STATISTICS.
10. SYSTEM PERFORMANCE BY COS.

SELECT REPORT TO BE LISTED. (1 - 10, EMPTY LINE = EXIT)
:

Select the number of the report you wish to list.

Enter L R # (report number), to designate a specific report before the menu is displayed.

The prompts displayed after selecting a specific report (i.e., 1–0) vary slightly as shown in the following sections. These reports can be printed. Before each reported is displayed, the message server prompts "READY PRINTER, THEN PRESS RETURN."

Digital Network Reports

The System Performance report, 1, and the Network Traffic report, 2, also print information about digital networking. To print digital information for either report, after entering the report number, enter D. For example, to list digital network information for the System Performance report, at the : prompt, enter

```
:1 D
```

If only 1 is entered for the System Performance report, the report does not include any digital networking information. The digital networking System Performance report is printed **only** when 1 D is entered. If only 2 is entered for the Network Traffic report, the report includes all networking information. Enter 2 D to get information only about digital networking.

Listing User Statistics (Selections 3 or 4)

Once a User Statistics, Mailbox Usage, or User Status Detail report has been selected, the following prompt displays:

```
ENTER DIGIT PATTERN ("?" FOR HELP):
CHECKING USER MAILBOXES...DONE.
READY PRINTER, THEN PRESS RETURN...
```

If ? is entered for help, the following prompt displays:

```
Enter one of the following to select one or more mailboxes:

"ALL"          -      ALL MAILBOXES.
1-8 DIGITS     -      ONLY MAILBOXES BEGINNING WITH THIS DIGIT PATTERN.
EMPTY LINE     -      ABORT WITHOUT ACTION.
```

If 1–8 digits are entered, the list displays the mailboxes beginning with the digit(s) entered. In this example the first digit is 5 and mailboxes are three digits long:

<u>Entered Digits</u>	<u>Mailboxes Displayed</u>
5	All mailboxes beginning with 5
56	All mailboxes beginning with 56
567	Only mailbox 567

User Statistics, Mailbox Usage, and User Status Detail reports are sorted by first digit. For example, if mailboxes in the 2000 and 300 series are used, 2000 lists first.

If an invalid number is entered, the program displays the prompt:

```
"NO MATCH ON DIGIT PATTERN."
```

Clearing a Report

To clear reports, at the @ prompt type

```
CLEAR REPORT, or C R
```

```
@C R
```

After this command is entered, following prompt displays:

```
1. SYSTEM PERFORMANCE (IN TRAFFIC PEGS) AND PORT STATISTICS.
2. NETWORK TRAFFIC.
3. USER MESSAGE, USER CALLING AND MAILBOX USAGE.

SELECT REPORT TO BE CLEARED.(1 - 3, EMPTY LINE = EXIT)
:
```

Select the number of the report type you wish to clear. The prompts displayed after selecting a report type are specific to that report type.

When option 1 — System Performance and Port Statistics, is chosen, the following reports are cleared:

- System Performance
- System Performance by COS report
- Digital Network Performance Report
- Port Statistics

When option 3 — User Call and Message Statistics, is chosen, the following reports are cleared:

- User Message Statistics
- User Calling Statistics
- Mailbox Usage
- User Status Detail
- Integration Calling Statistics

The Disk Usage report cannot be cleared. It always reflects current information.

5.3 SYSTEM PERFORMANCE REPORT

- ◆ 1. SYSTEM PERFORMANCE.
- 2. NETWORK TRAFFIC.
- 3. USER MESSAGE STATISTICS.
- 4. USER CALLING STATISTICS.
- 5. DISK USAGE.
- 6. PORT STATISTICS.
- 7. MAILBOX USAGE.
- 8. USER STATUS DETAIL.
- 9. INTEGRATION CALLING STATISTICS.
- 10 SYSTEM PERFORMANCE BY COS.

The System Performance report provides system-wide call and message statistics. It details the number of calls to busy and not answered extensions, calls to attendant/intercept positions, and messages left under various conditions.

Individual call and message statistics are displayed in the User reports.

☞ The System Performance report is based upon the Traffic Peg Count Table. Refer to the System Errors and Traffic Peg chapter for traffic peg details.

Clearing the System Performance report clears the traffic peg counts and vice versa. If you want both the System Performance report and the traffic pegs, list both before clearing.

An example of a System Performance report is shown on the next page.

---- SYSTEM PERFORMANCE REPORT FOR (SYSTEM NAME) ----

FROM: MM/DD HH:MM A.M. YYYY
 TO: MM/DD HH:MM P.M. YYYY PAGE 1 OF 1

 * INCOMING CALL SUMMARY *

 CALLER'S INITIAL ACTION:

DIALED EXTENSION OR DIGITS	764
DEFAULTED TO ASSISTANCE	136
DIALED "0" FOR ASSISTANCE	59
LEFT A MESSAGE AT THE TONE	0
PRESSED "#" TO LOG-ON	955
"*" TO MAKE A QUICK MESSAGE	12
CALLER WAS A NETWORK UNIT	1099
CALLER WAS A DID/E&M UNIT	0
OTHER	7
TOTAL CALLS INTO SYSTEM	3032

SUBSEQUENT ACTIONS:

DIALED EXTENSION OR DIGITS	445
SENT TO ASSISTANCE	3
DIALED "0" FOR ASSISTANCE	117
LEFT A MESSAGE AT THE TONE	370
PRESSED "#" TO LOG-ON	243
"*" TO MAKE A QUICK MESSAGE	4
TRANSFERRED CALL TO NETWORK	111

PROGRESS OF CALLS TO EXTENSIONS:

ANSWERED	459
RING-NO-ANSWER	104
BUSY	153
GREETING PLAYED (NO CALL)	784
VACANT NUMBER	24

 TOTAL TO EXTENSIONS 1524

NUMBER OF TIMES USERS LOGGED-ON:	1249
NUMBER OF USER MAILBOXES:	30
NUMBER OF NON-VOICE MAILBOXES:	10
NUMBER OF PORTS CONFIGURED:	4
ALL PORTS BUSY (SECONDS):	0

 * MESSAGE SUMMARY *

 MESSAGES CREATED:

AFTER BUSY OR NO-ANSWER	83
AFTER GREETING PLAYED	287
RECEIVED FROM NETWORK	976
BY QUICK-MESSAGE	14
BY LOGGED-ON USERS	632
TOTAL MESSAGES CREATED	1992

MESSAGES CURRENTLY STORED:

GREETING MESSAGES	14
NAME MESSAGES	8
USER MESSAGES	68
TOTAL MESSAGES STORED	90

DISK USAGE:

AVG. USER MESSAGE LENGTH (MINUTES)	0.7
STORAGE CURRENTLY USED	37%
APPROXIMATE MINUTES OF AUTHORIZED STORAGE	250
APPROXIMATE MINUTES OF EQUIPPED STORAGE	150

Call Summary

The Call Summary portion of the System Performance report shows the stages of calls and actions of callers into the Octel Overture 200/300. The calls include the following:

- Callers attempting to reach extensions.
- People calling into mailboxes.
- Other calls answered (such as calls from other network locations and calls from the DID Interface).

Information is reported in three stages:

- Caller's initial action.
- Caller's subsequent actions.
- Progress of calls to extensions.

The following sections describe the activities reported within each of the three stages. Also included are the traffic peg(s) used as the source for each field.

Caller's Initial Action

This section displays callers' initial action upon reaching the Octel Overture 200/300. If a category relates to a traffic peg, the peg is indicated in parentheses.

An integrated call that has generated a call record, pegs under Caller's Initial Action, Dialed Extension or Digits. The call record is considered the initial action taken.

DIALED EXTENSION OR DIGITS (Peg 129)

This category can include

- Number of times callers dialed a defined first digit from 1–8.
- Number of times callers were sent directly to Next Mailbox without dialing.
- Number of times callers dialed an account code.
- Number of times callers dialed extensions or digits to call out on the network.
- With Integration
 - Call forwarded calls with call record
 - Direct internal call to the Octel Overture 200/300 with call record
 - Forwarded call to the Octel Overture 200/300 with call record
 - Direct external call to the Octel Overture 200/300 with call record

DEFAULTED TO ASSISTANCE (Peg 138)

Number of times callers did nothing (e.g., rotary dial) and were transferred to attendant or intercept position.

- If the call is integrated with a call record, default to assistance is pegged under Subsequent Actions.

DIALED FOR ASSISTANCE
(Peg 128)

Number of times callers pressed and were transferred to attendant or intercept position.

 If the call is integrated with a call record, pressing for assistance is pegged under Subsequent Actions.

LEFT A MESSAGE AT THE TONE
(Peg 140)

Number of times callers left a message as an initial action. This also includes instances where Next Mailbox gives the caller a greeting and takes a message without the caller entering any digits.

PRESSED TO LOG ON
(Peg 131)

Number of times callers pressed to enter a mailbox (includes successful and unsuccessful logons).

 If the call is integrated with a call record, logon is pegged under Subsequent Actions.

TO MAKE A QUICK MESSAGE
(Peg 133)

Number of times callers pressed to make a Quick Message.

CALLER WAS A NETWORK UNIT
(Peg 135)

Number of times caller identified itself as a Network system. That is, the call was from another network location.

CALLER WAS A DID/E&M UNIT
(PEG 136)

Number of times caller identified itself as a DID/E&M system. That is, the call was intercepted by the Octel Overture 200/300 DID/E&M Interface.

OTHER

Miscellaneous category including

- Caller dialed .
- A Octel Overture 200/300 port called a CX port (extension forwarded to the Octel Overture 200/300).
- Caller dialed invalid first digit (e.g.,).
- Caller disconnected (detected hang-up events or from DID Interface).
- Caller has not taken initial action.
- With Adaptive Integration
 - Direct call into the Octel Overture 200/300 where caller hung up or pressed .
 - Direct internal call into the Octel Overture 200/300 where caller accessed Quick Greeting Activation.

 Numbers within the Other category may fluctuate as new calls come in and as current callers make an initial action. If Total Calls into the message server reaches the maximum value (65,535), this field contains ***. The Other category is calculated by subtracting all Initial Calls from Total Calls into System. If the subtraction results in a negative number, Other is ***.

TOTAL CALLS INTO SYSTEM
(Peg 1)

Total calls answered by the Octel Overture 200/300.

-  If the System Performance report or traffic pegs were last cleared while calls were in progress, this value may be larger than peg 1. However, the value printed in the System Performance report always reflects the correct value.

Subsequent Actions

After completing the initial action, (i.e., caller left a message at the tone), another action is taken. Subsequent actions are described below.

DIALED EXTENSION OR DIGITS
(Peg 130)

This category can include

- Number of times callers dialed a defined first digit from 1 to 8.
- Number of times callers went to Next Mailbox.
- Number of times callers dialed an extension or digit to stay in queue.
- Number of times a direct internal caller dialed an extension or digit.

SENT TO ASSISTANCE
(Peg 139)

This category can include

- Number of times callers were transferred to attendant or intercept position after dialing too many invalid extensions.
- Number of callers that remain on the line for assistance, whether or not a message was left when System Parameter 77 — PBX PROVIDES MOMENTARY DISCONNECT, is set to YES. (Adaptive Integration)
- Calls intercepted by DID or E&M Interface Modules that defaulted to assistance, whether or not a message was left.
- Number of network calls sent to assistance.
- Autotransfer to assistance (includes Personal Assistant).

DIALED FOR ASSISTANCE
(Peg 128)

Number of times callers pressed and were transferred to attendant/intercept position or Personal Assistant.

LEFT A MESSAGE AT THE TONE
(Peg 141)

Number of times callers left message after busy/no answer/greeting.

PRESSED TO LOG ON
(Peg 132)

Number of times callers pressed to enter a mailbox (includes successful and unsuccessful logons).

With Adaptive Integration, the number of times a direct internal caller pressed to logon.

PRESSED TO MAKE A QUICK MESSAGE
(Peg 134)

Number of times callers pressed to make a Quick Message.

TRANSFERRED CALL TO NETWORK (Peg 137) Number of times callers transferred out onto the network.

Progress of Calls to Extensions

If the initial or subsequent action taken by the caller requires the Octel Overture 200/300 to place a call, responses to that call are detailed below. Also included is the number of logon requests that were successfully completed.

ANSWERED
(Peg 46)

This category can include

- Number of answered calls.
- With Adaptive Integration, COS Attribute 15 — TRANSFER TO A RINGING EXTENSION, pegs as ANSWERED when the call is transferred.

RING-NO-ANSWER
(Peg 35)

Number of calls placed that were not answered, including:

- Number of normal calls to an extension resulting in ring-no-answer, including first caller to a FIFO queue extension.
- Number of DID calls that intercepted on ring-no-answer.
- Number of PBX integration calls that forwarded on ring-no-answer. (This applies to PBXs that provide information on why the call forwarded. Northern Telecom SL-1 and ROLM switches **do not** provide this information.)
- Number of times the Octel Overture 200/300 attempted to place a call but did not get dial tone at the port.

BUSY
(Peg134)

Number of calls placed to busy extensions, including

- Number of normal calls to a busy extension, including first caller to a FIFO queue extension.
- Number of DID calls that intercepted on busy.
- Number of PBX integration calls that forwarded on busy. (This applies to PBXs that provide information on why the call forwarded. Northern Telecom SL-1 switches **do not** provide this information.)

GREETING PLAYED (NO CALL)
(Pegs 144, 39, 98, and 162)

- Number of times a personal mailbox greeting was played and no call was placed (normal greeting operation). Also included in this category are calls to unavailable extensions, and calls to extensions that forward back to a Secondary Answering mode port and integration calls where a call record indicates an “all forward” condition.
- Number of times an Extended Absence Greeting is played to an external caller.
- Number of times OctelForms™ scripted prompt greeting mailbox was called (without COS Attribute 6 — CALL FIRST BEFORE PLAYING GREETING).
- Number of times a valid account code was entered.

- Number of times callers with FIFO queue position of two or greater dialed digits to enter or stay in queue, or when maximum queuing limit was reached, before going to Next Mailbox.
- Number of times error greeting (Custom Prompt) played.
- Number of times DID calls were intercepted immediately.
- Number of PBX integration calls that forwarded on the All Forward condition, or from PBXs which do not provide information on why the call forwarded.

VACANT NUMBER (Peg 38) Number of calls placed by the Octel Overture 200/300 to vacant number (fast busy).

TOTAL TO EXTENSIONS (Peg 46, 34, 35, 38, 39, 98, 144, and 162) Total calls placed to extensions by the Octel Overture 200/300.

NUMBER OF TIMES USERS LOGGED ON (Peg 9) Number of times a mailbox was successfully logged onto.

NUMBER OF USER MAILBOXES Number of mailboxes in the USER Table.

NUMBER OF PORTS CONFIGURED Number of ports configured.

ALL PORTS BUSY (SECONDS) (Peg 24) Number of seconds during which all the ports were busy and therefore unavailable.

Message Summary

The Message Summary section details the number of messages created and on what conditions, number of messages currently stored, and disk usage.

Totals for stored messages include disk space used for storing a forwarded message and all comments attached to it.

 Messages are only stored once and addressed to mailboxes as required. Therefore, User Statistics for messages do not equal total storage used or remaining for system statistics. Personal greetings and names are not included for individual mailboxes in the User Messaging report; they are included in the System Summary report.

A description of the Message Summary fields follows.

Messages Created

Messages may be created by callers responding to prompts or by mailbox owners using messaging features. The following summarizes both types.

AFTER BUSY OR NO-ANSWER (Peg 14) Number of messages left after call to an extension received busy or no answer.

AFTER GREETING PLAYED (Peg 142)	Number of messages left after greeting played.
RECEIVED FROM NETWORK (Peg 143)	Number of valid messages received from network.
BY QUICK MESSAGE (Peg 2)	Number of times a Quick Message was left.
BY LOGGED-ON USERS	Number of messages sent from mailboxes.
TOTAL MESSAGES CREATED	Number of valid voice messages created.

Messages Currently Stored

Messages are generally created by callers or by mailbox owners. Recorded names and greetings created using the Insert/Swap feature are also considered to be messages. System totals for each of these categories are reflected below.

GREETING MESSAGES	Number of greeting messages currently stored in mailboxes.
NAME MESSAGES	Number of name messages currently stored in mailboxes.
USER MESSAGES	Number of messages currently stored. All messages in mailboxes are counted, except multiple copies. When a message is delivered to several mailboxes, it is counted only once.
TOTAL MESSAGES STORED	Sum of greeting, name, and user messages.

Disk Usage

The following provides information about the total disk storage and the percentage of that storage currently utilized.

AVG. USER MESSAGE LENGTH	Average length in minutes of the messages currently stored. (Minutes divided by number of messages.)
STORAGE CURRENTLY USED	Percentage of total storage currently used.
APPROXIMATE MINUTES OF AUTHORIZED STORAGE	Maximum minutes of message storage that is authorized. This number is derived from the total of all voice hours on non-COD drives and authorized hours on COD drives.
APPROXIMATE MINUTES OF EQUIPPED STORAGE	Maximum minutes of message storage that would be available if no voice messages (names, greetings, or messages) are stored. This number is derived from the total of all voice hours on non-COD drives and equipped hours on the COD drives.

 The approximate minutes equipped may not match the approximate minutes authorized if the message server has not been restarted since additional COD hours were purchased.

The exact minutes of storage may vary due to factors including

- The disk itself.
- Manufacturer of the disk.
- Accumulated bad sectors on the disk.
- Single or dual-drive system. For message servers with more than two drives of different sizes, Hot Standby may consume additional space on the smaller of two drives, resulting in a loss of capacity for the rated hours of storage. Refer to the *Feature Description* volume, Hard Disk Redundancy chapter, for information about Hot Standby.

Digital Network Performance Report

The Digital Network Performance Report tracks the performance of the LAN card on a message server. It provides a measure of the messaging traffic across the digital network and the allocation of the LAN channel resources for the messaging traffic across the digital network. It is accessed as an extension of the System Performance Report.

To access the Digital Network Performance Report, at the @ prompt, enter

L R

The LIST REPORT menu appears. At the bottom of the menu, enter 1 D, as in the following.

```
SELECT REPORT TO BE LISTED. (1 - 10, EMPTY LINE = EXIT)
:1 D
```

The Digital Network Performance Report can also be accessed by using the command L R 1 D.

 If only 1 is entered for the System Performance report, the report does not include any digital networking information. The digital networking System Performance report is printed **only** when 1 D is entered.

All information shown on this report is computed from values pegged in the Traffic Peg Count Table. All peg table values max out at 65535. When a field has reached its maximum, the entry is displayed as ***, with a note at the end of the report:

NOTE: *** = Arithmetic Overflow

If fields are overflowing, it is an indication that the report should be listed and cleared at more frequent intervals, based on the traffic on the digital network.

An example of a Digital Network Performance Report is shown below.

```

-- DIGITAL NETWORK PERFORMANCE REPORT FOR XXXXX --

FROM:02/07 11:45 A.M. 1997
TO:02/08 10:44 A.M. 1997
-----
MESSAGE STATISTICS:
VOICE MESSAGES SENT           14071
VOICE MESSAGES RECEIVED      13997
FAX MESSAGES SENT            2409
FAX MESSAGES RECEIVED       2556
NAMES SENT                   3852
NAMES RECEIVED              3871
REAL TIME NAMES PLAYED       0
MESSAGE SEND (hh:mm:ss)     00:00:00
MESSAGE RECEIVE (hh:mm:ss)  00:00:00

DIGITAL NETWORKING CHANNEL USAGE:
NUMBER OF CHANNELS           16
1/2 OR MORE BUSY (hh:mm:ss) 03:57:40
3/4 OR MORE BUSY (hh:mm:ss) 03:33:42
ALL BUSY (hh:mm:ss)         00:58:10
IN USE SENDING MESSAGES (hh:mm:ss) ***
IN USE RECEIVING MESSAGE (hh:mm:ss) ***

LAN CONNECTIONS:
OUTGOING ATTEMPTED           6039
OUTGOING REJECTED            191
OUTGOING GOT ALL BUSY        191
INCOMING ATTEMPTED           5656
INCOMING REJECTED            126
INCOMING GOT ALL BUSY        124

LAN AVAILABILITY:
LAN CARD UP                   99.98%
CARD COURTESY DOWN           3

NOTE: *** = Arithmetic Overflow
-----

```

Following are descriptions of the fields in the report. The information in each field is for the period of the report for one particular location

Message Statistics

MESSAGES SENT	Number of messages sent.
MESSAGES RECEIVED	Number of messages received.
NAMES RECEIVED	Number of network names received from the digital network.
REAL TIME NAMES PLAYED	Number of realtime name plays requested.
MESSAGE SEND	Time (in hours, minutes, and seconds) of the actual lengths of the messages sent.
MESSAGE RECEIVE	Time (in hours, minutes, and seconds) of the actual lengths of the messages received.

Those totals are **not** the same as the amount of time used for sending or receiving messages. The reason they are not the same is that with digital networking, the time to send, for example, a 4-minute message may be less than 4 minutes.

Digital Networking Channel Usage

NUMBER OF CHANNELS	Total number of digital networking channels available on the message server.
1/2 OR MORE BUSY	Time (in hours, minutes, and seconds) that one-half or more of the digital networking channels were busy.
3/4 OR MORE BUSY	Time (in hours, minutes, and seconds) that three-quarters or more of the digital networking channels were busy.
ALL BUSY	Time (in hours, minutes, and seconds) that all digital networking channels were busy.
IN USE MESSAGE SEND	Time (in hours, minutes, and seconds) that a LAN card was occupied sending messages. This time would normally be less than the times in the MESSAGE SEND field.
IN USE MESSAGE RECEIVED	Time (in hours, minutes, and seconds) that a LAN card was occupied receiving messages. This time would normally be less than the times in the MESSAGE RECEIVE field.

LAN Connections

OUTGOING

Attempted	Number of attempts to make a connection to another location.
Rejected	Number of times an attempt to connect to another location was rejected.
Got Busy	Number of times an attempt to connect to another location was rejected because all LAN channels were busy at the other location.

INCOMING

Attempted	Number of attempts by another location to connect to this location.
Rejected	Number of times that attempts by another location to connect to this location were rejected.
Got Busy	Number of times that attempts by another location to connect to this location were rejected because all LAN channels were busy at this location.

LAN Availability

LAN CARD UP	The percentage of time that the LAN card was up and running to the message server up time. This field overflows if the peg for the message server up time reaches its maximum of 65535 minutes, which is 45 days. Therefore, the System Performance Report of the Traffic Peg Table must be cleared at least every 45 days for this information to be useful.
CARD COURTESY DOWN	The number of times that the CD x command to remove a LAN card from service was executed successfully. This field corresponds to Traffic Peg 150.

5.4 NETWORK TRAFFIC REPORT

- 1. SYSTEM PERFORMANCE.
- ◆ 2. **NETWORK TRAFFIC.**
- 3. USER MESSAGE STATISTICS.
- 4. USER CALLING STATISTICS.
- 5. DISK USAGE.
- 6. PORT STATISTICS.
- 7. MAILBOX USAGE.
- 8. USER STATUS DETAIL.
- 9. INTEGRATION CALLING STATISTICS.
- 10. SYSTEM PERFORMANCE BY COS.

The Network Traffic report provides traffic information for each location (multicabinet and remote) configured in the network. All configured locations are listed in the report. Traffic information accumulates until the report is cleared. For each location, the report lists

- Route Choices
- Feature Use Totals
- Message Delivery
- Network Access Totals

Example of a Network Traffic report:

```

----- NETWORK TRAFFIC REPORT FOR XXXXX -----
FROM: MM/DD HH:SS A.M.   YYYY
TO:   MM/DD HH:MM P.M.   YYYY
*****
TO LOCATION << NAME >>
ROUTE CHOICE->  1. TODL02
-----
CALLS TRIED   :      213
ROUTE BUSY   :         0
ROUTE FAIL   :         0
LINEQUAL FAIL:         0
DATA SUCCESS%:      100
MSG-MIN DAY  :      105
MSG-MIN NIGHT:       15

----- MESSAGE DELIVERY -----
CALLS  CALLS  MSGS  SENT  SENT  DISK  ALLMSG
TRIED  FAILED  RETRY NIGHT  DAY  FULL  RET'D
-----
   95     0     0    11   101    0     1

---NETWORK ACCESS TOTALS---      ---FEATURE USE TOTALS---
CALLS  CALLS  ALLPRT  ALLRTE      AUTO  QUICK  USER  IMMED.
TRIED  FAILED  BSY/NA  FAILED      ATTEN.  MSG  LOGON  CALL
-----
   213     1     1     0          62    6    50    0
    
```

To Location

For each location name, information is reported for a maximum of three possible route choices. For each route choice, the following accumulates:

CALLS TRIED	Number of calls attempted to this location by this route.
ROUTE BUSY	Encountered busy trying to reach this location.
ROUTE FAIL	Failed to access this location. Could be due to no route dial tone.
LINEQUAL FAIL	Line test failed. Could be due to low signal or high noise level.
DATA SUCCESS %	The percentage of data commands successfully sent. This value is an indicator of potential data failures that may result in messages returned to sender or uncompleted calls.
MSG-MIN DAY	Minutes of messages sent during the day.
MSG-MIN NIGHT	Minutes of messages sent during the night.

Message Delivery

Information for each location includes

CALLS TRIED	Message delivery calls attempted.
CALLS FAILED	Message delivery calls that failed to transfer at least one message. May be due to no answer, more than 3/4 of the ports busy, or line quality problems. A second attempt is made at a later time.
MSGS RETRY	Messages that failed in the process of being sent. May be due to the line being dropped. The Octel Overture 200/300 automatically retries at a later time. This is an indication of potential line problems.
SENT NIGHT	Messages sent during the night. The night hours are defined by System Parameter 62 — NET: NIGHT DELIVERY START TIME and System Parameter 63 — NET: NIGHT DELIVERY END TIME.
SENT DAY	Messages sent during all hours not defined by System Parameters 62 and 63.
DISK FULL	The disk at this location was full and the message was not delivered. These messages are sent back to the sender's mailbox.
ALLMSG RET'D	This column indicates the number of times all messages were returned for a particular location. The number is specific to each particular location, whether primary or secondary, i.e., if messages in the message queue for the primary location were successfully delivered, but the messages in the message queue for the secondary location were returned, only the secondary location indicates that the message was returned.

Names Directory

The Names Directory applies only to OctelNet:

ASCII RCV FAIL	Number of times delivery of the ASCII name from the remote node failed.
ASCI RCV NIGHT	Number of times ASCII name was received from the remote node during the period defined as night.
ASCII RCV DAY	Number of times ASCII name was received from the remote node during the period defined as day.
SPOKEN RCV FAIL	Number of times delivery of the spoken name from the remote node failed.
SPOKEN RCV NIGHT	Number of times spoken name was received from the remote node during the period defined as night.
SPOKEN RCV DAY	Number of times spoken name was received from the remote node during the period defined as day.
ASCLL NAMVRCY FAIL	Number of times message was refused because the ASCII name on the receiving system did not match the ASCII name on the sending system.

 System Parameter 251 – must be set to YES.

Network Access Totals

Summary of network access for each location:

CALLS TRIED	Number of calls attempted to this location.
CALLS FAILED	Calls tried that were not successful. Could be due to all ports busy, route busy, route failure, or line quality problems.
ALLPRT BSY/NA	Calls tried but not answered by the Octel Overture 200/300 at this location due to all ports busy or the message server being unavailable.
ALLRTE FAILED	Calls failed due to route busy, failure, or line quality, with no routes to advance to.

Feature Use Totals

Caller feature usage for each location:

AUTO ATTEN	Calls transferred through the network to an extension at this location using the automated attendant.
-------------------	---

- QUICK MSG** Quick Messages left at this location through the network.
- USER LOGON** Mailbox logged onto at this location through the network.
- IMMED CALL** Immediate call feature used to call an extension at this location through the network.

Digital Network Traffic Report

To display the report for digital information only, when selecting the report number, enter 2 DIGITAL or 2 D.

☞ If only 2 is entered for the Network Traffic report, the report includes all networking information. Enter 2 D to get information only about digital networking.

```

----- NETWORK TRAFFIC REPORT FOR XXXXXX -----
FROM : 00/00 00:00 A.M. 1997
TO : 07/03 08:30 A.M. 1997
*****
TO LOCATION << CHG01 >>

* * * DIGITAL NETWORK ACTIVITY * * *

----- CONNECTIONS -----
TRIED  FAILED  DRP  ALL-BSY  DAY  NIGHT
      0      0      0      0      0      0

----- MESSAGE DELIVERY -----
VOICE  VOICE  VOICE  DISK  ALLMSG
TRIED  FAILED  RETRY  FULL  MINUTES  RET'D
      0      0      0      0      0      0

FAX    FAX    FAX
TRIED  FAILED  RETRY
      0      0      0

----- OTHER -----
NAMES  HI_SPD  ANALOG  NAMES  NAMESND  NAMESND
PLAYED LNK  DRP  STANDBY  MISMTCH  SENT  FAILED
      0      0      0      0      0      0

*****
NOTE: Information showing success/failure status of analog
standby deliveries is available in the L R 2 report
    
```

Connections

Digital network connections for each location:

- TRIED** Number of times that a request for an open connection was made to the remote system.
- FAILED** Number of times that the open connection request did not result in a connection grant.
- DRP** Number of times that the connection was dropped after it had been established. A connection is considered dropped if the originating end lost the connection, without having done an explicit close connection.

ALL-BSY	Number of times that the reason for a connection reject was that all LAN channels on the destination were busy.
DAY MINUTES	Number of minutes that connections were established and maintained during the day.
NIGHT MINUTES	Number of minutes that connections were established and maintained during the night.

Message Delivery

Information for each location includes

TRIED	Message send attempts over the LAN.
FAILED	Number of send attempts that failed to deliver messages.
RETRY	Number of times the message server tried to send a message to this location that had already been tried earlier
DISK FULL	Number of times a message transfer was not completed because of a destination disk being full.
ALL MSG RET'D	Number of instances when a location fails.
MINUTES	Number of minutes of messages sent to this location.

Other Digital Network Information

Two other kinds of digital network information are provided:

NAMES PLAYED	Number of times that this message server requested this location to play a name in real time. Applicable only to locations in a domain.
HI-SPD LNK DRP	Number of times the permanent TCP/IP connection to this location was lost. Applicable only to high-speed links.
ANALOG STANDBY	Number of times Analog Standby
NAMES MISMTCH	Number of times a message is not delivered over the digital network because the of names between sending and receiving message servers do not match.
NAMESND SENT	Number of times a Namesend name was successfully sent.
NAMESND FAILED	Number of times a Namesend names failed.

5.5 USER MESSAGE STATISTICS

1. SYSTEM PERFORMANCE.
2. NETWORK TRAFFIC.
- ◆ 3. **USER MESSAGE STATISTICS.**
4. USER CALLING STATISTICS.
5. DISK USAGE.
6. PORT STATISTICS.
7. MAILBOX USAGE.
8. USER STATUS DETAIL.
9. INTEGRATION CALLING STATISTICS.
10. SYSTEM PERFORMANCE BY COS.

The User Message Statistics report provides a detailed list of call and messaging activity for individual mailboxes. Each line within the report displays data for a single mailbox. The report contains the number of current messages, total messages, logon dates and when the statistics were last cleared for each mailbox.

Additional user statistics are provided in the User Calling Statistics report.

☞ The User Message Statistics report uses the same tables as the User Calling Statistics and User Status Detail reports. When one of these reports is cleared, the tables are cleared for all three reports.

Example of a User Messaging report:

* MESSAGING STATISTICS *													
MM/DD	HH:MM	P.M.	YYYY									PAGE	1
MAILBOX	<---CURRENT MESSAGES--->				<-MESSAGES LEFT AFTER->				<--LOGON-->		DATE		
	TOTAL	AVGSC	TOTSC	OLDST	BUSY	NOANS	GREET	OTHER	TOTAL	LAST	CLEAR		
300	2	19	39	9/03	0	3	64	4	60	9/21	7/27		
301	6	71	430	9/17	12	29	3	85	183	9/17	7/27		
304	3	60	180	8/31	95	64	128	336	582	9/23	7/27		
305	0	0	0	---	34	119	5	119	230	9/23	7/27		
306	0	0	0	---	28	57	0	43	339	9/23	7/27		
307	0	0	0	---	0	0	0	0	2	9/23	1/01		
310	1	16	16	9/23	18	68	16	118	304	9/22	7/27		
311	0	0	0	---	2	80	0	62	133	9/23	7/27		

Messaging Statistics

Provides statistics about messages currently stored in each mailbox. Also shows the date that data for each mailbox was last cleared (from a terminal) by using the command `CLEAR REPORTS` and choosing option 3.

Current Messages

Numbers are given for

TOTAL	Total number of messages currently stored.
AVGSC	Average seconds per message, based on the total seconds and total number.
TOTSC	Total seconds of current messages stored.
OLDST	Date of the oldest message stored.

Messages Left After

Total number of messages left after the caller encountered any of these conditions:

BUSY	Extension called was busy.
NO ANSWER	Extension called did not answer. This includes all forwarded calls.
GREETING	Personal greeting was turned ON and played.
OTHER	Messages left by: New Message, Quick Message, Forward, Reply, Return Receipt, Broadcast, Distribution List.

Logon

Mailbox was entered by dialing and mailbox number (and security code) or for quick logon by dialing (and security code). This field provides

TOTAL	Number of times mailbox was entered.
LAST	Date when mailbox was last entered.

5.6 USER CALLING STATISTICS

1. SYSTEM PERFORMANCE.
2. NETWORK TRAFFIC.
3. USER MESSAGE STATISTICS.
- ◆ 4. **USER CALLING STATISTICS.**
5. DISK USAGE.
6. PORT STATISTICS.
7. MAILBOX USAGE.
8. USER STATUS DETAIL.
9. INTEGRATION CALLING STATISTICS.
10. SYSTEM PERFORMANCE BY COS.

The User Calling Statistics report provides a detailed list of call and messaging activity for individual mailboxes. Each line within the report displays data for a single mailbox. The report contains the number of incoming calls, subsequent calls, abandoned calls, and date statistics were last cleared for each mailbox.

Additional user statistics are provided in the User Message Statistics report.

☞ The User Calling Statistics report uses the same tables as the User Message Statistics and User Status Detail reports. When one of these reports is cleared, the tables are cleared for all three reports.

Example of a User Calling Statistics report:

```

* CALL PROCESSING STATISTICS *

MM/DD HH:MM P.M.   YYYY                                PAGE 1

<-----INCOMING CALLS-----> <-SUBSEQ. CALLS->  CALLS  DATE
MAILBOX  TOTAL ANSWD NOANS  BUSY GREET  TOTAL ATTEN EXTNS  ABAND  CLEAR

301          27    1    6    7   13    15    2   13    11  9/01
303          36   20   16    0    0     7    2    5    4  9/01
304           7    3    0    0    4     2    0    2    2  9/01
305          38   14   19    5    0     5    5    0    5  9/01
307           1    0    0    1    0     0    0    0    1  9/01
308           2    0    2    0    0     1    1    0    1  9/01
309           1    0    1    0    0     0    0    0    1  9/01
310           6    1    4    0    0     0    0    0    5  9/01
    
```

Call Processing Statistics

Provides statistics about calls to each mailbox. Also shows the date that data for each mailbox was last cleared (from a terminal) by using the command `CLEAR REPORTS` and choosing option 3.

Incoming Calls

Provides the following information for calls directed to the mailbox/extension.

TOTAL Total number of calls placed by the Octel Overture 200/300. Both integrated and non-integrated calls are included in this total.

ANSWD Number of calls answered This number includes non-integrated calls only. Calls that are released and forwarded back are not pegged.

NO ANSWD Number of calls not answered. Only non-integrated calls are included.

BUSY Number of calls placed to a busy extension. Only non-integrated calls are included.

GREET Number of calls placed to mailbox when

- Greeting is ON
- Extended absence greeting is ON
- No extension is associated with the mailbox
- Extension is unavailable or vacant
- DID calls which were intercepted immediately
- Calls to Personal Assistance resulting in RNA or busy

Only non-integrated calls are included.

 For calls that forward back in an integrated message server, refer to the Integration Calling Statistics Report section for the call count status.

Subsequent Calls

Provides information about what a caller did after their initial call to a mailbox or extension that was not answered.

TOTAL Total number of subsequent calls.

ATTEN Number of times the caller entered after entering an extension or mailbox.

EXTNS Number of times caller entered another mailbox or extension.

CALLS ABAND Number of calls disconnected after reaching an unavailable extension without leaving a message, calling another extension or the operator. Included are calls to scripted prompt mailboxes during which the caller hangs up before completing responses (in situations where COS Attribute 33 — WILL SEND SCRIPTED MESSAGES WITHOUT CONFIRMATION, is not assigned to the scripted prompt COS).

A forwarded call where a call record is generated is considered an initial action. Therefore, if a caller is forwarded, enters a mailbox number and then hangs up after hearing a greeting or system prompt, the mailbox entry pegs under Subsequent Calls and the abandon call column are not pegged.

Calls forwarded to the Octel Overture 200/300 are considered an initial action, and Calls Aband is pegged if the caller hangs up without leaving a message or dialing another extension.

5.7 DISK USAGE REPORT

1. SYSTEM PERFORMANCE.
2. NETWORK TRAFFIC.
3. USER MESSAGE STATISTICS.
4. USER CALLING STATISTICS.
- ◆ 5. **DISK USAGE.**
6. PORT STATISTICS.
7. MAILBOX USAGE.
8. USER STATUS DETAIL.
9. INTEGRATION CALLING STATISTICS.
10. SYSTEM PERFORMANCE BY COS.

The Disk Usage report provides statistics about the amount of voice message storage currently used on the message server.

```

* DISK USAGE REPORT FOR ABC Name *

12/20 06:01 P.M. 1997

-----TOTAL SYSTEM MESSAGE STORAGE-----

      PHYSICAL TOTAL      NAMES      GREETINGS      USER MSGS      NET NAMES
      STORAGE      %      NON      NON      NON
      CAPACITY USED      REDN REDN REDN REDN REDN REDN REDN REDN REDN
DISK 1 1985 32.7% 0.0% 1.0% 0.0% 1.3% 0.0% 30.0% 0.0% 0.3%
DISK 2 1985 32.3% 0.0% 0.9% 0.0% 1.6% 0.0% 29.4% 0.0% 0.2%
DISK 3 2777 48.2% 0.0% 1.4% 0.0% 2.1% 1.7% 42.5% 0.0% 0.4%
DISK 4 0 0.0% 0.0% 0.0% 0.0% 0.0% 0.0% 0.0% 0.0% 0.0%
DISK 5 0 0.0% 0.0% 0.0% 0.0% 0.0% 0.0% 0.0% 0.0% 0.0%
DISK 6 0 0.0% 0.0% 0.0% 0.0% 0.0% 0.0% 0.0% 0.0% 0.0%

TOTAL 6747 39.0% 0.0% 1.1% 0.0% 1.7% 0.7% 35.0% 0.0% 0.3%

TOTAL EQUIPPED MINUTES 73.1% USED
TOTAL PURCHASED MINUTES: 3600

STORAGE CAPACITY BASED ON MESSAGE TYPE:

      VOICE MSGS      FAX MSGS
      NON      NON
      REDN REDN REDN REDN
-----
DISK 1 0.0% 24.1% 0.0% 5.9%
DISK 2 0.0% 24.3% 0.0% 5.0%
DISK 3 1.0% 34.6% 0.7% 7.8%
DISK 4 0.0% 0.0% 0.0% 0.0%
DISK 5 0.0% 0.0% 0.0% 0.0%
DISK 6 0.0% 0.0% 0.0% 0.0%

TOTAL 0.4% 28.5% 0.2% 6.4%
    
```

Total System Message Storage

The Disk Usage report displays, the storage capacity, total percentage of storage used, and percentages of storage for names, greetings, and user messages for the disk.

STORAGE CAPACITY Number of minutes of storage.

TOTAL % USED Total percentage of the disk storage capacity used.

NAMES Non-redundant and Redundant	Percentage of the storage capacity used for non-redundant and redundant names storage.
GREETINGS Non-redundant and Redundant	Percentage of the storage capacity used for non-redundant and redundant greetings storage.
USER MESSAGES Non-redundant and Redundant	Percentage of the storage capacity used for non-redundant and redundant user messages storage.
NET NAMES Non-redundant and Redundant	Percentage of the storage capacity used for non-redundant and redundant network names storage.

The last row in the Total System Message Storage section lists the total for each of the columns.

Total of Minutes

TOTAL EQUIPPED MINUTES	Maximum minutes of message storage that would be available if no voice messages (names, greetings, or messages) are stored. This number is derived from the total of all voice hours on non-COD drives and equipped hours on the COD drives.
TOTAL PURCHASED MINUTES	The number of minutes purchased. This number may not be the same as the total equipped minutes if the message server has not been restarted since new COD hours were purchased.

Storage Capacity Based on Message Type

The Disk Usage report displays the storage capacity based on message type for voice messages and fax messages for every disk.

VOICE MESSAGES Non-redundant and Redundant	Percentage of the storage capacity used for non-redundant and redundant storage of voice messages.
FAX MESSAGES Non-redundant and Redundant	Percentage of the storage capacity used for non-redundant and redundant storage of fax messages.

5.8 PORT STATISTICS

1. SYSTEM PERFORMANCE.
2. NETWORK TRAFFIC.
3. USER MESSAGE STATISTICS.
4. USER CALLING STATISTICS.
5. DISK USAGE.
- ◆ **6. PORT STATISTICS.**
7. MAILBOX USAGE.
8. USER STATUS DETAIL.
9. INTEGRATION CALLING STATISTICS.
10. SYSTEM PERFORMANCE BY COS.

This report contains information for each port configured in the SLOTS Table. There are three sections of this report:

- Individual Port Statistics
- Port Group Statistics
- All Port Statistics

 Port statistics are included for fax calls.

An example of a Port Statistics report follows. The report refers to the fax channels as FAX ports.

```

* PORT USAGE REPORT FOR (SYSTEM NAME) *
FROM: MM/DD HH:MM A.M. YYYY
TO: MM/DD HH:MM P.M. YYYY
-----
* INDIVIDUAL PORT STATISTICS *
-----
PORT PORT INCOMING OUTGOING SECONDS SELFTEST
NUMBER TYPE COS CALLS/FAX CALLS/FAX BUSY FAILED
-----
1 VOC 254 468 0 1242 0
2 VOC 254 1082 0 2571 0
.
16 VOC 254 1473 129 3972 0
17 FAX 150 0 0 0 0
-----
* PORT GROUP STATISTICS *
-----
COS: 254
VOICE PORTS: 1 2 3 4 5 6 7 8 9 10 11 12 13 14 15 16
FAX PORTS:
NUMBER OF INCOMING CALLS:
NUMBER OF OUTGOING CALLS: 0
NUMBER OF INCOMING FAXES: 0
NUMBER OF OUTGOING FAXES: 0

NUMBER OF PORTS SIMULTANEOUSLY BUSY:
1 PORT FOR 10 SECONDS

COS: 150
VOICE PORTS:
FAX PORTS 16 17 18 19
NUMBER OF INCOMING CALLS: 0
NUMBER OF OUTGOING CALLS: 0
NUMBER OF INCOMING FAXES: 0
NUMBER OF OUTGOING FAXES: 0

NUMBER OF PORTS SIMULTANEOUSLY BUSY:
1 PORT FOR 0 SECONDS
-----
* ALL PORT STATISTICS *
-----
TOTAL NUMBER OF INCOMING CALLS: 0
TOTAL NUMBER OF OUTGOING CALLS: 0
TOTAL NUMBER OF INCOMING FAXES: 0
TOTAL NUMBER OF OUTGOING FAXES: 0

SECONDS TOO MANY PORTS BUSY TO MAKE OUTCALLS: 3
SECONDS TOO MANY PORTS BUSY TO MAKE FAX DELIVERY: 0

NUMBER OF VOICE PORTS SIMULTANEOUSLY BUSY:
1 PORT FOR 23221 SECONDS
2 PORTS FOR 12823 SECONDS

NUMBER OF FAX PORTS SIMULTANEOUSLY BUSY:

```

Individual Port Statistics

Information in this section includes the number of incoming and outgoing calls for each voice port and fax channel, the number of seconds each port was busy, and the number of seconds each port was busy because it failed selftest.

PORT NUMBER	The number associated with each port in the SLOTS Table.
PORT TYPE	Identifies whether the port is a voice port (VOC) or a fax channel (FAX).
COS	The Class of Service assigned to each port.
INCOMING CALLS/ FAXES	The number of incoming calls to each port for the period of time shown in the header of the report. The number of incoming calls on a VOC port includes both voice and fax calls received. The number of incoming calls on a FAX port is the number of fax messages received on that fax channel.
OUTGOING CALLS/ FAXES	The number of outgoing calls made on each port. Includes on-site and off-site message waiting, network messages sent, alarm calls, test network and fax delivery calls. The number of outgoing calls on a FAX port is the number of faxes successfully printed on that fax channel.
NUMBER OF SECONDS BUSY	Number of seconds the VOC port was not idle. The number of seconds fax channel corresponding to the FAX port was allocated.
SELFTTEST FAILED	The number of seconds the VOC port was out of service because selftest failed. Selftest fails when an error occurs during diagnostics causing the port to be taken out of service.

Port Group Statistics

Information in this section is grouped by COS. For each COS used in the SLOTS Table, there is a listing of each port, by number, included in that COS, as well as a total of the number of incoming and outgoing calls. Below that, there is an indication of how many ports are simultaneously busy for the listed number of seconds.

COS	The Class of Service of the port group.
VOICE PORTS FAX PORTS	The number associated with each port extension having this COS in the SLOTS Table.
NUMBER OF INCOMING CALLS	The total number of calls to all VOC ports using this COS. Includes both voice and fax calls received.
NUMBER OF OUTGOING CALLS	The total number of calls from all VOC ports using this COS. Includes on-site and off-site message waiting, network messages sent, alarm calls, test network calls, and fax delivery calls.
NUMBER OF INCOMING FAXES	The total number of fax messages received to all FAX ports using this COS.

NUMBER OF OUTGOING FAXES	The total number of faxes successfully printed from all FAX ports using this COS. Includes fax delivery for fax messages and fax-on-demand requests.
NUMBER OF PORTS SIMULTANEOUSLY BUSY	The number of ports using this COS that are busy at the same time and the total number of seconds during the reporting period for which that number of ports were busy.

All Port Statistics

Information in this section includes the total number of incoming and outgoing calls for the message server, the number of seconds “n” ports were busy, the number of seconds message waiting could not call because too many ports were busy, and the number of seconds a fax call could not be made because too many fax channels were busy.

TOTAL NUMBER OF INCOMING CALLS	The total number of all incoming calls to the message server for the period of time shown in the header of the report.
TOTAL NUMBER OF OUTGOING CALLS	The total number of all outgoing calls from the message server for the period of time shown in the header of the report. This includes on-site and off-site message waiting, network messages sent, alarm calls, test network calls, and fax delivery calls.
TOTAL NUMBER OF INCOMING FAXES	The total number of all faxes received for the period of time shown in the header of the report.
TOTAL NUMBER OF OUTGOING FAXES	The total number of all faxes printed for fax mail, fax overflow delivery and fax-on-demand for the period of time shown in the header of the report.
SECONDS TOO MANY PORTS BUSY TO MAKE OUTCALLS	If all ports make outcalls — the total number of seconds $\frac{3}{4}$ or more of the ports were busy. If any ports do not allow outcall — the total seconds all ports that do allow outcall were busy.
SECONDS TOO MANY PORTS BUSY TO MAKE FAX DELIVERY	Total number of seconds a FAX port was not available for fax delivery outcall.
NUMBER OF VOICE PORTS SIMULTANEOUSLY BUSY	The number of VOC ports that are busy at the same time and the total number of seconds during the reporting period for which that number of VOC ports were busy.
NUMBER OF FAX PORTS SIMULTANEOUSLY BUSY	The number of FAX ports that are busy at the same time and the total number of seconds during the reporting period for which that number of FAX ports were busy.

☞ To retain accuracy of the Port Statistics report, it is recommended the report be listed and cleared before changing a port’s COS in the UPDATE program, or changing the number of ports in System Parameter 4 — PORTS USED. The System Performance and Port Statistics reports are listed together in the CLEAR REPORT command. Therefore, also list and clear the System Performance report when listing and clearing the Port Statistics report.

5.9 MAILBOX USAGE

1. SYSTEM PERFORMANCE.
2. NETWORK TRAFFIC.
3. USER MESSAGE STATISTICS.
4. USER CALLING STATISTICS.
5. DISK USAGE.
6. PORT STATISTICS.
- ◆ 7. **MAILBOX USAGE.**
8. USER STATUS DETAIL.
9. INTEGRATION CALLING STATISTICS.
10. SYSTEM PERFORMANCE BY COS.

The Mailbox Usage report contains information detailing individual mailbox usage. The report shows the amount of time a port was used for each mailbox in the USER Table. The extension associated with each mailbox is also listed. The usage time for each mailbox is measured in two ways: Logon Time and Access Time.

- ❑ **Logon Time.** Logon time is the amount of time a person is logged onto their mailbox. The accumulated time is added to that mailbox’s logon time when the person exits their mailbox (by entering or hanging up).
- ❑ **Access Time.** Access time is the amount of time a caller listens to a greeting and/or leaves a message. The accumulated time is added to that mailbox’s access time after the greeting plays or a message is left.

This is an example of a Mailbox Usage report:

* MAILBOX USAGE SUMMARY *				
MM/DD	HH:MM P.M.	YYYY	Page 1	
MAILBOX	EXTENSION		LOGON TIME (MIN)	ACCESS TIME (MIN)
468	468		22	2
469	469		24	6
470	470		4	0
471	471		14	12
472	472		11	9
473			0	0
474	474		10	2
475	475		6	3

In some applications, it may be necessary to only collect timing information for certain ports. For example — the amount of time a person is logged onto a mailbox over a WATS line should be charged for, but the time logged on locally should not.

To provide this capability, COS Attribute 55 — DO NOT COLLECT MAILBOX TIMING INFORMATION FOR THIS PORT, can be assigned to specific ports. Timing information is not collected for calls made to ports with this attribute in their COS. (Attribute 55 has no effect if assigned to a mailbox.)

5.10 USER STATUS DETAIL

1. SYSTEM PERFORMANCE.
2. NETWORK TRAFFIC.
3. USER MESSAGE STATISTICS.
4. USER CALLING STATISTICS.
5. DISK USAGE.
6. PORT STATISTICS.
7. MAILBOX USAGE.
- ◆ **8. USER STATUS DETAIL.**
9. INTEGRATION CALLING STATISTICS.
10. SYSTEM PERFORMANCE BY COS.

This report provides current status information on mailbox access and the time durations associated with individual mailbox usage.

The following information is provided for each mailbox.

- Mailbox Number
- Name Recorded (Y/N)
- Greeting ON (Y/N or EA for extended absence greeting ON)
- Greeting Length (mmm:ss)
- Last Logon (mm/dd/yy)
- Oldest Message (mm/dd hh:mm)
- Newest Message (mm/dd hh:mm)
- Total Current Messages (up to 60)
- Total Message Duration (mmm:ss)

An example of the User Status Detail report follows.

USER STATUS DETAIL REPORT										
MM/DD	HH:MM	P.M.	YYYY							Page 1
MAILBOX	NAME	<GREETING>	LAST	<-----MESSAGES----->						
	REC?	ON?	LENGTH	LOG-ON	OLDEST	NEWEST	TOTAL	DUR.		
549	N	N	0:07	6/26 10:03	6/04 11:18	6/26 10:03	8	1:23		
550	Y	Y	1:02	6/03 13:11	5/26 13:56	6/13 12:08	3	3:05		
551	Y	EA	0:33	6/16 19:19	6/09 16:39	6/16 16:39	4	2:46		
552	Y	Y	0:18	6/12 10:59	6/12 9:19	6/18 10:49	3	5:23		
599	Y	Y	0:13	6/06 9:03	---	---	0	0:00		

☞ The User Status Detail report uses the same tables as the User Message Statistics and User Calling Statistics reports. When one of these reports is cleared, the tables are cleared for all three reports.

5.11 INTEGRATION CALLING STATISTICS

1. SYSTEM PERFORMANCE.
2. NETWORK TRAFFIC.
3. USER MESSAGE STATISTICS.
4. USER CALLING STATISTICS.
5. DISK USAGE.
6. PORT STATISTICS.
7. MAILBOX USAGE.
8. USER STATUS DETAIL.
- ◆ **9. INTEGRATION CALLING STATISTICS.**
10. SYSTEM PERFORMANCE BY COS.

The Integration Calling Statistics Report lists information about the type of non-integrated or integrated calls a mailbox received, as well as the number of calls to the mailbox that are abandoned.

```

                * INTEGRATION CALLING STATISTICS *

MM/DD  HH:MM P.M.  YYYY                                     Page 1

<-----INCOMING CALLS----->
                <--NON-INTEGRATED-->  <---INTEGRATED--->  CALLS  DATE
MAILBOX  TOTAL  ANSWD  NOANS  BUSY  GREET  NOANS  BUSY  ALL  ABAND  CLEAR

```

The Integration Calling Statistics report provides the following information for calls directed to the listed mailbox.

TOTAL Total number of calls placed by the Octel Overture 200/300 to the mailbox.

ANSWD Number of calls answered or transferred to ringing.

Non-Integrated Information

NO ANSWD Number of calls not answered.

BUSY Number of calls placed to a busy extension.

- GREET** Number of calls placed to the mailbox when
- Greeting is ON.
 - Extension is unavailable or vacant.
 - Call is placed to an extension which forwards back to a CX/MX mode port.
 - DID calls which were intercepted immediately.
 - Calls to Personal Assistance resulting in RNA or busy.
 - PBX integration calls which forward on the “all forward” condition.

Integrated Information

NO ANSWD Number of calls not answered. Includes PBX integration calls that forward on the ring-no-answer condition.

BUSY Number of calls placed to a busy extension. Includes PBX integration calls that forward on the busy condition.

ALL (FORWARD) Number of integrated calls forwarded on the All Forward condition. This also includes forwarded calls with no forward condition.

Calls Aband Number of calls disconnected after reaching an unavailable extension without leaving a message, calling another extension or calling the operator.

Date Cleared The date the statistics were last cleared.

5.12 SYSTEM PERFORMANCE BY COS

1. SYSTEM PERFORMANCE.
2. NETWORK TRAFFIC.
3. USER MESSAGE STATISTICS.
4. USER CALLING STATISTICS.
5. DISK USAGE.
6. PORT STATISTICS.
7. MAILBOX USAGE.
8. USER STATUS DETAIL.
9. INTEGRATION CALLING STATISTICS.
- ▶ 10. **SYSTEM PERFORMANCE BY COS.**

System Performance by COS report provides call and message statistics for ports/trunks by COS.

Example of a System Performance by COS report:

```

* SYSTEM PERFORMANCE BY COS FOR XXXXX *

FROM: MM/DD HH:MM A.M.   YYYY
TO:   MM/DD HH:MM P.M.   YYYY
-----

PORT/TRUNK COS: XXX

                                CALLER'S INITIAL ACTION
DIALED EXTENSION OR DIGITS          6
INTEGRATION:
  RNA FORWARD;                      0
  BUSY FORWARD;                     0
  ALL FORWARD;                      0
DEFAULTED TO ASSISTANCE:             0
DIALED "0" FOR ASSISTANCE:           0
PRESSED "#" TO LOG-ON:              44
*** TO MAKE A QUICK MESSAGE:       0
CALLER WAS A NETWORK UNIT:          0
CALLER WAS A DID/E&M UNIT:          0
OTHER:                              0
TOTAL CALLS INTO SYSTEM:            52

                                CALLERS SUBSEQUENT ACTIONS
DIALED EXTENSION OR DIGITS:         10
DEFAULTED TO ASSISTANCE:             0
DIALED "0" FOR ASSISTANCE:           1
LEFT A MESSAGE AT THE TONE:         0
PRESSED "#" TO LOG-ON:              10
*** TO MAKE A QUICK MESSAGE:       0

```

Caller's Initial Action

This section displays callers' initial actions upon reaching the port/trunk COS specified.

DIALED EXTENSION OR DIGITS

This can include

- Number of times callers dialed a defined first digit from 1–8.
- Number of times callers were sent directly to Next Mailbox without dialing.

	<ul style="list-style-type: none"> <input type="checkbox"/> With Adaptive Integration, every time a call is forwarded to the Octel Overture 200/300. <input type="checkbox"/> Number of times callers dialed an account code. <input type="checkbox"/> Number of times callers dialed extensions or digits to call out on the network.
INTEGRATION	Number of integrated calls that forwarded in.
RNA FORWARD	Number of calls placed that were not answered.
BUSY FORWARD	Number of calls placed to a busy extension.
ALL FORWARD	Number of calls placed to an All Forwarded condition.
DEFAULTED TO ASSISTANCE	Number of times callers did nothing (e.g., rotary dial) and were transferred to attendant or intercept position.
DIALED <input type="text" value="0"/> FOR ASSISTANCE	Number of times callers pressed <input type="text" value="0"/> and were transferred to attendant or intercept position.
LEFT A MESSAGE AT THE TONE	Number of times callers left a message as an initial action. This also includes instances where Next Mailbox gives the caller a greeting and takes a message without the caller entering any digits.
PRESSED <input type="text" value="#"/> TO LOG ON	Number of times callers pressed <input type="text" value="#"/> to enter a mailbox (includes successful and unsuccessful logons).
<input type="text" value="*"/> TO MAKE A QUICK MESSAGE	Number of times callers pressed <input type="text" value="*"/> to make a Quick Message.
CALLER WAS A NETWORK UNIT	Number of times caller identified itself as a Network system. That is, the call was from another network location.
CALLER WAS A DID/E&M UNIT	Number of times caller identified itself as a DID/E&M system. That is, the call was intercepted by the Octel Overture 200/300DID/E&M Interface.
OTHER	Miscellaneous category including <ul style="list-style-type: none"> <input type="checkbox"/> Caller dialed <input type="text" value="9"/> <input type="text" value="9"/>. <input type="checkbox"/> Port called a CX port (extension forwarded to the Octel Overture 200/300). <input type="checkbox"/> Caller dialed invalid first digit (e.g., <input type="text" value="9"/>). <input type="checkbox"/> Caller disconnected (detected hang-up events or from DID Interface). <input type="checkbox"/> Caller has not taken initial action.

- With Adaptive Integration
 - Direct call into the Octel Overture 200/300 where caller hangs up or dials .
 - Direct internal call into the Octel Overture 200/300 where caller accesses Quick Greeting Activation.
-  Numbers within the Other category may fluctuate as new calls come in and as current callers make an initial action.

TOTAL CALLS INTO SYSTEM

Total calls answered by the Octel Overture 200/300.

-  If the System Performance report or traffic pegs were last cleared while calls were in progress, this value may be larger than peg 1. However, the value printed in the System Performance report always reflects the correct value.

Subsequent Actions

After completing their initial action (i.e., the caller left a message at the tone), another action is taken. Subsequent actions are described below.

DIALED EXTENSION OR DIGITS

This can include

- Number of times callers dialed a defined first digit from 1–8.
- Number of times callers went to Next Mailbox.
- Number of times callers dialed an extension or digit to stay in queue.

SENT TO ASSISTANCE

This can include

- Number of times callers were transferred to attendant or intercept position after dialing too many invalid extensions.
- Number of callers that remain on the line for assistance, whether or not a message was left, with Adaptive Integration, when System Parameter 77 — PBX PROVIDES MOMENTARY DISCONNECT, is set to YES.
- Calls intercepted by DID or E&M Interface Modules which defaulted to assistance, whether or not a message was left.
- Number of network calls sent to assistance.
- Autotransfer to assistance (includes Personal Assistant).

DIALED FOR ASSISTANCE

Number of times callers pressed and were transferred to the attendant/intercept position or Personal Assistant.

LEFT A MESSAGE AT THE TONE

Number of times callers left a message after busy/no answer/greeting.

PRESSED TO LOG ON

Number of times callers pressed to enter a mailbox (includes successful and unsuccessful logons).

PRESSED TO MAKE A QUICK MESSAGE

Number of times callers pressed to make a Quick Message.

6

MAINTENANCE COMMANDS

Chapter Contents

6.1	Command Summary	6-1
	List Commands	6-1
	Clear Commands	6-3
	Test Commands	6-4
	System Service Mode Commands	6-6
	Miscellaneous Commands	6-8
6.2	Diagnostics	6-17
	Mailbox Configuration Status	6-17
	Message Status	6-19
	Network Diagnostics	6-20
	Port Configuration Status	6-27
	Port Mapping Status	6-28
	Floppy-Disk-Drive Diagnostics	6-28
	Hard-Disk-Drive Diagnostics (DEX)	6-29
	Disk Information Status (L DMAP)	6-31
	Line-Interface-Card Diagnostics	6-32
	Update Integration	6-33
	Port Status	6-34
	Alarm Test	6-37
	System Forwarding	6-39
	System Initialization	6-39
	System Status	6-40
	List Features	6-40
6.3	Application Delays	6-43
	How Tones Are Recognized	6-43
	How To Modify Application Delays	6-45
	Modifiable Application-Delay Indexes	6-47
	Using UPDATE to Modify Application Delays	6-55
6.4	Message Block and Message Purge	6-56
	Marking a Message Unplayable	6-56
	MPURGE Command Usage	6-58

6

MAINTENANCE COMMANDS

Figures

6-1	Alarm Test Flow	6-38
6-2	Sequence Used by the Octel Overture 200/300 To Screen Calls	6-44
6-3	Ring/No Answer Tone-Timing Failure	6-47

Tables

6-1	FINDMBOX Messages and Descriptions	6-24
6-2	Abbreviations for Channel/Port State	6-35
6-3	Application Delays for Cadence Recognition, for Determining Tone On/Tone Off	6-54

Quick Reference Guide

Maintenance Commands

Section	Subject	Command	Information	
Call Processing Trace	List Trace	L T	Trace for specific activity, selecting from the menu shown.	
Diagnostics	Reports	C R	Gives a menu for the type of report to clear.	
	Hard Disk Drive	DEX x y	Reads all disk sectors. x = disk number; y = region number.	
	Disk Drive	DSKMAP	Displays the last known status of all drives as recorded by the VCU. DSKMAP can be run from the hard disk or from the software diskette.	
	Disk Drive	DSKTST	Tests the drive slot specified, updates the last known status record of the VCU, and displays the status.	
	Mailbox Location	FINDMBOX	Searches for a mailbox in the local USER Table, local Network Name Table, and in the Uniform numbering Plan Domain. The command then prints a status message of the results of each search.	
	LAN Status		LANSTAT	For Digital Networking, gives basic information about the current status of the LAN, including whether the LAN is UP or DOWN and the state of the high-speed links.
			CMD x PING y	For Digital Networking, performs the lowest-level "echo" test from the LAN card at the local end to the destination cabinet. x = slot number in which the LAN card is installed y = IP address of device to which text Ethernet packet is sent
	LAN Channel Status	LCSTAT	For Digital Networking, displays the status of LAN channels. The status of all LAN channels, a specific LAN channel, or a range can be specified.	

Quick Reference Guide

Maintenance Commands

Section	Subject	Command	Information
Diagnostics (continued)	List Features	L F	Lists the features, the number of ports, mailboxes, and storage hours the system is equipped with.
	Message Status	L HE x	Lists the status of a message. x = message number.
	Mailbox Configuration	L M x	Lists the current configuration for a mailbox. x = mailbox number.
	Mailbox Configuration	L M x M	Lists information about messages for a specific mailbox. x = mailbox number; M is a required extension (the letter M, not an argument) of the command.
	Network Mailbox Status	L NET x	Displays message information for a network location. x = network location code.
	Messages Pending for Domain Locations	L NET D [x]	Lists messages pending transfer to the domain in general or specific domain locations. Messages that are pending response to LAN queries are also listed. x = is the domain location (optional)
	Personal Distribution List	L PDL	Lists the number of personal distribution list (PDL) sectors currently used.
	Port Configuration	L PO x	Displays information about a port. x = port number.
	Reports	L R	Gives a menu for the type of report to list.
	Integrations APIC or NPIC	SDBG xx 1 FF YY	Integration trace information is logged to the message server's call-processing trace log file. where xx is the slot number and yy is either 7F to turn on debug or 00 to turn off.
All other integrations	SDBG xx YY zz	where xx is the slot number, yy is the unit number and zz is either 7F to turn on debug or 00 to turn off.	

Quick Reference Guide

Maintenance Commands

Section	Subject	Command	Information
	Port Mapping Status	PRTMAP	Displays information about the allocation of system port numbers to ports configured in each slot.
	Tone and DTMF	PRT x	Monitors and prints the tone and DTMF events received for the port specified. To exit the monitor mode, press <u>Escape</u> . x = port number.
Diagnostics (continued)	Port Status	PS x	Displays current state of the ports. x = non-zero for continuous (optional)
	LAN Status	T DNET	For Digital Networking, to get a quick indication of the general “health” of the configuration and hardware at the local and remote cabinets.
	SNMP Manager System	T SNMP	Tests the mechanism for an Octel Overture 200/300 to communicate to an SNMP manager system.
	Alarm Test	TE A	Attempts to call number defined for alarm call.
	System Forwarding	CD x y z or TE C 1 y z	Forwards all ports specified. Uses string from System Parameter 45 — SYSTEM RELOAD FORWARD STRING. x = slot number y = port number or first port in a range of ports z = port number of the last port in a range of ports
	Floppy Disk Drive	TE F 1	Isolates faults to the diskette, disk drive, or disk controller.
	System Initialization	CU x y z or TE C 2 y z	Initializes and cancels forwarding for all ports specified. Sends initialization string from System Parameter 33 — PBX INITIALIZE CODE, then cancels forward string from System Parameter 46 — SYSTEM RELOAD CANCEL-FORWARD STRING. x = slot number y = port number or first port in a range of ports z = port number of the last port in a range of ports

Quick Reference Guide

Maintenance Commands

Section	Subject	Command	Information	
Diagnostics (continued)	Integration Card	TE INT x y	Tells the integration card to run its link selftest. Used only for systems with integration cards. x = slot number y = unit number.	
	LIC	TE L 1	Checks tone generation and detection circuitry.	
		TE L 2	Ring-through test. Use only when no traffic on system.	
		TE L 4 x	Test to see whether loop current is present on a specific port. x = port number.	
			TE L 5 x	Tone reflection test on one port. x = port number.
	Network Routes	TE NET x y	Tests network routes to a network location. x = network location code (optional); y = non-zero show digits entered.	
	System Status	TE S	Checks voltages and temperatures.	
	Fax Application Processor	TE X x y z	Fax loopback test. Verifies that the fax modems on the Fax Application Processor can send and receive fax data and that the TDM bus connection is correct. x = slot number y and z = fax channels	
	Data Fields	BITTST x	Converts hardware error data fields into bit sets. x = hexadecimal number.	
Hardware Errors	List Hardware Error Table	L H	Lists the Hardware Error Table.	
	Clear Hardware Error Table	C H	Clears the Hardware Error Table.	

Quick Reference Guide

Maintenance Commands

Section	Subject	Command	Information
Integration	Integration Unit	CD x y	Takes the integration unit out of service. x = slot number y = unit number
		CU x y	Brings the integration unit into service. x = slot number y = unit number
Integration (continued)	Integration Unit	ISTAT x y	Gives the current status of an integration unit. x = slot number y = unit number
	Integration Board	L INT x y	Lists the current state of the integration board, the diagnostic status, and the status of the links, and the pegs. x = slot number y = unit number.
	Incoming Call Records	MON2	Used to monitor incoming call records over the RS-232C link (port 2). To exit the monitor mode, press Escape
		MON2 H	Show call record data in hexadecimal values as it is sent by the PBX.
	Message Waiting Lamps	MWL RELITE	Send commands to relight each message waiting lamp that the Octel Overture 200/300 has marked as ON.
		MWL RECALC	Examines each mailbox to determine whether its message waiting lamp should be ON or OFF.
		MWOFF x	Turns OFF lamp message waiting. x = mailbox number. The maximum number of digits is eight. For ALL, enter A.
	L RT 1	List round trip time for message waiting.	
	C RT 1	Clears round trip time for message waiting.	

Quick Reference Guide

Maintenance Commands

Section	Subject	Command	Information
	Integration Cards	UPINTG	Restarts the integration cards and therefore disrupts call processing for approximately one to two minutes.
	Integration Board	C I x y	Clears the integration board pegs. x = slot number y = unit number
Traffic Pegs	Traffic Peg Count Table	L P	Lists the pegs.
		C P	Clears the pegs.
Miscellaneous	Baud Rate	BAUD	Displays the current baud rate setting. The available baud rates are 300, 600, 1200, 2400, 4800, 9600, and 19200.
	LAN Card	CD x	For Digital Networking, removes the LAN card from service.
		CU x	For Digital Networking, returns the LAN card to service. x = slot number
	Automatic Message Purge	APURGE x y z	Starts the message purge function if Automatic Message Purge is not already in progress. Displays the thresholds specified and asks for confirmation before initiating the message purge function. x = save threshold y = new threshold z = Net Name
	Automatic Message Purge	CPURGE	Cancels message purge if it is in progress, regardless of whether it was initiated automatically or by the APURGE command. Asks for confirmation before cancelling message purge.
	Message Purge	MBLOCK x y	Blocks a message from being played. It prevents a mailbox holder from starting to play, or replay, the message after it is blocked. x = message header number y = indicates that the message is to be blocked.

Quick Reference Guide

Maintenance Commands

Section	Subject	Command	Information	
Miscellaneous (continued)		MPURGE x	Deletes the message from every mailbox the message was sent to on the message server except for messages that were forwarded or sent over the network. x = message header number	
	Back up and Restore	FLOPPY	Used to back up and restore greetings, names, scripted and sequential messages, and personal distribution list names. Also used to load system prompts.	
	Allowable Commands	HELP	Displays the allowable commands for the password level of operation currently logged in to.	
	System Configuration	INSTA	Command to enter the system configuration program INSTALL. This program consists of a series of questions that define the system database.	
	Call Detail Record, Call Processing and Moves, Adds, Changes Trace	LOG	Used to collect detailed information about specific events for Call Processing Trace activities Call Detail Record log activities, and Moves, Adds, Changes log activities..	
	Internal Modem		MOD DISABLE	Blocks access to the Octel Overture 200/300 via the internal modem.
			MOD ENABLE	Restores access to the Octel Overture 200/300 via the internal modem.
	Password		PASS x y	Sets the password. x = password level y = new password. There are three password levels. Each password may be a maximum of eight alphanumeric characters, 0–9 and A–Z. All alpha characters must be in capital letters.

Quick Reference Guide

Maintenance Commands

Section	Subject	Command	Information
Miscellaneous (continued)	Patch Status	PAT STAT	This command shows the status of all patches currently applied on the message server, the patch number, the date the patch was applied and the target(s).
	Restart	RESTA	Restarts the CPU. All active ports are dropped, and the modem is dropped. The maintenance level password must be entered before restart begins.
	Restart	RESTA 2	Restarts the CPU. Reloads software from the hard disk. All active ports are dropped, and the modem is dropped.
	Time	TIME	Displays the current system date and time. Used only at the @ prompt.
	Network Failures	L NF	Lists Protocol 2 or Protocol 4 failures. Refer to the <i>Networking</i> volume — REMOTE ANALOG NETWORKING chapter for details.
	List Drive Map	L DMAP	S3.0 Provides disk information report on the physical characteristic of the disk drive.
	VCU	VCU	S3.0 Connects to the VCU. It provides detailed drive status, drive configuration, message header information on installed hardware. In addition, from this command you can enter the L DMAP command to get more details.
	Write Protect Drive	WPDISK	S3.0 This command write protects a disk drive to prevent any new messages from being created on that drive.

6.1 COMMAND SUMMARY

Maintenance commands for the Octel Overture™ 200/300 message server are entered from the @ prompt. In this chapter, the maintenance commands are divided into five command types:

- ❑ List commands
- ❑ Clear commands
- ❑ Test commands
- ❑ System service mode commands
- ❑ Miscellaneous commands

The basic command input is listed in **BOLD** letters, in the left column. The complete command name is in bold in the right column. In some instances, a modifier and extension might be required to complete the command string. You must press following all command strings before the message server executes the command.

The message server indicates that it is ready to receive information by displaying the @ prompt. For example, to list the Hardware Error Table, at the @ prompt, type

L H

List Commands

Use a **LIST** command to display maintenance tables, such as the Hardware Error Table or Traffic Peg Count Table, features, and mailbox information. A space is always required between the **L** (for **LIST**) and the letter following. At the @ prompt type

L [name]

Command	Basic Definition
L CCM	LIST CCM (Serenade 3.0) Displays the current message server utilization for the Client Controlled Message pool (CCM). This command is used for OctelAccess application development.
L C	LIST CLERR (Serenade 3.0) Used for OctelAccess troubleshooting. Lists the client error log that shows errors that are caused by invalid client requests. The error log contains all relevant information required to isolate the source of the error.
L F	LIST FEATURES Prints the optional packages installed on the Octel Overture 200/300. Lists the maximum number of ports, drives, SCHEDULE Table entries, and mailboxes.
L H	LIST HARDWARE Lists the Hardware Error Table.
L HE x	LIST HEADER Lists the status of a message, where x is the message number.

Command	Basic Definition
L INT x y	<p>LIST INTEGRATION STATUS Lists the current state of the integration board, the diagnostic status, the status of the links, and the pegs, where x is the slot number, and y is the unit number.</p> <p> This command is not used for DPNSS integration.</p>
L M x	<p>LIST MAILBOX Lists the current configuration of the mailbox specified, where x is the mailbox number.</p>
L M x M	<p>LIST MAILBOX MESSAGES Lists information about messages for a specific mailbox, where x is the mailbox number.</p>
L NET x	<p>LIST NETWORK MAILBOX Lists messages pending in analog and digital domain network mailboxes waiting to be sent to the specified network location, where x is the network location code. Beginning with S3.0, the information listed with this command includes the current network delivery schedule(s).</p>
L NET D [x]	<p>LIST NETWORK DOMAIN [LOCATION] Lists messages pending transfer to the domain in general or specific domain locations, where x is the the domain location (optional). Messages that are pending response to LAN queries are also listed.</p>
L NF	<p>LIST NETWORK FAILURES Lists the Network Failure Table, which contains Protocol 2, Protocol 4, Protocol 5, and digital-network errors. The table entries identify the date and time and the system port on which each error occurred. Additional information about each error type is reported in the DATA1 – DATA4 columns. Refer to the <i>Networking</i> volume, Remote Analog Networking and Digital Networking chapters.</p>
L P	<p>LIST PEG Lists the Traffic Peg Count Table.</p>
L PDL	<p>LIST PERSONAL DISTRIBUTION LISTS Lists the number of personal distribution list (PDL) sectors currently used.</p>
L PO x	<p>LIST PORT Lists the current configuration status for the port number specified, where x is the port number.</p>

Command	Basic Definition
L R	<p>LIST REPORT Prints a menu for the type of report to list, as follows:</p> <ul style="list-style-type: none"> 1 = System Performance 2 = Network Traffic 3 = User Message Statistics 4 = User Calling Statistics 5 = Disk Usage 6 = Port Statistics 7 = Mailbox Usage 8 = User Status Detail 9 = Integration Calling Statistics 10 = System Performance by COS
L R x	<p>LIST REPORT NUMBER Lists the report number specified without printing the menu, where x is the report number.</p>
L RT 1	<p>LIST ROUND TRIP TIME Lists the round trip time for message waiting. For integration, this command lists the following, by link:</p> <ul style="list-style-type: none"> <input type="checkbox"/> Number of mailbox holders assigned <input type="checkbox"/> Longest message waiting round trip time <input type="checkbox"/> Total number of ON commands in the trip listed <input type="checkbox"/> Total number of OFF commands in the trip listed <input type="checkbox"/> Current round-trip start-time <input type="checkbox"/> Number of ON commands <input type="checkbox"/> Number of OFF commands
L T	<p>LIST TRACE Prints a menu for type of trace to list, as follows:</p> <ul style="list-style-type: none"> 1 = All Activities 2 = Mailbox Activity 3 = Port Activity 4 = Location Activity 5 = Message Activity 6 = Integration Activity 7 = APlink Activity
L VM	<p>LIST VISUAL MAILBOX USERS Lists the total number of configured Visual Mailbox™ users and the total number of purchased Visual Mailbox licenses.</p>

Clear Commands

Use the **CLEAR** command to clear maintenance tables and reset all data to zero. A space is always required between the **C** (for **CLEAR**) and the letter following. At the **@** prompt, type

C [name]

Command	Basic Definition
C H	CLEAR HARDWARE Clears the Hardware Error Table. Also opens the alarm relay, and turns OFF the alarm LED.
C I x y	CLEAR INTEGRATION Clears the integration pegs, where x is the slot number and y is the unit number.
C P	CLEAR PEG Clears the Traffic Peg Count Table and the System Performance report.
C NF	CLEAR NETWORK FAILURES Clears the Network Failure Table, which contains Protocol 2, Protocol 4, Protocol 5, and digital-network errors.
C R	CLEAR REPORT Gives a menu as follows, for the type of report to clear.
	<pre> 1. SYSTEM PERFORMANCE (IN TRAFFIC PEGS) AND PORT STATISTICS. 2. NETWORK TRAFFIC. 3. USER MESSAGE, USER CALLING AND MAILBOX USAGE. SELECT REPORT TO BE CLEARED. (1 - 3, EMPTY LINE = EXIT).</pre>
C RT 1	CLEAR ROUND TRIP Clears the round-trip time for message waiting.



Test Commands

The following commands test the status of the LAN card connection, alarm callout, forwarding string, initializing string, floppy diskette, hard disk, line card, network location, and message server. At the @ prompt, type TEST or TE, followed by the name of the function to be tested. For example, to test the alarm, at the @ prompt, type

TE A

A space is always required between the TE (for TEST) and the following letter.

Command	Basic Definition
CMD x PING y	For Digital Networking, performs the lowest-level “echo” test from the LAN card at the local end to the destination server. This is the best tool to use to identify whether there is end-to-end connectivity across the digital network between two Octel Overture message servers. It is especially useful to verify that IP addresses are correctly configured. In the command, x is the slot number in which the LAN card is installed, and y is the IP address of the device to which the test Ethernet packet is sent.
TE A	TEST ALARM Tests the alarm call out feature. Places a call to the number specified in the SYSTEM PARAMETER Table — System Parameter 31.

Command	Basic Definition
TE C 1 x y	<p>TEST CHANNEL 1</p> <p>You can use either the TE C 1 command or the CD command to forward ports. Refer to the System Service Mode Commands, Courtesy Up/Courtesy Down, section. In the command, x is the port number or first port in a range of ports (optional), and y is the port number of the last port in a range of ports (optional).</p>
TE C 2 x y	<p>TEST CHANNEL 2</p> <p>You can use either the TE C 2 command or the CD command to cancel forwarded ports. Refer to the System Service Mode Commands, Courtesy Up/Courtesy Down, section. In the command, x is the port number or first port in a range of ports (optional), and y is the port number of the last port in a range of ports (optional).</p>
TE F 1	<p>TEST FLOPPY 1</p> <p>Reads each sector on the floppy diskette and reports any errors detected. This test does not verify data on the diskette for accuracy.</p>
TE L 1	<p>TEST LINE 1</p> <p>Tests the tone reflection. Ports that fail are left in a test state.</p> <p> This command is not used for DPNSS integration. █</p>
TE L 2	<p>TEST LINE 2</p> <p>Tests ring-through capability of all the ports.</p>
TE L 4 x	<p>TEST LINE 4</p> <p>Tests to see whether loop current is present on a specific port, where x is the port number. The port number must be entered in decimals.</p> <p> This command is not used for DPNSS integration. █</p>
TE L 5 x	<p>TEST LINE 5</p> <p>Tests tone reflection on one port, where x is the port number.</p>
TE NET x y	<p>TEST NETWORK</p> <p>Tests network routes to a network location, where x is the network location code (optional), and y is the non-zero show digits entered. Tests all locations if no network location is specified.</p>
TE S	<p>TEST STATUS</p> <p>Tests the temperatures and voltages for the Octel Overture 200/300.</p>

Command	Basic Definition
TE INT x y	<p>TEST INTEGRATION</p> <p>Tells the integration card to run a link self-test, where <i>x</i> is the slot number, and <i>y</i> is the unit number. Used only for message servers with integration cards.</p> <p>☞ This command is not used for DPNSS integration.</p>
T DNET	<p>TEST DNET</p> <p>Use this command for Digital Networking, to get a quick indication of the general “health” of the configuration and hardware at the local and remote cabinets.</p>
TE X x y z	<p>TEST FAX</p> <p>Perform a loopback test on the specified fax channels to verify that the fax modems can send and receive fax data and to test the TDM bus connection. Fax-modem data is sent across the Octel Overture 200/300’s TDM bus, using one of the fax channels as a sender and the other as a receiver. When this transaction is completed, the fax application processor reverses the direction of the data flow and repeats the transaction. In this command, <i>x</i> is the slot number, <i>y</i> is the fax channel, and <i>z</i> is the fax channel. Refer to the <i>Feature Description</i> volume, Fax Mail Plus chapter.</p>
T SNMP	<p>TEST SNMP</p> <p>An Octel Overture 200/300 can inform an SNMP manager system when a qualified hardware error is logged. This command tests the mechanism for an Octel Overture 200/300 to communicate to an SNMP manager system.</p>
DEX x y	<p>Disk EXerciser</p> <p>Tests all hard disk sectors for read errors, where <i>x</i> is the disk number, and <i>y</i> is the region number.</p>

System Service Mode Commands

Use the Courtesy Down command, **CD**, to remove from service ports, fax cards, LAN cards, or integration units or to disable the functionality of the Gateway Link feature. Use the Courtesy Up command, **CU**, to return them to service.

Use the Shutdown command before LAN Backup and Restore procedures to put the message server in an off-line mode without physically restarting or reloading the server. Like Courtesy Down, Shutdown removes ports, fax cards, and integration units from service, and disables digital and analog networking. However, unlike Courtesy Down, Shutdown does not disable the LAN card.

Use the Startup command after a LAN Backup or Restore to bring the message server back online, removing port forwarding, enabling fax cards, integration units, and analog and digital network messaging activity.

☞ Shutdown is required before restoring prompts and system configuration files. It is recommended that Shutdown be used before all LAN Restore procedures to prevent callers and mailbox holders from accessing the server during restore sessions. Such server activity could disrupt the restore procedure. For LAN Backup, if there is any possibility that voice messages being backed up could change during the procedure, the server should be in Shutdown mode.

Command	Basic Definition								
CD x y z	<p>COURTESY DOWN</p> <p>Use the Courtesy Down command with modifiers to remove the following from service:</p> <table border="0"> <tr> <td><input type="checkbox"/> Port or ports</td> <td>CD x y z</td> </tr> <tr> <td><input type="checkbox"/> Integration units</td> <td>CD x y</td> </tr> <tr> <td><input type="checkbox"/> Fax cards</td> <td>CD x</td> </tr> <tr> <td><input type="checkbox"/> LAN cards</td> <td>CD x</td> </tr> </table>	<input type="checkbox"/> Port or ports	CD x y z	<input type="checkbox"/> Integration units	CD x y	<input type="checkbox"/> Fax cards	CD x	<input type="checkbox"/> LAN cards	CD x
<input type="checkbox"/> Port or ports	CD x y z								
<input type="checkbox"/> Integration units	CD x y								
<input type="checkbox"/> Fax cards	CD x								
<input type="checkbox"/> LAN cards	CD x								

For this command, x is the slot number, y is the relative port, or first port in a range or relative unit number, and z is the port number of last port in range of ports (optional).

Port or ports – CD x y z

When you use the CD command to specify ports, the Octel Overture 200/300 forwards the ports specified. If no port is specified, the Octel Overture 200/300 tries to forward all ports. If a port is successfully forwarded, it is left in a forwarded (FWD) state. If a port fails to complete the forward string, it is left in the no-dial-tone (NDT) state. The Octel Overture 200/300 continues to try to forward all ports specified until successful or until you press **Escape**.

 You can also use the command **TE C 1 y z** to forward all ports.

CU x y z	<p>COURTESY UP</p> <p>Use the Courtesy Up command with modifiers to return the following to service:</p> <table border="0"> <tr> <td><input type="checkbox"/> Port or ports</td> <td>CU x y z</td> </tr> <tr> <td><input type="checkbox"/> Integration units</td> <td>CU x y</td> </tr> <tr> <td><input type="checkbox"/> Fax cards</td> <td>CU x</td> </tr> <tr> <td><input type="checkbox"/> LAN cards</td> <td>CU x</td> </tr> </table>	<input type="checkbox"/> Port or ports	CU x y z	<input type="checkbox"/> Integration units	CU x y	<input type="checkbox"/> Fax cards	CU x	<input type="checkbox"/> LAN cards	CU x
<input type="checkbox"/> Port or ports	CU x y z								
<input type="checkbox"/> Integration units	CU x y								
<input type="checkbox"/> Fax cards	CU x								
<input type="checkbox"/> LAN cards	CU x								

In this command, x is the slot number, y is the relative port, or first port in a range or relative unit number, and z is the port number of last port in range of ports (optional).

Port or ports – CU x y z

When you use the CU command to specify ports, the Octel Overture 200/300 tries to initialize and cancels forwarding for the ports specified. If no port is specified, the message server tries to initialize and cancels forwarding for all ports. If a port successfully initializes and cancels forwarding, it goes to the idle (IDL) state. If a port fails to complete either the initialization or cancel forward string, it is left in the no-dial-tone (NDT) state.

 You can also use the command **TE C 2 y z** to cancel forwarding of ports.

Command	Basic Definition
	The following commands also can be used.
CDFAX x y	COURTESY DOWN FAX Removes the fax channel from service.
CUFAX x y	COURTESY UP FAX Returns the fax channel to service.
CDINTG x y	COURTESY DOWN INTEGRATION UNIT Remove the integration unit from service.
CUINTG x y	COURTESY UP INTEGRATION UNIT Returns the integration unit to service.
CDGWL [f]	COURTESY DOWN GATEWAY LINK Removes the OctelAccess server link (gateway) from service. All new requests from a remote OctelAccess server are rejected, and all current requests in progress are finished before communication with the OctelAccess server is stopped. A progress message is displayed. This command is also used to re-initialize the OctelAccess link to recover from serious unexpected error conditions. This courtesy down state is maintained across a reload and restart. Only the CUGWL command can clear this state. f = Type f to force the OctelAccess Server link to shutdown immediately without waiting for in-progress requests or sessions to finish. (optional)
CUGWL	COURTESY UP GATEWAY LINK Returns the OctelAccess linkn (gateway) to service. The following commands are required before restoring prompts and system configuration files and are recommended for all LAN Restore procedures. These commands should also be used for backup procedures when information being backed up could change as the procedure is being run.
SHUTDOWN	SHUTDOWN Use this command to put the message server in an off-line mode, removing ports, fax cards, and integration units from service, and disabling digital and analog networking, but without physically restarting or reloading the system or disabling the LAN card. ⇒ Important: Whenever the SHUTDOWN command is used to put the server in an off-line mode, the STARTUP command must be used to bring the server back online. Even when the server is rebooted after a SHUTDOWN command, it is still necessary to issue the STARTUP command to initialize fax cards and the LAN card.
STARTUP	STARTUP Use this command to bring the message server back online, removing port forwarding, enabling fax cards, integration units, and analog and digital network messaging activity.

Miscellaneous Commands

Use these miscellaneous commands as described in the following:

Command	Basic Definition
APURGE x y z	Starts the message purge function, if Automatic Message Purge is not already in process. This command allows you to specify purge thresholds, with the same restrictions enforced by UPDATE for the message server and CSTAT parameters. Before initiating the message-purge function, this command displays the thresholds specified and asks for confirmation. In this command, <i>x</i> is the save threshold, <i>y</i> is the new threshold, and <i>z</i> is the Net Name.
BAUD	Displays the current baud rate setting of the Octel Overture 200/300. To change the baud rate, enter BAUD at the @ prompt, followed by the desired baud rate. Then change the terminal's baud rate, and press <input type="text" value="Enter"/> when prompted. The available baud rates are 300, 600, 1200, 2400, 4800, 9600, and 19200.
BITTST x	Converts hardware errors data fields into bit sets, where <i>x</i> is the hexadecimal number. Refer to the System Errors and Traffic Pegs chapter, Hardware Errors section, in this volume.
CPURGE x y	Cancel message purge if it is in process, regardless of whether it was initiated automatically or by the APURGE command. Asks for confirmation before canceling message purge. In this command, <i>x</i> is the slot number, and <i>y</i> is the unit number.
DCSTAT [x]	DCSTAT For Digital Networking, this command displays the status of the digital networking channels. You can specify the status of all digital networking channels, a specific channel, or a range.
DEX x y	Reads all disk sectors. Tests each of the specified regions separately, starting with the lowest-numbered region. Up to six drives are tested. Refer to the Hard-Disk-Drive Diagnostics (DEX) section in this chapter. In this command, <i>x</i> is the disk to test, and <i>y</i> is the region to test.
DSKMAP	Displays the last known status of all drives as recorded by the VCU. You can run DSKMAP from the hard disk or from the software diskette.
DSKTST	Tests the drive slot specified, updates the last known status record of the VCU, and displays the status. You can run DSKTST from the hard disk or from the software diskette.
EXPORTNAMES	Creates and manually initiate the Names Directory export file that includes all names directory information. This file is automatically exported to the OctelAccess server.
FINDMBOX	For Digital Networking, to ensure that a mailbox number is unique in a domain, searches for a mailbox in the local USER Table, local Network Name Table, and in the uniform numbering plan domain. The command then prints a status message of the results of each search.
FLOPPY	Used to back up and restore greetings, names, scripted and sequential messages, and personal distribution list names. Also used to load message server prompts. Refer to the Procedures chapter, Greeting Backup/Restore section, in this volume.

Command	Basic Definition
GWLSTAT	<p>This command is used as a diagnostic tool to review the current status of the OctelAccess server link, to determine</p> <ul style="list-style-type: none"> <input type="checkbox"/> Whether the OctelAccess server is up or down and if it is down, why is it down <input type="checkbox"/> Last time the OctelAccess server was initialized <input type="checkbox"/> Number of open sessions <input type="checkbox"/> Statistics about the number of sessions, new calls pending and number of gateways established.
HELP	<p>Displays the allowable commands for the password level of operation currently logged in to.</p>
INSTA	<p>INSTALL</p> <p>Use this command to enter the message-server configuration program, INSTALL. This program consists of a series of questions that define the Octel Overture 200/300 database. Answers to questions can be selected from a list, a default value, or created by the installer.</p> <p>The required INSTALL command must be a minimum of five letters. After you have completed the initial INSTALL program, you must enter a maintenance-level password before the INSTALL program begins.</p>
ISTAT x y	<p>Gives the current status of an integration unit, where <i>x</i> is the slot number, and <i>y</i> is the unit number.</p>
L DMAP	<p>Provides information regarding each drive in the system, including the logical and physical state of the disk, the vendor, the physical and logical size of the disk, and the disk key, for example, non-COD or COD. This command can only be issued after a connection has been made to the VCU. Beginning with S3.0.</p>
LANG	<p>Displays the languages installed. When a language is selected, this command lists the settings for the language. These settings can be modified; however, some settings require a special set of prompts. The settings that can be modified are as follows:</p> <p>SPECIAL TRANSLATE</p> <p>When Japanese and Korean language prompts are used, you can modify this option to specify either Japanese or Korean. This is required, so that various counting and grammar phrases are spoken correctly.</p> <p>CLOCK FORMAT</p> <p>This option is modified to specify whether the message server is configured for 12-hour, or 24-hour clock, or whether the change from a.m. to p.m. occurs at 1:00 for the 12-hour clock mode.</p>

Command	Basic Definition
	<p>SPEAK DATE BEFORE TIME</p> <p>You can modify this option to YES, to cause the server to speak the date before speaking the time. For example, “April fifth at 5:00 p.m.”</p>
	<p>SPEAK DAY BEFORE MONTH</p> <p>You can modify this option to YES, to cause the server to speak the day before speaking the month. For example, “Fifth of April.”</p>
	<p>SPEAK NAME BEFORE “ONE MESSAGE WAITING” PHRASE</p> <p>You can modify this option to YES, to cause the server to speak the name of the message recipient before the prompt “there is one new message for . . . ”</p>
	<p>SPEAK NAME BEFORE “MULTI MESSAGE WAITING” PHRASE</p> <p>You can modify this option to YES, to cause the server to speak the name of the message recipient before the prompt “there are two new messages for . . . ”</p>
	<p>SPEAK NAME BEFORE “CALL FOR” PHRASE</p> <p>You can modify this option to YES, to cause the server to speak the name of the message recipient before an incoming call is announced.</p>
	<p>SPEAK YEAR AS A NUMBER</p> <p>You can modify this option to YES, to cause the server to speak the year as a number. For example, 1997 is spoken as “One thousand, nine hundred, ninety seven.”</p> <p><i>S3.0, this option has been removed.</i></p>
	<p>SPEAK “THOUSAND” WHEN YEAR IS 1XXX</p> <p>You can modify this option to YES, to cause the server to speak the year without the first-digit quantity. For example, 1997 is spoken as “Thousand, nine hundred, ninety seven.”</p> <p><i>S3.0, this option has been removed.</i></p>
	<p>SPEAK SPECIAL PHRASE WHEN YEAR IS X100</p> <p>You can modify this option to YES if the last two digits for years ending in even hundreds should not be spoken. For example, the year 2100 is spoken as “Two thousand, one hundred.”</p> <p><i>S3.0, this option has been removed.</i></p>
LANSTAT	<p>LANSTAT</p> <p>This command gives basic information about the current status of the LAN, including whether the LAN is UP or DOWN, and the state of the high-speed links.</p>
LOG x y	<p>Use this command to collect information about specific events for Call Processing Trace (CPT) activities, Call Detail Record (CDR) log activities, Moves, Adds and Changes (MAC) log activities and Server Activity Trace (SAT) log activities. This command displays the collected data according to specific filters that can limit the time interval and the type of log defined. In this command, <i>x</i> is the specific filter for data collected in the logs, and <i>y</i> is the log to be traced. For details, refer to the Log Commands chapter in this volume.</p>

Command	Basic Definition
MOD DISABLE	<p>MODEM DISABLE</p> <p>Use this command to block access to the Octel Overture 200/300 through the internal modem. When the modem is disabled, if a logon is attempted by pressing <input type="text" value="#"/> <input type="text" value="#"/> <input type="text" value="#"/> <input type="text" value="5"/>, a caller receives the error message “<i>That command is not allowed.</i>”</p>
MOD ENABLE	<p>MODEM ENABLE</p> <p>Use this command to restore access to the Octel Overture 200/300 through the internal modem.</p>
MON2	<p>MONITOR TERMINAL #2</p> <p>Use this option to monitor incoming call records over the RS-232C link (port 2).</p> <p><input type="text" value="F"/> To exit the monitor mode, press <input type="text" value="Escape"/></p>
MON2 H	<p>Use this command to display call record data in hexadecimal format as it is sent by the PBX.</p>
MWL RECALC	<p>Use this command in certain integrations where the PBX lights lamps through a computer (for example, AT&T System 85), when the computer has been out of service. Examines each mailbox to determine whether its message-waiting lamp should be turned ON or OFF.</p>
MWOFF x	<p>Use this command to turn OFF lamp message waiting that the message-server link turned ON. This does not turn off the HASMSG flag that marks the message as newly received. In this command, x is the mailbox number (up to eight digits). For All, enter A.</p>
MWL RELITE	<p>This command is used in certain integrations, when the PBX has been restarted. Use this command to turns ON all message-waiting lamps that were ON before the PBX was restarted. The server checks the HASMSG flag. If it is still set, the lamp is relit.</p>
NAMESTAT	<p>NAMESTAT</p> <p>Use this command to print the status of the Dial-by-Name directory (Names Directory). This command provides overall figures for Dial-by-Name; that is, the number of local names stored and the number of network names stored.</p>
PASS x y	<p>PASSWORD</p> <p>The Octel Overture 200/300 has three password levels. Each password can be a maximum of eight alphanumeric characters, 0–9 and A–Z. Refer to the <i>Configuration</i> volume, Understanding Configuration, Security Protection Procedures and Guidelines section.</p> <p>In this command, x is the password level, and y is the new password.</p> <p>Default passwords are created by the manufacturer. These passwords should be changed immediately. The following describes the three password levels:</p>

Command **Basic Definition**

MAINTENANCE

This level allows full access to message-server diagnostics, error information, and the INSTALL and UPDATE programs. A default password, MAINT, is set by the manufacturer.

ADMINISTRATIVE

This level allows entrance to the UPDATE program. It also allows you to use the LIST and CLEAR commands for the Hardware Error Table, Traffic Peg Count Table, and all reports. A default password, ADMIN, is set by the manufacturer.

REPORT

This level allows you to use the LIST and CLEAR commands for the Hardware Error Table, Traffic Peg Count Table, and all reports, and the DEV command for DID/E&M reports. A default password, REPORT, is set by the manufacturer.

Passwords can be set for each level, as follows:

Level	Set or Change Password
Maintenance	Maintenance, Administration, Report
Administrative	Administration, Report
Report	Report

To set or change the password, at the @ prompt, enter one of the following commands, followed by the password:

PASS A (for administrative)

PASS M (for maintenance)

PASS R (for report)

The message server requests a password when a terminal is connected to the message server, when an already connected terminal is turned ON, or when the modem is accessed. The password entered at that time determines the level of access to the message server. When a task is complete, you should disconnect the terminal from the modem or turn it OFF. This ensures that the appropriate access level is available for the next session.

PAT STA**PATCH STATUS**

Use this command to show the status of all patches currently applied on the Octel Octel Overture 200/300, the patch number, the date the patch was applied, and the targets. If a patch is a special patch, enter sp* following the patch number.

This information is retained through all restarts. Following a reboot, patches that were applied to memory-only are removed from the status database.

After the patch status is displayed, a listing of all patches that are on the message-server hard disk, but not yet applied, are listed.

Command	Basic Definition
PRT x	<p>PRINT TONE Use this command to monitor and print DTMF tones entered by the caller, the DTMF tones sent by the Octel Overture 200/300 port, and the call-progress tones from the PBX to the terminal. This is a real-time command, and it can be initiated on only one port at a time. The information is not stored.</p> <p>In this command, x is the port to monitor. To exit the monitor mode, press <code>Escape</code>.</p> <p>The following lists the types of messages that can be displayed when the PRT command is initiated:</p> <p>ANSWER The Octel Overture 200/300 detected that the called party answered the telephone.</p> <p>NO ANSWER The Octel Overture 200/300 determined that the called party did not answer within the specified time period.</p> <p>SLOW BUSY Reorder tone from the PBX or central office was detected.</p> <p>FAST BUSY Reorder tone from the PBX or central office was detected.</p> <p>VACANT EXT. Solid dial tone from the PBX or central office was detected.</p> <p>FLASH The Octel Overture 200/300 performed a hook switch.</p> <p>NO DIAL TONE The Octel Overture 200/300 did not receive a PBX or central office dial tone.</p> <p>EXPECT DIAL TONE The Octel Overture 200/300 is configured to expect a PBX or central office dial tone.</p> <p>IN-x x is the incoming digit entered by the caller.</p> <p>DIAL-x x is the digits being sent by the Octel Overture 200/300.</p>

Command	Basic Definition
	<p>T ON</p> <p>The Octel Overture 200/300 is reporting that a tone was received from the PBX or central office. The number displayed is the actual time duration of the tone received.</p>
	<p>T OFF</p> <p>The Octel Overture 200/300 is reporting that no tone (silence) was received from the PBX or central office. The number displayed is the actual time duration that no tone was present.</p>
PRTMAP	<p>LIST PORT MAPPING</p> <p>Lists allocation of message server port numbers to ports configured in each slot, and displays the allocation of each port to integration unit.</p>
PS x	<p>PORT STATUS</p> <p>Use this command to print the status of all ports, where x is the non-zero for continuous (optional) printing.</p>
RESTA	<p>RESTART</p> <p>Use this command to restart the CPU. All active ports and the modem are dropped. With the RESTA command, the software is not reloaded from the hard drive.</p> <p>The maintenance-level password is requested before restart is initiated.</p>
RESTA 2	<p>RESTA 2</p> <p>Use this command to restart the CPU, which reloads software from the hard disk. All active ports and the modem are dropped.</p>
SDBG	<p>Use this command to allow card integration trace information to be logged to the message server's call-processing trace log file.</p> <p>To trace APIC and NPIC integrations, at the @ prompt enter</p> <pre>SDBG xx 1 FF yy</pre> <p>where xx is the slot number and yy is either 7F to turn on debug or 00 to turn off.</p> <p>To trace other integrations, at the @ prompt enter</p> <pre>SDBG xx yy 11 zz</pre> <p>where xx is the slot number, yy is the unit number 11 is the link number, and zz is either 7F to turn on debug or 00 to turn off.</p> <p>For example, SDBG 2 1 2 7F turns on debug for slot 2, unit 1, link 2.</p>
TIME	<p>TIME</p> <p>Use this command to display the current message-server date and time.</p> <p> To change the date and time, use the UPDATE program. At the . (dot) prompt, enter MODIFY DATE. the <i>Configuration</i> volume, Update chapter</p>

Command	Basic Definition
UPINTG	UPDATE INTEGRATION Use this command to restart the integration cards, which disrupts call processing for 1 or 2 minutes.
VCU	Use this command to connect to the VCU. It provides detailed drive status, drive configuration, message header information and status on installed hardware. It also provides error status reported by the VCU such as hard disk drive read-write errors. In addition, from this command, you can enter the <code>L DMAP</code> command to get more details about the disk drive.
WPDISK	WRITE PROTECT DISK DRIVE Use this command to write protect a disk, which prevents any new messages from being created on that disk. If a message server with one or more drives in a write-protected condition, a type 34 hardware error is logged.

Refer to *DID/E&M Trunk Interface Installation and Maintenance* manual, Diagnostic and Administrative Commands section, for the commands used to communicate with the DID/E&M Trunk Interface Modules. Refer to the *Direct Access Card (DAC) Installation and Maintenance Manual* for information about direct access cards.

6.2 DIAGNOSTICS

The Octel Overture 200/300 performs self-testing diagnostic programs that run continuously and do not interfere with normal message-server operation. These tests are designed to locate faults in the message server and reduce the need for additional test equipment, circuit descriptions, and schematic diagrams. When errors are detected, they are logged into the Hardware Error Table, by error code, with the fault and its location described.

In addition to the background diagnostics, you can run several diagnostic or test programs by command from a terminal. These demand diagnostics are described in this section.

Poll the message server on a regular schedule by using a 103A- or 212A-compatible modem, or poll it directly through a terminal or teleprinter. Print the Hardware Error Table, Traffic Peg Count Table, System Performance report, and User Statistics report. Study the reports for any abnormal indications, which allows for scheduled maintenance or corrective action, rather than reactive emergency procedures.

 The screen examples shown in this section might differ from the screens for your message server. Fields could be added, deleted, or relocated, depending on the software release.

Mailbox Configuration Status

The mailbox configuration command `LIST MAILBOX` displays information quickly about a specific mailbox. At the `@` prompt, type

```
L M x 
```

For this command, `x` is the mailbox number.

When listing a mailbox configured with multiple INFORMATION Tables, status information is displayed only for the current time period.

The following example shows all possible mailbox-configuration items that can be displayed, including those items added by configuring optional feature packages.

```
@L M 1019
INFORMATION TABLE NUMBER: 10 CLASS OF SERVICE: 10
WITH ATTRIBUTES: 0 7 8 10 12 17 19 24 28 41 48 54 61 64 76 77 79 82 93 94
EXTENSION NUMBER:
MESSAGE WAITING: ON
OFFSITE OR PAGER #: NONE
GREETING: EXTENDED ABSENCE ON
THIS MAILBOX HAS A SECURITY CODE
PERSONAL ASSISTANCE MAILBOX: NONE
WILL USE PORT INTERCEPT
NUMBER OF MESSAGES: 1 NUMBER OF FUTURE DELIVERY MESSAGES: 0
AUTOMATIC FAX DELIVERY: OFF
AUTOMATIC FAX DELETION: OFF
PERSONAL FAX #: NONE
NAMESCAN: ON
USER #: 0014 GREETING MSG. 1294 NAME MSG. #: 1274
MBOX MSG. #: 0000
MSG. WAIT DELAY: 00 OFFSITE ATTEMPTS: 0 MAX ATTEMPTS: 0
LOG-ON LANGUAGE : NONE
SINGLE DIGIT MENU MAX DIGIT: 0 PREFIX DIGITS: NONE

FLAGS: IN-RNG
```

☞ The SINGLE DIGIT MENU MAX DIGIT: and PREFIX DIGITS: fields are for a Single Digit Menu that was created through the USER Table. Entries in these fields override any entries made in INFORMATION Table indexes 4 and 5, associated with the COS for the mailbox.

The FLAGS: field describes the state that the mailbox is currently in. The following definitions are for the flags that might occur.

Screen Text	Definition
LOG-ON	— Mailbox holder currently logged on
SD-USE	— Mailbox in use by SEND TASK
IS-FUL	— Mailbox full
IN-RNG	— Message waiting in range for this mailbox
HASMSG	— Mailbox with a newly received message
MW-CAL	— Message waiting call in progress (or shortly will be)
LMP-ON	— Message waiting lamp turned ON
LP-CAL	— Calling to turn ON/OFF lamp
FX-DEL	— Fax delivery
LPRTY	— Lamp-message-waiting command retry
INTGIP	— Integration lamp command in progress

☞ Distribution lists are not mailboxes and cannot be listed with this command.

Use L M x M as an extension of the mailbox configuration status command to list all the messages and their status for a specific mailbox. To list message information for the mailbox, you must add the letter M to the command. At the @ prompt, type

L M x M

For this command, x is the mailbox number.

An example of this extended command follows:

```

@L M 2000 M
STATUS MSG CRE STATUS MSG CRE STATUS MSG CRE STATUS MSG CRE
10 NEW 50B6 003E 20 SAV 501D 003E 48 LSN 5008 0002 10 NEW 5187 003E
10 NEW 51AC 003E 40 LSN 13FA 0000 40 LSN 5007 0000 40 LSN 3002 0000

FAX STATUS FAX STATUS FAX STATUS FAX STATUS
00 08 FAX 08 FAX 00
08 FAX 28 FAX PERSNL 00 18 FAX GROUP

```

The STATUS, MSG, and CRE columns display information about voice and fax messages. To determine whether a message listed in these fields is a fax, refer to the FAX STATUS column of the corresponding row. If a message is a fax, the fax status is described in the column.

STATUS The abbreviation or term listed in this column indicates whether a message is new (NEW), listened to (LSN), saved (SAV), or tagged for future delivery (FUT).

MSG The message-header number that the Octel Overture 200/300 associates with a specific message is listed in this column. The message-header number is a locator of where voice or fax data is stored on the hard drive.

- CRE** This column contains a hexadecimal user number for the mailbox that created the message. To find out the mailbox number from the hexadecimal number, type @L M x where x is the hexadecimal number. The message server displays the mailbox number.
- FAX STATUS** In this column, in addition to the fax-status code, the wording indicates whether a message is a fax, or a fax marked for delivery to a personal or group fax machine. If the message is not a fax, the fax status displays 00 only.

Message Status

The LIST HEADER command displays information about a message. At the @ prompt, type

L HE x

For this command, x is the message number listed when L M x M is entered.

```

@L HE 1179
CREATOR MAILBOX NUMBER: 1102
EXTENSION MESSAGE NUMBER: 0000
ACM REFERENCE NUMBER: 0000
TIME 05/12/97 07:11
USE COUNT: 00001
ORIGINAL MESSAGE TYPE: 1 (make)
DEPTH OF FORWARDING: 0
MSG TRANSMISSION TYPE: 1
CODE RATE: 24 KBS

          PRIMARY   SECONDARY
VOICE BLOCKS:      00003   00000
VOICE BLOCK SIZE:  8KBYTES 8KBYTES
DISK NUMBER:       1       0
FLAGS:
ADDRESSES:
7364
CALLING PARTY DIGITS: 808

```

For the ORIGINAL MESSAGE TYPES : field, the following lists possible descriptions:

Number	Description
1	Made by message command
2	Forwarded message
3	Reply message
4	Greeting message
5	Name message
6	Broadcast message
7	Message left after call to busy extension
8	Message after no answer/vacant/Centrex
9	Quick message
10	Message left after greeting played or no extension defined
11	Message came from network
12	Return receipt message
13	Message has been forwarded on the network
14	Mailbox is full
15	Mailbox does not exist
16	Disk full
17	Routes failed too many times
18	Message undeliverable
19	Too many addresses for location
20	Generic mailbox failure (Octel networking)
21	Not used
22	Auto-forward of a broadcast message
23	Personal Distribution List name message
24	Send failure caused by mailbox being full
25	Record AP processor
26	Sent by AP processor
27	Network clone message
28	Broadcast message to collocated cabinet
29	Standard fax message
30	Message left after forward from busy extension
31	Message left after forward from no answer
32	Message left after all forward
33	Fax recorded for an application processor
34	Fax voice annotation

Network Diagnostics

Use the LIST NETWORK command to allow messages pending to be listed for analog locations to be listed. The diagnostic commands available for networking depend on whether the networking is analog or digital.

Type LIST NET to allow messages pending for analog and domain locations to be listed. Whether listing an analog network location or a domain location, the screen displays the information in the same format.

Beginning with S3.0, Network Schedule Table information is displayed. The screen display changes to show the appropriate network delivery schedule information.

```

@L Net ...
LOCATION FRAME NUMBER: 0000
DELIVERY SCHEDULE : NORSCH                CURRENT WINDOW :DEFAULT,2,3,4,5
START TIME: 07:00  END TIME : 12:00
INTERVAL : 0 Minutes
LAST OUTCALL : 12/21/1997  08:07
DELAY: 00000 MIN.
ERRORS: 00000
LIMIT: 00000
MESSAGE #
1BB2

```

LOCATION FRAME NUMBER	Octel internal use only.
DELIVERY SCHEDULE	This is the name of the Network Schedule used.
CURRENT WINDOW	All message delivery windows that are open/active for that location at the current time.
START TIME END TIME	The start and time for the delivery schedules.
INTERVAL	The minimum time for which a message must wait before an outcall is made.
LAST OUTCALL	The date and time of the last outcall.
DELAY	The entry in this field shows how many minutes the message server waits before attempting to send remaining messages after a failure. Its value is set by System Parameter 69 — NET: REMOTE DELAY BEFORE RETRY (MIN). For Digital Networking, this field applies only when a particular domain location is listed.
ERRORS	The entry in this field is the number of times a network call or message attempt to this location has failed. For Digital Networking, this field applies only when a particular domain location is listed.
LIMIT	The entry in this field shows how many times the message server retries network calls to this location before returning the current message to the creator's mailbox. Its value is set by System Parameter 68 — NET: REMOTE DELIVERY ATTEMPT LIMIT. For Digital Networking, this field applies only when a particular domain location is listed.
MESSAGE #	This field lists the hexadecimal header number of all messages waiting to be sent. Refer to the Message Status section in this chapter.

Beginning with S3.0, this can also be the message priority for Network Delivery Schedules listed.

For Digital Networking, if the listing is for all domain locations, the header numbers of all messages in the domain waiting to be sent are listed. If the listing is for a particular domain location, the header numbers of messages waiting to be sent to that particular domain location are listed.

**MESSAGE
PENDING QUERY**

Domain messages could be delayed in the predelivery processing and might not show up in the list of messages pending for a specific location. These messages appear under this heading.

Network Mailbox Status for Analog Networking

Use the `LIST NETWORK MAILBOX` command to display information contained in the network mailbox about a specific location, including the message numbers of all the messages in the network mailbox waiting to be sent to that location. It also shows the current delay (in minutes), the error retry count, and the retry limit.

L NET x

For this command, x is the location of the system to which the messages will be sent. The command can also be abbreviated as L N.

```
@L Net 6400
LOCATION FRAME NUMBER: 0005
DELAY: 00000 MIN.
ERRORS: 00000
LIMIT: 00010
MESSAGE #
000E
0010
0012
```

Network Domain Status for Digital Networking

Use the `LIST NETWORK DOMAIN` command to list the messages pending for all domain locations within a uniform-numbering-plan domain. The following example shows such a listing:

```
@L NET D
<ALL DOMAIN MESSAGES>
LOCATION FRAME NUMBER: 0002
MESSAGE #
2001
3002

MESSAGES PENDING QUERY:
4003
5002
6002
```

If the `LIST NET` command is followed by digits from the uniform numbering plan of a domain, the messages pending for all domain network locations are listed. For example, the command `LIST NET 4`, where the digit 4 is the first digit in the uniform numbering plan, gives exactly the same listing as `LIST NET DOMAIN` in the preceding example.

You can list information about a specific domain location, rather than all domain locations, by adding the location name after the `D` in the `LIST NET D` command, as follows:

```
@L NET D DALLAS
LOCATION FRAME NUMBER: 0004
DELAY: 00002 MIN.
ERRORS: 00000
LIMIT: 00001
MESSAGE #
2001
```

LAN Status

Use the `LANSTAT` command to provide basic information about the **current** status of the LAN card, digital networking and the Gateway Link. Information about the status of the LAN for previous periods in the Network Traffic Report for Digital Networks and the Digital Network Performance Report. For information about those reports, refer to the Reports chapter, Network Reports section, in this volume.

Use the `LANSTAT` command for information about the current status, whether the LAN is UP or DOWN and the state of the high-speed links.

The following example shows that the LAN is up and running:

```
@LANSTAT
LAN STATUS: UP
LAST INITIALIZED ON 05/25/97 AT 06:05 PM

DIGITAL NETWORKING STATUS: UP

----- HIGH-SPEED-LINK STATUS -----
LOCATION          STATUS    LAN-PRCL  OTHER
-----
SELF            -         3
CHCGO           UP        2
NEWYRK          DOWN     -
DALLAS          DOWN     1          OEM-FAIL
SFO             UP        3
-----

GWL STATUS: DOWN - GATEWAY LINK SYSTEM PARAMETER IS NOT ENABLED
@
```

The entry in the `LAN STATUS` field is always UP, INITIALIZING, or DOWN.

LAN Status

The LAN card is running, with CPU communication to the card. The LAN is running normally. If a Courtesy Down is in progress, the message `COURTESY DOWN IN PROGRESS` is shown.

When the LAN status is UP, the high-speed link status is given for each high-speed digital location, as follows:

- LOCATION The entry in this column is the location name.
- STATUS The entry in this column is the status of the link to this location, which is either UP or DOWN.
- LAN-PRCTL The entry in this column is the Digital Networking Protocol level of the other system. This entry allows compatibility with future releases. It does not relate to analog protocol numbering.
- OTHER The entry in this column can be one of the following: HNDSHAKE, waiting for start-up handshake reply; OEM-FAIL, cannot establish connection, OEM mismatch.

INITIALIZING Entry

The LAN is in the initialization process. The current status of the initialization process is given, from among the following:

- WAITING FOR LAN-REBUILD TO COMPLETE
- WAITING FOR LAN-BOARD TO START
- WAITING FOR LAN INFO FROM VCU
- STARTING HIGH-SPEED CONNECTIONS

DOWN Entry

CPU communication to the LAN card is not UP, and no LAN activity is possible. The reason, if known, is given. The following are possible reasons:

- System does not have the Digital Networking feature.
- A COURTESY-DOWN is in process.
- LAN SYSTEM PARAMETER NOT ENABLED.
- LAN BOARD NOT CONFIGURED IN SLOTS TABLE.

At any time during the listing of the LAN status, you can press **Escape** to terminate the listing within a line or two.

Status of FINDMBOX

Use the command `FINDMBOX` to search for a mailbox in the local `USER` Table, local Network Names Table, and Uniform Numbering Plan Domain. The command then prints a status message of the results of each search. Refer to Table 6-1 for a list of the status messages.

Table 6-1 FINDMBOX Messages and Descriptions

Status Messages	Description
FOUND IN LOCAL USER TABLE	The mailbox exists in the local <code>USER</code> Table.
NOT FOUND IN LOCAL USER TABLE	The mailbox does not exist in the local <code>USER</code> Table.
FOUND IN LOCAL NETNAME TABLE, EXISTS IN XXXXXX	The mailbox is found in the local Network Names Table, which says that it exists in XXXXXX.
NOT FOUND IN LOCAL NETNAMES TABLE	The mailbox was not found in the local Network Names Table.

Table 6-1 FINDMBOX Messages and Descriptions (continued)

Status Messages	Description
FOUND IN DOMAIN LOCATION YYYYYY	Domain location YYYYYY sent a positive response to the query; that is, the mailbox exists in YYYYYY.
NOT FOUND IN ANY OTHER DOMAIN LOCATION	All locations in this domain sent negative responses to the query.

The FINDMBOX command is useful for the following:

- Ensuring that a mailbox number is unique in a domain
- Detecting stale entries in local Network Names Tables where a mailbox has been moved from one location to another in the domain

You can use the FINDMBOX command to search for a single mailbox or a range of mailboxes. To use the command to search for a single mailbox, at the @ prompt, type

```
FINDMBOX x 
```

For this command, x is the mailbox number to be searched for.

To use the command to search for a range of mailboxes, at the @ prompt, type

```
FINDMBOX x y 
```

For this command, x is the first mailbox number in a range of mailboxes to be searched for, and y is the last mailbox number in the range.

 Press to abort this command.

The following is an example of the FINDMBOX command:

```
@FINDMBOX 4573
FOUND IN LOCAL USER TABLE.
FOUND IN LOCAL NETNAMES TABLE, EXISTS IN NYORK1.
FOUND IN DOMAIN LOCATION NYORK1.
FOUND IN DOMAIN LOCATION CHICGO.
@
```

Print Status of LAN

Use the DCSTAT command to print the status for all digital networking channels, for only the LAN channel specified, or for a range of digital networking channels specified. With the C option, you can continuously print the status for the digital networking channel number specified.

- To use the command to print the status for all digital network channels, at the @ prompt, type

```
DCSTAT 
```

- To use the command to print the status for only the digital network channel specified, at the @ prompt, type

```
DCSTAT x 
```

For this command, x is the channel number.

- To use the command to print the status for a range of digital network channels, at the @ prompt, type

```
DCSTAT x y 
```

For this command, x is the first digital network channel number in a range, and y is the last digital network channel number in the range.

- The Continuous option repeats the command until you press . To use the command to print the status continuously for the digital network channel specified, at the @ prompt, type

```
DCSTAT x C 
```

For this command, x is the digital network channel number and C specifies continuous print.

-  Press to interrupt this command.

The following is an example of the DCSTAT command display:

```
@DCSTAT
LCH01  LCH02  LCH03  LCH04  LCH05  LCH06  LCH07  LCH08
IDLE   IDLE   SND    IDLE   IDLE   IDLE   CONN   CONN

LCH09  LCH10  LCH03  LCH04  LCH05  LCH06  LCH07  LCH08
IDLE   SND    SND    IDLE   IDLE   IDLE   CONN   IDLE
@
```

Low-Level Echo Test (CMD PING)

Use the CMD PING command for the lowest-level “echo” test from the LAN card at this end to the destination server. It verifies that all the basic requirements are there, as follows:

- Both LAN cards are there, up and running, and talking to the CPU.
- LAN end-to-end data transfer is possible across the digital network.
- The LAN card IP addresses are correctly configured.

This is the best tool to use to identify whether there is end-to-end connectivity across the digital network between two Octel Overture message servers. It is especially useful to verify that IP addresses are correctly configured.

To use the command, at the @ prompt, type

```
CMD x PING y 
```

For this command, *x* is the slot number in which the LAN card is installed, and *y* is the IP address of the device to which the test Ethernet packet is sent.

 For additional Networking diagnostic information, refer to the *Networking* volume, Digital Networking chapter, Network Maintenance and Troubleshooting section.

Port Configuration Status

Use the LIST PORT command to list the current configuration status for a port. At the @ prompt, type

```
L PO x 
```

For this command, *x* represents the port number.

When a port is configured to use different INFORMATION Tables, only current information is displayed.

The following example shows various items that can be displayed, including those added by optional feature packages.

```
@L PORT 1
CLASS OF SERVICE: 241 WITH ATTRIBUTES:
USE FOR OUTCALL: YES ANSWERING MODE: AX
PORT TYPE: LIC4 TEST PORT: YES
INFORMATION TABLE NUMBER: 254
INTERCEPT MAILBOX: 4932 INTERCEPT EXTENSION: 1000
PORT EXTENSION: 300 COMPANY GREETING MAILBOX: 4665
```

Port Mapping Status

Use the `PRTMAP` command to display information about the assignment of message-server port numbers to ports configured in each slot. This command also displays the assignment of each port to an integration unit. At the `@` prompt, type

```
PRTMAP 
```

If the PBX type is `ATT75`, each port can be assigned to more than one integration unit. If the PBX type is not `ATT75`, each port can be assigned to **only one** integration unit and is assigned a line-appearance number for that integration unit.

If a port is assigned to an integration unit and that port has the COS attribute for nonintegration, Attribute 58 — `DO NOT USE THIS PORT FOR INTEGRATION`, this command prints `***` after the integration information for the port. The discrepancy in the configuration must be resolved, either by removing the COS attribute from the port or removing the port from all integration units.

The following is an example of the `PRTMAP` command without `ATT75` assigned:

```
@PRTMAP
SYSTEM
PORT      SLOT      PORT      EXTN      INTEGRATION      LINE
ID= 0
1          1          1          1210      10/1              1
2          1          2          1211      10/1              2
3          1          3          1212      10/1              3
4          1          4          1213      10/1              4
ID= 0
5          2          1          125       10/1              5
```

The following is an example of the `PRTMAP` command with `ATT75` assigned:

```
@PRTMAP
SYSTEM
PORT      SLOT      PORT      EXTN      INTEGRATION
ID= 0
1          1          1          121       10/1 10/2 11/1 11/2
2          1          2          122       10/1 10/2 11/1 11/2
3          1          3          123       10/1
4          1          4          124       10/2
ID= 0
5          2          1          125       10/2
```

Floppy-Disk-Drive Diagnostics

Use the floppy-disk-drive (FD) diagnostic command `TEST FLOPPY 1` to isolate faults to the diskette, floppy-disk drive, or floppy-disk controller. To run this test, at the `@` prompt, type

```
TE F 1 
```

This test reads the entire diskette; if there are errors, the message server responds with the following:

```
SOFT ERRORS DETECTED
```

or

```
FATAL ERROR DETECTED, SEE HARDWARE ERROR TABLE
```

When the diagnostic is completed, the message server responds as follows:

```
TEST 01 COMPLETED
```

If the message server fails to read from or write information to the diskette on the first attempt, but is successful in a subsequent attempt, the message server records a soft error. Soft errors can be caused by diskette wear, contamination on the recording surface, or aging of the floppy-disk-drive head.

Refer to the Installation chapter for information about the floppy-disk write-protect feature.

Hard-Disk-Drive Diagnostics (DEX)

The purpose of the DEX command is to “exercise” the disks; hence its name **Disk EXerciser**. Because only a small percentage of disk sectors are accessed in the course of normal operation and disk-error handling cannot be performed for any sectors that are never accessed, DEX provides an orderly and efficient means to read all disk sectors.

Each disk is divided into five regions, as follows:

Region 1	Critical sectors
Region 2	File system
Region 4	Prompts
Region 8	Message headers
Region 10	Voice data

DEX tests each of the specified regions separately, starting with the lowest-numbered region through the highest-numbered region. Up to six drives are tested.

When the DEX command finishes testing a region, it displays a status line, as follows:

```
REGION WW COMPLETE  DISK #1:  XXXXX  DISK #2:  XXXXX  DISK #3:  XXXXX
                     DISK #4:  XXXXX  DISK #5:  XXXXX  DISK #6:  XXXXX
```

Where *ww* is the Region tested, and *xxxxx* is the Number of sectors on the disk that had read errors.

All drives are listed on the status line, even if not installed. If not installed, zeros are displayed.

To use the command, at the @ prompt, type

DEX *x y*

Where *x* and *y* are one of the following:

x = DISK

This argument specifies which disk to test:

- 1 = Test disk #1 (if system drive #1 is installed)
- 2 = Test disk #2 (if system drive #2 is installed)
- 3 = Test disk #3 (if voice drive #3 is installed)
- 4 = Test disk #4 (if voice drive #4 is installed)
- 5 = Test disk #5 (if voice drive #5 is installed)
- 6 = Test disk #6 (if voice drive #6 is installed)
- FF = Test all disks (or those disks that are actually installed)
- = Abort background DEX

If all disks are specified but not all are installed, DEX tests only those disks that are actually installed. If an invalid option is specified, DEX responds with the following:

INVALID DISK NUMBER or DISK EXERCISE ABORTED

If none of the specified disks are actually installed, DEX responds with the following:

DRIVE NOT INSTALLED

y = REGION

This argument specifies which regions to test:

- 1 = Critical sectors
- 2 = File system
- 4 = Prompts
- 8 = Message headers
- 10 = Voice data
- = All regions

Voice drives have two types of regions, Critical sectors and Voice data. When running DEX to test all regions for all system and voice drives (that is, DEX FF), invalid regions of the voice drives are ignored, but the corresponding regions on the system drives are exercised.

 The DEX report for a voice drive region that does not exist displays zero errors.

The following example shows all regions on disk 1 tested:

```
@DEX 1

REGION 01 COMPLETE      DISK #1:00000      DISK #2:00000      DISK #3:00000
                        DISK #4:00000      DISK #5:00000      DISK #6:00000
REGION 02 COMPLETE      DISK #1:00004      DISK #2:00000      DISK #3:00000
                        DISK #4:00000      DISK #5:00000      DISK #6:00000
REGION 04 COMPLETE      DISK #1:00003      DISK #2:00000      DISK #3:00000
                        DISK #4:00000      DISK #5:00000      DISK #6:00000
REGION 08 COMPLETE      DISK #1:00000      DISK #2:00000      DISK #3:00000
                        DISK #4:00000      DISK #5:00000      DISK #6:00000
REGION 10 COMPLETE      DISK #1:00012      DISK #2:00000      DISK #3:00000
                        DISK #4:00000      DISK #5:00000      DISK #6:00000
DISK EXERCISE COMPLETE
```

If any errors are reported, refer to the Hardware Errors section in this chapter.

Disk Information Status (L DMAP)

Beginning with Serenade 3.0, the L DMAP command is used to display characteristics of each drive installed in the system. You must connect to the VCU before you can enter this command. You can determine the drive status, the drive manufacturer, the physical and logical size of each disk, and how the disk is keyed from the information displayed.

At the @ prompt type

```
VCU 
```

A> appears. At the A> prompt type

```
L DMAP 
```

To return to the @ prompt, enter E .

```
@VCU
Connecting to VCU
VCU 1.11 cksum=(1e0b843) Link:08/27/97 - 01/14/98 20:27
A>L DMAP
dev dsk log phy vendor prod_ID rev Mb phy/ log Mb h/k
0 --- - -
1 --- - -
2 1/1 ACT ALV SEAGAT ST1480 5736 406 cb40e/ cb40e 406 0/1
3 --- - -
4 --- - -
5 --- - -
6 --- - -
A>E
@
```

dev = Logical SCSI disk identification number
dsk = Disk number/total number of disks
log = Logical state of the system
ACT = Disk is actively used by the system

ERR = Disk has non-recoverable error
 VLD = Disk part of configuration, but needs rebuild.
 UNK = Disk is valid, but not part of this configuration
 INV = Disk does not have valid configuration block
 WPD = Disk slot is write protected
 phy = physical state of the disk
 ALV = Disk is alive
 ERR = Disk has error
 ILL = Disk is not a valid disk for the model defined
 vendor = Disk manufacturer details
 prod_ID = Disk manufacturer details
 rev = Disk manufacturer detail
 Mb = Physical size of the disk in Megabytes
 phy = Physical size of the disk in disk blocks
 /log = Logical size of the disk in disk blocks
 MB = Logical size of disk in Megabytes
 h/k = OEM identification/ Key revision (1=Non COD, 3=COD)
 h = OEM key: 0/1 = Octel and 2/3/5 = OEM
 k = COD/non-COD: 1 = non-COD and 3 = COD

 A COD drive cannot be copied to a non-COD drive.

Line-Interface-Card Diagnostics

Three online diagnostic tests can be used to test the line interface cards (LIC). The first test is performed periodically during normal message server operation. It is used to check the analog (voice) path of the LIC. The second test is the ring detection/PBX connection test. The third test is the ring-through test. These tests are described in the following sections.

Tone/DTMF/Beep Test

Use the `TEST LINE 1` command to test line 1. To run the test, turn the terminal or teleprinter ON. At the @ prompt, type

```
TE L 1 
```

This test runs in sequence on each of the installed ports.

Use the `TEST LINE 5 x` command to test line 5 for a specific port. At the @ prompt, type

```
TE L 5 x 
```

For this command, x is the specific port number in HEX.

A hybrid transformer is used on the LIC to check tone generation and detection circuitry. A tone is applied to the hybrid transformer and, as it is being reflected, the tone detector is turned ON. A comparison is made to see whether the tones sent match the tones detected. The test sequence continues, through all assigned ports. If a test tone sent is not received correctly, an error is entered in the Hardware Error Table.

Some PBXs have the capability of running diagnostics on their ports. The diagnostics can cause the Octel Overture 200/300's self-test to fail and place the Octel Overture 200/300 port in TST (test) mode, taking the port out of service. The port remains in TST mode until the self-test runs again and can put the port in service or until the message server is restarted. In cases of conflict with PBX diagnostics, the self-test can be disabled in the SLOTS Table. Consult with Octel before you set the self-test to NO in the SLOTS Table.

Ring Detection/PBX Connection Test

Use the `TEST LINE 4` command for this test. To run the test, turn on the terminal or teleprinter. At the `@` prompt, type

```
TE L 4 x 
```

For this command, `x` is the installed port number (in HEX) to be tested.

This test runs only on the port requested in the command, and the port must have the self-test parameter in the SLOTS Table set to YES.

This port is rapidly seized and released repeatedly. This action causes charging and discharging of the tip-and-ring circuitry on the LIC, if the port is correctly connected to the PBX. These pulses trigger the ring-detection circuitry on the port.

The test is completed successfully when the LIC reports the detection of this “ringing” to the CPU. If ringing is not detected, the test terminates unsuccessfully after 5 seconds and leaves the tested port in the TST mode, removing the port from service. An error is also logged in the Hardware Error Table.

 Some PBXs are not capable of generating sufficient voltage or loop current quickly enough for the test to succeed. One example is the Northern Telecom SL1. Consult with Technical Support if you are uncertain whether a particular PBX supports this test.

Ring-Through Test

The ring-through test is run **only on demand** and should be used only when the Octel Overture 200/300 is initially installed or when it is known that no calls are being processed.

The ring-through test performs the following sequence:

1. Seizes a port
2. Waits for dial tone from the PBX
3. Sends digits to a port using the extension number entered in the SLOTS Table
4. Waits for the port to answer, and sends a test pattern

For example, a four-port message server makes 12 test calls; each test call takes 20 to 30 seconds to complete. If the port called is busy or does not answer, an error is logged in the Hardware Error Table. The command for this test is `TEST LINE 2`. To initiate the test, at the `@` prompt, type

```
TE L 2 
```

Update Integration

The following changes to integration slots require that the integration cards be restarted before the changes take effect:

- Adding or deleting integration slots
- Modifying line appearances for an integration slot
- Enabling or disabling message waiting links

When any of these changes are made, the Octel Overture 200/300 presents the following message when exiting from the UPDATE program.

```
WARNING:  FOR CHANGES TO TAKE EFFECT INTEGRATION MUST BE RESTARTED
```

To execute the command UPDATE INTEGRATION, at the @ prompt, type

```
UPINTG 
```

The Octel Overture 200/300 then prompts the following:

```
RESTART INTEGRATION . . . ARE YOU SURE YOU WANT TO DO THIS?
```

This command restarts the integration cards and, therefore, disrupts call processing for approximately 1 or 2 minutes.

Port Status

The command PORT STATUS displays the current state of the installed ports. At the @ prompt, type

```
PS 
```

The message server responds with the current state of each installed port.

```
CH 1  CH 2  CH 3  CH 4  CH 5  CH 6  CH 7  CH 8
LSN  IDL   LSN  NEW  MOD  IDL  IDL  IDL

CH 9  CH 10 CH 11 CH 12 CH 13 CH 14 CH 15 CH 16
IDL  IDL   IDL  IDL  IDL  IDL  NMS  IDL

CH 17 CH 18 CH 19 CH 20 CH 21 CH 22 CH 23 CH 24
ERR  ERR   ERR  ERR  ERR  ERR  ERR  ERR

CH 25 CH 26 CH 27 CH 28 CH 29 CH 30 CH 31 CH 32
FX.IDL FX.RCV FX.SND FX.IDL FX.IDL FX.IDL FX.IDL FX.CDN
```

The port states are shown under each port channel (CH 1, etc.) and the ports might be in any of the states listed in Table 6-2.

Table 6-2 Abbreviations for Channel/Port State

Port State Abbreviation	Description
ACM	CALLER USING OCCI HEARS GREETING AND MESSAGING INSTRUCTIONS
ACR	CALLER USING OCCI IS RECORDING A MESSAGE
ADR	COLLECT ADDRESS FOR A MESSAGE
AFC	AUTO COPY CONFIGURATION
AFZ	PLAY ALL PHRASES
AIC	(ASSISTED INWARD CALLING) CALLING A USER OR PLAYING A GREETING
ALM	ALARM-CALL-OUT
AMR	AMIS MESSAGE RECEIVE
APP	APPLICATION PROCESSOR LINK
APR	PLAY ALL PROMPTS
CHK	CHECK FEATURE
CON	CONFIGURATION, MSG WAITING PARAMETERS OR SECURITY
DID	DID
DIG	IN-BAND DTMF INTEGRATION
DIR	DAC ADDRESS COLLECTION
DRP	DROPPING CALL
EXT	EXIT
ERR	LINE CARD FOR PORT HAS REPORTED A FATAL ERROR
FAX	FAX BOARD CHANNEL STATE
FGT	FORCED GREETING RECORD
FNM	FORCED NAME RECORD
FXA	PRINT ALL FAX
FXC	FAX CONNECT (RECEIVE/SEND)
FXO	FAX MAILBOX CONFIGURATION OPTIONS
FXP	FAX MAILBOX PRINT OPTIONS
FX . ALC	ALLOCATED FAX CHANNEL
FX . CDN	COURTESY DOWN FOR FAX CHANNEL
FX . IDL	FAX IDLE
FX . INT	FAX CHANNEL INITIALIZATION
FX . RCV	RECEIVING FAX
FX . SND	SENDING FAX
FX . TST	FAX CHANNEL TEST
FUT	FUTURE DELIVERY LISTEN
FWD	FORWARDED TO DIGITS IN SYSTEM PARAMETER TABLE
GRT	GREETING
HLP	ASKING FOR HELP
ID2	BUSY OUT PORT AFTER RING IN

Table 6-2 Abbreviations for Channel/Port State (continued)

Port State Abbreviation	Description
IDL	IDLE
LSN	LISTENING TO A MESSAGE
MSW	MESSAGE WAITING
MOD	THIS PORT IS CONNECTED TO THE MODEM
NAM	NAME SETUP
NDT	NO DIAL TONE WHEN ATTEMPTING TO FORWARD OR INITIALIZE PORTS
NET	NETWORKING
NEW	CREATE NEW, FORWARD, REPLY OR GREETING MESSAGE
NMD	NAMES DIRECTORY STATE
NMR	NET MESSAGE RECEIVE - PROTOCOL 1
NMS	NET MESSAGE SEND - PROTOCOL 1
NNR	NETWORK NAME RECEIVE
NTS	NET TEST STATE
OMC	OFFSITE MESSAGE WAITING CONFIGURATION
OMR	OCTELNET MESSAGE RECEIVE
OMS	OCTELNET MESSAGE SENT
QAD	COLLECTING AN ADDRESS FOR A QUICK MESSAGE
QCK	RECORDING A QUICK MESSAGE OR MESSAGE AFTER CALL
PAC	PERSONAL ASSISTANCE CONFIGURATION
PDL	PERSONAL DISTRIBUTION LISTS
RDY	WAITING FOR COMMAND AT READY
RNM	USER RECORD OWN NAME
SCR	SCRIPTED GREETING
SLQ	SELECT MESSAGE QUEUE
STR	START OF INITIAL LOGON BEFORE READY
TST	SELFTTEST IN PROGRESS OR PORT HAS FAILED SELFTTEST
VMR	NET MESSAGE RECEIVED - PROTOCOL 2
VMS	NET MESSAGE SEND - PROTOCOL 2
WFA	WAITING FOR MAILBOX ADDRESS AFTER RECEIVING #
WFD	WAITING FOR FIRST DIGIT AFTER ANSWERING CALL

Alarm Test

The `TEST ALARM` command tests the alarm callout feature. At the `@` prompt, type

```
TE A 
```

The message server attempts to call the string configured in System Parameter 31 — `ALARM NUMBER`. If successful, the person answering the alarm call hears a message similar to the following:

“Beep-Beep-Beep-Beep. This is an alarm call from message server number 123. Error type O has occurred. Press star to acknowledge alarm notification or press pound to connect to the modem.”

If not acknowledged, the message server disconnects the call after 1 minute and retries it every 10 minutes, until it is acknowledged (the listener presses).

To log on for remote access, proceed as follows:

1. Press . The line *Beeps* for up to 3 minutes, which allows time to connect the modem and the terminal.
2. Press when ready. This connects the modem, which enables remote access to the Octel Overture 200/300.

 If the person answering the alarm call does not enter a second , the server disconnects the call and continues to retry every 10 minutes, until the call is acknowledged.

Use the `LIST HARDWARE` command to list the Hardware Error Table after testing the alarm or enabling remote access. At the `@` prompt, type

```
L H 
```

The Octel Overture 200/300 prompts `*** ALARM HAS BEEN GIVEN ***` to indicate an alarm test was performed. The command `CLEAR HARDWARE` clears this test message. At the `@` prompt, type

```
C H 
```



You must clear the Hardware Error Table to reset the Octel Overture 200/300 callout feature, or the Octel Overture 200/300 will not attempt to call the alarm number when a true alarm occurs. If the Table shows other errors, refer to the System Errors and Traffic Pegs chapter, Hardware Errors section, in this volume.

 The `TE A` command also closes the Alarm Relay and turns ON the Alarm. The `C H` command reopens the Alarm Relay and turns OFF the Alarm.

Figure 6-1 shows an alarm-test flow chart.

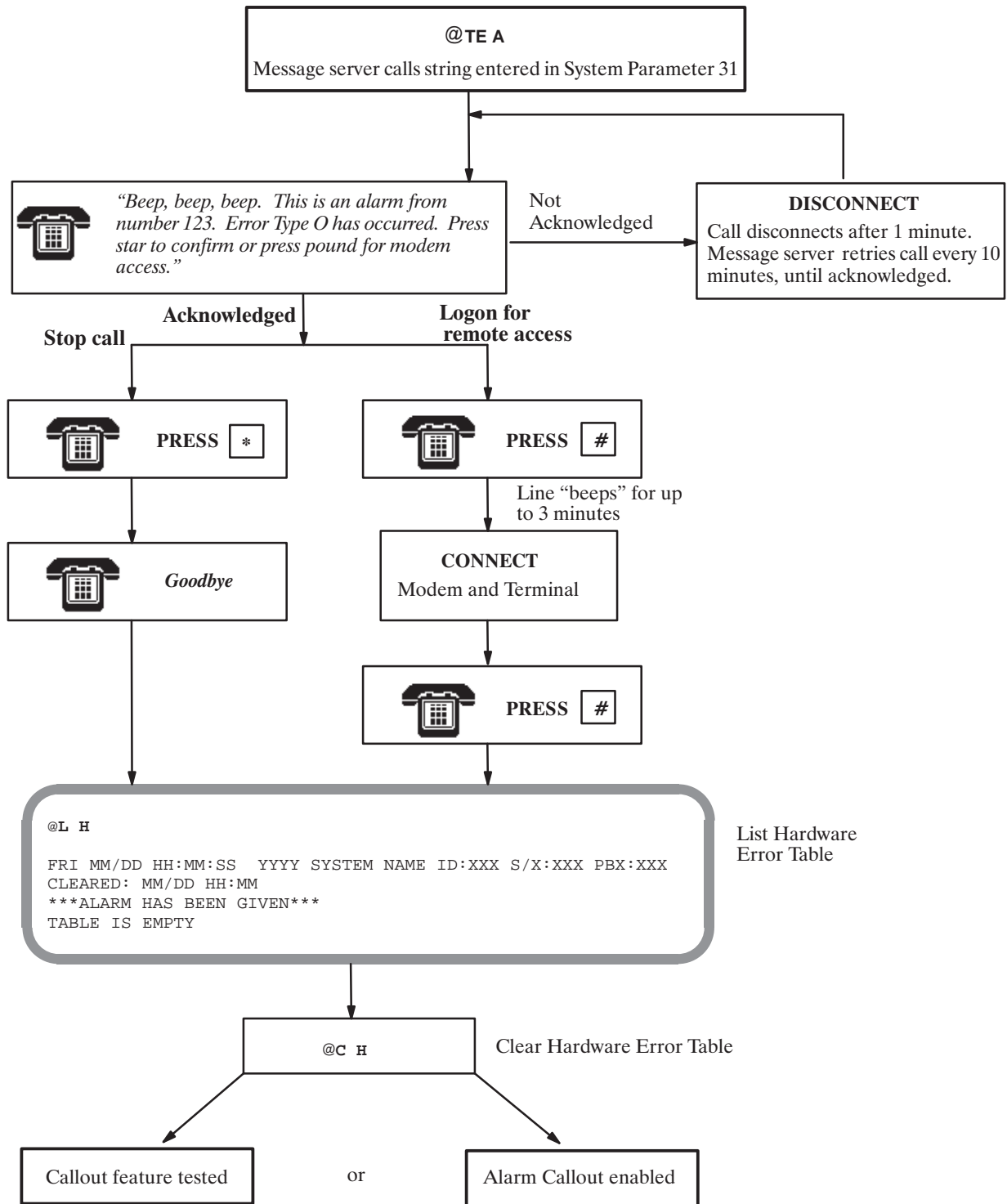

Figure 6-1 Alarm Test Flow

System Forwarding

The forwarding string entered in System Parameter 45 — SYSTEM-RELOAD FORWARD STRING, is automatically sent if the Octel Overture 200/300 reloads for any reason. During this time, calls are not accepted for several minutes, while an automatic check is performed on the database. If forwarding strings are not set up, incoming calls receive a ring-no-answer until the message server is ready. When forwarding strings are set up correctly, the PBX forwards all incoming calls to an operator or attendant for handling until the message server is ready to receive calls. The following describes the procedure for testing this feature.

Either the COURTESY DOWN (CD x y z) command, or the TEST CHANNEL 1 (TE C 1 X Y) command to test the forward feature. You can specify a specific port or range of ports. This command causes each port to attempt the forward.

When successful, the following message is displayed:

```
Port #1 Forwarded
.
.
All Requested Ports Forwarded
```

If only one port is specified, the Octel Overture 200/300 attempts to forward only that port. If a range is specified, the message server attempts to forward all ports in the range. If no port is specified, the message server tries to forward all ports. If a port is successfully forwarded, it is left in the forwarded state. If a port fails to complete the forwarding, it is left in the NDT state. The Octel Overture 200/300 continues to try to forward all ports specified, until successful or until you press **Escape**. To review the port status, use the P S command. To cancel forwarding, run the System Initialization test, as described in the following section.

For additional information about using the CD x y z command, refer to the System Service Mode Commands, Courtesy Up/Courtesy Down, section.

System Initialization

When the Octel Overture 200/300 has reloaded and is ready to handle calls, an initialization sequence automatically takes place. First, the message server attempts PBX initialization (System Parameter 33 — PBX INITIALIZE CODE), then attempts the cancel forward string (System Parameter 46 — SYSTEM-RELOAD CANCEL FORWARD-STRING), for each port in turn. When a port fails to complete the initialization or the cancel forward, the port is left in the NDT state. The message server attempts to initialize a port every 10 seconds.

Use either the COURTESY UP (CU x y z) command or the TEST CHANNEL 2 (TE C 1 x Y) command to test this feature. You can specify a specific port or range of ports. This command causes the server to attempt initialization and cancel forward for each port in turn.

When the initialization is successful, the following message is displayed:

```
Port #1 Initialized
.
.
All Requested Ports Initialized
```

If only one port is specified, the Octel Overture 200/300 tries to initialize and cancel forwarding for only the port specified. If a range is specified, the message server tries to initialize and cancel forwarding for all ports in the range. If no port is specified, the message server tries to initialize and cancel forwarding for all ports. If a port is successfully initialized and forwarding is canceled, it goes to the IDL state. If a port fails to complete either the initialization or the forwarding, the status remains NDT.

For additional information about using the `CU x y z` command, refer to the System Service Mode Commands, Courtesy Up/Courtesy Down, section.

System Status

Use the `TEST STATUS` command to check the message server status for d.c. voltages and the temperature. At the `@` prompt, type

```
TE S 
```

If d.c. voltages and the temperature are within acceptable ranges, the Octel Overture 200/300 responds with the following:

```
SYSTEM STATUS TESTED OK.
```

If d.c. voltages and the temperature are out of range, the Octel Overture 200/300 responds with the following:

```
ERROR DETECTED. SEE HARDWARE ERROR TABLE.
```

List Features

Use the `LIST FEATURES` command to list the following:

- Optional feature packages installed
- Number of installed, authorized, and used ports, mailboxes, and disk-storage hours
- Maximum number of drives, ports, and languages allowed in the message server

At the `@` prompt, type

```
L F 
```

@L F

```

----- SYSTEM SOFTWARE RELEASE S.x.x.x (MM/DD/YY) -----
DAY MM/DD HH:MM:SS YYYY SYSTEMNAME ID:XXX S/N:XXXXXX PBX:23

MODEL TYPE: OCTEL OVERTURE 300
SERIAL NUMBER: 200003
FEATURE PACKAGES:
SW-30001 SW-30003 SW-30004 SW-30007 SW-30008 SW-30009 SW-30015
SW-30019 SW-30020 SW-30021 SW-30022 SW-30023 SW-30024 SW-30026 SW-30027
SW-30028 SW-30029 SW-30030 SW-30031 SW-30032 SW-30034 SW-30049 SW-30050
SW-30051 SW-30052 SW-30053 SW-30055 SW-30056 SW-30057
-----

```

		Authorized	Used	Unused	Installed
Ports :	Analog	--	0	0	0
	Fax	--	8	0	8
	DSP	16	8	8	16
	PIC	24	20	4	24
MBXs :	Voice	900	678	222	10000
	Non-Voice	9100	0	9100	10000
	VMB	250	144	106	900
	Fax	640	507	133	10000
Storage :	Hours	100	58	42	106

```

-----
MAXIMUM NUMBER OF DRIVES: 6
MAXIMUM NUMBER OF PORTS: 64
MAXIMUM NUMBER OF SCHEDULE TABLE ENTRIES: 8
NUMBER OF LANGUAGES: 2
@

```

The LIST FEATURE screen fields are described as follows:

- Model Type** Shows the model number that is configured.
- Serial Number** Shows the serial number entered during INSTALL.
- Feature Packages** Lists the feature packages that are installed, including standard and optional features.
- Ports, Mbx, and Storage Information** Information for Ports, MBXs and Storage are divided into columns marked Authorized, Used, Unused, and Installed.
- The Authorized column shows the total number purchased.
 - The Used column shows the number configured or used. This number can be as high as the number authorized.
 - The Unused column shows the number available to be used. (The total number authorized minus the total number used.)
 - The Installed column shows the total capacity of the message server for specific port or mailbox types and storage hours. With Capacity on Demand (COD), a feature can be installed, but not authorized. For ports, this number is the number of ports present on the cards physically installed in the message server. For mailboxes, this indicates the maximum number of mailboxes that this message server supports.

Ports

This row lists the types of ports installed.

- The **Analog** row refers to the 4- and 8-port LIC. If the 4- and 8-port line cards are not controlled by Capacity on Demand (COD), the Authorized column is empty.
- The **Fax** row is the number of fax-application-processor channels installed. If the fax card is not controlled by COD, the Authorized column is empty.
 -  The fax capability for a mailbox is controlled by COD.
- The **DSP** row shows the number of DLC16 and ILC12 ports authorized, used, and installed.
- The **PIC** row shows the number of PBX integration card ports authorized, used, and installed.

Mailboxes

This row lists the types of mailboxes installed.

- The **Voice** row is the number of authorized, used, and installed mailboxes used for messaging.
- The **Non-Voice** row shows the number of mailboxes designated for applications use. These are mailboxes assigned Attribute 26 — MAY NOT USE INTERNAL MESSAGING FEATURES. For non-voice mailboxes, the value in the Authorized field is the installed number of mailboxes less the number of used voice mailboxes.
- The **VMB** row is the number of authorized, used, and installed Visual Mailbox licenses. The value in the Installed field is equal to the value for authorized voice mailboxes.
- The **Fax** row is the number of authorized, used, and installed fax mailbox licenses. The value in the Installed field is equal to the value for installed voice mailboxes.

Storage

This row lists the number of message storage hours authorized, used and installed. The value in the Authorized field is the number of hours purchased for COD drives added to the total hours on non-COD drives, not including the message server overhead. The Used field indicates the total number of hours actually used to store messages, names, greetings, redundant copies and network names. The Installed field is the actual physical capacity of all drives in the message server.

-  The hours used for message server overhead are not included in either the Used or Installed values. If all drives were either non-COD drives or fully authorized COD drives, Installed and Authorized would be the same.

Maximum Number of Drives

Shows the maximum number of disk-drive slots possible for the message server.

Maximum Number of Ports

Shows the maximum number of ports possible for the message server, including analog, DSP, PIC, and fax.

Maximum Number of Schedule Table Entries

Shows the maximum number of entries allowed in SCHEDULE Table entries. The maximum number is 8.

Number of Languages

Lists the number of languages installed.

6.3 APPLICATION DELAYS

Application delays are timing values set in the Octel Overture 200/300. Some of these delays are used to detect the tone cadence that the PBX provides to the Octel Overture 200/300. The tone cadence indicates a specific call condition; for example, a ringback tone indicates that the called extension is ringing, and a busy tone indicates that the called extension is busy.

When a PBX type is selected for System Parameter 3 — PBX TYPE/PBX MODEL, the default values are set to match the tone cadence of the selected PBX. If the PBX type is not in the list provided by System Parameter 3, select the PBX type OTHER. Because the tone-cadence values in that situation are not known, the Octel Overture 200/300 defaults to generic/industry-standard values; for example, a 1-second-on/3-second-off ring cadence, a 500-ms-on/500-ms-off busy cadence, and a 250-ms-on/off for a fast-busy cadence. These values could need to be changed to work correctly with your PBX when OTHER has been selected.

If the Octel Overture 200/300 can already detect ringback, slow-busy, fast-busy, and if configured, double interrupted ringback, the application delay indexes do not need to be modified. However, if the Octel Overture 200/300 detects an answer condition while monitoring single or double interrupted-ringback, slow-busy, or fast-busy tones, you must modify the application-delay indexes. The application-delay indexes that can be modified are described in the How to Modify Application Delays section in this chapter.

How Tones Are Recognized

When the Octel Overture 200/300 screens a call, it is looking for single- or double-interrupted ringback, slow-busy, or fast-busy tones. To process the call transfer, the Octel Overture 200/300 refers to application-delay indexes 49 through 52. These indexes show the maximum and minimum ON/OFF periods for any tone.

If the tone cadence detected does not comply with these delays, the Octel Overture 200/300 determines that the tone is not a single or double interrupted ringback, slow busy, or fast busy and that the call has been answered. If this occurs, the message server completes the call transfer. In a screen display of the Print Tone (PRT) and List Trace, an answer condition is indicated.

If the tone cadence is within the values set for delays 49 through 52, the Octel Overture 200/300 then compares the tone cadence with application-delay indexes 53 through 76 for single interrupted ringback, double interrupted ringback, slow-busy and fast-busy delays, to determine what the condition is. If it does not comply with any of these delays, it is assumed that the call has been answered and the Octel Overture 200/300 completes the transfer. Figure 5-2 shows the sequence that the Octel Overture 200/300 follows to screen calls.

 If the PBX provides double interrupted ringback when an internal extension calls another internal extension, System Parameter 26 — DOUBLE-INTERRUPTED RINGBACK, is set to YES. The Octel Overture 200/300 looks for a double interrupted ringback versus a single interrupted ringback when calling an extension.

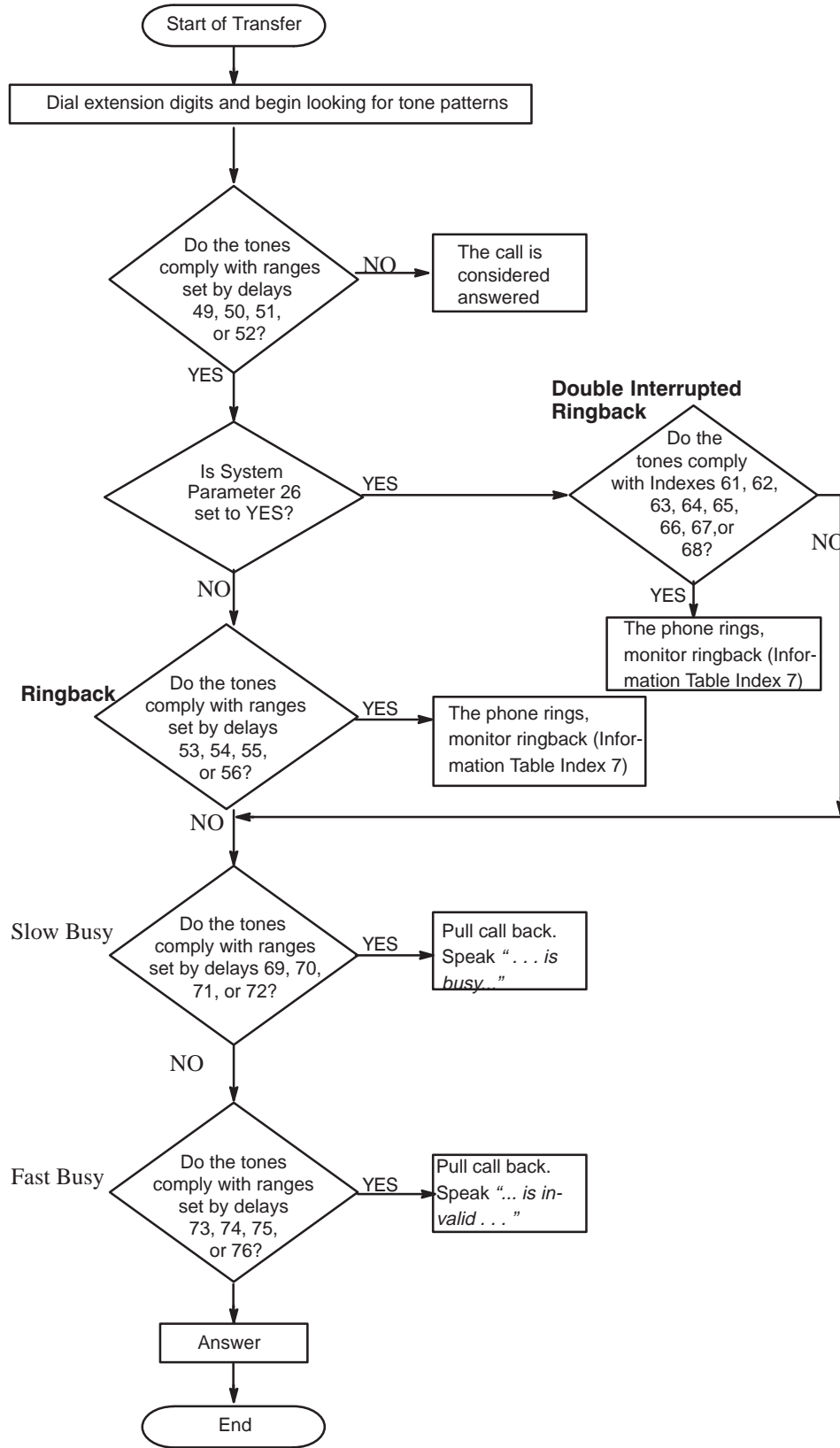



Figure 6-2 Sequence Used by the Octel Overture 200/300 To Screen Calls

How To Modify Application Delays

You should only modify those application-delay indexes for PBX tones that fail. Before modifying an application-delay index, use the `PRT` (`PRINT TONE`) command and `COS Attribute 70 — MEASURE PBX TONES`, to determine the correct timing value. Use the following steps:

1. Assign `COS Attribute 70` to a test mailbox that has an extension number for a telephone set located near the terminal.

When a mailbox with `COS Attribute 70` is called, the Octel Overture 200/300 dials the extension number, stays on line for 10 tone changes, and then hangs up. During this call, you can determine the tone cadence of the PBX.

 The extension called should **not** be set to forward on ring-no-answer, busy, or fast busy. Other features, such as camp-on, must be disabled. This could give a false tone cadence.

2. Select an Octel Overture 200/300 port and at the `@` prompt, type

```
PRT x 
```

For this command, `x` is the port number to be used.

3. Call that port's extension number.
4. When the message server answers, dial the test mailbox number.

The `PRT` command monitors and displays the DTMF tones dialed by the caller, the DTMF tones dialed by the Octel Overture 200/300, and the call-progress tones from the PBX to the terminal. This command is a real-time command and can be initiated on only one port at a time. The information is not stored.

 If the tones do not show on the screen when the `PRT` command displays the DTMF events, at the `@` prompt, type

```
C S 
```

5. Repeat steps 2 through 4. If executing the `C S` command does not help, contact your technical support center.

The `PRT` command should be initiated for any call condition that fails, such as when the message server calls an extension that is sending a ringback but the message server detects an answer condition.

The following example displays tone information when the Octel Overture 200/300 screens a call to a ring-no-answer extension that fails. Refer to the Miscellaneous Commands section in this chapter for a list of Print Tone output types.

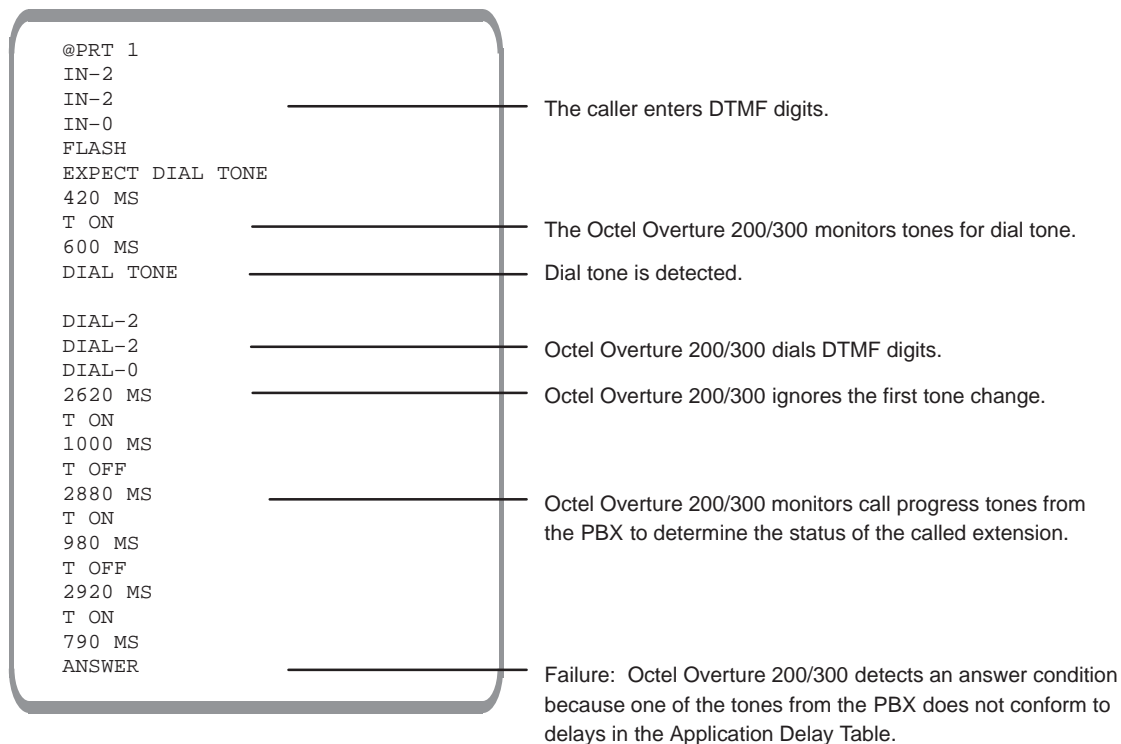

6. Review the PRT display to determine the tone cadence of the tone being monitored. Refer to the How to Modify Application Delays section in this chapter to find the application-delay indexes that refer to the error received.
7. Enter UPDATE to list the current values in the Application Delay Table; at the dot (.) prompt, type
 L APP
8. Create a tone timing diagram to help determine the tone cadence.

The tone values from the PRT display and the current application-delay values listed in the Application Delay Table can be included in the diagram to determine how much an individual tone needs to be modified.

For the preceding PRT example, the application-delay indexes that refer to the error received are indexes 50 and 54. Figure 6-3 shows what the failure would look like on a tone timing diagram. Note that the failure occurred when the PBX sent a TONE ON for 790 ms. The Octel Overture 200/300 was set to expect a TONE ON (ringback) for no less than 800 ms and no greater than 1200 ms. This is referred to as the “window.” In the diagram, the window for the silence period (TONE OFF) between rings is set to no less than 2800 ms and no greater than 3400 ms. The TONE OFF values are within that window.

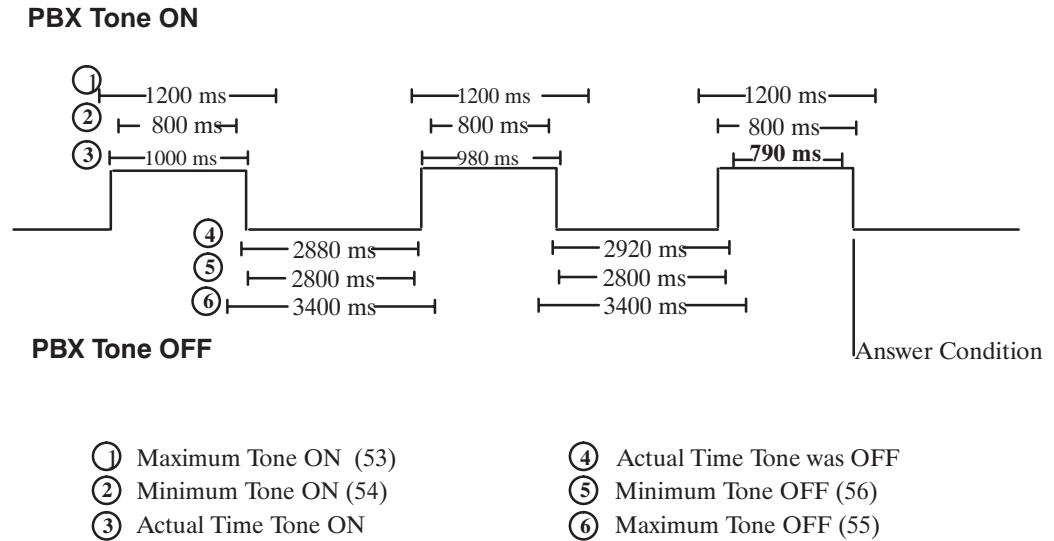

Figure 6-3 Ring/No Answer Tone-Timing Failure

9. Modify the required application delays.

In this case, Application Delay index 54 would be changed from 800 ms to 760 ms. Decreasing Index 54 allows for the 790 ms TONE ON.

☞ Index 50 must be equal to or less than Index 54.

10. After modifying the appropriate delays, remove Attribute 70, and retest the calls that failed.

If calls still fail, repeat this procedure from step 1.

Modifiable Application-Delay Indexes

The application-delay indexes that can be modified at the Maintenance level while in UPDATE are listed below, with descriptions of what the delay does and how to use it.

Application Delays for Addressing

131 WAIT DURING ADDRESSING TO RESOLVE DIGIT ENTERED

During addressing, Application Delay 131 causes a delay between digit entries when 0 is the first digit of mailboxes and extensions or when local mailbox addresses overlap network prefixes. The default delay is 2.0 seconds.

Use — When 0 is the initial digit for mailboxes and extensions, after 0, or 00–09 are entered, the message server waits for more digits. If no more digits are entered, the call is transferred to the operator (0), to the Dial-by-Name directory (00), or, in the case of a PDL address (01–09), the address is registered.

When local mailbox addresses overlap network prefixes, the message server waits for more digits after the local mailbox address is entered. If more digits are entered before the timeout

period expires, the address is considered to be a network address. For details about overlapping mailbox addresses and network prefixes, refer to the *Networking* volume, Remote Analog Networking chapter, Remote Networking Operation, Addressing for Overlapping Mailbox Addresses, and Network Prefixes sections.

Application Delays for Call Processing

8 WAIT AFTER OFF HOOK BEFORE GIVING PROMPT

Application Delay 8 causes a delay between the time the port goes off hook and the time the greeting or system prompt is played.

Use — If the PBX is slow in sending the speech paths through, it could cause greetings or prompts to be clipped (only part of the greeting or prompt heard). Modify Application Delay 8 to delay for a longer time before the message server plays the greeting or prompt.

19 TIMEOUT BEFORE LOOKING FOR RINGBACK OR BUSY

After dialing an extension number, the message server waits the amount of time specified in Application Delay 19 before looking for a ringback, busy, or fast-busy tone.

Use — Some PBXs send a partial ringback or busy tone before starting the ringback or busy-tone cycle. That would cause the Octel Overture 200/300 to fail, because the partial tone would not comply with any of the tone windows established in the Application Delay Table. Modify Application Delay 19 for a longer time interval.

87 WAIT LONGER BEFORE LOOKING FOR RINGBACK

Application Delay 87 only works in conjunction with COS Attribute 30 — EXTENSION IS ON ANOTHER PBX, WAIT LONGER BEFORE LOOKING AT TONES. After dialing an extension number, the message server waits the amount of time specified in Application Delay 87 before looking for a ringback, busy, or fast-busy tone.

Use — In some PBX environments, two or more PBXs might be connected through tie lines, so users on a local PBX could dial an extension number on a remote PBX and be routed directly to it, without going over the public network. The ringback tone from the distant PBX is delayed while the PBXs set up the call. Without Attribute 30 and Application Delay 87, the Octel Overture 200/300 detects the longer silence as an answer and attempts to transfer the call, which causes a failure. This COS attribute and application-delay combination allows the Octel Overture 200/300 to wait before looking for a ringback tone when calling certain extensions.

Application Delays used with Enhanced DTMF In-band Integration

79 DIAL TONE MAXIMUM OFF PERIOD

This delay is used as the first delay when looking for dial tone after flash, or whenever E, expect dial tone, is in a dialing string.

Use —The message server uses this delay to determine if the PBX has provided dialtone after flash or whenever E is in a dialing string. If dialtone is not received from the PBX within the

duration of this delay, the message server flashes again for dialtone, or, in the case of dialing strings, hangs up and tries again.

☞ This delay may be modified in the CPT environment to account for slow CPT (for dialtone) from the PBX.

110 FIRST DIGIT TIMEOUT WHILE WAITING FOR DTMF CALL RECORD

This delay value is the time the message server waits after going off hook for the first DTMF digit of an enhanced DTMF in-band call record.

Use — Some PBXs might not send DTMF call records (digits) in a timely manner. If this occurs, the Octel Overture 200/300 plays the default company greeting. This delay forces the message server to wait longer for the first DTMF digit of the call record.

111 INTERDIGIT TIMEOUT WHILE WAITING FOR DTMF CALL RECORD

This delay is the length of time that the message server waits for subsequent DTMF digits of an enhanced DTMF in-band call record. After the message server receives a DTMF digit of a call record, this timer starts. If the time ends before receiving another digit, the message server assumes that the PBX is finished sending digits. If the digits received match a Call Record Condition in the DTMFINT Table, the message server takes the appropriate action (plays mailbox greeting, etc.). If the digits received **do not** match a Call Record Condition, the message server plays the default company greeting.

Use — If a PBX is slow in sending DTMF digits, this delay should be increased to compensate for this.

112 DELAY BEFORE PLAYING PROMPT AFTER RECEIVING CALL RECORD

This delay is the time that the message server waits before playing a greeting or prompt after receiving a complete enhanced DTMF call record.

Use — When the PBX sends a DTMF call record to the Octel Overture 200/300, the speech path is not sent through to the caller. The caller hears silence or a ringback tone. After the PBX sends the last DTMF digit of the call record, it connects the caller and the Octel Overture 200/300. If the PBX is slow to send the speech path through, part of the greeting or prompt could be clipped. By extending this delay, the message server waits longer before playing a greeting or prompt.

141 DURATION OF ONE RING IN MILLISECOND UNITS

This delay is used to detect Ring-No-Answer (RNA). The default for this delay is a value of 5000 msec.

Use — When internal calls have a value specified in Information Index Table 7 — NUMBER OF RINGS BEFORE EXTENSION NO ANSWER, this value multiplied by the duration of one ring gives the time-out value for RNA. When message waiting outcalls have a value specified in Information Index Table 8 — NUMBER OF MESSAGE WAITING RINGS, this value is used to compute the time-out value for RNA.

142 MAXIMUM WAIT TIME FOR CALL TRANSFERRING HANG UP

This delay is used to detect call transferring hang-up delays. The default for this delay is a value of 30000 msec.

Use — When specifying the maximum time the message server waits for the call transferring party to hang up, so that the transfer to an extension forwarded to the message server is completed.

Application Delays for Cadence Recognition

49 MAXIMUM TONE ON PERIOD FOR ANY TONE

This delay must be set to a value equal to the largest value for any of the following delays set in the Application Delay Table: 53, 61, 63, 69, or 73.

Use — When the message server looks for a ringback, busy, or fast-busy tone, it uses this delay to determine whether the TONE ON is a valid tone. If the TONE ON is longer than this delay, the message server assumes an answer condition has occurred.

50 MINIMUM TONE ON PERIOD FOR ANY TONE

This delay must be set to a value less than the value for any of the following delays set in the Application Delay Table: 54, 62, 64, 70, or 74.

Use — When the message server looks for a ringback, busy, or fast-busy tone, it uses this delay to determine whether the TONE ON is a valid tone. If the TONE ON is less than this delay, the message server assumes an answer condition has occurred.

51 MAXIMUM TONE OFF PERIOD FOR ANY TONE

This delay must be set to a value equal to the largest value for any of the following delays in the Application Delay Table: 55, 65, 67, 71, or 75.

Use — When the message server looks for a ringback, busy, or fast-busy tone, it uses this delay to determine whether the TONE OFF is a valid silence period. If the TONE OFF is greater than this delay, the message server assumes an answer condition has occurred.

 Application delay 123 must be set to 0 for the server to wait the time specified in application 51. See application delay 123.

52 MINIMUM TONE OFF PERIOD FOR ANY TONE

This delay must be set to a value less than the value for any of the following delays in the Application Delay Table: 56, 66, 68, 72, or 76.

Use — When the message server looks for a ringback, busy, or fast-busy tone, it uses this delay to determine whether the TONE OFF is a valid silence period. If the TONE OFF is less than this delay, the message server assumes that an answer condition has occurred.

53 RINGBACK MAXIMUM TONE ON PERIOD

This delay is the longest delay that a TONE ON can be to qualify as a ringback.

Use — The message server uses this delay to determine whether the tone cadences that it is monitoring is a ringback. If the TONE ON is longer than this delay, the message server assumes that it is not a ringback.

54 RINGBACK MINIMUM TONE ON PERIOD

This delay is the shortest delay that a TONE ON can be to qualify as a ringback.

Use — The message server uses this delay to determine whether the tone cadences that it is monitoring is a ringback. If the TONE ON is shorter than this delay, the message server assumes that it is not a ringback.

55 RINGBACK MAXIMUM TONE OFF PERIOD

This delay is the longest delay that a TONE OFF can be to qualify as a ringback.

Use — The message server uses this delay to determine whether the tone cadences that it is monitoring is a ringback. If the TONE OFF is longer than this delay, the message server assumes that it is not a ringback.

56 RINGBACK MINIMUM TONE OFF PERIOD

This delay is the shortest delay that a TONE OFF can be to qualify as a ringback.

Use — The message server uses this delay to determine whether the tone cadences that it is monitoring is a ringback. If the TONE OFF is shorter than this delay, the message server assumes that it is not a ringback.

123 TIME TO WAIT FOR FIRST TONE

This delay **should only be modified** when using CPT-DTMF integration and must be set to 0 or a value greater than application delay 51.

Use — If application delay 123 is 0, the server waits for the amount of time specified by application delay 51 for the first TONE ON. If application delay 123 is non-zero, after dialing out digits for an outcall, the server waits this amount of time for the FIRST TONE ON condition. If no TONE ON occurs in this specified time, the server assumes the call was answered.

Application Delay indexes 61 through 68 are used only if System Parameter 26 is set to YES.

61 DOUBLE INTERRUPTED RINGBACK MAXIMUM TONE ON LONG PERIOD

This delay is the longest delay that a TONE ON, of the long TONE ON period, can be to qualify as a double interrupted ringback.

Use — The message server uses this delay to determine whether the tone cadences that it is monitoring is a double interrupted ringback. If the TONE ON is longer than this delay, the message server assumes that it is not a double interrupted ringback.

62 DOUBLE INTERRUPTED RINGBACK MINIMUM TONE ON LONG PERIOD

This delay is the shortest delay that a TONE ON, of the long TONE ON period, can be to qualify as a double interrupted ringback.

Use — The message server uses this delay to determine whether the tone cadences that it is monitoring is a double interrupted ringback. If the TONE ON is shorter than this delay, the message server assumes that it is not a double interrupted ringback.

63 DOUBLE INTERRUPTED RINGBACK MAXIMUM TONE ON SHORT PERIOD

This delay is the longest delay that a TONE ON, of the short TONE ON period, can be to qualify as a double interrupted ringback.

Use — The message server uses this delay to determine whether the tone cadence that it is monitoring is a double interrupted ringback. If the TONE ON is longer than this delay, the message server assumes that it is not a double interrupted ringback.

64 DOUBLE INTERRUPTED RINGBACK MINIMUM TONE ON SHORT PERIOD

This delay is the shortest delay that a TONE ON, of the short TONE ON period, can be to qualify as a double interrupted ringback.

Use — The message server uses this delay to determine whether the tone cadences that it is monitoring is a double interrupted ringback. If the TONE ON is shorter than this delay, the message server assumes that it is not a double interrupted ringback.

65 DOUBLE INTERRUPTED RINGBACK MAXIMUM TONE OFF LONG PERIOD

This delay is the longest delay that a TONE OFF, of the long TONE OFF period, can be to qualify as a double interrupted ringback.

Use — The message server uses this delay to determine whether the tone cadences that it is monitoring is a double interrupted ringback. If the TONE OFF is longer than this delay, the message server assumes that it is not a double interrupted ringback.

66 DOUBLE INTERRUPTED RINGBACK MINIMUM TONE OFF LONG PERIOD

This delay is the shortest delay that a TONE OFF, of the long TONE OFF period, can be to qualify as a double interrupted ringback.

Use — The message server uses this delay to determine whether the tone cadences that it is monitoring is a double interrupted ringback. If the TONE OFF is shorter than this delay, the message server assumes that it is not a double interrupted ringback.

67 DOUBLE INTERRUPTED RINGBACK MAXIMUM TONE OFF SHORT PERIOD

This delay is the longest delay that a TONE OFF, of the short TONE OFF period, can be to qualify as a double interrupted ringback.

Use — The message server uses this delay to determine whether the tone cadences that it is monitoring is a double interrupted ringback. If the TONE OFF is longer than this delay, the message server assumes that it is not a double interrupted ringback.

68 DOUBLE INTERRUPTED RINGBACK MINIMUM TONE OFF SHORT PERIOD

This delay is the shortest delay that a TONE OFF, of the short TONE OFF period, can be to qualify as a double interrupted ringback.

Use — The message server uses this delay to determine whether the tone cadences that it is monitoring is double interrupted ringback. If the TONE OFF is shorter than this delay, the message server assumes that it is not a double interrupted ringback.

69 SLOW BUSY MAXIMUM TONE ON PERIOD

This delay is the longest delay that a TONE ON can be to qualify as a slow-busy tone.

Use — The message server uses this delay to determine whether the tone cadences that it is monitoring is a slow-busy tone. If the TONE ON is longer than this delay, the message server assumes that it is not a slow-busy tone.

70 SLOW BUSY MINIMUM TONE ON PERIOD

This delay is the shortest delay that a TONE ON can be to qualify as a slow-busy tone.

Use — The message server uses this delay to determine whether the tone cadences that it is monitoring is a slow-busy tone. If the TONE ON is shorter than this delay, the message server assumes that it is not a slow-busy tone.

71 SLOW BUSY MAXIMUM TONE OFF PERIOD

This delay is the longest delay that a TONE OFF can be to qualify as a slow-busy tone.

Use — The message server uses this delay to determine whether the tone cadences that it is monitoring is a slow-busy tone. If the TONE OFF is longer than this delay, the message server assumes that it is not a slow-busy tone.

72 SLOW BUSY MINIMUM TONE OFF PERIOD

This delay is the shortest delay that a TONE OFF can be to qualify as a slow-busy tone.

Use — The message server uses this delay to determine whether the tone cadences that it is monitoring is a slow-busy tone. If the TONE OFF is shorter than this delay, the message server assumes that it is not a slow-busy tone.

73 FAST BUSY MAXIMUM TONE ON PERIOD

This delay is the longest delay that a TONE ON can be to qualify as a fast-busy tone.

Use — The message server uses this delay to determine whether the tone cadences that it is monitoring is a fast-busy tone. If the TONE ON is longer than this delay, the message server assumes that it is not a fast-busy tone.

74 FAST BUSY MINIMUM TONE ON PERIOD

This delay is the shortest delay that a TONE ON can be to qualify as a fast-busy tone.

Use — The message server uses this delay to determine whether the tone cadences that it is monitoring is a fast-busy tone. If the TONE ON is shorter than this delay, the message server assumes that it is not a fast-busy tone.

75 FAST BUSY MAXIMUM TONE OFF PERIOD

This delay is the longest delay that a TONE OFF can be to qualify as a fast-busy tone.

Use — The message server uses this delay to determine whether the tone cadences that it is monitoring is a fast-busy tone. If the TONE OFF is longer than this delay, the message server assumes that it is not a fast-busy tone.

76 FAST BUSY MINIMUM TONE OFF PERIOD

This delay is the shortest delay that a TONE OFF can be to qualify as a fast-busy tone.

Use — The message server uses this delay to determine whether the tone cadences that it is monitoring is a fast-busy tone. If the TONE OFF is shorter than this delay, the message server assumes that it is not a fast-busy tone.

Coordinate the following application-delay indexes for cadence recognition. Refer to Table 6-3.

- Set index 49 to a value equal to the largest value for any of the following delay indexes: 53, 61, 63, 69, or 71.
- Set index 50 to a value less than the value for any of the following delay indexes: 54, 62, 64, 70, or 74.
- Set index 51 to a value equal to the largest value for any of the following delay indexes: 55, 65, 67, 71, or 75.
- Set index 52 to a value less than the value for any of the following delay indexes: 56, 66, 68, 72, or 76.

Table 6-3 Application Delays for Cadence Recognition, for Determining Tone On/Tone Off

TONE EVENT	Maximum Tone On	Minimum Tone On	Maximum Tone Off	Minimum Tone Off
Single Interrupt Ringback	Index 53	Index 54	Index 55	Index 56
Max/Min Acceptable Tone Ranges	Index 49	Index 50	Index 51	Index 52
Double Interrupt Ringback, long periods	Index 61	Index 62	Index 65	Index 66
Double Interrupt Ringback, short periods	Index 63	Index 64	Index 67	Index 68
Slow Busy	Index 69	Index 70	Index 71	Index 72
Fast Busy	Index 73	Index 74	Index 75	Index 76

Using UPDATE to Modify Application Delays

You can use UPDATE to modify specific application delays. When you modify an application-delay index, enter the new value in milliseconds, rounded to the nearest 20 ms.

Use the UPDATE program as follows:

- List the current values in the Application Delay Table
- Modify the values

List Command

```
.L APP
```

Use the LIST command to list the current values in the Application Delay Table. The message server prompts for an individual delay. Enter the application-delay index to be listed.

To list all application delay indexes, press `Enter`. The following is an example of the Application Delay Table.

```
.L APP
LST:
APPLICATION DELAY TABLE
INDEX      DELAY (msec.)
0          0
1          7000
2          5000
3          500
4          3000
5          1200
6          1000
7          30000
8          1600
.
.
.
251        0
252        0
253        0
254        0
255        0
```

Modify Command

```
.M APP
```

Use the `MODIFY` command to change application delays. The message server prompts for the application-delay index to be modified. Refer to the Modifiable Application–Delay Indexes section in this chapter; only the delays that are listed can be modified at the Maintenance level. Enter the application-delay index number. Type the new value, and press `Enter`. The message server displays the new value.

The delay values are entered in milliseconds and rounded to the nearest 20 ms value.

The following is an example of Application Delay Index 8 being modified to 1000 ms (1 second).

```
.M APP
Enter APPLICATION DELAY index.
MOD:8
Enter new value (in MILLISECONDS) for APP DELAY 8.
Note: Will be rounded to the nearest 20 MSEC.
(0-1310700 MSEC, (0 means Infinite, empty line = 800  )
MOD:1000
DELAY set to 1000 MSEC.
```



Caution!

Changing an Application Delay from a nonzero value to zero should **never** be done. A zero value sets an infinite timeout that could result in permanently locking up a port.

6.4 MESSAGE BLOCK AND MESSAGE PURGE

Voice and fax messages for the Octel Overture 200/300 can be marked as unplayable with the MBLOCK message block command. Messages can be deleted on a mailbox-by-mailbox basis or from every mailbox in the message server with the MPURGE message purge command.

To block or purge a message, the message header number must be identified. To determine the message header number, use either the L M [mailbox number] M command to list mailbox message information for a specific mailbox, or the L T (list trace) command if only the approximate time of the message is known. Refer to the Mailbox Configuration Status section in this chapter, for more information about listing mailbox messages.

Marking a Message Unplayable

Messages that are recorded and sent can be blocked from being played by the message recipients. Blocking a message makes the message unplayable.

Making a message unplayable has no immediate effect on that message if it is already being played. However, it prevents a mailbox holder from starting to play or to replay the message after it is blocked. If a mailbox holder does attempt to play an unplayable message, the creator's name is played. The status prompt plays, followed by *"This message has been marked unplayable by the system administrator. Please erase."*

This same prompt is heard if the message is a fax message that the user is trying to print by entering **1** **9** **8**. The normal fax-message menu, with options to print the fax, is not played. The auto-print feature is suppressed for fax messages marked unplayable.

If a message is marked for delivery to a remote mailbox but has not been sent, this same prompt is sent over the network instead of the message. Messages already sent over the network are not deleted or blocked by the MPURGE and MBLOCK commands.

The mailbox holder might hear silence rather than the preceding prompt, if the following occurs:

- The MBLOCK command is entered at the same time the message is played for a local user or sent over the network.
- A mailbox holder has forwarded the message using the future-delivery option and then listens to the message while it is still in the mailbox.

To block a message from being played, at the @ prompt, type

```
MBLOCK x y Enter
```

In this command, x is message header number, and y indicates that the message is to be blocked.

The message server responds with a request to confirm this command.

```
MAKE MESSAGE 5001 UNPLAYABLE
ARE YOU SURE YOU WANT TO DO THIS? Y
MESSAGE 5001 MADE UNPLAYABLE
```

MPURGE Command Usage

A message that has been recorded and sent can be deleted from one or all mailboxes in the message server.

From **all** mailboxes, the MPURGE command first initiates an MBLOCK command so that, while the message server is searching each mailbox for an occurrence of the message, mailbox holders cannot play that message.

The search that occurs after the MBLOCK command is issued can take some time to be executed. For example, on a message server with 1,200 mailboxes, the search takes approximately 1/2 hour. Also, seconds or even minutes might elapse between the display of the next “mailbox scheduled for deletion” prompt. When the search has been completed, because the MBLOCK command is issued by the message server before beginning the message-purge search, the message continues to use the header assigned to it, and it remains on the disk until the message server is restarted.

When the MPURGE command is issued to delete a message from **an individual** mailbox, the MBLOCK command is not evoked. The message is deleted from the mailbox specified. When issued for a particular mailbox, the MPURGE command is quick to be executed. If a message was sent, for example, to three mailboxes and purged one mailbox at a time from each of the three, after the final deletion, the message is deleted from the disk and the header is made available for reuse.

Whether for a single mailbox or for all mailboxes, when the MPURGE command is issued to request that a message be deleted, if the mailbox holder is logged on, the request to delete is queued, and the deletion occurs after the mailbox holder logs off.

If the message server is restarted while deletion requests are queued, those queued requests are lost. However, the message remains unplayable if it has been blocked (explicitly by MBLOCK or implicitly by the all-mailbox MPURGE command). To verify that messages have been deleted before restarting the message server, check the trace log.

MPURGE Command for All Mailboxes

To delete a message from every mailbox in the message server, at the @ prompt, type

```
MPURGE x 
```

In this command, x is the message-header number.

```
DELETE MESSAGE 5001 FROM ALL MAILBOXES
ARE YOU SURE YOU WANT TO DO THIS? Y
MESSAGE 5001 SCHEDULED FOR DELETION FROM MAILBOX 2021
MESSAGE 5001 SCHEDULED FOR DELETION FROM MAILBOX 2022
.
.
@
```

The message server searches all mailboxes for the message to be deleted before returning to the @ prompt. As it searches, the following prompt is displayed each time there is an occurrence of the message:

```
MESSAGE xxx SCHEDULED FOR DELETION FROM MAILBOX yyy.
```

The command can be canceled by entering `[Escape]`. The execution pauses, and the following message is printed:

```
ABORT MPURGE (AND LEAVE MESSAGE UNPLAYABLE) .
ARE YOU SURE YOU WANT TO DO THIS? Y
@
```

Enter `Y` to abort the message purge. If the message purge is aborted, all messages that have already been queued for deletion are deleted.

MPURGE Command for Message-by-Message Use

To delete a message from one mailbox, at the `@` prompt, type

```
MPURGE x z [Enter]
```

In this command, `x` is the message header number and `z` is the mailbox number.

Before checking whether the message is actually present in the mailbox, the Octel Overture 200/300 requests confirmation before deleting a message from the mailbox. For example, when a message is to be deleted from one mailbox, the message server responds with the following:

```
DELETE MESSAGE 5001 FROM MAILBOX 2022
ARE YOU SURE YOU WANT TO DO THIS? Y
@
```

 If an original recipient has forwarded the message, the forwarded instance of the message is not deleted with the `MPURGE x y` command. However, if a message is deleted from **every** mailbox by the `MPURGE x` command, the message, but not the forwarding comments, is blocked and cannot play.

If the message should be restricted from all delivery, two options for removing the message are available:

- Use `MPURGE` to delete the message from all mailboxes. If the message server is large, this could take some time. The message could be heard by some users before the command to delete it from their mailboxes is issued.
- Do an `MBLOCK` and then a single-mailbox `MPURGE` for each mailbox to which the message was sent.

If the message should go to some of the originally addressed mailboxes, then the options are as follows:

- Use `MPURGE` to delete the message from all mailboxes, and then create a new message with the appropriate information. Send the message to the desired mailbox addresses.
- Use a single-mailbox `MPURGE` for each mailbox that should not receive the message. If any of these mailboxes are configured for Auto-Copy, perform the message purge from the Auto-Copy target.

Forwarded messages and network messages are not deleted.

MBLOCK and MPURGE Considerations

- ❑ Blocked messages (explicitly by MBLOCK or implicitly by an all-mailbox MPURGE) are not automatically deleted from the message server. The space used by the message and the associated header become available for reuse when the message server is restarted.
- ❑ If a message has been forwarded, the forwarded instance is not automatically deleted by the MPURGE command. Make the message unplayable using the MBLOCK command. The message recipient hears the sender's name if available, but the message is not played. The prompt requesting that the message be deleted is heard.
- ❑ Any message can be Auto-Copied. If the single-mailbox MPURGE command is used to delete a message, that message must be deleted from the Auto-Copy target as well. If the all-mailbox MPURGE is used, in general, the message is deleted from Auto-Copy targets.
- ❑ Even if a message is part of a forwarding chain, only that particular message is blocked or purged. Block or purge all messages in the chain, if desired. For instance, if a voice-annotated fax message is to be purged, enter the MPURGE command separately for both the voice annotation and for the fax message. Similarly, if a message was forwarded with comments, delete both the comments and the forwarded message with the MPURGE command.
- ❑ If part of a forwarded message chain is marked unplayable, when the message server is restarted, messages from the point of those marked unplayable are deleted. For example, if a message is forwarded with comments and then forwarded a second time with comments, blocking the first forwarded comments deletes those comments and the message, but the second forwarded comments can still be played.

7

LOG COMMANDS

LOG, LIST TRACE, CALL DETAIL RECORD

Chapter Content

7.1	LOG Command	7-1
	Log Options	7-2
7.2	Call Processing Trace (CPT)	7-5
	Using the CPT Log	7-5
	Printing the CPT Log	7-6
	Using the List Trace Command	7-8
	Using the LOG PR CPT Command	7-12
	Examples Using LOG PR CPT	7-14
	Examples Using LOG PR CPT for Untraced Activities	7-16
	Displaying Types of Events and Supplemental (AUX) Activities	7-21
7.3	Call Detail Record Log	7-22
	Configuring the CDR Log	7-26
	Displaying Call Detail Records	7-29
	Setting Display Specifications	7-30
	CDR Size by Transaction Type	7-36
	Examples of Various CDR Log Screens	7-37
7.4	Namesend Activity Trace Log	7-40
7.5	Moves, Adds, and Changes Log	7-43
	Types of Configuration Table Entries Logged	7-43
7.6	Server Activity Trace Log	7-50
Appendix A	Call-Processing Trace Activities	7A-1

Tables

7-1	Trace Activity Types	7-7
7-2	Transaction Type Descriptions	7-23
7-3	Descriptions of the CDR Status That Can Be Logged	7-24
7-4	Information Logged by Transaction Type	7-35
7-5	Call Detail Record Size by Transaction Type	7-36
7-6	Namesend Activity Types	7-40

Tables (continued)

7-7	Event and Aux Activities in Namesend Activity Log	7-42
7-8	SAT Log Aactivity Types	7-51

Quick Reference Guide

LOG Commands

Command	Information
LOG Commands	
LOG x y	Displays log option and log to be traced.
LOG ?	Displays all log options.
LOG ST CPT	Shows the beginning time and the time of the first record presently in the CPT log.
LOG PR CPT LOG PR CDR	Prompts for print options and filters to control output format and record selection criteria.
LOG BE CDR	Used with CDR to set the begin time for the CDR log.
LOG MF CDR	Used with CDR log to enable or disable filters for logging combinations of transaction and status types.
LOG PF CDR	Used with the CDR log to display the enabled or disabled filters modified by the LOG MF command.
Call Processing Trace (CPT) Commands	
L T	Display a menu of seven choices for call processing trace activity. Enter the trace activity number to be displayed.
L T x	Displays a specific call processing trace activity. x = trace activity number to be displayed.
L T ?	Displays all LIST TRACE options
Call Detail Record (CDR) Command	
CDR	Displays the CDR log file.
CDR ?	Displays available options and all report filter types

7.1 LOG COMMAND

Use the LOG command to collect information about specific events for

- Call Processing Trace (CPT) activities
- Call Detail Record (CDR) log activities
- Moves, Adds, and Changes (MAC) activities (beginning with Serenade 3.0)
- Network Namesend activities (NAM)
- Server Activity Trace Log (SAT) (beginning with Serenade 3.0)

It displays the collected data according to specific filters that can limit the time interval activities logged.

To execute the LOG command, at the @ prompt, type

```
LOG x y
```

In this command, x is a specific option type and y is the log to be traced.

- Log Options.** To display the log options, at the @ prompt, type

```
LOG ? 
```

Five log options are displayed:

```
@LOG ?
PR   Print log file
BE   Set begin time of log file
PF   Print filters for input to log file
MF   Modify filters for input to log file
ST   Print status of log file
```

- Logs To Be Traced.** The log types that can be traced are **CPT**, **CDR**, **MAC**, **SAT** and **NAM** .

The following table shows the log options that can be used.

Log Type	PR	BE	PF	MF	ST
CPT	✓				✓
CDR	✓	✓	✓	✓	✓
MAC	✓	✓			✓
SAT	✓				✓
NAM	✓				✓

Log Options

Several log options are available to the user. Details about each option and how it works with each log type are presented in the following sections.

PR Option, Print Log Files

Use the LOG option PR to list filters for each log type. These filters designate the records that can be collected and displayed.

When you enter LOG PR [log type], the Octel Overture™ 200/300 prompts for print options and filters to control the output format and record selection criteria. The desired combinations of print options and filters are entered in the command line. The print options are common for all log types; the filters differ by log type. The PR filters for each log type are explained in the appropriate section.

```
@LOG PR <log type>
Specify Print Option(s):
    "S"tart <time>, "E"nd <time>, "L"ine <length>, "p"age <length> "\"
    "M"ask <mask (including date and time fields)> "C"ontinuous
Filters:  PR TY EV AU MB MS SL UN LI SO D1 D2 D3 D4 D5
>
```

The general rules for using the LOG PR x command to display activities are as follows:

- Print options and filters for LOG PR x can be entered in any order.
- Print options and filters can be omitted and some might be only partially specified so that a range that matches the entered characters is displayed.

If no print options or filters are entered after the LOG PR x command, all information is printed, starting at the beginning of the log and ending with the last entry.

 At any time, press **Escape** to terminate printing and return to the @ prompt.

The print-option fields for setting how the trace is displayed on the screen are explained as follows:

- S**tart [time]. Enter the time that the trace log display should begin. Only those activities with a start time greater than or equal to the specified time are displayed. If no start time is specified, the display begins at the beginning of the log.

You must specify the year, month, and day. The hour, minute, and second are optional. For example, S 97 01 23 7 specifies 7 a.m. on January 23, 1997, as the starting time for records to be printed.

- E**nd [time]. Enter the time that the trace log display should end.

You must specify the year, month, and day. The hour, minute, and second are optional. For example, E 97 01 23 9 27 specifies 9:27 a.m. on January 23, 1997, as the end time. Records with an ending time after this time are not printed.

- L**ine [length]. Line length can be shortened if the screen is too small and lines wrap. This will truncate columns on the right. If the display line length should be changed, enter the line length desired. The standard line length is 80 characters. The default varies by record type.

- ❑ **Page [length]**. Enter the number of lines that should be displayed between headers. The default displays the header only once.
- ❑ **\ (backslash)**. Before pressing `Enter`, you can enter a backslash (\) to designate that additional print options or filters follow on another line. If the print options and filters designated are longer than one line, the backslash connects the additional line to the command string. The backslash can also be used at any time in the line to segment criteria to identify print options or filters requested easily.
- ❑ **Mask**. Not used at Maintenance level.
- ❑ **C**. Press the letter C to designate that the records should print continuously from the time the log command is initiated.

To terminate printing and return to the @ prompt, press `Escape` .

BE Option Set Begin Time of Log Files

Use the BE option to set the beginning time for the CDR or MAC log. Once the begin time is set, records collected before this date are no longer accessible.

Setting the begin time for a log facilitates the interface to an external data collection package that periodically collects the current data in the log. You must specify the year, month, and day; the hour and minute are optional.

To set the begin time, at the @ prompt, type

```
LOG BE X Enter
```

In this command, X is CDR or MAC.

Enter the year, month, day, hour, and minute of the begin time. Separate the information by a space.

```
@LOG BE CDR
Specify Beginning Time
>97 1 6
BEGIN TIME SET FOR LOG
```

MF Option, Modify Filters

Use the MF option with the CDR log to enable or disable the filters for logging combinations of transaction and status types. Refer to the Call Detail Record Log section for information about MF for this log.

PF Option, Display Filters

Use the PF option with the CDR log. Enabled or disabled filters that are modified by the LOG MF command can also be displayed with the LOG PF command. Refer to the Call Detail Record Log section for information about PF for this log.

ST Option, Print Status of Log Files

Use the ST option to show the beginning time and the time of the first record presently in the log. For CPT, the log begins when the Octel Overture 200/300 is first installed and when it is reinstalled because of a software upgrade. For CDR or MAC, you can use LOG BE to alter the begin date.

When the log file becomes full, new records overwrite the oldest records in the log. Therefore, the beginning time of the log and the time on the first record actually in the log at a given time are not the same once the log has been overwritten.

In the following example, the records that were logged between 3:21:45 p.m., December 6, 1997, and 8:35:03 a.m., December 7, 1997, are no longer accessible.

To display the log beginning time, at the @ prompt, type

LOG ST x

```
@LOG ST CPT
log name: CPT
LOG FILE BEGINNING TIME IS 12/06/97 15:21:45
TIME OF FIRST RECORD IN LOG IS 12/07/97 08:35:03
@
```

7.2 CALL PROCESSING TRACE (CPT)

The Call Processing Trace (CPT) logs all call processing and messaging activities and events to one file on the hard disk drive. The CPT logs events for the following activities:

- Mailboxes
- Ports
- Network locations (Analog and Digital networking activities are logged separately.)
- Message headers
- Integrations
- Applications processors (Works for Serenade)
- Client-Server Protocol (Used to trace activity for OctelDesigner Applications)

The CPT logs activity detected by the Octel Overture 200/300. The CPT can be used to determine, for example, why a caller entering 399 received the response “*Extension 39 is invalid.*” The CPT can help determine the port that was used for the call. However, the reason for the failure requires extensive testing to determine why a digit was not detected. Possible reasons might include the caller’s instrument, transmission quality, or any other interruption in the transmission path during sending of the DTMF digits.

The CPT is a diagnostic aid that is designed to be used when a detailed customer complaint is received. When used correctly, the CPT helps to verify or explain problems, such as late delivery or reappearing messages.

When the CPT function is used as part of the process to determine why something unexpected happened, several points should be considered:

- The PBX numbering plan
- The Octel Overture 200/300 mailbox/extension numbering scheme
- The extension numbers assigned to the Octel Overture 200/300 ports
- The PBX function and feature-access codes

Using the CPT Log

When an unexpected event is identified in the CPT, the first step is to backtrack and attempt to understand all activity reported before the event. The CPT stores several hours of activity for a large, high-traffic message server and up to several days of activities for a small, low-traffic message server.

To collect and analyze specific call processing and message activities, you can use either the LIST TRACE command or the LOG PR CPT command.

These commands provide two different methods of printing log records.

- ❑ Enter `L T` for List Trace, a simple menu whose options provide predefined filtering.
- ❑ Enter `LOG PR`, which prints files with no default filters. However, because specific filters can be designated, this command allows greater control and flexibility by using the filters.

Examine the CPT to determine the DTMF digits entered just before the unexpected event. The CPT usually explains why the Octel Overture 200/300 performed the way it did.

Printing the CPT Log

The CPT log is printed in the same format for both commands. The content of each record varies according to the type of activity traced, but similar data items are printed in the same column.

MM/DD/YY	HH:MM:SS	PRT	TYPE	EVENT	AUX	MBX/EXTN	MSG#	SL U L	SOURCE
12/07/97	11:58:34		MSG	REMOVED		6013	68f9		
12/07/97	11:58:34		MSG	FREED	NO_TALK		696d		

Each column on the screen can be described as follows:

- ❑ **MM/DD/YY.** Month, day, and year of the transaction.
- ❑ **HH:MM:SS.** Hour, minute, and second of the transaction.
- ❑ **PRT.** Three-digit designation of the active port, starting with 0. This column is blank if the activity is not associated with a port. For Client-Server Protocol (CSP), the port column lists an OctelAccess number from G01 to G99.
- ❑ **TYPE.** Types of trace activities being logged. Refer to Table 7-1 for activity types that are listed in this column.

Table 7-1 Trace Activity Types

Type	Description
PORT	Port activity
FAX_CHN	Fax-channel activity
FAX_MSG	Fax-message activity
MBX	Mailbox activity
MSG	Message activity
NET_MSG	Network-message activity
LAN_IN	Request received by this server from the LAN
LAN_OUT	Request sent from this server to the LAN
LAN_MSG	Message activity initiated by the LAN
LANLOST	CPU and LAN card lost communication
LANSYNC	CPU and LAN card have synchronized communication

Table 7-1 Trace Activity Types

Type	Description
LAN_CTY	Courtesy operation (UP or DOWN specified in the EVENT field)
ONT_IN	An OctelNet (Protocol 5) packet received by server
ONT_OUT	An OctelNet (Protocol 5) packet sent out by server
ONT_ERR	An OctelNet (Protocol 5) protocol error occurred
NAM_DIR	Dial-by-Name directory activity
INTG_C	Card-based integration record, including MIC, RIC, ATTIC, SL1, and M1 integrations
INTG_CA	Card-based ANI integration record
INTG_R	RS-232C integration record
INTG_D	DTMF integration record
LINK_AP	Application control processor link activity
AP	Application control processor mailbox activity (for example, message waiting)
CSP_IN	Packet received from the OctelAccess Server (Beginning with S3.0)
CSP_OUT	Packet sent to the OctelAccess Server
GWLINK_UP	Link between OctelAccess Server and the message server is up
GWLING_DOWN	Link between OctelAccess Server and the message server is down
ISDNMSG	Identifies activity associated with calls to a DTIC card.
INTGQRY	PBX query call record types
INTGREP	PBX reply call record types

- EVENT.** Shows what action was taking place at that time. Refer to Appendix A at the end of this chapter for a list of possible events.
- AUX.** Shows supplemental event information. The AUX column also displays the digits entered for an activity or a fax result code. For fax messages, the AUX column is empty if the fax was successful. For applications routed through Octel Access, the AUX column displays the application session ID. Server to the Refer to Appendix A in this chapter for a list of possible events and supplemental actions that are logged, which includes a list of the fax result codes.
- MBX/EXTN.** Shows only the mailbox and the extension. The network location code is not shown in this column. Instead, the network location name is shown in the SOURCE column.
For fax messages, this column shows the baud rate.
- MSG#.** Shows the message number.
- SL U L.** These three columns show the slot number, the integration unit, and the link. For fax messages, the SL column shows encoding type MH or MR.
- SOURCE.** Shows the source of the call (integration). This column shows the network-location name for a network message.

Using the List Trace Command

Use the L T (List Trace) command to display CPT activities. A trace for specific types of activities can be selected from a menu of seven activities. Each activity is logged separately.

```
@L T
 1 ALL ACTIVITIES
 2 MAILBOX ACTIVITY
 3 PORT ACTIVITY
 4 LOCATION ACTIVITY
 5 MESSAGE ACTIVITY
 6 INTEGRATION ACTIVITY
 7 AP/VSA ACTIVITY

SELECT TRACE TO BE LISTED. (1 - 7 EMPTY LINE = EXIT).
:1
Enter start time : Year Month Day Hour Minute or C (continuous)
:
```

Specifying a start time helps to trace a specific problem. The trace is displayed from the time specified until the last log for that activity is found. To display current events, specify a continuous trace from the time L T is initiated.

- ❑ At the @ prompt, type

```
L T 
```

Seven options are displayed. After the option is entered, if no specific information is entered, all activities are displayed.

- ❑ A specific List Trace activity can be specified. At the @ prompt type

```
L T x 
```

For this command, x is the specific activity number to trace.

After you enter the option number, you can enter a start time. When a start time is specified, the year and month entries are mandatory and must be entered in the order shown. The day, hour, and minute entries are optional. For example, 97 02 24 lists all information stored starting with the first event stored for February 24 and continuing to the current date and time. If the date and time entered precedes the date and time for the data stored, the message server starts reporting events for the earliest date within the range specified.

 To determine the first record in CPT, type LOG ST CPT at the @ prompt. Refer to the Log Command section in this chapter.

To select the complete history stored, press at the : prompt, instead of entering a start time.

To display current events, enter C (for continuous), and press .

To exit List Trace, press .

A description of the seven options follows.

Option 1, All Activities

Select 1 to display **all** mailbox, port, location, message, integration, and Works for Serenade activities.

```

@L T 1
Enter start time : Year Month Day Hour Minute or C (continuous)
:
MM/DD/YY HH:MM:SS PRT TYPE EVENT AUX MBX/EXTN MSG# SL U L SOURCE
11/05/97 09:43:05 029 PORT DIGIT_OUT 4
11/05/97 09:43:05 029 PORT DIGIT_OUT C
11/05/97 09:43:05 014 PORT OFFHOOK
11/05/97 09:43:05 014 MBX MSGWAIT SET 8207
11/05/97 09:43:06 NET_MSG PUT_IN 030A ABC
11/05/97 09:43:06 NET_MSG SENT 6609 030A
11/05/97 09:43:06 NET_MSG REMOVED 6609 030A
11/05/97 09:43:06 MSG FREED USE_CNTO 030A
11/05/97 09:43:06

```

A remote network location cannot be uniquely identified by only its prefix digits, because the NUMBERING PLAN Table can have more than one entry for a location name. For that reason, the prefix digits for event PUT_IN are not printed in the MBX/EXTN column. Instead, the network location name is entered in the SOURCE column; in the preceding example, the name ABC is in the SOURCE column. Refer to the *Networking* volume, Numbering Plan Table chapter, for more information about multiple entries for the same location name.

Option 2, Mailbox Activity

Select 2 to display Mailbox Activity. To list activities for **all** mailboxes, leave the Enter Mailbox: field blank. To list activities for a defined series of mailbox numbers, enter a specific mailbox number or only partial digits for the mailbox numbers. All activities on the port used by that mailbox or those mailboxes are listed until that mailbox or mailboxes log off.

Mailbox activities (type) displayed include the following events:

- Mailbox logon and logoff
- Number of messages at logon
- Hanging up without logging off
- An invalid security code entered
- Message-waiting call received
- Message-waiting integration used
- Number of messages in the mailbox
- Digits entered by the user
- Name recorded
- Greeting recorded
- Messages sent and received
- Messages erased

- Call-forwarding mailbox assigned

```

@L T 2
Enter mailbox (Empty line = ALL)
:4720
Enter start time : Year Month Day Hour Minute or C (continuous)
:
MM/DD/YY HH:MM:SS PRT TYPE EVENT AUX MBX/EXTN MSG# SL U L SOURCE
04/05/97 10:05:19 MSG PUT_IN FWD_RNA 4720 0359
04/05/97 10:05:19 009 MBX MSGWAIT SET 4720
04/05/97 10:34:50 029 MBX LOGON 4720
04/05/97 10:34:50 029 MBX HAS_MSGS 016 4720
04/05/97 10:34:50 029 MBX NEW_MSGS 001 4720

```

Option 3, Port Activity

Select 3 to display port activity. To display activity for **all** ports, leave the `Enter Port:` field blank. To display activity for a specific port, enter the port number. The following port activities are displayed:

- Caller action
- Line drops
- DTMF digits in and out
- Call status (busy/RNA)
- Call transfers made
- Invalid security code entered
- Number of messages sent on port

```

@L T 3
Enter port (Empty line = ALL)
:15
Enter start time : Year Month Day Hour Minute or C (continuous)
:
MM/DD/YY HH:MM:SS PRT TYPE EVENT AUX MBX/EXTN MSG# SL U L SOURCE
04/05/97 09:47:30 015 PORT DIGIT_OUT B
04/05/97 09:47:30 015 PORT DIGIT_OUT 1
04/05/97 09:47:30 015 PORT DIGIT_OUT 2
04/05/97 09:47:31 015 PORT DIGIT_OUT 0
04/05/97 09:47:31 015 PORT DIGIT_OUT 8
04/05/97 09:47:31 015 PORT DIGIT_IN B
04/05/97 09:47:32 015 PORT DIGIT_IN 9

```

Option 4, Location Activity

Select 4 to display network location activity. To display activity for **all** network locations, leave the `Enter Location:` field blank. To list the activity for a specific network location, enter the location code or only partial-location-code digits. The location entered is displayed in the `MBX/EXTN` column. The location activities displayed are as follows:

- Network messages added or removed from a network location

- The success or failure of a network message received or sent
- Network message recorded
- Message number

```

@L T 4
Enter location (Empty line = ALL)
:6620
Enter start time : Year Month Day Hour Minute or C (continuous)
:
MM/DD/YY HH:MM:SS PRT TYPE EVENT AUX MBX/EXTN MSG# SL U L SOURCE
04/05/97 09:43:05 NET_MSG PUT_IN 6620 7A8D
04/05/97 09:44:16 NET_MSG PUT_IN 6620 7A91
04/05/97 09:44:45 NET_MSG SENT 6620 7A8D

```

Option 5, Message Activity

Select 5 to display message activity. To display **all** message activity, leave the Enter Message: field blank. To display a specific message, enter the message number or a series of digits. The message activity trace displays as follows:

- Messages sent, received, erased, freed
- Names and Greeting activity

```

@L T 5
Enter message (Empty line = ALL)
:
Enter start time : Year Month Day Hour Minute or C (continuous)
:97 05
MM/DD/YY HH:MM:SS PRT TYPE EVENT AUX MBX/EXTN MSG# SL U L SOURCE
05/02/97 13:22:09 001 MSG RECORD RNA 1173
05/02/97 13:22:13 MSG FREED TOO_SHRT 1173
05/12/97 07:11:34 001 MSG RECORD MAKE 1179
05/12/97 07:11:51 001 MSG SENT 1179
05/12/97 07:11:51 MSG PUT_IN MAKE 1121 1179
05/18/97 06:27:22 001 MSG PLAY MAKE 117C

```

Option 6, Integration Activity

Select 6 to display **all** integration activities. The integration activities displayed are as follows:

- Direct internal and external calls with source or trunk group
- Forwarded internal and external calls with source or trunk group
- Message-waiting notification
- Set or clear message waiting
- Undetermined call location
- Port used for AT&T System 75 integration
- Forwarding reasons for slot, unit, and link

```

@L T 6
Enter start time : Year Month Day Hour Minute or C (continuous)
:
MM/DD/YY HH:MM:SS PRT TYPE EVENT AUX MBX/EXTN MSG# SL U L SOURCE
04/05/97 09:56:23 040 INTG_C FWD_INT BUSY 4373 09 1 4 1705
04/05/97 09:57:49 041 INTG_C DIR_EXT 800 10 1 1
04/05/97 9:57:54 040 INTG_C ONHOOK 09 1 4
04/05/97 09:58:16 043 INTG_C FWD_EXT NO_ANSWER 4334 10 1 3 100

```

Option 7, Amlink Activity

Select 7 to display Works for Serenade system activity. The activities displayed are as follows:

- LOST. The data link between the Octel Overture 200/300 CPU and the Works for Serenade system is down.
- SYNC. The data link is restored.

Using the LOG PR CPT Command

You can use the LOG command, LOG PR CPT, to display the same activities as are filtered with LIST TRACE.

With the LOG PR CPT command, different combinations of print options and filters can be specified to consolidate information and focus the display on specific types of trace activities. Use LOG PR CPT to do the following:

- Set filter for records with FAX_CHN and FAX_MSG.
- Set start and end times for any trace.
- Review timing and sequence of all high-level communication to and from the LAN for Digital Networking.

To use the LOG command for CPT activities, at the @ prompt, type

LOG PR CPT .

```

@LOG PR CPT
Specify Print Option(s):
  "S"tart <time>, "E"nd <time>, "L"ine <length>, "p"age <length> "\"
  "C"ontinuous
Filters: PR TY EV AU MB MS SL UN LI SO D1 D2 D3 D4 D5

```

Refer to the Log Command section for an explanation of LOG print options.

In addition to the LOG print options that control the output format, you can enter specific filters and arguments to limit the output to only those activities that match the set of search criteria. A filter need not be specified and, in some cases, the filters can be partially specified. Only the values that match the specified filters are displayed.

- ❑ **Port filter**, PR [port number]. Type PR [port number] to display port activities. You can display all ports or a specific port. To display all ports, enter only the filter command, PR. To display a specific port, enter the port number as three digits, beginning with a leading 0. For example, port 6 would be entered as PR 006 and port 34 as PR 034.
- ❑ **Type filter**, TY [type]. Type TY [type] to display a specific type of trace activity. Enter one of the trace activity types listed in Table 7-1. Except for TY INTG, only one type can be specified at a time. To show all integration activity, type TY INTG.
- ❑ **Event filter**, EV [event]. Type EV [event] to display a specific event. The events that can be specified, and their correct spelling, are listed in Appendix A, *Call-Processing Trace Activities*. Only one event can be specified at a time.
- ❑ **AUX filter**, AU [aux]. Type AU [aux] to display supplemental event activities. The supplemental activities that can be designated, their correct spelling, and a list of the fax result codes are listed in Appendix A at the end of this chapter. Only one supplemental event can be specified for each event.
- ❑ **Mailbox filter**, MB [number]. Type MB [number] to display records for a specific mailbox or extension number. The filter can designate partial mailbox digits to display **all** mailboxes beginning with those specific digits. The mailbox/extension number is displayed in the MBX/EXTN: column.

When MB is the only filter applied to LOG PR CPT, all events and supplemental activities for the mailboxes are listed. You can use MB with other filters that apply to mailbox activity for more detailed filtering.

- ❑ **Message Number filter**, MS [number]. Type MS [number] to display all records where the specified message-header number appears in the MSG# column.

A message number can be determined by reviewing the MSG# column in a trace-activity log or at the @ prompt, by typing

```
L M x M 
```

X is the mailbox number.

- ❑ **Slot filter**, SL [number]. Type SL [number] to display records for slot numbers. To display a specific slot number, enter the number as two digits. For example, you would enter slot 1 as SL 01, slot 12 as SL 12, and so forth.
- ❑ **Unit filter**, UN [number]. Type UN [number] to display records for the specific unit number on a slot.
- ❑ **Link filter**, LI [number]. Type LI [number] to display records for the specified link.
- ❑ **Source filter**, SO. Type SO to display the source of the call (integration). This filter shows the network location name for a network message.
- ❑ **D1, D2, D3, D4, D5 filters**. Use these filters to show debug information, when applicable.

Two additional qualifiers help to limit the output further:

- ❑ You can center a hyphen (-) preceding a filter to specify that the filter should not match a specific value. For example, MB - 4 specifies that records in the mailbox column that begin with 4 should not be displayed.
- ❑ You can enter a quote (") to specify blank columns. For example, EV -" specifies that, if the EVENT column is blank, the record should not be displayed.

Examples Using LOG PR CPT

You can use the LOG command to trace for specific information. Use print options, such as the start time, S, or end time, E, along with any combination of filters. At the @ prompt, type

```
LOG PR CPT 
```

The message server displays print options and filters.

```
@LOG PR CPT
Specify Print Option(s):
  "S"tart <time>, "E"nd <time>, "L"ine <length>, "p"age <length> "\"
  "C"ontinuous
  Filters: PR TY EV AU MB MS SL UN LI SO D1 D2 D3 D4 D5
>S 97 7 6 E 97 7 8
```

Mailbox Activities

To print the mailbox activity currently in the CPT log, enter the filter MB to display all mailbox activities. You can enter specific mailbox numbers or partial mailbox digits.

```
@LOG PR CPT
Specify Print Option(s):
  "S"tart <time>, "E"nd <time>, "L"ine <length>, "p"age <length> "\"
  "C"ontinuous
  Filters: PR TY EV AU MB MS SL UN LI SO D1 D2 D3 D4 D5
>S 97 7 6 MB - " TY - NET
```

In this example, this command displays a mailbox without location information. The TY – NET filter is necessary, because the location and mailbox numbers are both printed in the MB column.

Port Activities

To print the port activity currently in the CPT log, enter the filter PR to display all port activities. Enter three digits, beginning with 0, to specify a particular port. Start and end times can be designated.

```
@LOG PR CPT
Specify Print Option(s):
  "S"tart <time>, "E"nd <time>, "L"ine <length>, "p"age <length> "\"
  "C"ontinuous
  Filters: PR TY EV AU MB MS SL UN LI SO D1 D2 D3 D4 D5
>PR 007 S 97 7 6
```

In this example, this command displays all CPT records for port 7 that occurred on or after July 7, 1997.

Location Activity

To print the network location activity, enter the filter TY NET_MSG.

Message Activity

To print message activity that is currently in the CPT log using the LOG command, at the @ prompt type

```
LOG PR CPT 
```

To list all messages or specify a specific message number, type the filter MS.

```
@LOG PR CPT
Specify Print Option(s):
  "S"tart <time>, "E"nd <time>, "L"ine <length>, "p"age <length> "\"
  "C"ontinuous
  Filters: PR TY EV AU MB MS SL UN LI SO D1 D2 D3 D4 D5
>MS 3000
```

In this example, this command displays all records for message 3000, from the beginning of the log until the end.

Integration Activity

To display integration activity using LOG, specify the type of integration to trace; enter the filter TY X, where X is the type of integration to trace. Enter TY INTG to show all integration activity:

- INTG_C. Card-based integration record (MIC, RIC, ATTIC, SL1, M1)
- INTG_CA. Card-based ANI integration record (MIC, RIC, ATTIC, SL1, M1)
- INTG_R. RS-232C integration record
- INTG_D. DTMF integration record

In addition to TY, the following filters can also be specified for integration:

- SL. Slot number for card integration
- UN. Unit number for card integration
- LI. Link number for card integration
- SO. Source of call (integration)

To display APlink activity using LOG, at the @ prompt type

```
@LOG PR CPT
Specify Print Option(s):
  "S"tart <time>, "E"nd <time>, "L"ine <length>, "p"age <length> "\"
  "C"ontinuous
  Filters: PR TY EV AU MB MS SL UN LI SO D1 D2 D3 D4 D5
>TY AP S 97 7 9 11 25
```

In this example, this command displays all Works for Serenade activity in the CPT log that occurred on or after 11:25 a.m., July 9, 1997.

Examples Using LOG PR CPT for Untraced Activities

The following examples use the LOG PR CPT command to display activities that cannot be traced using the L T command.

LOG for Digital Networking (LAN)

You can also use the LOG command to review the timing and sequence of all high-level communication to and from the LAN for digital networking. The following activities can be displayed:

- Communication to the LAN card being lost and reestablished
 - This activity could be caused by LAN card restarting or the LAN card being removed and reinserted.
- Communication to other high-speed locations being lost and reestablished
 - This activity could be caused by the other location experiencing a restart or the digital connection to the other location being interrupted across the network.
- Message transfer traffic
 - The sending side shows the message number being sent, the creator, and the result of the transfer.
 - The receiving side shows the message number being received and the new message in which it is stored.
- Activities for a specified source creator mailbox
- Activities for a specified LAN channel

The LOG command can show information both in real time, as it happens, or for a previous period by specifying a start date and time. All entries are time-stamped as they occur.

Example of All LAN Type Entries

In this example, the start time (S) is specified as 97 4 21, and the type of filter (TY) is specified as LAN. This example displays all log entries in the TYPE column that start with LAN.

```

@LOG PR CPT
Specify Print Option(s):
  "S"tart <time>, "E"nd <time>, "L"ine <length>, "P"age <length> "\"
  "C"ontinuous
Filters: PR TY EV AU MB MS SL UN LI SO D1 D2 D3 D4 D5
>s 97 4 21 ty lan

MM/DD/YY HH:MM:SS PRT TYPE      EVENT      AUX      MBX/EXTN MSG# SL U L SOURCE
D1 D2 D3 D4 D5
04/21/97 07:23:27      LAN_IN  OPENCONN
04/21/97 07:23:27 L01 LAN_OUT CONNGRANT      1001
.
.
.
04/21/97 07:26:11 L01 LAN_IN  DESTMBX  NAMEFAIL 4411      JOE JONES
04/21/97 07:26:13 L01 LAN_IN  FAXDLV   NO_EXTN      R2071      66303090
04/21/97 07:26:15 L01 LAN_MSG CREATE      F69
.
.
.
04/21/97 15:47:37 L05 LANLOST      000
04/21/97 15:47:56 L05 LANSYNC      000

```

Example of LANLOST Type Entries

In this example, the start time (S) is specified as 97 4 21, and the type of filter (TY) is specified as LANLOST. This example displays all log entries that have LANLOST in the TYPE column.

```

@LOG PR CPT
Specify Print Option(s):
  "S"tart <time>, "E"nd <time>, "L"ine <length>, "P"age <length> "\"
  "C"ontinuous
Filters: PR TY EV AU MB MS SL UN LI SO D1 D2 D3 D4 D5
>s 97 4 21 ty lanlost

MM/DD/YY HH:MM:SS PRT TYPE      EVENT      AUX      MBX/EXTN MSG# SL U L SOURCE
D1 D2 D3 D4 D5
04/21/97 15:47:37 L05 LANLOST      000

```

Example of Search for Source Creator Mailbox Type

In this example, the start time (S) is specified as 97 4 21, and the type of filter (SO, for source) is specified as 66994474. This example displays all log entries that have an entry of 66994474 in the SOURCE column.

```

@LOG PR CPT
Specify Print Option(s):
  "S"tart <time>, "E"nd <time>, "L"ine <length>, "P"age <length> "\
  "C"ontinuous
  Filters: PR TY EV AU MB MS SL UN LI SO D1 D2 D3 D4 D5
>s 97 4 21 SO 66994474

MM/DD/YY HH:MM:SS PRT TYPE      EVENT      AUX      MBX/EXTN MSG#  SL U L SOURCE
  D1 D2 D3 D4 D5
04/25/97 14:21:01 L01 LAN_IN  NAMDLV                D15      66994474
04/25/97 14:21:01 L01 LAN_IN  MSGDLV      NO_EXTN    D15      66994474
04/26/97 09:35:42 L01 LAN_IN  NAMDLV                11BA     66994474
04/26/97 09:35:42 L01 LAN_IN  MSGDLV      NO_EXTN    11C1     66994474
04/26/97 09:42:15 L01 LAN_IN  NAMDLV                11D8     66994474
04/26/97 09:42:15 L01 LAN_IN  MSGDLV      NO_EXTN    11DA     66994474

```

Example of LANSYNC Type Entries

In this example, the start time (S) is specified as 97 4 21, and the type of filter (TY) is specified as LANSYNC. This example displays all log entries that have a LANSYNC entry in the TYPE column.

```

@LOG PR CPT
Specify Print Option(s):
  "S"tart <time>, "E"nd <time>, "L"ine <length>, "P"age <length> "\
  "C"ontinuous
  Filters: PR TY EV AU MB MS SL UN LI SO D1 D2 D3 D4 D5
>s 97 4 21 ty lansync

MM/DD/YY HH:MM:SS PRT TYPE      EVENT      AUX      MBX/EXTN MSG#  SL U L SOURCE
  D1 D2 D3 D4 D5
04/21/97 15:47:56 L05 LANSYNC                000

```

Example of LAN Channel Number

In this example, the start time (S) is specified as 97 4 21, and the type of filter (PR, for port) is specified as 101. This example displays all log entries for activities on LAN channel 1, and it shows message number 10B3 sent to number F68.

```

@LOG PR CPT
Specify Print Option(s):
  "S"tart <time>, "E"nd <time>, "L"ine <length>, "P"age <length> "\ "
  "C"ontinuous
  Filters: PR TY EV AU MB MS SL UN LI SO D1 D2 D3 D4 D5
>s 97 4 21 pr 101

MM/DD/YY HH:MM:SS PRT TYPE      EVENT      AUX      MBX/EXTN MSG#  SL U L SOURCE
D1 D2 D3 D4 D5
04/21/97 07:23:27 L01 LAN_OUT CONNGRANT          1001
04/21/97 07:23:27 L01 LAN_IN  VCUCONN
04/21/97 07:23:27 L01 LAN_OUT STATUS      VCUREADY
04/21/97 07:23:27 L01 LAN_OUT STATUS      VCUCONN
04/21/97 07:23:27 L01 LAN_IN  STRTSND
04/21/97 07:23:27 L01 LAN_IN  DESTMBX          110
04/21/97 07:23:27 L01 LAN_OUT STRTSND      SUCCESS
04/21/97 07:23:27 L01 LAN_OUT DESTMBX      SUCCESS 110
04/21/97 07:23:27 L01 LAN_IN  MSGDLV      NO_EXTN          10B3      151
04/21/97 07:23:27 L01 LAN_MSG CREATE          F68
04/21/97 07:23:28 L01 LAN_OUT STATUS      SUCCESS
04/21/97 07:23:28 L01 LAN_OUT STATUS      COMPLETE
04/21/97 07:23:28 L01 LAN_MSG RCV          SUCCESS          F68
04/21/97 07:23:29 L01 LAN_IN  CLOSEDONE

```

LOG for Protocol 5 (OctelNet)

You can also use the LOG command for tracing various events for Protocol 5 (OctelNet) networking. The applicable events are provided in Appendix A at the end of this chapter.

The following example uses the LOG PR CPT command for OctelNet information. The start time (S) is specified as 97 02 09, and the type of filter (TY) is specified as ONT. This example displays all log entries that start with ONT in the TYPE column.

```

@LOG PR CPT
Specify Print Option(s):
  "S"tart <time>, "E"nd <time>, "L"ine <length>, "P"age <length> "\ "
  "C"ontinuous
  Filters: PR TY EV AU MB MS SL UN LI SO D1 D2 D3 D4 D5
>s 97 02 09 00 00 ty ont

MM/DD/YY HH:MM:SS PRT TYPE      EVENT      AUX      MBX/EXTN MSG# SL U L SOURCE
D1 D2 D3 D4 D5
02/09/97 15:51:48 004 ONT_IN  WKUP_REQ  KNOWSER
02/09/97 15:51:48 004 ONT_OUT WKUP_RSP  KNOWSER
02/09/97 15:51:53 004 ONT_IN  LYSN_REQ
02/09/97 15:51:53 004 ONT_OUT LYSN_RSP
02/09/97 15:52:00 004 ONT_IN  SHDR_REQ
02/09/97 15:52:00 004 ONT_OUT SHDR_RSP  ACCEPT
02/09/97 15:52:12 004 ONT_IN  MHDR_REQ  ADMNMSG
02/09/97 15:52:12 004 ONT_OUT MHDR_RSP  SUCCESS  0000
02/09/97 15:52:18 004 ONT_IN  ADMGENREQ GETNAME  9068
02/09/97 15:52:18 004 ONT_OUT ADMASCRSP SUCCESS
02/09/97 15:52:31 004 ONT_IN  ADMGENRSP SUCCESS
02/09/97 15:52:34 004 ONT_OUT END_MSG
02/09/97 15:52:37 004 ONT_IN  ADMGENRSP ADDED
02/09/97 15:52:42 004 ONT_IN  ADMGENREQ CHMODE  00
02/09/97 15:52:42 004 ONT_OUT ADMGENRSP SUCCESS
02/09/97 15:52:52 004 ONT_IN  MHDR_REQ  NEWVCE  9068
02/09/97 15:52:51 004 ONT_OUT MHDR_RSP  SUCCESS  120B
02/09/97 15:53:12 004 ONT_IN  END_MSG
02/09/97 15:53:12 004 ONT_OUT SAVE_RQ
02/09/97 15:53:13 004 ONT_IN  SAVE_GO
02/09/97 15:53:14 004 ONT_OUT MSG_RSP
02/09/97 15:53:24 004 ONT_IN  MHDR_REQ  NEWVCE  9068
02/09/97 15:53:24 004 ONT_OUT MHDR_RSP  SUCCESS  120C
02/09/97 15:53:31 004 ONT_IN  END_MSG
02/09/97 15:53:31 004 ONT_OUT SAVE_RQ
02/09/97 15:53:32 004 ONT_IN  SAVE_GO
02/09/97 15:53:32 004 ONT_OUT MSG_RSP
02/09/97 15:53:42 004 ONT_IN  MHDR_REQ  ENDSSES
02/09/97 15:53:42 004 ONT_OUT MHDR_RSP  SUCCESS  0000

```

Client Server Protocol Trace Examples

Client-Server Protocol (CSP) request-reply trace displays activity between the OctelAccess Server and the message server. This type of trace information can be used to troubleshoot development of OctelDesigner applications. The example below shows a voice session between the OctelAccess Server and the message server. The string of digits following the session ID in the AUX field is the raw bytes in the packet. This information is not translated.

```

@LOG PR CPT
Specify Print Option(s):
  "S"tart <time>, "E"nd <time>, "L"ine <length>, "P"age <length> "\ "
  "C"ontinuous
  Filters: PR TY EV AU MB MS SL UN LI SO D1 D2 D3 D4 D5

MM/DD/YY HH:MM:SS PRT TYPE      EVENT      AUX      MBX/EXTN MSG# SL U L SOURCE
04/21/97 07:23:27 001 PORT      OFFHOOK
04/21/97 07:23:27 G03 CSP_OUT  NEWCALL    1      8A 01 00 0B 00 0A 00 0B 00 01
04/21/97 07:23:27 G03 CSP_IN    SPK_PRMP  1      08 00 00 00 00 0C 00 0B 00 01
04/21/97 07:23:27 G03 ERROR     CL_ERROR   1
04/21/97 07:23:27 G03 CSP_OUT  END_SPEAK  1      86 00 00 0B 00 0A 00 0B 00 01
04/21/97 07:23:27 G03 CSP_IN    RECRD_MSG  1      13 00 00 00 00 0B 00 0B 00 01

```

Other LOG Examples

In this example, use the LOG PR CPT command to print all entries in the CPT trace log for messages being deferred for mailbox 4999 from 11:00 a.m., July 8, 1997, to 3:00 p.m., July 9, 1997.

```
@LOG PR CPT
Specify Print Option(s):
  "S"tart <time>, "E"nd <time>, "L"ine <length>, "p"age <length> "\ "
  "C"ontinuous
  Filters: PR TY EV AU MB MS SL UN LI SO D1 D2 D3 D4 D5
>EV DEFERRED MB 4999 S 97 7 8 11 E 97 7 9 15
```

In this example, use the LOG PR CPT command to print all entries in the CPT trace log for integration slot 9, unit 1, link 2 starting July 10, 1997, at 12:30:45, and continuing:

```
@LOG PR CPT
Specify Print Option(s):
  "S"tart <time>, "E"nd <time>, "L"ine <length>, "p"age <length> "\ "
  "C"ontinuous
  Filters: PR TY EV AU MB MS SL UN LI SO D1 D2 D3 D4 D5
>TY intg sl 09 un 1 lt 2 \
>S 97 7 10 12 30 45 C
```

 The “\” in the example illustrates the use of the continuation character to show that the command continues onto another line.

Displaying Types of Events and Supplemental (AUX) Activities

Refer to Appendix A at the end of this chapter for a list of the events and AUX activities that can be displayed in a Call Process Trace log. With the LOG command, any of these events and AUX activities can be filtered.

7.3 CALL DETAIL RECORD LOG

The Call Detail Record (CDR) Log collects call-processing-transaction data in a log file on the Octel Overture 200/300. Each time a transaction is concluded, its outcome status is logged in the CDR log file. The file containing these transaction records can be used for billing or maintenance purposes. As a maintenance tool, the CDR log can be used to optimize Octel Overture 200/300 applications or to identify security violations.

Table 7-2 and Table 7-3 list the abbreviations displayed for the various transaction types and status types that can be configured, with a description of each type:

Table 7-2 Transaction Type Descriptions

Transaction Type (XACTIN)	Description
ALOUTC	Alarm outcall
APIN	ACP call in (Works for Serenade).
APOUTC	ACP outcall (Works for Serenade).
CALATT	Call to assistance (0) – dialed.
CALATD	Call to assistance (0) – default.
CALDID	DID call to mailbox through DID module.
CALEXT	For the VMX 5000 User Interface, 001 is used to transfer to a local extension. Extension digits are included, as are auto attendant calls when no mailbox is defined.
CALHLP	VMX 5000 User Interface only. 000 is used to transfer to a help mailbox. The help mailbox is included.
CALIMM	Immediate call to mailbox.
CALINT	Integrated call to mailbox (includes all calls received with call record).
CALMBX	Call to a mailbox.
CALNXT	Call to a Next Mailbox.
CALPA	Call to Personal Assistance – dialed.
CALPAD	Call to Personal Assistance – default.
CALSDM	Call to a Single Digit Menu mailbox.
COSOVR	Port/Trunk COS override. The new trunk COS is shown.
FAXQCK	Quick fax. For each quick fax sent, there is a FAXRCV transaction type.
FAXDLV	Fax delivery attempt. For each fax delivery, there is a FAXSND transaction type.
FAXSND	Fax channel: send.
FAXRCV	Fax channel: receive.
FAXEDT	Fax channel: edit (Works for Serenade).
LOGON	Mailbox logon.
LPOUTC	Lamp message waiting outcall (only if DTMF digits are used to control lamps).
MODEM	Modem connect.
MWOUTC	Message-waiting outcall.
OFOUTC	Off-site message-waiting outcall.
NTOUTC	Network outcall attempt.
NTMSGD	Network message: sent day.
NTMSGN	Network message: sent night.
NTMSGR	Network message: received.
NTIN	Network call in.
NTCHEK	Network check function. Checking if a network message was listened to. This does not stop the mailbox logon activity. The logon record continues, after the network check is completed.
QCKMSG	Quick message.
QCKINT	Forced forward, record-call-in-progress. Applicable only to selected Enhanced In-band Integration, this functionality is PBX-dependent.

Table 7-3 Descriptions of the CDR Status That Can Be Logged

Status	Description
OK	All's well condition (for example, call answered, logon successful).
AFWD	All calls forwarded.
APXF	Transfer control to ACP (Works for Serenade).
BADP	Invalid password.
BADU	UID logon failed, because the incorrect user ID entered.
BADM	Invalid mailbox number.
BLOK	Call blocked.
BUSY	Busy.
CNTU	Number of messages erased and sent during logon.
DIR	Direct call to message server.
DIRI	Direct call from extension.
ERR	Error or network failure after connection.
ERRX	Error in PBX transfer or network busy/RNA.
FBSY	Fast busy.
FLLQ	Failed line-quality test.
FLBU	All-ports busy on receiving message server.
FLRT	Failed route
FLAR	All routes failed.
FLDK	Disk full.
FLNR	No response from network location.
FLPR	VMX 5000 location protocol error.
FLNN	No room for more netnames in NETNAME Table.
FLNC	Destination not taking network calls, messages returned.
FLRF	Destination refused to accept message from this message server.
FLMO	Destination accepting messages only (no reply).
FLUD	Message undeliverable (too long, etc.).
FLND	DTMF D not received in network response (AMIS protocol).
FLAA	All messages failed.
GRET	Greeting played.
MBXF	Mailbox full.
NTXF	Network access attempt.
NOCL	No call placed.
QUE	Call queued.
RNA	No answer.
VAC	Extension vacant (does not exist).

Two commands are used to configure CDR: the LOG command defines which transactions are to be retained in the log; the CDR command indicates the portion of the retained data that is to be displayed.

- ❑ **LOG.** Use the LOG command to set, clear, and display the transaction types and status types that the Octel Overture 200/300 collects in the CDR log file.
- ❑ **CDR.** Use the CDR command to display collected data, according to specific filters that can limit the time interval, transaction type, status type, or any combination. The CDR command also provides functions to set the beginning of the log file, identify whether the log file has wrapped around and overwritten itself, and format the output.

This section explains the following:

- ❑ What the CDR file contains
- ❑ How to enable the CDR log to record the desired transactions
- ❑ How to define selected items within the log for display

The following example shows a CDR log that begins on April 18, 1997. The columns on the screen are as follows:

```

@CDR
MM/DD/YY HH:MM:SS XACTIN STAT MS ME PRT DURATN MAILBOX COS CALLER
04/18/97 00:00:24 LPOUTC ERR 009 0:00.1 4450
04/18/97 00:00:25 OFOUTC OK 020 0:00.1 7395
*04/18/97 00:01:06 LOGON BADP 00 00 020 0:00.7 7395
04/18/97 00:01:12 LPOUTC ERR 009 0:00.1 4450
04/18/97 00:06:13 LPOUTC ERR 009 0:00.1 4450
04/18/97 00:06:15 OFOUTC OK 020 0:00.1 7395
*04/18/97 00:06:56 LOGON BADP 00 00 020 0:00.7 7395
04/18/97 00:07:14 CALINT OK 01 033 0:01.7 2070 252
04/18/97 00:07:14 FAXRCV OK 01 007 0:01.7

```

- ❑ **MM/DD/YY.** The MM/DD/YY column lists the month, day, and year of each transaction.
- ❑ **HH/MM/SS.** The HH/MM/SS column lists the hour, minute, and second of each transaction.
- ❑ **XACTIN.** The XACTIN column lists transaction type or indicates the specific type of calling or messaging event. Refer to Table 7-2 for a list of the transaction types.
- ❑ **STAT.** The STAT column shows the status of each transaction type. The status indicates what happened when that call was placed. Refer to Table 7-3 for the list of possible status values.
- ❑ **MS.** The MS column shows the number of messages sent in that transaction. For example, in a call transaction in which no message is left, the entry in the MS column would be 00; with one message left, the entry would be 01. A LOGON entry equals the number of messages sent by the mailbox holder while logged on. A FAXRCV entry indicates the number of fax pages received.
- ❑ **ME.** The ME column shows the number of messages erased while the mailbox holder was logged on.
- ❑ **PRT.** The PRT column contains a three-digit designation, starting with 0, of the port that each transaction came in on. For digital networking entries, this entry is always 000.
- ❑ **DURATN.** The DURATN column lists the number of hours/minutes/tenths of minutes for each transaction. The duration of an event, reflected in a CDR log that is not designated to be logged is included in the first CDR log entry associated with the call. For example, assume that records of type CALATT (call attendant) are not logged, but all transactions of type LOGON are enabled. A call comes into the message server and is routed to the attendant mailbox. The attendant greeting plays, and the caller logs on to a mailbox rather than hangs up. Because a record is not logged for CALATT, the entire duration of that call is attributed to LOGON.

For digital networking entries, this column contains the actual voice length of the message for NTMSGD and NTMSGN entries and is always 0:00.0 for an NTOUTC entry.

☞ Consider the following about entries in the DURATN column:

- ❑ If the message-server time is modified in UPDATE (MODIFY DATE), the durations logged for calls in process at that time will not be correct. When the time is changed because of daylight savings time, the duration logged for calls in process is correct.
- ❑ The maximum duration that can be logged is 24 hours. For example, a call that lasts 25 hours would show a duration of 1 hour.
- ❑ **MAILBOX.** The MAILBOX column lists the number of the mailbox involved for each transaction type (XACTIN). For example, the mailbox listed for a LOGON transaction type is the mailbox entered. The mailbox listed for a network transaction type is the creator's mailbox. The mailbox listed for a CALPA transaction type is the mailbox originally called.
- ❑ **COS.** The COS column shows the number of the incoming port/trunk group, which is logged only for integrated call records. Refer to the Call Detail Records, Display Filters section, in this chapter.
- ❑ **CALLER.** In the CALLER column, the caller's mailbox number is logged only for integrated call records. Refer to the Display Filters section.

The following two columns are displayed by expanding the screen width to 132. When defining the CDR transactions within the LOG command, define L [LEN] to be 132 (L 132) to display these columns:

- ❑ **DESTINATION.** The DESTINATION column lists the numbers entered for pager outcalls and fax-delivery attempts. The entries represent the location names as defined in the LOCATION Table for network outcalls or the identification string of the sending fax machine for a FAXRCV transaction type.
- ❑ **RTE.** The RTE column lists the route numbers for network outcall attempts. The RTE column represents the voice-port allocation for FAXSND, FAXRCV, and FAXEDT (logged by fax channel only) transaction types. For digital networking entries, the entry in this column is always 1 for a NTOUTC transaction type.

Configuring the CDR Log

Until the CDR log is configured to save the transaction records, no records are saved. To save transaction records, use the LOG command to save the combinations of transaction types and status values. The transaction type indicates the specific type of calling event to be logged (for example, call to a mailbox, call to a personal assistant). The status indicates what happened when a call was placed or a message delivery was attempted.

Use the LOG command as follows:

- ❑ Modify the specific transaction-type and status-value combinations used to save transactions in the CDR log.
- ❑ Display specific transaction-type and status-value combinations established, as well as the entire log.

Modifying CDR for Transaction and Status

To begin recording call detail records, the desired combinations of transaction types and status options must be enabled. All transaction types and status values can be set, or specific types of transactions and status values can be set.

- ☞ Setting type and status combinations only determines the records that should actually be saved in the log. Some type and status combinations might not be valid, but setting them has no effect on the log file, because they would not occur.

- ❑ To configure the type/status combinations to be logged, at the @ prompt, type

```
LOG MF CDR 
```

```
@LOG MF CDR
```

```
Specify Filters to MODIFY:
```

```
<"E"nable or "D"isable> <XA string or "ALL"> <ST string or "ALL">
```

```
Empty line when done. ESCape to abort.
```

```
>
```

- ❑ The message server prompts you to specify the filters to be modified. If all transaction types and all status values are to be enabled, at the > prompt, type

```
E ALL ALL 
```

- ❑ You can enter additional modifications to the CDR log. If no other modifications are to be made, press again. The message server confirms that the CDR log was modified.

```
>E ALL ALL
```

```
>
```

```
LOG FILTERS MODIFIED
```

- ❑ If specific transaction types should be set, at the > prompt, enter the type of transaction and the status value to set. Refer to Table 7-2 and Table 7-3 for the correct abbreviations to enter, or use the LOG PF CDR command to display the CDR log status to view these abbreviations. Refer to the Displaying CDR Type and Status Configuration section.
- ❑ A transaction type and a status value can be partially specified. When only the first letter (or two) is entered, all types and values beginning with that letter are enabled. In the following example, only transaction types beginning with CAL and status values beginning with B were set.

```
>E CAL B
```

```
>
```

```
LOG FILTERS MODIFIED
```

```
@LOG PF CDR
```

```
Specify Filters to PRINT:
```

```
<"E"nable or "D"isable> <XA string or "ALL"> <ST string or "ALL">
```

```
Empty line when done. ESCape to abort.
```

```
>E C B
```

CALMBX	BUSY	BADP	BADM	BLOK	BADU
CALATT	BUSY	BADP	BADM	BLOK	BADU
CALPA	BUSY	BADP	BADM	BLOK	BADU
CALFLX	BUSY	BADP	BADM	BLOK	BADU
CALNXT	BUSY	BADP	BADM	BLOK	BADU
CALDID	BUSY	BADP	BADM	BLOK	BADU
CALINT	BUSY	BADP	BADM	BLOK	BADU
CALEXT	BUSY	BADP	BADM	BLOK	BADU
CALIMM	BUSY	BADP	BADM	BLOK	BADU
CALATD	BUSY	BADP	BADM	BLOK	BADU
CALPAD	BUSY	BADP	BADM	BLOK	BADU
CALHLP	BUSY	BADP	BADM	BLOK	BADU

```
>
```

-  Press **Escape** to cancel LOG MF CDR at any time before the message server displays the LOG FILTERS MODIFIED message. No changes are made to the CDR log.
- To disable transaction and status values from the CDR log, use the same command, LOG MF CDR. The same procedure is used to disable transactions and status values, but after LOG MF CDR, enter D before specifying the filters to modify.

```

@LOG MF CDR
Specify Filters to MODIFY:
<"E"nable or "D"isable> <XA string or "ALL"> <ST string or "ALL">
Empty line when done. ESCape to abort.
>D ALL ALL

>
LOG FILTERS MODIFIED

```

Displaying CDR Type and Status Configuration

The transaction types and status values, both those enabled and disabled, that are modified by the LOG MF CDR command can be printed with the LOG PF CDR command.

- To print a single transaction type or all transaction types currently being collected in the CDR log file, at the @ prompt, type

```
LOG PF CDR Enter
```

```

@LOG PF CDR
Specify Filters to PRINT:
<"E"nable or "D"isable> <XA string or "ALL"> <ST string or "ALL">
Empty line when done. ESCape to abort.
>

```

The message server prompts you to enter the filters that should be printed.

- To print specific information, enter a transaction type and status value at the > prompt. A transaction type and a status value can be partially specified. When only the first letter (or two) is entered, all types and values beginning with the letter are displayed. For example, if the status Fxxx should be displayed for all transaction types that begin with CAL, at the > prompt, type

```
E CAL F
```

Those transaction types beginning with CAL, such as CALATD, CALATT, CALDID, that have a status beginning with the letter F, such as FLLQ, FLUD, FLND, are printed.

- If all transaction types and all status values that are enabled are to be displayed, at the > prompt, type

```
E ALL ALL Enter
```

```
>E ALL ALL
```

```
CALMBX  OK      RNA      BUSY     AFWD     DIR      DIRI
        BADP     BADM     MBXF     GRET     VAC      FBSY
        ERR     BLOK     NTFX     APXF     ERRX     FLLQ
        FLBU     FLRT     FLAR     FLDK     FLNR     FLPR
        FLNN     FLNC     FLRF     FLMO     FLUD     FLND
        FLAA     QUE     NOCL     BADU     CNTU
CALATT  OK      RNA      BUSY     AFWD     DIR      DIRI
        BADP     BADM     MBXF     GRET     VAC      FBSY
.
.
.
```

- To print transaction and status types that are disabled, use the same command, LOG PF CDR. The same procedure is used to print disabled transactions and status types, but after LOG MF CDR, enter D before specifying the filters to print.

Displaying Call Detail Records

Use the CDR command to display the CDR log file and accept parameters to display information in the CDR log in various ways, including the following:

- By time: start and/or end time
- Page length, line length
- Specific number of records to be listed
- Actions that occur after a transaction event has been selected, even if those actions were not themselves selected (subsequent actions)
- Types of information specified by filters
- Beginning of the log file set and whether the log file has wrapped around and overwritten itself displayed

To display options available with the CDR command and all the report filter types, at the @ prompt, type

```
CDR ? 
```

```
@CDR ?
```

```
USAGE :
```

```
CDR [S <TIME>] [E <TIME>] [B <TIME>] [R <MAX>] [L <LEN>] [P <LEN>] [W] [SU]
FILTERS: XA <XACTIN>, ST <STAT>, PR <PRT>, CO <COS>, MA <MBX>, MS <MS>, ME <ME>
        <TIME> : <YEAR> <MONTH> <DAY> <HOUR> <MINUTE>
```

Each field shown in the preceding screen is explained in detail in the following section. The following rules govern use of the CDR command to control what is displayed:

- You can enter display specifications and filter types for the CDR command in any order.
- You can omit display specifications and filter types; some can be partially specified, so that a range or record that matches the entered characters is displayed.

If more than one filter (XA, ST, PR, CO, MA, MS, ME) is entered, a match on any one field allows the record to be displayed.

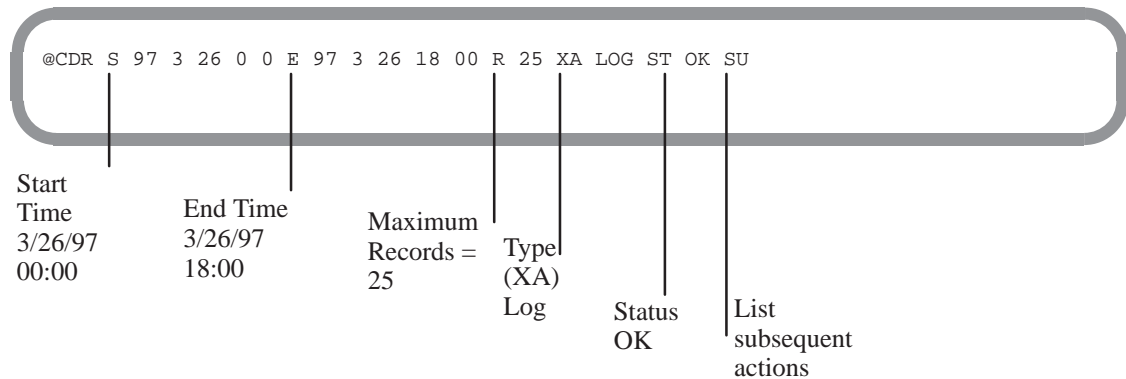



Setting Display Specifications

The fields for setting the CDR display specifications, including log file management, are described below.

Specifying Time

If all information stored in the CDR log file is to be listed, timing is the only criterion that needs to be specified. There are two kinds of time frames:

- The first time frame starts with the logical beginning time or the first record in the log and ends at the end of the file.
- The second time frame has a specified start and end time within the first time frame.
-  If the CDR log buffer becomes full, the records at the beginning of the log are overwritten. Overwriting begins at the physical beginning of the buffer rather than at the logical beginning time that has been set.
- Logical Begin Time**, B [YY MM DD HH MM]. Setting the logical beginning time tells the Octel Overture 200/300 where to start the CDR log if no other start time is specified. Once the logical begin time is set, records collected before this date are no longer accessible.
 -  When using CDR data to develop reports, you should set the logical begin time. If it is not set, when data wraps, there is no way to determine how much data was lost. Refer to the **Wrap** entry, following.

To set the begin time, at the @ prompt, type CDR B and the year, month, day, hour, minute of the begin time. Separate the parts of the date and time with spaces.

```
@CDR B 97 02 01 00 01
BEGIN TIME SET FOR LOG
```

In this example, the logical begin time is 12:01 a.m., February 1, 1997. The message server confirms that the begin time is set.

-  If B is specified, all other filters, except W, are ignored in that command line.

- ❑ **Start Time, S** [YY MM DD HH MM]. To display the CDR log from a time after the logical begin time, enter a specific start time. If no start time is specified, the listing begins with the first record logged after the logical begin time. At the @ prompt, type

```
CDR S 
```

To select a particular start time, at the @ prompt, type CDR S, followed by the year, month, day, hour, and minute of the start time. Separate the parts of the date and time with spaces.

```
@CDR S 97 02 07 08 00
```

- ❑ **End Time, E** [YY MM DD HH MM]. To display CDR data ending at a specified time other than the last record currently in the log, enter a specific end time.

```
@CDR E 97 09 07
```

You can specify an end time with or without a start time. If no start time is specified, the CDR log is displayed from the logical begin time to the end time specified.

You can add additional filters to the command line to display only specific type and status information.

- ❑ **Wrap, [W]**. Use W to display the current wrap status in the log file. If some data in the CDR file has been overwritten, the Octel Overture 200/300 responds with the following:

```
LOG FILE WRAPPED
LOG FILE BEGINNING TIME IS MM/DD/YY HH:MM:SS
TIME OF FIRST RECORD IN LOG IS MM/DD/YY HH:MM:SS
```

☞ If the logical begin time is not set, line two in the preceding screen is not displayed.

If the logical begin time is set before the file has been overwritten, the Octel Overture 200/300 responds with the following:

```
TIME OF FIRST RECORD IN LOG IS MM/DD/YY HH:MM:SS
```

All records that were logged between the beginning time and the time of first record are lost. If W is specified, all other filters are ignored in that command line.

Managing the Log File

Establishing the correct logical begin time is critical to good log file management. The following is the recommended procedure for regular CDR data collection:

- Specify the end time. At the @ prompt, type

```
CDR E 97 01 15 06 00 
```

Records from the current logical begin time to 6:00 a.m., January 15, 1997, are displayed.

- Set the begin time to that same end time. At the @ prompt, type

```
CDR B 97 01 15 06 00 
```

To see the current logical begin time

```
@CDR W
LOG FILE WRAPPED
LOG FILE BEGINNING TIME IS 01/01/97 12:01:00
TIME OF FIRST RECORD IN LOG IS 01/01/97 08:25:03
```

To print records from the current logical begin time to 6:00 a.m., January 15, 1995

```
@CDR E 97 01 15 06 00
MM/DD/YY HH:MM:SS XACTIN STAT MS ME PRT DURATN MAILBOX COS CALLER
01/01/97 10:42:07 TIMEST OK
.
.
01/14/97 20:59:51 CALINT DIRI OO      034 0:00:0
```

To reset logical begin time

```
@CDR B 97 01 15 06 00
BEGIN TIME SET FOR LOG
```

Specifying the Display

The settings for how the CDR log is displayed on the screen are described below:

- Line Length, L** [LEN]. The default column format is 80 columns, but any line length up to 132 columns can be displayed. Two columns, DESTINATION and RTE, cannot be seen if the column format is set to 80. To see those columns, you must specify the line length to be 132.
- Page Length, P** [LEN]. The default number of lines per page is 66. If header information should not be displayed every 66 lines, change this parameter.

If 0 is entered, the page displays one header at the beginning of the CDR file.

- Number of Records, R** [MAX]. Use this command to specify the maximum number of records to list during this command transaction. If no maximum is specified, all records that meet the criteria are displayed.
- Subsequent Action, SU**. Print the subsequent actions for records that pass the filter criteria. An asterisk (*) is printed in the first column for each transaction that is **not** the initial transaction of the call. To see subsequent actions completed for a record, enter SU in the command line.

```
@CDR XA LOGON ST BADP SU
MM/DD/YY HH:MM:SS XACTIN STAT MS ME PRT DURATN MAILBOX
*08/09/97 10:19:38 LOGON  BADP 00 00 055 0:00.2 4430
*08/09/97 10:19:38 LOGON  BADM 00 00 055 0:00.0 6
```

Display Filters

You can use seven filters to define specifically the type of information that is displayed in the CDR log. Multiple filters can be used in a command line, but each filter can appear only once. However, if only the first letter or two of the transaction type or status value is entered, all transaction types or status values beginning with the letter entered are filtered. If no filter is specified, all information is displayed. The filters are as follows:

- ❑ **Transaction Type, XA** [XACTIN]. Enter the transaction type that should be displayed. In the command string, type XA [type]. For example, type XA NTMSGD for network messages send day, or XA NT for all network transactions.
- ❑ **Status, ST** [STAT]. Enter the type of status information that should be displayed. In the command string, type ST [status]. For example, enter ST FLLQ for failed line-quality test or ST FL for all network-failure conditions.
- ❑ **Port, PR** [PRT]. If a specific port should be displayed, enter that port number in the command string. The designation of a single port number must consist of three digits (for example, 005 for Port 5).

For ports numbered above 9, the 2-digit port number should be preceded by a single 0 (for example, 023). For ports numbered above 9, a range of 10 ports can be specified by entering the 0, plus one significant number for the beginning of the range. For example, type PR 03 to display ports 30–39.

- ❑ **COS, CO** [COS]. The COS of the incoming port/trunk group for an integrated-call record can be displayed. The designation of a single COS must consist of 3 digits. For COS 1 through 9, the COS should be preceded by 00 (for example, 001). For COS 10 through 99, the COS should be preceded by 0 (for example, 037). For COS 10 through 99, a range of ten COSs can be specified by entering the 0 plus one significant number for the beginning of the range. For example, type CO 09 to display COS 90 through 99. To display COS 100 through 199, enter 1.
- ❑ **Mailbox, MA** [MBX]. Specific or partially specified mailbox number prefixes can be displayed. For example, to display all mailboxes that start with 43, type MA 43.
- ❑ **Messages Sent, MS** [MS]. With this filter, the number of messages sent during a transaction can be defined. For example, if abandoned calls for a specific transaction type should be displayed, specify MS 00. All calls with 0 messages left would be displayed.
- ❑ **Messages Erased, ME** [ME]. Use this filter to define the number of messages erased.

All records contain information about transaction type, status, port and duration. Additional information is logged for specific transaction types. The settings included in this information are defined at the beginning of this section. A matrix of which settings apply to which transaction types is presented in Table 7-4.

Examples of Using Multiple Display Filters

The following example shows the use of two filters:

- ❑ XA CAL, all transaction types starting with CAL
- ❑ PR 009, a specific port

```
@CDR XA CAL PR 009
MM/DD/YY HH:MM:SS XACTIN STAT MS ME PRT DURATN MAILBOX COS CALLER
11/22/97 12:04:55 CALMBX GRET 00 009 0:00.1 7777
*11/22/97 12:05:14 CALFLX QUE 00 009 0:00.3 8103
11/22/97 12:12:13 CALMBX BUSY 01 009 0:01.5 4319
```

The following example shows the use of three filters:

- XA CAL, all transaction types starting with CAL
- PR 009, a specific port
- MA 777, a specific mailbox

```
@CDR XA CAL PR 009 MA 7777
MM/DD/YY HH:MM:SS XACTIN STAT MS ME PRT DURATN MAILBOX COS CALLER
11/22/97 12:04:55 CALMBX GRET 00 009 0:00.1 7777
11/22/97 12:43:14 CALMBX GRET 00 009 0:00.4 7777
11/22/97 13:13:13 CALMBX GRET 00 009 0:01.0 7777
```

 A filter can be entered only one time.

The following example shows an incorrect entry: the ST filter is entered twice.

```
@CDR XA LOGON ST BADP ST OK
USAGE:
CDR[S <TIME>] [E <TIME>] [B <TIME>] [R <MAX>] [L <LEN>] [P <LEN>] [W] [SU]
FILTERS: XA <XACTIN>, ST <STAT>, PR <PRT>, CO <COS>, MA <MBX>, MS <MS>, ME <ME>
<TIME> : <YEAR> <MONTH> <DAY> <HOUR> <MINUTE>
```

Table 7-4 Information Logged by Transaction Type

Transaction Type	Field						
	MS	ME	COS	MAILBOX	CALLER	DESTINATION	RTE
ALOUTC							
APIN							
APOUTC				✓			
CALATD	✓			✓			
CALATT	✓			✓			
CALDID	✓			✓			
CAEXT				✓			
CALHLP				✓			
CALIMM	✓			✓			
CALINT	✓		✓	✓	✓		
CALMBX	✓			✓			
CALNXT	✓			✓			
CALPA	✓			✓			
CALPAD	✓			✓			
CALSDM	✓			✓			
COSOVR			✓				
FAXDLV				✓		✓	
FAXEDT						✓	
FAXQCK	✓			✓			
FAXRCV	✓				✓	✓	
FAXSND						✓	
LOGON	✓	✓		✓			
LPOUTC				✓			
MODEM							
MWOUTC				✓			
OFOUTC				✓		✓	
NTCHEK					✓		
NTMSGD				✓			
NTMSGN				✓			
NTMSGR				✓			
NTIN							
NTOUTC						✓	✓
QCKMSG	✓			✓			
QCKINT	✓		✓	✓	✓		

CDR Size by Transaction Type

The Octel Overture 200/300 allocates 2 MB of disk space for CDR events, and records a time stamp (TIMEST) every 2 K. Each call record requires from 10–18 bytes, depending on the number of digits in the mailbox. Table 7-5 shows the length of call detail records by transaction type.

Table 7-5 Call Detail Record Size by Transaction Type

Transaction Type (XACTIN)	Record Size (Bytes), Fixed Portion	Additional Bytes, Variable Portion*
CALMBX	10	1...8 (Mailboxes)
CALATT	10	1...8 (Mailboxes)
CALATD	10	1...8 (Mailboxes)
CALPA	10	1...8 (Mailboxes)
CALPAD	10	1...8 (Mailboxes)
CALSMD	10	1...8 (Mailboxes)
CALNXT	10	1...8 (Mailboxes)
CALDID	10	1...8 (Mailboxes)
CALINT	16	1...8 (Mailboxes)
CALIMM	10	1...8 (Mailboxes)
CALEXT	8	1...8 (Extensions)
CALHLP	8	1...8 (Mailboxes)
COSOVR	10	0
LOGON	11	1...8 (Mailboxes)
QCKMSG	10	1...8 (Mailboxes)
QCKINT	16	1...8 (Mailboxes)
OFOUTC	13	1...16 (Dialed numbers)
MWOUTC	13	0
LPOUTC	13	0
ALOUTC	9	0
FAXQCK	10	1...8 (Mailboxes)
FAXDLV	13	1...16 (Dialed numbers)
FAXSND	11	1...8 (Mailboxes)
FAXRCV	11	1...8 (Mailboxes)
FAXEDT	11	1...8 (Mailboxes)
NTOUTC	16	0
NTMSGD	9	1...8 (Mailboxes)
NTMSGN	9	1...8 (Mailboxes)
NTMSGR	9	1...8 (Mailboxes)
NTIN	9	0
NTCHK	9	1...8 (Mailboxes)
APIN	9	0
APOUTC	9	1...23 (Mailboxes or dialed numbers)
MODEM	9	0
TIMEST	9	0

*This varies depending on the number of digits in the mailbox or the number of digits in the dialing string.

To estimate how many days the CDR records can be stored before the buffer becomes full and the log file wraps, perform the following steps for each transaction type enabled:

1. Multiply the number of mailbox holders by the average number of times per day that the mailbox registers activity for the transaction types logged.
2. Using Table 7-5, calculate the number of bytes used per transaction type record logged; include 1 byte for each 2 digits in the mailbox number.
3. Multiply the number of transactions per day (from step 1) by the number of bytes per transaction for that transaction type (from step 2). This is the number of bytes used in 1 day.
4. Sum the result of step 3 for each transaction type to yield an estimate of the number of bytes used per day.
5. Divide the disk space allocated for CDR records (2 MB) by the number of bytes used in 1 day to determine how many days the storage space will last before the information wraps.

This estimate can help establish the schedule for checking the CDR log.

Examples of Various CDR Log Screens

Several examples of various CDR logs follow. CDR logs can be created for billing or maintenance purposes.

Invalid Logons With Subsequent Actions

The following example shows a CDR log for entries of invalid security codes and subsequent caller actions. This type of CDR log could be used to investigate unauthorized access activity. In this example, the entry BADP in the STAT column indicates that an invalid security code was entered; the BADM entry indicates that an invalid mailbox number was entered.

```
@CDR XA LOGON ST BADP SU
MM/DD/YY HH:MM:SS XACTIN STAT MS ME PRT DURATN MAILBOX
*08/09/97 10:19:38 LOGON BADP 00 00 055 0:00.2 4430
*08/09/97 10:19:38 LOGON BADM 00 00 055 0:00.0 6
```

Logon Calls to a Specific Mailbox

The following example shows a CDR log that details four logon calls to mailbox 4585, starting on August 12, 1997.

In the status column, the OK entry indicates that the logon was successful, and the BADP entry indicates that an invalid security code was entered when attempting to log on to mailbox 4585. The log shows subsequent actions, since the initial action in each case was a direct call from the extension (not shown).

```
@CDR XA LOGON MA 4585 S 97 08 12 08 00
MM/DD/YY HH:MM:SS XACTIN STAT MS ME PRT DURATN MAILBOX
*08/12/97 08:22:17 LOGON OK 01 01 055 0:01.8 4585
*08/12/97 08:23:42 LOGON OK 00 01 051 0:00.2 4585
*08/12/97 08:51:03 LOGON OK 01 00 053 0:01.5 4585
*08/12/97 09:46:13 LOGON BADP 00 00 056 0:00.1 4585
```

Fax Transactions

The following example shows a CDR log for all fax transactions. The CDR command shows the column length set to 132 (L 132), which is required to see the DESTINATION and RTE columns.

```
@CDR XA FAX L 132 PO O S 08 97 08 16 08 00
MM/DD/YY HH:MM:SS XACTIN STAT MS ME PRT DURATN MAILBOX DESTINATION RTE
08/16/97 08:00:03 FAXRCV OK 02 007 0:01.4 2126911191 045
08/16/97 08:00:05 FAXDLV OK 032 0:02.6 2000 2000
08/16/97 08:00:05 FAXSND OK 066 0:02.6 032
08/16/97 08:00:03 FAXDLV OK 030 0:01.6 2000 2000
08/16/97 08:00:05 FAXSND OK 063 0:01.6 030
08/16/97 08:00:05 FAXQCK OK 01 032 0:03.9 4735
08/16/97 08:01:57 FAXRCV OK 07 063 0:03.7 2200 032
```

In this example, the records in the log show the following:

- ❑ A two-page fax was successfully received (FAXRCV and OK entries) from a location with an identification string of 2126911191. The RTE column displays the voice port allocated with a FAXRCV entry in the XACTIN column.
- ❑ A fax was successfully delivered (FAXDLV entry) for mailbox 2000 to extension 2000. The FAXSND entry shows which fax channel was used to deliver the fax.
- ❑ A seven-page Quick Fax was sent (FAXQCK entry) to mailbox 4735. Every FAXQCK record is followed by a FAXRCV record.

The PRT column shows the voice ports for FAXQCK and FAXDLV, and the fax channels for FAXRCV and FAXSND.

The MS column shows the number of pages received for FAXRCV records. For FAXQCK transactions, the 01 is always indicated in conjunction with a quick fax message, with or without voice annotation.

CDR for Network Messages

The following example shows a CDR log for network messages. You could use this CDR log for an application where the customer bills the user for the calls made on the network.

Set the column length in the CDR command to 132 (L 132), which is required to see the DESTINATION and RTE columns. The DESTINATION column shows the name in the LOCATION Table.

```
@CDR L 132 XA NT ST OK
MM/DD/YY HH:MM:SS XACTIN STAT MS ME PRT DURATN MAILBOX DESTINATION RTE
09/14/97 09:15:31 NTIN OK 029 0:00.5
*09/14/97 09:16:17 NTMSGR OK 029 0:00.8 66093164
09/14/97 09:16:50 NTOUTC OK 030 0:00.6 VMX2D
*09/14/97 09:18:42 NTMSGD OK 030 0:01.8 4736
```

The MAILBOX column entry for NTMSGR and NTMSGD entries is the mailbox number of the creator of the message. The transaction type NTMSGR is preceded with an NTIN entry, and NTMSGD is preceded with an NTOUTC entry. An OK entry in the STAT column shows that the transaction was successful.

MWN Attempts Encountered Fast Busy

The following example shows a CDR log for a port that encountered fast-busy while attempting a message-waiting-notification outcall.

@CDR KA MWOUTC ST FBSY

MM/DD/YY	HH:MM:SS	XACTIN	STAT	MS	ME	PRT	DURATN	MAILBOX	COS	CALLER
02/10/97	14:12:32	MWOUTC	FBSY			012	0:00.0	4428		
02/10/97	14:13:09	MWOUTC	FBSY			012	0:00.0	2065		
02/10/97	14:19:21	MWOUTC	FBSY			012	0:00.0	4341		

MWI Attempts

The following example shows a CDR log of lamp message-waiting-indication attempts in an in-band and DTMF message-waiting environment.

@CDR KA LPOUTC

MM/DD/YY	HH:MM:SS	XACTIN	STAT	MS	ME	PRT	DURATN	MAILBOX	COS	CALLER
02/10/97	15:00:24	TIMEST	OK							
02/10/97	15:03:09	LPOUTC	ERR			012	0:00.0	7711		
02/10/97	15:07:39	LPOUTC	OK			012	0:00.0	4341		
02/10/97	15:07:41	LPOUTC	OK			011	0:00.0	4324		
02/10/97	15:07:43	LPOUTC	OK			010	0:00.0	8301		
02/10/97	15:07:45	LPOUTC	OK			009	0:00.0	4532		
02/10/97	15:08:10	LPOUTC	ERR			008	0:00.0	7711		
02/10/97	16:08:23	TIMEST	OK							

DID Call

The following example shows a call through the DID module.

@CDR KA CALDID

MM/DD/YY	HH:MM:SS	XACTIN	STAT	MS	ME	PRT	DURATN	MAILBOX	COS	CALLER
02/11/97	11:02:48	TIMEST	OK							
02/11/97	11:02:48	CALDID	OK	00		034	0:00.1	4347		
02/11/97	12:59:37	CALDID	GRET	0		034	0:00.4	4347		
02/11/97	13:00:11	TIMEST	OK							
02/11/97	13:00:11	CALDID	GRET	01		034	0:00.2	4347		
02/11/97	13:00:34	CALDID	GRET	00		034	0:00.0	4347		

Specific Octel Overture 200/300 Ports

The following example shows a CDR log for ports 10 through 19. Only records for a range of ports can be displayed at one time. In this command line, PR 01 means that records for ports 010 through 019 are displayed.

@CDR PR 01

MM/DD/YY	HH:MM:SS	XACTIN	STAT	MS	ME	PRT	DURATN	MAILBOX
08/09/97	10:02:48	LPOUTC	OK			013	0:00.1	4313
08/09/97	10:02:48	LPOUTC	OK			013	0:00.1	4480
08/09/97	10:59:37	LPOUTC	OK			013	0:00.4	4379
08/09/97	10:00:11	CALATT	OK	00		014	0:00.1	4300

7.4 NAMESEND ACTIVITY TRACE LOG

The Namesend Activity Trace Log collects Namesend propagation transaction data for Digital Networking in a log file on the Octel Overture 200/300. This log includes all activity associated with names propagation, including the following:

- Recorded names received from and propagated to a location using Namesend
- Additions, deletions, and modifications to the queue of names that are pending propagation, the Netnames Table, and the Dial-by-Name Directory.

 Refer to the Networking Volume, Digital Networking for information about Namesend.

Use the LOG PR NAM command for different combinations of print options and filters that can be specified to consolidate information and focus on specific types of Namesend activities to be displayed.

To use the LOG command for Namesend Activity Trace activities, at the @ prompt, type

LOG PR NAM

```
@LOG PR NAM
Specify Print Option(s):
  "S"tart <time>, "E"nd <time>, "L"ine <length>, "P"age <length>, "\",
  "M"ask <mask (including date and time fields)>, "C"ontinuous
Filters: TA TY EV AU MB NA LO
```

Refer to the Log Command section for an explanation of LOG print options.

In addition to the LOG print options that control the output format, you can enter specific filters and arguments to limit the output to only those activities that match the set of search criteria. Filters need not be specified; in some cases, filters can be partially specified. Only the values that match the specified filters are displayed. The following filters are available:

- Task**, TA [TASK]. This filter is for technical support use.
- Type**, TY [TYPE]. This filter displays a specific type of Namesend activity. Enter one of the types listed in Table 7-6 to specify a specific type to filter.

Table 7-6 Namesend Activity Types

Type	Description
QUEUED	Names in queue that are pending propagation
DEQUEUE	Names deleted from the queue pending propagation
NAM_RCV	Names that were received at this location
NAM_SND	Names that were propagated automatically
RBLD	The queue of names was propagated again because of a restart or reload.

- ❑ **Event**, EV [EVENT]. This filter displays a specific event. The events that can be specified and their correct spelling are listed in Table 7-7. Only one event can be specified at a time.
- ❑ **Auxiliary**, AU [AUXILIARY]. This filter displays supplemental event activities. The supplemental activities that can be designated and their correct spelling are listed in Table 7-7. Only one supplemental event can be specified for each event.
- ❑ **Mailbox**, MB [MAILBOX]. This filter displays records for a specific mailbox or extension number. The filter can designate partial mailbox digits to display all mailboxes beginning with a specific digit.
- ❑ **Name**, NA [NAME]. This filter displays the name that was sent. A specific name can be specified or the filter can designate can specify an alphabetic pattern match to display names that match the pattern specified.
- ❑ **Location**, LOC [LOCATION]. This filter displays the location from which the name was sent. A specific location can be specified.

Below is an example of a Names trace log with no filters specified.

```

@LOG PR NAM
MM/DD/YY HH:MM:SS  TASK      TYPE      EVENT     AUX      MBX/EXTEN  NAME      LOC
-----
06/08/97 12:33:44  CHAN_055  QUEUED    ADDASC    Q_FULL    4343      JONES JOE  MILPITAS
06/08/97 12:42:59  TERMILTAS  QUEUED    ADMIN     SUCC      4343      JONES JOE  MILPITAS
06/08/97 12:34:56  LCH_13     NAMSND    DIGNET    NDRFUL    4343      JONES JOE  MILPITAS
06/08/97 12:35:01  LCH_13     NAMSND    DIGNET    SUCC      4343      JONES JOE  MILPITAS
06/08/97 12:35:59  LCH_13     DEQUEU    SENT      SUCC      4343      JONES JOE  MILPITAS

```

Table 7-7 Event and Aux Activities in Namesend Activity Log

TYPE	EVENT	DESCRIPTION	AUX	DESCRIPTION
QUEUED	ADMIN	Addition to the queue of names pending by administrator.	SUCCESS Q_FULLL FAIL	Success. Queue is full. An error was encountered on the remote side. Remote side will have a software error or hardware error.
	ADDASC	An alphabetic name (ASCII) was added.	SUCCESS Q_FULLL FAIL	Success. Queue is full. An error was encountered on the remote side. Remote side will have a software error or hardware error.
	MODASC	An alphabetic name (ASCII) was modified.	SUCCESS Q_FULLL FAIL	Success. Queue is full. An error was encountered on the remote side. Remote side will have a software error or hardware error.
	MODSPK	A spoken name was modified.	SUCCESS Q_FULLL FAIL	Success. Queue is full. An error was encountered on the remote side. Remote side will have a software error or hardware error.
DEQUEUE	ADMIN	Deletion from the queue of names pending by administrator.	SUCCESS FAIL	Success. An error was encountered on the remote side. Remote side will have a software error or hardware error.
	SENT	Name was successfully propagated and was removed from the queue.	SUCCESS FAIL	Success. An error was encountered on the remote side. Remote side will have a software error or hardware error.
NAM_RCV	DIGNET	Names received at this location were sent via digital networking.	SUCCESS NDRFUL NTNFUL Q_FULLL FAIL	Success. NDR Table is full. NETNAME Table is full. Queue is full. An error was encountered on the remote side. Remote side will have a software error or hardware error.
NAM_SND	DIGNET	Names propagated automatically via digital networking.	SUCCESS NDRFUL NTNFUL Q_FULLL FAIL	Success. NDR Table is full. NETNAME Table is full. Queue is full. Failed due to lack of resources.

7.5 MOVES, ADDS, AND CHANGES LOG

(Serenade 3.0)

Many configuration changes that are made in the INSTALL program, in the UPDATE program, and within the mailbox are recorded in the Moves, Adds, and Changes log. With the MAC log, you can use the following commands:

- LOG PR MAC displays all activities in the MAC log or sets filters for specific records to be displayed.
- LOG BE MAC sets the beginning date and time for the MAC log. Once the beginning date and time is set, records collected before this date are no longer accessible.
- LOG ST MAC displays the beginning date and time and the time of the first record presently in the log.

The following example shows a MAC log. A description of each of the fields follows.

```
MM/DD/YY HH:MM:SS BY  ACT  REC      ID      ATTR  VALUE
01/03/98 11:07:14 USER MOD  USER   7829   AUTO  72007829
01/03/98 11:19:24 USER DEL  USER   7829   AUTO
01/03/98 11:29:05 USER MOD  USER   7829   AUTO  72007829
01/03/98 11:54:45 UPDT MOD  DIST   7779   MBR    6639223
01/03/98 12:21:38 **** SAV
```

- MM/DD/YY.** Month, day, and year of the transaction.
- HH:MM:SS.** Hour, minute, and second of the transaction.
- BY.** The type of application used to make a change to the configuration.
- ACT.** The type of action taken, such as modification, deletion, or addition of a record.
- REC.** The table, distribution list or system location that was modified.
- ID.** The record modified. If the values associated with a mailbox are changed, the entry for this field is the mailbox number.
- ATTR.** Record that was changed. Not all changes are recorded.
- VALUE.** The new value for a record that was modified.

Types of Configuration Table Entries Logged

Change are logged to the MAC log when the following configuration tables are modified:

- SYSTEM PARAMETER Table
- INFORMATION Table
- CLASS OF SERVICE Table
- USER Table
- SCHEDULE Table
- CSTAT Table
- NAMES Table
- SLOTS Table
- CUSTOM PROMPT Table
- NUMBERING PLAN Table

In addition, the system distribution list (SDL) changes and extended mailbox additions are logged.

SYSTEM PARAMETER Table

The following system parameters are entered in the MAC log, if they have been modified. The system parameter index number is displayed in the ATTR field.

- 145 — APPLICATION PROCESSOR ERROR MAILBOX
- 147 — NAMES DIRECTORY MAILBOX
- 156 — APPLICATION PROCESSOR MESSAGE POOL EM LIST
- 199 — NET: CREATOR MAILBOX FOR RETURNED MESSAGES

An example of a system parameter modification entry to the MAC log follows. In this example, System Parameter 199 was modified to set the creator mailbox to 3433.

```
MM/DD/YY HH:MM:SS BY ACT REC ID ATTR VALUE
01/15/98 14:28:25 UPDT MOD SYSP 01 199 3433
```

CLASS OF SERVICE

Class of Service (COS) attributes that you add, modify, or delete are logged to the MAC log. When you modify a COS, the ATTR field displays ATBU. In the following example, COS 000 was modified to include Attribute 112.

```
MM/DD/YY HH:MM:SS BY ACT REC ID ATTR VALUE
01/15/98 14:28:25 UPDT MOD COS 000 ATBU 112
```

SCHEDULE Table

When you add a SCHEDULE Table or modify a time period or INFORMATION Table default for a SCHEDULE Table, the information is logged in the MAC log. The REC field displays the COS, and the ID field displays the corresponding COS number. The ATTR and VALUE fields are empty.

When you create a SCHEDULE Table, and you add a number of schedules and the default schedule, the first entry in the ACT field displays ADD; for second and subsequent entries, the entry in the ACT field displays MOD. The schedule number is not listed.

```
MM/DD/YY HH:MM:SS BY ACT REC ID ATTR VALUE
01/15/98 14:28:25 UPDT ADD COS 000
01/15/98 14:28:40 UPDT MOD COS 000
01/15/98 14:28:48 UPDT MOD COS 000
```

NAMES Table

When you add names to or delete names from the NAMES Table, an entry is made in the MAC log. Whether adding or modifying names, the ACT field displays MOD. The REC field displays whether it is a USER Table or Distribution list change; ID field displays the mailbox, the ATTR field displays the name, and the VALUE field displays the new name. In the following example, the name for mailbox 300 is changed to Newton; the name for distribution list 302 is changed to James, and the name for mailbox 300 is deleted.

 Delete is automatic, as part of the Modify command.

```
MM/DD/YY HH:MM:SS BY ACT REC ID ATTR VALUE
01/15/98 14:28:25 UPDT MOD USER 300 NAME NEWTON
01/15/98 14:30:55 UPDT MOD DIST 302 NAME JAMES
01/15/98 14:31:15 UPDT DEL USER 300 NAME
```

CUSTOM PROMPT Table

When you modify a CUSTOM PROMPT Table, the MAC log enters the changes by language.

- The entry in the REC field for changes to the CUSTOM PROMPT Table is LANG.
- The ID field is the number of the language changed.
- The ATTR field can include the following:

ATTR	Description
ERNX(n)	The mailbox that plays the nonexistent mailbox greeting for first digit “n” was changed. A greeting from the mailbox listed in the VALUE field plays when an extension starting with the “n” digit does not exist, but an attempt is made to contact it.
ERBL(n)	The mailbox that plays the blocked extension greeting for first digit “n” was changed. The greeting of the mailbox listed in the VALUE field plays when an extension starting with the “n” digit is blocked, and an attempt is made to contact it.
MSGWT	The message-waiting-notification mailbox was changed to the mailbox listed in the VALUE field.
APNTF	The application-control-processor notification mailbox was changed to the mailbox listed in the VALUE field.
TUTOR	The new-user-tutorial mailbox was changed to the mailbox listed in the VALUE field.

```
MM/DD/YY HH:MM:SS BY ACT REC ID ATTR VALUE
01/15/98 14:58:25 UPDT MOD LANG 001 ERNX1 200
01/15/98 15:00:55 UPDT MOD LANG 001 ERNX3 200
01/15/98 15:01:15 UPDT DEL LANG 001 TUTOR 300
```

INFORMATION Table

When you add, modify, or delete an INFORMATION Table, the changes are logged in the MAC log. The ATTR field can display

ATTR	Description
TYP	The type of INFORMATION Table added or deleted. M is for mailbox and P is for port.
INTCP	The intercept mailbox is changed to the mailbox listed in the VALUE field.

GRT	The Greeting mailbox is changed to the mailbox listed in the VALUE field.
DIVRT	The Divert mailbox is changed to the mailbox listed in the VALUE field.
NEXT	The Next mailbox is changed to the mailbox listed in the VALUE field.
MXMNU	The Maximum Digits for Menu is changed to the number in the VALUE field.
PREFX	The Prefix digits is changed to the number in the VALUE field.
FIFO	The FIFO Queue message mailbox is changed to the mailbox listed in the VALUE field.

```
MM/DD/YY HH:MM:SS BY ACT REC ID ATTR VALUE
01/15/98 14:58:25 UPDT ADD INFO 001 TYPE M
01/15/98 15:00:55 UPDT MOD INFO 003 INTCP 300
01/15/98 15:01:15 UPDT MOD INFO 003 DIVRT 400
```

USER Table

When you add, modify, or delete the USER Table, the changes are logged in the MAC log. The ATTR field can display the following:

ATTR	Description
COS	The COS number for the mailbox is displayed in the ID field.
EXTN	An extension number was added to the mailbox displayed in the ID field.
FDIG(x)	The mailbox listed in the next record begins with a new first digit. The “x” is the first-digit number. The VALUE field lists the first digit.
AUTO	The autocopy mailbox was changed to the number displayed in the VALUE field.
OFFPA	The offsite pager number was changed to the number displayed in the VALUE field.
PFAX	The personal fax number was changed to the number displayed in the VALUE field.
PERSA	The personal assistance number was changed to the number displayed in the VALUE field.
PDL(x)	A mailbox number is added to the personal distribution list “x”.
MXMNU	The maximum number of digits used for the single-digit menu has been changed.
SEC	This entry is displayed when the security code was reset.
UID	This user ID number was set for the mailbox number in the ID field.

When you have added a new mailbox number to the USER Table, the first entry in the MAC log shows the mailbox and the COS added. Subsequent entries show other USER Table configurations for the mailbox.

 When you have created a mailbox and added an extension number, the ACT field displays MOD and the ATTR field displays EXTN.

```
MM/DD/YY HH:MM:SS BY ACT REC ID ATTR VALUE
01/15/98 14:58:25 UPDT ADD USER 300 COS 000
01/15/98 15:01:15 UPDT MOD USER 300 EXTN 3010
```

When you have created a mailbox starting with a new first digit, before the entry indicating mailbox creation, an entry is made showing the new first digit; ATTR displays the first-digit number, and the VALUE field displays the length of the mailbox number. When the last number starting with a particular digit is deleted, an entry is made indicating the deletion of the mailbox number; another entry is made displaying the first-digit number. The VALUE field is empty.

```
MM/DD/YY HH:MM:SS BY ACT REC ID ATTR VALUE
01/15/98 14:58:25 UPDT MOD SYS 01 FDIG3 3
01/15/98 15:01:15 UPDT ADD USER 300 COS 000
```

CSTAT Table

Only changes to CSTAT Table Index 1 – PDL INDEX VALUE are logged. The ATTR field displays PDLSC.

```
MM/DD/YY HH:MM:SS BY ACT REC ID ATTR VALUE
01/15/98 14:28:25 UPDT MOD COS 000 PDLSC 001
```

SLOTS Table

Changes to the SLOTS Table are logged. When you add a slot number, it is displayed in the IO field. The following screen shows that slot 1 was added.

```
MM/DD/YY HH:MM:SS BY ACT REC ID ATTR VALUE
01/15/98 14:28:25 UPDT ADD SLOT 001
```

NUMBERING PLAN Table

Initial digits that are added, modified, or deleted in the NUMBERING PLAN Table are recorded in the MAC log.

```
MM/DD/YY HH:MM:SS BY ACT REC ID ATTR VALUE
01/15/98 14:28:25 UPDT ADD CAB 212
```

When you add or modify the SELF network location number, it is recorded in the MAC log.

```
MM/DD/YY HH:MM:SS BY ACT REC ID ATTR VALUE
01/15/98 14:28:25 UPDT MOD SYS 01 SELF 88
```

System Distribution Lists

The MAC log displays changes to system distribution lists, including the creation of an SDL or changes to the COS of an SDL pilot mailbox. When you add the first member of an SDL, the MAC log displays the mailbox as a SDL pilot (CUD) and then displays the mailbox number of the first member added.

```
MM/DD/YY HH:MM:SS BY ACT REC ID ATTR VALUE
01/15/98 14:58:25 UPDT CUD USER 305
01/15/98 15:01:15 UPDT MOD DIST 305 MBR 306
01/15/98 15:01:25 UPDT MOD DIST 305 COS 001
```

Extended Mailbox

Changes to add extended mailboxes are logged, when you add a mailbox to an extended mailbox. The ATTR field displays EMB.

```
MM/DD/YY HH:MM:SS BY ACT REC ID ATTR VALUE
01/15/98 14:28:25 UPDT ADD USER 301 EMB 303
```

Using the LOG PR MAC command

To use the LOG command for MAC activities, at the @ prompt, type

```
LOG PR MAC 
```

```
@LOG PR MAC
Specify Print Option(s):
  "S"tart <time>, "E"nd <time>, "L"ine <length>, "P"age <length>, "\",
  "M"ask <mask (including date and time fields)>, "C"ontinuous
Filters: BY AC RE ID AT VA
```

Refer to the Log Command section in this chapter for an explanation of LOG print options.

In addition to the LOG print options that control the output format, you can enter specific filters and arguments to limit the output to only those activities that match the set of search criteria. Filters need not be specified; in some cases, filters can be partially specified. Only the values that match the specified filters are displayed. The following filters are available:

- BY.** This filter displays the application used to make a change to the configuration. Enter one of the BY names the follows to specify a specific application.

BY	Description
UPDT	Configuration change listed was made either in UPDATE or INSTAL.
****	Message server actions can include actions such as saving the configuration file.
USER	A mailbox holder made changes directly in the mailbox

- AC.** This filter displays the action taken, such as add, modify, or delete a record. A list of the actions that can be selected follows:

AC	Description
DEL	Record was deleted.
ADD	Record was added.
MOD	Record was modified.
CUD	Mailbox holder's mailbox was converted to a distribution list.
CDU	Distribution list was converted to a mailbox holder mailbox.
SAV	This entry indicates an exit from update.
INS	Changes were made in the INSTALL program
REN	Renumber

- RE.** This filter displays the configuration table, distribution list or message server location that was modified. Modifications to the following are recorded in the MAC log.

RE	Description
USER	USER Table
DIST	System Distribution list
COS	CLASS OF SERVICE Table or SCHEDULE Table
INFO	INFORMATION Table
SLOT	SLOT Table
LANG	CUSTOM PROMPT Table
CAB	NUMBERING PLAN Table*
SYS	Message server changes, including changes made to the FIRSTDIGIT Table
SYSP	SYSTEM PARAMETER Table

*This also displays selected information from the ROUTE and LOCATION Tables, however, changes to those tables are not displayed directly.

- ID.** This filter identifies the record that was modified. If the values associated with a mailbox holder mailbox are changed, the entry for this field is the mailbox number.
- AT.** This filter displays the record that was modified.
- VA.** This filter displays the new value for a record that was modified.

7.6 SERVER ACTIVITY TRACE LOG

(Serenade 3.0)

The server activity trace (SAT) collects all the functional activity of the OctelAccess server on the message server into a log file. For each activity, the status of the activity and the mailbox or the message number acted on are collected. The SAT log can be used as a tool to review the OctelAccess server activity on the message server.

The SAT log options are as follows:

- LOG PR SAT** displays all activities in the SAT log or to set filters for specific records to be displayed.
- LOG ST SAT** shows the beginning date and time and the time of the first record presently in the log.

The following example shows a SAT log. A description of each of the fields follows.

```

@LOG PR SAT
Specify Print Option(s):
  "S"tart <time>, "E"nd <time>, "L"ine <length>, "P"age <length>, "\",
  "M"ask <mask (including date and time fields)>, "C"ontinuous
  Filters: CO MB AC D1 D2 ST
>

MM/DD/YY HH:MM:SS CONNID   MBX     ACTIVITY           DAT1     DAT2 STATUS
04/24/98 07:35:30
LINK UP

```

- MM/DD/YY.** Month, day, and year activity occurred.
- HH:MM:SS.** Hour, minute, and second transaction.
- CONNID.** The combination of the OctelAccess ID and the session ID that is uniquely mapped to one Octel 200/300 session ID. For example, a CONNID entry of 008/00001 shows the OctelAccess ID as 008 and the session ID as 00001.
- MBX.** The mailbox to which the session currently has access to.
- ACTIVITY.** Text strings describing the type of activity on the message server. Refer to Table 7-8 for descriptions of the activities logged.
- DATA1, DATA2.** Activity-specific data to be interpreted in the context of the action; for example, message number or DTMF strings. DATA1 contains the mailbox number or client controlled message (CCM) reference number or the digit-string input; DATA2 contains the message number.
- STATUS.** The status of the concluded action or the reason for failure. For example, SUCC is entered if the activity succeeded; BAD_MSGNO appears if a bad message number was received. Refer to Table 7-9 for the list of status types and descriptions.

Table 7-8 SAT Log Activity Types

Activity	DATA1	DATA2
ADD ONE PDL MEMBER	Member mailbox number	PDL number
APPEN MBX MSG	CCM reference number	Message number
CALL MBX	Mailbox/extn digits	Null
CHECK FOR PDL OPTION	Owner member mailbox number	Null
CLAIM NEW CALL	Channel task name	Session ID
CLEAR MSG WTG	Mailbox digits	Null
CLIENT ERR LOGGED	Client error number (decimal)	Null
COMPLETE TRANSFER	Mailbox digits to transfer to	Null
CONNECT TDM	Channel task name	Null
COPY CCM TO MBX	Source mailbox digits	Message numbers
COURTESY DOWN STARTED	Null	Null
DEL ALL PDL LISTS	Null	Null
DEL ONE PDL LIST	Null	PDL number
DEL ONE PDL MEMBER	Member mailbox number	PDL number
DELETE CCM MSG	CCM reference number	Message number
DELETE MBX MSG	Mailbox digits	Message number
DELETE MSG ERROR	Null	Null
DIGIT IN	DTMF digit	Null
DISCONNECT TDM	Channel disconnected	Null
DTMF IN	Channel task name	Digit input
DTMF OUT	DTMF string	DTMF string continued
ERR/OUT OF SYN	Internal session ID	Null
ERROR – CHN ABORT	Channel task name	Session ID
EXP FILE DOWNLOAD	Export file type	Null
FAX CHANNEL ALLOC	Allocated fax channel number	Null
FILE XFER CNCL	Null	Null
GATEWAY CONNECT	Null	Null
GATEWAY DISCONNECT	Null	Null
GET ALL PDL	Number of members returned	PDL number
GET FILE	CCM reference number	Message number

Table 7-8 SAT Log Activity Types

Activity	DATA1	DATA2
GET MBX INFO	Mailbox digits	Null
GET MISGINFOR BY MSG	CCM Reference Number	Message Number
GET MSG POSITION	Null	Null
GET MSGINFO BY IDX	Mailbox digits	Index
GET ONE PDL	Number of member returned	PDL number
GET TIME AND DATE	Null	Null
GODIAL	Mailbox digits	Null
GOT PBX ONHOOK	Channel name	Null
GREETING CMD	On/off/select	Message number
INITIATE TRANSFER	Mailbox digits to transfer to	Null
LINK DOWN	Null	Null
LINK UP	Null	Null
LOAD LANGUAGES	Null	Null
LOG ON	Mailbox digits	Null
MBX INFO ALERT	Null	Null
MESSAGE DOWNLOAD	CCM reference number	Message number
MESSAGE UPLOAD	CCM reference number	Message number
MSG WAITING CMD	Mailbox digits	On/off
NEW CALL	Channel task name	Session ID
PAUSE SPEAK	Null	Message number
PDL EDIT REQUEST	Null	Null
PORT ALLOC	Allocated port number	Null
PORT ONHOOK	Port number put on-hook	Null
PUT FILE	Null	Message number
REC LMT WARNING	Session states	Null
RECEIVE FAX	Null	Null
RECONNECT	Port number	Null
RECORD MBX MSG	Creator mailbox digits	Message number
RECORDING ERROR	Null	Null
RELEASE CHANNEL	Channel released	Null

Table 7-8 SAT Log Activity Types

Activity	DATA1	DATA2
REPLACE PDL MEMBER	New member mailbox number	PDL number
REQUEST REJECTED	CSP request number(decimal)	Null
RESUME SPEAK	Null	Message number
SAVE MBX MSG	Mailbox digits	Message number
SEND FAX	Null	Null
SEND MSG	Null	Message Number
SESSION CLOSE	Session ID	Null
SESSION OPEN	Session ID	Null
SET LANGUAGES	Prompt set	Null
SET MSG POSITION	Position	Null
SET VOLUME	Volume level	Null
SET/VALIDATE PASSWORD	Mailbox digits	Null
SET/VALIDATE PASSWORD	Mailbox digits	Null
SPEAK CCM MSG	CCM reference number	Null
SPEAK DATA TIME	System prompt number	Null
SPEAK MBX GRTG	Mailbox digits	Message number
SPEAK MBX MSG	Null	Message number
SPEAK MBX NAME	Mailbox digits	Null
SPEAK PDL NAME	Mailbox digits	PDL number
SPEAK PROMPTS	System prompt number	Null
STOP SPEAK RECORD	Null	Message number
TDM STATUS	Null	Null

Table 7-9 SAT Log SAT_Status Types

STATUS	DESCRIPTION
SUCCESS	Success
FAIL	Fail
BADMSGNO	Bad message number
DTMFIN	DTMF in
LANDOWN	LAN down
OTHER	—
CALLP_BSY	Target busy
CALLP_FBSY	Fast busy
CALLP_RNA	Ring-no-answer
CALLP_VACANT	Target
CALLP_CXPORT	Octel 200/300 message server calling itself
CALLP_NODT	Never received tone from message server
INV_DATA	Invalid data
INV_STATE	Invalid state
INTERR	Internal error
BADDTMFDIG	Bad DTMF digit
2MUCHDATA	Too much data in request
PRTAL_NOTAV	Port allocation: no ports available
INSUFF_DATA	Insufficient data
NORSRC	No resources available
INVSSID	Invalid SSID
ALRDY_ONHK	On-hook request, but port already on-hook
BAD_TO,E	Bad clock structure
SPKRESUMED	Speak resumed
BADMSGTYPE	Bad message type
BADMBXNO	Bad mailbox number
BADVOLLVL	Bad volume index
BAD_PRT_TYP	Bad port type requested
NOCOS	Does not have required COS
MBXBSY	Mailbox busy
BADCCMREF	Bad CCM reference number
NODT	No dial tone
INV_ACCESS	Invalid access
DSK_FAIL	Disk fail
MBX_BSY	Mailbox busy
DST-FULL	Destination mailbox full
SYS_PERF	System performance limit

Table 7-9 SAT Log SAT_Status Types

STATUS	DESCRIPTION
NO_GREET	Cannot turn on greeting
MSG_FAIL	Cannot save message
DSK_FULL	Disk full
SILENCE	Only silence/exceeds limit
ONLY_DTMF	Only DTMF
MSG_NOT_EXIST	No such message
APPOOL_FULL	AP mailbox pool full
NO_POOL_CF	No mailbox pool configured
NO_FAX_PRT	No FAX port
NONE_AVAIL	None available (for open session)
ALERT_PM	Information alert – new/purge message
LINE_DROP	PBX line drop
SUCC_DTMF	Record succeeds on DTMF in
SUCC_TIME_LMT	Record succeeds on Time limit
BAD_DST_ADDR	Invalid destination address
BAD_ADDR_OPT	Invalid addressing option
UDIR_FAIL	User directory fails
BAD_ORIG_MSGNO	Invalid original message number
CANNOT_FWD	Cannot forward a message
NO_DST_ADDR	No destination address
MSG_DEL	Message deleted already
GDL_NOMBX	No mailbox for go dial
INV_PSWDOP	Invalid password operation
INVPSWD	Invalid password
PSWCHGREQ	Password change required
PSWNEWREQ	New password required
SHORTPSWD	Short password
MAYNOTUSE	May not use this password
ALERT_LOGOFF	Information alert – user logoff
CLERR	Client error
NONE	Status field is blank
PRTAL_USAGE	Port allocation:usage requirement is not met
PRTAL_NOT_CNFG	Port allocation:no port configured
CH_NOTALLOC	Channel not allocated for TDM
TDM_ERROR	TDM error
DSC_TDM	TDM disconnected
INV_CHTYPE	Invalid channel type

Table 7-9 SAT Log SAT_Status Types

STATUS	DESCRIPTION
DST_FAIL	Destination mailbox fails
COS	Mailbox without OctelAccess COS
RECWARN	Record limit warning
ILLGL_MBX	Illegal mailbox – distribution list, network mailbox
GOT_PRT	Already allocated a port
NO_TDM	No TDM connection
CLOSE_SESS	Close session while busy
TDM_ACTIVE	TDM is still connected
CLOSESS_INPROG	Close session in progress
STOPSPK	Stopped speak operation
NO_GWAY	No active OctelAccess connection
TMO	Timed out
NOTNEWCALL	Not a new call
FATAL_CH_ERROR	Fatal channel error: invalid state
PAUSESPK	Pause speak operation
ABORTCH	Abort port
CRTSY_DN	Courtesy down
OPERATOR	Operator-initiated action
NETERR	Network error
GWDOWN	OctelAccess Server down
PROTERR	Protocol error
NO_MBX_COS	Mailbox without required COS
XFER_INPROG	File transfer already in progress
FILEXFER_SESS_BUSY	All file-transfer sessions busy
XFER_CNCL_NO_INPROG	No file transfer in progress to cancel
INV_ENCODING_RATE	Invalid encoding rate; not used
FILEXFER_CNCL	File transfer canceled
FILENAME_TOO_LONG	File name in request is too long
FILEXFER_INV_MBXNUM	Invalid mailbox number for desk tab upload
NOT_IN_MBX	Message to download not in mailbox
NDR_REBUILD	Names directory export file update in progress
INV_FILETYPE	Invalid export file type
NDR_NO_FEATURE	No names directory feature
INV_FAXUSAGE	Inv fax usage for port allocation
NO_PDL_OPT	Mailbox without PDL options
INV_PDLNUM	Invalid PDL number
INV_PDLMEMMBX	PDL member mailbox non-existing

Table 7-9 SAT Log SAT_Status Types

STATUS	DESCRIPTION
PDL_OWNER_SDL	PDL owner mailbox an SDL
INV_COS_ATTR	Invalid COS attribute
PDLMEM_EXIST	PDL member already in PDL
PDL_FULL	PDL already full
PDLMEM_NINPDL	PDL member not in PDL
NO_PDLS	PDL owner does not have any PDLS
PDLMEM_IS_SELF	PDL member is self
FTP_CONN_CLOSED	FTP connection is closed
FTP_FILEOPEN	FTP file open error
FTP_FILE_RW_ERR	FTP file read/write error
FTP_NETWORK_ERR	FTP network error

APPENDIX A

CALL-PROCESSING TRACE ACTIVITIES

The types of activities performed during call processing are shown in Table 7A-1, Trace Activity Types. Events and supplemental activities are shown in Table 7A-2, EVENT and AUX Activities in the Call-Process Trace Log.

Table 7A-1 Trace Activity Types

Type	Description
PORT	Port activity
FAX_CHN	Fax channel activity
FAX_MSG	Fax message activity
MBX	Mailbox activity
MSG	Message activity
NET_MSG	Network message activity
LAN_IN	Request received by this server from the LAN
LAN_OUT	Request sent from this server to the LAN
LAN_MSG	Message activity initiated by the LAN
LANLOST	CPU and LAN card lost communication
LANSYNC	CPU and LAN card synchronized communication
LAN_CTY	Courtesy operation (UP or DOWN specified in the EVENT column)
ONT_IN	OctelNet (Protocol 5) packet received by this server
ONT_OUT	OctelNet (Protocol 5) packet sent by this server
ONT_ERR	OctelNet (Protocol 5) protocol error occurred
NAM_DIR	Dial-by-Name Directory activity
INTG_C	Card-based integration record, including MIC, RIC, ATTIC, SL1, and M1 integrations
INTG_CA	Card-based ANI integration record
INTG_R	RS-232C integration record
INTG_D	DTMF integration record
LINK_AP	Application-control-processor link activity
AP	Application-control-processor mailbox activity (e.g., message waiting)
VSA	Octel Mailbox Manager™ activity
XFREXTFWD	Log the transfer to forwarded extension
DIRMSGACC	Log direct message access

Table 7A-1 Trace Activity Types

Type	Description
INTGQRY	Log the PBX query call record types
INTGREP	Log the PBX reply call record types
CHKMBXQRY	Log the PBX query to check the existence of a mailbox
CHKMBXYES	Log the reply "YES" to the check mailbox query
CHKMBXNO	Log the reply "NO" to the check mailbox query
LINK_REQ	Log the PBX query to check the link authorization
LINK_REP	Log the reply to the link supervision query
CSP_IN	Packet received from the OctelAccess server
CSP_OUT	Packet sent from the message server to the OctelAccess server

In Table 7A-2, note the following:

- ❑ An entry in the TYPE column indicates that the EVENT applies only to the TYPE given.
- ❑ An entry of OctelNet means that the EVENT can apply to all OctelNet TYPES: ONT_IN, ONT_OUT, ONT_ERR.
- ❑ An entry of LAN means that the the EVENT can apply to all LAN TYPES: LAN_IN, LAN_OUT, LAN_MSG, LANLOST, LANSYNC, and LAN_CTY.
- ❑ For OctelNet events, the following terminology is used:
 - ❑ A base is a message server that makes an outcall and/or sends a message (voice or fax).
 - ❑ A node is a message server that receives a message.

Table 7A-2 EVENT and AUX Activities in Call Process Trace Log

TYPE Column Entry	EVENT Column Entry	DESCRIPTION	AUX Column Entry	DESCRIPTION
ONT_IN, ONT_OUT	ABORT	Abort recording (DTMF digit *). Entry might be sent by the base server or the node while playing or recording a new message to indicate some problem or error.		
OctelNet	ADMASCRSP	ASCII name response packet (administrative packet). This packet contains the ASCII name of the mailbox in the just-preceding administrative request packet. ☞ The SOURCE column contains the first 10 characters of the ASCII name.	SUCCESS MBXTYPE MBXNTFND NOMATCH NOASCNM NOSPKNM NOACCESS NOFEAT CORRUPT ADDED SYNTAX MORE_9 NWERROR STOP FSFULL	Success Incorrect mailbox type Mailbox does not exist ASCII names do not match No ASCII name for mailbox No spoken name for mailbox Cannot access network directory Feature not supported Spoken name corrupted Name successfully added to Names Directory Syntax error in name More than nine identical names in Names Directory Error in updating Names Directory Stop further protocol exchange — abort System full
OctelNet	ADMBALRSP	The mailbox/alias response packet (administrative packet). This packet is the response containing alias information for the same mailbox as in the just-preceding administrative request packet. This packet is sent by the node and received by the base server.	SUCCESS MBXTYPE MBXNTFND NOMATCH NOASCNM NOSPKNM NOACCESS NOFEAT CORRUPT ADDED SYNTAX MORE_9 NWERROR STOP FSFULL	Success Incorrect mailbox type Mailbox does not exist ASCII names do not match No ASCII name for mailbox No spoken name for mailbox Cannot access network directory Feature not supported Spoken name corrupted Name successfully added to Names Directory Syntax error in name More than nine identical names in Names Directory Error in updating Names Directory Stop further protocol exchange — abort System full

Table 7A-2 EVENT and AUX Activities in Call Process Trace Log (continued)

TYPE Column Entry	EVENT Column Entry	DESCRIPTION	AUX Column Entry	DESCRIPTION
OctelNet	ADMGENREQ	Generic administrative request packet. This packet is sent by the base server (the server trying to retrieve spoken and ASCII names) and received by the node. The AUX column contains the type of request. ☞ The MBX/EXTN column contains the mailbox number for which the request is being made (00 for CHMODE AUX type).	GETALL GETNAME CHMODE TXALL	Get all names. Get name for mailbox Change to/from voice/admin mode. Transmit all names.
OctelNet	ADMGENRSP	Generic administrative response packet.	SUCCESS MBXTYPE MBXNTFND NOMATCH NOASCNM NOSPKNM NOACCESS NOFEAT CORRUPT ADDED SYNTAX MORE_9 NWERROR STOP FSFULL	Success Incorrect mailbox type Mailbox does not exist ASCII names do not match No ASCII name for mailbox No spoken name for mailbox Cannot access network directory Feature not supported Spoken name corrupted Name successfully added to Names Directory Syntax error in name More than nine identical names in Names Directory Error in updating Names Directory Stop further protocol exchange — abort System full
	ALLOC_TO	Fax allocation		
LAN	ANLOGSTBY	Indicates the change from LAN delivery to analog standby delivery (LAN, analog standby) ☞ The MSG# column contains the number of the first message in the queue to be sent to the location for which analog standby was initiated. ☞ The SOURCE column contains the name of the remote location.		
OctelNet	ASCIINAME	OctelNet ASCII name verification packet. This packet contains the ASCII name of the destination mailbox in the just-preceding message header request packet sent by the base server (or received by the node) as it appears in the Names Directory of the base. ☞ The SOURCE column contains the first 10 characters of the ASCII name.		
	AUTO_LOGON			
	CALL_MBX			
LAN	CLOSEDONE	Connection has been closed.		
	CONNECT_TO	Fax channel connect to voice port.		

Table 7A-2 EVENT and AUX Activities in Call Process Trace Log (continued)

TYPE Column Entry	EVENT Column Entry	DESCRIPTION	AUX Column Entry	DESCRIPTION
LAN	CONNGRANT	Connection has been granted.		
	COS_OVRID	COS override occurred.		
	COURTESY	Generic for courtesy up/down.	UP/DOWN	
LAN	CREATE	Created msg to receive new message delivery.		
	DEBUG	Integration debug records .		
	DEFERRED	Message deferred for mailbox.		
LAN, OctelNet	DESTMBX	Destination mailbox for the message . ✉ The SOURCE field contains the ASCII name for each destination address sent.	NAMEFAIL	Failure status when ASCII name match fails.
	DIGIT_IN	Digit received by system.		
	DIGIT_OUT	Digit received by system.		
	DIR_INT	Direct internal call.		
	DIR_EXT	Direct external call.		
	DISC_FROM	Fax channel disconnect from voice port.		
ONT_IN, ONT_OUT	END_MSG	End of message (DTMF digit #). Sent by the base to the node at the end of new message play.		
FAX_MSG	END_PLAY	The playing of the message has ended.		The CPT shows result codes for fax transactions in the AUX column. For fax messages, the AUX column is empty if the fax was successful. The most common result codes listed are for the END PLAY event.
			01	Fax protocol error
			02	Default error code
			03	Modem training failure
			04	Remote fax requested a feature not supported by the Octel Overture 200/300
			05	Not used
			06	Voice bus timeout
			07	Fax protocol error
			08	VCU not ready
			09	Bad-page-retransmit limit reached
			0A	Modem connection failure; no response from on-board modem
			0B	Modem connection failure
			0C	Other side disconnected
			0D	Operator assistance not supported in fax
				Fax system ID match
			0E	No fax or busy line
			0F	

Table 7A-2 EVENT and AUX Activities in Call Process Trace Log (continued)

TYPE Column Entry	EVENT Column Entry	DESCRIPTION	AUX Column Entry	DESCRIPTION
FAX_MSG	END_PLAY (continued)		10 11 12 13 14 15 16 17 18 19	Transmitter failed in HDLC test. Used in fax loopback test. Hardware error 63 is logged Receiver failed in HDLC test. Used in fax loopback test. Hardware error 63 logged Both transmitter and receiver failed in HDLC test. Used in fax loopback test. Hardware error 63 logged Timeout occurred in HDLC test. Used in fax loopback test. Hardware error 63 logged No identification frame record from remote fax Remote fax did not respond to command Unable to configure remote fax Remote fax did not confirm Octel Overture 200/300's transmission fax parameters Hardware training failed. No carrier No response from RX for multipage signal
			1A 1B 1C 1D 1E 1F 20	Unexpected frame from remote fax No response from remote fax to end of procedure frame No response from remote fax to end of message frame No response from remote fax to identification frame Failure in receiving command frame from remote fax Remote fax failed in retransmitting bad page and disconnected Remote fax disconnected because of resolution mismatch
	END_REC RD	Stop recording message.		The CPT shows result codes for fax transactions in the AUX column. For fax messages, the AUX column is empty if the fax was successful. The most common result codes listed are for the END_PLAY event.
	EX_AB_GRT	Extended absence greeting.	ON OFF	
FAX_CHAN	FAX_CONCT	Fax connect information.		
FAX_CHAN	FAX_INFO	Fax message information.		
FAX_CHAN	FAX_DELIV	Fax delivery.	START SUCCESS FAIL RETRY	Fax delivery failed, but will retry.
LAN	FAXDLV	Indicates the delivery and receipt of a fax message at the receive and send sides.  The SOURCE column contains the creator mailbox.	HAS_EXTN NO_EXTN	This is the last message of a chain.

Table 7A-2 EVENT and AUX Activities in Call Process Trace Log (continued)

TYPE Column Entry	EVENT Column Entry	DESCRIPTION	AUX Column Entry	DESCRIPTION
LAN	FORCE_FWD	Forced forward.		
	FWD_INT	Forward internal call.	NO_ANSWER BUSY ALL FORCED	Ring-no-answer forward Busy forward All forward Forced forward
	FWD_EXT	Forward external call.	NO_ANSWER BUSY ALL FORCED	Ring-no-answer forward Busy forward All forward Forced forward
	FREED	Message freed.	TOO_SHRT ERAS_REQ LISN_END HIT_** OLD_GRET OLD_NAME NO_ADDR USE_CNT0	Message too short Erase requested Listened to end Entered ** Old greeting Old name No addresses Use count 0
			HUNG_UP BAD_ADDR REC_ERR BAD_ADDR REC_ERR BAD_ADDR REC_ERR NO_TALK	
			DTMF_REC EXTN_HDR NTNM_DEL NTNM_PRG NTNM_CLI FAX_FAIL FAX_ADEL FAX_ABRT MBX_MSG	DTMF received while recording Extension header Netname deleted Netname deleted by auto-purge Netname deleted by CLI Fax failed Fax auto deletion Fax abort Mailbox message (VMX 5000 UI)
	FREE_FROM	Fax freed from (Reverse of ALLOC_TO).		
	FUTR_MAKE	Future delivery message made.		
	FUTR_SENT	Future delivery message sent.		
LAN	HNSHK_RQ	Handshake request.		
LAN	HNSHK_RP	Handshake reply.	SUCCESS	
	HAS_MSGS	Message count when logged on.		Message count displayed
	HUNGUP			
	INV_SECUR	Invalid password entered.		
	INV_USER	Invalid UID.		
	LINE_DROP	System received drop signal.		
	LOCK_UP	Possible port lockup (SL1 integration).		
LAN	LOCN_UP	Link to this location is up.		

Table 7A-2 EVENT and AUX Activities in Call Process Trace Log (continued)

TYPE Column Entry	EVENT Column Entry	DESCRIPTION	AUX Column Entry	DESCRIPTION
LAN	LOCN_DOWN	Link to this location is down.		
	LOGON	Successful user logon to mailbox.		
	LOG_MSGS	Number of messages delivered while logged on.		
	LOGOFF	Successful user logoff.		
ONT_IN, ONT_OUT	LSYN_REQ	Line synchronization request packet sent by the base server to the node. ☞ The protocol level proposed by the base, which is also in the packet, is printed in the SOURCE column.		
ONT_IN, ONT_OUT	LSYN_RSP	Line synchronization response packet sent by the node to the base. ☞ The final protocol level determined by the node (the lower level of that proposed by the base and that of the node), which is also in the packet, is printed in the SOURCE column.		
	MARKED	Message marked playable/unplayable.	PLAYABLE UNPLAYBL	Message marked playable. Message marked unplayable.
	MARK_DEL	Name is marked for deletion.		
ONT_IN, ONT_OUT	MHDR_REQ	Message header request packet sent by the base server to the node. This packet contains a message header type, which is printed in the AUX column. ☞ The message header request can contain a destination mailbox. If it does (depending on the message header type), it is printed in the MBX/EXTN column. ☞ The message header request may contain a source mailbox. If it does (depending on the message header type), it is printed in the SOURCE column. ☞ The message number being sent by the base is shown in the MSG# column. for the base server only.	ENDSES NEWVCE CPYVCE POSCONF NEGCONF REMNOT TRNARN ADMNMSG NEWNAME CPYNAME CMPFAX ONLFX CPYFAX CMPFXNM CPYFXNM ONLYFXNM	End of session New voice message Copy previous voice message Positive confirmation Negative confirmation Remote message waiting notification Turnaround requested Administrative message New voice message with name confirmation Copy previous message with name confirmation Compound fax message Fax-only message Copy previous fax message Fax compound with name confirmation Copy previous fax with name confirmation Fax-only with name confirmation

Table 7A-2 EVENT and AUX Activities in Call Process Trace Log (continued)

TYPE Column Entry	EVENT Column Entry	DESCRIPTION	AUX Column Entry	DESCRIPTION
ONT_IN, ONT_OUT	MHDR_RSP	<p>Message header response packet sent by the node to the base server. The message header response packet contains the response to the message header request.</p> <p>☞ The message number of the message just recorded/copied is shown in the MSG# column for the node only.</p> <p>☞ The location name of the base server location (concluded by the node, based on the source mailbox number) is shown in the SOURCE column for the node only.</p>	SUCCESS MBXNTFND MBXTYPE MBXFULL FUTFULL FSFULL NODELETE NODISABL BADMSG NODEBUSY NOANSWER BADLINE RE-SYNC NOMATCH USRBLCKD ABSGREET RCVMBXFX RCVPRTFX RCVSYSFX SNDRPTFX	Success Destination mailbox not found or deleted before the message could be delivered Nondeliverable mailbox type Destination mailbox full Mailbox future delivery full File system full Node deleted Node disabled — return messages Bad message Node busy No answer Bad line Re-sync request (used after abort) ASCII name does not match Network message blocked by user User had absent greeting RCV not a fax-capable mailbox RCV not a fax-capable port RCV not a fax-capable system TX not a fax-capable port
	MSGWAIT	Request to turn message waiting on or off.	SET CLEAR	Turn on message waiting Turn off message waiting
LAN	MSGDLV	Delivering one message of the chain.	HAS_EXTN NO_EXTN	This is the last message of a chain.
	MW_RESULT	Result of attempt to set message waiting.	OFF OFF_BAD ON ON_BAD NOTCFG UNABLE	Off:success Off:failure On:success ON:failure Not configured in PBX Unable to make
ONT_IN, ONT_OUT	MSG_RSP	Message response packet sent by the node to the base server. The message response packet is sent by the node to the base server after recording the new message. It contains the node's response to the message delivery requested by the base server. The response types are the same as those for the message header response and are traced in exactly the same manner.		
	NET_NAME	Netname activity.		
	NEW_MSGS	New message count when logged on.		Message count displayed
	OFFHOOK			
	ONHOOK			
LAN	OPENCONN	Open a connection.		
	PBX_RSTRT	PBX restart integration pcket received.		
	PLAY	Play message.		Type of message entered in AUX
	PURGE	Name was successfully purged.		

Table 7A-2 EVENT and AUX Activities in Call Process Trace Log (continued)

TYPE Column Entry	EVENT Column Entry	DESCRIPTION	AUX Column Entry	DESCRIPTION
	PUT_IN	Message was put in mailbox or location.		Type of message entered in AUX
	RBLD_END	Event logged at the end of the rebuild process for the Names Directory.		
	RBLD_STRT	Event logged at the beginning of the rebuild process for the Names Directory.		
	RBLD_P1	Logged an inconsistency during pass 1 of the rebuild for the Names Directory. ☞ The first 8 digits of the mailbox number are printed in the MBX/EXTN column.	BADUSRNM BADNETNM USRINCON NETINCON	
	RBLD_P2	Logged an inconsistency during pass 2 of the rebuild for the Names Directory. ☞ The first 8 digits of the mailbox number are printed in the MBX/EXTN column.	BADNAMNM USRINCON	
	RBLD_P	Logged an inconsistency during pass 3 of the rebuild for the Names Directory. ☞ The first 8 digits of the mailbox number are printed in the MBX/EXTN column.	BADNAMNM USRINCON	
ONT_ERR	RCV_FAIL	Logged an OctelNet packet receive failure. An attempt to receive/decode an OctelNet packet failed. The reason for the failure is indicated in the AUX column for decryption failure, unscrambling failure, checksum failure, timeout, or the remote side hanging up. For other errors, the AUX column is blank.	DECRPT UNSCRM CHKSUM TIMOUT HANGUP	Decryption failure Unscrambling failure Checksum failure Timeout Remote side hanging up
	RECORD	Start record message.		Type of message is entered in AUX column
	REMOVED	Message removed from mailbox or location.		
LAN	RCV	Received message.	SUCCESS	
	RECEIVED	Network message received.		
	RECRD_CALL	Record call in progress.		
ONT_IN , ONT_OUT	SAVE_GO	Save go (DTMF digit 9). Sent by the base server to the node after receiving the save request from the node.		
ONT_IN , ONT_OUT	SAVE_RQ	Save request (DTMF digit 8). Request by the node to the base server after receiving an end of message from the base.		
LAN	SEND	Final message status result of STRTSND.	SUCCESS CALLFAIL	Network connection was not successful or was closed. Will retry to make connection.
	SENT	Message sent.		

Table 7A-2 EVENT and AUX Activities in Call Process Trace Log (continued)

TYPE Column Entry	EVENT Column Entry	DESCRIPTION	AUX Column Entry	DESCRIPTION
ONT_IN, ONT_OUT	SER_NUM	Serial number packet sent by the node to the base server. The serial number (in hex) is traced in the SOURCE column.		
ONT_IN, ONT_OUT	SHDR_REQ	Session header request packet sent by the base server to the node. The serial number of the base is in the SOURCE column.		
ONT_IN, ONT_OUT	SHDR_RSP	Session header response packet sent by the node to the base server. The serial number of the node is in the SOURCE column.	ACCEPT REJECT	The node is accepting the proposed connection. The node is rejecting the proposed connection.
ONT_ERR	SND_FAIL	OctelNet packet send failure. An attempt to prepare or send an OctelNet packet failed. The reason for the failure is indicated in the AUX column for encryption failure, scrambling failure, checksum failure, or the remote side hanging up. For other errors, the AUX column is blank.	ENCRPT SCRMBL CHKSUM HANGUP	Encryption failure Scrambling failure Checksum failure Remote side hanging up
LAN	SNMP_QRY	SNMP information has been requested.	001 002	Digital performance report Network traffic report
	SNMP_SND	SNMP information has been sent.		
	STATUS		NO_ANSWR FAST_BSY BUSY EVENT RINGING UNAVAIL TALKOFF CAMPON FAILED CXPORT	
	STATUS		SUCCESS COMPLETE VCUREADY VCUCONN	Completed function VCU ready to connect VCU connected
LAN	STATUS (continued)		FAIL DISKFULL NOTFND NONETNAM UNEXPREQ	Generic failure Mailbox not found Network name cannot be updated Unexpected request
			MBXFULL NORECORD NTNAMFUL FWDDEPTH	Mailbox full Mailbox set to no record COS NetNam Table full Max message forwarding depth exceeded
			ALL_BSY OEM_FAIL REV_FAIL COURUPDN	All LCH are busy Failed because of OEM mismatch Protocol level not supported Courtesy up/down in progress

Table 7A-2 EVENT and AUX Activities in Call Process Trace Log (continued)

TYPE Column Entry	EVENT Column Entry	DESCRIPTION	AUX Column Entry	DESCRIPTION
			TSTERADR TSTERCON TSTERDOM TSTERRDG TSTERSDG TSTERFDG TSTERCOL TSTSWRCV CPUCHKER NOFAXFTR NOFAXCOS TNDMLIM	IP address did not match Connection types do not match In-domain status does not match Receiver self digits do not match Sender self digits do not match First digit mismatch with senders Collocated status mismatch SW error on receive side of testlan Bad CPU data checksum Receiver does not have FAX feature Receiver mbx does not have FAX COS Msg tandem limit reached
			RLANFAIL LLANFAIL	Remote LAN failure Local LAN failure
	STRTSND	Starting send for a new message chain.		No. of msgs in message chain is shown
	TEST	Background port self-test.		
	TIMESTAMP	Debug feature for user to force timestamp in trace.		
	TRANSFER		FLASH EXP_DT GOT_DT NO_DT DELAY	Expect dial tone Got dial tone No dial tone
INTG_C	USE_PORT	ATTIC integration.		
	UNKNOWN	Call record in unknown format.		
	VCUCONN	Connect VCU for message transfer.		
ONT_IN, ONT_OUT	WKUP_REQ	Wakeup request sent by the base server to the node. The location name being called is printed in the SOURCE column for the base only.	NEEDSER KNOWSER	Wakeup request tone of DTMF CD Wakeup request tone of DTMF BD
ONT_IN, ONT_OUT	WKUP_RSP	Wakeup response sent by the node to the base server.	NEEDSER KNOWSER	Wakeup request tone of DTMF BDD Wakeup request tone of DTMF CDD
	END_FLUSH INCOMPLET INV_1ST NO RECORD INV_RECRD	These five events are for the DTMF Integration.		
AP	POLL SEND RECEIVE SYNC LOST_SYNC	These five events are for Works for Serenade..		
VSA	VSAIN VSAOUT VSAUP VSADOWN	These events show activity for Octel Mailbox Manager.		

Table 7A-2 EVENT and AUX Activities in Call Process Trace Log (continued)

TYPE Column Entry	EVENT Column Entry	DESCRIPTION	AUX Column Entry	DESCRIPTION
CSP_IN	EST_CONN	Establish a connection		
CSP_OUT	REQ_PORT	Requewst a Serenade port		
	HANGUP	Hangup a Serenade port		
	INIT_XFR	Initiate a transfer		
	COMPLE_XFR	Complete the transfer		
	RECONNECT	Reconnect to caller		
	CALL_MBX	Call a mailbox/extension		
	SPK_PRMPRT	Speak system prompts		
	SPK_GRTG	Speak greeting		
	SPK_NAME	Speak name for a specified mailbox		
	SPK_MSG	Speak message number		
	DTMF_OUT	Outpulse a DTMF string		
	STOP_OPER	Stop a speak/record operation		
	PAUSE_MSG	Pause speaking message		
	CONT_MSG	continue speaking message		
	SETMSGPOS	Set message position		
	COPY_MSG	Copy a ACM message to a mailbox		
	ERASE_MSG	Erase message number		
	RECRD_MSG	Record a message		
	GT_MBXINF	Get mailbox information		
	GT_MSGIDX	Get mailbox header information from message index		
	GT_MSGNUM	Get mailbox header information from message number		
	GODIAL	Give control of port to Serenade		
	MOD_MSGWT	Set/clear application message waiting notification		
	MSG_XOUT	Request a fax/voice message to be transferred to gateway		
	CKSET_PWD	Validate/set a mailbox password		
	ERR_SYNAC	Error/out of sync on this session		
	SET_VOL	Set volume level		
	SAVE_MSG	Save message in mailbox		
	GETMSGPOS	get position of a message		
	SET_GRTG	Set mailbox greeting on/off		
	SEND_MSG	Address/deliver a recorded message		
	CLROFFMWT	Turn off offsite message waiting for this mailbox		
	GT_OMMPKT	Get OMM packet		
	RLS_FXPRT	Release a fax port		
	CONN_TDM	Connect the TDM bus for two ports		

Table 7A-2 EVENT and AUX Activities in Call Process Trace Log (continued)

TYPE Column Entry	EVENT Column Entry	DESCRIPTION	AUX Column Entry	DESCRIPTION
CSP_IN	BREAK_TDM	Break the TDM connection		
CSP_OUT	FAX_RCV	Received a fax message		
	FAX_SEND	Send a fax message		
	FAX_LOAD	Load a fax form into fax card memory		
	FAX_MAKE	Save fax card memory into fax document		
	FAX_EDIT	Place characters on a fax form		
	CH-FORTDM	Mark a channel available for TDM connection		
	CH_NOTTDM	Indicate channel no longer used for TDM connection		
	LOG_OFF	Client logged off by gateway		
	FAX_CNCL	Cancel fax transfer		
	MSG_XIN	Request to transfer a fax/voice message to Serenade		
	LANG_LOAD	Request languages loaded on message server		
	LANG_SET	Change language		
	EST_CONN	Established connection		
	ONHOOK	Serenade port on hook		
	RP_PORTRQ	Reply to port request		
	CMD_ACK	Command received, being processed		
	RP_MSGCMD	Reply to message command		

8

SYSTEM ERRORS AND TRAFFIC PEGS

Chapter Contents

8.1	Boot ROM Diagnostics	8-1
8.2	Hardware Errors	8-4
	Alarm Relays	8-5
	Hardware Error Types	8-5
8.3	Traffic Peg Count Table	8-37
	Traffic Pegs	8-38

Figure

8-1	Traffic Peg Count Table	8-58
-----	-------------------------------	------

Tables

8-1	Boot ROM Diagnostic Errors	8-2
8-2	Hardware Error Types and Remedies	8-6

Quick Reference Guide

System Errors and Traffic Pegs

	Command	Information
Traffic Pegs		
	L P	Lists the traffic pegs
	C P	Clears the Traffic Pegs Count Table
Hardware Errors		
	BITTST x	Converts hardware error data fields into bit sets. x = hexadecimal number
	L H	Lists the Hardware Error Table.
	C H	Clears the Hardware Error Table.

8.1 BOOT ROM DIAGNOSTICS

When the Octel Overture™ 200/300 message server is loaded or reloaded (loss of power, system error, or a command), the CPU and the VCU execute a boot ROM diagnostic. The following describes how to access and interpret the boot ROM errors.

Turn ON the terminal and set the speed to 300, 1200, or 9600 baud. At any of these speeds, the Octel Overture 200/300 prints or displays the diagnostic status. Turn ON the power to the cabinet. Press **Enter** repeatedly to establish the baud rate. The complete diagnostic message shown below is printed. The word FAILED is displayed if one of the tests fail.

```

CPU                               Model 300-6039-001           Rev 02F
486                               Step 27                   12MB

Testing Processor...PASSED
Testing System Voltage/Temp...PASSED
Testing ROM Checksum...PASSED
Testing PIT...PASSED
Testing DMA...PASSED
Testing UART...PASSED
Testing Modem...PASSED
Testing TDM Crosspoint...PASSED
Testing Floppy...PASSED
Testing RTC...PASSED
Testing BIC...PASSED
Testing OCC...PASSED
Testing WDT...PASSED
Testing Control Bus Interface...PASSED

Testing COMPLETED
Booting from SCSI file XBOOT.IM
Image loaded
Loading Image from Hard Disk
Loading file VMS1_2.IM
Loading file VMS2_2.IM
Image loaded

----- SYSTEM SOFTWARE RELEASE SX.X.X-2 (MM/DD/YY) -----
Copyright 19XX  Octel Communications Corp. All Rights Reserved.
THU 04/07 09:51:31 1997  E1-ISDN  ID: S/N:000000  PBX:00
(Modem enabled)  Last Logon : 00/00 00:00
@WAITING FOR VCU READY
LOADING VCU WITH FILE H:VCU.IM
VCU STARTED
RUNNING DISK REBUILD... REBUILD DONE
INITIALIZING PORTS...
PORT INITIALIZATION DONE

PASSWORD:
@

```

If errors are encountered, an error message is printed. If a problem is found, the terminal displays a specific error number. Table 8-1 contains a list of possible error numbers, a description of each error, and the most likely cause. When a failed assembly is returned for repair, the specific error number provides additional information. When contacting your technical support center, indicate the boot ROM diagnostic error number.

The boot ROM diagnostic errors and their most likely causes are listed on the following pages. The CPU error number is displayed in hexadecimal form. A fatal error means that the message server does not come up.

Table 8-1 Boot ROM Diagnostic Errors

CPU Error No.		Description	Most Likely Cause
001	Fatal	Microprocessor instruction set error	CPU
002	Fatal	EPROM checksum error	CPU
003	Fatal	Memory context register error	CPU
004	Fatal	Map RAM pattern test error	CPU
005	Fatal	Map RAM addressing test error	CPU
006	Fatal	DRAM pattern test error	CPU
00A	Fatal	DRAM addressing test error	CPU
00E		Erroneous parity error during DRAM tests	CPU
00F		Erroneous write protect error during DRAM tests	CPU
010		Parity error not detected	CPU
011		Write protect not detected	CPU
012		Data corrupted during write protect test	CPU
013		Z180 CSIO test error	CPU
015		Analog to digital converter test error	CPU
016		+5V VCC out of range (+4.75 to +5.25V)	PSU
017		+5V clear out of range (+4.50V to +5.50V)	PSU
018		+12V clear out of range (+10.8V to +13.2V)	PSU
019		+12V motor out of range (+11.4V to +12.6V)	PSU
01A		Battery out of range (+3.57V to +5.25V)	CPU
01B		Temp out of range (<10 C or >50 C / <50F or >122F)	SYSTEM
01C		Z180 PRT test error	CPU
01D	Fatal	Unexpected NMI error	CPU
01E	Fatal	Unexpected interrupt error	CPU
01F		Z180 DMAC test error	CPU
022		Z180 ASCI test error	CPU
023		Modem loopback test error	CPU
024		TOD RAM pattern or addressing test error	CPU
025		TOD alarm interrupt error	CPU
026		TOD not counting	CPU
027		Floppy disk controller test error	CPU
02B		OCC write error	OCC

Table 8-1 Boot ROM Diagnostic Errors (continued)

CPU Error No.	Description	Most Likely Cause
02C	OCC read error	OCC
02D	OCC checksum error	OCC
032	8254 timer error	CPU
033	Watchdog timer error	CPU
034	Coprocessor DMA CH 2 →CH 3 error	CPU
035	Coprocessor DMA CH3→CH 2 error	CPU
036	-5V clear out of range (-4.5V to -5.5V)	PSU
037	-12V out of range (-10.8 to -13.2V)	PSU
039	Dual port RAM pattern test error	CPU
03A	Dual port RAM addressing test error	CPU
03B	TDM crosspoint pattern test error	CPU
03C	TDM crosspoint addressing test error	CPU
03D	Coprocessor dual port RAM pattern test error	CPU
03E	Coprocessor dual port RAM addressing test error	CPU
03F	Coprocessor SRAM pattern test error	CPU
040	Coprocessor SRAM addressing test error	CPU
041	Coprocessor unexpected interrupt	CPU
042	Coprocessor unexpected NMI	CPU
043	Coprocessor boot failure	CPU
044	Coprocessor boot failure	CPU
045	Control BUS interrupt test error	CPU
046	Control BUS register test error	CPU
047	Coprocessor SIO loopback	CPU
048	Coprocessor SIO loopback CH 2→ CH 3 error	CPU
049	Coprocessor SIO loopback CH 3→ CH2 error	CPU
053	VCU on SCSI error detected	HD

8.2 HARDWARE ERRORS

The Octel Overture 200/300 logs each hardware error, along with its date, time, and type, in the Hardware Error Table. This section explains how to read and interpret the information in the Hardware Error Table. It also suggests some probable causes and remedies.

- ❑ The command `LIST HARDWARE` is used to list the Hardware Error Table. From the `@` prompt, enter

```
L H 
```

- ❑ The command `CLEAR HARDWARE` is used to clear the Hardware Error Table. From the `@` prompt, enter

```
C H 
```

- ❑ For some hardware errors it may be necessary to translate the error bits into the error code. To display which bits are set in a HEXadecimal number (max 16 bits), from the `@` prompt, enter

```
BITTST x
```

where x is a hexadecimal number.

An example to see which bits are set in the hex number 1234:

```
@BITTST 1234
```

```
BIT 2 IS SET
BIT 4 IS SET
BIT 5 IS SET
BIT 9 IS SET
BIT 12 IS SET
@
```

Hardware Error Table example and field description:

```
@L H
```

```
THU 01/30 22:29:56 1997 E1_ISDN ID:200444 S/N:200003 PBX:32
CLEARED: 08/26 11:02
```

TYPE	SLOT	CHNL	PRIO	DATE	TIME	#BAD	DATA1	DATA2	DATA3	DATA4
01	09	00	1	01/21	04:24	1	00000001	00000000	00000034	00000007
01	09	00	1	01/21	04:25	1	00000001	00000001	00000034	00000007
01	09	00	1	01/21	04:25	1	00000001	00000002	00000034	00000007

```
@
```

- ❑ **TYPE.** Range 1–nn. Indicates which hardware assembly detected an error or failed to perform a function. See Table 8-2.
- ❑ **SLOT.** Where applicable, shows slot number in which the PCA was installed when the error was reported.
- ❑ **CHNL.** Indicates the number of the failed channel.

 For Error #24 only,
 CHNL 1 refers to unit 1
 CHNL 2 refers to unit 2

- **PRI0.** Indicates the priority level of the hardware error being reported. Each type of hardware error has been assigned an error priority level. Priority levels range from 0 to 3, with 0 being the lowest level and 3 the highest. Higher priority hardware errors overwrite lower priority errors if the Hardware Error Table is full. Always correct the highest priority errors first.

**Priority Number of failures required
to generate an alarm call**

3	1
2	25
1	50

Priority 0 reports a test of the alarm (TE A).

- **DATE.** Shows the month and day the error was first detected.
- **TIME.** Shows the hour and minute the error was first detected, using a 24-hour clock.
- **#BAD.** Indicates the number of times the error occurred (up to 99 times).
- **DATA1 – DATA4.** These fields contain information used by Octel when an assembly is returned for repair.

This information is displayed as eight digits. The first six are zeroes.

- ☞ It is important to enter this information on a failure report when returning an assembly to Octel.

Alarm Relays

The Octel Overture 200/300 provides both major and minor alarm relays, which can be used to light an LED or sound an alarm. Refer to the Maintenance Commands chapter, Alarm Test section.

In the event of a power failure, both of these relays close the contacts to indicate the power failure. Both relays remain closed during a subsequent restoration of power until the software boot process opens the relays. However, if there is an alarm condition prior to the power failure or an alarm condition arises during the boot process, the relay(s) remain closed until the `CLEAR HARDWARE` command is given.

During operation, if any hardware error occurs, the minor alarm relay is closed. In turn, the major alarm relay closes when an alarm call is attempted, subject to the priority of the hardware errors.

Hardware Error Types

The following table outlines the probable cause and suggested remedy for errors. Clear errors with the highest priority first. Priority 3 is the highest, 1 is the lowest.

DATA-1 – DATA-4 information in the Hardware Error Table is displayed as eight digits. Only the last two digits are displayed in the following Hardware Error Table.

Table 8-2 Hardware Error Types and Remedies

Error Type:Name	Source	Remedy	Priority
1: Floppy Disk	TEST FLOP 1 or while trying to read	Clear Hardware Error Table and run TEST F 1. If errors repeat, replace the following components one at a time. Run TEST F 1 each time. Check cables, diskette, CPU, MFD. DATA-1 = ERROR CODES 01 = READ 02 = WRITE	1
2: Tone Reflection	Selftest or TEST LINE 1, TEST L 5	Clear Hardware Error Table. Run TEST L 1. If one channel fails, disconnect line card and run TEST L 1 again or TEST L 5. If errors repeat, replace the LIC. If all lines fail, check the configuration or VCU as possible cause.	2
3: Prompt	Selftest or TEST LINE 1	Same as error 2.	2
4: DTMF Reflection	Selftest or TEST LINE 1	Same as error 2.	2
5: Ring Through	TEST LINE 2 PORT	Verify that extension numbers in the table are correct. Could be a problem in PBX extensions or LIC.	2
6: Floppy Disk Controller	During read or write to floppy	Clear Hardware Error Table, run TEST FLOP 1. Check cables. If errors repeat, replace CPU.	1
8: VCU On-line	On-line diagnostic tests	Replace VCU. Reboot the message server. If error repeats, replace CPU. If problem continues, contact your technical support center.	3
10: Disk getting full	Disk message capacity is all used up or getting there.	For DATA-1=03 and DATA-2=00-06, and 11 errors, erase messages or increase hard disk capacity. For DATA-2=10 errors, call your technical support center.	3
	DATA-1 = 01 = ALARM THRESHOLD CONFIGURED IN SYSTEM PARAMETER 108 REACHED 03 = DISK FULL OR CANNOT MAKE MESSAGE REDUNDANT		

Table 8-2 Hardware Error Types and Remedies (continued)

Error Type:Name	Source	Remedy	Priority
DATA-2 = 00 = NO VOICE FILE SLOTS LEFT 01-06 = LOGICAL DRIVE ID THAT IS FULL 0a = PROMPT AREA FULL 0b = NO DISK WITH SUFFICIENT SPACE AVAILABLE 0c = SYSTEM RECORDING LIMIT EXCEEDED (ZERO HOUR DRIVES) DATA-3 = NOT USED DATA-4 = NOT USED			
11: Disk Initialization Failure	VCU could not successfully initialize the disk(s).	Contact your technical support center.	3
DATA-1 = REASON: 01 = NO SYSTEM DISK FOUND 02 = NO VALID FILE SYSTEM FOUND DATA-2 = NOT USED DATA-3 = NOT USED DATA-4 = NOT USED			
12: CPU Parity	Parity error occurred in CPU memory area.	If error repeats, replace power supply unit.	3
DATA-1 FROM I/O ADDRESS 6A (ERR.ADDR2) BIT 0, 1, 2 = CONTEXT REG IN USE ON ERROR DATA-2 FROM I/O ADDRESS 69 (ERR.ADDR1) HIGH ADDRESS ON PARITY ERROR DATA-3 FROM I/O ADDRESS 68 (ERR.ADDR0) LOW ADDRESS ON PARITY ERROR DATA-4 CONTENTS OF CONTEXT REG DESIGNATED BY DATA-1			
14: VCU initial checksum error	VCU code checksum incorrect	Contact your technical support center.	3
15: System Status Error	Temperature or voltage out of range	Check DATA-1 for information pertaining to what is out of range and perform corrective action.*	3
	* To correct cabinet temperature, check the filter, fan, room temperature, etc. Be sure there are at least six inches between cabinet and the wall. If Type 15 errors (with DATA-1=01) still appear, replace the CPU card. For Type 15 errors (with DATA-1=02, 03, 04, 05, 06, 0A, or 0B), voltage cannot be adjusted; recommended action is to replace the power supply unit.		

Table 8-2 Hardware Error Types and Remedies (continued)

Error Type:Name	Source	Remedy	Priority
DATA-1 = FAILURE CODE:			
01 =	INSIDE CABINET TEMPERATURE MEASUREMENT IS OUT OF RANGE.	10 TO 50 C (50 F TO 122 F)	
DATA-2 = REASON:			
	01 = TEMPERATURE TOO HIGH		
	02 = TEMPERATURE TOO LOW		
02 =	+5 DIGITAL VOLTAGE MEASUREMENT IS OUT OF RANGE	+4.75 TO +5.25	
DATA-2 = REASON:			
	00 = VOLTAGE OUT OF RANGE (DIRECTION UNKNOWN)		
	01 = VOLTAGE TOO HIGH		
	02 = VOLTAGE TOO LOW		
03 =	+12 ANALOG VOLTAGE MEASUREMENT IS OUT OF RANGE	+10.80 TO +13.20	
DATA-2 = SAME AS FOR 02			
04 =	-12 ANALOG VOLTAGE MEASUREMENT IS OUT OF RANGE	-13.20 TO -10.80	
DATA-2 = SAME AS FOR 02			
05 =	+12 MOTOR VOLTAGE MEASUREMENT IS OUT OF RANGE	+11.40 TO +12.60	
DATA-2 = SAME AS FOR 02			
06 =	+5 BATTERY VOLTAGE MEASUREMENT IS OUT OF RANGE	+3.60 TO MINIMUM	
DATA-2 = SAME AS FOR 02			
0A =	-5 ANALOG VOLTAGE MEASUREMENT IS OUT OF RANGE	-5.50 TO -4.50	
DATA-2 = SAME AS FOR 02			
15: System Status Error (continued)	Temperature or voltage out of range	Check DATA-1 for information pertaining to what is out of range and perform corrective action.*	3
0B =	+5 ANALOG VOLTAGE MEASUREMENT IS OUT OF RANGE	+4.40 TO +5.50	
DATA-2 = SAME AS FOR 02			
0C =	DISK SHUTDOWN CAUSED BY OUT OF RANGE TEMPERATURE	41 F to greater than 131 F (5 TO 55 C.)	
DATA-2 = REASON			
	01 = SUCCESSFUL SHUTDOWN		
	02 = FAILED TO SHUT DOWN		

Table 8-2 Hardware Error Types and Remedies (continued)

Error Type:Name	Source	Remedy	Priority
16: Defect in hard disk prompt area DATA-1 = 00 = BOTH SYS DRIVES 01 = SYS DRIVE 1 02 = SYS DRIVE 2 DATA-2 = LEAST SIGNIFICANT BYTE (Prompt number in HEX) DATA-3 = MOST SIGNIFICANT BYTE (Prompt number in HEX) DATA-4 = LANGUAGE SET # (1 TO N=n)	Defect in prompt area logged into Defect List	Copy prompts from diskette to the hard disk, using the Floppy Backup Restore procedure. If errors repeat, possible cause could be HD or VCU.	3
18. Data lost error. Hard disk number DATA-1 = LOGICAL DRIVE ID THAT FAILED TO REMAP SECTOR DATA-2 = NOT USED DATA-3 = NOT USED DATA-4 = NOT USED	Failure to attempt to relocate a bad sector on a disk. Data has been lost.	Replace hard disk with a spare provided by Octel. If error continues, contact your technical support center.	3
20–22: DID System Error	DID Diagnostics or configuration problems	Refer to the <i>DID/E&M Trunk Interface</i> manual for details.	2
23: PBX Integration	Problem with the RS-232C link with PBX	Check the RS-232C connections. If error repeats, contact your technical support center.	2
24: PBX Integration	Problem with the integration card or RS-232C integration	This error pertains only to certain integrated message server. The following outlines the probable cause and suggested remedy for that error, depending upon the DATA fields.	2

The DATA-1 field specifies the type of error. DATA-2 through DATA-4 are data associated with the error.

DATA-1 = ERROR CODE:

01 = ERROR IN OPENING CODE FILE H:LIC:
There is no code in the message server for the integration card.

REMEDY: Call your technical support center.

02 = ERROR DOWNLOADING FILE, DISK ERROR WHILE READING H:LIC:

REMEDY: Call your technical support center.

Table 8-2 Hardware Error Types and Remedies (continued)

Error Type:Name	Source	Remedy	Priority
<p>03 = LIC WAS BUSY WHEN IT SHOULDN'T HAVE BEEN The integration card was not able to accept commands to it because it was busy.</p> <p>REMEDY: Reset the integration card. If the error persists call your technical support center.</p> <p>04 = LIC REPORTED BAD DIAGNOSTIC BYTE: During the code download procedure or normal operation, the integration card reported an error through its diagnostic byte. DATA-2 = DIAGNOSTIC BYTE DATA-3 = NOT USED DATA-4 = STATE OF LIC TASK WHEN ERROR OCCURRED</p> <p>REMEDY: Clear the Hardware Error Table. If the error persists, call your technical support center.</p> <p>05 = LIC REPORT LINK STATUS ERROR The digit display telephone line to the integration card is not working. DATA-2 = LINK NUMBER HAVING ERROR DATA-3 = LINK STATUS DATA-4 = STATE OF LIC TASK WHEN ERROR OCCURRED</p> <p>REMEDY: Check the PBX status on the line if DATA-3 = 03 or check the wiring or PBX hardware if DATA-3 = 04.</p>			
<p>24: PBX Integration (continued)</p>	<p>Problem with the integration cardRS-232C integration</p>	<p>This error pertains only to certain integrated message servers. The following outlines the probable cause and suggested remedy for that error, depending upon the DATA fields.</p>	<p>2</p>
		<p>06 = LIC RECEIVED BAD REQUEST FROM CPU This is an error in communication between the system software and the integration card. DATA-2 = REPLY BYTE (34 = LIC BOOTED, 35 = BOOT ROM) DATA-3 = BAD REQUEST BYTE DATA-4 = STATE OF LIC TASK WHEN ERROR OCCURRED</p> <p>REMEDY: Call your technical support center</p>	

Table 8-2 Hardware Error Types and Remedies (continued)

Error Type:Name	Source	Remedy	Priority
	<p>07 = GOT AN ERROR WHILE DOING MESSAGE WAITING</p> <p>DATA-2 = REASON FOR FAILURE:</p> <p>00 = TIMED OUT</p> <p>01 = NOT APPLICABLE</p> <p>02 = MW NOT CONFIGURED</p> <p>03 = COULD NOT MAKE MW</p> <p>05 = EXTENSION IN "DO NOT DISTURB" (MITEL INTG)</p> <p>06 = MSG WTG LINK NOT IDLE WHEN CPU SENT MWI REQUEST</p> <p>DATA-3 = HIGH BYTE OF USER NUMBER THAT MW FAILED ON</p> <p>DATA-4 = LOW BYTE OF USER NUMBER THAT MW FAILED ON</p> <p>REMEDY: If DATA-2 = 00 or 03, clear the Hardware Error Table. If error persists, check PBX configuration of the digital display phone lines that connect to the integration card. If DATA-2 = 02, the extension number is not configured for message waiting. The extension number is determined from the user number, which is in DATA-3 and DATA-4. For example,</p> <p>DATA- 3 = 01; DATA- 4 = 33 = USER #0133.</p> <p>At the @ prompt, enter L MAILBOX to get the mailbox number. The Octel Overture 200/300 returns the MAILBOX number causing the error. A zero (0) must be entered before the mailbox number. For example,</p> <p>@ L M 0133 U Mailbox: 341</p>		
<p>24:PBX Integration (continued)</p>	<p>Problem with the integration card</p>	<p>This error pertains only to certain integrated message servers. The following outlines the probable cause and suggested remedy for that error, depending upon the DATA fields.</p> <p>08 = COULDN'T GET CALL INFO, PROBABLY GLARE, WILL TRANSFER TO ASSIST:</p> <p>The integration card was not able to determine the call information on the last call that came in on Port DATA-3.</p> <p>DATA-2 = REPLY TYPE (38 = BAD DISPLAY, 39 = GLARE)</p> <p>DATA-3 = PORT CALL CAME IN ON (1...16)</p> <p>DATA-4 = UNUSED</p> <p>REMEDY: Check the digit display telephone line configuration in the PBX. Pay particular attention to the port appearances on the keys. If the configuration is correct and the problem persists, call your technical support center.</p>	<p>2</p>

Table 8-2 Hardware Error Types and Remedies (continued)

Error Type:Name	Source	Remedy	Priority
	<p>09 = GOT CALL, BUT NO CALL RECORD (OR CALL RECORD WAS TOO LATE): DATA-2 = PORT # CALL CAME IN ON DATA-3 = NOT USED DATA-4 = NOT USED</p> <p>The call rang in on the port but the port the integration card (e.g., SLIC, ATTIC) didn't send the call information. Therefore, the Octel Overture 200/300 port answered the call after five rings and played the generic company greeting.</p> <p>REMEDY: Check the digit display telephone line configuration in the PBX. Pay particular attention to the port appearances on the keys. If the configuration is correct and the problem persists, call your technical support center.</p> <p>0A = INTEGRATION TYPE CONFIGURED DOES NOT MATCH INTEGRATION CARD INSTALLED: REMEDY: Be sure configuration in the SLOTS Table for the Octel Overture 200/300 matches the integration card type.</p> <p>0B = CAN'T FORWARD A PORT VIA MIC SINCE EXTENSION TO FORWARD PORT TO IS NOT DEFINED</p>		
<p>24: PBX Integration (continued)</p>	<p>Problem with the integration card</p>	<p>This error pertains only to certain integrated message servers. The following outlines the probable cause and suggested remedy for that error, depending upon the DATA fields.</p> <p>0C = UNEXPECTED CARD STATE DATA-2 = CARD STATE 00 = RESET 01 = FATAL ERROR 02 = DOWNLOAD 03 = CARD UP DATA-3 = TASK STATE 00 = RESET 01 = DOWNLOAD 02 = WAIT AFTER DOWNLOAD 03 = UP</p> <p>REMEDY: Clear Hardware Error Table. If error continues, call your technical support center.</p> <p>0D = TIMED OUT WAITING FOR STATUS BITS TO CHANGE (TO RUN OR FAIL AFTER DOWNLOAD COMPLETE) REMEDY: Clear Hardware Error Table. If error continues, call your technical support center.</p>	<p>2</p>

Table 8-2 Hardware Error Types and Remedies (continued)

Error Type:Name	Source	Remedy	Priority
25: Works Link Failure DATA-1 = 04 = UNABLE TO SYNCHRONIZE LINK REMEDY: Verify that the Works system hardware is correctly installed. Run Works system hardware diagnostics. Call your technical support center, if necessary. DATA-1 = 05 = SOFTWARE RELEASE MISMATCH BETWEEN THE OVERTURE 200/300 AND WORKS REMEDY: Install correct software releases on the Works system and the Octel Overture 200/300. Call your technical support center, if necessary. DATA-1 = 07 = WRONG CARD INSTALLED IN AP SLOT (BAD CARD ID) REMEDY: Check to make sure that the card installed in the slot is an AP card.	Problem with the RS-232C link to the Works system	The remedy for the error depends on the DATA-1 values. For DATA-1 values not listed, call your technical support center.	3
27: Option Control Chip Error DATA-1 = ERROR CODE: 01 = OCC READ ERROR (OCC CHIP PROBABLY BAD OR MISSING) 02 = OCC CHECKSUM ERROR 03 = SERIAL NUMBERS ON THE OCC AND SECTOR 3 ARE DIFFERENT 04 = CONTENTS OF THE OCC AND SECTOR 3 ARE DIFFERENT 05 = OCC SERIAL NUMBER IS ALL ZEROES 06 = SECTOR 3 READ ERROR 07 = SECTOR 3 CHECKSUM ERROR 0D = HW BIT DOESN'T MATCH OCC 0E = OEM ID ERROR ON DISK DRIVE DATA-2 = PHYSICAL SLOT # DATA-3 = LOG UNIT # DATA-4 = OEM ID OF DRIVE DATA-2 = UNUSED DATA-3 = UNUSED DATA-4 = UNUSED	Problem with the OCC	Contact your technical support center.	3

Table 8-2 Hardware Error Types and Remedies (continued)

Error Type:Name	Source	Remedy	Priority
28: ACP Error	Works requesting an error be logged in the Works Hardware Error Table	Log onto Works and list the Hardware Error Table. Refer to the Works <i>Installation and Maintenance Manual</i> , Maintenance chapter.	3
29: DMA Timeout	Non-maskable interrupt	Contact your technical support center.	3
30: Arbitration Timeout	Non-maskable interrupt	Contact your technical support center.	3
31: Control BUS Error	Non-maskable interrupt	Contact your technical support center.	3
32: CPU Coprocessor Error	Error logged by coprocessor interrupt routines and by coprocessor Task	Contact your technical support center.	2

DATA-1 = TYPE OF ERROR THAT OCCURRED IN THE COPROCESSOR

01 = COPROCESSOR INITIALIZATION ERROR
DATA-2 gives the reason.

DATA-2 =

3D = DUAL PORT RAM READ/WRITE TEST FAILED
 3E = DUAL PORT RAM VERIFY TEST FAILED
 3F = STATIC RAM READ/WRITE TEST FAILED
 40 = STATIC RAM VERIFY TEST FAILED
 41 = UNEXPECTED INTERRUPT RECEIVED BY COPROCESSOR
 42 = UNEXPECTED NMI RECEIVED BY COPROCESSOR
 43 = COPROCESSOR EXECUTED A WILD JUMP
 44 = TIMED OUT WAITING FOR COPROCESSOR READY

02 = TIMEOUT WAITING FOR COPROCESSOR DMA CHANNEL 1 TO COMPLETE

03 = TIMEOUT WAITING FOR COPROCESSOR DMA CHANNEL 2 TO COMPLETE

04 = COPROCESSOR-DETECTED ERROR ON DMA CHANNEL 1

05 = COPROCESSOR-DETECTED ERROR ON DMA CHANNEL 2

Table 8-2 Hardware Error Types and Remedies (continued)

Error Type:Name	Source	Remedy	Priority
33:Line Card Hardware Error	Error logged by selftest when start LSP reply was received with either an error status or an unexpected OK status (e.g., Slot is empty or already reported down)	Contact your technical support center.	3

The DATA-1 field specifies the type of error. DATA-2 and DATA-3 are data associated with the error.

DATA-1 = REPORTED STATUS

- 00 = START LSP REPLY RECEIVED WITH EITHER AN ERROR STATUS OR AN UNEXPECTED OK STATUS (e.g. slot is empty or already reported down.)

DATA-2 = REPORTED STATUS

- 00 = LSP SUCCESSFULLY STARTED
- 01 = SCSI ERROR WHILE LOADING LSP
DATA-4 = VCU ERROR CODE
- 02 = CARD TYPE IN SLOT DOES NOT MATCH CONFIGURED TYPE
DATA-4 = CARD TYPE ACTUALLY INSTALLED IN SLOT
- 03 = CONTROL BUS ERROR – SLOT EMPTY OR CARD NON-RESPONSIVE
- 04 = FILE SYSTEM READ ERROR ACCESSING LSP IMAGE
- 05 = CARD IN SLOT REPORTS FATAL DIAGNOSTIC ERROR
DATA-3 = SUPPLEMENTAL CARD STATUS
- 06 = BAD START LSP REQUEST
- 89 = LIC REPORTED LIC IMAGE CHECKSUM ERROR

DATA-3 = CURRENT SLOT STATE

- 00 = EMPTY (UNCONFIGURED)
- 01 = WAITING FOR INITIAL START LSP REPLY
- 02 = RUNNING
- 03 = ERROR

- 01 = NO PORTS CONFIGURED FOR LINE CARD
- 02 = LINE CARD DISALLOWED BY OCC
- 03 = TOTAL PORTS > ALLOWED BY OCC
- 04 = ERROR WRITING START LSP REQUEST TO VCU
- 05 = DISK ERROR WHEN SEARCHING FOR LSP CODES

Table 8-2 Hardware Error Types and Remedies (continued)

Error Type:Name	Source	Remedy	Priority
34. Power-ON Diagnostic Error	Selftest for line cards.	Replace LIC as indicated by slot number.	2
	<p>For LIC4</p> <p>DATA-1 = PORT 1 DATA-2 = PORT 2 DATA-3 = PORT 3 DATA-4 = PORT 4</p> <p>Error Codes for all DATA values:</p> <p>00 = NO ERRORS DETECTED 01 = CHANNEL STATUS REGISTER ERROR 02 = CVSD DATA REGISTER BIT/ADDRESS ERROR 04 = A/D CONVERTER OR POWER DETECT ERROR 08 = CVSD ENCODING CIRCUIT ERROR 10 = DTMF SENDER, POWER LIMITER ERROR 20 = CVSD DECODING CIRCUIT OR OUTPUT GAIN CIRCUIT ERROR 40 = CVSD DECODING, ENCODING ERROR 80 = DTMF SENDER, DTMF DECODER ERROR, OR BAND PASS FILTER CIRCUIT ERROR FF = FATAL ERROR</p>	<p>For LIC 8, TLC 8</p> <p>DATA-1 = PORT 1, PORT 2 DATA-2 = PORT 3, PORT 4 DATA-3 = PORT 5, PORT 6 DATA-4 = PORT 7, PORT 8</p>	
34 Power-ON Diagnostic Error	<p>Diag- Selftest for integration cards. TE INT LI INT DATA-1 through DATA-4 designate errors found.</p> <p>DATA-1: Bit 5: TIMER Bit 4: NMI Bit 3: Incorrect checksum found in code during normal operation Bit 2: Normal (error found during normal code operation) Bit 1: BOOT (error found during boot process) Bit 0: Incorrect checksum found in code during boot process</p>	Replace integration card as indicated by slot number.	2

Table 8-2 Hardware Error Types and Remedies (continued)

Error Type:Name	Source	Remedy	Priority
<p>34. Power-ON Diagnostic Error (continued)</p> <p>DATA-2</p> <ul style="list-style-type: none"> Bit 7: Error detected on Link 4 Bit 6: Error detected on Link 3 Bit 5: Error detected on Link 2 Bit 4: Error detected on Link 1 Bit 3: RAM error type 4 Bit 2: RAM error type 3 Bit 1: RAM error type 2 Bit 0: RAM error type 1 <p>DATA-3 = UNDEFINED DATA-4 = UNDEFINED</p>	<p>Selftest for integration cards.</p> <p>TE INT LI INT DATA-1 through DATA-4 designate errors found.</p>	<p>Replace integration card as indicated by slot number.</p>	<p>2</p>
<p>34. Power-ON Diagnostic Error</p> <p>DATA-1</p> <ul style="list-style-type: none"> Bit 7: 5 volts clean out of range Bit 6: VCC out of range Bit 5: A to D converter error Bit 4: PIT1 error Bit 3: Parity error Bit 2: DRAM data error Bit 1: Boot ROM checksum failure Bit 0: Fatal CPU error <p>DATA-2</p> <ul style="list-style-type: none"> Bit 7: DMA page register error Bit 6: Unexpected interrupt Bit 5: PIT2 (8254) timing error Bit 4: Temperature out of range Bit 3: -12 volts clean out of range Bit 2: -5 volts clean out of range Bit 1: 12 volts motor out of range Bit 0: 12 volts clean out of range 	<p>Selftest for CPU.</p> <p>DATA-1 through DATA-4 designate errors found.</p>	<p>Replace CPU. For OCC error, replace OCC.</p>	<p>3</p>

Table 8-2 Hardware Error Types and Remedies (continued)

Error Type:Name	Source	Remedy	Priority
<p>34. Power-ON Diagnostic Error</p> <p>DATA-3</p> <ul style="list-style-type: none"> Bit 7: TDM crosspoint error Bit 6: Modem failure Bit 5: COM port failure Bit 4: Watch Dog Timer failure Bit 3: OCC error Bit 2: Floppy Disk Controller error Bit 1: Real Time Clock error Bit 0: DMAC error <p>DATA-4</p> <ul style="list-style-type: none"> Bit 3: CODEC failure Bit 2: BIC error Bit 1: VCU error Bit 0: Control Bus error 	<p>Selftest for CPU. DATA-1 through DATA-4 designate errors found.</p>	<p>Replace CPU. For OCC error, replace OCC.</p>	<p>3</p>
<p>34: Power-ON Diagnostic Error</p> <p>DATA-1</p> <ul style="list-style-type: none"> Bit 0: Control Memory parity error detected in memory test. Bit 1: Control Memory parity circuit failed. Bit 2: Unexpected interrupt was received. Bit 3: Timer A interrupt not detected or Timer A timing error detected. Bit 4: Timer B timing error detected. Bit 5: Timer C timing error detected. Bit 6: Timer D timing error detected. Bit 7: Byte Clock A circuit error detected. <p>DATA-2</p> <ul style="list-style-type: none"> Bit 0: Byte Clock B circuit error detected. Bit 1: Voice memory failed memory test. Bit 2: Voice Memory refresh circuit error detected. Bit 3: Voice Memory parity circuit failed. Bit 4: Write Protect Memory failed memory test. Bit 5: Write Protect functionality failed. Bit 6: Control Bus Shared Memory error detected. Bit 7: Port Controller Memory failed memory test. 	<p>Selftest for VCU. DATA-1 through DATA-4 designate errors found</p>	<p>Replace VCU.</p>	<p>3</p>

Table 8-2 Hardware Error Types and Remedies (continued)

Error Type:Name	Source	Remedy	Priority
34: Power-ON Diagnostic Error (continued)	Selftest for VCU. DATA-1 through DATA-4 designate errors found	Replace VCU.	3
<p>DATA-3</p> <ul style="list-style-type: none"> Bit 0: Port Controller failed diagnostic selftest. Bit 1: Port Controller interrupt functionality failed. Bit 2: Port Controller ALU failed. Bit 3: Port Controller carry logic failed. Bit 4: Port Controller failed to return diagnostic acknowledgement. Bit 5: Port Controller failed PLAY/RECORD loop back test. Bit 6: Port Controller failed Silence register loop back test. Bit 7: DMA controller error detected. <p>DATA-4</p> <ul style="list-style-type: none"> Bit 0: Watch Dog Timer circuit failed. Bit 1: Master interrupt circuit failed. Bit 2: Control Bus Status Register circuit failed. Bit 3: SCSI Controller circuit failed. Bit 4: Undefined. Bit 5: Undefined. Bit 6: Undefined. Bit 7: Undefined. 			
36. System RAM Error	Cache module found an error with system RAM, CPU and/or VCU.	Call your technical support center for remedy.	3
<p>The DATA-1 field specifies the type of error. DATA-2 through DATA-4 are data associated with the error.</p> <p>DATA-1 = ERROR CODE:</p> <ul style="list-style-type: none"> 01 = FIRMWARE REPORT OF RAM SIZE NOT EVEN MEGABYTE 02 = CANNOT R/W MEM AS REPORTED BY FIRMWARE, SEE DATA-2 DATA-2: (D) = MEGABYTES WHERE ERR, WHEN DATA=1 OR 2 03 = RAM SIZE LESS THAN STANDARD SIZE OF 5 MEG FOR THE OCTEL OVERTURE 300 AND 2 MEG FOR THE OCTEL OVERTURE 200 (slot = CPU) 			

Table 8-2 Hardware Error Types and Remedies (continued)

Error Type:Name	Source	Remedy	Priority
36. System RAM Error (continued)	Cache module found an error with system RAM, CPU and/or VCU. 08 = VCU VOICE RAM < REQUIRED AMOUNT FOR PORT COUNT (SLOT = FIRST LINE CARD SLOT THAT GOES BEYOND LIMIT FOR EXISTING RAM) DATA-2 = NUMBER MB NEEDED FOR CURRENT PORT CONFIGURATION (IF = FF, NUMBER PORTS CONFIGURED > MAX EXPECTED) DATA-3 = NUMBER MB REPORTED BY VCU DATA-4 = NUMBER PORTS CONFIGURED 09 = VCU CONTROL RAM INSUFFICIENT FOR LANGUAGES LOADED DATA-2 = VCU CONTROL RAM SIZE IN MEGABYTES DATA-3 = N/A DATA-4 = N/A 10 = VCU RAM INSUFFICIENT FOR # FAX PORTS CONFIGURED DATA-2 = # FAX PORTS SUPPORTED BY VCU RAM DATA-3 = VCU CONTROL RAM SIZE IN MEGABYTES DATA-4 = VCU VOICE RAM SIZE IN MEGABYTES 11 = VCU RAM INSUFFICIENT FOR TOTAL NUMBER PORTS CONFIGURED DATA-2 = # PORTS SUPPORTED BY VCU RAM DATA-3 = VCU CONTROL RAM SIZE IN MEGABYTES DATA-4 = VCU VOICE RAM SIZE IN MEGABYTES 12 = CPU RAM SIZE INSUFFICIENT FOR OCC USER AND PORT COUNTS DATA-2 = 1 IF ERROR READING OCC 2 IF OCC SIZES TOO LARGE FOR TABLE ALLOCATION 13 = CPU RAM SIZE INSUFFICIENT FOR LAN OPERATION DATA-2 = 1 IF ERROR WHILE SYS_ALLOC OPERATION 2 IF ERROR WHILE VRTX PARTITION CREATION	Call your technical support center for remedy.	3
37. Ring Detection Failure	TEST Line 4	Ensure that the PBX is properly connected to the LIC, and verify that the PBX type provides sufficient loop current for the test. If the PBX is properly connected and the PBX provides sufficient loop current but the test still fails, replace the LIC. If the PBX type does not provide sufficient loop current, do not use TEST Line 4. DATA-1 = UNEXPECTED EVENT TYPE DATA-2 = NOT USED DATA-3 = NOT USED DATA-4 = NOT USED	2

Table 8-2 Hardware Error Types and Remedies (continued)

Error Type:Name	Source	Remedy	Priority
38. Disk Defect Boot Region	Defect in secondary bootstrap (Xboot) region	Attempt to reload the software code from the floppy diskette to the hard disk. If error repeats, replace the hard disk indicated in DATA-1. If error repeats again, call your technical support center.	3
<p>DATA-1 = LOGICAL DRIVE ID WITH DEFECTIVE XBOOT DATA-2 = NOT USED DATA-3 = NOT USED DATA-4 = NOT USED</p>			
39. Disk Defect File System Region	Defect in file system region of a system disk	Attempt to reload the software code from the floppy diskette to the hard disk. If error repeats, replace the hard disk indicated in DATA-1. If error repeats, call your technical support center.	3
<p>DATA-1 = LOGICAL DRIVE ID WITH DEFECTIVE FILE SYSTEM DATA-2 = NOT USED DATA-3 = NOT USED DATA-4 = NOT USED</p>			
40. Non-Media Disk Error	Non-media disk error	Call your technical support center to have information interpreted.	
<p>DATA-1 = DRIVE ID AND SEVERITY INDICATION 01 = NON-FATAL ERROR, DRIVE 1 02 = NON-FATAL ERROR, DRIVE 2 03 = NON-FATAL ERROR, DRIVE 3 04 = NON-FATAL ERROR, DRIVE 4 05 = NON-FATAL ERROR, DRIVE 5 06 = NON-FATAL ERROR, DRIVE 6 81 = FATAL ERROR, DRIVE 1 82 = FATAL ERROR, DRIVE 2 83 = FATAL ERROR, DRIVE 3 84 = FATAL ERROR, DRIVE 4 85 = FATAL ERROR, DRIVE 5 86 = FATAL ERROR, DRIVE 6</p>			
			1
			3
<p>DATA-2 = SCSI SENSE KEY DATA-3 = SCSI SENSE CODE DATA-4 = NOT USED</p>			3

Table 8-2 Hardware Error Types and Remedies (continued)

Error Type:Name	Source	Remedy	Priority
41. Visual Mailbox Hardware Error (LAN HE) DATA-1 = LAN ERROR TYPE AS FOLLOWS: 01 = NO RESPONSE FROM LAN CONTROLLER AFTER CONTROLLER RESET 02 = NO INTERRUPT RECEIVED FROM LAN AFTER CONTROLLER ENABLED 03 = INCORRECT ID STRING STORED BY CONTROLLER AFTER RESET DATA-2 = FIRST BYTE OF ID STRING (SHOULD BE D1 HEX) DATA-3 = SECOND BYTE OF ID STRING (SHOULD BE NODE ID)	Command link interface LAN is malfunctioning or has detected a network error	This is a Visual Mailbox error. First check that Visual Mailbox is functioning properly. If it is, this is a false alarm or the condition has corrected itself. Check to see if the cable from the Octel Overture 200/300 to the Gateway is properly connected and secured. Restart the Gateway. If the problem still exists, replace the CLI board in the Gateway.	3
	20 = PACKET TRANSMISSION WAS NOT ACKNOWLEDGED AFTER 5 SECONDS DATA-2 = DESTINATION NODE ID 21 = NETWORK RECONFIGURATION OCCURRED DUE TO TOKEN RING INACTIVITY		2

Table 8-2 Hardware Error Types and Remedies (continued)

Error Type:Name	Source	Remedy	Priority
42. Configuration Error	Error detected in the configuration tables	Check the configuration tables.	1
<p>The DATA-1 field specifies the type of error. DATA-2 through DATA-4 are data associated with the error.</p>			
<p>DATA-1 = ERROR CODE:</p>			
<p>01 = NO DEFAULT LINK ASSIGNED FOR NON-SPECIFIED COS</p>			
<p>DATA-2 = COS</p>			
<p>DATA-3 = HIGH BYTE OF USER NUMBER</p>			
<p>DATA-4 = LOW BYTE OF USER NUMBER</p>			
<p>02 = MORE THAN ONE DEFAULT LINK DEFINED</p>			
<p>DATA-2 = DEFAULT LINK ASSIGNED (SEE NOTE 1)</p>			
<p>DATA-3 = THIS DEFAULT LINK (SEE NOTE 1)</p>			
<p>03 = PORT ASSIGNED TO MORE THAN ONE INTEG TASK</p>			
<p>DATA-2 = SYSTEM PORT NUMBER</p>			
<p>DATA-3 = FIRST IU TASK ASSIGNED (1...)</p>			
<p>DATA-4 = THIS IU TASK ASSIGNED (1...)</p>			
<p>04 = AP NOT CONFIGURED IN SLOT TABLE BUT SYSP 146 IS SET</p>			
<p>05 = LINK ASSIGNED FOR MWI WAS NOT ENABLED</p>			
<p>DATA-2 = LINK AND UNIT (SEE NOTE 1)</p>			
<p>DATA-3 = HI BYTE OF USER NUMBER</p>			
<p>DATA-4 = LO BYTE OF USER NUMBER</p>			
<p>06 = GATEWAY ERROR MBOX NOT CONFIGURED (SYSP 199)</p>			
<p>07 = CALL TO MBOX WITH COS ATTRIBUTE 84 THAT WAS NOT CORRECTLY CONFIGURED</p>			
<p>DATA-2 = SPECIFIC OUTFAX (Attribute 84) ERROR</p>			
<p>= 0 = MBOX HAS ZERO MESSAGES</p>			
<p>= 1 = FIRST MSG IN MBOX IS NOT A FAX</p>			
<p>= 2 = RUSDIR FAILED (Read User Director Failed)</p>			
<p>08 = PRIMARY-SECONDARY CIRCULAR LINK LIST CORRUPTED</p>			
<p>DATA-2 = 0 SANITY CHECK FAILED</p>			
<p>1 LOOP DETECTED IN THE LIST</p>			
<p>09 = BAD SDM MBOX</p>			
<p>DATA-2 = 0</p>			
<p>DATA-3 = SUBTYPE</p>			
<p>DATA-4 = 8 MAILBOX DIGITS*</p>			
<p>*Read the last pair of digits first, the next-to-last second, etc. For example, if the mailbox were 12345678, the data 4 field would read 78563412. the Character "A: represents a 0 and the character "0" represents a null character. For example, mailbox 52025 would appear as 0050A250.</p>			
<p>0A = BAD NETWORK LOCATION</p>			
<p>0B = BAD PHANTOM MBOX</p>			
<p>DATA-3 = USER# HIGH BYTE, DATA-4 = USER# LOW BYTE.</p>			
<p>0C = BAD AUTOCOPY TARGET CONFIGURED</p>			
<p>DATA-2, DATA-3 = HI/LO USER # WHOSE AUTOCOPY TARGET IS INVALID</p>			
<p>Note 1: HI NIB = LINK (0...); LO NIB = IU (1...)</p>			
<p>0D = BAD FAX TARGET CONFIGURED</p>			
<p>DATA-2 = HIGH USER NUMBER WHOSE AUTOCOPY TARGET IS INVALID</p>			
<p>DATA-3 = LOW USER NUMBER WHOSE AUTOCOPY TARGET IS INVALID</p>			

Table 8-2 Hardware Error Types and Remedies (continued)

Error Type:Name	Source	Remedy	Priority
42. Configuration Error (continued)	Error detected in the configuration tables	Check the configuration tables.	1
0E =	TOTAL NUMBER OF VISUAL MAILBOX USERS EXCEEDS THE ALLOWED LIMIT		
DATA-2 =	HIGH BYTE OF THE TOTAL NUMBER OF VISUAL MAILBOX USERS		
DATA-3 =	LOW BYTE OF THE TOTAL NUMBER OF VISUAL MAILBOX USERS		
0F =	PBX HAS UNKNOWN LINE APPEARANCE		
DATA-2 =	INVALID LINE NUMBER IN WHICH TRANSLATION WAS ATTEMPTED		
10 =	PORT COS HAS UID LOGIN, BUT UID IS NOT CONFIGURED WITH SYSTEM PARAMETER 212		
DATA-2 =	PORT COS		
DATA-3 =	CHANNEL NUMBER		
11 =	ERROR IN USER TREE BUILD — USRERR		
DATA-2 =	TYPE OF ERROR		
	= 1 = UNKNOWN ERROR		
	= 2 = DUPLICATE		
	= 3 = BAD TREE FRAME		
	= 4 = BAD VUSER FRAME		
	= 5 = BAD BALANCE FACTOR		
	= 6 = BAD ROTATION		
DATA-3 =	HIGH NIBBLE OF USER NUMBER		
DATA-4 =	LOW NIBBLE OF USER NUMBER		
12 =	ERROR IN UID TREE BUILD — UIDERR		
DATA-2 =	TYPE OF ERROR		
	= 1 = UNKNOWN ERROR		
	= 2 = DUPLICATE		
	= 3 = BAD TREE FRAME		
	= 4 = BAD VUSER FRAME		
	= 5 = BAD BALANCE FACTOR		
	= 6 = BAD ROTATION		
DATA-3 =	HIGH NIBBLE OF USER NUMBER		
DATA-4 =	LOW NIBBLE OF USER NUMBER		
13 =	ERROR IN EXTENSION TREE BUILD — EXTERR		
DATA-2 =	TYPE OF ERROR		
	= 1 = DUPLICATE		
	= 2 = INVALID CHARACTER		
	= 3 = INVALID LENGTH		
	= 4 = NET NUM CONFLICT		
DATA-3 =	HIGH NIBBLE OF USER NUMBER		
DATA-4 =	LOW NIBBLE OF USER NUMBER		
14 =	RECEIVED INACCESSIBLE CREATOR MAILBOX DIGITS DURING A DIGITAL NETWORK MESSAGE TRANSFER		
	Creator must be accessible through the NUMBERING PLAN Table in order to be able to receive reply messages, return receipt, etc.		
	DATA-2, DATA-3, and DATA-4 contain the upper or leading six digits of inaccessible creator mailbox.		

Table 8-2 Hardware Error Types and Remedies (continued)

Error Type:Name	Source	Remedy	Priority
15 =	NO SELF IP ADDRESS CONFIGURED		
17 =	SNMP SYSTEM MANAGER NOT KNOWN, TRAP MUST BE SENT		
18 =	NO AP ERROR MAILBOX (SYSTEM PARAMETER 145).		
42. Configuration Error (continued)	Error detected in the configuration tables	Check the configuration tables.	1
19 =	SELF MUST BE CONFIGURED		
	SOURCE: Unable to build network creator's address for delivery of a network message.		
	REMEDY: Add a numbering plan entry for SELF in the NUMBERING PLAN Table.		
1A =	OCTELNET SYSTEM MAILBOX NOT CONFIGURED		
	SOURCE: The OctelNet System mailbox (System Parameter 248) has not been configured.		
	REMEDY: Configure the OctelNet System mailbox. Refer to the <i>Configuration</i> volume, Remote Analog Networking chapter, Configuration, System Parameters, and COS Attributes sections.		
1B =	OCTELNET SYSTEM MAILBOX DOES NOT HAVE COS ATTRIBUTE 82		
	SOURCE: The OctelNet System mailbox does not have Class of Service Attribute 82.		
	REMEDY: Add COS Attribute 82 — THIS USER MAY RECEIVE FAX MESSAGES, to the COS of the OctelNet System mailbox. To add COS Attribute 82 requires that a sufficient number of Fax Mail Plus licenses are authorized.		
1C =	OCTELNET MAXIMUM FAX TRANSMISSION TIME IS SET TO ZERO		
	SOURCE: The OctelNet maximum fax transmission time (System Parameter 252) is set to zero.		
	REMEDY: Set System Parameter 252 — OCTELNET: MAX FAX TRANSMIT TIME, to at least 1 minute.		

Table 8-2 Hardware Error Types and Remedies (continued)

Error Type:Name	Source	Remedy	Priority
42. Configuration Error (continued)	Error detected in the configuration tables	Check the configuration tables.	1
1D =	REMOTE SYSTEM (NOT OVERTURE 200/300) CONFIGURED TO SUPPORT TURNAROUND		
DATA-2 =	LOCATION NUMBER OF REMOTE CABINET IN THE LOCATION TABLE OF THE LOCAL CABINET		
SOURCE:	The remote cabinet (not an Octel Overture 200/300) is configured to support turnaround. The remote cabinet is an Octel Overture 250/350 or Octel Overture PC, and in its node profile, NODE RESPONSE ALLOWED has been set to YES for this node.		
REMEDY:	Modify the node profile in the remote cabinet and set NODE RESPONSE ALLOWED to NO.		
1E =	NO QUERY REPLY POSSIBLE. Digital network is not up, do not have domain feature, or both.		
1F =	DOMAIN FEATURE NOT AVAILABLE		
DATA-2 =	TYPE OF ERROR		
= 1 =	QUERIES BEING RECEIVED FROM FIELD This means that some other system has this cabinet configured in the domain.		
DATA-3 =	REMOTE HOST HANDLE OF THAT CABINET		
	This can be used to get the IP address of that cabinet by doing L HOST on the LAN card prompt.		
DATA-4 =	UNUSED		
20 =	OctelNet serial # not configured.		
22 =	Sent a prefix the remote side did not recognize during Namesend.		
23 =	Other side does not have the Namesend feature.		
24 =	Generic Gateway error mailbox has not been configured but is required. (System Parameter 285) Go Dial went to initialization prompt.		
25 =	Names Directory error during Namesend.		
26 =	Multiple domain location configured with same IP address.		
27 =	Self numbering plan entry not configured, but matches Alternate self.		
28 =	Location for destination network mailbox not found. It is possible that the network mailbox was in a distribution list and the location was deleted. DATA-2 = First 8 digits of the network mailbox.		
29 =	No forwarding string defined (system parameter 45) for NPIC.		

Table 8-2 Hardware Error Types and Remedies (continued)

Error Type:Name	Source	Remedy	Priority
43. Hard Disk/ Language Table Read/Write Error	Error detected in the read/write of language table	Errors 1 or 3 — Run FLOPPY Backup/Restore. Errors 2, 5, 6, 7, or 8 — Run Disk Exerciser command.	3
<p> DATA-1 = ERROR CODE, AS FOLLOWS: 01 = NO LANGUAGE LOADED 02 = NO ACTIVE SYSTEM DISKS FOR READ 03 = CK SUM ERROR ON READ 04 = TABLE SIZE ERR 05 = CAN'T READ EITHER SYS-DISK 06 = ERR ON WRITE TO DISK #1 07 = ERR ON WRITE TO DISK #2 08 = ERR ON WRITE TO BOTH DISKS 09 = LANGUAGE QTY LOADED EXCEEDS OCC MAX </p>			
44. CPU/VCU Request/Reply Checksum Error	A protocol error occurred between the CPU and VCU on the control bus.	Contact your technical support center.	3
<p> DATA-1 = NUMBER OF RETRIES ATTEMPTED BEFORE TRANSACTION SUCCEEDED OR ABANDONED (MAXIMUM OF 3). DATA-2, DATA-3, DATA-4 = FAILURE REASON FOR EACH ATTEMPT: 01 = NO ERROR (RETRY SUCCEEDED) 02 = CONTROL BUS TIMEOUT ATTEMPTING TO READ CPU CB STATUS REGISTER 03 = CONTROL BUS TIMEOUT ATTEMPTING TO READ VCU SHARED RAM 04 = CONTROL BUS TIMEOUT ATTEMPTING TO WRITE VCU SHARED RAM 05 = INCORRECT CHECKSUM ON VCU REPLY BUFFER 06 = VCU DETECTED CHECKSUM ERROR ON CPU REQUEST BUFFER </p>			
45. VCU Reply Language Set Error	The VCU has replied that there is an error in a language set.	Contact your technical support center.	3
<p> DATA-1 = THIS ERROR NUMBER DATA-2 — BIT MAP HI BITS= LOAD FAULT DATA-3 — BIT MAP HI BITS= NOT LOADED </p>			

Table 8-2 Hardware Error Types and Remedies (continued)

Error Type:Name	Source	Remedy	Priority
46. Received DTMF other than D (AMIS)	While trying to establish a connection with a Protocol 4 (AMIS) location, received non D DTMF tone, suggesting that a person's telephone number may have been entered.	Check the route. Check that the PNN or TNN is correct. Contact the system administrator of the remote network.	1
<p>DATA-1 = ERROR CODE: 01 = WHILE TRYING TO ESTABLISH A CONNECTION WITH A LOCN, WE GOT BACK DTMF WE WERE NOT EXPECTING, SUGGESTING WE MAY HAVE, SOMEHOW, DIALED A PERSON'S TELEPHONE NUMBER. FOR PROTOCOL 1, 2 AND 3 WE COULD'VE GOT DTMF 0-9, * OR # FOR PROTOCOL 4 WE COULD'VE GOT ANY DTMF OTHER THAN D DATA-2 and DATA-3 = ARE THE INDEX INTO THE NETRLT TABLE THAT LEADS US TO THE PROBLEMATIC LOCATION</p> <p>REMEDY: Check the route, PNN and TNN. Contact the system administrator at the remote end.</p> <p>DATA-2 = ERROR CODE: 02 = ATTEMPTING TO NETWORK WITH AN OEM MODEL THAT HAS NETWORKING INCOMPATIBILITY DATA-2 and DATA-3 = ARE THE INDEX INTO THE NETRLT TABLE THAT LEADS US TO THE PROBLEMATIC LOCATION</p> <p>REMEDY: Contact your technical support center.</p>			
61. VCU: Insufficient Control RAM	The VCU does not have enough control RAM for model specified by CPU.	Contact your technical support center.	3
<p>DATA-1 = MEGABYTES OF RAM ACTUALLY HAVE DATA-2 = MAX PORTS GIVEN BY CPU REQUEST</p>			
62. VCU: Insufficient Voice RAM	The VCU does not have enough voice RAM for model specified by CPU.	Contact your technical support center.	3
<p>DATA-1 = MEGABYTES OF RAM ACTUALLY HAVE DATA-2 = MAX PORTS GIVEN BY CPU REQUEST</p>			

Table 8-2 Hardware Error Types and Remedies (continued)

Error Type:Name	Source	Remedy	Priority
<p>63. Fax Card Hardware Error</p> <p>DATA-1 =</p> <p>00 = FAX LOOPBACK TEST FAILED DATA-2 =OTHER CH# (RELATIVE) USED IN TEST DATA-3 =ERROR CODE RETURNED FROM FAX PROCESSOR</p> <p>01 = FAX CARD DIDN'T RESPOND TO TEST COMMAND DATA-2 =1ST CH# (RELATIVE) USED IN TEST DATA-3 =2ND CH# (RELATIVE) USED IN TEST</p>	<p>Fax loopback test failed, or fax card didn't respond to test command, TEST X x y z.</p>	<p>Replace the fax card and do the loopback test again.</p>	<p>2</p>
<p>64. LAN Card Hardware Error</p> <p>DATA-1 =ERROR CODE:</p> <p>00 = INVALID LAN CONTROL BUS ID Problem with LAN card.</p> <p>REMEDY: Contact your technical support center.</p> <p>01 = BAD LAN CONTROL BUS CKSUM Problem with LAN card.</p> <p>REMEDY: Contact your technical support center.</p> <p>02 = LOST COMMUNICATION TO LAN BOARD Communication between the CPU and LAN card across the control bus was interrupted or failed for some reason.</p> <p>REMEDY: Verify that the LAN card is properly inserted in the slot and has not been removed. Try the LANSTAT command to verify that the LAN card is up and communicating with the CPU. If the error continues, contact your technical support center.</p>	<p>Problem detected by the LAN card.</p>	<p>Dependent on the Data-1 values described below.</p>	<p>3</p>

Table 8-2 Hardware Error Types and Remedies (continued)

Error Type:Name	Source	Remedy	Priority
64. LAN Card Hardware Error (continued)	Problem detected by the LAN card. DATA-2 values in case of LAN_LOST_COMM: 1 Unable to read card status. 2 Card status is nonoperational. 3 CB timed out at start of read reply. 4 CB timed out during read reply packet. 5 CB time out at start of send request. 6 CB timed out when checked if took request. 7 CB timed out at end of the read reply. 8 CB timed out during write request packet. 9 CB timed out after write request. 10 Complement of replies not match. 11 Checksum wrong after control bus copy. 03 = REACHED THE MAX. RETRY COUNT WHILE SYNCHRONIZING. FORCED RESET DONE TO SYNCHRONIZE. The CPU is unable to communicate with the LAN card. REMEDY: Same as for DATA-1 = 02. 04 = LAN CONTROL BLOCK REQUEST SIZE MISMATCH Compatibility problem with the LAN card. REMEDY: Contact your technical support center. 05 = LAN CONTROL REPLY BLOCK SIZE MISMATCH Compatibility problem with the LAN card. REMEDY: Contact your technical support center. 06 = LAN CONTROL BUS TIME OUT DURING READING/WRITING CONTROL BUS Problem with the LAN card. REMEDY: Contact your technical support center. 07 = OEM NCK OF OTHER SYSTEM DOES NOT MATCH OURS OEM type between systems is incompatible. REMEDY: Use the LANSTAT command to determine which location is in the OEM-FAIL state. Check the OEM type of the current system. Contact your technical support center.	Dependent on the DATA-1 values described below.	3

Table 8-2 Hardware Error Types and Remedies (continued)

Error Type:Name	Source	Remedy	Priority
64. LAN Card Hardware Error (continued)	Problem detected by the LAN card.	Dependent on the DATA-1 values described below.	3
	08 = ERROR DURING COURTESY DOWN An error occurred while executing the courtesy down command.		1
	DATA-2 = ERROR CODES: 01 = COURTESY DOWN STATE 02 = COURTESY STATE STATE		
	DATA-3 = ERROR CODES 01 = LAN EVENT TIMEOUT 02 = VCU EVENT TIMEOUT 03 = INVALID LAN SLOT		
	REMEDY: Try the courtesy down command again. If the problem continues, contact your technical support center.		
	09 = ERROR WITH CSX PARAMETERS The VCU is unable to provide the necessary client, server, and transfer-task resources needed to run LAN. This could typically occur when LAN is added to an existing installed message server.		3
	DATA-2 = NUM_CLIENTS (REPORTED BY VCU) DATA-3 = NUM_SERVERS (REPORTED BY VCU) DATA-4 = NUM_XFERS (REPORTED BY VCU)		
	REMEDY: If necessary, System Parameters 126, 127, and 128 can be set to reduce the CSX request to the VCU. Most likely, though, the VCU is too old to work with LAN or has insufficient memory. Contact your technical support center.		
	A = MULTIPLE YES RESPONSE TO MAILBOX QUERY Within a LAN uniform numbering plan, any specific mailbox should have only one occurrence across the domain. The system, however, sent a mailbox query and had multiple locations respond with a "found."		
	DATA-2 = MAILBOX NUMBER (DIG 0 AND 1 PACKED) DATA-3 = MAILBOX NUMBER (DIG 2 AND 3 PACKED) DATA-4 = MAILBOX NUMBER (DIG 4 AND 5 PACKED)		
	REMEDY: Use the FINDMBX command to locate all occurrences of the mailbox in question. Delete the unnecessary occurrence of the mailbox. If this mailbox must appear multiple times, the numbering plan must be modified to remove the mailbox initial digits from the uniform numbering plan domain.		

Table 8-2 Hardware Error Types and Remedies (continued)

Error Type:Name	Source	Remedy	Priority
64. LAN Card Hardware Error (continued)	Problem detected by the LAN card. B = CONTROL BLOCK SIZE MISMATCH Compatibility problem with LAN card. DATA-2 = LOW BYTE OF CTL BLOCK SIZE REMEDY: Contact your technical support center. C = CPU DATA PACKET RECEIVED GOT CHECKSUM ERROR Data communication is being corrupted between the current system CPU and the CPU at the location specified. DATA-2 values as follows: 1 On open conn request received 2 On connless data packet 3 On data packet received 4 On connection grant received 5 On connection reject received 6 On a query packet received 7 Remote end had the cksum error DATA-3 = LOW BYTE OF LOCATION DATA-4 = UPPER BYTE OF LOCATION REMEDY: The LAN card guarantees that if a packet gets through, it should be perfect, regardless of line conditions. Therefore, this most likely points to the software on either the CPU or LAN card. Was the software recently changed or upgraded at either location? If this continues, contact your technical support center. To determine the other location: Subtract 2 from the number in Data-2 and Data-3 to get the location number starting from 1. In UPDATE, list the LOCATION Table to determine the name of the corresponding location.	Dependent on the DATA-1 values described below.	3
65 DMA Channel Error	Problem with CPU card	Replace CPU card	2
66. LAN Card Reported Hardware Error	Problem detected by the LAN card.	Dependent on the DATA-1 values as described below. DATA-1 = ERROR CODE ON LAN CARD: 01 = ERROR LOGGED PRIOR TO SYNC-UP WITH CPU REMEDY: Contact your technical support center.	3

Table 8-2 Hardware Error Types and Remedies (continued)

Error Type:Name	Source	Remedy	Priority
<p>66. LAN Card Reported Hardware Error (continued)</p>	<p>Problem detected by the LAN card.</p> <p>02 = LINK LOST</p> <p>REMEDY: The LAN card lost its connection to the LAN. This usually indicates that the connection to the digital network went down. It is normally not a problem within the Octel Overture 200/300 cabinet. It is mainly an informational error. It shows the date and time of the occurrence, which can be correlated to the Call Processing Trace and any user complaints at this time.</p> <p>This error can occur for many reasons, including the following:</p> <ul style="list-style-type: none"> <input type="checkbox"/> LAN cable or wiring to the hub was disconnected. <input type="checkbox"/> The digital network was taken down for servicing. <input type="checkbox"/> Equipment failure in the digital network. <p>The LAN card will automatically attempt to reestablish all connections when the digital network comes up again. All system functions and features should recover and continue smoothly.</p> <p>If digital networking is currently up and running, it means there was a temporary loss of the network, which has since been corrected. Otherwise, it may be necessary to check with the network administrator.</p> <p>If the problem continues, even when the external digital network is up, it may indicate a problem with the LAN card.</p> <p>03 = COULD NOT GET ENETID FROM BIC</p> <p>REMEDY: Contact your technical support center.</p> <p>04 =BAD ROUTE — GATEWAY IP ADDRESS BAD</p> <p>Error occurs if the user set up a gateway IP address that is incorrect; i.e., the gateway is not in the same LAN as the system.</p> <p>DATA-2 and DATA-3 together give 16 bits of error information. DATA-4 = 0</p> <p>REMEDY: Correct the gateway IP address.</p>	<p>Dependent on the DATA-1 values as described below.</p>	<p>3</p>

Table 8-2 Hardware Error Types and Remedies (continued)

Error Type:Name	Source	Remedy	Priority
66. LAN Card Reported Hardware Error (continued)	Problem detected by the LAN card. 05 = SNMP MANAGER HOST NAME CANNOT BE RESOLVED Possible reasons include: <input type="checkbox"/> Manager host name may be bad. <input type="checkbox"/> Name server IP address may be bad. <input type="checkbox"/> The Octel Overture 200/300 cannot communicate with the name server. <input type="checkbox"/> Other — error code in DATA-2 and DATA-3 gives more information. REMEDY: Correct the SNMP manager host name. <input type="checkbox"/> Correct the name server IP address. <input type="checkbox"/> Configure the SNMP manager IP address. DATA-2 = 1, 2, or 3. This tells us where the error was logged from. DATA-3 and DATA-4 together give 16 bits of error information. 06 = BAD_SUBNET The subnet mask for self is not configured correctly.. Most common reason is that the subnet mask has never been configured. The subnet mask is configured for SELF only, and the value configured is shown when the L LOC command is issued. REMEDY: Get the correct IP address from the LAN administrator and reconfigure the message server 07 = DUP_IPADDR — IP ADDRESS CONFLICT. There is another system with the same IP address in the subnetwork that includes the message server. REMEDY: Get the correct IP address from the LAN administrator and configure it in the definition of SELF. DATA-2 = ERROR DATA DATA-3 = ERROR DATA DATA-4 = ERROR DATA	Dependent on the DATA-1 values as described below.	3
67 Patching Error	Dependent on value in DATA-4. DATA-4 = 01 PARTIAL PATCH DETECTED 02 PATCH AREA ALLOCATION ERROR	Contact your technical support center.	3

Table 8-2 Hardware Error Types and Remedies (continued)

Error Type:Name	Source	Remedy	Priority
68 BIC Error	Dependent on value in DATA-1.	Replace CPU card.	2
			1
<p>DATA-1 = 01 BIC read error (chip bad or missing). DATA-1 = 02 BIC checksum error</p> <p>DATA-2 = Computed checksum. DATA-3 = Checksum stored in BIC.</p>			
69 VCU port-controller status	Error detected with VCU port controller.	Contact your technical support center.	3
<p>DATA-1 = VCU logical port with error status. DATA-2 = Currently active port-control-block for port-block 0 or 1. DATA-3 = Port block status. Bit 0 = Parity error Bit 1 = Direction error Bit 2 = Request timing error Bit 3 = Port operation complete</p>			
70 Control Bus error on a DSP-based card	Error in Contrl Bus I/O between CPU and card.	Replace the DSP-based card. If error repeats, call your technical support center.	3
<p>DATA-1 = 01 Timeout on a request from CPU. 02 Timeout on a PIC request. DATA-2 = Message Type waiting for _____. DATA-3 = User Number, if applicable.</p>			
71 High Speed Link Monitor Error	The Digital Networking high-speed link is down more than the maximum configured in System Parameters 267–269. An error is logged per location.	Check remote location to see if digital networking is up. Follow troubleshooting guidelines in the <i>Networking</i> volume, Digital Networking chapter.	3
<p>Data-1 Location number for which logged Data-2 Sub-type, the possible values are as follows: 1 = continuous downtime exceeded system parameter 267 2 = cumulative downtime exceeded system parameter 268 3 = Number of times down exceeded system parameter 269</p> <p>Data-3 Unused Data-4 Unused</p>			

Table 8-2 Hardware Error Types and Remedies (continued)

Error Type:Name	Source	Remedy	Priority
72 Protocol Revision Level Error	Namesend activity	Disable Namesend to the remote location.	1
Data-1	Digital Networking		
Data-2	Local Protocol Revision Level		
Data-3	Remote Protocol Revision Level		
Data-4	Location number of Remote Location		
73. Control Bus Error – VCU shared RAM I/O	Dependent on value in DATA-2.	Replace VCU. If error repeats, contact your technical support center.	3
Data-1	Task Number		
Data-2	= 01 VCU to CPU = 02 CPU to VCU		
74 Gateway Timeout error	Message server timed out waiting for the gateway poll.	The OctelAccess server is not responding. Check and bring up the OctelAccess server.	3
Data-1	OctelAccess ID (the ID configured at the OctelAccess server)		
75 Names Directory Export error	Message server detected error when updating Names Directory export file or during export file transfer.	Contact your technical support center.	2
DATA-1	ERROR CODE: 01 = NO DISK SPACE 02 = READ ONLY VOLUME 03 = ROOT DIRECTORY FULL 04 = NO SYSTEM DEVICE 05 = FILE CONTAINS BAD SECTORS 06 = NOT A FILE SYSTEM DRIVE		

8.3 TRAFFIC PEG COUNT TABLE

The Traffic Peg Count Table is used to record events monitored by the Octel Overture™ 200/300. Proper use of the table helps to understand how the various features and functions are being used.

Several of the pegs may be used to determine PBX performance in conjunction with the Octel Overture 200/300, such as 13, 24, 25, 47–49.

Pegs are arranged in a table ten columns wide. The pegs are numbered from the top left corner across the first row 0, 1, 2 . . . The second row begins with 10, 11, 12 . . .

 Some pegs are not used. Unused pegs do not appear in the peg description.

The header displayed when the table is listed contains the current date, time, message server name, ID number, serial number, and PBX type. Under the header is the date and time the Traffic Peg Table was last cleared. The numbers displayed in the Traffic Peg Table are for the time period beginning from when the Traffic Peg Table was last cleared.

```

@L P
MON 05/16 10:43:20 1997 V200_4 ID:200444 S/N:200003 PBX:63

05/16 14:11

TRAFFIC PEGS

      0      1      2      3      4      5      6      7      8      9
00000  00078 00000 00020 00013 00000 00000 00001 00004 00056
00010  00022 00000 00005 10063 00000 07976 00009 00001 00002 00000
00020  00000 00000 00002 00009 65535 00000 00000 00001 00000 00000
00030  00008 00000 00023 00006 00000 00002 00002 00001 00001 00003
00040  00000 00000 00000 00000 00000 00010 00002 00000 00004 00000
00050  00000 00000 00000 00000 00000 00000 00000 00000 00000 00000
00060  00000 00000 00000 00000 00000 00000 00000 00000 00000 00000
00070  00000 00000 00000 00000 00002 00000 00000 00000 00000 00000
00080  00000 00000 00000 00000 00000 00000 00000 00000 00000 00000
00090  00000 00000 00000 00000 00000 00000 00000 00000 00000 00000
00100  00000 00000 00000 00000 00000 00000 00000 00000 00000 00000
00110  00000 00000 00000 00000 00000 00000 00000 00000 00000 00000
00120  00000 00000 00000 00000 00000 00000 00000 00000 00000 00004
00130  00000 00061 00018 00000 00000 00000 00000 00000 00004 00000
00140  00001 00000 00001 00000 00002 00004 00001 00000 00000 00000
00150  00000 00000 00000 00000 00000 00000 00000 00000 00000 00000
00160  00000 00000 00000 00000 00000 00000 00000 00000 00000 00000
00170  00001 00000 00000 00000 00001 00000 00000 00000 00000 00000
00180  00000 00000 00000 00000 00000 00000 00000 00000 00000 00000
00190  00000 00000 00000 00000 00000 00000 00000 00000 00000 00000
00200  00000 00000 00000 00000 00000 00000 00009 00001 00016 00015
00210  00000 00000 00000 00000 00000 00000 00000 00000 00000 00000
00220  00000 00000 00000 00000 00000 00000 00000 00000 00000 00000
00230  00000 00000 00000 00000 00000 00000 00000 00000 00000 00000
00240  00000 00000 00000 00000 00000 00000 00000 00000 00000 00000
00250  00000 00000 00000 65535 00000 00000 00000 00000 00000 00000
00260  00000 00000 00000 65535 00000 00000 00000 00000 00000 00000
00270  00000 00000 00000 65535 00000 00000 00000 00000 00000 00000
00280  00000 00000 00000 00000 00000 00000 00000 00000 00000 00000
00290  00000 00000 00000 00000 00000 00000

```

- Use the command `LIST PEG` to display pegs on a terminal. At the `@` prompt, enter

```
L P 
```

- Use the command `CLEAR PEG` to set pegs to zero. At the `@` prompt, enter

```
C P 
```



Many of the traffic pegs are used in the System Performance report. When the Traffic Peg Count Table is cleared, the System Performance report is also cleared. Likewise, if the System Performance report is cleared, the Traffic Peg Count Table is cleared.

Traffic Pegs

#	Description
01	INCOMING CALLS Total number of incoming calls answered by the Octel Overture 200/300. Includes calls, logons, hangups, etc.
02	QUICK MESSAGES Number of quick messages left (Messaging feature <input type="checkbox"/> *).
03	MESSAGES CREATED Total number of messages created. Includes messages left after extension busy/no answer, new messages, reply messages, quick messages, etc. (NEW, REPLY, QUICK).
04	TIMES LISTEN WAS USED Number of times listen was used (<input type="checkbox"/> 5).
05	TIMES LAST WAS USED Number of times last was used (<input type="checkbox"/> 1 <input type="checkbox"/> 5).
06	MESSAGES SENT TO DISTRIBUTION LIST Number of times messages were sent to Distribution Lists.
07	TIMES SAVE WAS USED Number of times save was used (<input type="checkbox"/> 7).
08	TIMES ERASE WAS USED Number of times erase was used (<input type="checkbox"/> 3).
09	TIMES USER LOGGED ON Number of times callers successfully logged on (by pressing <input type="checkbox"/> # followed by mailbox number and security code).
10	TIMES EXIT WAS USED Number of times <input type="checkbox"/> 9 was used to exit from mailbox.
11	MAILBOX IN USE WHEN USER ATTEMPTED TO LOGON Number of times the mailbox was already in use when logon was attempted.
12	USER WAS DROPPED BECAUSE OF TOO MANY ERRORS Number of times a person was disconnected because too many errors had been made.

#	Description
13	NO DIAL TONE FROM PBX WHEN TRYING TO MAKE A CALL Number of times the Octel Overture 200/300 attempted to call out and did not receive dial tone from the PBX (when connecting a call).
14	LEFT MESSAGE AFTER CALLING AN EXTENSION Number of messages left after calling an extension that was busy or did not answer.
15	NUMBER OF VOICE PROCESSING ERRORS Number of software errors.
16	TIMES NEW WAS USED TO CREATE A MESSAGE Number of times new was used to create a message (<input type="text" value="6"/>).
17	NUMBER OF FORWARDED MESSAGES Number of times forward was used (<input type="text" value="1"/> <input type="text" value="3"/>).
18	NUMBER OF REPLY MESSAGES Number of times reply was used (<input type="text" value="1"/> <input type="text" value="7"/>).
19	TIMES VOLUME WAS USED Number of times volume was used (<input type="text" value="1"/> <input type="text" value="8"/>).
20	RETURNED TO AUTO ATTENDANT FROM LOGON Number of times <input type="text" value="9"/> <input type="text" value="0"/> was used from mailbox to return to automated attendant level.
21	TIMES TIME STAMP WAS USED Number of times that time was used (<input type="text" value="8"/>).
22	MESSAGES SENT WITH MORE THAN ONE ADDRESS Number of messages that were directed to more than one address.
23	MESSAGES DELETED Number of messages deleted — heard to conclusion and exited with <input type="text" value="9"/> , deleted because too short, or erased. If a message has been sent to more than one address, the message is not deleted (and count accumulated) until all addresses have erased the message.
24	AMOUNT OF SECONDS ALL PORTS BUSY Total number of seconds calls were blocked because all Octel Overture 200/300 ports were busy.
25	MESSAGE WAITING COLLIDED WITH AN INCOMING CALL Number of times message waiting call collided with incoming call or did not receive dial tone from PBX.
26	CALLS MADE BY MESSAGE WAITING Number of message waiting calls made.
27	MESSAGE DELETED — TOO SHORT Number of messages deleted because they were less than four seconds in duration.

#	Description
29	IMMEDIATE CALL USED Number of times immediate call was used (1 4).
30	BACKUP WHILE LISTENING TO A MESSAGE Number of times backup was used while listening to message (2).
31	BACKUP WHILE RECORDING A MESSAGE Number of times backup was used while listening to message (2).
32	TIMES SYSTEM HAS RELOADED Number of times the Octel Overture 200/300 has reloaded.
33	TIMES SYSTEM HAS RESTARTED Number of times the Octel Overture 200/300 has restarted.
34	AUTO ATTENDANT CALLS TO BUSY EXTENSION Number of calls made to busy extensions.
35	AUTO ATTENDANT CALLS TO EXTENSION THAT DID NOT ANSWER Number of calls made to extensions that did not answer.
36	GREETINGS PLAYED Number of times greetings, included extended absence greetings, were played.
37	GREETINGS RECORDED Number of greetings, including extended absence greetings, that were recorded.
38	CALLS TO VACANT EXTENSION Number of calls made to extensions that do not exist (does not count message waiting calls).
39	CALLS TO UNAVAILABLE EXTENSION Number of calls made to unavailable extensions.
40	ALARM CALLS CONFIRMED Number of alarm calls confirmed by pressing the [*] upon receipt of alarm call.
41	ALARM CALLS ATTEMPTED Number of calls made attempting to deliver alarm calls.
42	NO PORT AVAILABLE WHEN ALARM CALL WAS ATTEMPTED Number of times an alarm call could not be made because a port was not available.
43	MESSAGE WAITING ENCOUNTERED 3/4 OF THE PORTS BUSY Number of seconds message waiting could not call, and/or could not deliver a network message because 3/4 or more of all ports were busy (when all ports are configured for outcall).
44	MESSAGE WAITING CALLED VACANT EXTENSION Number of times message waiting called an extension that did not exist.

#	Description
45	AUTO ATTENDANT CALLS PLACED Number of times the Octel Overture 200/300 dialed an extension number; counts all extensions called.
46	AUTO ATTENDANT CALLS ANSWERED BY CALLED PARTY Number of calls placed that were answered.
47	TRANSFER TO INTERCEPT BY DIALING 0 Number of times transfer to intercept because zero was pressed.
48	TRANSFER TO INTERCEPT BY TIME OUT (no digits entered) Number of times actually transferred to intercept when caller defaulted because no digits were entered. (The difference between peg 48 and peg 138 equals the number of times the Attendant/Intercept Greeting played.)
49	NO DIAL TONE ON ALTERNATE TRANSFER CODE Number of times no dial tone was received when attempting the alternate transfer string.
50	BROADCAST MESSAGES SENT Number of broadcast messages sent.
51	RESET INTEGRATION UNIT
58	Applies only to integration units on integration cards. Number of times the Octel Overture 200/300 reset the integration card. Could be caused by various conditions. The Octel Overture 200/300 does not restart.
67	MESSAGE SEND FAILED Number of times message failed to be delivered because mailbox full or set not to accept messages.
68	NUMBER OF CALLS PLACED BY WORKS APPLICATION The number of times calls were placed by the Works for Serenade system.
69	NUMBER OF CALLS TO EITHER AP OR GATEWAY LINK ERROR MAILBOX Calls to the AP or to the Gateway Link terminated unexpectedly and the caller was sent to the AP error mailbox or to the Gateway Link error mailbox.
70	SUBSEQUENT CALLS Number of mailboxes called after placing initial call.
71	MESSAGE WAITING CALLS TO BUSY EXTENSIONS Number of calls message waiting placed to busy extensions.
72	MESSAGE WAITING CALLS TO RING-NO-ANSWER EXTENSIONS Number of calls message waiting placed to ring-no-answer extensions.
73	MESSAGE WAITING CALLS ANSWERED Number of calls message waiting placed that were answered.
74	NAME MESSAGES RECORDED Number of name messages recorded.

#	Description
75	<p>SEND FAILED TO EXTENDED MAILBOX — MAILBOX FULL/SET TO NOT ACCEPT MESSAGE</p> <p>Number of times a message was not sent to an Extended mailbox because the mailbox was full or set not to accept messages.</p>
76	<p>SET UP OFFSITE MESSAGE WAITING</p> <p>Number of times offsite outcalling digit string was set up.</p>
77	<p>MESSAGE WAITING CALLED CX/MX PORT</p> <p>Number of times an extension was called and answered by an Octel Overture 200/300 CX/MX port.</p>
78	<p>NETWORK MESSAGE SEND ATTEMPT</p> <p>The number of Protocol 1 or 3 network message send attempts. This peg is incremented each time the local system attempts to transmit a voice message.</p>
79	<p>NETWORK MESSAGE SEND SUCCESS</p> <p>The number of Protocol 1 or 3 network messages sent successfully. This peg is incremented each time the local system successfully transmits a voice message. Protocols 1 and 3 send all pending messages for a location (except night messages) when that location is called.</p> <p>Night messages are included in the pending messages for a location during the hours defined in System Parameter 62 — NET: NIGHT DELIVERY START TIME, and System Parameter 63 — NET: NIGHT DELIVERY END TIME.</p>
80	<p>NETWORK SEND COLLISION</p> <p>Number of network message send attempts that collided with an incoming call. This peg is incremented during Protocol 5 operation.</p>
81– 88	<p>CODE DOWNLOADED SUCCESSFULLY TO INTEGRATION CARD</p> <p>Applies only to integration units of integration cards. Number of times operating code was successfully downloaded to the integration card after reset.</p>
97	<p>DIGIT LOST DURING NETWORK COMMUNICATION</p> <p>The number of times a digit was lost or garbled during network communications.</p> <p>(Protocols 1, 3, or 5 only) This peg is incremented if the destination system responds during network communications that the digits received have failed a data integrity check. Digits can be corrupted by noise or poor transmission quality on the network connection.</p>
98	<p>AIC CALLED CX/MX PORT</p> <p>(AIC = Assisted Inward Calling) Number of times a CX/MX port answered when the Octel Overture 200/300 was extending a call.</p>
99	<p>POWER FAILED</p> <p>Number of times the Octel Overture 200/300 detected a power failure.</p>

#	Description
100	<p>NET MESSAGE SEND — OTHER SYSTEM BUSY The number of times a network message call was terminated because the destination system did not have enough idle ports.</p> <p>(Protocols 1, 3, or 5 only) This peg is incremented if the destination system responds during network communication that it has too few idle ports to accept a network call.</p>
101	<p>DID/E&M INTERFACE INTERCEPTED IMMEDIATE Number of times DID/E&M Interface calls were intercepted immediately.</p>
102	<p>DID/E&M INTERFACE INTERCEPTED RING-NO-ANSWER Number of times DID/E&M Interface calls were intercepted due to ring-no-answer.</p>
103	<p>DID/E&M INTERFACE INTERCEPTED DUE TO BUSY Number of times DID/E&M Interface calls were intercepted due to busy.</p>
104	<p>DID/E&M INTERFACE INTERCEPTED SOMETHING WRONG WITH CALL Number of times DID/E&M Interface calls were intercepted but something was wrong with the call.</p>
105	<p>INVALID BUS MESSAGE TYPE Received selftest results unexpectedly. Check for error in Hardware Error Table.</p>
106	<p>DID/E&M INTERFACE REQUESTED CODE Number of times DID/E&M Interface requested code.</p>
107	<p>DID/E&M INTERFACE REQUESTED TABLES Number of times DID/E&M Interface requested tables.</p>
108	<p>DID/E&M INTERFACE REQUESTED TO INTERCEPT CALL IMMEDIATELY Number of times DID/E&M Interface was instructed to intercept immediately.</p>
109	<p>DID/E&M INTERFACE ERRORS DURING SELFTEST Number of times DID/E&M Interface had errors to report from selftest.</p>
110	<p>DUPLICATE DEVICES DETECTED (MASTER Octel Overture 200/300S) Number of times duplicate devices were found.</p>
111	<p>MESSAGES RECEIVED FROM BUS Number of times messages were received from the digital bus.</p>
112	<p>MESSAGES SENT TO BUS Number of messages sent to the digital bus.</p>
113	<p>NETWORK MESSAGE RECEIVE DISK FULL The number of times the local system reported the disk was full when a network location was attempting to deliver a message.</p>

#	Description
114	<p>NETWORK MESSAGE RECEIVED REACHED BLOCK LIMIT The number of times the message being received was longer than expected.</p> <p>The originating system sends the length of the message being transmitted during network communication. If the end of message marker is not received, typically the line has dropped.</p>
115	<p>NETWORK MESSAGE RECEIVED EXCEEDED SILENCE LIMIT The number of times the local system aborted recording a message being received during to the silence limit being exceeded.</p>
116	<p>NETWORK MESSAGE RECEIVE PORTS BUSY The number of times the local system terminated a Protocol 1, 3, or 5 network call because there were too few idle ports.</p>
117	<p>OFFSITE MESSAGE WAITING CALLS PLACED Number of offsite outcalls attempted.</p>
118	<p>OFFSITE MESSAGE WAITING TIMES ANSWERED Number of offsite outcalls answered.</p>
119	<p>OFFSITE MESSAGE WAITING ANSWERED BUT NO RESPONSE Number of times offsite outcalls were answered but the Octel Overture 200/300 detected no response after speaking the prompt the maximum number of times.</p>
120	<p>OFFSITE MESSAGE WAITING PRE-DIGIT FAILED Number of times the predigit string failed.</p>
121	<p>NETWORK LINE QUALITY TEST ATTEMPT The number of line quality test attempts performed during Protocol 1 or 3 network calls.</p>
122	<p>NETWORK LINE QUALITY TEST FAILED The number of Protocol 1 or 3 network line quality failures.</p>
123	<p>NETWORK LINE QUALITY SIGNAL TOO LOW The number of Protocol 1 or 3 network line quality tests that failed because the signal level was too low.</p>
124	<p>NETWORK LINE QUALITY SIGNAL/NOISE RATIO TOO LOW The number of Protocol 1 or 3 network line quality tests that failed because the signal level was too low.</p>
125	<p>LAMP MESSAGE WAITING CALLS MADE Number of times a message waiting lamp digit string was attempted.</p>
126	<p>LINE DROP EVENTS Number of loop current interruption (momentary disconnect).</p>
127	<p>INITIAL DIALED <input type="text" value="0"/> FOR ASSISTANCE Number of times a caller pressed <input type="text" value="0"/> immediately after answer.</p>

#	Description
128	SUBSEQUENT DIALED [0] FOR ASSISTANCE Number of times callers pressed [0] after a mailbox.
129	INITIAL DIALED EXTENSION OR DIGIT Number of times a caller initially entered the first digit (1–8) for a defined mailbox or extension in the USER Table.
130	SUBSEQUENT DIALED EXTENSION OR DIGIT Number of times a caller subsequently entered a first digit (1–8) mailbox or extension defined in the USER Table.
131	INITIAL PRESSED [#] TO LOGON Number of times caller initially dialed [#] as a first digit, indicating a request to logon to a mailbox.
132	SUBSEQUENT PRESSED [#] TO LOGON Number of times a caller subsequently pressed [#] after attempting to call another mailbox.
133	INITIAL PRESSED [*] FOR QUICK MESSAGE Number of times [*] was pressed immediately after the system answered.
134	SUBSEQUENT PRESSED [*] FOR QUICK MESSAGE Number of times [*] was subsequently pressed after other digits were entered.
135	CALLER WAS NETWORK The number of times the source of an incoming call was identified as a network location.
136	CALLER WAS DID/E&M INTERFACE UNIT. Number of times the caller was a DID/E&M Trunk Interface call.
137	CALLER WAS TRANSFERRED OUT TO NETWORK The number of times Protocol 1 or 3 placed an immediate call to accomplish any network function. Includes calling an extension, checking if a message has been listened to, logging on, or sending a Quick Message across the network.
138	INITIAL DEFAULT TO INTERCEPT Number of times a caller listened to the Company Greeting, did nothing and defaulted to the intercept extension. The call may not actually be transferred to the intercept extension. For example, the greeting may have played or the caller may have abandoned. (The difference between peg 48 and peg 138 equals the number of times the Attendant/Intercept Greeting played.)
139	SUBSEQUENT DEFAULT TO INTERCEPT; CALLER MADE TOO MANY ERRORS Number of times callers were transferred to the intercept extension after entering too many non-existent extensions. Calls intercepted by DID or E&M Interface Modules can also default to assistance after leaving a message.
140	INITIAL LEFT MESSAGE AT TONE Number of callers that left a message at the tone.

#	Description
141	SUBSEQUENT LEFT MESSAGE AT TONE Number of times a message was left after calling a different mailbox.
142	MESSAGE RECEIVED AFTER GREETING Number of messages left after greeting played.
143	MESSAGE RECEIVED FROM NETWORK The number of messages received from network locations. Includes all protocols.
144	NORMAL GREETING PLAYED, NO CALL PLACED Number of times a greeting played and no additional digits were entered.
145	MESSAGE CREATED BUT NOT SENT, (ERROR — NO ADDRESS, ETC.) Number of messages NOT SENT because there was absolute silence, no address was entered, or the message was deleted before sent. A message is defined as any message, greeting, or name.
146	INCOMPLETE EXTENSION NUMBER DIALED Number of times caller failed to finish entering an extension number.
150	CARD COURTESY DOWN Number of times the CD X command was executed successfully for LAN cards.
152	COMMAND SENT OVER RS-232C TO PBX TO TURN ON MESSAGE WAITING Number of times a command was sent over RS-232C to PBX to turn ON message waiting light (PBX integration only).
153	COMMAND SENT OVER RS-232C TO PBX TO TURN OFF MESSAGE WAITING Number of times a command was sent over RS-232C to PBX to turn OFF message waiting light (PBX integration only).
154	INFORMATION SENT FROM PBX OVER RS-232C Received information from PBX over RS-232C (PBX integration only).
155	RECEIVED INVALID/UNEXPECTED RESPONSE FROM PBX OVER RS-232C Received invalid or unexpected response from PBX over RS-232C (PBX integration only).
156	INTEGRATION — BUSY FORWARD PBX forwarded call when busy was encountered.
157	INTEGRATION — RING-NO-ANSWER FORWARD PBX forwarded call when ring-no-answer was encountered.
158	INTEGRATION — ALL FORWARD Integration — PBX immediately forwarded all calls, or forwarding status unknown (e.g., SL-1).
159	INTEGRATION — DIRECT CALL Integration — Direct extension call to logon.

#	Description
160	INTEGRATION — NO CALL RECORD Integration — Number of times received a call on an integrated system but received no call record or it was late.
161	TRANSFER TO PERSONAL ASSISTANT Number of times caller pressed <input type="text" value="0"/> or was automatically transferred to a Personal Assistance position.
162	PERSONAL ASSISTANT UNAVAILABLE Number of times a personal assistant did not answer due to busy, ring-no-answer, or telephone forwarded back to the Octel Overture 200/300.
163	NO PORT AVAILABLE FOR ATTIC ONLY APPLIES TO AT&T SYSTEM 75 INTEGRATION Number of times the Octel Overture 200/300 was too busy to accept a call from the ATTIC card. Caller hears ringback until an Octel Overture 200/300 port becomes available.
164	PORT STATUS CONFLICT WITH SLIC APPLIES ONLY TO A NORTHERN TELECOM SL-1 INTEGRATION The Octel Overture 200/300 port status conflicts with the SLIC card status.
165	RESET INTEGRATION CARD APPLIES ONLY TO INTEGRATION CARDS Number of times the Octel Overture 200/300 reset the integration card. Could be caused by various conditions. The Octel Overture 200/300 does not restart.
167	MESSAGE SENT TO PDL WITH AN INVALID MAILBOX AS A MEMBER Number of times a message was sent to a Personal Distribution List that contained an invalid mailbox as one of its members.
168	MW COMMAND SENT TO AN INTEGRATION CARD TO TURN ON LAMP APPLIES ONLY TO INTEGRATION CARDS Number of times a message waiting command was sent to an integration card to turn ON a message waiting indicator.
169	MW COMMAND SENT TO AN INTEGRATION CARD TO TURN OFF LAMP APPLIES ONLY TO INTEGRATION CARDS Number of times a message waiting command was sent to an integration card to turn OFF a message waiting indicator.
170	REPLIED TO ADDITIONAL ADDRESSES Number of times reply to additional addresses was used.
171	MARKED A MESSAGE PRIVATE Number of times mark a message Private was used.
172	FUTURE DELIVERY MESSAGE Number of times a Future Delivery message was created.
173	NAMES DIRECTORY MAILBOX Number of times the Dial-by-Name directory mailbox was accessed.

#	Description
174	PERSONAL DISTRIBUTION LIST Number of times a Personal Distribution List was used.
175	PROTOCOL 2 MESSAGE ATTEMPT The number of Protocol 2 network message delivery attempts. This peg is incremented each time a message is successfully sent to Protocol 2 locations. Protocol 2 sends all pending messages for a particular location (except night messages) when that location is called.
176	PROTOCOL 2 MESSAGE SENT Number of Protocol 2 messages successfully sent.
184	APLINK: DIAL TO AP LINK CONNECT TMO LOST Number of times the communication link between the ACP and the CPU was established.
185	TIMES PORT WITH COS ATTRIBUTE 66 GOT AN INCOMING CALL Number of times a port with Attribute 66 — THIS PORT IS FOR OUTCALLS ONLY, NO DIAL TONE EXPECTED, received an incoming call.
190	INTEGRATION — PBX RESTART PBX notified the Octel Overture 200/300 of a restart. message waiting lamps are relit.
191	INTEGRATION-RECORD CALL-IN-PROGRESS Record call-in-progress requested by user.
192	INTEGRATION — FORCED FORWARD A call was forced to forward to the Octel Overture 200/300.
193	INTEGRATION — UNKNOWN FORMAT Unknown format for call record received.
194	INTEGRATION — PREMATURE END Premature end of call record.
195	INTEGRATION — BAD FIRST DIGIT Bad first digit in VAR field.
196	INTEGRATION — DIGITS NOMATCH Digits do not match call format.
197	TODO QUEUE TOO FULL Number of times TODO QUEUE too full (3/4) to take message.
198	AP DECPOOLCNT MAILBOX FULL OR OUT-OF-SYNC IN GATEWAY LINK Indicates when an Octel Overture 200/300 mailbox in the application processor message mailbox pool is out-of-sync with the Works for Serenade application ACM count or out-of-sync in the Gateway Link CCM scheme.

#	Description
202	NETWORK PROTOCOL 4 MESSAGE ATTEMPT The number of Protocol 4 network message delivery attempts. This peg is incremented each time the local system attempts to transmit a voice message to a Protocol 4 location.
203	NETWORK PROTOCOL 4 MESSAGE SENT The number of successful Protocol 4 network message deliveries.
204	PORT WENT OFF-HOOK AND DIDN'T GET LOOP CURRENT The number of times the system port went off-hook and loop current was not detected.
205	NUMBER OF MESSAGES AFTER CALLING AN EXTENSION UNDER THE ALL FORWARD CONDITION The number of messages left after calling an extension with all forward.
206	NUMBER OF MESSAGES SENT BY LOGGED ON USERS The number of times mailbox holders sent a message after pressing <input type="text" value="#"/> <input type="text" value="6"/> to record a message, <input type="text" value="1"/> <input type="text" value="3"/> to forward a message, or <input type="text" value="1"/> <input type="text" value="7"/> to reply to a message.
207	NUMBER OF OTHER MESSAGES — NET ERRORS, RETURN RECEIPT, MAILBOX FULL, ETC. The number of times other messages, such as Return Receipt, Forward on network, network errors, and ACP messages, were sent.
208	NUMBER OF INVALID USER LOGON ATTEMPTS The number of times an invalid mailbox or password was entered when attempting to log on to a mailbox.
209	NUMBER OF INVALID TERMINAL LOGON ATTEMPTS The number of times an invalid password was used when attempting to log on to the Octel Overture 200/300 terminal.
210	NUMBER OF MESSAGES AFTER CALLING AN EXTENSION WHERE THE CONDITION WAS BUSY The number of times a message was left after calling a busy extension (forwarded or not).
211	TOTAL NUMBER OF FAXES RECEIVED Total number of fax messages received by the Octel Overture 200/300 including faxes received with errors.
212	NUMBER OF URGENT MSGS SENT Total number of messages that were marked urgent.
213	FAX SECONDS TOO FEW FAX CHANNELS TO DO DELIVERY Total number of seconds no fax channels were available to deliver fax messages. The minimum number of fax channels that must be idle before another fax delivery outcall is attempted is determined by System Parameter 202 — FAX NUM FREE FAX CHANNELS TO MAKE FAX CALLS.

#	Description
214	<p>TOTAL NUMBER OF FAXES PRINTED</p> <p>Total number of fax messages printed, including fax messages immediately printed, printed to a group fax number or to a personal fax number.</p>
215	<p>NUMBER OF ATTEMPTS TO PRINT A FAX VIA ATTRIBUTE 84</p> <p>Total number of calls to fax-on-demand mailboxes.</p>
216	<p>NUMBER OF FAXES THAT FAILED TO PRINT</p> <p>Number of unsuccessful attempts to print a fax message.</p>
217	<p>NUMBER OF TIMES QUICK FAX FEATURE USED</p> <p>Number of times a caller used Quick Fax, [*]*, to send a fax message to a mailbox.</p>
218	<p>NUMBER OF TIMES COULDN'T ALLOCATE A FAX CHANNEL BECAUSE ALL FAX CHANNELS WERE BUSY</p> <p>Number of times a fax channel was not available to send or receive a fax because all fax channels were busy.</p>
219	<p>USER HELP</p> <p>For the VMX 5000 User Interface only. The number of times a mailbox holder pressed [0][0][0] from a 5000 User Interface mailbox to transfer to the Help desk.</p>
220	<p>USER DIALED EXTENSION</p> <p>For the VMX 5000 User Interface only. The number of times a mailbox holder pressed [0][0][1] and an extension number from a 5000 User Interface mailbox to call a local extension.</p>
221	<p>LOGON FAILURE TRANSFER</p> <p>The number of times callers were transferred to the Logon Failure mailbox after three bad logon attempts.</p>
222	<p>USER RECORDED AN ANNOUNCEMENT</p> <p>For the VMX 5000 User Interface only. The number of times a mailbox holder pressed [0][7][2] to record an announcement.</p>
223	<p>USER RECEIVED MAILBOX MESSAGE</p> <p>For the VMX 5000 User Interface only. The number of times a mailbox holder pressed [0][7][7] to record a mailbox message.</p>
224	<p>NUMBER OF TIMES A CALL IS MADE TO A MAILBOX WHICH IS CONFIGURED FOR PORT/TRUNK COS OVERRIDE</p> <p>The number of times a call is made to a mailbox that is configured for port/trunk COS override.</p>
225	<p>USER ACTIVATED EXTENDED ABSENCE GREETING</p> <p>The number of extended absence greetings recorded. Traffic Peg 37 is also incremented.</p>
226	<p>CALL ANSWERING MESSAGE BLOCKED DUE TO EXTENDED ABSENCE GREETING</p> <p>The number of times a call answering message was blocked because the extended absence greeting was ON. Traffic Peg 36 is also incremented.</p>

#	Description
227	DIGITAL NETWORK MESSAGE SEND SUCCESS The number of digital network messages sent successfully.
228	MESSAGES RECEIVED FROM DIGITAL NETWORK Number of messages successfully received from the digital network.
229	NUMBER OF NETWORK NAMES RECEIVED FROM DIGITAL NETWORK Number of network names successfully received from the digital network
230	REAL-TIME NAME PLAY REQUESTED Number of times this cabinet played a real-time name from other cabinets.
231	VOICE BLOCKS OF MESSAGE SENT Number of voice blocks of messages sent.
232	VOICE BLOCKS OF MESSAGE RECEIVED Number of voice blocks of messages received.
233	SECONDS ONE-HALF OR MORE LAN CHANNELS BUSY Number of seconds during which one-half or more of the LAN channels were busy.
234	SECONDS THREE-QUARTERS OR MORE LAN CHANNELS BUSY Number of seconds during which three-quarters or more of the LAN channels were busy.
235	SECONDS ALL LAN CHANNELS BUSY Number of seconds during which all LAN channels were busy.
236	SECONDS LAN CHANNELS IN USE SENDING MESSAGES Total number of seconds during which LAN channels were sending messages, for all channels combined.
237	SECONDS LAN CHANNELS IN USE RECEIVING MESSAGES Total number of seconds during which LAN channels were receiving messages, for all channels combined.
238	ATTEMPTS TO MAKE AN OUTGOING CONNECTION Number of times LAN channels attempted to open an outgoing connection.
239	OUTGOING CONNECTION REJECTS Number of times the attempt to open a connection was rejected.
240	OUTGOING CONNECTION REJECTS BECAUSE NO LAN CHANNEL AVAILABLE Number of times the reject was due to too many LAN channels already busy at the receiving end.
241	INCOMING CONNECTION ATTEMPTS Number of times this cabinet received a request to open a connection.

#	Description
242	INCOMING CONNECTION REJECTS BY THIS CABINET Number of times this cabinet rejected a request to open a connection.
243	INCOMING CONNECTION REJECTS BECAUSE NO LAN CHANNEL AVAILABLE Number of times this cabinet rejected a request to open a connection because too many LAN channels were already busy.
244	MAXIMUM SIMULTANEOUS REAL TIME NAME PLAYS Maximum number of real-time names that were playing at one time.
245	REAL-TIME QUERY CACHE HITS This peg gives the number of times for real-time queries that the mailbox location was found in the Network Names Table.
246	BACKGROUND (MESSAGING) QUERY CACHE HITS This peg gives the number of times for messaging queries that the mailbox location was found in the Network Names Table.
247	SINGLE LOCATION QUERIES Number of single location queries. This peg is incremented only for real-time name play.
248	REAL-TIME MULTIPLE LOCATION (BROADCAST) QUERIES Number of real-time (non-background) query requests that have been broadcast to all other domain cabinets.
249	BACKGROUND MULTIPLE LOCATION (BROADCAST) QUERIES Number of background message delivery query requests sent to all other domain cabinets.
250	GOT DISK FULL WHILE SENDING MESSAGES OVER THE DIGITAL NETWORK Number of times the destination cabinet rejected a message during delivery because of the disk being full.
251	GOT DISK FULL WHILE RECEIVING MESSAGES OVER THE DIGITAL NETWORK Number of times this cabinet rejected a message during delivery because of the disk being full.
252	LAN CHECKSUM ERROR DETECTED DURING DIGITAL NETWORK COMMUNICATION Number of times a checksum error occurred during digital network communication.
253	TOTAL TIME (IN MINUTES) THAT THE SYSTEM IS UP Number of minutes the Octel Overture 200/300 has been up. Increments every minute. This peg is used in conjunction with peg 254 to calculate the percentage of time that the LAN is UP to the time that the system is UP for the Digital Network Performance Report, LAN Availability.

#	Description
254	<p>TOTAL TIME (IN MINUTES) THAT THE LAN IS UP</p> <p>Number of minutes that communication to the LAN card has been up. Increments every minute that the LAN card is communicating to the CPU. This peg is used in conjunction with peg 253 to calculate the percentage of time that the LAN is UP to the time that the system is UP for the Digital Network Performance Report, LAN Availability.</p>
255	<p>NUMBER OF TIMES TOTAL REAL TIME NAMES PLAYED REACHED THE LIMIT OF AVAILABLE CLIENTS</p> <p>The number of times that a name could not be played by this cabinet in real time over the LAN. This cabinet had already hit the maximum limit for playing the maximum number of simultaneous real time names (i.e., hit Maximum Name Clients).</p>
256	<p>NUMBER OF TIMES REAL TIME NAME PLAY RESULTED IN ERROR DUE TO LIMIT AT SERVER</p> <p>The number of times that a name could not be played by this cabinet in real time over the LAN. The cabinet on which the name resides had already hit its limit for the maximum number of simultaneous real time names that it can provide to other cabinets (i.e., hit Maximum Name Servers).</p>
257	<p>NUMBER OF TIMES REAL TIME QUERY BY EXTENSION</p> <p>The number of times that a real time LAN query was broadcast to all cabinets in the LAN domain to search by matching extension digits (as opposed to search by mailbox digits).</p>
258	<p>NUMBER OF TIMES LAN REQUEST QUEUE FILLED UP</p> <p>The number of times that the LAN request queue filled up.</p>
259	<p>NUMBER OF TIMES DETECT DTMF WHILE RECORDING NET NAME OR MESSAGE</p> <p>The number of times DTMF was detected while recording a network name or message.</p>
260	<p>NUMBER OF TIMES SENDING NET NAME FAILED</p> <p>The number of times that sending a network name failed.</p>
261	<p>OCTELNET MESSAGE SEND ATTEMPTS</p> <p>The number of Protocol 5 network message send attempts.</p>
262	<p>OCTELNET MESSAGE SEND SUCCESSES</p> <p>The number of successful Protocol 5 network message deliveries.</p>
263	<p>OCTELNET MESSAGE RECEIVE ATTEMPTS</p> <p>The number of Protocol 5 network message receive attempts.</p>
264	<p>OCTELNET MESSAGE RECEIVE SUCCESSES</p> <p>The number of successful Protocol 5 network message receives.</p>

#	Description
265	<p>COPIED A RECEIVED OCTELNET MESSAGE — MORE THAN 10 RECIPIENTS The number of times a received Protocol 5 message was copied because the message had more than 10 recipients.</p>
266	<p>COPIED A RECEIVED OCTELNET MESSAGE — DIFFERENT DELIVERY OPTIONS The number of times a received Protocol 5 message was copied because the message had different delivery options than the previous recipient.</p>
267	<p>OCTELNET SYSTEM MAILBOX FULL The number of times the OctelNet system mailbox was full.</p>
268	<p>OCTELNET SYSTEM MAILBOX LOCK ATTEMPTS The number of attempts the Octel Overture 200/300 made to lock the OctelNet system mailbox. The mailbox is locked whenever a task is underway to read or write to the mailbox, such as receiving future delivery messages or receiving messages that have more than 10 recipients or recipients with different delivery options. Only one task can access a mailbox at a time. Locking the mailbox ensures that the changes being made by one task do not interfere with changes by another task.</p>
269	<p>OCTELNET SYSTEM MAILBOX LOCK SUCCESSES The number of successful attempts the Octel Overture 200/300 made to lock the OctelNet system mailbox. Failure to lock the OctelNet system mailbox (that is, after Peg 268 is incremented because of an attempt to lock it but Peg 269 is not incremented) means that many tasks have tried to access the mailbox but some tasks have not been able to access it.</p>
270	<p>OCTELNET MESSAGE RECEIVE EXCEEDS EXPECTED LENGTH GIVEN BY SENDING SYSTEM The number of times a Protocol 5 message receive exceeds the expected length given by the sending system.</p>
271	<p>OCTELNET FAX SEND ATTEMPTS The number of attempts the Octel Overture 200/300 made to send a fax message over Protocol 5.</p>
272	<p>OCTELNET FAX SEND SUCCESSES The number of successful attempts the Octel Overture 200/300 made to send a fax message over Protocol 5.</p>
273	<p>OCTELNET FAX RECEIVE ATTEMPTS The number of attempts the Octel Overture 200/300 made to receive a fax message over Protocol 5.</p>
274	<p>OCTELNET FAX RECEIVE SUCCESSES The number of successful attempts the Octel Overture 200/300 made to receive a fax message over Protocol 5.</p>

#	Description
275	OCTELNET SPOKEN NAME SEND ATTEMPTS The number of attempts the Octel Overture 200/300 made to send a spoken name over Protocol 5.
276	OCTELNET SPOKEN NAME SEND SUCCESSES The number of successful attempts the Octel Overture 200/300 made to send a spoken name over Protocol 5.
277	OCTELNET SPOKEN NAME RECEIVE ATTEMPTS The number of attempts the Octel Overture 200/300 made to receive a spoken name over Protocol 5.
278	OCTELNET SPOKEN NAME RECEIVE SUCCESSES The number of successful attempts the Octel Overture 200/300 made to receive a spoken name over Protocol 5.
279	OCTELNET ASCII NAME SEND ATTEMPTS The number of attempts the Octel Overture 200/300 made to send an alphabetic (ASCII) name over Protocol 5.
280	OCTELNET ASCII NAME SEND SUCCESSES The number of successful attempts the Octel Overture 200/300 made to send an alphabetic (ASCII) name over Protocol 5.
281	OCTELNET ASCII NAME RECEIVE ATTEMPTS The number of attempts the Octel Overture 200/300 made to receive an alphabetic (ASCII) name over Protocol 5.
282	OCTELNET ASCII NAME RECEIVE SUCCESSES The number of successful attempts the Octel Overture 200/300 made to receive an alphabetic (ASCII) name over Protocol 5.
283	NUMBER OF DIGITAL NETWORK FAX MESSAGES SENT SUCCESSFULLY The number of digital network fax messages sent successfully. Fax messages include voice-annotated fax messages.
284	NUMBER OF DIGITAL NETWORK FAX MESSAGES RECEIVED SUCCESSFULLY The number of digital network fax messages received successfully. Fax messages include voice-annotated fax messages.
285	OFFSITE/MESSAGE WAITING END DIGITS FAIL The number of times the offsite outcalling end digits specified through System Parameter 259 — DIGIT STRING AT END OF OFFSITE/PAGER DIGITS, failed.
290	GATEWAY LINK – NEW CALL FOR LOGON The number of times a logon control is transferred to the OctelAccess server.
291	GATEWAY LINK – NEW CALL FOR LOGOFF The number of times a logoff control is transferred to the OctelAccess server.

#	Description
292	GATEWAY LINK – STANDARD NEW CALL The number of times a new call is transferred to the OctelAccess server control.
293	GATEWAY LINK – NEW CALLS NOT CLAIMED BY THE GATEWAY Number of times an attempt to transfer call control to the OctelAccess server failed because no gateway assumed control of the new call.
294	GATEWAY LINK – NUMBER OF SESSIONS ESTABLISHED BY THE GATEWAY The number of sessions established by the OctelAccess server. This is the number of applications that have connected to the message server.
295	GATEWAY LINK – OUTCALLS INITIATED BY CLIENTS The number of outcalls made using the OctelAccess server. This is a count of the number of times applications made outcalls through the OctelAccess server.
296	GATEWAY LINK – FAXES DELIVERED FOR CLIENTS The number of faxes delivered for applications using the OctelAccess server.
297	GATEWAY LINK – FAX MESSAGES TRANSFERRED TO THE GATEWAY This is a count of the number of times the OctelAccess server used the file transfer feature to transfer a fax message from Octel Overture 200/300 to the OctelAccess server.
298	GATEWAY LINK – VOICE MESSAGES TRANSFERRED TO THE GATEWAY This is a count of the number of times the OctelAccess server used the file transfer feature to transfer a voice message from Octel Overture 200/300 to the OctelAccess server.
299	GATEWAY LINK – FAX MESSAGES TRANSFERRED TO THE MESSAGE SERVER This is a count of the number of times the OctelAccess server used the file transfer feature to transfer a fax message from the OctelAccess server to Octel Overture 200/300.
300	GATEWAY LINK – VOICE MESSAGES TRANSFERRED TO THE MESSAGE SERVER This is a count of the number of times the OctelAccess server used the file transfer feature to transfer a voice message from the OctelAccess server to Octel Overture 200/300.
301	GATEWAY LINK – FTP REQUESTS REJECTED DUE TO REACHING MAXIMUM CONCURRENT LIMIT OF 3 The message server allows only three simultaneous file transfers. This is a count of the number of times a request to transfer files was rejected because three transfers were already in progress.
307	INTEGRATION – ATTEMPT TO TRANSFER TO AN EXTENSION FORWARDED An attempt, that may or may not have been successful, was made by a user to transfer a caller to an extension forwarded to the message server. Used with Matra PBX integration only.

#	Description
308s	INTEGRATION – CHECK MAILBOX Received a query from the PBX in response to check if there is a mailbox associated with an extension. Used with Matra PBX integration only.
309	INTEGRATION – MAILBOX EXISTS REPLY Replied “YES” to the PBX in response to the query to check the existence of the mailbox associated with an extension. Used with Matra PBX integration only.
310	INTEGRATION – MAILBOX DOES NOT EXIST REPLY Replied “NO” to the PBX in response to the query to check the existence of the mailbox associated with an extension. Used with Matra PBX integration only.
311	INTEGRATION – LINK SUPERVISION REQUEST Received a query from the PBX to check if the message server is an authorized one. Used with Matra PBX integration only.
312	INTEGRATION – LINK SUPERVISION REPLY Replied “YES” to the PBX in response to the query to check if the message server is an authorized one. Used with Matra PBX integration only.

Figure 8-1 represents the Traffic Peg Count Table. In the representation, names are used. In the actual table, the number of occurrences appears.

	0	1	2	3	4	5	6	7	8	9
00	■	NUM CALLS	QUICK MSG	MSG CREATE	LISTEN	LAST	DIST MSG	SAVE	ERASE	LOGON
10	EXIT	ALRDY LOGON	ERROR DROP	NO DIAL	MSG AFT CALL	VPERR	NEW	FOWRD	REPLY	VOLUME
20	RETURN ATO ATN	TIME	MULTI ADDR	MSG DELETE	SEC ALL BSY	MSG WT COLID	MSG WT CALL	TOO SHORT	J	IMMED CALL
30	BACKUP LISTEN	BACKUP RECORD	RELOAD COUNT	RESTART COUNT	BUSY CALLS	NO ANS CALLS	GREET PLAY	GREET RECORD	VACANT CALLS	UNAVAIL CALLS
40	ALARM CONFRM	ALARM ATTMPT	ALARM NO PORT	MSG WT NO PORT	MSG WT VACANT	CALLS PLACED	CALLS ANSWRD	ATN XFR DIAL 0	ATN XFR BY TMO	ALT NO DIAL TN
50	BROAD CAST	RESET INTEGR	RESET INTEGR	RESET INTEGR	RESET INTEGR	RESET INTEGR	RESET INTEGR	RESET INTEGR	RESET INTEGR	■
60	■	■	■	■	■	■	■	MSGND FAILED	CALLS PLACED BY WORKS	CALLS TO AP ERRORS MBX
70	SUBSEQ CALLS	MSG WT BUSY	MSG WT NO ANS	MSG WT ANSWER	NAME RECORD	EXTND FAILED	OFFSITE SETUP	MW GOT CX PORT	NET SND ATTMPT	NET SND SUCCESS
80	NET SND COLLID	DOWNLD CODE	DOWNLD CODE	DOWNLD CODE	DOWNLD CODE	DOWNLD CODE	DOWNLD CODE	DOWNLD CODE	DOWNLD CODE	■

Figure 8-1 Traffic Peg Count Table ■ = Not Used

	0	1	2	3	4	5	6	7	8	9
90	■	■	■	■	■	■	■	NET DIG LOST	AIC GOT CX PORT	POWER FAILURE
100	NET SND BUSY	IMMED INTCP	RNA INTCP	BUSY INTCP	ERROR INTCP	INVALID BUS MSG	RQST CODE	RQST TABLES	RQST IMMED	DID/E&M ERROR
110	DUPLI FOUND	BUS IN MSGS	BUS OUT MSGS	NET RCV DSK FUL	NET REV LONG	NET RCV SIL LIM	NET REV BUSY	OFF MW CALLS	OFF MW ANSWER	OFF MW SPK LIM
120	OFF MW PRE FAIL	NET QUA ATTEMPT	NET QUA FAIL	NET QUA LOW SIG	NET QUA LOW S/N	MSG WT LAMP	LN DROP EVENT	INITIAL DIAL 0	SUBSEQ DIAL 0	INITIAL DIG DIAL
130	SUBSQ DIG DIAL	INITIAL DIAL #	SUBSEQ DIAL #	INITIAL DIAL *	SUBSEQ DIAL *	CALLER WAS NET	CALLER WAS DID/E&M	CALLER XFR TO NET	INL DFLT INTCP	SUB DEF INTCP
140	INL LFT MESSAGE	SUB LFT MESSAGE	MSG AFT GREETING	MSG RCV FRM NET	NORMAL GRT PLA	MSG CRE NOT SENT	PARTL EXTENS	■	■	■
150	NUM CTY DOWN	■	RS232 MW ON	RS232 MW OFF	RS232 INFO	RS232 UNKNWN	INTG BUSY FWD	INTG RNA FWD	INTG ALL FWD	INTG DIRECT
160	INTG NO CALL REC	XFR PA	PA UNAVAIL	NO PRT AVAIL	PORT STATUS CONFLICT	RESET INTEGR	■	PDL BAD ADDR	MW ON	MW OFF
170	REPLY ADDR	MSG PRIV	FUTURE DELIV	NAME DIR USED	PDL USED	NET P2 ATTEMPT	NET P2 SUCCESS	■	■	■
180	■	■	■	■	AP LINK LOST	ATTRI 66 INCOMING CALL	■	■	■	■
190	INTG PBX RST	INTG RECCALL	INTG FWDFRC	INTG UNK FMT	INTG PRE END	INTG BAD FDG	INTG DIG NOM	TODO-Q FULL	APLINK DECFUL	■
200	■	■	NET P4 ATTEMPT	NET P4 SUCCESS	NO LOOPC	MSGS ALLFWD	MSG BY LOGGED	MSGS OTHER	INVAL USRLOG	INVAL TERMLOG
210	MSG BUSY	MSG FAX	URGENT MSGS	TOO FEW FAX CH	FAXES PRINTED	FAXES PRINTED VIA ATT 84	FAXES FAILED TO PRINT	QUICK FAX USED	FAX CHANNELS BUSY	USER HELP
220	USER DIAL EXT	LOGON FAIL XFER	USER REC ANN	USER REC MBMSG	COS OVERRIDE	USER ACT EAG	MSG BLCK BY EAG	DIGNET SND SUCESS	DIGNET RECD SUCCESS	DIGNET NETNAM RECD
230	RTIME NAM	MSG SENT VBLOCKS	MSG RECD VBLOCKS	1/2 LAN CH BUSY	3/4 LAN CH BUSY	ALL LAN CH BUSY	LAN CH SEND MSGS	LAN CH REC MSGS	LAN CH OUTCONCT	LAN CH REJEC OUT
240	LAN CH NOT AVAIL	LAN CH INCOM	LAN CH IN REJECTS	LAN CH INCOM REJECTS	MAX RTIME NME PLAY	RTIME QUERY	MSG QUERY	SGL LOC QUERY	RTIME BRDCAST QUERY	BAKGRND BRDCAST QUERY
250	DNET SND REJECTED DSK FULL	DNET RCD REJECTED DISKFULL	DNET CHCKSUM ERROR	TIME SYS UP	TIME LAN UP	RTIM NAM RCHD LIMIT	RTIM NAM PLY ERROR	RTIME EXT QUERY	LAN RQST Q FULL	NET REC_DTMF
260	NET NAME FAIL	ON MSG SND ATT	ON MSG SENT	ON MSG RCV ATT	ON MSG RCVD	ON > 10 CLONE	ON DIF CLONE	ON FULL SYS MBX	ON LOK MBX ATT	ON LOK MBX OK
270	ON MSG LONG	ON FAX SND ATT	ON FAX SENT	ON FAX RCV ATT	ON FAX RCVD	ON SPOK SND ATT	ON SPOK SENT	ON SPOK RCV ATT	ON SPOK RCVD	ON ASCI SND ATT
280	ON ASCI SENT	ON ASCI RCV ATT	ON ASCI RCVD	LAN SND FAX SUC	LAN RCV FAX SUC	OFF/MW END DIG	■	■	■	■

Figure 8-1 Traffic Peg Count Table ■ = Not Used

	0	1	2	3	4	5	6	7	8	9
290	GWL – LOGON	GWL LOGOFF	GWL ALONE	GWL NOT CLMD	GWL # SESSIONS	GWL OUTCALLS	GWL FAX DLVD	GWL FAX MSG FRM MS TO GATEWAY	GWL VOICE MSG FRM MS TO GATEWAY	GWL FAX MSG FRM GATEWAY TO MS
300	GWL VOICE MSG FRM GATWEAY TO MS	GWL FTP REQUEST REJECTED	■	■	■	■	■	INTEG TRANSFER–	INTEGR CHECK MBX	INTEGR MBX EXISTS REPLY
310	INT MBX NOT EXIST REPLY	INT LINK SUPERVISE REQUEST	INT LINK SUPERVISE REPLY	■	■	■	■	■	■	■

Figure 8-1 Traffic Peg Count Table

■ = Not Used

HARDWARE REPLACEMENT

Chapter Contents

9.1	Hardware Maintenance and Diagrams	9-1
	Preventive Maintenance	9-1
	Octel Overture 200 Diagrams	9-2
	Octel Overture 300 Diagrams	9-7
9.2	Hardware Replacement Guidelines	9-12
	Printed Circuit Assembly (PCA) Replacement	9-12
	Line Interface Card Replacement	9-14
	Integration Card Replacement	9-15
	Local Area Network (LAN) Card Replacement	9-17
	DTIC Replacement	9-19
	Fax Application Processor Replacement	9-24
	Hard-Disk-Drive Replacement	9-25
	Octel Overture 300 Floppy-Disk-Drive Replacement	9-28
	Power Supply Unit Replacement	9-30
	Octel Overture 200 Fan Panel Assembly	9-33
	Octel Overture 300 Fan Tray Replacement	9-34
	Air Filter Cleaning	9-35
	Motherboard Assembly	9-36
	Octel Overture 300 Disk-Drive Backplane Replacement	9-46
	Octel Overture 300 Load Resistor Assembly Replacement	9-48
	Octel Overture 300 Power-Filter Assembly	9-50
	AC-to-DC Power-Supply Conversion	9-51
	Option Control Chip Replacement	9-53
9.3	Message Server Assembly Descriptions and Part Numbers	9-56
	Octel Overture 200 Assemblies	9-56
	Octel Overture 300 Assemblies	9-56
	Octel Overture 200/300 Assemblies	9-57

HARDWARE REPLACEMENT

Figures

9-1	Shelf Structure in the Octel Overture 200	9-3
9-2	Inside Front View of Octel Overture 200	9-4
9-3	Octel Overture 200 Cabinet Rear View	9-5
9-4	Inside Rear View of Octel Overture 200	9-6
9-5	Shelf Structure of Octel Overture 300	9-8
9-6	Inside Front View of Octel Overture 300	9-9
9-7	Rear View of Octel Overture 300	9-10
9-8	Inside Rear View of Octel Overture 300	9-11
9-9	Card Cage Showing a Printed Circuit Assembly and an Option Control Chip	9-13
9-10	LED Placement on the LAN Card	9-18
9-11	DTIC–E1 Kit Installation for the Octel Overture 200	9-22
9-12	DTIC–E1 Kit Installation for the Octel Overture 300	9-22
9-13	Fax Application Processor	9-23
9-14	120–ohm DTIC–E1 Adapter	9-23
9-15	Fax Application Processor Replacement	9-24
9-16	Octel Overture 200 Hard-Disk-Drive Assembly	9-26
9-17	Octel Overture 300 Hard-Disk-Drive Assembly	9-26
9-18	Octel Overture 300 Floppy-Disk-Drive Assembly	9-28
9-19	Octel Overture 200 Power Supply Unit	9-30
9-20	Octel Overture 300 Power Supply Assembly	9-31
9-21	Motherboard Assembly	9-36
9-22	A.C. Backplane Power Harness Installation for Octel Overture 200	9-41
9-23	D.C. Backplane Power Harness Installation for Octel Overture 200	9-42
9-24	Power-Filter Assembly for 120-Vac and 240-Vac Domestic Octel Overture 300	9-43
9-25	Power-Filter Assembly for 240-Vac International Octel Overture 300	9-44
9-26	Power-Filter Assembly for 48-Vdc Octel Overture 300	9-45
9-27	Octel Overture 300 Disk-Drive Backplanes	9-46
9-28	Cutaway View of the Load-Resistor Assembly	9-48
9-29	Field Wiring for –48-Vdc Powered Octel Overture 300	9-51
9-30	Option Control Chip (OCC) Assembly	9-54
9-31	Location of Option Control Chip (OCC) in the Octel Overture 200/300	9-54

9.1 HARDWARE MAINTENANCE AND DIAGRAMS

This chapter provides details for preventive maintenance of the Octel Overture™ 200/300 and procedures for hardware replacement. It also provides a list of message server components and their part numbers. To assist with the procedures, diagrams of the Octel Overture 200 and Octel Overture 300 are shown.

Preventive Maintenance

Preventive maintenance consists of cleaning the air filter, periodic visual inspection of fan operation, and listing the System Performance Tables. The frequency of this maintenance depends on the operating environment provided for the Octel Overture 200/300. Based on the environment, the local service company should determine the maintenance interval required.



Use of an antistatic wrist grounding strap prevents damage to sensitive electronic components. Before handling any electronic equipment, including the Power Supply Unit and cables, fasten one end of the strap around your wrist and the other end to any unpainted metal surface of the Octel Overture 200/300 inner cabinet.

Air Filter

Clean the air filter regularly (every 3 to 4 months) to prevent restricted air flow. Server overheating from reduced air flow is a common source of alarm calls. Refer to the Air Filter Cleaning section in this chapter for air-filter removal and replacement procedures.

Fans

Inspect the fans for operation at least once a year. To check the fans, perform the following:

1. Unlock and open the door of the server.
2. For the Octel Overture 200, view the two fans at the rear of the message server and observe whether they are spinning. (A flashlight will assist in this observation.) If one or more fans are not spinning, replace the fan assembly as instructed in the Octel Overture 200 Fan Panel Assembly section, in this chapter.

For the Octel Overture 300, view the four fans through the card cage at shelf A and observe whether they are spinning. (A flashlight will assist in this observation.) If one or more fans are not spinning, replace the fan tray as instructed in the Octel Overture 300 Fan Tray Replacement section, in this chapter.

3. Close and lock the front door of the server.

Power Supply Output

Check voltages using a digital volt meter. Refer to the Installation chapter, Octel Overture 200/300 Hardware Installation section, in this volume.

Preventive Maintenance Tools and Equipment

The tools and equipment required to perform preventive maintenance tasks on the Octel Overture 200/300 are as follows:

- Antistatic wrist strap
- Digital volt/ohm meter
- RS-232C-compatible ASCII send/receive terminal capable of 300, 1200, or 9600 baud. Refer to the Installation chapter, Terminal Communications section, in this manual.
- Three standard, touch-tone telephones
- Telephone test set (butt set)
- Large, flat-bladed screwdriver
- No. 1 Phillips screwdriver
- IC puller
- Breakout box
- Digit grabber
- Flashlight

Octel Overture 200 Diagrams

Use the following Octel Overture 200 diagrams to provide assistance when performing preventive maintenance or replacing components. Figure 9-1 shows the Octel Overture 200 shelf structure. Figure 9-2 through Figure 9-4 illustrate the front, rear, and inside views of the Octel Overture 200 server.

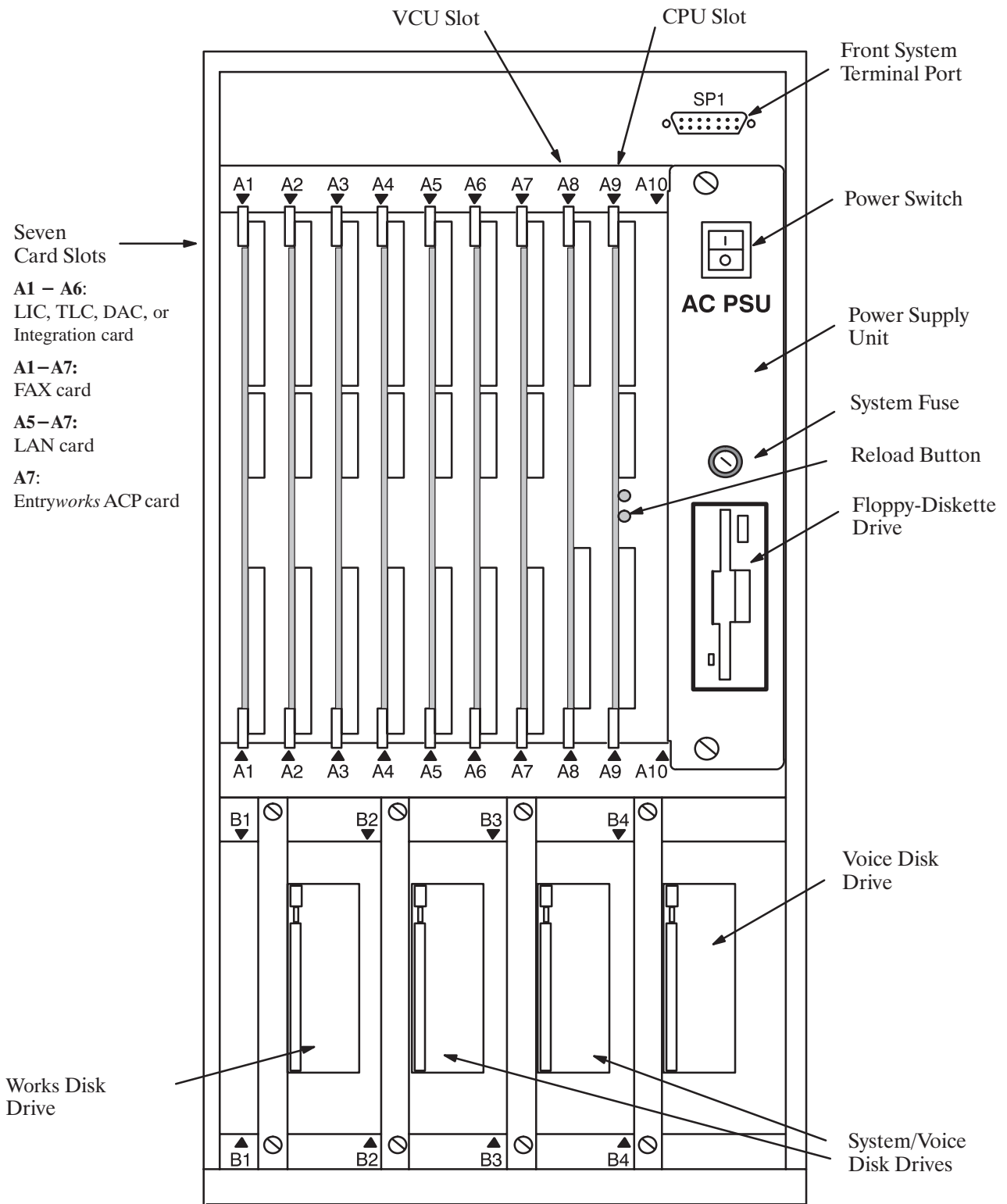

Figure 9-1 Shelf Structure in the Octel Overture 200

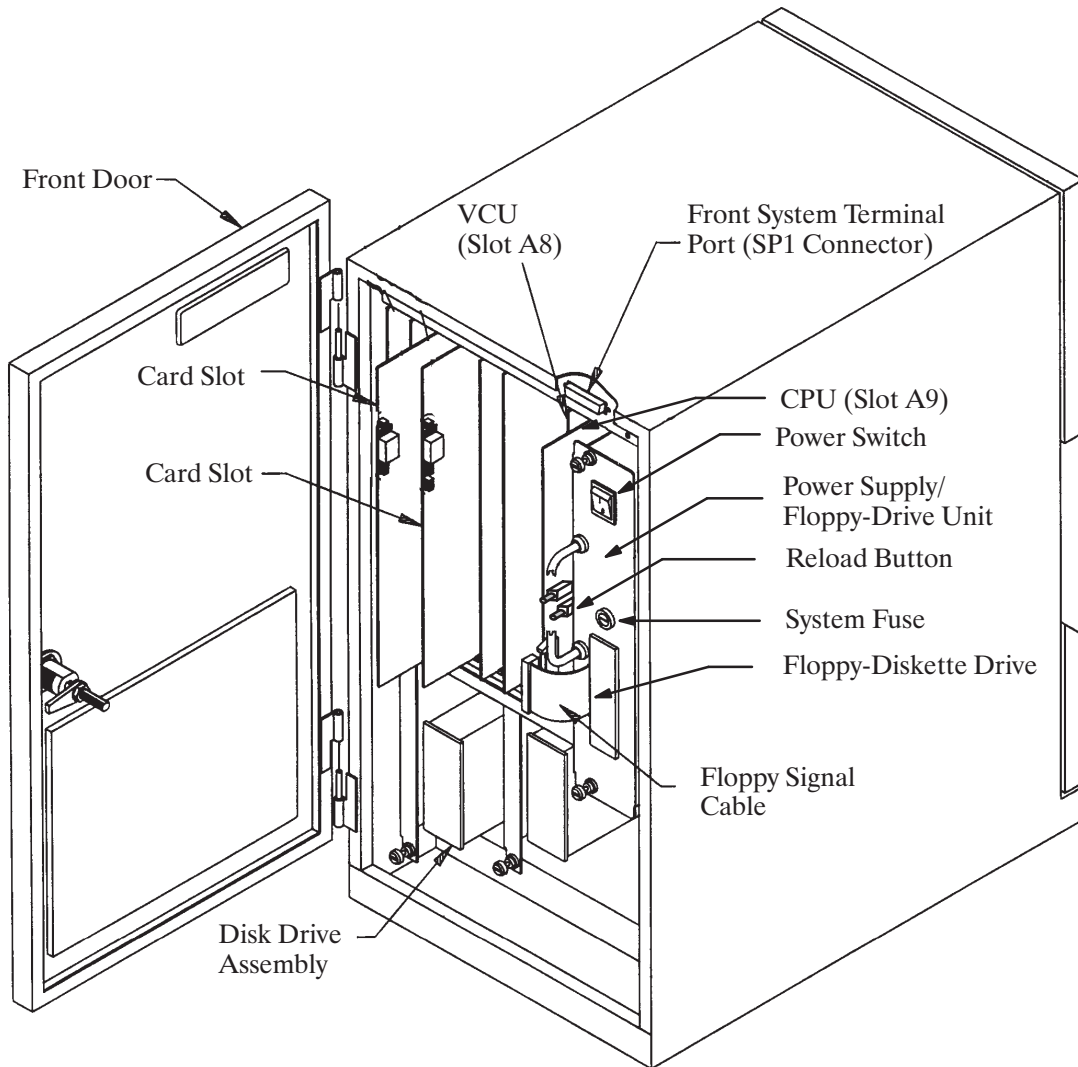

Figure 9-2 Inside Front View of Octel Overture 200

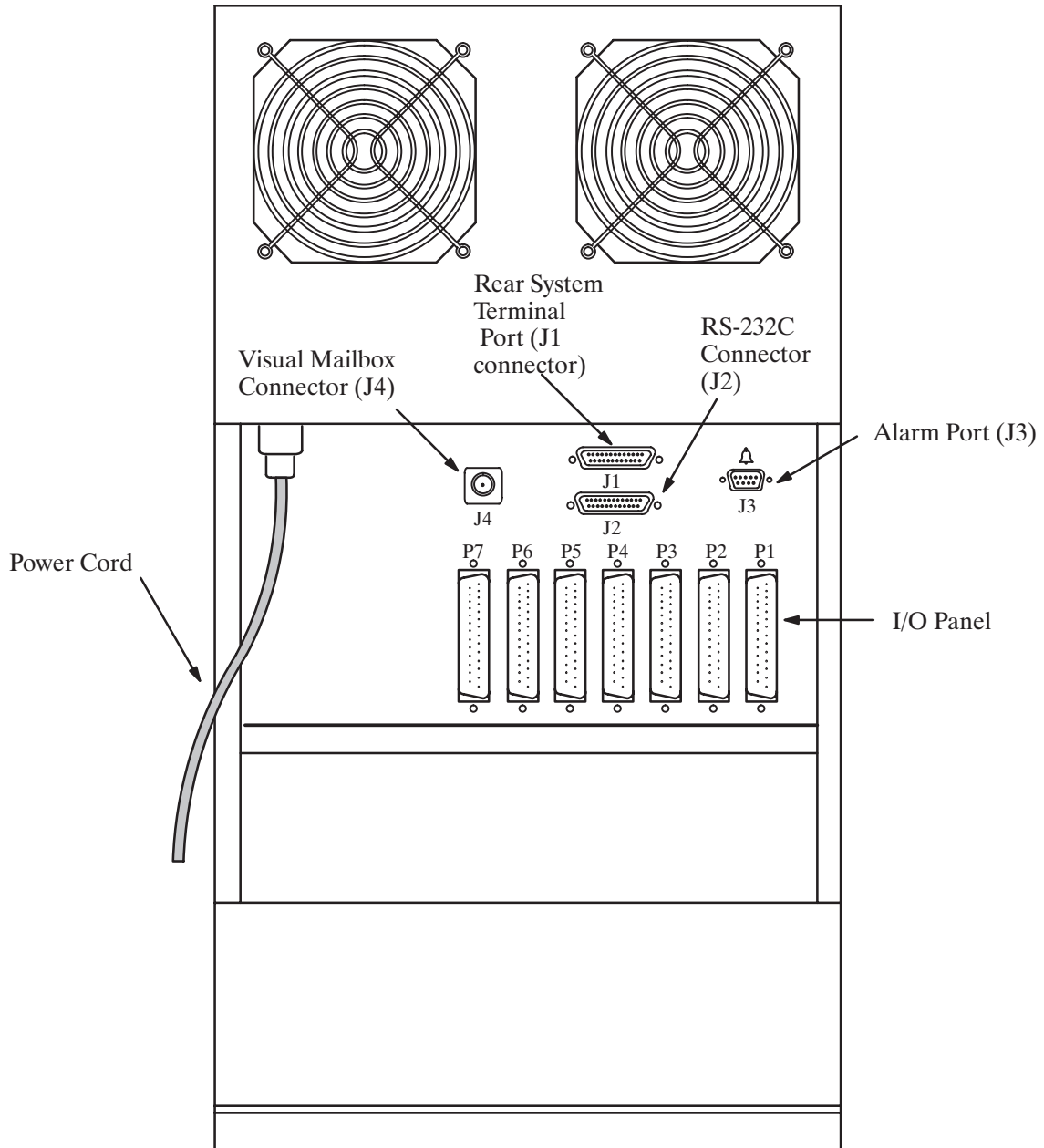

Figure 9-3 Octel Overture 200 Cabinet Rear View

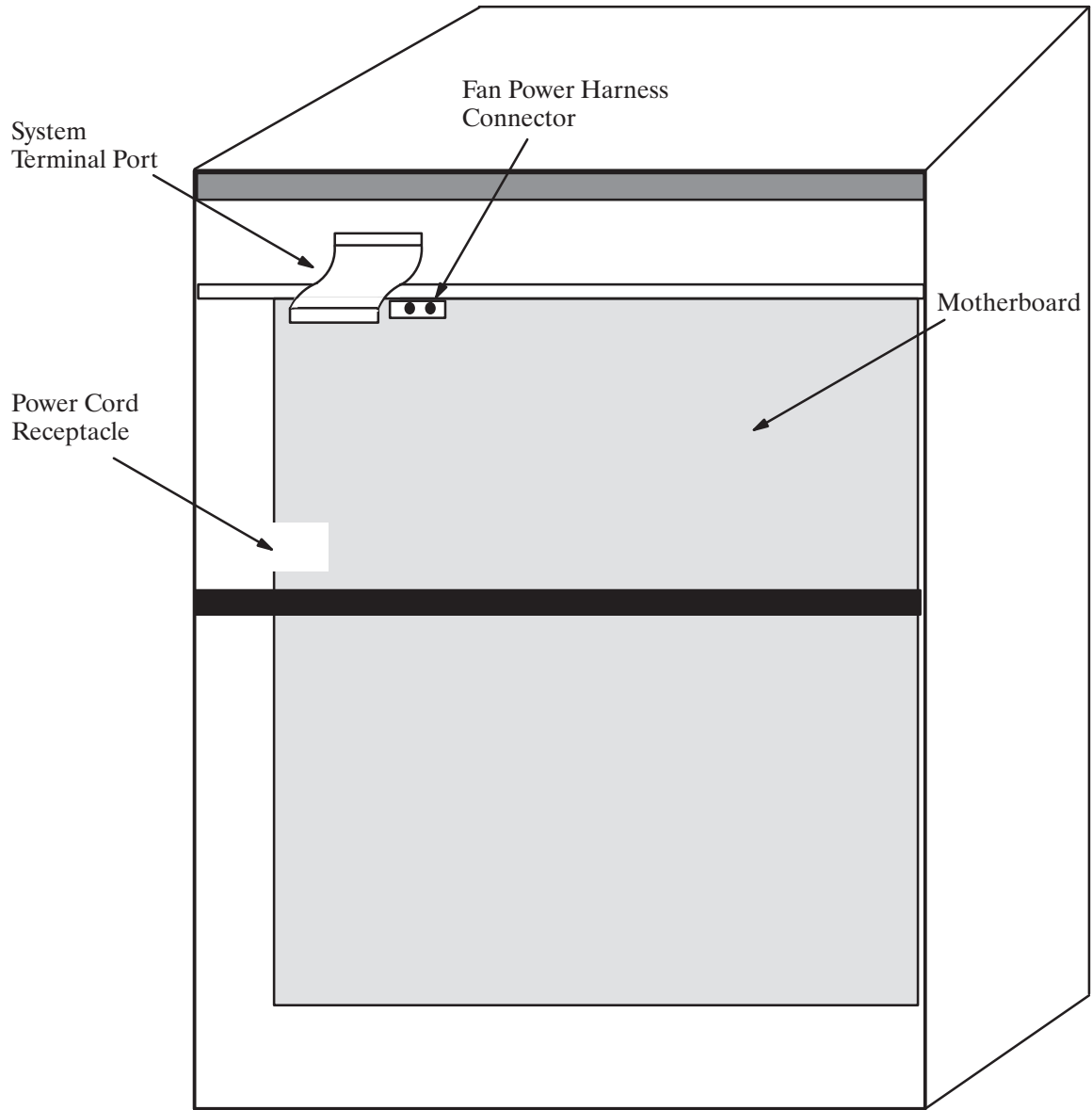

Figure 9-4 Inside Rear View of Octel Overture 200

Octel Overture 300 Diagrams

Use the following Octel Overture 300 diagrams to provide assistance when performing preventive maintenance or replacing components. Figure 9-5 shows the Octel Overture 300 shelf structure. Figure 9-6 through Figure 9-8 illustrate the front, rear, and inside views of the Octel Overture 300 server.

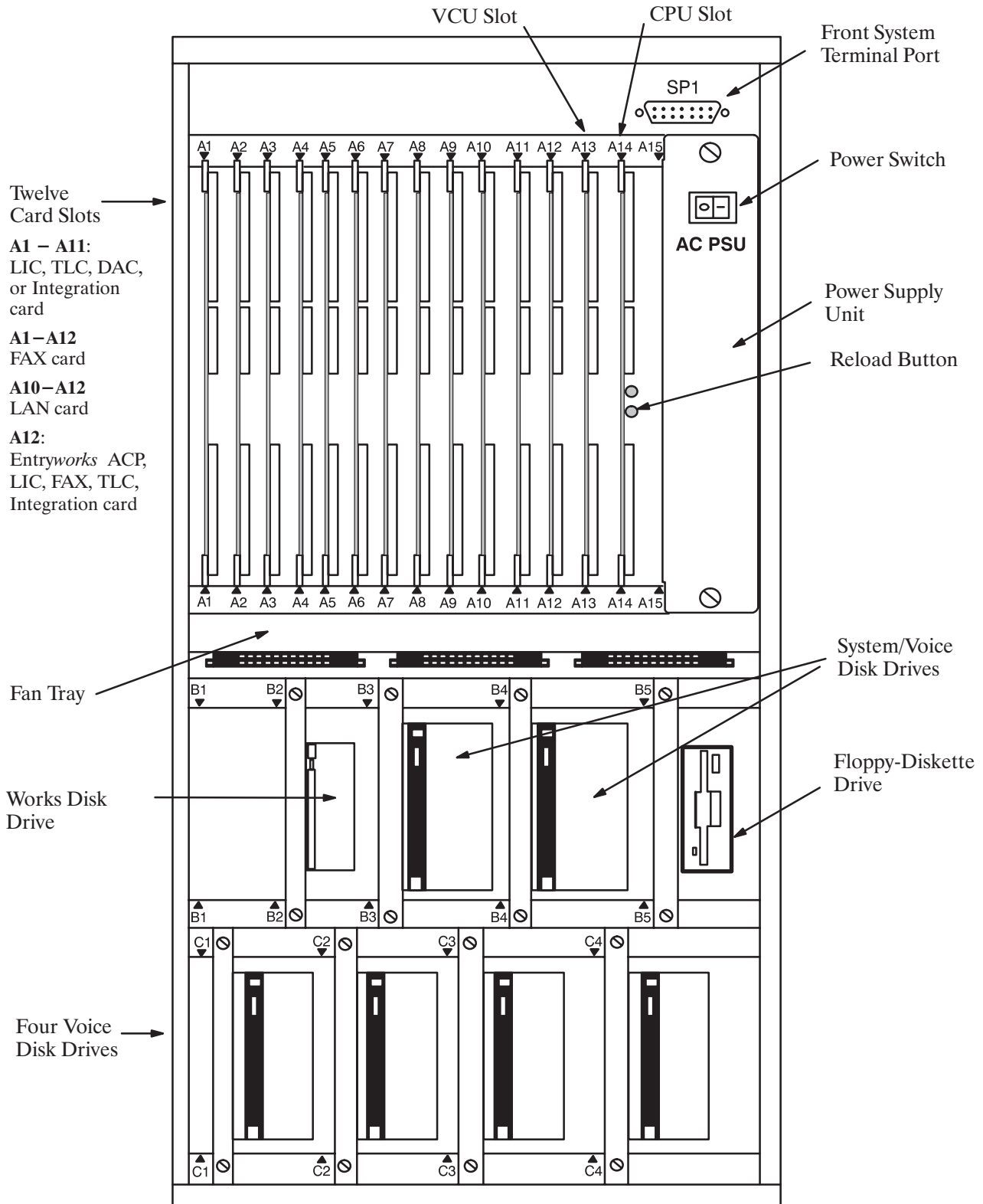

Figure 9-5 Shelf Structure of Octel Overture 300

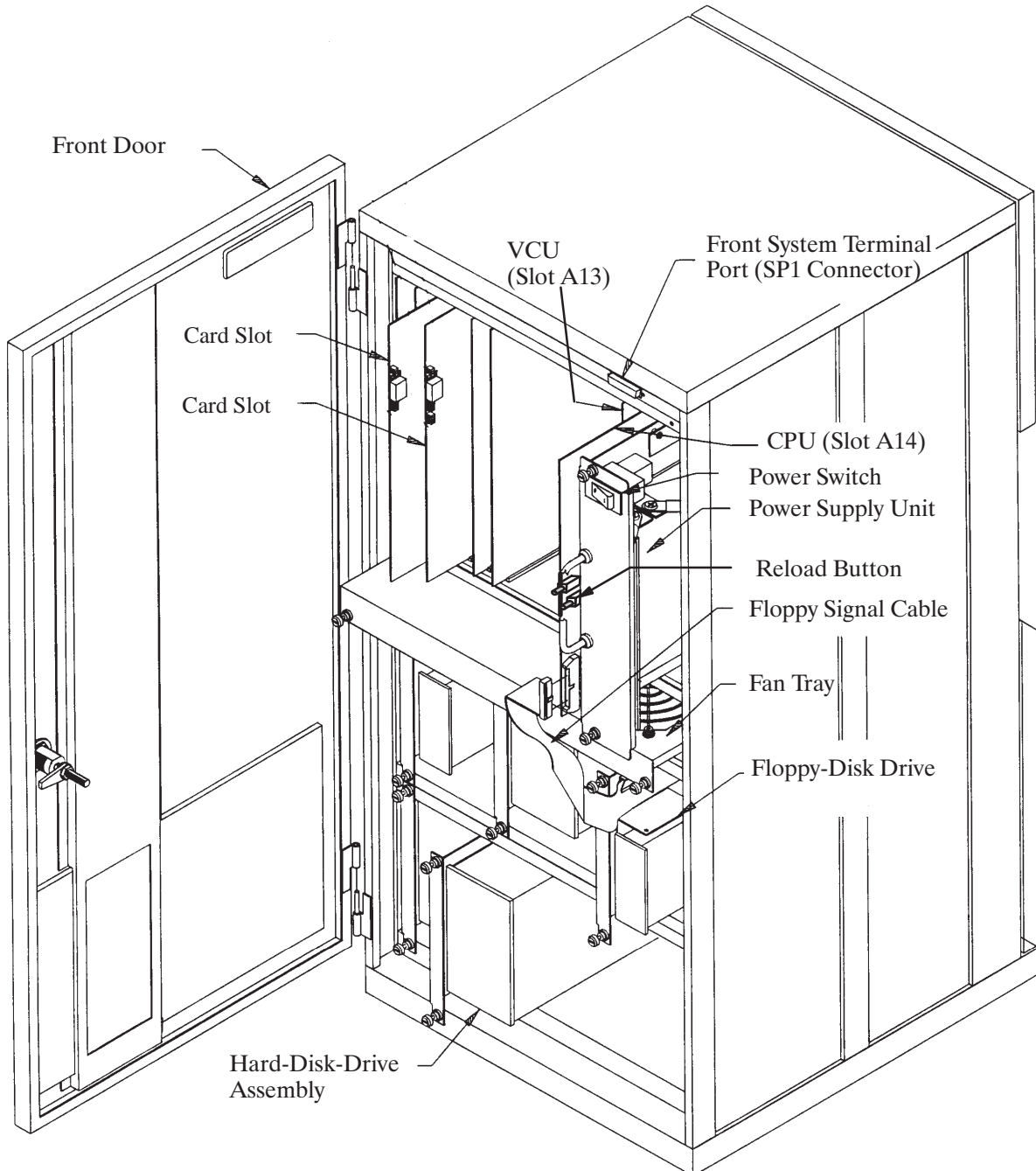

Figure 9-6 Inside Front View of Octel Overture 300

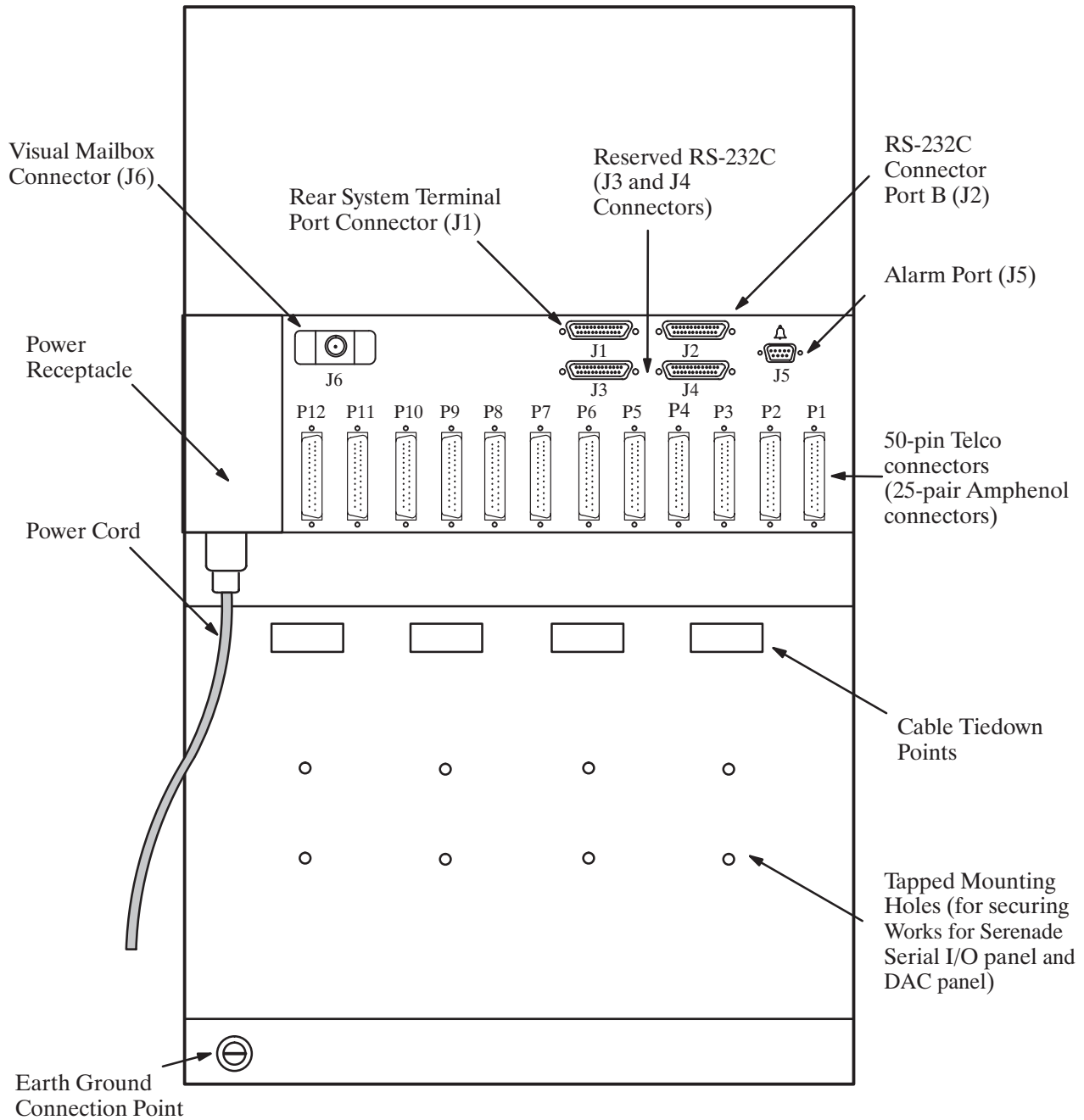

Figure 9-7 Rear View of Octel Overture 300

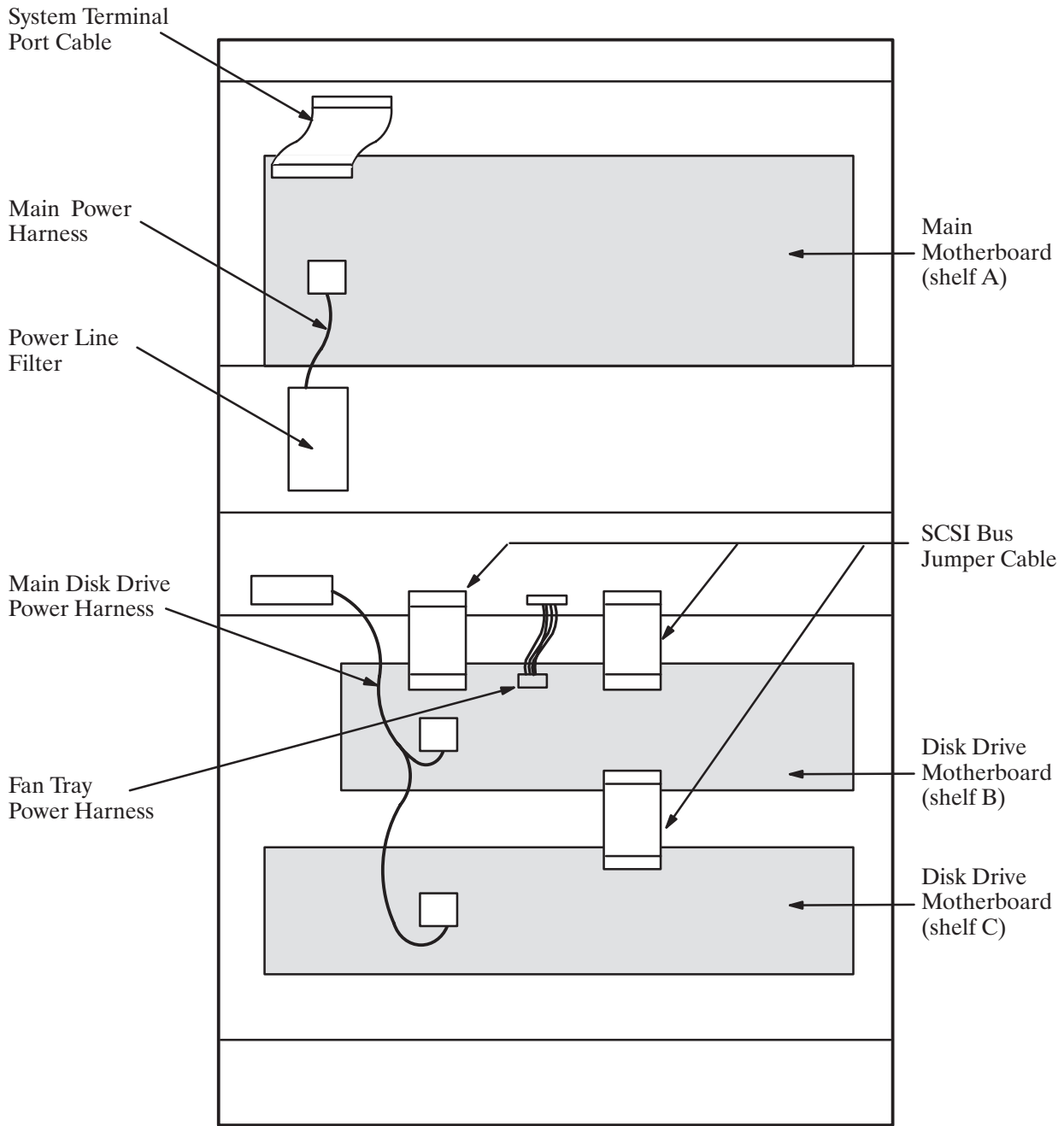



Figure 9-8 Inside Rear View of Octel Overture 300

9.2 HARDWARE REPLACEMENT GUIDELINES

You can safely replace subassemblies in Octel Overture 200 or Octel Overture 300 message servers by following the procedures in succeeding sections. None of the subassemblies contain replaceable components; replacing, attempting to replace, or modifying any component of a subassembly voids all warranties. Octel can replace an assembly with an equivalent assembly.

To install or replace a CPU, a VCU, floppy-disk drives, or the power supply unit, the power to the message server must be turned OFF. Refer to the Power Supply Unit section in this chapter for details about turning OFF power to the cabinet. Hard-disk drives, line interface cards, integration cards, LAN cards, and fax application processors can be replaced when the power is ON.

 The message server must be restarted if a line interface card, integration card, or fax application processor is added or if the replacement card is not the same as the card removed. Refer to the Hard-Disk-Drive Replacement section in this chapter for considerations regarding hot plug replacement of disk drives.

When replacing or installing subassemblies in an Octel Overture 200/300 cabinet, use the following guidelines:

- Close and lock the cabinet door when not working on the cabinet. The door should not be left open for more than 1 hour at a time.
- Always wear an antistatic wrist strap before handling **any** parts.



To avoid damaging electronic assemblies, wear an antistatic wrist strap. Put on the strap **before** a component is removed from its static bag. Wrap one end around your wrist and attach the other end to an unpainted part of the cabinet. The Octel Overture 200/300 must be plugged into a grounded outlet. Wear the strap during the entire replacement procedure.

Printed Circuit Assembly (PCA) Replacement

Use this procedure to replace the following PCAs:

- Voice control units (VCU)
- Central processing units (CPU)

To replace line interface cards (LIC), refer to the Line Interface Card Replacement section in this chapter. To replace integration cards, refer to the Integration Card Replacement section in this chapter.



Printed circuit assemblies, as well as other assemblies in the Octel Overture 200/300, contain static-sensitive components. The human body can easily store enough static electricity to damage a PCA. To avoid discharging this energy to electronic assemblies, **always** wear an antistatic wrist strap when handling assemblies.

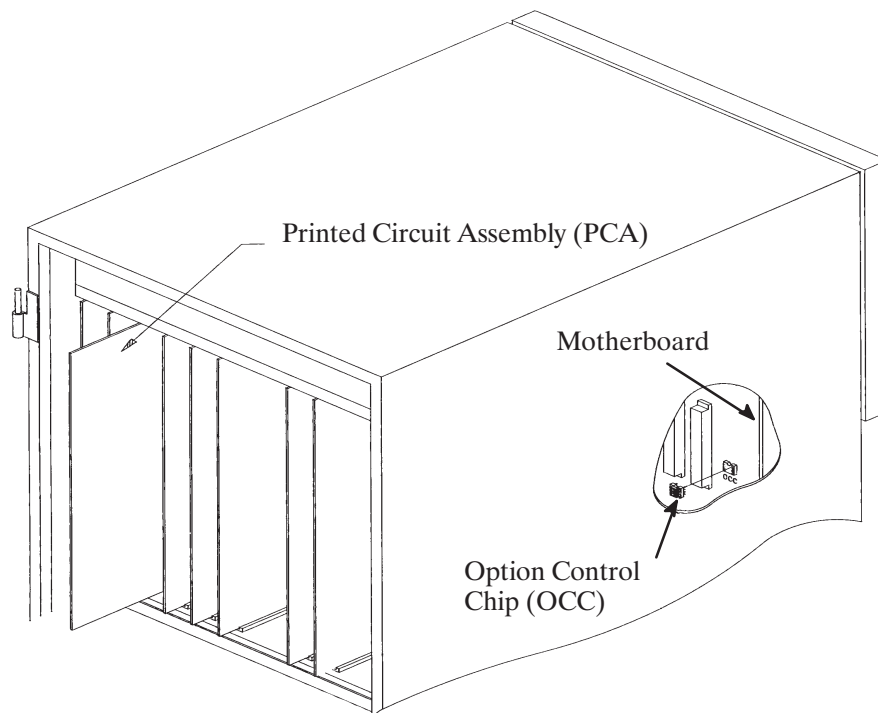



Figure 9-9 Card Cage Showing a Printed Circuit Assembly and an Option Control Chip

- Replacing a PCA

Use the following procedure to replace a VCU or CPU:

1. Unlock and open the door of the cabinet.
2. Put on an antistatic wrist strap. Connect it to an unpainted portion of the cabinet.
3. Switch OFF the power supply unit.
4. Disengage the PCA from the motherboard by pivoting the plastic card ejectors at the top and bottom of the PCA front edge.
5. Slide the PCA out of card cage.

 Handle the PCA **only** by the top and bottom edges. **Do not** touch the components on the PCA.

6. Store the removed PCA in a static protection bag.
7. Remove the replacement PCA from its static protection bag.
8. While holding the top and bottom edges of the replacement PCA, slide it into the card cage. Check that the card slides in the plastic card guides to ensure correct insertion.
9. Pivot the card ejectors, as needed, to grip the small flanges on the front edges of the card cage.
10. Firmly seat the PCA connectors into the motherboard by pressing the ejectors against the front edge of the PCA. The ejectors will clip onto small pins on the PCA when the connectors are seated.



Caution!

Do not slam the PCA into the cabinet, as this could damage the board or the motherboard connectors.

11. Switch ON the power supply unit.
12. Test the message server for correct operation.
13. Close and lock the door to the cabinet.

Line Interface Card Replacement

The Octel Overture 200/300 line interface cards (4- and 8-port LIC, ILC12, and DLC16) installed in shelf A are designed to be hot plugged; that is, the message server does not need to be turned OFF to remove or install the cards.

- ☞ The message server must be restarted if a line interface card is added or if the replacement card is not the same as the card removed.



Caution!

No more than one line card at a time can be removed or installed with the power ON; the ports must be forwarded before removing the line card.

Removing Line Cards

Use the following procedure to remove a line card:

1. Unlock and open the door of the cabinet.
2. Put on an antistatic wrist strap. Connect it to an unpainted portion of the cabinet.
3. Forward the Octel Overture 200/300 ports being replaced.

To forward ports, at the @ prompt, type

```
CD x y z
```

In this command, x is the slot, y is the first port in the card, and z is the last port in the card.

- ☞ You can also use the command `TE C 1 x y` to forward the ports.

4. Disengage the line card from the motherboard by pivoting the plastic card ejectors at the top and bottom of the front edge of the line card.
5. Slide the line card out of the card cage.

- ☞ Handle the line card **only** by the top and bottom edges. **Do not** touch any components on the line card.

6. Store the removed line card in a static protection bag.

Installing Line Cards

Use the following procedure to install a line card:

1. Put on an antistatic wrist strap. Connect it to an unpainted portion of the cabinet.
2. While holding the top and bottom edges of the card, slide it into the card cage.
3. Pivot the card ejectors, as needed, to grip the small flanges on the front edges of the card cage.
4. Firmly seat the line card connectors into the motherboard by pressing the ejectors against the front edge of the line card. The ejectors will clip onto small pins on the line card when the connectors are seated.



Caution!

Do not slam the line card into the cabinet, as this could damage the board or motherboard connectors.

Once the line card is installed, the red LED comes ON. When self-test diagnostics are complete, the green LED comes ON. When the card has been initialized and is ready for operation, the red LED goes OFF.

5. Initialize the ports, by typing

```
CU x y z
```

In this command, x is the slot, y is the first port in the card, and z is the last port in the card.

 You can also use the command `TE C 2 x y` to initialize the ports.

6. Test the message server for correct operation.
7. Close and lock the door to the cabinet.

Integration Card Replacement

The Octel Overture 200/300 integration cards installed in shelf A are designed to be hot plugged; that is, the message server does not need to be turned OFF to remove or install the cards.

 The message server must be restarted if an integration card is added or if the replacement card is not the same as the card removed.



Caution!

No more than one integration card at a time can be removed or installed with the power ON.

Removing Integration Cards

Use the following procedure to replace an integration card:

1. Unlock and open the door of the cabinet.
2. Put on an antistatic wrist strap. Connect it to an unpainted portion of the cabinet.
3. Use the Courtesy Down command to take the integration card out of service. At the @ prompt, type

```
CD x y
```

In this command, *x* is the slot number, and *y* is the unit number.

4. Disengage the integration card from the motherboard by pivoting the plastic card ejectors at the top and bottom front edge of the card.
5. Slide the integration card out of the card cage, handling the card only by the top and bottom edges.

 **Do not** touch the components on the card.

6. Store the removed integration card in a static protection bag.

Installing Integration Cards

Use the following procedure to install an integration card:

1. Put on an antistatic wrist strap. Connect it to an unpainted portion of the cabinet.
2. While holding the top and bottom edges of the card, slide it into the card cage.
3. Pivot the card ejectors, as needed, to grip the small flanges on the front edges of the card cage.
4. Firmly seat the integration card connectors into the motherboard by pressing the ejectors against the front edge of the card. The ejector will clip onto small pins on the integration card when the connectors are seated.



Caution!

Do not slam the integration card into the cabinet, as this could damage the board or motherboard connectors.

Once the integration card is installed, the red LED comes ON. When self-test diagnostics are complete, the green LED comes ON. When the card has been initialized and is ready for operation, the red LED goes OFF (less than 5 minutes).

5. Use the Courtesy Up command to initialize the integration card. At the @ prompt, type

```
CU x y
```

In this command, *x* is the slot number, and *y* is the unit number.

If there are two units, make sure to initialize both units.

Repeat this step for unit 2.

6. Test the message server for correct operation.
7. Close and lock the door to the cabinet.

Local Area Network (LAN) Card Replacement

The LAN card installed in shelf A is designed to be hot plugged; that is, the message server does not need to be turned OFF to remove or install the card.

Only one LAN card can be installed in an Octel Overture 200/300 message server. The LAN card can be installed in the following locations:

- Slots A5 through A7 for the Octel Overture 200
- Slots A10 through A12 for the Octel Overture 300

Removing a LAN Card

Use the following procedure to remove a LAN card:

1. Before servicing a LAN card, use the Courtesy Down command to take the LAN card out of service. At the @ prompt, type

```
CD x 
```

In this command, x is the slot number.

2. Unlock and open the door of the cabinet.
3. Put on an antistatic wrist strap. Connect it to an unpainted portion of the cabinet.
4. Disengage the LAN card from the motherboard by pivoting the plastic card ejectors on the top and bottom front edge of the LAN card.
5. Slide the LAN card out of the card cage.

 Handle the LAN card only by the top and bottom edges. **Do not** touch components on the LAN card.

6. Store the removed LAN card in a static protection bag.

Installing a LAN Card

Use the following procedure to install a LAN card:

1. Put on an antistatic wrist strap. Connect it to an unpainted portion of the cabinet.
2. While holding the top and bottom edges of the LAN card, slide it into the card cage.
3. Pivot the card ejectors, as needed, to grip the small flanges on the front edges of the card cage.
4. Firmly seat the LAN card connectors into the motherboard by pressing the ejectors against the front edge of the LAN card. The ejectors will clip onto small pins on the LAN card when the connectors are seated.



Caution!

Do not slam the LAN card into the cabinet, as this could damage the board or motherboard connectors.

5. Install the 10BaseT, RJ45 adapter on the back of the cabinet, for the slot in which the LAN card is being installed.
6. After servicing the LAN card, use the Courtesy Up command to put the card into service. At the @ prompt, type

CU x

In this command, x is the slot number.

7. Test the message server for correct operation.
8. Close and lock the door to the cabinet.

Figure 9-10 shows the eight LEDs on the front edge of the LAN card.

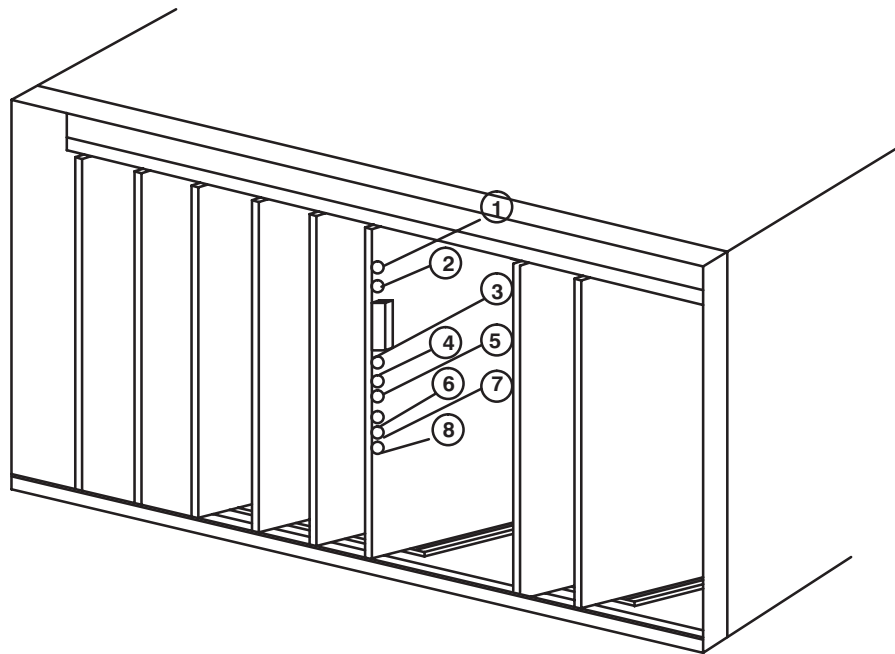

Figure 9-10 LED Placement on the LAN Card

Once the LAN card is installed, the LEDs on the LAN card are activated, as follows:

LED Number	LED Description	LED Color	LED Activity
1	Standard use	Red	Lit when the LAN card is installed. Goes off when the card has been initialized and is ready for operation.
2	Standard use	Green	Lit when self-test diagnostics are complete.
3	Development	Yellow	Used only for development.
4	Good link indicator	Yellow	Lit when the adapter and wiring to a hub are correct.
5	Rx polarity reversed	Yellow	Lit if the pair being received by the Ethernet controller needs to be reversed. Check the wiring.
6	Receive activity Indicator	Yellow	Lit when the Ethernet controller sees activity on the receive pair.
7	Transmit activity indicator	Yellow	Lit when the Ethernet controller sees activity on the transmit pair.
8	Collision Indicator	Yellow	Lit when a collision occurs. Collisions occur normally in Ethernet/802.3 networks, because it is part of the low layer protocol.

DTIC Replacement

The Digital Trunk Interface Cards (DTIC) installed in Shelf A are designed to be hot plugged; that is, the system does not need to be powered down to remove or install the cards.





Caution!

No more than one card at a time may be removed or installed with power ON.

Removing a DTIC Card

The procedure to replace a DTIC is as follows:

1. Unlock and open the door of the cabinet.
2. Put on antistatic wrist strap. Connect it to an unpainted portion of the cabinet.
 -  The ports cannot be forwarded.
3. Disengage the DTIC from the motherboard by pivoting the plastic card ejectors on the top and bottom of the line card front edge.
4. Slide the DTIC out of the card cage.
 -  Handle the DTIC only by the top and bottom edges. **Do not** touch components on the card.
5. Store removed card in a static protection bag.

Installing a DTIC Card

The procedure to install a DTIC is as follows:

☞ For a new installation, configure the SLOTS Table for the DTIC card before the card is installed.

1. Put on antistatic wrist strap. Connect it to an unpainted portion of the cabinet.
For a first-time installation, the DTIC-E1 kit must be installed. Follow steps 2 and 3, then follow the steps for either a 75-ohm or 120-ohm DTIC-E1 adapter installation. If this is not a new installation, go to step 5.
2. Remove two jack screws and washers securing the connector marked J2 (for the Octel Overture 200) or J4 (for the Octel Overture 300) to the I/O panel on the back of the system. Refer to Figure 9-11 for the Octel Overture 200 or Figure 9-12 for the Octel Overture 300.
3. Using two new jack screws provided with the kit and washers just removed, attach the grounding strip where shown in Figure 9-11 for the Octel Overture 200 or Figure 9-12 for the Octel Overture 300.
4. Install the DTIC adapter.

For 75-ohm DTIC-E1 installations:

- a. Connect the 75-ohm DTIC-E1 adapter, to the amphenol connector on the I/O panel corresponding to the DTIC card slot in the system card cage. Secure the velcro strap. Make sure that the adapter is completely seated.
- b. Secure the grounding screw on the top of the adapter to the grounding strip.
- c. Attach the customer-provided 75-ohm transmit and receive coax cables to the appropriate coax connectors on the adapter where shown in Figure 9-13. Go to step 5.

For 120-ohm DTIC-E1 installations:

- a. Prepare the customer-provided I/O cable as follows:
 - ❑ Cut the cable jacket so that the conductors protrude approximately 25mm (1 inch) from the end of the jacket.
 - ❑ Strip approximately 6mm (.25 inch) of insulation from the end of each conductor.
 - ❑ Cut the shield so that a 13 mm (.5 inch) length of shield foil or braid can be pulled back over the cable jacket.

☞ To pass regulatory requirements, shielded cable must be used.

- b. Connect the conductors from the I/O cable to the 120-ohm adapter s shown in Figure 9-14.
- c. Secure the jacket of the cable to the adapter using the clamp provided or remove the clamp and secure with a tie-wrap through 2 small rectangular cutouts. Make sure the clamp or tie wrap clamp-down around the shield that has been folded back around the cable jacket.
- d. Connect the adapter to the amphenol connector on the I/O panel corresponding to the DTIC-E1 card slot in the system card cage. Secure the velcro strap. Make sure the adapter is completely seated.
- e. Secure the grounding screw on the top of the adapter to the grounding strip. Go to step 5.
5. Check that the DTIC's SW1 and SW2 switches at the bottom right-hand corner of the card are set to the correct positions; 75-ohm or 120-ohm. these switches and their settings are marked on the card.
6. While holding top and bottom edges of the card, slide the DTIC into the card cage.

7. Pivot the card ejectors as needed to grip small flanges on the front edges of the card cage.
8. Firmly seat the DTIC connectors into the motherboard by pressing ejectors against the front edge of the card. The ejectors will clip onto small pins on the DTIC when the connectors have seated.



Caution!

No more than one card at a time may be removed or installed with power ON.

9. At the @ prompt, enter RESTA to restart the system. The information on the DTIC card is downloaded to the system and the DTIC becomes operational. If the card is being hot plugged, the system does not need to be restarted.

Once the DTIC is installed, the uppermost red LED comes ON. When selftest diagnostics are complete, the red LED remains ON and the uppermost green LED comes ON, indicating that the card is ready for application code download and initialization.

After a delay of 10 to 15 seconds, only the uppermost green LED remains lit, indicating normal operation of the DTIC application code. This green LED stays ON even if problems are detected with the E1 trunk or other aspects of initialization. However, if there are problems, the LEDs below the green power LED will light to indicate the nature of the problem. Otherwise, these other LEDs remain OFF. Refer to the following table for the LEDs and their meanings.

LED	Meaning
Red boot (top)	Apcode is initializing
Green Power	DTIC has power
Red 1 (top)	Loss of signal on trunk (LOS)
Red 2	Loss of frame on trunk (LOF)
Yellow 3	Remote alarm indication (RAI)
Yellow 4	“Other” trunk alarm
Yellow 5	Alarm history
Green 6 (bottom)	One or more channels off hook

10. Initialize ports by entering

```
CU x y z
```

where *x* is the slot, *y* is the first port in the card, and *z* is the last port in the card. If *y* and *z* are not specified, it defaults to all ports on the card.

 The command TE C 2 x y may also be used .

11. Test system for proper operation.
12. Close and lock the door to the cabinet.

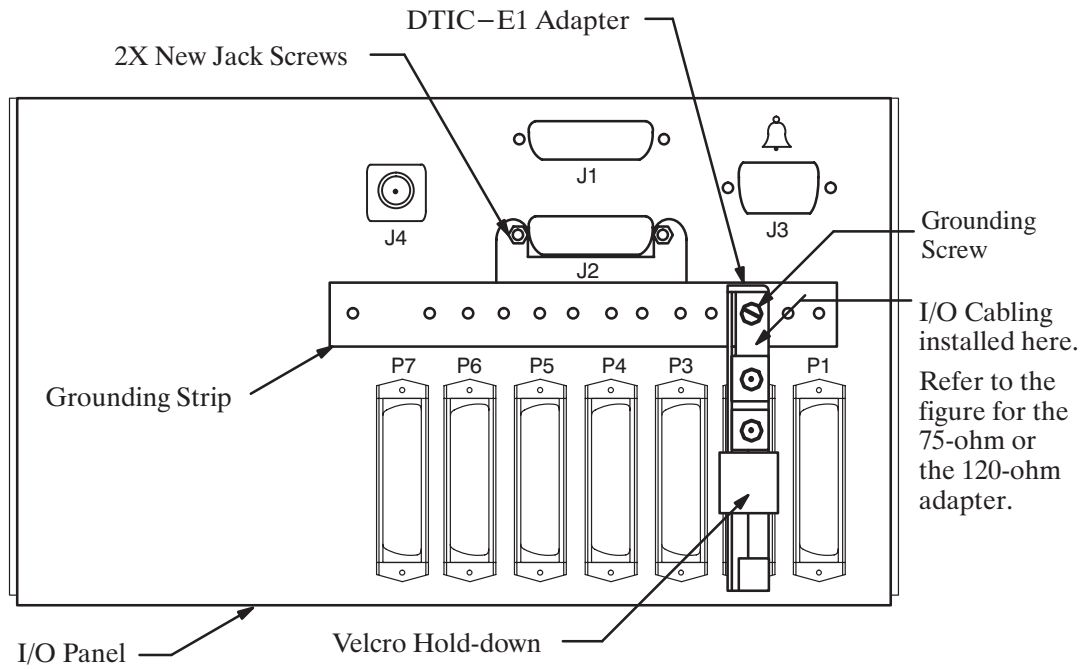

Figure 9-11 DTIC-E1 Kit Installation for the Octel Overture 200

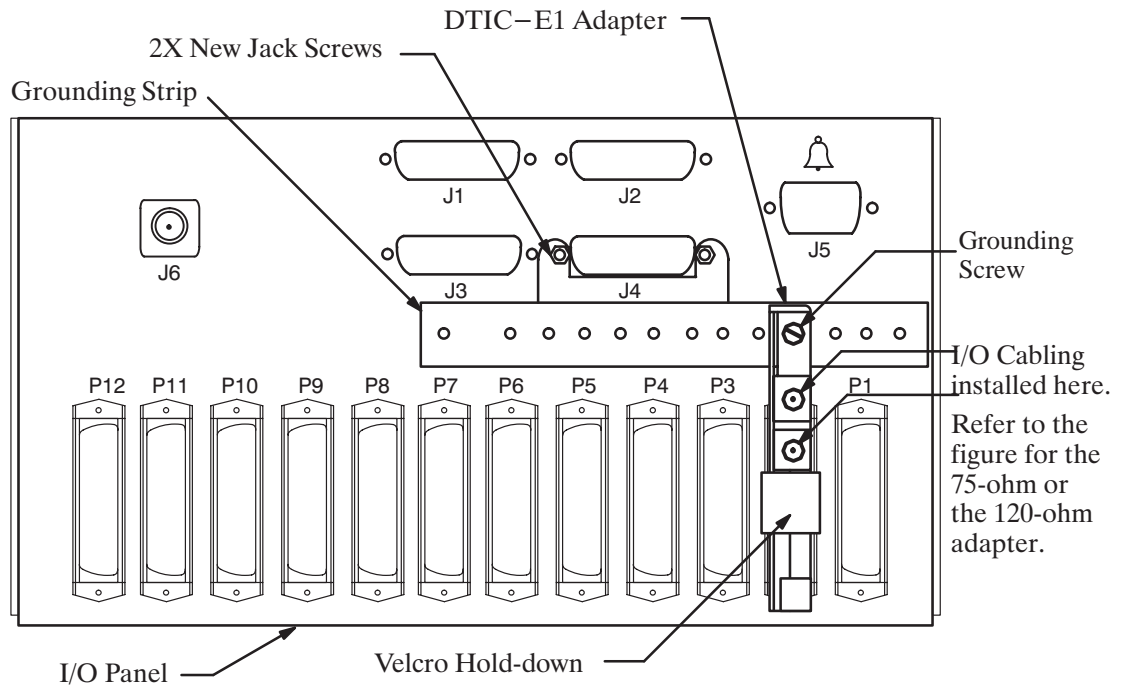

Figure 9-12 DTIC-E1 Kit Installation for the Octel Overture 300

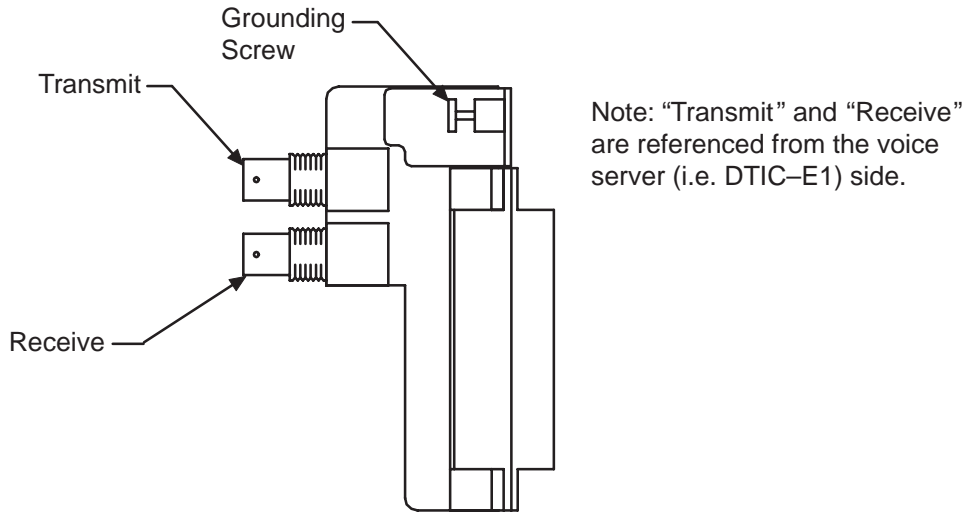

Figure 9-13 75-ohm DTIC-E1 Adapter

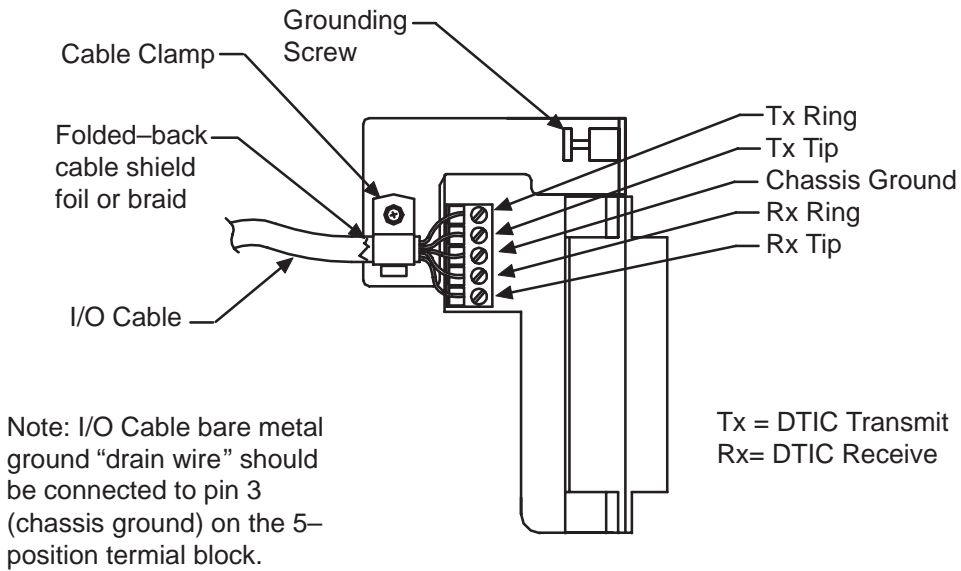

Figure 9-14 120-ohm DTIC-E1 Adapter

Fax Application Processor Replacement

The Octel Overture 200/300 fax application processors (fax cards) installed in shelf A are designed to be hot pluggable; that is, the message server does not need to be turned OFF to remove or install the cards. Figure 9-15 is a diagram of a fax card.

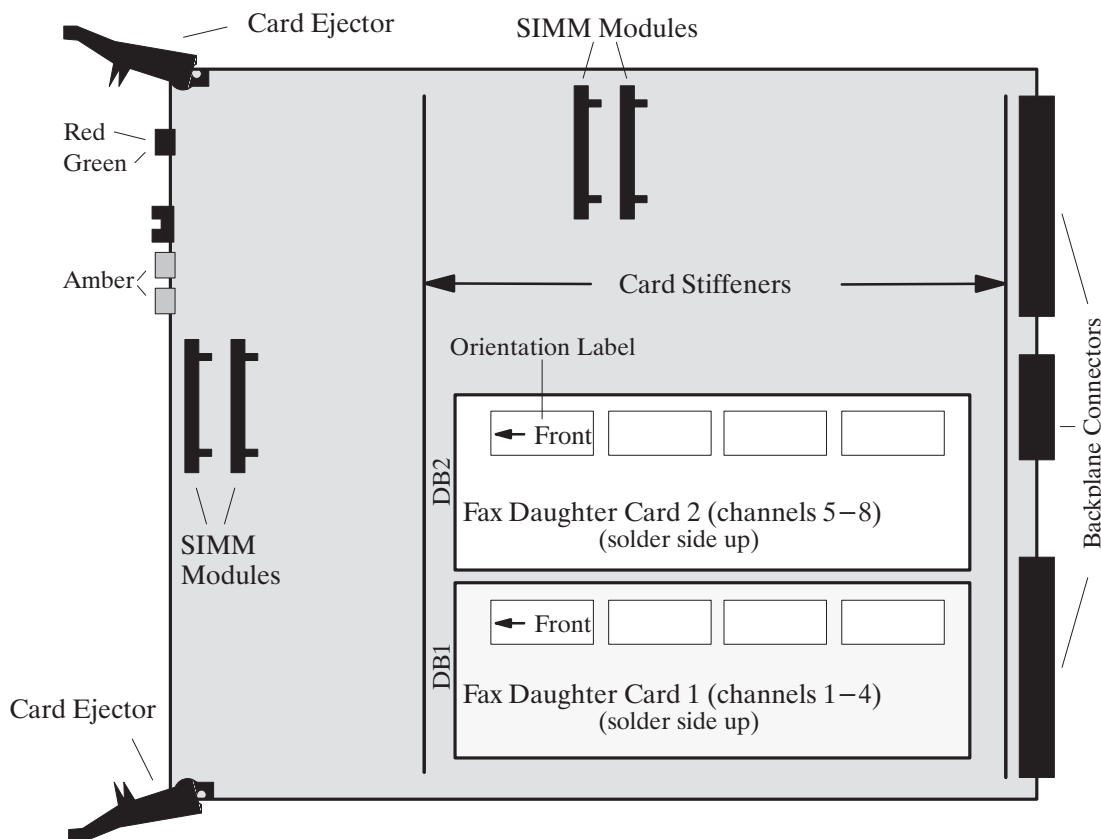

Figure 9-15 Fax Application Processor

Removing Fax Application Processors

Use the following procedure to remove a fax card:

1. Before servicing a fax application processor, use the Courtesy Down command to take the fax card out of service. At the @ prompt, type

```
CD x 
```

In this command, x is the slot number.

2. Unlock and open the door of the cabinet.
3. Put on an antistatic wrist strap. Connect it to an unpainted portion of the cabinet.
4. Remove the fax card from the Octel Overture 200/300 cabinet by pivoting the plastic card ejectors at the top and bottom front edge of the card and sliding the card out of the card cage.

 Handle the fax card **only** by the top and bottom edges. **Do not** touch components on the card.

5. Store the removed fax card in a static protection bag.

Installing Fax Application Processors

Use the following procedure to install a fax card:

1. Put on an antistatic wrist strap. Connect it to an unpainted portion of the cabinet.
2. While holding the top and bottom edges of the fax card, slide it into the card cage, taking care to align the card on the card guides and not let the daughter cards touch nearby cards.
3. Pivot the card ejectors, as needed, to grip the small flanges on the front edges of the card cage.
4. Firmly seat the fax card connectors into the motherboard by pressing the ejectors against the front edge of the fax card. The ejectors will clip onto the small pins on the fax card when the connectors are seated.



Caution!

Do not slam the fax card into the cabinet, as this could damage the card or motherboard connectors.

Once the fax card is installed, the red LED comes ON. When the self-test diagnostics are complete, the green LED comes ON. When the card has been initialized and is ready for operation, the red LED goes OFF.

5. Use the Courtesy Up command to put the card into service. At the @ prompt, type

```
CU x 
```

In this command, x is the slot number of the fax card.

6. Test the fax card for correct operation. Refer to the *Feature Description* volume, Fax Mail Plus chapter, Testing the Fax Application Processor section, for testing procedures.
7. Close and lock the door to the cabinet.

Hard-Disk-Drive Replacement

Hard-disk drives are already installed in the message server cabinet when it is shipped. When a replacement is required, certain procedures must be followed to restore a message server to normal operation.

Hot plug replacement of hard-disk drives is supported. Drives inserted hot are not operational until the Disk Options (DISKO) program is run. There is no online Disk Options program. However, the command to add, remove, or replace hard-disk drives must still be issued using the Disk Options program when the message server is booted from a floppy diskette.

 You must restart the message server if the hard-disk drive has been replaced.

Refer to the Procedures chapter in this volume, Hard-Disk Replace and Hard-Disk Add sections.

Only hard-disk drives supplied by Octel can be used to replace or to upgrade a message server. The disk drive assembly includes **all necessary** cables. **Do not remove or alter any cables on the drive assembly.** Figure 9-16 shows the hard-disk-drive assembly for the Octel Overture 200. Figure 9-17 shows the hard-disk-drive assembly for the Octel Overture 300.

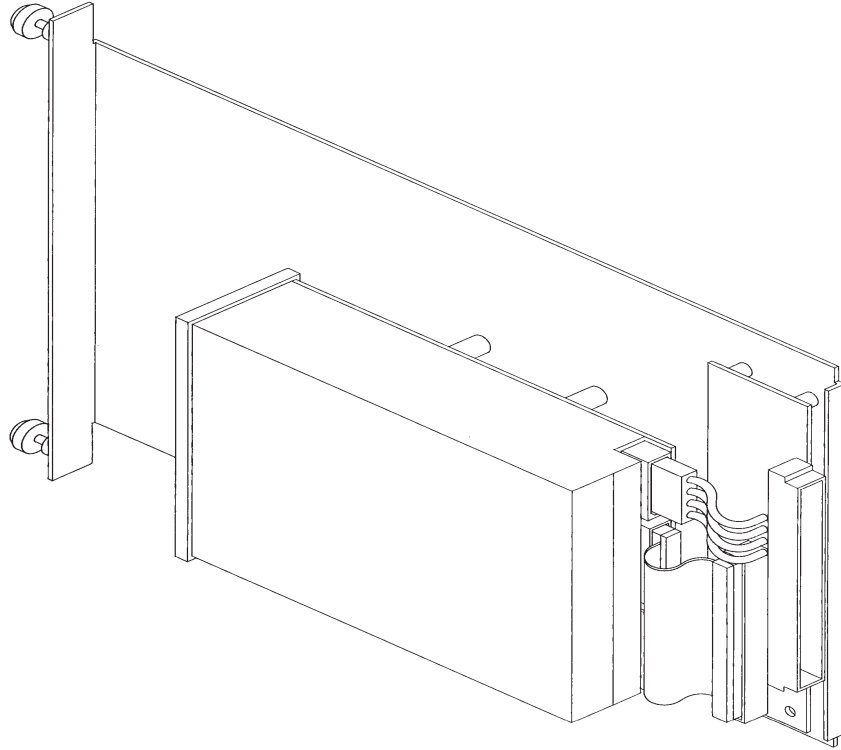

Figure 9-16 Octel Overture 200 Hard-Disk-Drive Assembly

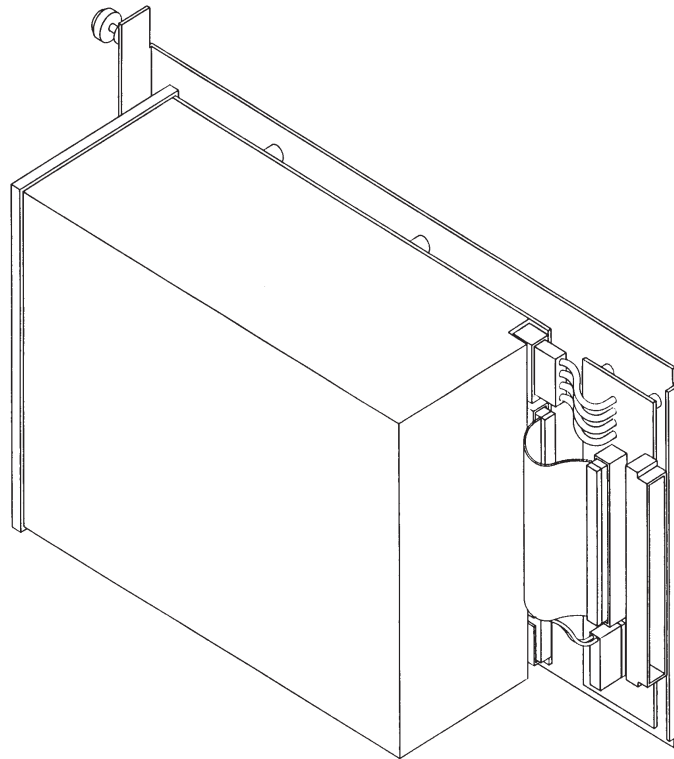

Figure 9-17 Octel Overture 300 Hard-Disk-Drive Assembly



Caution!

The hard-disk-drive assemblies are sensitive to static electricity. Do not attempt the following procedures without wearing an antistatic wrist strap.

Removing the Hard-Disk Drive

To remove the hard-disk drive, use the following procedures:

1. Unlock and open the door of the cabinet.
2. Put on an antistatic wrist strap. Connect it to an unpainted portion of the cabinet.
3. Locate the drive assembly to be removed.
4. Using a flat-bladed screwdriver, loosen the two captive screws that secure the hard-disk drive to the cabinet.
5. Gripping the front flange, pull the drive assembly out of the cabinet. Use one hand to support the bottom of the drive when it clears the cabinet.
6. Carefully place the drive assembly nearby, to be reinstalled or shipped.

 The hard-disk-drive assemblies are sensitive to rough handling. Be careful and handle them as gently as possible.

Installing the Hard-Disk Drive

To replace the hard-disk drive, use the following procedures:

 The disk drive ID will automatically be selected when the drive assembly is installed. Do not change the jumpers on the disk drive.

1. Put on an antistatic wrist strap. Connect it to an unpainted portion of the cabinet.
2. Remove the new disk drive from the shipping container.
3. Verify that the part number on the label attached to the sheet-metal plate of the hard-disk-drive assembly agrees with what was ordered.

 For part numbers and storage hours, refer to the Hardware chapter in this volume.

4. Hold the disk drive with your right hand, grasping the front flange with your left hand supporting the weight of the drive. The drive should be to the right of the metal slider plate.
5. Guide the sheet-metal plate into the card guides that are marked with the appropriate slot ID.
6. Gently, but firmly, slide the drive assembly into the slot until the connector on the back of the assembly is mated with the connector on the backplane. This is accomplished when the flange on the front of the drive-assembly sheet metal reaches or very nearly reaches the sheet metal of the cabinet.



Caution!

Do not slam the drive assembly into cabinet. This could damage the disk drive.

7. Using a flat-bladed screwdriver, tighten the two captive screws that are attached to the front flange of the drive assembly.
8. Follow the procedure in the Procedures chapter, Hard-Disk Restore/Add/Replace section, in this volume, to restore the message server to correct configuration.
9. Test the message server for correct operation.

Octel Overture 300 Floppy-Disk-Drive Replacement

In the event of damage or a malfunction, an Octel Overture 300 floppy-disk drive might need to be replaced. **Only** floppy-disk drives supplied by Octel can be used to replace a drive or to upgrade a message server. The disk-drive assembly includes **all necessary** cables. **Do not remove or alter any cables on the drive assembly.** Figure 9-18 shows the floppy-disk-drive assembly for the Octel Overture 300.

- ☞ For the Octel Overture 200, the power supply and the floppy drive are part of the power supply unit. If the floppy-disk drive malfunctions, these subassemblies must be replaced as a unit. Refer to the Power Supply Unit Replacement section in this chapter to replace an Octel Overture 200 floppy-disk drive.

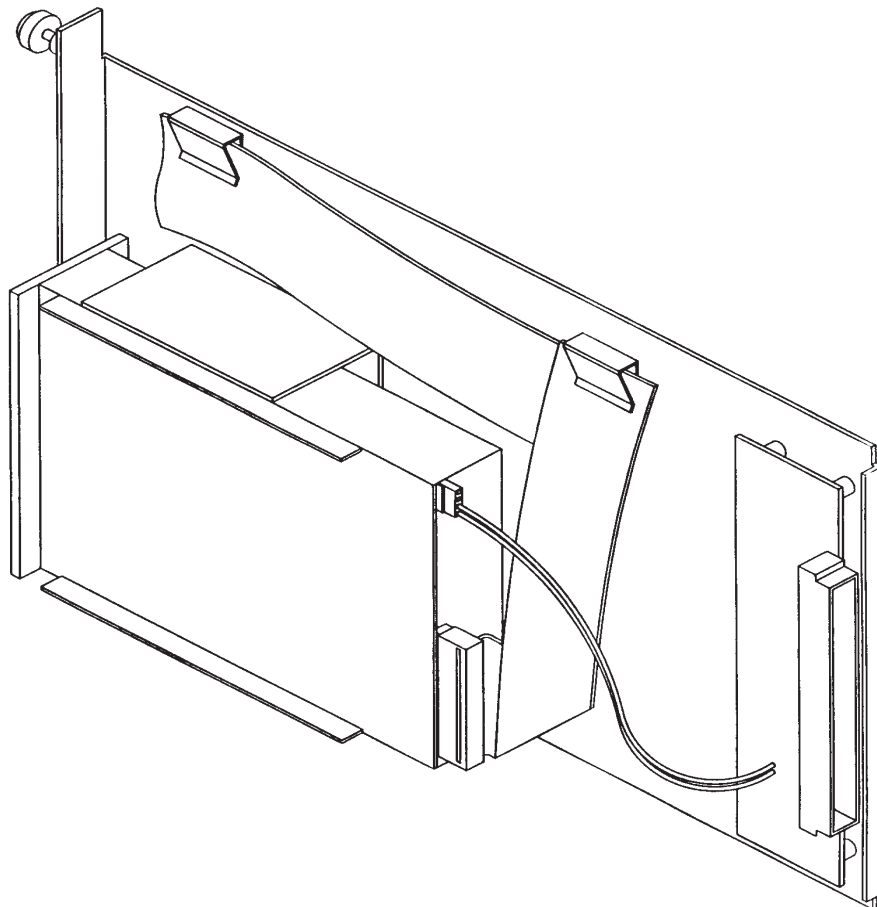

Figure 9-18 Octel Overture 300 Floppy-Disk-Drive Assembly



Caution!

The floppy-disk drive assemblies are sensitive to static electricity. Do not attempt the following procedures without wearing an antistatic wrist strap.

Removing the Octel Overture 300 Floppy-Disk Drive

The Octel Overture 300 floppy-disk-drive assembly is a hot pluggable assembly. You do not need to turn OFF the power supply unit. To remove the floppy-disk-drive assembly, use the following procedures:

1. Unlock and open the door of the cabinet.
2. Put on an antistatic wrist strap. Connect it to an unpainted portion of the cabinet.
3. Locate the floppy-disk-drive assembly.
4. Remove the configuration backup diskette from the floppy-disk drive.
5. Disconnect the floppy-disk signal cable from the front of the CPU card.
6. Using a flat-bladed screwdriver, loosen the two captive screws that secure the floppy-disk drive to the cabinet.
7. Gripping the front flange, pull the drive assembly firmly to unseat the rear-mounted connector. Continue to pull the drive out of the cabinet. Use one hand to support the bottom of the drive when it clears the cabinet.
8. Carefully put the floppy-drive assembly nearby, to be reinstalled or shipped.

 Floppy-disk-drive assemblies are sensitive to rough handling. Be careful and handle them as gently as possible.

Installing Octel Overture 300 Floppy-Disk Drive

The Octel Overture 300 floppy-disk-drive assembly is hot pluggable. You do not need to turn OFF the power supply unit. To install a replacement floppy-disk drive in the Octel Overture 300, use the following procedure:

1. Put on an antistatic wrist strap. Connect it to an unpainted portion of the cabinet.
2. Remove the replacement floppy-disk-drive assembly from the shipping container.
3. Hold the floppy-disk drive with your right hand, grasping the front flange, with your left hand supporting the weight of the drive. The drive should be to the right of the sheet-metal slider plate.
4. Guide the sheet-metal plate into the card guides marked “B5.”
5. Gently, but firmly, slide the drive assembly into the slot until the connector on the back of the assembly has mated with the connector on the backplane. This is accomplished when the flange on the front of the drive assembly sheet metal reaches or very nearly reaches the sheet metal of the cabinet.



Caution!

Do not slam the floppy-disk-drive assembly into the cabinet. This could damage the floppy-disk drive.

6. Using a flat-bladed screwdriver, tighten the two captive screws that are attached to the front flange of the drive assembly.
7. Connect the keyed connector on the floppy-drive signal cable to the connector on the CPU card.
8. Insert the configuration backup diskette into the floppy-disk drive.
9. Test the message server for correct operation.

Power Supply Unit Replacement

If the power supply unit malfunctions, it must be replaced with a new one. No attempt should be made to replace or alter the power supply's circuit components or wire harness. No power supply adjustments are possible.

- For the Octel Overture 200, the power supply and floppy-disk drive are part of the power supply unit. If either the power supply or floppy-disk drive malfunctions, you must replace the entire unit. The instructions used to remove and install the power supply are the same instructions used to replace an Octel Overture 200 floppy-disk drive. Figure 9-19 shows the power supply unit for an Octel Overture 200.

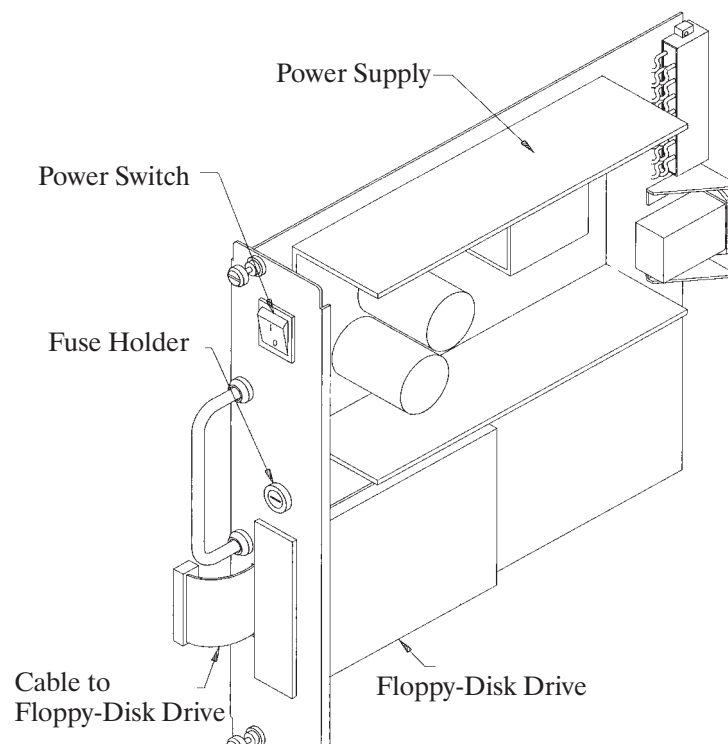

Figure 9-19 Octel Overture 200 Power Supply Unit

- For the Octel Overture 300, the power supply unit and the floppy-disk drive can be replaced separately. Refer to the Octel Overture 300 Floppy-Disk-Drive Replacement section to remove an Octel Overture 300 floppy-disk drive. Figure 9-20 shows the power supply assembly for the Octel Overture 300.

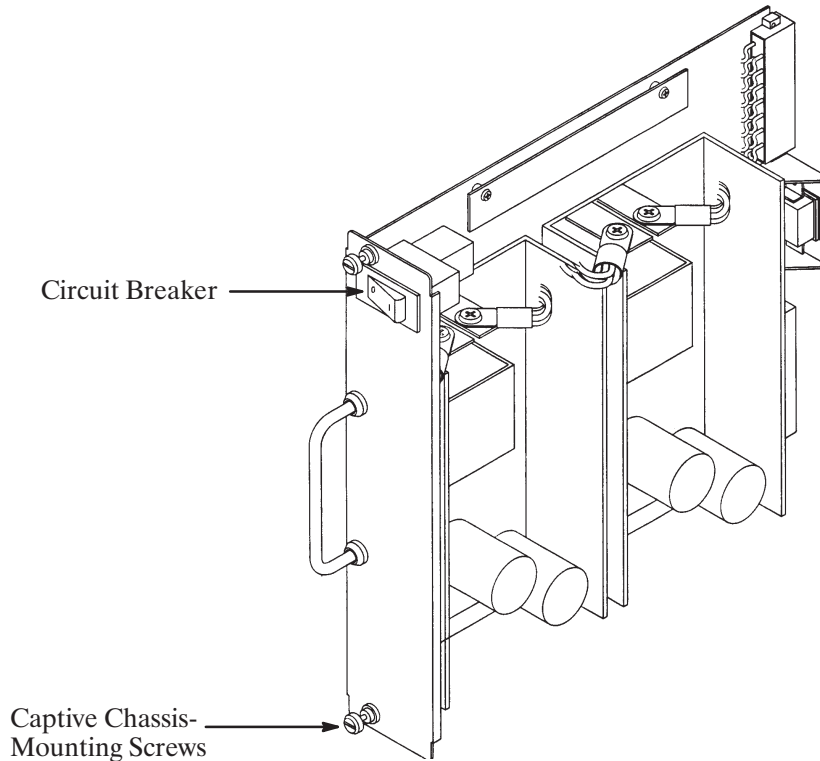

Figure 9-20 Octel Overture 300 Power Supply Assembly



Caution!

The power supply unit is sensitive to static electricity. Do not attempt the following procedures without wearing an antistatic wrist strap.

Removing the Power Supply Unit

Use the following procedure to remove the power supply unit:



Caution!

The power supply unit is **not** hot pluggable. **Do not** remove the power supply unit when it is ON.

1. Unlock and open the door of the cabinet.
2. Put on an antistatic wrist strap. Connect it to an unpainted portion of the cabinet.
3. Turn OFF the power to the message server at the switch on the front of the power supply unit. The switch for the power supply unit is a circuit-breaker rocker switch.
 - On the Octel Overture 200, the switch is OFF when the bottom of the rocker, marked 0, is pressed in. The switch is ON when the top of the rocker, marked 1, is pressed in.
 - On the Octel Overture 300, the switch is OFF when the side of the rocker, marked 0, is pressed in. The switch is ON when the side of the rocker, marked 1, is pressed in.



Caution!

To avoid risk of electric shock, wait 2 minutes after turning OFF the message server to remove the power supply unit.

4. Remove the floppy-disk-drive signal cable from the CPU.
5. Using a flat-bladed screwdriver, loosen the two captive screws on the front of the power supply unit.
6. Gripping the power supply unit handle, pull the power supply unit firmly to unseat the rear-mounted connectors. Continue to pull out the power supply unit, ready to support the bottom of the power supply unit with one hand when it clears the cabinet.

Installing the Power Supply Unit

To install the power supply unit, use the following procedure:

1. Put on an antistatic wrist strap. Connect it to an unpainted portion of the cabinet.
2. Verify that the power supply switch is OFF. The power supply unit switch is a circuit-breaker rocker switch.
 - ❑ On the Octel Overture 200, the power supply unit switch is OFF when the bottom of the rocker, marked 0, is pressed in. The switch is ON when the top of the rocker, marked 1, is pressed in.
 - ❑ On the Octel Overture 300, the switch is OFF when the side of the rocker, marked 0, is pressed in. The switch is ON when the side of the rocker, marked 1, is pressed in.



Caution!

Installing the power supply unit with the circuit breaker ON and the power cord attached to the primary power could damage the power supply unit or the message server.

3. Pick up the power supply unit with one hand on the handle and the other hand under the unit to support its weight. Support the power supply by holding the sheet-metal slider. **Do not** touch any power-supply electrical components or wiring.
4. Line up the edges of the power-supply-unit sheet metal, with the card guides marked A10 on the Octel Overture 200 and A15 on the Octel Overture 300, and slide the power supply unit halfway into the cabinet. Remove your supporting hand from the bottom of the sheet-metal plate.
5. Once again, confirm that the circuit breaker is OFF.
6. Gently, but firmly, continue to slide the power supply unit into the cabinet by pushing on the handle until the connectors on the back of the unit have mated with the connectors on the motherboard. This is accomplished when the flange on the front sheet metal of the power supply unit reaches or very nearly reaches the sheet metal of the cabinet.



Caution!

Do not slam the power supply unit into the cabinet. This could damage the power supply unit.

7. Using a flat-bladed screwdriver, tighten the two captive screws that are attached to the front flange of the power supply unit.
8. Reattach the floppy-disk-drive signal cable.
9. When all other message-server maintenance has been accomplished, turn ON the message server at the power supply unit switch. Measure the voltages on the front of the CPU, as described in the Installation chapter, Octel Overture 200/300 Hardware Installation section.
10. Close and lock the door of the cabinet.

Octel Overture 200 Power Supply Fuse

The Octel Overture 200 power supply unit has a fuse located on the front panel. If all of the following conditions are met, the fuse might have blown:

- The power switch on the power supply unit is ON,
- The power cord is plugged in,
- None of the LEDs on the front edges of the cards are lit,
- The disk drive and fans are quiet (not running).

Use the following procedure to replace the fuse:

1. Unlock and open the door of the cabinet.
2. Turn OFF the power switch on the front of the power supply unit.
3. Remove the fuse-holder cap, using a flat-bladed screwdriver.
4. Remove the fuse and verify that the fuse is blown. To remove the fuse, pull the end of the fuse out of the fuse cap.
5. Replace the fuse with a fuse of the same rating. To replace the fuse, push one end of the fuse into the fuse-holder cap and insert the cap into the fuse holder.
6. Tighten the fuse-holder cap with a flat-bladed screwdriver.
7. Turn ON the power switch.
8. Check the LEDs on the cards to see whether they are lit.
9. Check that the disk drive and fans are running.
10. Close and lock the door of the cabinet.

Octel Overture 200 Fan Panel Assembly

In the Octel Overture 200, the fan panel is hot pluggable. That is, the message server does not need to be turned OFF to remove and install the fan panel. However, if the message server must be moved to gain access to the fan panel, it must be turned OFF. This prevents possible damage to the message server.

Removing the Fan Panel from the Octel Overture 200

Use the following procedures to remove the fan panel. Before proceeding, have the replacement unit ready.

1. Put on an antistatic wrist strap. Connect it to an unpainted portion of the cabinet.
2. Using a Phillips head screwdriver, remove the four screws securing the fan panel, and remove it from the back of the message server.
3. Disconnect the fan power harness from the top of the motherboard. Set the fan panel aside.



Caution!

When the fan panel is removed, do not operate the message server for more than 4 minutes.

Installing Fan Panel in the Octel Overture 200

To install the fan panel, use the following procedures:

1. Connect the fan power harness for the new fan panel to the power connector on the top of the motherboard.
2. Rest the fan panel on the two locating standoffs.
3. Secure the fan panel with the four screws previously removed. Insert the two short screws at the top edge, and the two long screws at the bottom edge of the fan panel.
4. Turn ON the message server and make sure that both fans are spinning.

Octel Overture 300 Fan Tray Replacement

In the Octel Overture 300, the fan tray is hot pluggable. That is, the message server does not need to be turned OFF to remove and reinstall the fan tray.

- ☞ The Octel Overture 300 should not be operated with the door open or the air filter removed for more than 1 hour.



Caution!

When the fan tray is removed, do not operate the message server more than 4 minutes. If the fan tray cannot be replaced within 4 minutes, turn OFF the message server.

Removing the Fan Tray from the Octel Overture 300

The fan tray is hot pluggable. That is, the message server does not need to be turned OFF to remove and reinstall the fan tray. Use the following procedure to remove the fan tray. Before proceeding, have the replacement unit ready.

1. Unlock and open the door of the cabinet.
2. Put on an antistatic wrist strap. Connect it to an unpainted portion of the cabinet.
3. Using a flat-bladed screwdriver, loosen the two captive screws on the front flange of the fan tray.
4. Move the floppy-drive signal cable to the right, so that it will not interfere with the removal of the fan tray.

 **Do not** disconnect the floppy-drive cable. There is enough relief in the cable to allow you to remove the fan tray without disconnecting the cable.

5. Grip the front edge of the fan tray and pull it straight out of the cabinet.



When the fan tray is removed, do not operate the message server for more 4 four minutes.

Installing the Fan Tray in the Octel Overture 300

To install the fan tray, use the following procedures:

1. Place the fan tray edges into the two U-channels on either side of the cabinet, under the card cage. The floppy-disk signal cable should be to the right of the fan tray.
2. Slide the fan tray into the message server, so the the connector on the back of the assembly mates fully with the connector in the cabinet. This is accomplished when the front flange of the fan tray reaches or very nearly reaches the two small angle brackets on either side of the cabinet.
3. Using a flat-bladed screwdriver, tighten the two captive screws attached to front flange of the fan tray.
4. If necessary, turn ON the message server and verify that all four fans are spinning.

Air Filter Cleaning

Air filters can be cleaned and reused indefinitely. The following sections explain how to remove, clean, and reinstall an air filter.

 The Octel Overture 200/300 should not be operated with the door open or the air filter removed for more than 1 hour.

Removing the Air Filter

To remove the air filter, use the following procedures:

1. Unlock and open the door of the cabinet.
2. On the back of the door, free the corners, then the top and bottom edges of the air filter from the velcro hold-downs.
3. Slide the air filter out of the door.

4. Once the air filter is removed, rinse it in cold water until the water runs clear.
5. Shake out the excess water from the air filter. The air filter should be dry before you reinstall it.

Installing the Air Filter

To reinstall the air filter, use the following procedures:

1. Slide the air filter into the door in the way that you removed it. Make sure that the wavy side of the filter material is against the door.
2. Once the air filter is in position, push the corners and the top and bottom edges of the air filter against the velcro hold-downs.
3. Close and lock the door to the cabinet.

Motherboard Assembly

The motherboard provides the communications bus for the VCU, CPU, and LIC printed circuit assemblies as well as the d.c. power distribution for the disk drives. Figure 9-21 shows the motherboard assembly.

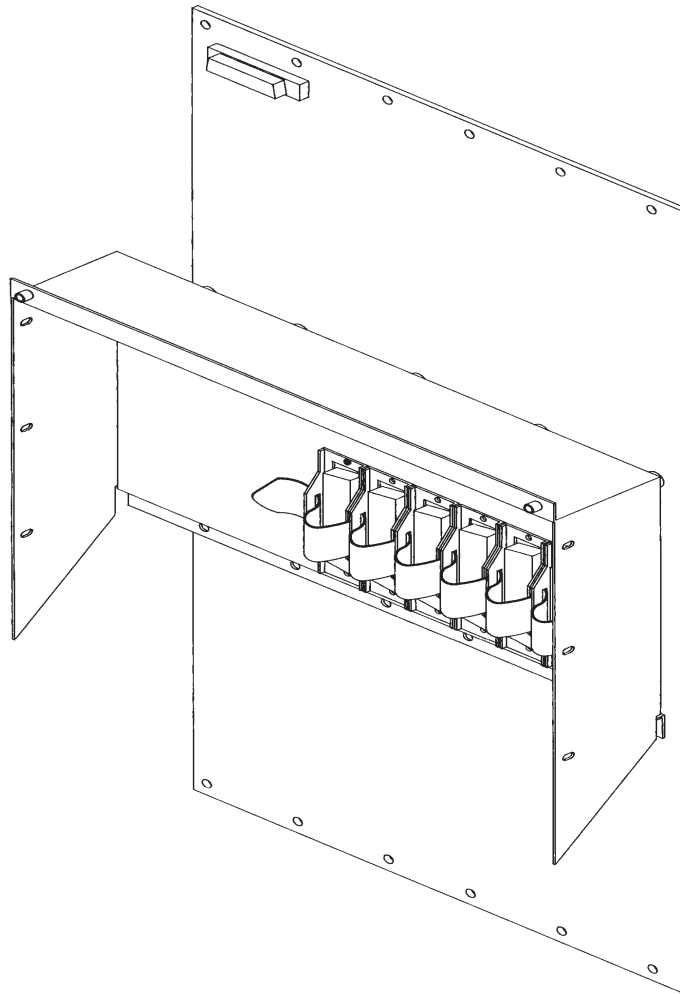

Figure 9-21 Motherboard Assembly



Caution!

Replacing the motherboard assembly is a complicated procedure. Replace it **only after** you have confirmed that the motherboard is faulty. **Do not** disassemble the motherboard.

The motherboard can only be replaced as an assembly. To replace the motherboard assembly, you must have access to both the front and rear of the Octel Overture 200/300 cabinet.

Removal and reinstallation procedures are separate for the Octel Overture 200 and Octel Overture 300, because the procedures differ for each message server.



Caution!

Make sure to wear an antistatic wrist strap before attempting the following procedures.

Handle the motherboard assembly carefully; do not drop it or bang it into other objects. **Never** set anything on top of it.

Removing the Motherboard Assembly from the Octel Overture 200

To remove the motherboard assembly, use the following procedures:

1. Unlock and open the door of the cabinet.
2. Put on an antistatic wrist strap. Connect it to an unpainted portion of the cabinet.
3. Turn OFF the power supply unit. Refer to the Power Supply Unit Replacement section in this chapter for details about turning OFF the power to the message server.
4. Disengage the cards in slots A1 through A9 from the motherboard. (The cards stay in the cabinet.) Remove the floppy-diskette signal cable.
5. Using a flat-bladed screwdriver, loosen the two captive screws on the front of the power supply unit and on the disk-drive assembly. Disengage them from the backplane. (The power supply unit and the disk-drive assembly stay in the cabinet.)
6. Move to the back of the Octel Overture 200 cabinet, and label all cables attached to the motherboard, so that they can be reattached in the same positions on the new motherboard.
7. Disconnect the cables from the motherboard.
8. Unplug the AC cord from the cabinet.

If the cabinet is d.c. powered, disconnect the wiring from the d.c. power source at the DC inlet box.

Remove the DC inlet box from the back of the message server as shown in Figure 9-23.

9. Remove the fan panel, following the instructions in the Octel Overture 200 Fan Panel Assembly section in this chapter.
10. Disconnect the maintenance-port cable from the upper left hand corner of the motherboard.
11. Using a Phillips head screwdriver, remove the four screws that secure the bottom panel to the cabinet, and remove the panel.

Cables that were disconnected from the motherboard in step 7 are fastened to the bottom panel with cable ties. These cables can remain fastened.

12. Remove the six screws that secure the motherboard to the cabinet from the sides of the motherboard I/O panel.
13. Remove the 18 screws that secure the motherboard to the cabinet; remove the motherboard.
14. Refer to Figure 9-22 or Figure 9-23 and remove the hardware that secures the backplane power harness to the motherboard. Use an 11/32 nut driver to remove the grounding hardware. Remove the backplane power harness from the motherboard, so that it can be reinstalled on the new motherboard.

 The hardware used to secure the backplane power harness to the motherboard is reused when securing the harness to the new motherboard.

Installing a Motherboard Assembly in the Octel Overture 200

To install the motherboard, use the following procedure:



Caution!

The motherboard must be aligned precisely to ensure correct card engagement. To accomplish this, make sure to follow the instructions exactly.

1. Install the backplane power harness from the old motherboard on the new motherboard. Refer to Figure 9-22 or Figure 9-23 for correct installation.
2. Remove the Option Control Chip (OCC) from the old motherboard and install it in the new motherboard assembly. Refer to the Option Control Chip Replacement section in this chapter for removal and installation procedures.
3. Hold the new motherboard up to the cabinet, and install a screw in the top, center screw hole to hold it in place.
4. Install the remaining 17 screws along the top and bottom of the motherboard, so that the it is just able to move, with a minimal amount of distance between the screwheads and motherboard. **Do not** tighten the screws yet.
5. Install the six screws on the sides of the motherboard I/O panel, but do not tighten them at this time.
6. Push only PCAs in slots A1 and A9, the power supply assembly, and one disk-drive assembly into the connectors on the motherboard. **Do not** tighten the power supply assembly.
7. Tighten the 18 screws at the top and bottom of the motherboard and the six screws on the I/O panel.
8. Connect the maintenance port cable to the connector on the top left corner of the motherboard.
9. Fasten the bottom rear panel with four screws (two short ones at the top, two long ones at the bottom), and reconnect the cables as they were connected on the old motherboard.
10. Replace the fan panel, following the instructions in the Octel Overture 200 Fan Panel Assembly section in this chapter.

If the cabinet is d.c. powered, install the DC inlet box.
11. Verify that the power supply unit is OFF. Attach the power cord.

If the cabinet is d.c. powered, reconnect the wires from the d.c. power source to the DC inlet box. Refer to Figure 9-23.
12. Plug the remaining boards into the motherboard.

13. Tighten the two fasteners on the front of the power supply unit and disk-drive assembly.
14. Test the message server for correct operation by following the procedures in the Installation chapter in this volume.
15. Close and lock the door to the cabinet.

Removing a Motherboard Assembly from the Octel Overture 300

To remove the Motherboard Assembly, refer to Figure 9-24, Figure 9-25, and Figure 9-26, and use the following procedures:

1. Unlock and open the door of the cabinet.
2. Put on an antistatic wrist strap. Connect it to an unpainted portion of the cabinet.
3. Turn OFF the power supply unit. Refer to the Power Supply Unit Replacement section in this chapter for details about turning OFF the power to the message server.
4. Disengage the cards in slots A1 through A14 from the motherboard. (The cards stay in the cabinet.) Remove the floppy-diskette signal cable.
5. Using a flat-bladed screwdriver, loosen the two captive screws on the front of the power supply unit. Disengage the motherboard from the backplane. (The power supply unit stays in the cabinet.)
6. Move to the back of the Octel Overture 300 cabinet and label all cables attached to the motherboard, so that they can be reattached in the same positions on the new motherboard.
7. Disconnect the cables from the motherboard.
8. Remove four screws that secure the top panel to the cabinet, and remove the panel.
9. Disconnect the maintenance-port cable from the upper left hand corner of the motherboard assembly.
10. Remove the power filter assembly as described in the Octel Overture 300 Power-Filter Assembly Replacement section of this chapter.
11. Using a Phillips head screwdriver, remove the four screws that secure the bottom panel to the cabinet, and remove the panel.

Cables that were disconnected from the motherboard in step 7 are fastened to the bottom panel with cable ties. These cables can remain fastened.
12. Disconnect the power harness for the disk-drive backplanes (SCSI motherboard) at the motherboard. Leave the harness ends connected to the disk-drive backplanes.
13. Disconnect the two short flat cables from the motherboard. Leave the cables attached to the top disk-drive backplane.
14. Disconnect the fan power harness from the top disk-drive backplane.
15. Remove the five screws that secure the motherboard to the cabinet from the sides of the motherboard I/O panel.
16. Remove the 18 screws that hold the top and bottom of the motherboard to the cabinet, and remove the motherboard.
17. Remove the power-filter harness from the motherboard, so that it can be installed on the new motherboard.

 The hardware used to secure the harness to the motherboard (two screws, two nuts, and a lockwasher) is reused when securing the harness to the new motherboard.

Installing the Motherboard Assembly in the Octel Overture 300

To install the motherboard assembly, use the following procedure:



Caution!

The motherboard must be aligned precisely to ensure correct card engagement. To accomplish this, make sure to follow the instructions exactly.

1. Install the filter power harness from the old motherboard on the new motherboard. Refer to Figure 9-24 for correct installation.
2. Remove the Option Control Chip (OCC) from the old motherboard and install it in the new motherboard. Refer to the Option Control Chip Replacement section in this chapter for removal and installation procedures.
3. Hold the new motherboard up to the cabinet, and install a screw in the top, center screw hole to hold it in place. Pass the power harness to the fan tray through the small, rectangular cutout in the bottom of the motherboard.
4. Install the remaining 17 screws along the top and bottom of the motherboard, so that it is just able to move with a minimal amount of distance between the screwheads and the motherboard. **Do not** tighten screws yet.
5. Install the five screws on the sides of the motherboard I/O panel, but do not tighten them at this time.
6. Push only PCAs in slots A1 and A14 and the power supply assembly into the connectors on the motherboard.
7. Tighten the 18 screws at the top and bottom of the motherboard and the five screws on the motherboard I/O panel.
8. Plug the fan-tray harness into the top disk-drive backplane.
9. Connect the two flat cables from the top disk-drive backplane to the motherboard.
10. Connect the disk drive backplane power harness to the motherboard.
11. Connect the maintenance port cable to the connector at the top left corner of the motherboard.
12. Install the power filter assembly as described in the Octel Overture 300 Power-Filter Assembly Replacement section in this chapter.
13. Fasten the bottom rear panel with four screws, and reconnect the cables as they were connected on the old motherboard.
14. Fasten the top rear panel with four screws.
15. Verify that the power supply unit is OFF. Attach the power cord.
If the cabinet is d.c. powered, reconnect the wires from the d.c. power source to the power filter assembly. Refer to Figure 9-26.
16. Plug the remaining boards into the motherboard.
17. Tighten the two captive screws on the front of the power supply unit.
18. Test the message server for correct operation by following the procedures in the Installation chapter in this volume.
19. Close and lock the door to the cabinet.

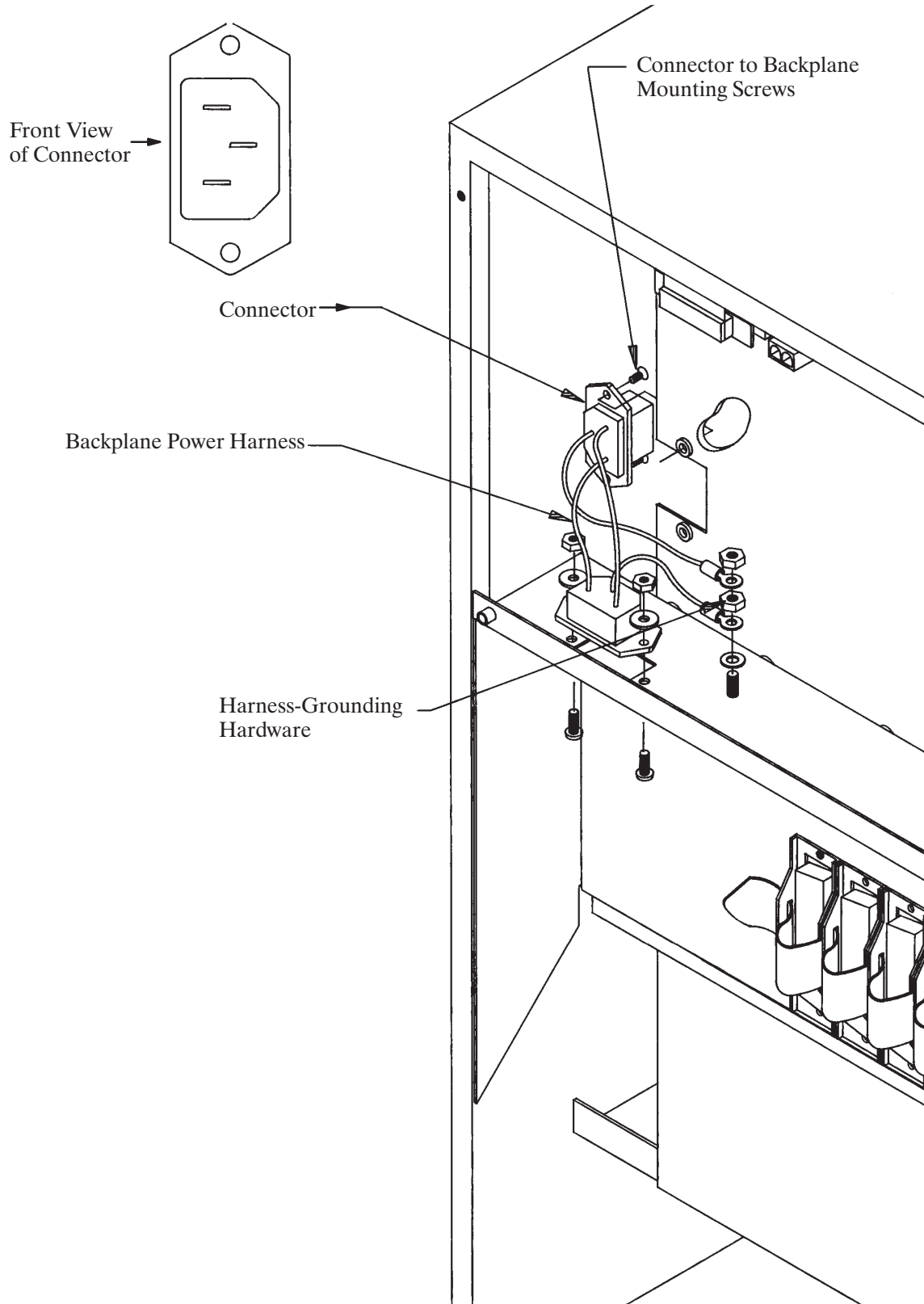

Figure 9-22 A.C. Backplane Power Harness Installation for Octel Overture 200

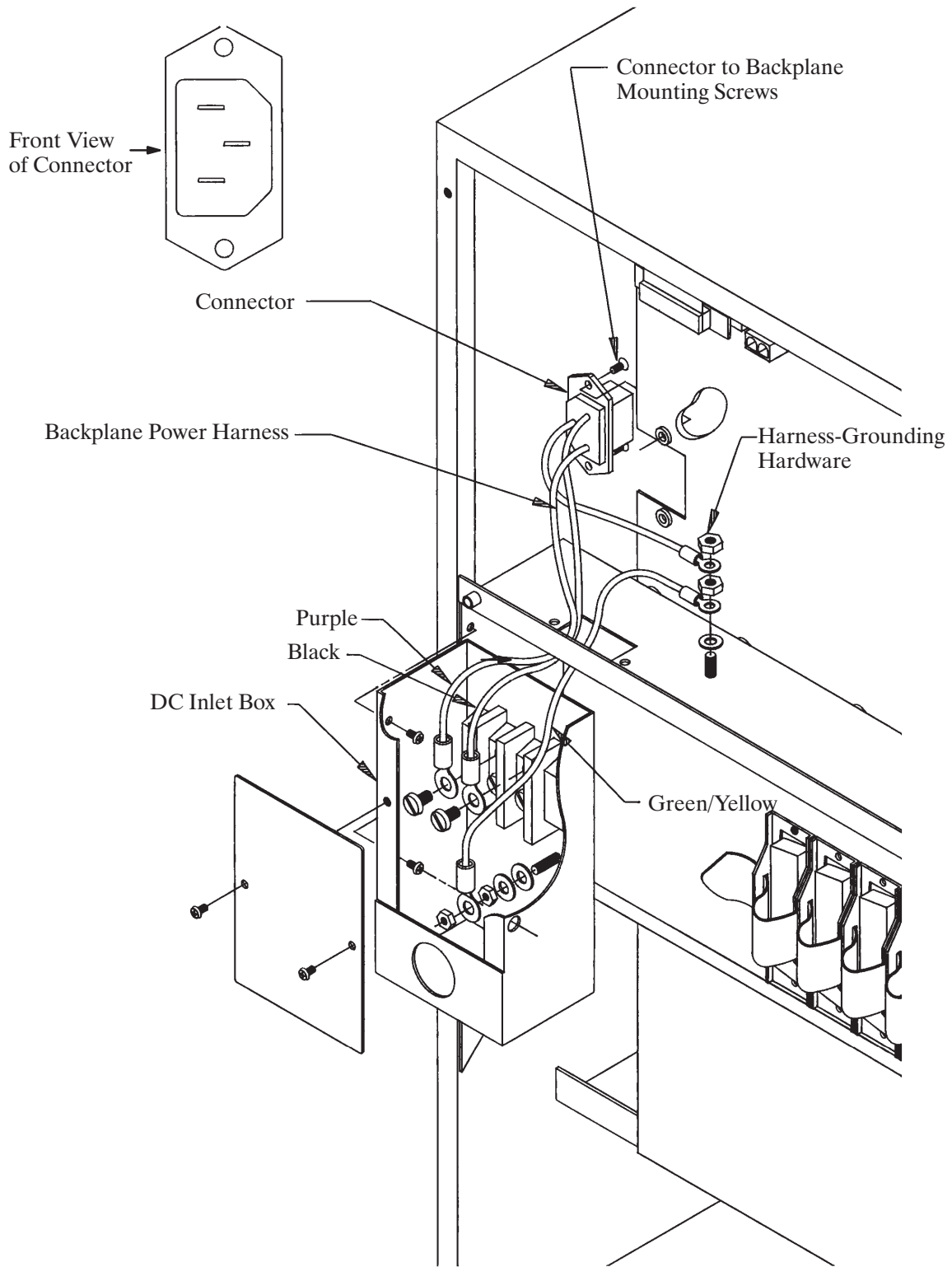

Figure 9-23 D.C. Backplane Power Harness Installation for Octel Overture 200

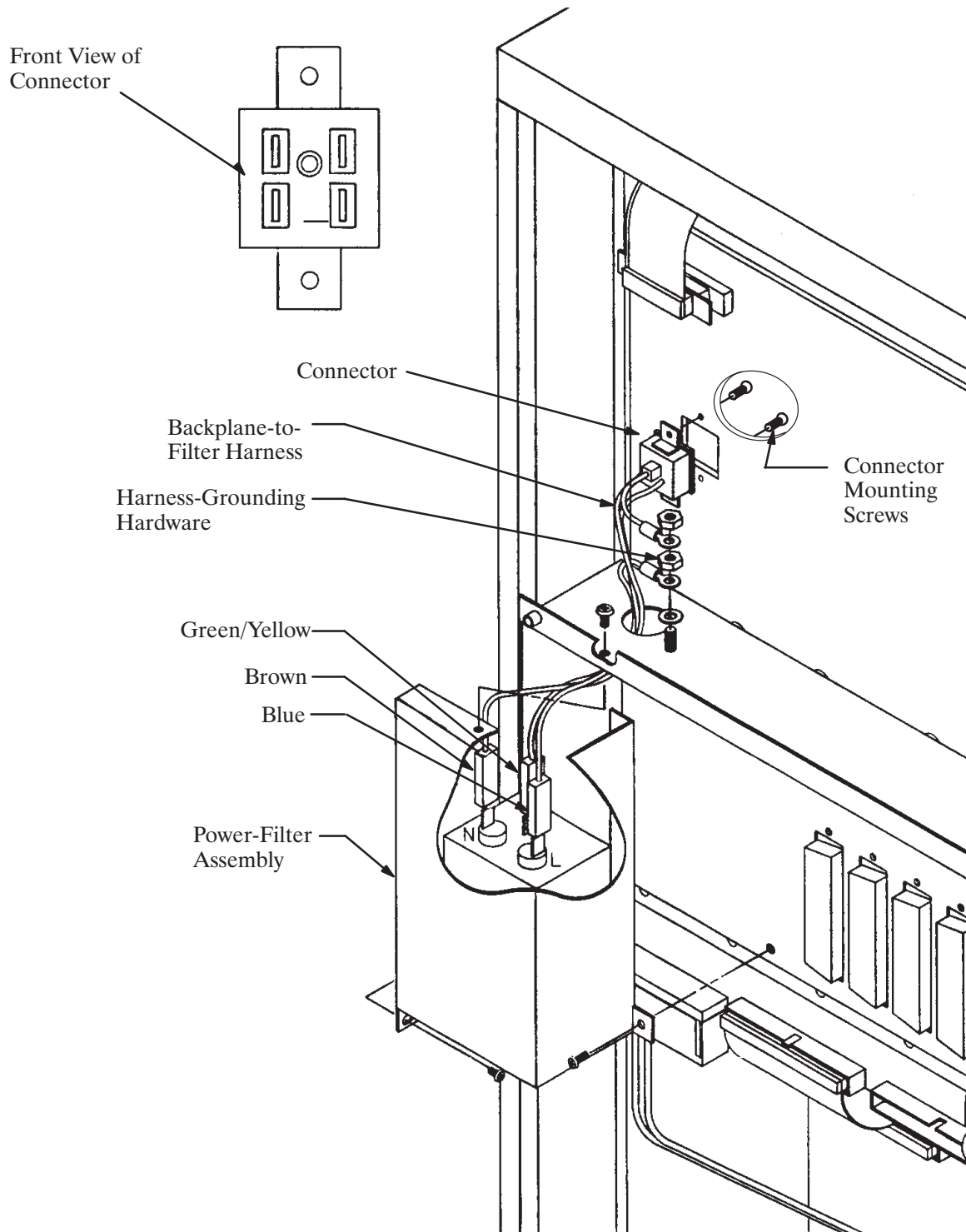

Figure 9-24 Power-Filter Assembly for 120-Vac and 240-Vac Domestic Octel Overture 300

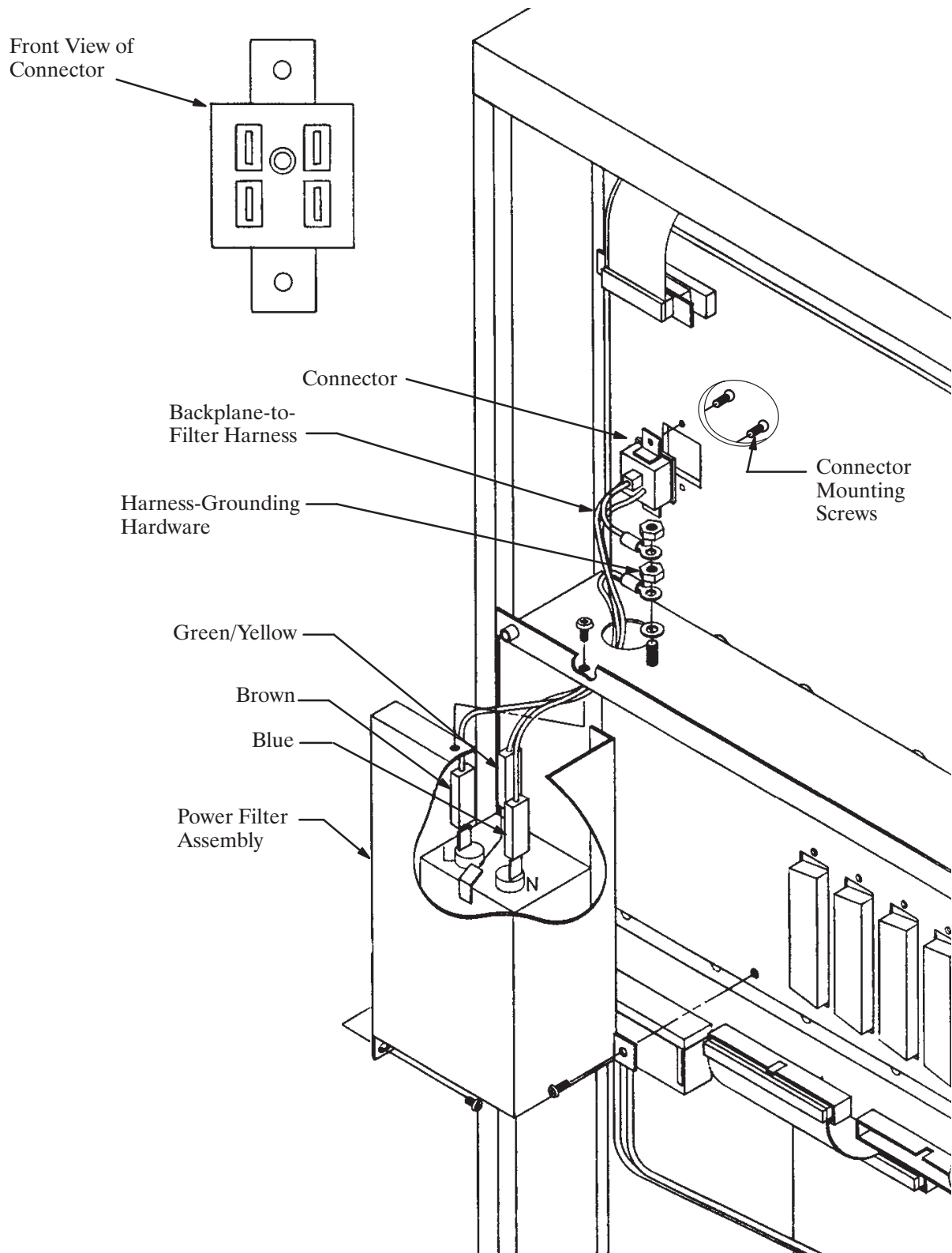

Figure 9-25 Power-Filter Assembly for 240-Vac International Octel Overture 300

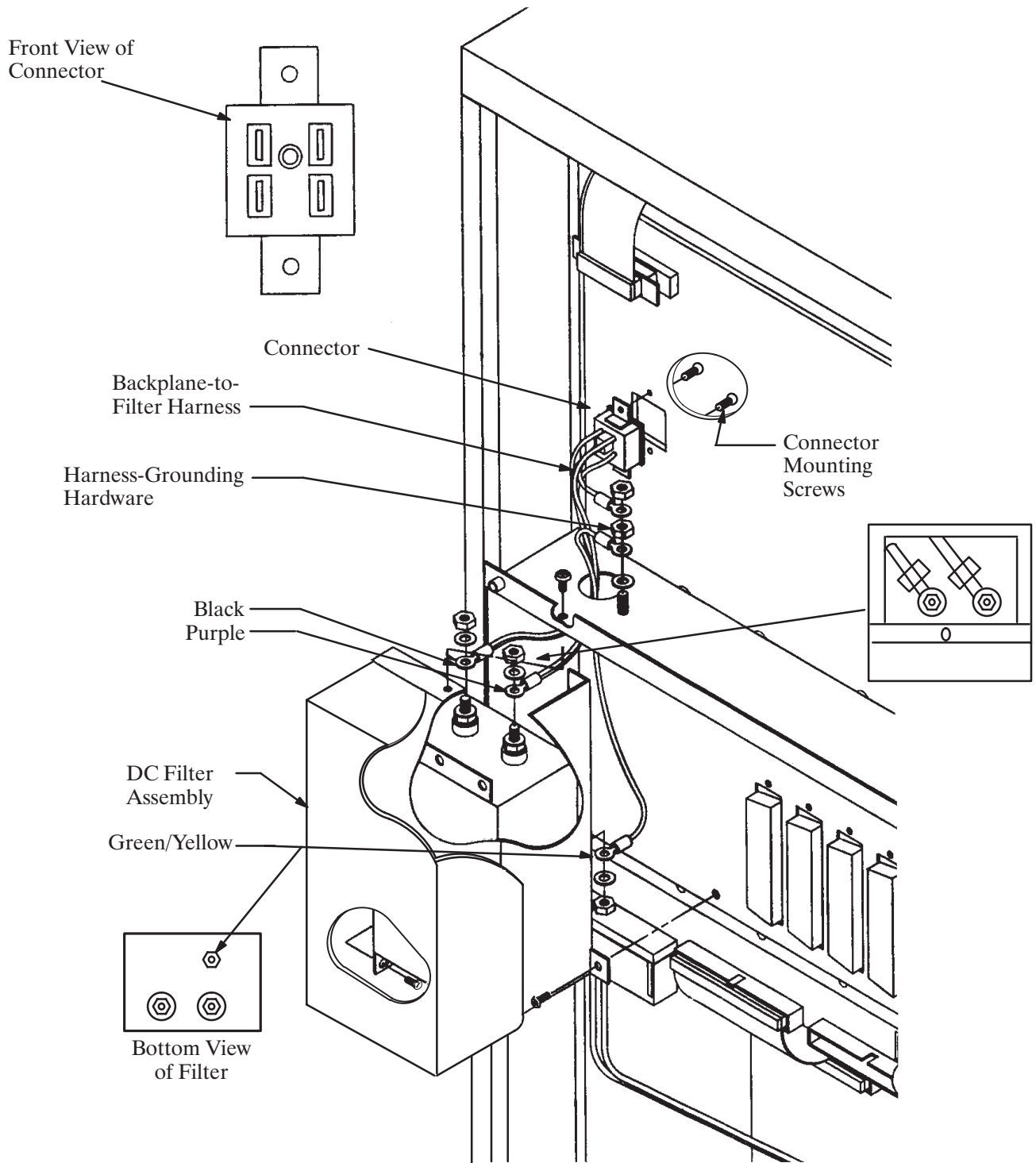

Figure 9-26 Power-Filter Assembly for 48-Vdc Octel Overture 300

Octel Overture 300 Disk-Drive Backplane Replacement

The disk-drive backplanes provide communication and d.c. power buses from the motherboard to the disk-drive assembly. There are two disk-drive backplanes, one for shelf B and one for shelf C.

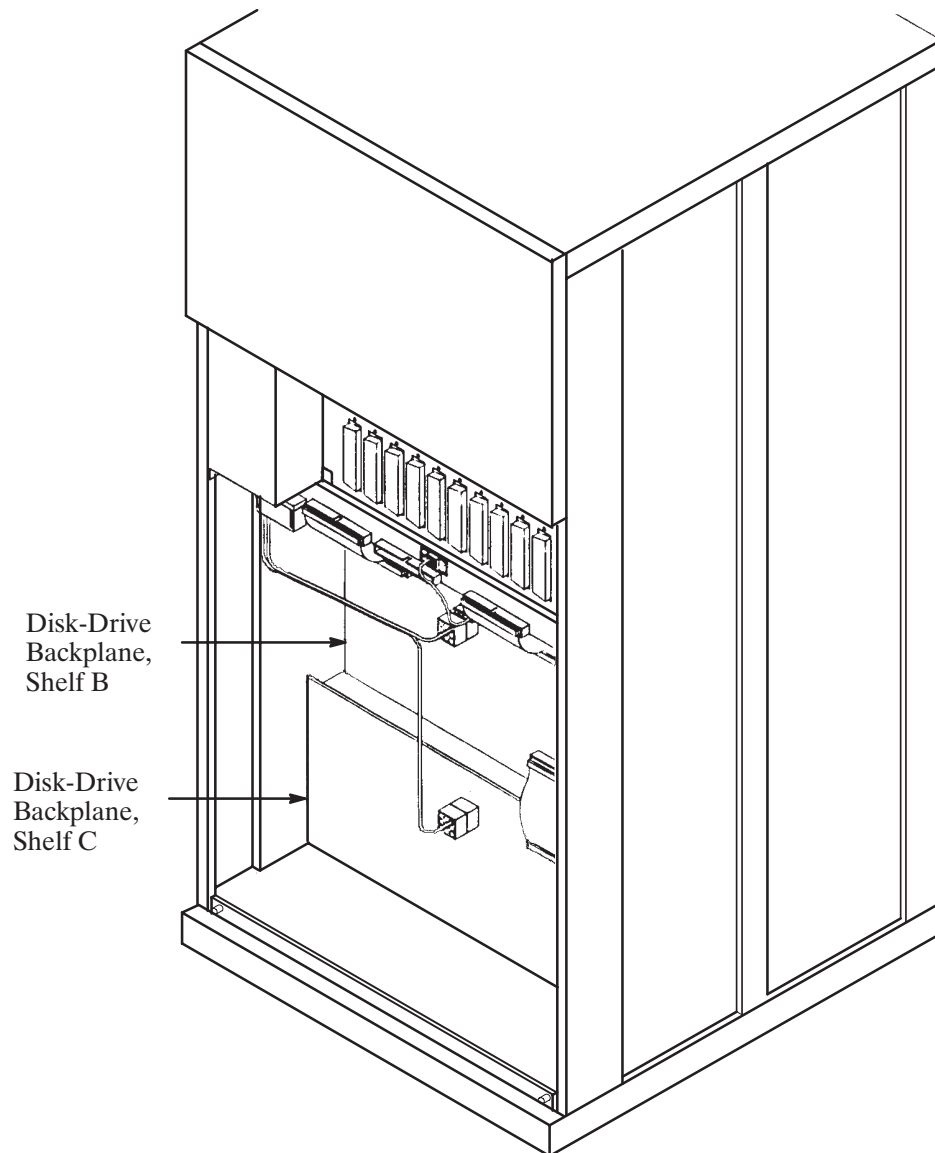

Figure 9-27 Octel Overture 300 Disk-Drive Backplanes

The following replacement procedures provide steps for removing and installing disk-drive backplanes. Before proceeding, make sure to determine which backplane is faulty.



Caution!

Disk-drive backplane are sensitive to static electricity. **Do not** attempt the following procedures without wearing an antistatic wrist strap.

- ☞ The disk drive backplane is sensitive to rough handling. Care should be taken to handle it as gently as possible.

Removing a Disk Drive Backplane from the Octel Overture 300

Use the following procedure to remove a disk-drive backplane:

1. Unlock and open the door of the cabinet.
2. Put on an antistatic wrist strap. Connect it to an unpainted portion of the cabinet.
3. Turn OFF the power supply unit. Refer to the Power Supply Unit Replacement section in this chapter for details about turning OFF the power to the message server.
4. Using a flat-bladed screwdriver, loosen the two captive screws on the front of each of the disk-drive assemblies on the shelf that has the faulty backplane. Disengage each disk-drive assembly from the backplane; the disk-drive assembly should stay in the cabinet.
5. At the rear of the Octel Overture 300 cabinet, disconnect all cables attached to the motherboard. Mark the cables so that they can be reattached at the same positions.
6. Disconnect the power cord from the cabinet.
7. Remove the four screws that secure the bottom panel to the cabinet, and remove the panel.
Cables that were disconnected from the motherboard in step 5 might be fastened to the bottom panel with cable ties. These cables can remain fastened.
8. Disconnect all harnesses and cables from the backplane being replaced. Make sure that the ends of the harnesses and cables not directly attached to the backplane being replaced remain connected.
9. If the shelf B disk-drive backplane is being removed, and the message server is equipped with a load-resistor assembly, remove the four screws and washers that secure the load-resistor assembly to the message server. Refer to Figure 9-28 to verify whether a load-resistor assembly is present.
10. Remove the screws along the top and bottom edges of the backplane and remove it.

Installing a Disk Drive Backplane in the Octel Overture 300

Use the following procedure to install a new disk-drive backplane:



Caution!

The backplane must be aligned precisely to ensure that the disk-drive assembly is fully engaged with the backplane. To accomplish this, follow the instructions exactly.

1. Hold the new backplane up to the cabinet, and install a screw in the top, center screw hole to hold it in place.
2. If the shelf B backplane is being installed in a message server with a load-resistor assembly, secure the load-resistor assembly to the cabinet with four screws and washers, as shown in Figure 9-28 . Do not tighten the screws.
3. Install all of the screws along the top and bottom edges of the backplane, so that it is just able to move, with only a small gap between the screwheads and the backplane.
4. At the front of the cabinet, push each disk-drive assembly into its mating connector on the backplane.
5. Tighten all the screws on the top and bottom edges of the backplane.

6. Reconnect all harnesses and cables to the backplane.
7. Fasten the bottom rear panel with four screws, and reconnect the cables as they were.
8. Verify that the power supply unit is OFF . Attach the power cord.
9. Tighten the fasteners on the front of each disk-drive assembly.
10. Test the message server for correct operation by following the procedures in the Installation chapter in this volume. Verify that the fans are spinning.

Octel Overture 300 Load Resistor Assembly Replacement

If the load-resistor assembly malfunctions, it must be replaced with a new one. Do not attempt to replace or alter the load-resistor components or wire harness.

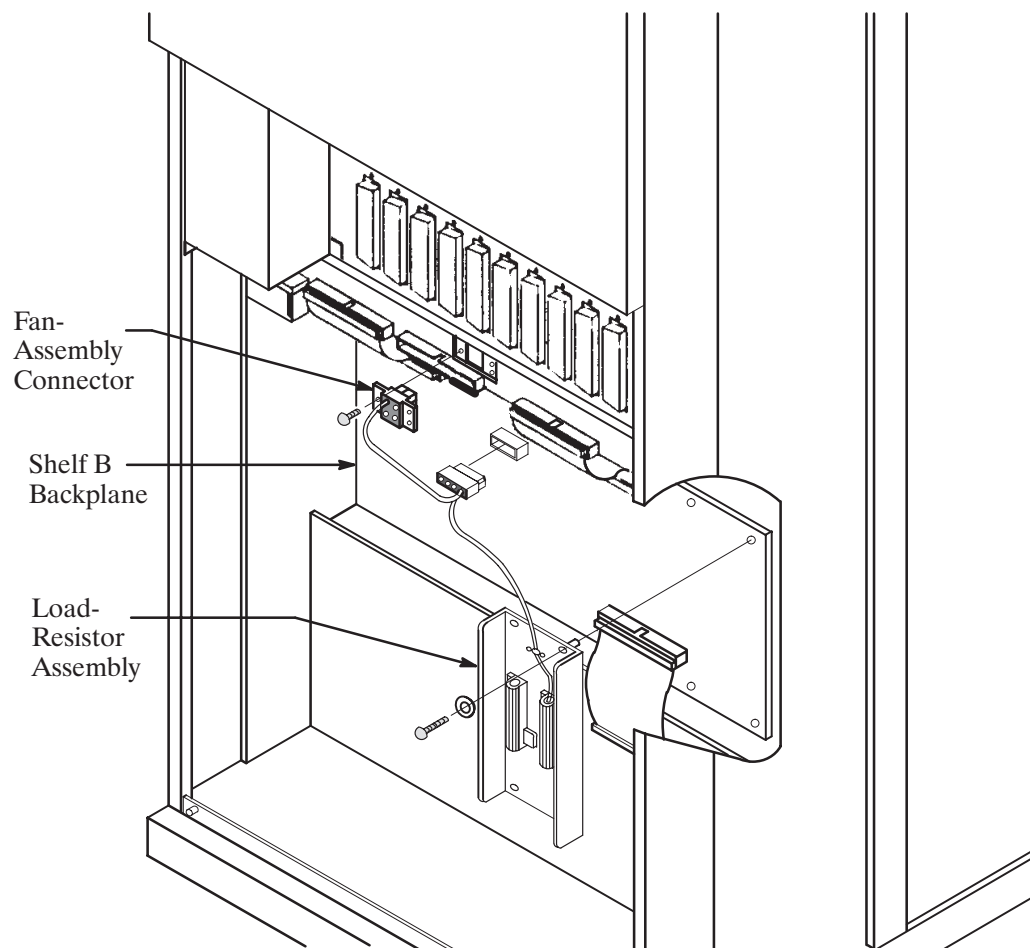

Figure 9-28 Cutaway View of the Load-Resistor Assembly



The Octel Overture 300 is sensitive to static electricity. **Do not** attempt the following procedures without wearing an antistatic wrist strap.

Removing the Load Resistor Assembly from the Octel Overture 300

Use the following procedures to remove the load-resistor assembly:

1. Unlock and open the door of the cabinet.
2. Put on an antistatic wrist strap. Connect it to an unpainted portion of the cabinet.
3. Turn OFF the power supply unit. Refer to the Power Supply Unit Replacement section in this chapter for details about turning OFF the power to the message server.
4. Using a flat-bladed screwdriver, loosen the two captive screws on the front of the fan assembly.
5. Pull the fan assembly forward about 1 inch. The fan assembly does not need to be removed from the cabinet.
6. At the rear of the cabinet, remove the four screws that hold the bottom panel to the back of the cabinet, and set the panel aside.
7. Locate the load-resistor assembly on the shelf B backplane (refer to Figure 9-28). Note that the harness attached to the load-resistor assembly is also attached to the shelf B disk-drive backplane and to the fan assembly.
8. Remove the three screws that secure the fan-assembly connector to the cabinet.
9. Disconnect the harness where it plugs into the shelf B backplane.
10. Remove four screws and washers that secure the load-resistor assembly sheet metal to the cabinet, and set the load-resistor assembly aside.

Installing a Load Resistor Assembly in the Octel Overture 300

Use the following procedures to install a load-resistor assembly:

1. Put on an antistatic wrist strap. Connect it to an unpainted portion of the cabinet.
2. Verify that the power supply switch is OFF.
3. Secure the load-resistor assembly sheet metal to the chassis with the four screws and washers, as shown in Figure 9-28.
4. Connect the load-resistor assembly/fan-assembly harness to the shelf B backplane.
5. Secure the fan-assembly connector to the cabinet with three screws.
6. Attach the bottom rear panel to the cabinet with four screws.
7. Slide the fan assembly back into the cabinet, and secure it with the captive screws on the front of the assembly.
8. Turn ON the message server at the power supply unit switch, and check for correct message-server operation. Make sure that the fans are spinning.
9. Close and lock the door of the cabinet.

Octel Overture 300 Power-Filter Assembly

The power-filter assembly is a unit that includes a power-entry connection and a power-line EMI-suppression filter. The power-line filter varies with input power type; for domestic use the input power is 120/240 Vac, and for international use it is 240 Vac or 48 Vdc.

The power-filter assembly is replaced as a unit. **Do not** disassemble it in any way.



Caution!

The power-filter assembly is sensitive to static electricity. **Do not** attempt the following procedures without wearing an antistatic wrist strap.

Removing the Power-Filter Assembly from the Octel Overture 300

To remove the power-filter assembly, use the following procedures:

1. Unlock and open the door of the cabinet.
2. Turn OFF the power supply unit.
3. If the message server has an a.c. power source, disconnect the power cord at the power-filter assembly and set it aside.

If the cabinet is d.c.-powered, remove the cover from the DC filter assembly and disconnect the wires from the power source at the terminal block mounted on the DC filter assembly.

4. At the rear of the cabinet, remove four screws that secure the top panel to the cabinet. Remove the panel.
5. Put on an antistatic wrist strap. Connect it to an unpainted portion of the cabinet.
6. Remove the three screws that secure the power-filter assembly to the cabinet.
7. Disconnect the wires from the power-filter assembly that lead to the motherboard assembly and set it aside.

 The AC power-filter assembly does not require tools, whereas the DC filter assembly requires an open-ended wrench to disconnect the wires.

Installing the Power-Filter Assembly in the Octel Overture 300

To install the power-filter assembly, use the following procedure:

1. Connect the wires from the motherboard assembly to the power-filter, as shown in Figure 9-25 and Figure 9-26, according to the voltage requirement for the message server.

 When fastening the filter harness to the DC filter assembly, route the connecting wires **away** from the sharp edge.

2. Secure the power-filter assembly to the cabinet with three screws.
3. Fasten the top panel with the four screws.

4. If the cabinet has an a.c. power source, plug the power cord into the power filter.

If the cabinet is d.c.-powered, reconnect the wires from the power source to the terminal block, as shown in Figure 9-29.

5. Turn ON the power supply.
6. Close and lock the door of the cabinet.
7. Test the message server for correct operation.

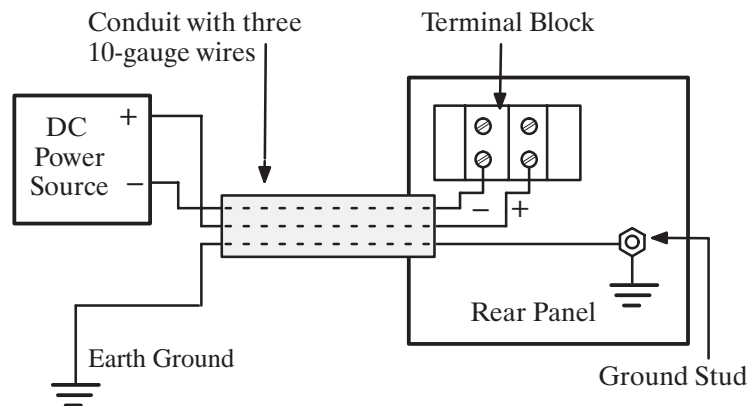

Figure 9-29 Field Wiring for -48-Vdc Powered Octel Overture 300

AC-to-DC Power-Supply Conversion

Before proceeding, read the instructions in the Installing the Octel Overture 200/300 With a -48-Vdc Power Supply Unit section, in the Installation chapter of this volume. Make sure that the material is available to connect the cabinet to the -48-Vdc power source.

The Octel Overture 200/300 can be powered by either an a.c. or d.c. power source.

The Octel Overture 200 contains either an a.c. or d.c. version of the power supply unit to work with the power source selected. The d.c. version of the message server requires an additional d.c. inlet box. To convert the Octel Overture 200 from an a.c.-powered to a d.c.-powered message server, use the Octel Overture 200 instructions.

The Octel Overture 300 contains either an a.c. or d.c. version of the power supply unit and power-filter assembly to work with the power source selected. To convert the Octel Overture 300 from an a.c.-powered to a d.c.-powered message server, use the Octel Overture 300 instructions.



Damage to the message server might occur if replacement procedures are not performed in the order given.

Removing AC Subassemblies from the Octel Overture 200

This conversion requires the Octel Overture 200 AC-to-DC power supply conversion kit, part number 740-6543-001, which contains the following:

- DC power supply unit
- DC inlet box
- DC backplane harness

To remove the a.c. subassemblies, use the following procedures:

1. Remove the a.c. power supply unit, following the instructions in the Removing the Power Supply section in this chapter.
2. Remove the VCU and CPU cards from slots A8 and A9, respectively.
3. Discard the spare fuse attached to the side of the cabinet, located under the power supply unit.
4. Disconnect the power cord at both ends, and set it aside.
5. Remove the fan-panel assembly as described in the Removing the Fan Panel from the Octel Overture 200 section.
6. Remove the AC backplane harness by removing the two screws that hold the connector in the backplane, as shown in Figure 9-22. These screws can be accessed through the front of the cabinet. Remove the hardware that secures the ground wires and the connector from the I/O panel. Pull the harness out of the message server.

Installing DC Subassemblies in the Octel Overture 200

To install the d.c. subassemblies, use the following procedure:

1. Remove the cover on the DC inlet box, as shown in Figure 9-23.
2. Remove the two black screws that hold the I/O panel to the cabinet, and attach the d.c. inlet box to the cabinet using two new screws.
3. Install the d.c. backplane harness, as shown in Figure 9-23.
4. Secure the fan panel to the cabinet, as described in the Installing the Fan Panel in the Octel Overture 200 section.
5. Reinstall the VCU and CPU cards in slots A8 and A9, respectively.
6. Install the d.c. power supply unit following the instructions in the Installing the Power Supply Unit section.
7. Secure the new spare fuse to the side of the cabinet.
8. Locate the message-server label on the base of the cabinet, at the rear. Mark the box on the label indicating d.c. power. Remove the mark from the box indicating a.c. power.

Removing AC Subassemblies from the Octel Overture 300

This conversion requires the Octel Overture 300 AC-to-DC power supply conversion kit, part number 740-6100-001, which contains the following:

- DC power supply unit
- DC filter assembly
- DC backplane harness

To remove the a.c. subassemblies, use the following procedure:

1. Remove the AC power supply unit, following the instructions in the Removing the Power Supply section.
2. Remove the VCU and CPU cards from slots A13 and A14, respectively.
3. Remove the AC Power Filter Assembly, following the instructions in the Removing Power Filter Assembly from the Octel Overture 300 section.
4. Remove the a.c. filter-to-backplane harness by removing the two screws that hold the connector in the backplane, as shown in Figure 9-24 or Figure 9-25. These screws can be accessed through the front of the chassis. Remove the nuts and washers that secure the ground wires. Pull the harness out of the message server.

Installing DC Subassemblies in the Octel Overture 300

To install the d.c. subassemblies, use the following procedure:

1. Install the d.c. filter-to-backplane harness, as shown in Figure 9-26.
2. Connect the wires from the backplane harness to the d.c. filter assembly, as shown in Figure 9-26.
3. Fasten the d.c. filter assembly to the cabinet, with three screws.
4. Fasten the top panel to the cabinet, with four screws.
5. Reinstall the VCU and CPU cards in slots A13 and A14, respectively.
6. Install the d.c. power supply unit, following the instructions in the Installing the Power Supply section.
7. Locate the message-server label on the base of the cabinet at the rear. Mark the box on the label indicating d.c. power. Remove the mark from the box indicating a.c. power.

Field Wiring to DC Power Source

Connect the Octel Overture 200/300 to a d.c. power source as described in the Installation chapter, Installing the Octel Overture 200/300 With a –48-Vdc Power Supply Unit section.

Option Control Chip Replacement

The Option Control Chip (OCC) is the component that controls the features that are installed on the Octel Overture 200/300. The OCC assembly is an 8-pin integrated circuit inserted into a socket that is soldered onto the motherboard, as shown in Figure 9-30 and Figure 9-31.

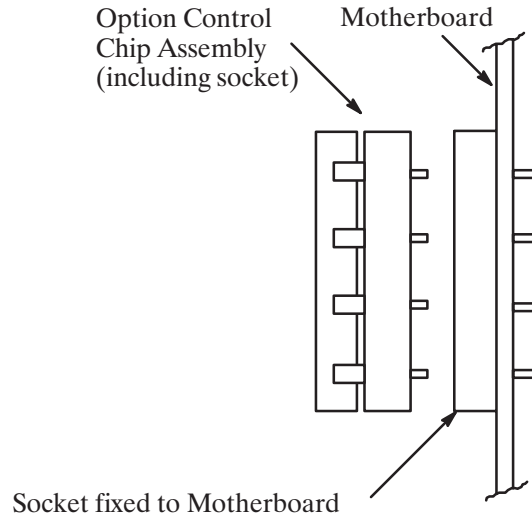

Figure 9-30 Option Control Chip (OCC) Assembly

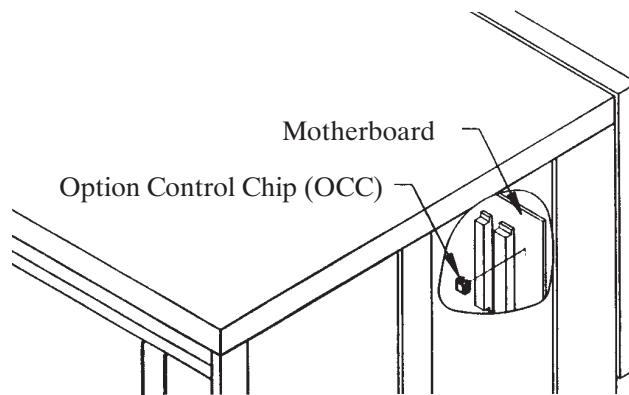

Figure 9-31 Location of Option Control Chip (OCC) in the Octel Overture 200/300



The OCC assembly is sensitive to static electricity and should be handled as little as possible. **Do not** attempt the following procedures without wearing an antistatic wrist strap.

Removing the OCC

The OCC assembly should always be moved as a unit that includes the OCC integrated circuit and the socket in which it is mounted. The two parts of the assembly should never be separated.

1. Perform the procedure in the Removing the Power Supply section.
2. After the power supply is removed, remove the CPU and the VCU cards. Follow the instructions in the Printed Circuit Assembly Replacement section.
3. Locate the OCC assembly next to the top power supply connector on the motherboard. Using an IC puller, **carefully** pry the entire OCC assembly from the motherboard. If a pin is broken or bent during removal, a new OCC must be ordered.
4. Place the OCC assembly on an antistatic foam pad.

Installing the OCC

To install the OCC assembly, use the following procedures:

1. Install the new OCC assembly next to the top power supply connector on the motherboard. Pin 1 on the OCC assembly must be up.
2. Replace the CPU and the VCU cards, as described in the Printed Circuit Assembly Replacement section of this chapter.
3. Replace the power supply unit, as described in the Power Supply Unit Replacement section of this chapter.
4. Turn ON the message server, and test for correct operation.
5. Close and lock the door of the cabinet.

9.3 MESSAGE SERVER ASSEMBLY DESCRIPTIONS AND PART NUMBERS

Octel Overture 200 Assemblies

Assemblies used in the Octel Overture 200 are as follows:

Assembly	Part Number
System Motherboard, Board Assembly	740-6503-001
CPU, Board Assembly	300-6039-001
VCU, Board Assembly	300-6001-004
90- to 132-Vac Power Supply Assembly	740-6504-001
180- to 260-Vac Power Supply Assembly	740-6505-001
42- to 60-Vdc Power Supply Assembly	740-6506-001
AC-to-DC Power Supply Conversion Kit	740-6543-001
Hard-Disk Drive, 500 MB (0 hour drive)	740-6632-002
Hard-Disk Drive, 1.0 GB (0 hour drive)	740-6631-002
Hard-Disk Drive, 2.0 GB (0 hour drive)	740-6633-002
Maintenance Port Cable	520-6502-001
Fan Power Harness	530-6501-001
Fan Panel Assembly	740-6502-001
Air Filter	840-6507-001

Octel Overture 300 Assemblies

Assemblies used in the Octel Overture 300 are as follows:

Assembly	Part Number
System Motherboard, Board Assembly, Shelf A	740-6003-001
SCSI Motherboard, Board Assembly, Shelf B	300-6006-001
SCSI Motherboard, Board Assembly, Shelf C	300-6005-001
CPU, Board Assembly, 8 megabytes	300-6039-001
VCU, Board Assembly	300-6001-004
120-Vac Power Supply Assembly	740-6016-001
240-Vac Power Supply Assembly	740-6017-001
-48-Vdc Power Supply Assembly	740-6027-001
AC-to-DC Power Supply Conversion Kit	740-6100-001
Hard-Disk Drive, 500 MB (0 hour drive)	740-6632-002
Hard-Disk Drive, 1.0 GB (0 hour drive)	740-6631-002
Hard-Disk Drive, 2.0 GB (0 hour drive)	740-6633-002
Floppy Drive Assembly	740-6010-001
SCSI Bus Jumper Cable	520-6001-001
Maintenance Port Cable	520-6003-001
Fan Power Harness	530-6001-001

Assembly	Part Number
120-/240-Vac Filter-to-Backplane Harness	530-6009-001
48-Vdc Filter-to-Backplane Harness	530-6021-001
Disk Power Harness	530-6010-001
Fan Tray Assembly	740-6002-001
Air Filter	840-6013-001
Load Resistor Assembly	740-6128-001
120-Vac Power Filter Assembly	740-6006-001
240-Vac Power Filter Assembly, Domestic	740-6028-001
240-Vac Power Filter Assembly, European	740-6031-001

Octel Overture 200/300 Assemblies

Assemblies used in both the Octel Overture 200 and the Octel Overture 300 are as follows:

Assembly	Part Number
Option Control Chip (OCC), Replacement	FK 90004
Line Card, Board Assembly, U. S., Canada, Mexico, 4-port	300-6002-001
Line Card, Board Assembly, U. S., Canada, Mexico, 8-port	300-6032-001
Line Card, Board Assembly, U.S, Canada, Mexico, 16-port	300-6054-001
Line Card, Board Assembly, United Kingdom, 4-port	300-6002-002
Line Card, Board Assembly, United Kingdom, 8-port	300-6032-002
Line Card, Board Assembly, United Kingdom, 12-port	300-6056-002
Line Card, Board Assembly, United Kingdom, 16-port	300-6054-002
Line Card, Board Assembly, France, 4-port	300-6044-001
Line Card, Board Assembly, Germany, 4-port	300-6044-005
Line Card, Board Assembly, Netherlands, 4-port	300-6002-009
Line Card, Board Assembly, Netherlands, 8-port	300-6032-009
Line Card, Board Assembly, New Zealand, Australia, 4-port	300-6002-011
Line Card, Board Assembly, New Zealand, Australia, 8-port	300-6032-011
Telemarketing Line Card, Board Assembly, 8-port	300-6032-003
Telemarketing Line Card, United Kingdom, 8-port	300-6032-004
Telemarketing Line Card, New Zealand, Australia, 8-port	300-6032-012
Direct Access Card (DAC)	300-6027-001
Direct Access Card (DAC), New Zealand, Australia, 4-port	300-6027-011
Fax Application Processor, 4-channel	300-6037-002
Fax Application Processor, 8-channel	300-6037-003
LAN card	300-6049-001
Northern Telecom Integration Card (SLIC)	300-6009-001
AT&T Integration Card (ATTIC)	300-6018-001
ROLM Integration Card (RIC)	300-6025-001
Mitel Integration Card (MIC)	300-6020-001
Serial Integration Card for the Meridian 1 (SIC8)	300-6040-001
APIC Integration Card for AT&T Systems	300-6058-003
NPIC Integration Card for Northern Telecom	300-6058-004

10

DIGITAL TRUNK INTERFACE CARD (DTIC)

Chapter Contents

10.1	Digital Trunk Interface Card (DTIC) Overview	10-1
	DTIC Hardware	10-1
10.2	How to Configure the DTIC	10-3
	System Parameters	10-3
	Class of Service	10-4
	LSP Table	10-4
	SLOTS Table	10-4
10.3	Troubleshooting and Maintenance	10-10
	Diagnostics	10-10
	DTIC Not Up	10-11
	Call into System, Phone Rings but Is Never Answered	10-19
	System Answers but Voice Quality Is Poor	10-19
	System Answers but Pops or Buzzes	10-19
	Modem Connection Has Garbage Characters	10-19
	Ports on the DTIC Configured for Ringing but Do Not Answer Calls	10-19
	DTIC Still Does Not Operate Correctly	10-20

Figure

10-1	DTIC Component Layout	10-2
------	-----------------------------	------

10.1 DIGITAL TRUNK INTERFACE CARD (DTIC) OVERVIEW

The DTIC is applicable only to specific Octel channels in Europe and is available only through those channels.

This chapter contains information specific to the digital trunk interface card (DTIC). Included are details about hardware, installation, configuration, and maintenance and troubleshooting. The DTIC is not documented elsewhere in this manual.

The DTIC is a 30-port line card designed to interface an Octel Overture 200/300 to E1 trunks.

E1 trunks are the European “building block” standard for Wide Area Network (WAN) communication. E1 is specified by CCITT and also standardized by ETSI. An E1 trunk can carry 30 simultaneous phone calls plus signaling information. A port carries voice and data for calls. Each port can be viewed as a “virtual” telephone connection where each end is either on hook or off hook.

For the DTIC to operate correctly, two tables must be configured in the Octel Overture 200/300: the SLOTS Table and the SYSTEM PARAMETER Table. An LSP Table is also used by the Octel Overture 200/300. A COS must be configured for each of the 30 DTIC ports.

DTIC Hardware

The DTIC consists of two major processing components: the control processor (CP) and five digital signal processors (DSPs). Refer to Figure 10-1 showing the layout of the primary components on the card.

To connect the Octel Overture 200/300 to the PBX, use two 75-ohm coax cables. Be sure that the sw1 and sw2 switches on the card are set correctly to 75 ohms and 120 ohms for Germany. Refer to Figure 10-1.

Three kits are available.

Kit Name	Kit Part Number	Included in Kit
75 ohm DTIC-E1 Kit	740-6254-002	DTIC-E1 card, DTIC-E1 adapter (BNC version), grounding strip, EMI suppression material, and fastening hardware (does not include cables)
120 ohm DTIC-E1 Kit	740-6254-003	DTIC-E1 card, grounding strip, EMI suppression material, and fastening hardware (does not include cables)
DTIC-E1 Grounding Strip Materials Kit	740-6255-001	Grounding strip and fastening hardware (does not include cables)

Refer to the Installation chapter, DTIC Pin Assignment section, for the 50-pin telco connector pin assignments for the DTIC. Refer to the Hardware Replacement chapter, DTIC Replacement section, for the procedure for replacing/installing a DTIC.

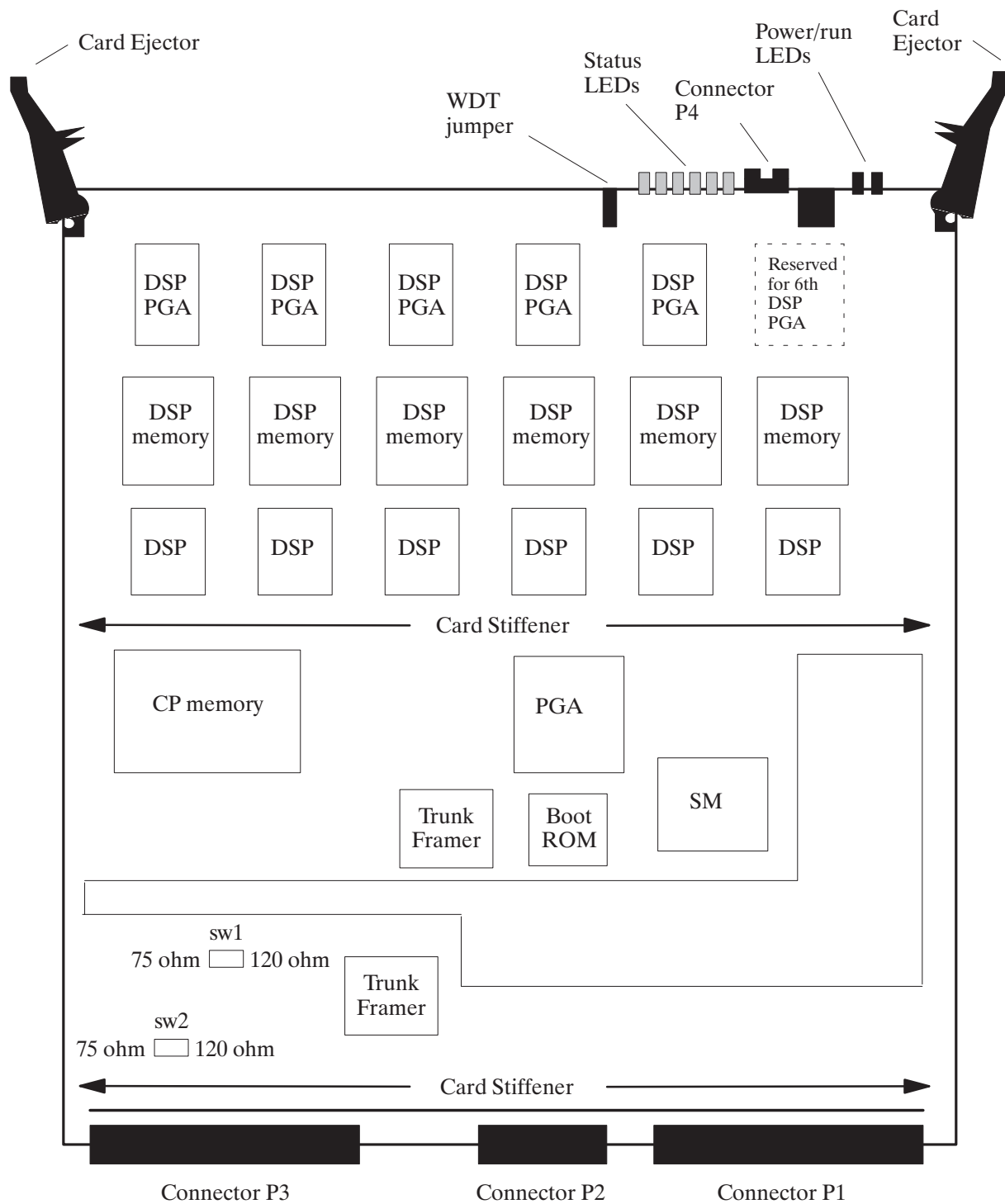



Figure 10-1 DTIC Component Layout

10.2 HOW TO CONFIGURE THE DTIC

For the DTIC to operate correctly, the Octel Overture 200/300 for the DTIC must be configured correctly. The major items for configuration are the following:

- System Parameters
- COS
- SLOTS Table

 The correct LSP Table must be selected during configuration of the SLOTS Table. The LSP Table, with the name ACULAB, first must be added and configured at a password level higher than Maintenance level.

Special information regarding integration and configuration, including information about the LSP Table, is provided in the integration document DPNSS-ACULAB-03/96.

System Parameters

Several system parameters must be properly set to allow the DTIC to work correctly:

- System Parameter 3 — PBX TYPE and PBX MODEL.
Set the PBX type and PBX model to the correct settings.
- System Parameter 9 — FLASH TIME (MSEC).
Set the flash time to 130 msec.
- System Parameter 13
Set the five parts of this parameter. The settings are PBX dependent.
 - TRANSFER INITIATE CODE
 - RECONNECT CODE AFTER NO-ANSWER
 - RECONNECT CODE AFTER BUSY
 - RECONNECT CODE AFTER FAST BUSY
 - TRANSFER COMPLETE CODE
- System Parameter 51 — RS-232 INTEGRATED WITH PBX.
Does not have to be integrated to work. The setting is site dependent.
- System Parameter 77 — PBX PROVIDES MOMENTARY DISCONNECT.
Set to YES.
- System Parameter 117 — RINGBACKS BEFORE ANSWERING AX PORT.
Set to 3, 4, or 5 for integrated systems or to 0 if not integrated. This setting is site specific and depends on customer preference.

- ❑ System Parameter 175 — PORT NUMBER FOR CALL RECORDS TO FIRST PORT.
These settings are site specific and depend on the numbering of PBX extensions. The following is an example of settings for the four parts of this parameter:
 - ❑ Number of digits in the extension number fields to 5
 - ❑ Number of digits in the port number field to 3
 - ❑ Fill character to 0 (zero)
 - ❑ Port number used in call records to 1
- ❑ System Parameter 198 — PCM ENCODING FOR THE SYSTEM.
Set to 1, for A-law.

Voice data is encoded, in the E1 environment, into 8 bit numbers (called octets) that are sent 8000 times per second for each port. This process of sampling and encoding analog voice to these octets is called Pulse Code Modulation (PCM). PCM uses two standard algorithms for conversion: A-law, which is used primarily in Europe, and U-law, which is used in North America. If DTIC voice quality sounds consistently bad but still recognizable, the DTIC could be operating with the wrong PCM law. To correct this low voice quality, change the PCM law and restart the message server.

⇒ **Important:** If a DTIC card is configured for A-law, 4- or 8-port line cards cannot be used:

- ❑ To receive fax calls
- ❑ For modem connection using the `# # # 5` command

Class of Service

A COS must be configured for each of the 30 DTIC ports. Assign attributes as required. Refer to the *Configuration* volume, COS chapter.

LSP Table

LSP tables are preconfigured and exist in the system. The LSP Table defines control parameters for different DSP-based line/trunk interface cards and the DSP-based integration cards. Each LSP Table has fields that define values for control parameters needed for correct operation of the card. These values are downloaded to the card when it boots up.

In UPDATE, the LSP Tables can be listed by the command `LIST LSP`. If problems exist because of an LSP Table configuration, information about these parameters is useful if it is necessary to call technical support for help.

SLOTS Table

The slot in which a DTIC is to be installed must be added to the SLOTS Table. Adding a slot for a DTIC is similar to adding a slot for other line cards. However, there are some questions pertaining specifically to the DTIC.

Slots can be skipped, as for any line cards. However, the grounding strip is for only the first seven slots. With Capacity on Demand, the number of ports for the DTIC are purchased as required.

After the slot is configured, the system must be restarted for the DTIC to become operational.

Configuring Slots for the DTIC

The DTIC card is physically connected to a PBX extension (a single line) via two 75-ohm coax cables to support 30 ports. The PBX directs calls to the message server for answering.

The SLOTS Table contains information about each port on the DTIC card.

Each port connected to a PBX extension can be configured to handle calls differently. For non-integrated systems, the port extensions must be set up in one or more hunt groups in the PBX. Each hunt group can be configured to handle calls differently.

The following example shows only eight ports. The DTIC can have up to 30 ports configured.

SLOT	CARD TYPE	PORT	EXTENSION #	COS	MODE	OUTCALL	TEST	SYS
4	DTC17-E1	1		254	AX	NO	NO	7
		2		254	AX	NO	NO	8
		3		254	AX	NO	NO	9
		4		254	AX	NO	NO	10
		5		254	AX	NO	NO	11
		6		254	AX	NO	NO	12
		7		254	AX	NO	NO	13
		8		254	AX	NO	NO	14

LSPTAB table: ACULAB
SECONDARY SYNC RECEIVER OF CLOCK

The following describes the valid or invalid entries for the SLOTS Table fields:

SLOT Enter the slot number to be configured — slots 1–6 for the Octel Overture 200 and slots 1–7 for the Octel Overture 300.

 Because the grounding strip used for the DTIC is only for seven slots, in effect the slots available for the Octel Overture 300 are slots 1–7.

CARD TYPE Enter the number for a DTIC card — **23**–DTC17–E1.

PORT Configure the ports in consecutive order. Specifies the port (channel) number on a card. DTIC cards have 30 channels each. If two DTIC cards are installed in slots 1 and 2, the channel numbers on the card in the second slot start with port 31.

EXTENSION # Enter the PBX extension number connected to each message server port. A mailbox extension number **cannot** be the same as a port extension number.

COS Enter the COS for each port on the card. Directs the message server to other system tables for the days and times to activate features and where to get further instructions for handling the call.

Assign port/trunk COS in descending order, starting with the highest-numbered COS.

MODE

Enter the Answering Mode. Must be either Primary Answer (AX), Secondary Answer (CX), or Message Center (MX). Determines how the message server handles the call when that port answers. For further details on answering modes, refer to the *Product Description* volume, General Description chapter, and to the *Configuration* volume, Slots Table chapter, Line Cards section.

OUTCALL

Enter YES or NO to enable or disable message waiting, network message, and alarm calls. Specifies whether the port may place a call. Provide this information for each port on the card.

☞ For message waiting notification or alarm outcalls, multiple calls can be placed simultaneously.

☞ Some PBXs require that the same port/extension activate and deactivate the message waiting lamp. To do this, define System Parameter 106 — LAMP MESSAGE WAITING PORT, with the port number to use.

Nonintegrated Systems. In most cases, allow **all** ports to make outcalls. When all ports are defined as YES, the message server only makes outcalls when no more than 2 of the ports are in use. This leaves ports available for incoming calls. If NO is defined for any ports, all ports defined as YES are used for outcalls, even when more than 2 are in use.

It is recommended that NO for OUTCALL be used only for special applications.

Integrated Systems. If eight or fewer ports are configured, the message server makes outcalls when at least two ports are idle. If 9–32 ports are configured, the message server makes outcalls when at least three ports are idle. If more than 32 ports are configured, the message server makes outcalls when at least four ports are idle.

SYNC

Enter 1, 2, or 3 to specify that this card is the primary, secondary, or tertiary system clock sync source or N that the card is not used as a clock sync source.

If no other cards (PIC or other DTIC) have been selected as the primary clock sync source, enter 1. If another card has been selected as the primary clock sync source, enter 2. If other cards have been selected as the primary and secondary clock sync source, enter 3. Otherwise, enter N.

If the card selected as the primary clock sync source has problems (for example, the clock is lost), the system CPU switches to the secondary clock sync source. If the secondary fails, the CPU switches to the tertiary clock sync source. If the tertiary fails, the CPU uses its own internal but less accurate clock crystal.

SYS

Designates the system port number for each port on a DTIC card. The port numbers are allocated sequentially by the system.

LSPTAB

Enter the number to specify the LSP Table to be referenced for this slot.

- ☞ The LSP Table for this DPNSS integration first must be added and configured at a password level higher than Maintenance level. If the ACULAB LSP Table does not appear in the list of LSP Tables, contact Technical Support to add the table and configure it correctly.

Adding or Modifying a DTIC Card

When adding DTIC cards, ports can be added if the number of used ports is less than the number of authorized ports. The message server checks to see that the number of ports configured does not exceed the maximum number of DSP ports purchased.

After the card type is entered, the LSP Table must be entered. The name of the LSP Table to choose is ACULAB. After the LSPTAB table is chosen, enter information about each port, including extension number, COS, answer mode (AX, CX, MX), if the port is used for message waiting and network outcalling (Y/N), and test channel (Y/N).

- ☞ The LSP Table for this DPNSS integration first must be added and configured at a password level higher than Maintenance level. If the ACULAB LSP Table does not appear in the list of LSP Tables, contact Technical Support to add the table and configure it correctly.

.A SLOT

```

Enter SLOT NUMBER to ADD.
Enter empty line when done.
ADD:2

    6 -LIC4          5 -MITEL          2 -SLIC          8 -ACP
    7 -DAC4          50-PICROLM       3 -RIC           16-FAX8
    10-LIC8          51-PICATT        4 -ATTIC        17-FAX4
    11-TLC8          52-PICNT         13-SIC8         22-LAN
    18-LIC4I
    23-DTC17-E1
    25-DTC17-ISDN
    26-DLC16
    33-ILIC12FR
    34-ILIC12UK
    35-ILIC12JP
    37-ILIC12GR
Enter Card Type.
SLOT 2 :23

Enter LSP table to be referenced for this slot.
    0-DEFAULT      6-IL12US_S      12-DL1690      18-IL12UK_C      24-PIC_NT
    1-IL12FR_S     7-DL16FR        13-DPNSS_CB    19-IL12FR_C      25-PIC_ROLM
    2-IL12GE_S     8-T1            14-DL16UK_C    20-IL12GE_C      26-DL16SNG
    3-DL16US        9-MD110-E1     15-DL16NTH     21-IL12US_C      27-DL16OS
    4-DL16AU        10-DL16UK_S    16-DL16TOSH    22-EUROISDN
    5-DL16GE        11-IL12UK_S    17-DL16TIE     23-PIC_AT&T
(Empty line = 0)
MOD:9

Should this card be:
    (1 - PRIMARY
    2 - SECONDARY
    3 - TERTIARY
    N - no ) sync receiver of the master clock?
(1-3, N. Empty line = N):2

Enter information for each PORT.
Enter as: EXTENSION NUMBER connected to each port (1-8 digits),
CLASS-OF-SERVICE (0-254), ANSWER MODE (AX, CX, MX), USE PORT FOR
MESSAGE WAITING AND NETWORK OUTCALLING (Y/N)

1: N,254,AX,N
2: N
3: N
.
.
.
28: N
29: N
30: N

```

 The number of the ACULAB LSP Table might not be 49, as it is in this example, because this LSP Table is not part of the Serenade software. If the ACULAB LSP Table does not appear in the list of LSP Tables, contact Technical Support to add the table and configure it correctly.

Modifying a DTIC card in the SLOTS Table is similar to adding a DTIC.

```

.M SLOT
Enter slot number to MODIFY
Enter empty line when done.
MOD:5
6 -LIC4      2 -SLIC      8 -ACP
7 -DAC4      3 -RIC       17 -FAX4
10 -LIC8     4 -ATTIC     16 -FAX8
11 -TLC8     13 -SIC8     22 -LAN
18 -LIC4I
5 -MTEL
23 -DTC17-E1
26 -DLC16
50 -PICROLM
51 -PICATT
52 -PICNT
33 -ILIC12FR
34 -ILIC12UK
35 -ILIC12JP
37 -ILIC12GR
Enter card type.
SLOT 5:23
Enter LSPTAB table to be referenced for this slot.
0-DEFAULT
1-ILC12_FR
2-ILC12_GE
3-DLC16_US
4-DLC16_AU
5-DLC16_GE
6-ILC12_US
7-DLC16_FR
8-T1
9-MD110-E1
10-DLC16_UK
11-DLC16_UK
12-DLC16_90
49-ACULAB
MOD:9
Should this card be:
(1 - PRIMARY
2 - SECONDARY
3 - TERTIARY
N - no ) sync receiver of the master clock (1-3, N):2
Enter PORT NUMBER to ADD or MODIFY.
Modify port (1 - 30 )
Enter empty line when done.
PORT:1
Enter information for each PORT.
Enter as: EXTENSION NUMBER connected to each port (1-8 digits),
CLASS-OF-SERVICE (0-254), ANSWER MODE (AX, CX, MX), USE PORT FOR MESSAGE
WAITING AND NETWORK OUTCALLING (Y/N)

1 : n,254,ax,n
2 : n
3 : n
.
.
.
28: n
29: n
30: n

```

 The number of the ACULAB LSP Table might not be 49, as it is in this example, because this LSP Table is not part of the Serenade software. If the ACULAB LSP Table does not appear in the list of LSP Tables, contact Technical Support to add the table and configure it correctly.

10.3 TROUBLESHOOTING AND MAINTENANCE

After the installation and configuration of the DTIC is complete and the system has been restarted, verify whether phone calls can be placed by simply calling the system on one of the DTIC voice mail ports. If the call is successful (you get the voice mail greeting and there is no popping or buzzing indicating clock sync problems), the DTIC installation is successful.

If phone calls cannot be placed to the message server, several commands help in troubleshooting the DTIC card. The following subsection lists these commands. Following that are subsections giving a series of problems with possible solutions to help in troubleshooting the system.

Diagnostics

The CONNECT command logs onto the DTIC card. At the @ prompt, enter

```
CONN x 
```

where x is the slot number of the DTIC. The following message appears:

```
Connecting to E1      in slot 1
```

Three status commands give information about the status of the trunks, card, and ports:

- ST TR gives the status of the trunks.
- ST CARD gives the status of the DTIC card.
- ST x, where x is a port number (1–30), gives the status of that port.
- LIST STATS gives a count of errors seen by the trunk.

 Putting a c after any status command repeats the status indefinitely to the terminal until the ESC key is pressed. For example, ST 1 C causes the status of port 1 to be updated continually, rather than giving the status only one time.

To exit from the DTIC, at the dtic> prompt, enter

```
EXIT 
```

The following message appears:

```
Disconnecting from E1.
```

DTIC Not Up

The supervisor terminal is the virtual session you see on the DTIC card when you use the `CONNECT` command to connect to the DTIC. The supervisor terminal may not indicate that the DTIC is up or stayed up. This problem is likely caused by the E1 trunk being down. This terminology is used because personnel with the proper cable can connect a terminal directly to the front of the DTIC card.

Once logged onto the DTIC, you can request the status of the trunk, the card in general, and any of the 30 ports (channels). An example of the status for a bad trunk follows. The trunk, card, and port 1 (channel 1) status are shown in order.

To request the status of the trunk, at the `dtic>` prompt, enter

```
dtic>ST TR 
```

```
dtic>ST TR
----- DS1A Signal Status -----
RECEIVE                                TRANSMIT
  State:      Loss of Signal            Traffic:     Disabled
  RAI:        OFF                       RAI:        OFF
  AIS:        OFF                       AIS:        OFF
  Line Code:  ???                       Mode:       Non-CRC4
                                           Loopback:   OFF
  Excess CRC Failures: NO
  Excess FAS Errors:  NO
  Excess FEBE:       NO

----- Timeslot 16 Signaling Channel Status -----
RECEIVE                                TRANSMIT
  State:      Out of frame              Mode:       CAS
  MF RAI:    OFF                       MF RAI:    ON
  AIS:       OFF                       AIS:       OFF

----- CM State -----
State: On-line
```

The `TRANSMIT Traffic` field shows `Disabled`, which indicates that the card will not transmit. The `RECEIVE State` field shows `Loss of Signal (LOS)`, which indicates that the E1 trunk is not being detected. Because the main trunk is `LOS`, timeslot 16 will also have problems; its state is `Out of Frame`. The card state is still `On-line` because it is operational but cannot complete calls because of trunk problems. If the state is not `On-line`, the card also will not correctly complete calls. The following gives basic information about the fields for the status of the trunk.

DS1A Signal Status — state of entire trunk

Field	Possible values	Description
RECEIVE		
State	In frame Out of frame Loss of Signal	Normal. Functioning but has problems. Not functioning.
RAI (Remote Alarm Indication)	OFF ON	Remote end receiving signal and detects no problems. Remote end detects problems with signal from DTIC.
AIS (Alarm Indication Signal)	OFF ON	Normal. Problem with far end sending pattern, cannot make phone calls.
Line Code:	AMI (Alternate Mark Inversion) HDB3 (High Density Bipolar with 3 bits) ???	Normal. HDB3 mode is enabled. HDB3 pattern being sent. Loss of signal. The question marks (???) appear in the field.
Excess CRC Failure (Cyclic Redundancy Check)	NO Number of excess failures	If the mode is not CRC4 (the mode used in Europe). The signal for the check is sent 1,000 times/second. When the check fails more than about 888 times/second, the digit is incremented.
Excess FAS Errors (Frame Alignment Signal)	NO YES	In checking for FAS errors, a signal with a repetitive pattern is sent by the far end at 8,000 times/second. If the DTIC does not receive an expected item from the pattern several times in a row, the field changes to YES.
Excess FEBE (Far End Block Error)	NO YES	Signal from DTIC is okay. Signal from DTIC has problems. This field applies only for CRC mode.
TRANSMIT		
Traffic	Disabled Enabled	DTIC not able to actively place phone calls. The card is not usable. The signal that the DTIC is receiving is not satisfactory.
RAI (Remote Alarm Indication)	OFF ON	Near end receiving signal and detects no problems. Near end detects problems with signal from PBX.
AIS (Alarm Indication Signal)	OFF ON	Normal. Near end initializing, cannot make phone calls.
Mode	CRC4 Non-CRC4	The network is using this advanced error checking. The network is not using CRC4.
Loopback	OFF ON	Special looping diagnostics are being run. Normal operation — not looping.

Timeslot 16 Signaling Channel Status — state of only this channel

Field	Possible values	Description
RECEIVE		
State	In frame Out of frame	Normal operation. Can send voice data but not information regarding call progress, etc.
MF RAI (Multi-Frame Remote Alarm Indication)	OFF ON	Far end satisfied with signal on this channel. Far end not satisfied.
AIS (Alarm Indication Signal)	OFF ON	Normal. Problem with far end sending pattern, cannot make phone calls.
TRANSMIT		
Mode	CAS	CAS (Channel Associated Signaling) is the only mode currently.
MF RAI (Multi-Frame Remote Alarm Indication)	OFF ON	DTIC satisfied with signal being received. DTIC not satisfied with signal being received.
AIS (Alarm Indication Signal)	OFF ON	Normal. Problem.
CM State*		
State	On-line Off-line	Normal. Not functioning. For example, the card may be off-line for 20–30 minutes when the system is being booted. The card doesn't think the system knows the card is there. ☞ When the card is being brought up, the CM State normally starts off-line for 10 seconds to 30 minutes, depending on whether the system software is already up or not.

* Card Manager (CM) is the basic high-level software for the DTIC card.

Both the card and port status also indicate problems. Following is the status card listing:

```
dtic>ST CARD
----- Channel Status - ALL -----
CARD STATE:      DOWN
SEQUENCER PC:    C2

CLOCK MASTER:    Disabled
CLOCK ACTIVE:    Disabled
```

The card status explicitly says that the card is DOWN, although the reason is not given. The reason is given in the trunk status. Also, the card is not actively configured as a clock master (that is, the status is “Disabled”) by the system, a consequence of the card being down. The following gives basic information about the fields for the status of the card.

Channel Status – ALL — state of the card

Field	Possible values	Description
CARD STATE	UP DOWN	Card is ready for traffic. Card is not ready for traffic. The CARD STATE should agree with the Traffic field under the TRANSMIT section of the trunk status.
SEQUENCER PC*	Value from 00 to ff (hex)	Informational only — for use by Octel Engineering.
CLOCK MASTER	Enabled Disabled	DTIC enabled as clock master. DTIC not enabled as clock master.
CLOCK ACTIVE	Enabled Disabled	A good clock is being received from the network. A good clock is not being received from the network.

* A Sequencer PC is a virtual software entity (like a little computer) that has its own task to perform on a specific part of the card's software. For example, there is a separate Sequencer PC for keeping track of the health of each port.

Following is the port status for port 1:

```

dtic>ST 1
----- Channel 01 Status -----
RECEIVE                TRANSMIT
  ABCD:  0000                ABCD:  1111

OTHER
  CHANNEL STATE:  ON HOOK
  SEQUENCER PC:   0f

```

The port status indicates that code 1111 is being sent. This code occurs because the card is down and the DTIC is not ready to receive a call from the PBX. The SEQUENCER PC status 0f indicates that the port is waiting to be told to operate. Generally, 0f means down. The following gives basic information about the fields for the status of a port (channel).

Field	Possible values	Description
Channel 01 Status		
RECEIVE		
ABCD ABCD represents bit patterns (range 0000–1111). Given here are a few common patterns. Other patterns would be for unusual circumstances.	0001 1101 0101 1101→1001→1101 0000	Idle/on-hook. Off-hook. Busy/error. Flash. No information or an invalid pattern being received from the other end.

Field	Possible values	Description
TRANSMIT		
ABCD	0001 1101 0001→1101→1111 1101→1001→1101 1111	On-hook. Off-hook. Wink. Flash. Busy/error.
OTHER		
CHANNEL STATE	ON HOOK OFF HOOK	
SEQUENCER PC*	Value from 00 to ff (hex) 0f 02 fe and ff 00 to fd	Informational only — for use by Octel Engineering. Down. The port is waiting to be told to operate. Up, idle, and ready for calls. The port is down because of an internal error. Most of the other possible values are used when the port is processing calls.

* A Sequencer PC is a virtual software entity (like a little computer) that has its own task to perform on a specific part of the card's software. For example, there is a separate Sequencer PC for keeping track of the health of each port.

For comparison, the following examples show connection to a properly operating DTIC.

The ST TR command shows the status of the trunk:

```

dtic>ST TR
----- DS1A Signal Status -----
RECEIVE                                TRANSMIT
State:      In Frame                    Traffic:    Enabled
RAI:        OFF                         RAI:       OFF
AIS:        OFF                         AIS:       OFF
Line Code:  HDB3                        Mode:      Non-CRC4
                                                Loopback:  OFF
Excess CRC Failures: NO
Excess FAS Errors:  NO
Excess FEBE:       NO

----- Timeslot 16 Signaling Channel Status -----
RECEIVE                                TRANSMIT
State:      In CAS Frame                 Mode:      CAS
MF RAI:     OFF                         MF RAI:    OFF
AIS:        OFF                         AIS:       OFF

----- CM State -----
State: On-line

```

This example shows normal trunk status.

The ST CARD command shows the status of the card:

```
dtic>ST CARD
----- Channel Status - ALL -----
CARD STATE:      UP
SEQUENCER PC:    C2
CLOCK MASTER:    Enabled
CLOCK ACTIVE:    Enabled
```

This example shows normal card status. In this example, the card is enabled to be the synchronization receiver of the master clock.

The ST 1 command shows the port status for port 1 (channel 1):

```
dtic>ST 1
----- Channel 01 Status -----
RECEIVE                TRANSMIT
  ABCD: 0001            ABCD: 0001
OTHER:
  CHANNEL STATE:  ON HOOK
  SEQUENCER PC:   02
```

This example shows normal port status for port 1. The port is idle and is transmitting and receiving the on-hook code.

The LIST STATS command gives a count of errors seen by the trunk:

```
dtic>LIST STATS
ts_oof_cnt           = 0
ts_oof_crc_cnt       = 0
ts_lcv_cnt           = 0
ts_bit_slip_cnt      = 0

ts_crc_fail_cnt      = 0
ts_fas_err_cnt       = 0
ts_febe_cnt          = 0

ts_oof_cas_cnt       = 0

COFA cnt             = 0
CAS COMFA cnt        = 0
HDB3 Detect cnt      = 1
PCM Frm Slip cnt     = 0
```

The following gives basic information about the fields for these error counts.

Field	Count for ... *	Comments
ts_oof_cnt	Out of frame	Increments whenever an oof problem is seen.
ts_oof_crc_cnt	Change of frame alignment cyclic redundancy check	Applies when using CRC mode. Increments when the basic frame is okay but momentarily could not use CRC.
ts_lcv_cnt	Line code violation	If this count increments, it likely means serious problems, probably with the PBX, which may require maintenance.
ts_bit_slip_cnt	Bit slip	The clock sync source is out or the frequency is slightly off.
ts_crc_fail_cnt	Cyclic redundancy check fail	Intermittent instantaneous errors. There could be hundreds in a day. This count is not as serious as the ts_oof_cnt.
ts_fas_err_cnt	Frame alignment signal error	The frame alignment signal is sent in a basic pattern of 8,000/second. A count of 1 or 2 a day does not indicate a problem. A count of several in an hour indicates a problem.
ts_febe_cnt	Far end block error	Indicates that the far end (the PBX) has problems with the signal it is receiving. There is a high CRC count being received from the DTIC.
ts_oof_cas_cnt	Out of frame channel associated signaling	The voice signal is okay but the system cannot determine call processing status, such as whether on-hook or off-hook. Each incident of this increments the count.
COFA cnt	Change of frame alignment	There could be a count that is too low to be significant. A rule of thumb is that if the count is 7 or more per day, it is significant. This indicates momentary losses of frame, perhaps too quick to trigger an alarm and bring the card down. An oof condition must persist for 2 seconds before bringing the card down. If the count is 256 or more per day, it is very serious and should be fixed immediately.
CAS COMFA cnt	Channel associated signaling change of multiframe alignment	Same as for COFA cnt except that this is for channel 16 only.
HDB3 Detect cnt	High density bipolar with 3 bits detection	Counts when HDB3 mode is enabled. HDB3 mode is always enabled for the DTIC. Increments when HDB3 patterns are detected. A count of 100 per day or less is normal. Greater than 100 per day could indicate problems.
PCM Frm Slip cnt	Pulse code modulation frame slip	Indicates a clock problem. Increments when an entire frame (256 bits) slips all at once. If the count is 17 or more per day, it is a minor cause for concern. If the count is 512 or more per day, it is a major problem.

* The ts means trunk scanner.

Solutions for Trunk Problems

Perform the following steps to solve trunk problems:

1. Make sure the transmit and receive portions of the cable are not reversed. If it is possible to swap the transmit and receive parts of the cable, do so, and check to see if the DTIC comes up.
2. Make sure the cable is not broken. Find a loopback cable to loop the DTIC to itself. If it comes up, the cable could be a problem.
3. Make sure the PBX is sending a correct E1 framing pattern. Try looping the PBX to itself and seeing if it operates with what it receives.
4. Check that the PBX and DTIC both are in the same CRC4 mode — either both disabled or both enabled.
5. Make sure that the impedance switches (sw1 and sw2) on the DTIC are set correctly according to cable type. Both switches **must** be set the same.
6. Check the alarm queue on the DTIC for clues about why it is down. Log on to the card and enter `LIST ALARM`. For example,

```
@CONN 2
Connecting to E1          in slot 2
dtic>LIST ALARM
03/22/97 08:05:25 Trunk  Loss of Signal
03/22/97 08:05:25 Trunk  Out of Frame
03/22/97 08:05:25 Trunk  Traffic Disabled
03/22/97 08:05:25 Trunk  Out of CAS Multiframe
dtic>EXIT
Disconnecting from E1
```

7. Check the LEDs on the front of the card for trunk problems. The LEDs have the same information as the status screens although without as much detail. However, if you are unable to get terminal access to the system, the LEDs might be a good alternative. The meanings of the LEDs are as follows:

LED	Meaning
Red boot (top)	Apcode is initializing
Green Power	DTIC has power
Red 1 (top)	Loss of signal on trunk (LOS)
Red 2	Loss of frame on trunk (LOF)
Yellow 3	Remote alarm indication (RAI)
Yellow 4	“Other” trunk alarm
Yellow 5	Alarm history
Green 6 (bottom)	One or more ports off hook

 All red LEDs should be OFF when the card is correctly initialized. If LEDs Red 1 and Red 2 are ON, it indicates that there is no incoming clock, possibly due to incorrect cabling.

For further help, contact Technical Support.

Call into System, Phone Rings but Is Never Answered

This problem is unlikely, but it could be caused by the DTIC being operational but not being allowed to report ringing to the main system. A possible source of this problem is that the signaling method for the DTIC is not set to the correct value. The signaling method is set in LSP Table parameter 24 and should be 10 for the ACULAB. If the problem occurs, contact Technical Support.

System Answers but Voice Quality Is Poor

This problem probably means that the PCM encoding law is incorrectly set. Check whether System Parameter 198 — PCM ENCODING FOR THE SYSTEM, is set to 1, for A-law. If not, change the value to 1.

System Answers but Pops or Buzzes

This problem probably means that the setting of the DTIC as a clock sync source is not correct. If only one DTIC is configured in the system, check that the DTIC is configured as the primary clock sync source. If the DTIC is not configured as the primary clock sync source and the PBX has another clock, the clock rates may not be the same.

If more than one DTIC is configured in the system, check that the DTIC is configured as the primary clock sync source and also check that the PBX is using the same clock rate.

Modem Connection Has Garbage Characters

This problem occurs when log on is via a modem connection and the characters that appear on the screen are random characters and digits.

The source of the problem and solution are the same as given for the System Answers But Pops or Buzzes.

Ports on the DTIC Configured for Ringing but Do Not Answer Calls

This problem could be caused by the message server expecting dial tone when initializing the ports. The message server, as part of initialization, tells each port to go off hook, listen for dial tone, send a DTMF string, and then go on hook.

At the @ prompt, use the PS command to see whether the port in question has the code NDT for no dial tone or ERR for error. To determine whether the failing port number is actually on the DTIC or on another line card instead, use the LIST SLOT x command, where x is the DTIC slot number.

If NDT or ERR is present, check System Parameter 33 — PBX INITIALIZE CODE. The value for this parameter should be NONE.

Restart the system to reinitialize the DTIC. Then test that the card accepts phone calls.

DTIC Still Does Not Operate Correctly

If you need to call Technical Support, try to provide the symptoms of the problem and the revision/version of the DTIC software. You can get complete DTIC revision information by connecting to the DTIC (E1) using the `VERSION` command, as in the following example:

```
@CONN 2
Connecting to E1      in slot 2
dtic>VERSION
          **** Version Information ****

Firmware Rev      Date      Time  ChkSum Comment
-----
BootROM   3.03   Jan 31 1997  16:40:24  5A32  final DTIC-E1/DLC16 version

Xillinx Images      Rev      Date      Time      Filename  Package
-----
Voice Bus Intf      4.0    05/13/97  19:18:43  vbintf.lca  3042PQ100
DTIC Pass 1 TDM     1.0    01/21/97  18:25:31  tdmint.lca  3042PC84
DTIC pass 2 TDM     1.0    12/21/97  01:46:26  dtctdm.lca  3064PC84
DLIC16 TDM          5.0    11/09/97  17:22:11  116TDM.LCA  3042PQ100
PIC TDM             4.0    09/08/97  18:11:45  PICTDM.LCA  3042PQ100

CODE  REV      DATE      TIME      COMMENT
-----
DSP   1.67   03/10/97  09:32:40  all 1.65f patches, fix PCM cnvrnsn bug
CP    0.01   MAR 20, 1997 13:50   New digit sending method
```

11

LAN CARD

Chapter Contents

11.1	Overview	11-1
11.2	Installing and Configuring the LAN Card	11-2
	SLOTS Table	11-2
	System Parameters	11-3
	LAN Card Installation	11-5
11.3	Testing the LAN Card	11-6
	Traffic Pegs	11-9
11.4	Taking the LAN Card Out of Service	11-10
	When To Use Courtesy Down	11-10
	Effect of Pressing the Escape Key	11-12
Appendix A	Internet Addressing	11A-1
Appendix B	Simple Network Management Protocol (SNMP)	11B-1
Appendix C	Octel Private MIB	11C-1

Tables

11-1	LED Activity on the LAN Card	11-5
11-2	CD and CU for LAN — Messages and Descriptions	11-12

Quick Reference Guide

LAN Card

	Command	Description
Taking LAN card out service of and returning it to service		
Courtesy Down	CD x	Takes the LAN card out of service without interrupting activities in progress. x = slot number of LAN card.
Courtesy Up	CU x	Brings the LAN card back into service. x = slot number of LAN card.
Network Test		
TEST LAN	TEST LAN	Tests all locations in the network.
	TEST LAN x	Tests a single location in the network; x = the specific location name to be tested.
SNMP Test		
TEST SNMP	TEST SNMP	Tests the mechanism of communication between the Octel Overture 200/300 message servers and the SNMP manager system.
Maintenance and Troubleshooting		
Diagnostic Tools		
LAN CARD PING Echo Test	CMD x PING y	Lowest level “echo” test from the local LAN to the destination message server to verify that both LAN cards are UP, data transfer is possible, and IP addresses are correct. x = slot number of LAN card y = IP address of the device to which the Ethernet packet is sent.
LAN STATUS	LANSTAT	Lists basic information about the current status of the LAN — UP DOWN, INITIALIZING.

11.1 OVERVIEW

Information in this chapter specific to the LAN card includes details about hardware, installation, configuration, maintenance, and troubleshooting. A LAN card must be installed in the Octel Overture™ 200/300 for the Digital Networking feature, the LAN Backup and Restore feature, or the Gateway Link feature.

The LAN card is purchased as part of the the LAN Hardware Kit, which contains one LAN card (a replaceable unit) and one 25-pair-to-RJ45 adapter (**not** a replaceable unit). The part number of the kit for both the Octel Overture 200 and the Octel Overture 300 is 740-6221-001.

For installation, the following are required, but not included with the LAN card hardware kit:

- 10BaseT Ethernet Hub, compliant with IEEE 802.3
- Four-pair twisted-pair wiring with RJ45 connector

11.2 INSTALLING AND CONFIGURING THE LAN CARD

Only one LAN card can be installed in the message server. The LAN card can be installed in slots A5, A6, or A7 for the Octel Overture 200 and slots A10, A11, or A12 for the Octel Overture 300.

The LAN card must be configured in the SLOTS Table and certain system parameters might need to be modified before the LAN card is installed.

Before installing the LAN card, configure the LAN card in the SLOTS Table. Refer to the *Configuration* volume, Slots Table chapter.

SLOTS Table

When adding the LAN card to the SLOTS Table, enter 22 for the card type. The LAN card entry can also be added in the INSTALL program, question 3, or in UPDATE, with the ADD SLOT command.

You cannot configure more than one LAN card in the SLOTS Table. Any attempt to add a second LAN card results in the following error message:

```
LAN CARD ALREADY CONFIGURED IN SLOT n.
```

You can install the LAN card in slots A5, A6, or A7 in the Octel Overture 200 and in slots A10, A11, or A12 of Shelf A in the Octel Overture 300. The commands MODIFY SLOT and DELETE SLOT allow a slot with card type 22 to be modified or deleted, respectively.

You cannot modify or delete the LAN card entry in the SLOTS Table when the LAN card is UP. Any attempt to do so results in the following error message:

```
LAN is currently UP.  
Please COURTESY DOWN the LAN board before doing this operation.
```

System Parameters

Configure System Parameters 233 and 234 if a gateway and name server exist on the LAN and must be accessed. Contact the network administrator for information about these system parameters.

System Parameter	Description and Use
------------------	---------------------

233	LAN: NAME SERVER IP ADDRESS
------------	------------------------------------

The name server is used to determine the IP address of a node, given its ASCII host name. The ASCII host name is used to identify a node with a symbolic name, so that hard-coded IP addresses are not used. This entry is optional and need not be configured if all nodes are known by their IP addresses.

The IP address of the name server must be of the form M.N.O.P, where M = 1–223; N and O = 0–255, and P = 1–254.

☞ This is the name server in the data network (LAN), not the Octel Overture 200/300 Netnames or Dial-by-Name directory.

234	LAN: GATEWAY IP ADDRESS
------------	--------------------------------

The gateway unit connects two or more LANs and is used only if the message server needs to communicate with another message server on a different network. A typical example would be a Wide Area Network (WAN) connection. If a gateway is used, its IP address must be configured here.

An IP address must be of the form M.N.O.P, where M = 1–223; N and O = 0–255, and P = 1–254.

☞ This is the gateway unit in the data network (LAN), not to be confused with the other types of the gateways, such as gateway unit used to connect Visual Mailbox users from the Entryworks ACP board to the LAN or message servers used as message gateways, or the OctelAccess server link.

System Parameters 235–240 and 242 are optional. These system parameters are only required when accessing an existing LAN network and are used only if SNMP is to be used. The SNMP is not required to support a dedicated LAN that connects only Octel Overture 200/300 message servers.

☞ Simple Network Management Protocol (SNMP) is a standard protocol that allows a network administrator on the LAN data network to request information from servers attached to the LAN for the purposes of troubleshooting and network management. The SNMP management application is typically an off-the-shelf software package run by a network administrator or technician on a workstation or PC-compatible. Contact your network administrator to determine whether SNMP management tools are available and how they could be useful. Refer to Appendix B, Simple Network Management Protocol (SNMP), for additional information.

System Parameter	Description and Use
235	LAN: SNMP MANAGER IP ADDRESS The IP address of the SNMP manager's PC/workstation, which must be of the form M.N.O.P, where M = 1–223; N and O = 0–255, and P = 1–254.
236	LAN: SNMP MANAGER HOST aSCII NAME The host name of the SNMP manager's PC/workstation, which can be up to 31 alphanumeric characters long.
237	LAN: SNMP LOCATION OF VOICE MAIL CABINET The location is a descriptive field that specifies the location of the Octel Overture 200/300, which can be up to 31 characters.
238	LAN: SNMP NAME OF SYSTEM CONTACT The name of the person who needs to be contacted in case of network trouble with the Octel Overture 200/300 (that is, the Octel Overture 200/300 system administrator). Also, include the person's phone number, if known. The name can be up to 31 characters long.
239	LAN: SNMP READ COMMUNITY The read community that can only access SNMP data. This is a password that provides read-only access to the SNMP manager, which can be up to 19 characters long.
240	LAN: SNMP READ WRITE COMMUNITY The read-write community that can access and modify SNMP data. This is a password that provides read/write access to the SNMP manager, which can be up to 19 characters long.
242	LAN: SEND TRAP TO THE SNMP MANAGER ON ALARM If this parameter is set to Yes and if the SNMP manager IP address (or manager name if a name server is configured) is configured, the CPU will generate an SNMP trap request to the LAN card, whenever a hardware error is logged a sufficient number of times for its priority to cause an alarm call. The default is No.

LAN Card Installation

LAN cards are designed to be hot-plugged. The procedure to install the LAN card is as follows:

1. Put on an antistatic wrist strap. Connect it to an unpainted portion of the cabinet.
2. While holding the LAN card by its top and bottom edges, slide the card into the card cage.
3. Pivot the card ejectors as needed to grip the small flanges on the front edges of the card cage.
4. Firmly seat the LAN card connectors into the motherboard by pressing the card ejectors against the front edge of the LAN card. The ejectors will clip onto small pins on the LAN card when the connectors are seated.



Caution!

Do not slam the LAN card into the cabinet, as this could damage the card or motherboard connectors.

5. Install the 25-pair-to-RJ45-adapter on the back of the cabinet for the slot in which the LAN card is being installed.
6. Connect the ethernet twisted-pair cable from the RJ45 adapter to the ethernet hub.
7. After installing the LAN card, restart the message server to put the card into service. At the @ prompt, enter

RESTA

There are eight LEDs on the front edge of the LAN card. Once the LAN card is installed, the LEDs are activated as shown in Table 11-1.

Table 11-1 LED Activity on the LAN Card

LED Color	LED Purpose	LED Activity
Red	Standard use	Lights after the LAN card is installed. Goes off when the card has been initialized and is ready for operation.
Green	Standard use	Lights when self-test diagnostics are complete.
Yellow	Development	Used only for development.
Yellow	Good Link Indicator	Lights when the adapter and wiring to a hub are okay.
Yellow	Rx Polarity Reversed	Lights if the pair being received by the ethernet controller need to be reversed. Check the wiring.
Yellow	Receive Activity Indicator	Lights when the ethernet controller sees activity on the receive pair.
Yellow	Transmit Activity Indicator	Lights when the ethernet controller sees activity on the transmit pair.
Yellow	Collision Indicator	Lights when a collision occurs. Collisions occur normally in ethernet/802.3 networks, because it is part of the low-layer protocol.

11.3 TESTING THE LAN CARD

After the Octel Overture 200/300 has been restarted to bring up the LAN card, test whether the LAN card is functional and is communicating with other message servers. Use the following commands:

- CMD PING
- LANSTAT

CMD PING

The CMD PING command does the lowest-level “echo” test from the LAN card at this end to the destination message server. It verifies that all the basic requirements are met, such as the following:

- Both LAN cards are present, up and running, and talking to the CPU.
- LAN end-to-end data transfer is possible across the digital network.
- The LAN card IP addresses are correctly configured.

To use the CMD PING command, at the @ prompt, enter

```
CMD x PING y 
```

where *x* is the slot number in which the LAN card is installed and *y* is the IP address of the device to which the test ethernet packet is sent.

The CMD PING command sends a low-level ethernet packet to the address specified. The receiver replies with a ping-response packet.

An example of a ping success is as follows:

```
@CMD 11 PING 157.156.53.3
LAN (Ethernet) Link: 02/4/1994 12:48:20 (0179fc76:0179fc76) Rev 1.0.3
  Current Time: 04/12/1994 15:15:25 @ Slot 10
LAN>PING 157.156.53.3: 56 data bytes
64 bytes from 157.156.53.3: icmp_sn=0. time=110 ms

----157.156.53.3 PING Statistics----
1 packets transmitted, 1 packets received, 0% packet loss
round-trip (ms) min/avg/max = 110/110/110
LAN>
@
```

An example of a ping failure is as follows:

```
@CMD 11 PING 157.156.53.5

LAN (Ethernet) Link: 02/4/1994 12:48:20 (0179fc76:0179fc76) Rev 1.0.3
  Current Time: 04/12/1994 15:15:49 @ Slot 10
LAN>PING 157.156.53.5: 56 data bytes
still trying...
still trying...
still trying...
still trying...
still trying...
still trying...

157.156.53.5 not responding
LAN>
@
```

This is the best tool to use to identify whether there is end-to-end connectivity across the digital network between two Octel Overture 200/300 message servers. It is especially useful to verify that IP addresses are correctly configured.

LANSTAT Command

The LANSTAT command provides basic information about the **current** status of the LAN. Information about the status of the LAN for previous periods is provided in the Network Traffic Report for Digital Networks. Refer to the Reports chapter in this volume.

The LANSTAT command provides information about the current status: whether the LAN is UP or DOWN and the state of the high-speed links. Following is an example of the screen for LANSTAT:

```
@LANSTAT
LAN STATUS: UP
LAST INITIALIZED ON 05/25/97 AT 06:05 PM

DIGITAL NETWORKING STATUS: UP

----- HIGH-SPEED-LINK STATUS -----
LOCATION          STATUS    LAN-PRCL  OTHER
-----
SELF             -        3
CHCGO            UP        2
NEWYRK           DOWN     -
DALLAS           DOWN     1          OEM-FAIL
SFO              UP        3

-----

GWL STATUS: DOWN - GATEWAY LINK SYSTEM PARAMETER IS NOT ENABLED
@
```

The LAN status is always UP, INITIALIZING, or DOWN, as follow:

LAN Status

The LAN card is running, with CPU communication to the card. The LAN is running normally. If a Courtesy Down is in progress, the message COURTESY DOWN IN PROGRESS is shown.

When the LAN status is UP, the high-speed link status is given for each high-speed digital location, as follows:

- LOCATION The entry in this column is the location name.
- STATUS The entry in this column is the status of the link to this location, which is either UP or DOWN.
- LAN-PRTCL The entry in this column is the Digital Networking Protocol level of the other system. This entry allows compatibility with future releases. It does not relate to analog protocol numbering.
- OTHER The entry in this column can be one of the following: HNDSHAKE, waiting for start-up handshake reply; OEM-FAIL, cannot establish connection, OEM mismatch.

INITIALIZING Entry

The LAN is in the initialization process. The current status of the initialization process is given, from among the following:

- WAITING FOR LAN-REBUILD TO COMPLETE
- WAITING FOR LAN-BOARD TO START
- WAITING FOR LAN INFO FROM VCU
- STARTING HIGH-SPEED CONNECTIONS

DOWN Entry

CPU communication to the LAN card is not UP, and no LAN activity is possible. The reason, if known, is given. The following are possible reasons:

- System does not have the Digital Networking feature.
- A COURTESY-DOWN is in process.
- LAN SYSTEM PARAMETER NOT ENABLED.
- LAN BOARD NOT CONFIGURED IN SLOTS TABLE.

At any time during the listing of the LAN status, you can press **Escape** to terminate the listing within a line or two.

Traffic Pegs

The following pegs in the Traffic Peg Count Table are useful in monitoring and troubleshooting the LAN card.

Peg Number	Description and Use
150	CARD COURTESY DOWN: Number of times the CD command for LAN was executed successfully.
254	TOTAL TIME (IN MINUTES) THAT THE LAN IS UP: Number of minutes that communication to the LAN card has been UP. Increments every minute that the LAN card is communicating with the CPU. This peg is used with peg 253 to calculate the percentage of time that the LAN card is UP to the time that the message server is UP for the Digital Network Performance Report, LAN Availability.
255	NUMBER OF TIMES TOTAL REALTIME NAMES PLAYED REACHED THE LIMIT OF AVAILABLE CLIENTS: The number of times that a name could not be played by this message server in real time over the LAN, because this message server had already reached the maximum limit for playing the maximum number of simultaneous real-time names (that is, reached Maximum Name Clients).

11.4 TAKING THE LAN CARD OUT OF SERVICE

Use the Courtesy Down command to take the LAN card out of service. The Courtesy Down command does the following:

- ❑ Takes the digital-networking hardware and software out of service without interrupting any activity in progress or causing random errors.
- ❑ Blocks any new digital networking activities.
- ❑ Waits for all activities in progress to be completed, such as background message transfers and real-time name plays, before taking the hardware and software out of service.
- ❑ Displays progress messages while waiting for any background message transfers or real-time names to complete.

Use the Courtesy Up command to bring the LAN card back into service. The Courtesy Down condition is maintained across a system reload, restart, or power cycle. Only a Courtesy Up command can clear the Courtesy Down condition.

- ☞ The Shutdown command can be used to put the message server in an offline mode without disabling the LAN card. Refer to the Maintenance Command chapter, System Service Mode Commands section in this volume.

When To Use Courtesy Down

Use of the Courtesy Down command is recommended before you do the following:

- ❑ Service the LAN card hardware (such as for removal)
- ❑ Take the message server down by powering off, reloading, etc.
- ❑ Use the UPDATE program to make any of the following configuration changes:
 - ❑ Use the ADD, MODIFY, or DELETE commands for the LOCATION Table if the location involved is a high-speed digital location
 - ❑ Turn off the digital networking feature in the SYSTEM PARAMETER Table; that is, set System Parameter 225 — DIGITAL NETWORKING ENABLED to no.
 - ❑ Change the SLOTS Table for a LAN card

- ☞ The UPDATE program blocks these changes if the digital-networking system is UP.

To bring the LAN card down, at the @ prompt, enter

```
CD x 
```

where x is the slot number of the LAN card.

```

@CD 7
STARTING LAN COURTESY DOWN...

LCH01 LCH02 LCH03 LCH04 LCH05 LCH06 LCH07 LCH08
  IDLE  IDLE  SEND  CONN  IDLE  IDLE  SEND  CONN

WAITING FOR 4 LAN CHANNEL(S) TO GO IDLE
WAITING FOR 3 LAN CHANNEL(S) TO GO IDLE
WAITING FOR 2 LAN CHANNEL(S) TO GO IDLE
WAITING FOR 1 LAN CHANNEL(S) TO GO IDLE
ALL LAN CHANNELS ARE IDLE.

WAITING FOR 8 REAL-TIME NAMES TO FINISH PLAYING
LAN COURTESY DOWN COMPLETED SUCCESSFULLY.
@

```

To bring the LAN card up, at the @ prompt, enter

CU x

where x is the slot number of the LAN card.

```

@CU 7
STARTING LAN COURTESY UP...

WAITING FOR LAN CARD TO START...

LAN CARD IN SLOT 7 STARTED
LAN COURTESY UP COMPLETED SUCCESSFULLY.
@

```

Any errors that occur while processing a Courtesy Up or Courtesy Down command are logged to the Hardware Error Table. Some examples are as follows:

- Timed out waiting for the LAN card to come UP
- Timed out waiting for the LAN card to respond to a Courtesy Down request
- Timed out waiting for the VCU to respond to a Courtesy Down request
- Timed out waiting for the VCU to respond to the Enable-LAN-message server request

Table 11-2 shows other informational or error messages displayed for these commands.

Table 11-2 CD and CU for LAN — Messages and Descriptions

Status Messages	Description
SYSTEM DOES NOT HAVE DIGITAL NETWORKING FEATURE	Digital Networking feature is not available. To check for SW-X0049 or SW-X0053 in the feature table, at the @ prompt, enter L F.
LAN CARD IS CURRENTLY DOWN	LAN card is already down or in the process of being brought up when the CD x command is entered.
LAN CARD IS ALREADY UP	LAN card is already up when the CU x command is entered.
COURTESY DOWN ABORTED	Courtesy Down did not complete successfully because of an error as shown by one of the other error messages.
COURTESY UP ABORTED	Courtesy Up did not complete successfully because of an error as shown by one of the other error messages.

Effect of Pressing the Escape Key

The effect of pressing `[Escape]` while a Courtesy Down command is in progress depends on how far the process has gone.

- ❑ If `[Escape]` is pressed before the message `WAITING FOR N REAL-TIME NAMES TO FINISH PLAYING` is displayed, the message server aborts the CD command and leaves the LAN card in service.
- ❑ If `[Escape]` is pressed after the message `WAITING FOR N REAL-TIME NAMES TO FINISH PLAYING` is displayed, the message server continues processing the CD command and gives the message `PLEASE WAIT . . .` The shutdown continues.

The effect of pressing `[Escape]` while a Courtesy Up command is in progress depends on how far the process has gone.

- ❑ If `[Escape]` is pressed before the message `WAITING FOR LAN CARD TO START` is displayed, the message server continues processing the CU x command and gives the message `PLEASE WAIT . . .` The Courtesy Up process continues.
- ❑ If `[Escape]` is pressed after the message `WAITING FOR LAN CARD TO START` is displayed, the message server returns to the @ prompt. The message server continues processing the CU x command in the background. It might take 2 to 3 minutes for the LAN card to come UP after this message.

APPENDIX A

INTERNET ADDRESSING

This appendix provides some background information about internet addresses and how this information relates to the Octel Overture™ 200/300 Digital Networking and other Octel LAN-based features.

A TCP/IP* internet is a virtual network built by interconnecting physical networks with gateways. Addressing is an essential ingredient that helps TCP/IP software hide physical network details and makes the internet appear to be a single, uniform entity. For an Octel Overture 200/300 to be able to talk to any other system, a globally accepted method of identifying systems is needed. Often, host identifiers are classified as *names*, *addresses*, or *routes*. A *name* identifies what an object is, an *address* identifies where it is, and a *route* tells how to get there. Names, addresses, and routes really refer to successively lower levels of host identifiers. In general, people usually prefer pronounceable names to identify machines, whereas software works better with more compact binary representation of identifiers that we think of as addresses.

For addresses, the designers of TCP/IP chose a scheme analogous to physical network addressing in which each host (or network connection) on the internet is assigned a unique 32-bit integer (4 bytes) IP address that is used in all communication to the host. These integers are chosen so as to make routing efficient.

The bits of IP address for all hosts on a given network share a common prefix. Conceptually, each address is a pair (netid, hostid), where netid identifies a network and hostid identifies a host on that network. In practice, each IP address must have one of the first three forms shown in the following figure. For ease of communication, IP addresses are written in the dotted decimal format with four decimal integers separated by decimal points, where each integer gives the value of one octet of the IP address. Thus, the 32-bit address

10000000 00001010 00000010 00011110

is written

128.10.2.30

* Transmission Control Protocol/Internet Protocol. A set of communications protocols developed for the Defense Advanced Research Projects Agency to internetwork dissimilar systems. It runs on a large number of computers and is supported by many hardware vendors from personal computers to mainframes. It is used by many corporations and almost all American universities and federal organizations. The TCP protocol controls the transfer of the data, and the IP protocol provides the routing mechanism.

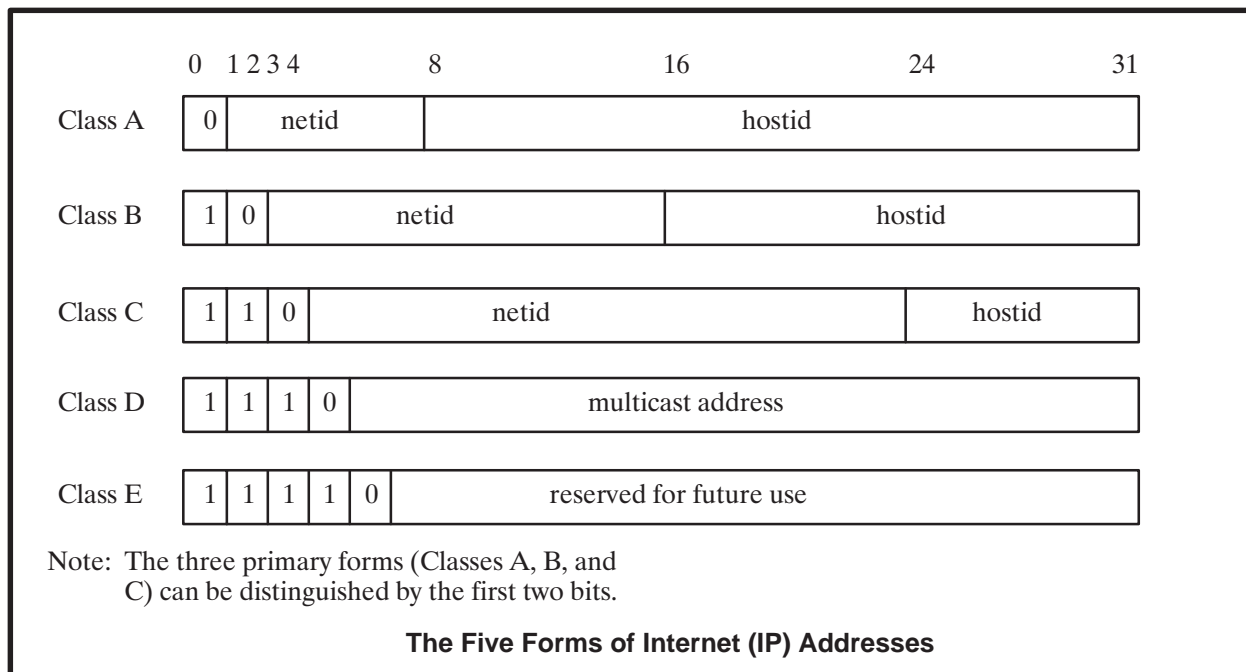

Given an IP address, its class can be determined from the three high-order bits, with two bits being sufficient to distinguish among the three primary classes. The IP address has been defined in such a way that it is possible to extract the hostid or netid portions quickly. Gateways use the netid as the basis for routing and depend on such efficient extraction. The major advantage of encoding network information in the IP address is that it makes efficient routing possible. Another advantage is that IP addresses can refer to networks as well as hosts.

Special (Reserved) IP Addresses

By convention, hostid 0 is never assigned to an individual host. It refers to the given network. Also by convention, any hostid consisting of all 1s is reserved for broadcast on the given network. This broadcast address is called a directed broadcast address, which provides a powerful mechanism that allows a remote system to send a single packet that will be broadcast on the specified network.

Another form of broadcast address consisting of all 32 1s is called the local network broadcast address or limited broadcast address. This form may be used as part of a startup procedure before it learns its IP address or the IP address of the local network. The class A address 127.0.0.0 is reserved for loopback and is designed for testing and interprocess communication on the local machine. A packet sent to this address will never appear on the network. The following figure lists all the combinations of 0s and 1s used by IP itself.

all 0s		This host*	
class ident.	all 0s	host	Host on this net*
all 1s		Limited broadcast (local net)**	
net	all 1s	Directed broadcast for net**	
127	anything (often 1)	Loopback***	

* Allowed only at system startup and is never a valid destination address.
 ** Never a valid source address.
 *** Should never appear on a network.

Note: The length of the net portion depends on its class.

Special Forms of IP Addresses

Subnet Addressing

The netid portion of an IP address is assigned to an organization by a central agency called IANA.[†] The individual organization is free to divide its hostid portion into multiple smaller physical networks called subnets.

Suppose a site has a class B address. It has 16 bits of the address to use for its local portion. Suppose there are eight physical networks at the site. For purposes of addressing efficiency, the organization could take the top 3 bits from its local portion and assign one value to each of its eight physical networks. This particular combination gives eight physical networks (subnets) with up to 8,192 hosts per subnetwork. Another site may choose to assign 8 bits to the subnet, giving 256 subnets each with up to 256 hosts. Refer to the following figure.

To allow maximum autonomy, the TCP/IP subnet standard allows the subnet partition to be selected on a per-network basis. Once a partition has been selected for a particular network, machines attached to that network are expected to use it.

The subnet mask is usually given to you by your LAN administrator along with your system's IP address. If your network doesn't use a subnetting scheme, you should still set up the subnet mask to cover your network portion. Refer to Example 3 in this chapter.

[†] For information on how to get your own assigned IP address, contact Joyce K. Reynolds, (213) 882-1511 JKREY @ ISI.EDU Internet Assigned Numbers. Authority, USC-Information Sciences Institute, 4676 Admiralty Way, Marina del Rey, California 90292-6695.

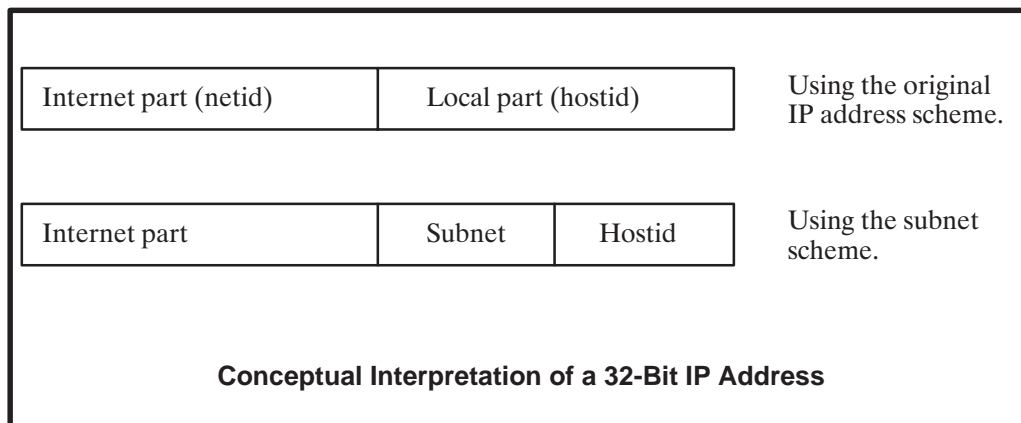

Implementation of Subnets with Masks

The standard specifies that a site using subnet addressing must choose a 32-bit subnet mask for each network. Bits in the subnet mask are set to 1 if the network treats the corresponding bit in the IP address as part of the network address, and 0 if it treats the bit as part of the host identifier. For example, the 32-bit subnet mask

```
11111111 11111111 11111111 00000000
```

specified that the first three octets (bytes) identify the network and the fourth octet identifies a host on that network. It is assumed that the subnet mask has 1s for all bits that correspond to the net portion of the address. For example, the subnet mask for a class B network always includes the first two octets plus zero or more subnet bits.

The standard does not require that the subnet bits be contiguous. However, it is recommended that sites use contiguous subnet masks and they use the same mask throughout an entire set of physical networks that share a network address because noncontiguous subnet masks make assigning host addresses and understanding routing tables more difficult.

Configuration Implications

For a Octel Overture 200/300 LAN network configuration, it is desirable to collect the subnet information from the user in the same dotted decimal format used for obtaining IP addresses. The default shown in the UPDATE questions is for only one network that has zero subnets. The default is derived from the netid portion of the host's own IP address.

Example 1 — Assume that the IP address assigned to a system is 157.156.26.1. This is represented in its binary format

```
100111101 10011100 00011010 00000001
```

to note that this is a class B address.

Assume that there are ten different physical networks in this organization. Also assume that with future growth, there will be up to 20 different physical networks in this organization. To represent ten subnets requires 4 bits and to represent 20 subnets requires 5 bits — 5 bits is sufficient to represent up to 32 subnets, whereas 4 can represent only 16 subnets. Setting the 5 top bits of the hostid to 1 in addition to

the network portion for the class B address gives the following in binary format:

```
11111111 11111111 11111000 00000000
```

This is equivalent to

```
255.255.248.0
```

which is what the user would enter in reply to the UPDATE question:

```
Enter the subnet mask for this Digital Network (Default
255.255.0.0) : 255.255.248.0
```

Example 2 — Assume that the system administrator in this network wants to divide the network into 256 subnetworks having at most 256 hosts in each subnet. To represent 256 subnets requires 8 bits of subnet mask information that need to be set to 1:

```
11111111 11111111 11111111 00000000
```

This is equivalent to

```
255.255.255.0
```

which is what the user would enter in reply to the UPDATE question:

```
Enter the subnet mask for this Digital Network (Default
255.255.0.0) : 255.255.255.0
```

Example 3 — Digital networking used for uniform numbering plan domain or multicabinet systems only. If there is only one physical network, the system administrator may choose not to use subnets.

If there is no connectivity to any other InterNetworking device, any IP address may be used. However, using a class C address (i.e., some number in the range 192.0.0.0 – 223.255.255.254) is usually suitable.

For example, for three Octel Overture 200/300 cabinets on their own dedicated LAN segment, the IP addresses might be

Cabinet 1 — 192.0.0.1

Cabinet 2 — 192.0.0.2

Cabinet 3 — 192.0.0.3

- If you choose a class A address in the absence of subnets, set the subnet mask to 255.0.0.0.
- If you choose a class B address in the absence of subnets, set the subnet mask to 255.255.0.0.
- If you choose a class C address in the absence of subnets, set the subnet mask to 255.255.255.0.

For example, if your IP address is 192.1.2.3, your subnet mask would be 255.255.255.0.

APPENDIX B

SIMPLE NETWORK MANAGEMENT PROTOCOL (SNMP)

11B.1 UNDERSTANDING SIMPLE NETWORK MANAGEMENT PROTOCOL (SNMP)

Simple Network Management Protocol (SNMP) is the standard digital network management protocol in TCP/IP* networks. An SNMP management application is typically an off-the-shelf software package run on a PC, terminal, or workstation by a network administrator or technician to manage and troubleshoot a network. Octel Overture 200/300 message servers with LAN used for digital networking and other Octel LAN based features support communication with the SNMP manager application and management information bases (MIBs) to supply data about the Octel Overture 200/300 message servers.

Three varieties of SNMP data support; the basic MIB, the private MIB, and hardware error traps, are provided. Data item groups from the MIBs are supplied to the SNMP manager application as replies to queries. The SNMP manager application may schedule queries or request them on demand. The hardware error traps are initiated by the managed Octel Overture 200/300 when a hardware error generates an alarm.

Basic MIB	Internet MIB-II Standard
Private MIB	Specific data items that identify an Octel Overture 200/300 and describe its digital network traffic and hardware errors. Refer to Appendix C for a listing of the Octel private MIB and instructions on obtaining the private MIB file from Internet.
Hardware Error Traps	A notification from the Octel Overture 200/300 to the SNMP manager application that a hardware error has reached an alarm threshold.

* Transmission Control Protocol/Internet Protocol. A set of communications protocols developed for the Defense Advanced Research Projects Agency to interconnect dissimilar systems. It runs on a large number of computers and is supported by many hardware vendors from personal computers to mainframes. It is used by many corporations and almost all American universities and federal organizations. The TCP protocol controls the transfer of the data, and the IP protocol provides the routing mechanism.

11B.2 BASIC MIB — INTERNET MIB-II

Octel has implemented a subset of the Internet MIB-II Standard. This standard provides access to low-level TCP/IP and network monitoring information such as

- Number of packets sent and received
- Number of error packets at Ethernet, TCP, SNMP, and UDP levels
- Current UDP socket information
- Current connection information
- SNMP requests and replies

More specifically, Internet MIB-II presents 175 attribute variables in the following nine groups:

 Octel has implemented a subset of variables defined in the MIB-II Standard. Contact Octel for a complete list of which variables are supported in the Octel implementation.

- System
- Interfaces
- Internet Protocol (IP)
- Internet Control Message Protocol (ICMP)
- Transmission Control Protocol (TCP)
- User Datagram Protocol (UDP)
- Exterior Gateway Protocol (EGP)
- Media Specific MIBs
- Simple Network Management Protocol (SNMP)

Refer to the Internet MIB-II Standard Specification for additional information that describes each variable in detail. The documentation manuals for the SNMP manager software that you are using may also provide useful information.

11B.3 PRIVATE MIB — OCTEL PRODUCTS.VMX-DIAL MIB

Introduction

The private MIB consists of about 60 variables whose data values are divided into various groups defined by the MIB file hierarchy. There are 23 variables that are repeated from each location configured. The actual division of the groups as displayed on the SNMP manager application depends on the MIB descriptor file being used.

For example, SUNNET SNMP Manager (by Sun Microsystems) displays the private MIB variables in four groups representing the system configuration (system ID information), the combined data from the Digital Network Traffic Report and specified LOCATION Table data fields, the Digital Network Performance Report, and the Hardware Error Table.

 The examples in this chapter were formatted by the SUNNET SNMP Manager software package. Your actual SNMP screens may look different, depending on the specific SNMP Manager software package and MIB descriptor file you are using.

The four parts of the VMX-DIAL private MIB collect defined fields of data from the Digital Network Performance Report, the Digital Network Traffic Report, the LOCATION Table, and the Hardware Error Table. The relevant fields are organized into groups of associated variable that are retrieved from the Octel Overture 200/300 by SNMP protocol queries from the SNMP manager application.

The four reports available in the private MIB are

CONFIG	Configuration information that identifies the current cabinet.
LOCTABLE	Summary of information for a digital network location.
DNETSTAT	The Digital Network Traffic Report
HWERRTABLE	The system Hardware Error Table

These are described in detail in the sections following.

CONFIG

This part of the private MIB contains configuration information that identifies to the current cabinet, including:

- System name
- System serial number
- System ID

These variables are taken from the Digital Network Performance Report.

Following is an example of CONFIG system information for the current cabinet, with system name [works9]:

```

Mon Jun 6 18:32:29 1994 [ works9 ] : Quick Dump: VMX-DIAL.config

systemName=OCTEL
sysSerialNum=123456
systemID=98765
    
```

LOCTABLE

This part of the private MIB contains the Digital Network Traffic Report and data from the LOCATION Table. It shows traffic information such as connections and messages to each other digital location from the current cabinet. It also shows some configuration information for each digital location, including name, IP address, connection type, etc.

Following is an example of LOCTABLE:

```

Mon Jun 6 18:33:42 1994 [ works9 ] : Quick Dump: VMX-DIAL.locTable

KEY=1
locIndex=1
locName=ATLNT2
locIpAddr=157.156.16.10
locLinkType=lowspeed
locInDomain=no
locColocated=yes
route1=TO2
route2=
route3=
caterpts=16
cfailures=0
cdropped=0
cbusys=0
cdayMin=1
cnightMin=0
mdAttempts=16
mdFails=0
mdRetries=0
mdDiskfulls=0
mdMbxFails=0
mdMinute=12
locPlayedNames=0
locLinkdrops=16
    
```

} **LOCATION Table**

} **Digital Network Traffic Report**

DNETSTAT

This part of the private MIB contains the Digital Network Performance Report. It shows a high-level summary of all digital networking activity, such as messages sent/received, LAN channel usage, and connections.

Following is an example of DNETSTAT:

```

Mon Jun  6 18:32:47 1994 [ works9 ] : Quick Dump: VMX-DIAL.dNetstat

sentMsgs=0
recvMsgs=0
recvNames=0
playedRtNames=0
secSent=0
secRecv=0
lchNumber=4
sec50pct=0
sec75pct=0
sec100pct=0
lchInSendSec=0
lchInRecvSec=0
outAttempts=0
outRejects=0
outGotBusys=0
inAttempts=0
inRejects=0
inGotBusys=0
lanAvailPct=100

```

HWERRTABLE

This part of the private MIB is a listing of the system Hardware Error Table. It shows the error type, when it occurred, and some additional error-specific data fields. The Hardware Error Table output is not filtered to exclude errors not relating to Digital Networking. All hardware errors are reported.

Following is an example of HWERRTABLE:

```

Mon Jun  6 18:33:21 1994 [ works9 ] : Quick Dump: VMX-DIAL.hwerrTable

KEY  heIndex  heErType  heSlot  heMon  heDay  heHour  heMin  heChnum  hePrio  heCnt  heData1  heData2  heData3  heData4
1    1         64       6 jun   6      16     41  00000000  3      1  00000002  00000002  00000000  00000000
2    2         64       6 jun   6      16     42  00000000  3      1  00000009  00000004  00000004  00000004
3    3         24       4 jun   6      16     53  00000001  2     99  00000005  00000001  00000004  00000003

```

SNMP Query Tracing

When an SNMP query is received by an Octel Overture 200/300, the event is logged in the CP trace. Each type of query has an identifying number that appears in the AUX field of the CP trace.

Identifying Number	CPT Trace Logged To
001	Digital Network Performance Report or System Configuration
002	Digital Network Traffic Report
003	Hardware Error Table

Following is an example of a CP trace:

```

@LOG PR CPT
Specify Print Option(s):
  "S"tart<time>, 'E"nd<time>, "L"ine<length>, "P"age<length>"\"
  "C"ontinuous
Filters: PR TY EV AU MB MS SL UN LI SO D1 D2 D3 D4 D5
>s94 09 08 14 45 ev snmp

MM/DD/YY HH:MM:SS PRT TYPE      EVENT      AUX      MBX/EXTN MSG# SL U L  SOURCE
D1 D2 D3 D4 D5
09/08/94 14:45:37      LAN_IN    SNMP_QRY   001
09/08/94 14:45:37      LAN_OUT   SNMP_SND   001
09/08/94 14:45:43      LAN_IN    SNMP_QRY   002
09/08/94 14:45:43      LAN_OUT   SNMP_SND   002
09/08/94 14:45:48      LAN_IN    SNMP_QRY   002
09/08/94 14:45:48      LAN_OUT   SNMP_SND   002
09/08/94 14:46:28      LAN_IN    SNMP_QRY   002
09/08/94 14:46:28      LAN_OUT   SNMP_SND   002
09/08/94 14:47:59      LAN_IN    SNMP_QRY   003
09/08/94 14:47:59      LAN_OUT   SNMP_SND   003
09/08/94 14:48:04      LAN_IN    SNMP_QRY   003
09/08/94 14:48:04      LAN_OUT   SNMP_SND   003
09/08/94 14:48:10      LAN_IN    SNMP_QRY   003
09/08/94 14:48:10      LAN_OUT   SNMP_SND   003
09/08/94 14:48:15      LAN_IN    SNMP_QRY   003
09/08/94 14:48:15      LAN_OUT   SNMP_SND   003

```

Type 1 queries produce a single CPT entry. Type 2 queries produce one entry per network location configured with. Type 3 queries produce one entry more than the number of error entries.

SNMP Private MIB Information Refresh

In the Octel Overture 200/300, the LAN card maintains a local copy of private MIB information. The LAN card updates this copy with new information from the CPU at intervals of 2 minutes.

When the SNMP manager queries the LAN card for private MIB information, the LAN card responds immediately from its local copy. The MIB information sent may not reflect changes that have occurred in the last two minutes, until the LAN card refreshes its copy from the CPU.

11B.4 USING SNMP TRAPS

SNMP traps are SNMP protocol messages initiated by the managed system to report a predefined error condition. For the Octel Overture 200/300, these errors are hardware errors as logged in the Hardware Error Table. In addition to the name and ID of the logging system, all information for the hardware error that caused the trap is listed.

Hardware errors have four priorities, ranging from priority 0 (lowest) to priority 3 (highest). An alarm notification trap is made depending on the combination of the error priority and the number of times the error (the same type with the same data) is logged. An alarm notification trap is made for the following combinations of priority and number of times the error is logged:

Error Priority	Number of Times Error Logged
3	1
2	25
1	50

 No alarm notification is made for priority 0, which reports the test of the alarm (command `TE A`).

Conditions for SNMP Trap Notification

The CPU generates an SNMP trap request to the LAN card under the following conditions:

- The SNMP manager system is configured, which means
 - System Parameter 235 — LAN: SNMP MANAGER IP ADDRESS, is configured.

or

 - Both System Parameter 233 — LAN: NAME SERVER IP ADDRESS, and System Parameter 236 — LAN: SNMP MANAGER HOST ASCII NAME, are configured.
- System Parameter 242 — LAN: SEND TRAP TO THE SNMP MANAGER ON ALARM, is set to YES.
- A hardware error is logged a sufficient number of times for its priority to cause a system alarm notification.

 An alarm outcall is repeated until acknowledgment. There is no such acknowledgment from the SNMP manager system for SNMP traps. SNMP notification is done only once per occurrence.

Configuring SNMP

The following information must be configured through system parameters:

- The SNMP manager's IP address. System Parameter 235 — SNMP MANAGER IP ADDRESS

Sometimes SNMP managers may only have an ASCII name configured, and the actual mapping from the ASCII name to an IP address is performed by a name server. In this case, the following system parameters must be configured:

- The IP address of the name server. System Parameter 233 — LAN: NAME SERVER IP ADDRESS
- The ASCII name of the SNMP manager. System Parameter 236 — LAN: SNMP MANAGER HOST ASCII NAME

When the same hardware error is logged a sufficient number of times (the number is predefined), an alarm outcall is made. To notify the SNMP manager of the first occurrence of this alarm outcall, the following system parameter must be enabled:

- System Parameter 242 — LAN: SEND TRAP TO THE SNMP MANAGER ON ALARM

The default setting for System Parameter 242 is NO. If the SNMP manager system is not configured, System Parameter 242 cannot be set to YES, and the following message is given:

```
Please configure system parameter 235, or 236 and 233, for the SNMP
manager system first.
```

For purposes of authentication and providing access privileges, the SNMP manager and agents exchange SNMP READ COMMUNITY and SNMP READ WRITE COMMUNITY names. As the names suggest, members of a READ COMMUNITY can only “read” the SNMP variables. Members of a READ WRITE COMMUNITY can not only “read” the SNMP variables through SNMP queries but also modify those SNMP variables that are modifiable. The following system parameters are used to specify the READ and READ WRITE communities:

- System Parameter 239 — LAN: SNMP READ COMMUNITY
- System Parameter 240 — LAN: SNMP READ WRITE COMMUNITY

The character strings in System Parameter 239 and System Parameter 240 are transmitted between the Octel Overture 200/300 and the SNMP manager application to verify each other’s access to the data being requested in a query. If the character strings do not match, the queries will fail.

In the SYSTEM PARAMETER Table in UPDATE, even if a string is entered in mixed upper- and lowercase, it is stored in the system as uppercase. However, when the string is transmitted to the LAN card, it is then converted to all lowercase. It is this lowercase string that must match the community read and write strings, as configured in the SNMP manager.

The following examples show this conversion process.

```
.M SYS 239
  Enter the SNMP Read Community Name.
  (1 - 19 characters, empty line = PA_LAB_READ)
MOD:PA_Lab_Read
  Enter system parameter index.
MOD:240
  Enter the SNMP Read Write Community Name.
  (1 - 19 characters, empty line = PA_LAB_WRITE)
MOD:PA_Lab_Write
  Enter system parameter index.
MOD:
```

```
.L SYS 239-240

INDEX VALUE      (LST?MOD)   PARAMETER NAME:
239 PA_LAB_READ   L/M         LAN: SNMP READ COMMUNITY
240 PA_LAB_WRITE L/M         LAN: SNMP READ WRITE COMMUNITY
```

```

@CON 6
Connecting to LAN in slot 6

LAN (Ethernet) Link: 08/1/1994 12:39:04 (018664b6:018665b6) Rev. 1.1.2
Current Time: 09/12/1994 17:20:42 @ Slot 6
LAN<l cfg
Installation Name : V200_1
VMX System ID   : 200111
Host Name       : v200_1
Domain Name     :
Internet Address : 148.147.250.114
Subnet Mask     : 255.255.255.0
Ethernet Address : 00-c0-94-00-00-0e
GateWay Address : 0.0.0.0
Name Server Addr : 0.0.0.0

SNMP - Manager   : 148.147.250.28
Manager Name     : sunnet
Sys Name         : v200_1
Location         :
Contact          :
RdCommunity      : pa_lab_read
RdWRCommunity    : pa_lab_write

```

Example of an SNMP Trap Report

Following is an example of an SNMP trap report generated on a system error alarm:

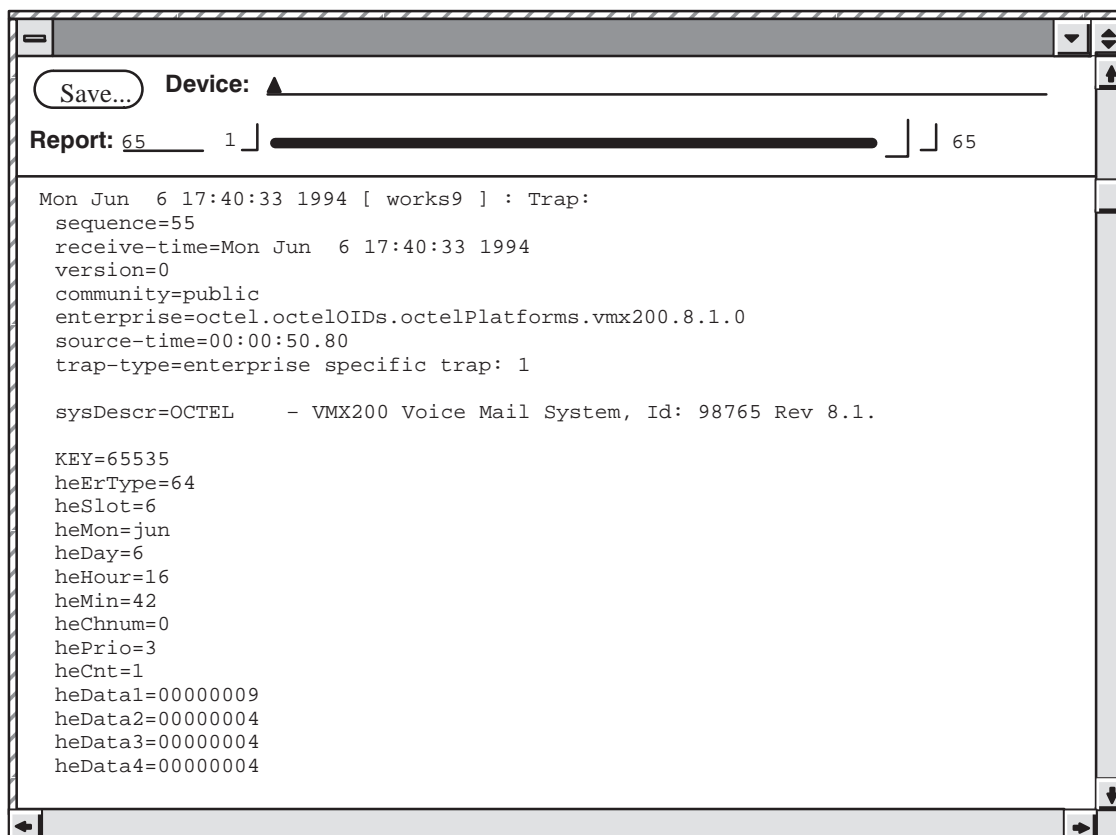

```

Save... Device: ▲
Report: 65 1
Mon Jun 6 17:40:33 1994 [ works9 ] : Trap:
sequence=55
receive-time=Mon Jun 6 17:40:33 1994
version=0
community=public
enterprise=octel.octelOIDs.octelPlatforms.vmx200.8.1.0
source-time=00:00:50.80
trap-type=enterprise specific trap: 1

sysDescr=OCTEL - VMX200 Voice Mail System, Id: 98765 Rev 8.1.

KEY=65535
heErType=64
heSlot=6
heMon=jun
heDay=6
heHour=16
heMin=42
heChnum=0
hePrio=3
heCnt=1
heData1=00000009
heData2=00000004
heData3=00000004
heData4=00000004

```

SNMP Trap CP Trace Example

Following is an example of a CP trace for an SNMP trap:

```
MM/DD/YY  HH:MM:SS  PRT  TYPE      EVENT      AUX MBX/EXTN MSG#  SL U L SOURCE
D1  D2  D3  D4  D5

05/18/94  12:06:08      LAN_OUT  SNMP_TRAP  001
```

The value 001 (currently the only one defined) in the auxiliary field (AUX) indicates that the SNMP trap is being sent because of a hardware error.

Hardware Error Table Entries for an SNMP Trap

A hardware error type 42, DATA1 = 17(hex) will be logged if a trap needs to be sent but the SNMP system manager is not known. For example,

```
@L H

THU 05/19 09:13:17 1994 ABC,INC  ID:123456 S/N:123456 PBX:23

CLEARED: 05/19 09:10

TYPE SLOT CHNL PRIO DATE   TIME   #BAD DATA1  DATA2  DATA3  DATA4
42    06   00    1   05/19 09:13    1 00000017 00000000 00000000 00000000
```

For the SNMP manager system to be configured, either its IP address (System Parameter 235) or its host name (System Parameter 236) **and** the IP address of the domain name server (System Parameter 233) must be known.

Once an SNMP trap has been generated, the L H command displays this information. For example,

```
@L H

THU 05/19 13:22:08 1994 ASKME  ID:123456 S/N:123456 PBX:23

CLEARED: 05/19 12:51

*** SNMP MANAGER SYSTEM HAS BEEN NOTIFIED ***

TYPE SLOT CHNL PRIO DATE   TIME   #BAD DATA1  DATA2  DATA3  DATA4
33    01   00    3   05/19 12:54    1 00000000 00000003 00000002 00000000
64    06   00    3   05/19 13:01    1 00000002 00000001 00000000 00000000
```

After successful completion of an SNMP TEST, hardware error type 64, DATA1 = 0E(hex) with a priority of 0 is logged.

Testing SNMP Trap Functionality

An Octel Overture 200/300 can inform an SNMP manager system when a qualified hardware error is logged. The `TEST SNMP` command tests the mechanism and gives assurance that the Octel Overture 200/300 can communicate to the SNMP manager system, is provided.

Before a `TEST SNMP` command can be used, System Parameter 242 must be set to `YES`, and the SNMP manager system must be configured, which means that either System Parameter 235 or System Parameters 233 and 236 must be configured.

TEST SNMP Operation

At the `@` prompt, enter

```
TEST SNMP 
```

The Octel Overture 200/300 then generates hardware error type 64, `DATA1 = 0E`, with a priority of 0. The system sends a trap on this error to the SNMP manager system. The user will be informed that the alarm has been sent and the test is completed.

The user may then have the SNMP manager system pull up the private MIBs for hardware errors on the Octel Overture 200/300. Successful completion of the test, however, does not guarantee that the SNMP manager system did indeed receive the trap. The SNMP protocol does not provide for an acknowledgment from the manager system. It is recommended that the SNMP manager system be pinged before doing `TEST SNMP`.

When `TEST SNMP` is complete, the Hardware Error Table should be listed. The listing will include the type 64 error and the following message:

```
*** SNMP MANAGER SYSTEM HAS BEEN NOTIFIED ***
```

The `C H` command should be used to clear both of these conditions.

TEST SNMP Messages

On successful completion of the `TEST SNMP` command, the following message is displayed:

```
ALARM HAS BEEN SENT TO THE SNMP MANAGER SYSTEM.
```

If for any reason the SNMP trap could not be sent, one of the following messages is displayed, as appropriate:

- PLEASE CONFIGURE SYSTEM PARAMETERS 235 OR 236 AND 233.
- LAN COMMUNICATION IS NOT UP.
- SYSTEM DOES NOT HAVE DIGITAL NETWORKING FEATURE.
- SYSTEM PARAMETER FOR DIGITAL NETWORKING IS NOT ENABLED.
- SYSTEM PARAMETER FOR SNMP TRAPS IS NOT ENABLED.
- HARDWARE ERROR TABLE IS FULL. PLEASE CLEAR IT FIRST.
- USER ABORT ...
- SYSTEM ERROR. PLEASE CONTACT TECHNICAL SUPPORT.
- FAILED TO SEND SNMP TRAP.

TEST SNMP Examples

Following is an example of a successful TEST SNMP:

```
@TEST SNMP
```

```
ALARM HAS BEEN SENT TO THE SNMP MANAGER SYSTEM.
```

Following is an example of an unsuccessful TEST SNMP:

```
@TEST SNMP
```

```
LAN COMMUNICATION IS NOT UP.
```

APPENDIX C

OCTEL PRIVATE MIB

11C.1 SAMPLE INTERNET SESSION TO OBTAIN THE PRIVATE MIB

This appendix provides a sample Internet session for obtaining the Octel Private MIB from Internet and a listing of the Octel Private MIB.

To obtain the private MIB file, connect to the Internet and then do FTP ANONYMOUS from ftp.ISI.EDU (128.9.176.20). Following is a sample session:

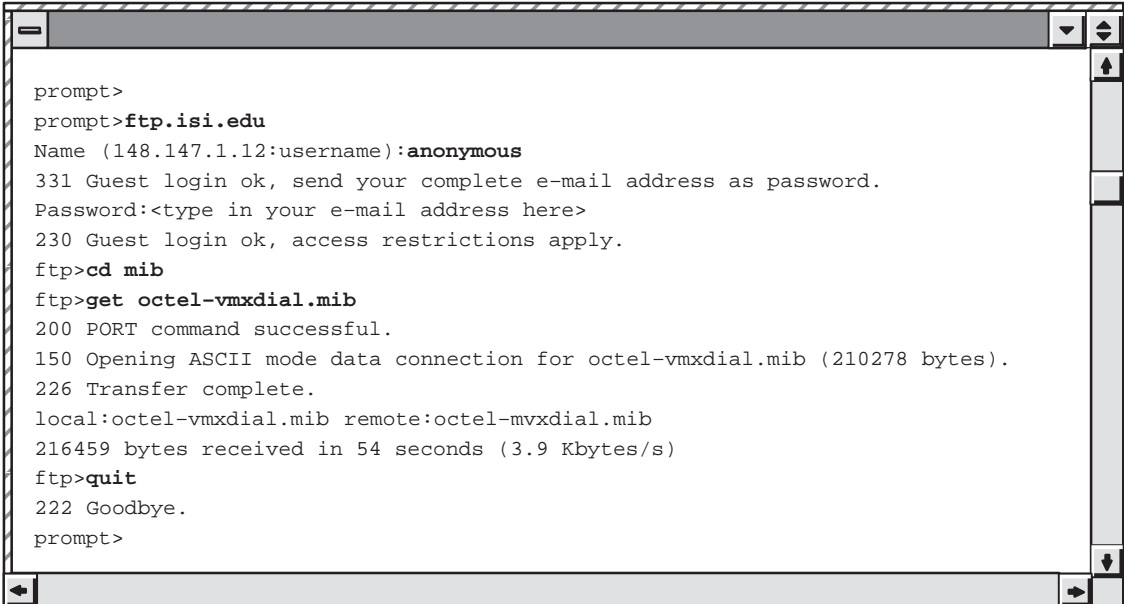

```
prompt>
prompt>ftp.isi.edu
Name (148.147.1.12:username):anonymous
331 Guest login ok, send your complete e-mail address as password.
Password:<type in your e-mail address here>
230 Guest login ok, access restrictions apply.
ftp>cd mib
ftp>get octel-vmxdial.mib
200 PORT command successful.
150 Opening ASCII mode data connection for octel-vmxdial.mib (210278 bytes).
226 Transfer complete.
local:octel-vmxdial.mib remote:octel-mvxdial.mib
216459 bytes received in 54 seconds (3.9 Kbytes/s)
ftp>quit
222 Goodbye.
prompt>
```

 Bold entries are what you type. Entries enclosed in <> indicate that you should substitute with the right data.

11C.2 LISTING OF OCTEL PRIVATE MIB

```

VMX-DIAL DEFINITIONS ::= BEGIN
--
-- VMX-DIAL private MIB definitions for the VMX200/300
-- Filename: vmxdial.mib
-- This MIB definition is provided for use with Octel's VMX200/300
-- product only.
--
-- Contact Person:
--             LAN Engineering Group
--             Octel Communication Corporation
--
-- NOTE:
-- 1. This file will be published electronically in
--     venera.isi.edu and can be obtained using ftp anonymous.
--
-- 2. Sunnet Manager User:
-- Sunnet doesn't support multi-dimensional table. To make this file works
-- with subnet, the mnemonic for the second level table need to be replaced
-- by the number it represents. Example:
-- locEntry is a table entry, and
--     routel is defined as locroute.1 where locroute is locEntry.7
-- the above definition need to be changed as follows:
-- . remove the definition for locroute
-- . routel is defined as locEntry.7.1
-- This need to be done for all multi-dimensional tables.
--
IMPORTS
    enterprises, NetworkAddress, IpAddress, Counter, Gauge,
        TimeTicks
        FROM RFC1155-SMI
    OBJECT-TYPE
        FROM RFC-1212
    DisplayString
        FROM RFC1213-MIB;
octel          OBJECT IDENTIFIER ::= { enterprises 662 }
octelOIDs      OBJECT IDENTIFIER ::= { octel 1 }
octelPlatforms OBJECT IDENTIFIER ::= { octelOIDs 1 }
vmx200         OBJECT IDENTIFIER ::= { octelPlatforms 3 }
vmx300         OBJECT IDENTIFIER ::= { octelPlatforms 4 }
octelProducts OBJECT IDENTIFIER ::= { octel 3 }
vmxDial        OBJECT IDENTIFIER ::= { octelProducts 1 }
config         OBJECT IDENTIFIER ::= { vmxDial 1 }
dNetstat       OBJECT IDENTIFIER ::= { vmxDial 2 }
location       OBJECT IDENTIFIER ::= { vmxDial 3 }
hwerr          OBJECT IDENTIFIER ::= { vmxDial 4 }
-- dNetstat subtrees
message        OBJECT IDENTIFIER ::= { dNetstat 1 }
lanCh          OBJECT IDENTIFIER ::= { dNetstat 2 }
lanConn        OBJECT IDENTIFIER ::= { dNetstat 3 }
systemName     OBJECT-TYPE
    SYNTAX DisplayString (SIZE (0..255))
    ACCESS read-only
    STATUS mandatory
    DESCRIPTION
        "VMX System Name, from Configuration"
    ::= { config 1 }
sysSerialNum   OBJECT-TYPE

```

```

        SYNTAX DisplayString (SIZE (0..255))
        ACCESS read-only
        STATUS mandatory
        DESCRIPTION
            "VMX System Serial Number."
        ::= { config 2 }
systemID OBJECT-TYPE
        SYNTAX DisplayString (SIZE (0..255))
        ACCESS read-only
        STATUS mandatory
        DESCRIPTION
            "VMX System Identification Number."
        ::= { config 3 }
sentVoiceMsgs OBJECT-TYPE
        SYNTAX Counter
        ACCESS read-only
        STATUS mandatory
        DESCRIPTION
            "Total number of voice messages sent to the networks"
        ::= { message 1 }
recvVoiceMsgs OBJECT-TYPE
        SYNTAX Counter
        ACCESS read-only
        STATUS mandatory
        DESCRIPTION
            "Total number of voice messages received from the networks"
        ::= { message 2 }
sentFaxMsgs OBJECT-TYPE
        SYNTAX Counter
        ACCESS read-only
        STATUS mandatory
        DESCRIPTION
            "Total number of fax messages sent to the networks"
        ::= { message 3 }
recvFaxMsgs OBJECT-TYPE
        SYNTAX Counter
        ACCESS read-only
        STATUS mandatory
        DESCRIPTION
            "Total number of fax messages received from the networks"
        ::= { message 4 }
recvNames OBJECT-TYPE
        SYNTAX Counter
        ACCESS read-only
        STATUS mandatory
        DESCRIPTION
            "Total number of name received from the networks"
        ::= { message 5 }
playedRtNames OBJECT-TYPE
        SYNTAX Counter
        ACCESS read-only
        STATUS mandatory
        DESCRIPTION
            "Total number of Real Time network name played"
        ::= { message 6 }
secSent OBJECT-TYPE
        SYNTAX INTEGER
        ACCESS read-only
        STATUS mandatory
        DESCRIPTION

```

```

        "Total number of seconds of message sent to the networks"
        ::= { message 7 }
secRecv OBJECT-TYPE
    SYNTAX INTEGER
    ACCESS read-only
    STATUS mandatory
    DESCRIPTION
        "Total number of seconds of message received from the networks"
        ::= { message 8 }
lchNumber OBJECT-TYPE
    SYNTAX INTEGER
    ACCESS read-only
    STATUS mandatory
    DESCRIPTION
        "Maximum number of LAN channel available in the system."
        ::= { lanCh 1 }
sec50pct OBJECT-TYPE
    SYNTAX INTEGER
    ACCESS read-only
    STATUS mandatory
    DESCRIPTION
        "Total number of second that 50 percent of lan channel is busy"
        ::= { lanCh 2 }
sec75pct OBJECT-TYPE
    SYNTAX INTEGER
    ACCESS read-only
    STATUS mandatory
    DESCRIPTION
        "Total number of second that 75 percent of lan channel is busy"
        ::= { lanCh 3 }
sec100pct OBJECT-TYPE
    SYNTAX INTEGER
    ACCESS read-only
    STATUS mandatory
    DESCRIPTION
        "Total number of second that all of lan channel is busy"
        ::= { lanCh 4 }
lchInSendSec OBJECT-TYPE
    SYNTAX INTEGER
    ACCESS read-only
    STATUS mandatory
    DESCRIPTION
        "Number of second LCH is in used for sending message"
        ::= { lanCh 5 }
lchInRecvSec OBJECT-TYPE
    SYNTAX INTEGER
    ACCESS read-only
    STATUS mandatory
    DESCRIPTION
        "Number of second LCH is in used for receiving message"
        ::= { lanCh 6 }
outAttempts OBJECT-TYPE
    SYNTAX Counter
    ACCESS read-only
    STATUS mandatory
    DESCRIPTION
        "Number of time an outgoing lan connection is attempted"
        ::= { lanConn 1 }
outRejects OBJECT-TYPE
    SYNTAX Counter

```

```

ACCESS read-only
STATUS mandatory
DESCRIPTION
    "Number of time an outgoing lan connection is rejected"
 ::= { lanConn 2 }
outGotBusys OBJECT-TYPE
SYNTAX Counter
ACCESS read-only
STATUS mandatory
DESCRIPTION
    "Number of time an outgoing lan connection is rejected,
    due to all LCH busy"
 ::= { lanConn 3 }
inAttempts OBJECT-TYPE
SYNTAX Counter
ACCESS read-only
STATUS mandatory
DESCRIPTION
    "Number of time an incoming lan connection is requested"
 ::= { lanConn 4 }
inRejects OBJECT-TYPE
SYNTAX Counter
ACCESS read-only
STATUS mandatory
DESCRIPTION
    "Number of time an incoming lan connection is rejected"
 ::= { lanConn 5 }
inGotBusys OBJECT-TYPE
SYNTAX Counter
ACCESS read-only
STATUS mandatory
DESCRIPTION
    "Number of time an incoming lan connection is rejected,
    due to all LCH busy"
 ::= { lanConn 6 }
lanAvailPct OBJECT-TYPE
SYNTAX INTEGER
ACCESS read-only
STATUS mandatory
DESCRIPTION
    "Percentage of LAN availability."
 ::= { dNetstat 4 }
locTable OBJECT-TYPE
SYNTAX SEQUENCE OF LocEntry
ACCESS not-accessible
STATUS mandatory
DESCRIPTION
    "List of active Digital Network Location."
 ::= { location 1 }
locEntry OBJECT-TYPE
SYNTAX LocEntry
ACCESS not-accessible
STATUS mandatory
DESCRIPTION
    "Each entry contains info about the Network Location."
INDEX { locIndex }
 ::= { locTable 1 }

LocEntry ::= SEQUENCE {
    locIndex

```

```

        INTEGER,
locName      DisplayString (SIZE (0..255)),
locIpAddr    IPAddress,
locLinkType  DisplayString,
locInDomain  DisplayString,
locColocated DisplayString,
route1      DisplayString (SIZE (0..255)),
route2      DisplayString (SIZE (0..255)),
route3      DisplayString (SIZE (0..255)),
cattempts   Counter,
cfailures   Counter,
cdropped    Counter,
cbusys      Counter,
cdayMin     INTEGER,
cnightMin   INTEGER,
mdvcAttempts Counter,
mdvcFails   Counter,
mdvcRetries Counter,
mdfxAttempts Counter,
mdfxFails   Counter,
mdfxRetries Counter,
mdDiskfulls Counter,
mdMbxfails  Counter,
mdMinute    INTEGER,
locPlayedNames Counter,
locLinkdrops Counter,
locAnalogstndbys Counter
}
locIndex      OBJECT-TYPE
SYNTAX      INTEGER
ACCESS      read-only
STATUS      mandatory
DESCRIPTION
    "Index of this Location Entry"

```



```

 ::= { locEntry 1 }
locName      OBJECT-TYPE
SYNTAX      DisplayString (SIZE (0..255))
ACCESS      read-only
STATUS      mandatory
DESCRIPTION
    "System Name of This Location Entry, SELF means this system"
 ::= { locEntry 2 }
locIpAddr    OBJECT-TYPE
SYNTAX      IPAddress
ACCESS      read-only
STATUS      mandatory
DESCRIPTION
    "Internet Address of this Location"
 ::= { locEntry 3 }
locLinkType  OBJECT-TYPE
SYNTAX      INTEGER {
    lowspeed(1),
    highspeed(2)
}
ACCESS      read-only
STATUS      mandatory
DESCRIPTION
    "Type of the network interface"
 ::= { locEntry 4 }
locInDomain  OBJECT-TYPE
SYNTAX      INTEGER {
    no(1),
    yes(2)
}
ACCESS      read-only
STATUS      mandatory
DESCRIPTION
    "Whether this location is in the same Uniform Numbering Plan
    domain. "
 ::= { locEntry 5 }
locColocated OBJECT-TYPE
SYNTAX      INTEGER {
    no(1),
    yes(2)
}
ACCESS      read-only
STATUS      mandatory
DESCRIPTION
    "Whether this location is in the same location."
 ::= { locEntry 6 }
locroute     OBJECT IDENTIFIER ::= { locEntry 7 }
routel       OBJECT-TYPE
SYNTAX      DisplayString (SIZE (0..255))
ACCESS      read-only
STATUS      mandatory
DESCRIPTION
    "First Entry in the Route Table for this location."
 ::= { locEntry 1 }
route2       OBJECT-TYPE
SYNTAX      DisplayString (SIZE (0..255))
ACCESS      read-only
STATUS      mandatory
DESCRIPTION
    "Second Entry in the Route Table for this location."

```

```

route3 ::= { locroute 2 }
        OBJECT-TYPE
        SYNTAX DisplayString (SIZE (0..255))
        ACCESS read-only
        STATUS mandatory
        DESCRIPTION
            "Third Entry in the Route Table for this location."
locConn OBJECT IDENTIFIER ::= { locEntry 8 }
cattempts OBJECT-TYPE
        SYNTAX Counter
        ACCESS read-only
        STATUS mandatory
        DESCRIPTION
            "Number of times LAN connection attempted."
cfailures ::= { locConn 1 }
          OBJECT-TYPE
          SYNTAX Counter
          ACCESS read-only
          STATUS mandatory
          DESCRIPTION
            "Number of times LAN connection to this location failed."
cdroppedcs ::= { locConn 2 }
          OBJECT-TYPE
          SYNTAX Counter
          ACCESS read-only
          STATUS mandatory
          DESCRIPTION
            "Number of times LAN connection to this location dropped."
cbusys ::= { locConn 3 }
        OBJECT-TYPE
        SYNTAX Counter
        ACCESS read-only
        STATUS mandatory
        DESCRIPTION
            "Number of times All LAN Connection is busy."
cdayMin ::= { locConn 4 }
        OBJECT-TYPE
        SYNTAX INTEGER
        ACCESS read-only
        STATUS mandatory
        DESCRIPTION
            "Number of minutes(day time) LAN connection is established."
cnightMin ::= { locConn 5 }
          OBJECT-TYPE
          SYNTAX INTEGER
          ACCESS read-only
          STATUS mandatory
          DESCRIPTION
            "Number of minutes(night time) LAN connection is established."
msgDelivery OBJECT IDENTIFIER ::= { locEntry 9 }
mdvcAttempts OBJECT-TYPE
        SYNTAX Counter
        ACCESS read-only
        STATUS mandatory
        DESCRIPTION
            "Number of voice message delivery attempts to this location."
mdvcFails ::= { msgDelivery 1 }
          OBJECT-TYPE

```

```

SYNTAX Counter
ACCESS read-only
STATUS mandatory
DESCRIPTION
    "Number of voice message delivery failures to this location."
 ::= { msgDelivery 2 }
mdvcRetries OBJECT-TYPE
SYNTAX Counter
ACCESS read-only
STATUS mandatory
DESCRIPTION
    "Number of voice message delivery retries to this location."
 ::= { msgDelivery 3 }
mdfxAttempts OBJECT-TYPE
SYNTAX Counter
ACCESS read-only
STATUS mandatory
DESCRIPTION
    "Number of fax message delivery attempts to this location."
 ::= { msgDelivery 4 }

mdfxFails OBJECT-TYPE
SYNTAX Counter
ACCESS read-only
STATUS mandatory
DESCRIPTION
    "Number of fax message delivery failures to this location."
 ::= { msgDelivery 5 }
mdfxRetries OBJECT-TYPE
SYNTAX Counter
ACCESS read-only
STATUS mandatory
DESCRIPTION
    "Number of fax message delivery retries to this location."
 ::= { msgDelivery 6 }
mdDiskfulls OBJECT-TYPE
SYNTAX Counter
ACCESS read-only
STATUS mandatory
DESCRIPTION
    "Number of message delivery to this location fails due to
    disk full."
 ::= { msgDelivery 7 }
mdMbxfails OBJECT-TYPE
SYNTAX Counter
ACCESS read-only
STATUS mandatory
DESCRIPTION
    "Number of message delivery to this location fails due to
    mailbox verification failure."
 ::= { msgDelivery 8 }
mdMinute OBJECT-TYPE
SYNTAX INTEGER
ACCESS read-only
STATUS mandatory
DESCRIPTION
    "Total number of message (in minute) delivered to
    this location."
 ::= { msgDelivery 9 }
locPlayedNames OBJECT-TYPE

```

```

        SYNTAX Counter
        ACCESS read-only
        STATUS mandatory
        DESCRIPTION
            "Number of Real Time Network Name Played from this location."
        ::= { locEntry 10 }
locLinkdrops OBJECT-TYPE
    SYNTAX Counter
    ACCESS read-only
    STATUS mandatory
    DESCRIPTION
        "Number of time LAN connection dropped, High Speed link only."
    ::= { locEntry 11 }
locAnalogstndbys OBJECT-TYPE
    SYNTAX Counter
    ACCESS read-only
    STATUS mandatory
    DESCRIPTION
        "Number of times Analog Standby used to this location."
    ::= { locEntry 12 }
hwerrTable OBJECT-TYPE
    SYNTAX SEQUENCE OF HwerrEntry
    ACCESS not-accessible
    STATUS mandatory
    DESCRIPTION
        "Table of Hardware errors."
    ::= { hwerr 1 }
hwerrEntry OBJECT-TYPE
    SYNTAX HwerrEntry
    ACCESS not-accessible
    STATUS mandatory
    DESCRIPTION
        "Hardware Error table Entry"
    INDEX { heIdx }
    ::= { hwerrTable 1 }
HwerrEntry ::= SEQUENCE {
    heIdx
        INTEGER,
    heType
        INTEGER,
    heSlot
        INTEGER,
    heMon
        INTEGER,
    heDay
        INTEGER,
    heHour
        INTEGER,
    heMin
        INTEGER,
    heCh
        INTEGER,
    hePrio
        INTEGER,
    heCnt
        INTEGER,
    heData1
        OCTET STRING,
    heData2
        OCTET STRING,

```

```

        heData3
            OCTET STRING,
        heData4
            OCTET STRING
    }
heIdx          OBJECT-TYPE
SYNTAX        INTEGER
ACCESS        read-only
STATUS        mandatory
DESCRIPTION   "Index of this Hardware Entry"
 ::= { hwerrEntry 1 }
heType        OBJECT-TYPE
SYNTAX        INTEGER
ACCESS        read-only
STATUS        mandatory
DESCRIPTION   "Error Type of this hardware error."
 ::= { hwerrEntry 2 }
heSlot        OBJECT-TYPE
SYNTAX        INTEGER
ACCESS        read-only
STATUS        mandatory
DESCRIPTION   "Slot Number of this Hardware Error Entry"
 ::= { hwerrEntry 3 }
heMon         OBJECT-TYPE
SYNTAX        INTEGER {
                jan(1),
                feb(2),
                mar(3),
                apr(4),
                may(5),
                jun(6),
                jul(7),
                aug(8),
                sep(9),
                oct(10),
                nov(11),
                dec(12)
            }
ACCESS        read-only
STATUS        mandatory
DESCRIPTION   "Month in which this Hardware Error Entry occurred"
 ::= { hwerrEntry 4 }
heDay         OBJECT-TYPE
SYNTAX        INTEGER
ACCESS        read-only
STATUS        mandatory
DESCRIPTION   "Day on which this Hardware Error Entry occurred"
 ::= { hwerrEntry 5 }
heHour        OBJECT-TYPE
SYNTAX        INTEGER
ACCESS        read-only
STATUS        mandatory
DESCRIPTION   "Hour on which this Hardware Error Entry occurred"
 ::= { hwerrEntry 6 }

```

```

heMin          OBJECT-TYPE
    SYNTAX     INTEGER
    ACCESS     read-only
    STATUS     mandatory
    DESCRIPTION
        "Minute on which this Hardware Error Entry occurred"
 ::= { hwerrEntry 7 }
heCh           OBJECT-TYPE
    SYNTAX     OCTET STRING
    ACCESS     read-only
    STATUS     mandatory
    DESCRIPTION
        "Channel Number of this Hardware Error Entry"
 ::= { hwerrEntry 8 }
hePrio        OBJECT-TYPE
    SYNTAX     INTEGER
    ACCESS     read-only
    STATUS     mandatory
    DESCRIPTION
        "Priority of this Hardware Error Entry"
 ::= { hwerrEntry 9 }
heCnt         OBJECT-TYPE
    SYNTAX     INTEGER
    ACCESS     read-only
    STATUS     mandatory
    DESCRIPTION
        "Frequency of this hardware error."
 ::= { hwerrEntry 10 }
heData1       OBJECT-TYPE
    SYNTAX     OCTET STRING
    ACCESS     read-only
    STATUS     mandatory
    DESCRIPTION
        "Data1 of this hardware error."
 ::= { hwerrEntry 11 }
heData2       OBJECT-TYPE
    SYNTAX     OCTET STRING
    ACCESS     read-only
    STATUS     mandatory
    DESCRIPTION
        "Data2 of this hardware error."
 ::= { hwerrEntry 12 }
heData3       OBJECT-TYPE
    SYNTAX     OCTET STRING
    ACCESS     read-only
    STATUS     mandatory
    DESCRIPTION
        "Data3 of this hardware error."
 ::= { hwerrEntry 13 }
heData4       OBJECT-TYPE
    SYNTAX     OCTET STRING
    ACCESS     read-only
    STATUS     mandatory
    DESCRIPTION
        "Data4 of this hardware error."
 ::= { hwerrEntry 14 }
hwerrTrap     TRAP-TYPE
    ENTERPRISE octel
    VARIABLES { sysDescr, heType, heSlot, heMon, heDay,
                heHour, heMin, heCh, hePrio, heCnt,

```

```
        heData1, heData2, heData3, heData4 }  
DESCRIPTION  
    "A hwerrTrap signifies that the VMX system has hardware errors  
    logged. This trap is sent if the user has configured it."  
 ::= 1  
END
```

12

PROCEDURES

Chapter Contents

12.1	Electronic Feature Delivery	12-1
12.2	Floppy Diskette Backup Procedures	12-3
	Backing Up All Names, Greetings, Scripted Messages, Sequential Messages, and Personal Distribution List Names	12-4
	Backing Up All Names	12-6
	Backing Up Local Names	12-8
	Backing Up Network Names	12-10
	Backing Up Greetings by COS	12-12
	Backing Up a Single Greeting	12-14
	Backing Up a Scripted or Sequential Mailbox	12-16
	Backing Up All Personal Distribution List Names	12-18
	Backing Up Language Prompts	12-20
12.3	Floppy Diskette Restore Procedures	12-22
	Restoring All Names, Greetings, Scripted Messages, Sequential Messages, and Personal Distribution List Names	12-23
	Restoring All Names	12-25
	Restoring Local Names	12-27
	Restoring a Name to a Different Mailbox	12-29
	Restoring Network Names	12-31
	Restoring a Single Greeting	12-33
	Restoring a Greeting to a Different Mailbox	12-34
	Restoring a Scripted or Sequential Mailbox	12-35
	Restoring All Personal Distribution List Names	12-36
	Restoring Language Prompts	12-37
12.4	Floppy Directory	12-39
12.5	Errors	12-40
12.6	Hard Disk Procedures	12-41
	Preparation	12-41
	Procedures	12-41
	Commands	12-41
	DSKMAP	12-41
	DSKTST	12-42
	DISKO	12-43
	Hard Disk Add	12-45
	Hard Disk Copy	12-48
	Hard Disk Remove	12-51
	Hard Disk Replace	12-54
	Hard Disk Restore	12-58
12.7	Adding Languages	12-71
	Upgrade Languages	12-72
	Adding Language Prompts	12-76

Quick Reference Guide

Procedures

Section	Command	Other Necessary Information
Electronic Feature Delivery/Removal		Order Administration department adds optional software.
Greeting Backup/Restore	FLOPPY	Backs up and restores greetings, names, scripted and sequential messages to and from hard disk and floppy diskettes. Floppy directory displays type of message backed up and from which mailbox.
Hard Disk Restore		Restores system to current release.
Disk Options	DISKO	Provides options for the addition, removal, or replacement of a hard disk drive, or for system restore.

12.1 ELECTRONIC FEATURE DELIVERY

The Option Control Chip (OCC), located on the Motherboard in Shelf A, contains the features the Octel Overture™ 200/300 is equipped with. The following optional features can be added to Octel Overture 200/300 message servers.

To see what options are installed on the Octel Overture 200/300, at the @ prompt, enter L F . The LIST FEATURE command displays the features installed, the number of ports, mailboxes, storage hours, and languages purchased as well as the number of Visual Mailbox™ and Fax Mail Plus licenses purchased.

☞ For the X in the part numbers, substitute 4 for the Octel Overture 200 and 3 for the Octel Overture 300 part number.

Software Option	Description
SW-X0003	Octel Mailbox Manager
SW-X0004	Voicenet™ Remote Analog Networking
SW-X0007	Fax Mail Plus
SW-X0008	Name and Greeting Redundancy
SW-X0009	Message Redundancy
SW-X0015	AMIS Analog Networking
SW-X0019	Single Digit Menus
SW-X0020	Incoming Call Restriction
SW-X0021	Call Queuing (formerly FIFO Queuing)
SW-X0022	OctelForms (formerly Scripted Prompting)
SW-X0024	Works for Serenade™
SW-X0026	Works for Serenade with the Octel Overture 200/300
SW-X0027	Works for Serenade Application Development Kit
SW-X0028	Works for Serenade 3270 Host Interface
SW-X0029	Works for Serenade Application Controlled Messaging
SW-X0030	Works for Serenade Local Database Access
SW-X0031	Adaptive Integration
SW-X0032	Works for Serenade Distributor's Application Development Kit
SW-X0033	Works for Serenade Async Host: 1–16 Sessions
SW-X0035	Works for Serenade Async Host: 17–32 Sessions
SW-X0049	Remote Digital Networking
SW-X0050	VMX 5000 User Interface
SW-X0052	OctelNet™ Analog Networking
SW-X0053	Domain Digital Networking
SW-X0055	TTD/TTY
SW-X0056	Digital Gateway for the Octel Overture 200 only
SW-X0057	LAN Backup and Restore

The following example shows the optional features listed when the LIST FEATURE command is entered. Refer to the Maintenance Commands chapter for an explanation of the fields in this screen.

```

@L F

----- SYSTEM SOFTWARE RELEASE S.x.x.x (MM/DD/YY) -----
DAY MM/DD HH:MM:SS YYYY SYSTEMNAME ID:XXX S/N:XXXXXX PBX:23

MODEL TYPE: OCTEL OVERTURE 300
SERIAL NUMBER: 200003
FEATURE PACKAGES:
SW-30001 SW-30003 SW-30004 SW-30007 SW-30008 SW-30009 SW-30015 SW-30019
SW-30020 SW-30021 SW-30022 SW-30023 SW-30024 SW-30026 SW-30027 SW-30028
SW-30029 SW-30030 SW-30031 SW-30032 SW-30034 SW-30049 SW-30050 SW-30051
SW-30052 SW-30053 SW-30055 SW-30056 SW-30057

-----
                Authorized    Used    Unused    Installed
-----
Ports :   Analog                --      0      0          0
          Fax                    --      8      0          8
          DSP                    16      8      8          16
          PIC                     24     20      4          24

MBXs :   Voice                   900     678     222     10000
          Non-Voice              9322      0     9322     10000
          VMB                     250     144     106      900
          Fax                     640     507     133     10000

Storage : Hours                  100      58      42          106
-----

MAXIMUM NUMBER OF DRIVES: 6
MAXIMUM NUMBER OF PORTS: 64
MAXIMUM NUMBER OF SCHEDULE TABLE ENTRIES: 8
NUMBER OF LANGUAGES: 2
@

```

Contact your Octel representative to add

- Optional software
- DSP or PIC Ports
- Mailboxes
- Disk storage hours
- Languages
- Visual Mailbox licenses
- Fax Mail Plus mailbox licenses

 The OCC must always remain with the message server it was purchased for. You cannot enter the UPDATE program if the OCC is not installed on the Shelf A Motherboard. If the Shelf A Motherboard must be replaced, the OCC assembly must be removed from the original board and installed on the replacement board.

12.2 FLOPPY DISKETTE BACKUP PROCEDURES

This section includes backup procedures to be used when backing up with floppy diskettes. If you plan to back up over the LAN, refer to the *Feature Description* volume, LAN Backup and Restore chapter. Floppy diskette backup procedures are used to back up

- All names.
- An individual name in a mailbox.
- All greetings.
- All greetings by COS.
- An individual greeting in a mailbox.
- All messages in a Scripted Prompt mailbox, or in a Sequential Greeting mailbox.
- All messages in all Scripted and Sequential Greeting mailboxes.
- Personal Distribution List names for all mailboxes.
- Personal Distribution List names for an individual mailbox.
- Network Names
- All names, greetings, messages in Scripted and Sequential Greeting mailboxes, and Personal Distribution List names.
- All prompts or a single prompt.

 Use 3.5 inch high-density floppy diskettes for Backup.

After the BACKUP option has been selected, the Octel Overture 200/300 checks the floppy to make sure it is not the System Configuration diskette or the Software Update diskette. If it is, a warning message prints and the backup is aborted.

The diskette is checked to determine if it is formatted. If the floppy is formatted, the Octel Overture 200/300 message server asks if you would like to continue. If the floppy is not formatted, the floppy diskette is formatted, and you are prompted to enter a name for the floppy before backing up the message.

If the floppy contains messages previously backed up, the Octel Overture 200/300 asks if you would like to reformat and reuse the floppy, or just append the message to the end.

The Backup supports messages that are too large to save on a single floppy; the Octel Overture 200/300 prompts you to insert another floppy. After the new floppy is inserted, the diskette is checked before the floppy is formatted and backup resumes.

To abort the Backup at any time, press Escape.

Backing Up All Names, Greetings, Scripted Messages, Sequential Messages, and Personal Distribution List Names

The following is an example of backing up all names, greetings, scripted messages, sequential messages, and Personal Distribution List names. New diskettes are inserted into the floppy drive.

Action	Octel Overture 200/300 Description and Response
1. @FLOPPY <input type="text" value="Enter"/>	<p>The following menu is displayed:</p> <pre> 1. BACKUP 2. RESTORE 3. FLOPPY DIRECTORY SELECT FLOPPY OPTION (1 - 3, EMPTY LINE = EXIT). :</pre>
2. :1 <input type="text" value="Enter"/>	<p>The following menu is displayed:</p> <pre> ----- BACKUP ----- 1. NAMES 2. GREETINGS 3. SCRIPT AND SEQUENTIAL MESSAGES 4. PERSONAL-DISTRIBUTION-LIST NAMES 5. PROMPTS 6. ALL NAMES, GREETINGS, SCRIPT AND SEQUENTIAL MESSAGES, PERSONAL-DISTRIBUTION-LIST NAMES SELECT BACKUP OPTION (1 - 6, EMPTY LINE = NONE). :</pre>
3. :6 <input type="text" value="Enter"/>	<p>The following is displayed:</p> <pre> INSERT FLOPPY, PRESS RETURN WHEN READY ENTER TITLE FOR THIS FLOPPY (1 - 14 CHARACTERS) :</pre>

Action**Octel Overture 200/300 Description and Response**4. :DISK #1

The following is displayed:

```

FORMATTING                               ...DONE
BACKING UP LOCAL-NAME FOR MAILBOX 370    ...DONE
BACKING UP LOCAL-NAME FOR MAILBOX 371    ...DONE
BACKING UP LOCAL-NAME FOR MAILBOX 372    ...DONE
BACKING UP LOCAL-NAME FOR MAILBOX 373    ...DONE
BACKING UP LOCAL-NAME FOR MAILBOX 374    ...DONE
BACKING UP LOCAL-NAME FOR MAILBOX 375    ...DONE
BACKING UP GREETING FOR MAILBOX 254      ...DONE
BACKING UP GREETING FOR MAILBOX 371      ...DONE
BACKING UP GREETING FOR MAILBOX 372      ...FLOPPY IS FULL!

INSERT ANOTHER FLOPPY TO CONTINUE, PRESS RETURN WHEN READY
ENTER TITLE FOR THIS FLOPPY (1 - 14 CHARACTERS).
:
```

5. :DISK #2

The following is displayed:

```

FORMATTING                               ...DONE
BACKING UP GREETING FOR MAILBOX 372      ...DONE
BACKING UP GREETING FOR MAILBOX 373      ...DONE
BACKING UP GREETING FOR MAILBOX 374      ...DONE
BACKING UP GREETING FOR MAILBOX 4006     ...DONE
BACKING UP GREETING FOR MAILBOX 4007     ...DONE
BACKING UP GREETING FOR MAILBOX 4008     ...DONE
BACKING UP SCRIPT/SEQUENTIAL MESSAGE FOR MAILBOX 370  DONE
BACKING UP SCRIPT/SEQUENTIAL MESSAGE FOR MAILBOX 370  DONE
BACKING UP SCRIPT/SEQUENTIAL MESSAGE FOR MAILBOX 370  DONE
BACKING UP SCRIPT/SEQUENTIAL MESSAGE FOR MAILBOX 370  DONE
BACKING UP PERS-DIST-LIST NAME FOR MAILBOX 370        DONE

-----  BACKUP COMPLETE  -----
-----  BACKUP  -----

1. NAMES
2. GREETINGS
3. SCRIPT AND SEQUENTIAL MESSAGES
4. PERSONAL-DISTRIBUTION-LIST NAMES
5. PROMPTS
6. ALL NAMES, GREETINGS, SCRIPT AND SEQUENTIAL MESSAGES,
   PERSONAL-DISTRIBUTION-LIST NAMES

SELECT BACKUP OPTION (1 - 6, EMPTY LINE = DONE).
:
```

Backing Up All Names

The following is an example of backing up all names.

Action

Octel Overture 200/300 Description and Response

1. @FLOPPY

The following menu is displayed:

```

1. BACKUP
2. RESTORE
3. FLOPPY DIRECTORY

SELECT FLOPPY OPTION (1 - 3, EMPTY LINE = EXIT).
:
```

2. :1

The following menu is displayed:

```

-----  BACKUP  -----

1. NAMES
2. GREETINGS
3. SCRIPT AND SEQUENTIAL MESSAGES
4. PERSONAL-DISTRIBUTION-LIST NAMES
5. PROMPTS
6. ALL NAMES, GREETINGS, SCRIPT AND SEQUENTIAL MESSAGES,
   PERSONAL-DISTRIBUTION-LIST NAMES

SELECT BACKUP OPTION (1 - 6, EMPTY LINE = NONE).
:
```

3. :1

The following menu is displayed:

```

-----  BACKUP NAMES  -----

1. LOCAL NAMES
2. NETWORK NAMES
3. ALL NAMES

SELECT NAME OPTION (1 - 3, EMPTY LINE = DONE)
:
```

4. :3

The following is displayed:

```

-----  BACKUP ALL LOCAL NAMES  -----

INSERT FLOPPY, PRESS RETURN WHEN READY

ENTER TITLE FOR THIS FLOPPY (1 - 14 CHARACTERS)
:
```

Action**Octel Overture 200/300 Description and Response**5. :ALLNAMES

The following is displayed:

```

FORMATting                                     ...DONE
BACKING UP LOCAL-NAME FOR MAILBOX 370         ...DONE
BACKING UP LOCAL-NAME FOR MAILBOX 371         ...DONE
BACKING UP LOCAL-NAME FOR MAILBOX 372         ...DONE
BACKING UP LOCAL-NAME FOR MAILBOX 373         ...DONE
BACKING UP LOCAL-NAME FOR MAILBOX 374         ...DONE
BACKING UP LOCAL-NAME FOR MAILBOX 375         ...DONE

-----  BACKUP ALL NETWORK NAMES  -----

BACKING UP NETNAME FOR MAILBOX 7710375        ...DONE

-----  BACKUP OF LOCAL AND NETWORK NAMES COMPLETE  -----

-----  BACKUP  -----

1. NAMES
2. GREETINGS
3. SCRIPT AND SEQUENTIAL MESSAGES
4. PERSONAL-DISTRIBUTION-LIST NAMES
5. PROMPTS
6. ALL NAMES, GREETINGS, SCRIPT AND SEQUENTIAL
   MESSAGES,PERSONAL-DISTRIBUTION-LIST NAMES

SELECT BACKUP OPTION (1 - 6, EMPTY LINE = DONE).
:
```

Backing Up Local Names

The following is an example of backing up local names.

Action	Octel Overture 200/300 Description and Response
1. @FLOPPY <input type="text" value="Enter"/>	<p>The following menu is displayed:</p> <pre data-bbox="662 489 1464 699"> 1. BACKUP 2. RESTORE 3. FLOPPY DIRECTORY SELECT FLOPPY OPTION (1 - 3, EMPTY LINE = EXIT). :</pre>
2. :1 <input type="text" value="Enter"/>	<p>The following menu is displayed:</p> <pre data-bbox="662 825 1464 1161"> ----- BACKUP ----- 1. NAMES 2. GREETINGS 3. SCRIPT AND SEQUENTIAL MESSAGES 4. PERSONAL-DISTRIBUTION-LIST NAMES 5. PROMPTS 6. ALL NAMES, GREETINGS, SCRIPT AND SEQUENTIAL MESSAGES, PERSONAL-DISTRIBUTION-LIST NAMES SELECT BACKUP OPTION (1 - 6, EMPTY LINE = NONE). :</pre>
3. :1 <input type="text" value="Enter"/>	<p>The following menu is displayed:</p> <pre data-bbox="662 1287 1464 1560"> ----- BACKUP NAMES ----- 1. LOCAL NAMES 2. NETWORK NAMES 3. ALL NAMES SELECT NAME OPTION (1 - 3, EMPTY LINE = DONE) :</pre>
4. :1 <input type="text" value="Enter"/>	<p>The following is displayed:</p> <pre data-bbox="662 1686 1464 1898"> ----- BACKUP OF LOCAL NAMES ----- ENTER THE MAILBOX NUMBER TO BACKUP (1 - 8 DIGITS, ALL, EMPTY LINE = DONE)</pre>

Action**Octel Overture 200/300 Description and Response**5. :ALL

The following is displayed:

```

-----  BACKUP ALL LOCAL NAMES  -----
INSERT FLOPPY, PRESS RETURN WHEN READY
ENTER TITLE FOR THIS FLOPPY (1 - 14 CHARACTERS)
:
```

6. :LOCALNAMES1

The following is displayed:

```

FORMATTING                                     ...DONE
BACKING UP LOCAL-NAME FOR MAILBOX 370         ...DONE
BACKING UP LOCAL-NAME FOR MAILBOX 371         ...DONE
BACKING UP LOCAL-NAME FOR MAILBOX 372         ...DONE
BACKING UP LOCAL-NAME FOR MAILBOX 373         ...DONE
BACKING UP LOCAL-NAME FOR MAILBOX 374         ...DONE
BACKING UP LOCAL-NAME FOR MAILBOX 375         ...DONE

-----  BACKUP OF ALL LOCAL NAMES COMPLETE  -----

-----  BACKUP NAMES  -----

1. LOCAL NAMES
2. NETWORK NAMES
3. ALL NAMES

SELECT NAME OPTION (1 - 3, EMPTY LINE = DONE)
:
```

Backing Up Network Names

The following is an example of backing up network names.

Action	Octel Overture 200/300 Description and Response
1. @FLOPPY <input type="text" value="Enter"/>	<p>The following menu is displayed:</p> <pre> 1. BACKUP 2. RESTORE 3. FLOPPY DIRECTORY SELECT FLOPPY OPTION (1 - 3, EMPTY LINE = EXIT). : </pre>
2. :1 <input type="text" value="Enter"/>	<p>The following menu is displayed:</p> <pre> ----- BACKUP ----- 1. NAMES 2. GREETINGS 3. SCRIPT AND SEQUENTIAL MESSAGES 4. PERSONAL-DISTRIBUTION-LIST NAMES 5. PROMPTS 6. ALL NAMES, GREETINGS, SCRIPT AND SEQUENTIAL MESSAGES, PERSONAL-DISTRIBUTION-LIST NAMES SELECT BACKUP OPTION (1 - 6, EMPTY LINE = NONE). : </pre>
3. :1 <input type="text" value="Enter"/>	<p>The following menu is displayed:</p> <pre> ----- BACKUP NAMES ----- 1. LOCAL NAMES 2. NETWORK NAMES 3. ALL NAMES SELECT NAME OPTION (1 - 3, EMPTY LINE = DONE) : </pre>
4. :2 <input type="text" value="Enter"/>	<p>The following is displayed:</p> <pre> ----- BACKUP NETWORK NAMES ----- ENTER THE NETWORK MAILBOX NUMBER TO BACKUP (1 - 16 DIGITS, ALL, EMPTY LINE = DONE) </pre>

Action**Octel Overture 200/300 Description and Response**5. :ALL

The following is displayed:

```

INSERT FLOPPY, PRESS RETURN WHEN READY

ENTER TITLE FOR THIS FLOPPY (1 - 14 CHARACTERS)
:
```

6. :NETNAMES1

The following is displayed:

```

FORMATTING                                     ...DONE
BACKING UP NETNAME FOR MAILBOX 7710311         ...DONE
BACKING UP NETNAME FOR MAILBOX 7710312         ...DONE
BACKING UP NETNAME FOR MAILBOX 7710313         ...DONE
BACKING UP NETNAME FOR MAILBOX 7710314         ...DONE

-----  BACKUP OF ALL NETWORK NAMES COMPLETE  -----
-----  BACKUP NAMES  -----

1. LOCAL NAMES
2. NETWORK NAMES
3. ALL NAMES

SELECT NAME OPTION (1 - 3, EMPTY LINE = DONE)
:
```

Backing Up Greetings by COS

The following is an example of backing up greetings by COS.

Action	Octel Overture 200/300 Description and Response
1. @FLOPPY <input type="text" value="Enter"/>	<p>The following menu is displayed:</p> <pre> 1. BACKUP 2. RESTORE 3. FLOPPY DIRECTORY SELECT FLOPPY OPTION (1 - 3, EMPTY LINE = EXIT). : </pre>
2. :1 <input type="text" value="Enter"/>	<p>The following menu is displayed:</p> <pre> ----- BACKUP ----- 1. NAMES 2. GREETINGS 3. SCRIPT AND SEQUENTIAL MESSAGES 4. PERSONAL-DISTRIBUTION-LIST NAMES 5. PROMPTS 6. ALL NAMES, GREETINGS, SCRIPT AND SEQUENTIAL MESSAGES, PERSONAL-DISTRIBUTION-LIST NAMES SELECT BACKUP OPTION (1 - 6, EMPTY LINE = NONE). : </pre>
3. :2 <input type="text" value="Enter"/>	<p>The following is displayed:</p> <pre> ----- GREETINGS ----- ENTER THE MAILBOX NUMBER TO BACKUP (1 - 8 DIGITS, ALL, COS, EMPTY LINE = DONE). : </pre>
4. :COS <input type="text" value="Enter"/>	<p>The following is displayed:</p> <pre> ENTER COS OF MAILBOXES TO BACKUP (0-127). : </pre>

Action**Octel Overture 200/300 Description and Response**5. :20

The following is displayed:

```

INSERT FLOPPY, PRESS RETURN WHEN READY

WARNING! FLOPPY ALREADY HAS MESSAGES.

TITLE: TEST SAMPLE

WOULD YOU LIKE TO RE-USE?
(Y = CURRENT DATE WILL BE LOST, N = WILL APPEND TO THE END).
:

```

6. :N

The following menu is displayed:

```

BACKING UP GREETING FOR MAILBOX 351      ...DONE
BACKING UP GREETING FOR MAILBOX 352      ...DONE
BACKING UP GREETING FOR MAILBOX 353      ...DONE

-----  BACKUP COMPLETE  -----

-----  BACKUP  -----

1. NAMES
2. GREETINGS
3. SCRIPT AND SEQUENTIAL MESSAGES
4. PERSONAL-DISTRIBUTION-LIST NAMES
5. PROMPTS
6. ALL NAMES, GREETINGS, SCRIPT AND SEQUENTIAL
   MESSAGES, PERSONAL-DISTRIBUTION-LIST NAMES

SELECT BACKUP OPTION (1 - 6, EMPTY LINE = DONE).
:

```

Backing Up a Single Greeting

The following is an example of backing up a single greeting.

Action	Octel Overture 200/300 Description and Response
1. @FLOPPY <input type="text" value="Enter"/>	<p>The following menu is displayed:</p> <pre> 1. BACKUP 2. RESTORE 3. FLOPPY DIRECTORY SELECT FLOPPY OPTION (1 - 3, EMPTY LINE = EXIT). : </pre>
2. :1 <input type="text" value="Enter"/>	<p>The following menu is displayed:</p> <pre> ----- BACKUP ----- 1. NAMES 2. GREETINGS 3. SCRIPT AND SEQUENTIAL MESSAGES 4. PERSONAL-DISTRIBUTION-LIST NAMES 5. PROMPTS 6. ALL NAMES, GREETINGS, SCRIPT AND SEQUENTIAL MESSAGES, PERSONAL-DISTRIBUTION-LIST NAMES SELECT BACKUP OPTION (1 - 6, EMPTY LINE = NONE). : </pre>
3. :2 <input type="text" value="Enter"/>	<p>The following is displayed:</p> <pre> ----- GREETINGS ----- ENTER THE MAILBOX NUMBER TO BACKUP (1 - 8 DIGITS, ALL, COS, EMPTY LINE = DONE). : </pre>
4. :371 <input type="text" value="Enter"/>	<p>The following is displayed:</p> <pre> INSERT FLOPPY, PRESS RETURN WHEN READY WARNING! FLOPPY ALREADY HAS MESSAGES. TITLE: TEST SAMPLE #2 WOULD YOU LIKE TO RE-USE? (Y = CURRENT DATE WILL BE LOST, N = WILL APPEND TO THE END). : </pre>

Action**Octel Overture 200/300 Description and Response**5. :N

The following is displayed:

```
BACKING UP GREETING FOR MAILBOX 371          ...DONE
-----  BACKUP COMPLETE  -----
-----  BACKUP  -----

1. NAMES
2. GREETINGS
3. SCRIPT AND SEQUENTIAL MESSAGES
4. PERSONAL-DISTRIBUTION-LIST NAMES
5. PROMPTS
6. ALL NAMES, GREETINGS, SCRIPT AND SEQUENTIAL
   MESSAGES, PERSONAL-DISTRIBUTION-LIST NAMES

SELECT BACKUP OPTION (1 - 6, EMPTY LINE = DONE).
:
```

Backing Up a Scripted or Sequential Mailbox

The following is an example of backing up a Scripted or Sequential mailbox.

Action

Octel Overture 200/300 Description and Response

1. @FLOPPY

The following menu is displayed:

```

1. BACKUP
2. RESTORE
3. FLOPPY DIRECTORY

SELECT FLOPPY OPTION (1 - 3, EMPTY LINE = EXIT).
:
```

2. :1

The following menu is displayed:

```

-----  BACKUP  -----

1. NAMES
2. GREETINGS
3. SCRIPT AND SEQUENTIAL MESSAGES
4. PERSONAL-DISTRIBUTION-LIST NAMES
5. PROMPTS
6. ALL NAMES, GREETINGS, SCRIPT AND SEQUENTIAL MESSAGES,
   PERSONAL-DISTRIBUTION-LIST NAMES

SELECT BACKUP OPTION (1 - 6, EMPTY LINE = NONE).
:
```

3. :3

The following is displayed:

```

-----  SCRIPTED/SEQUENTIAL MESSAGES  -----
ENTER THE MAILBOX NUMBER TO BACKUP
(1 - 8 DIGITS, ALL, EMPTY LINE = DONE).
:
```

4. :370

The following is displayed:

```

INSERT FLOPPY, PRESS RETURN WHEN READY

WARNING!  FLOPPY ALREADY HAS MESSAGES.

TITLE:  SAMPLE #3

WOULD YOU LIKE TO RE-USE?
(Y = CURRENT DATE WILL BE LOST, N = WILL APPEND TO THE END).
:
```

Action**Octel Overture 200/300 Description and Response**5. :Y

The following is displayed:

```
ENTER THE TITLE FOR THIS FLOPPY (1-14 CHARACTERS).
:
```

6. :SCRIPTS

The following is displayed:

```
BACKING UP SCRIPT/SEQUENTIAL MESSAGE FOR MAILBOX 370  DONE
BACKING UP SCRIPT/SEQUENTIAL MESSAGE FOR MAILBOX 370  DONE
BACKING UP SCRIPT/SEQUENTIAL MESSAGE FOR MAILBOX 370  DONE
BACKING UP SCRIPT/SEQUENTIAL MESSAGE FOR MAILBOX 370  DONE
```

```
-----  BACKUP COMPLETE  -----
```

```
-----  BACKUP  -----
```

1. NAMES
2. GREETINGS
3. SCRIPT AND SEQUENTIAL MESSAGES
4. PERSONAL-DISTRIBUTION-LIST NAMES
5. PROMPTS
6. ALL NAMES, GREETINGS, SCRIPT AND SEQUENTIAL
MESSAGES, PERSONAL-DISTRIBUTION-LIST NAMES

```
SELECT BACKUP OPTION (1 - 6, EMPTY LINE = DONE).
:
```

Backing Up All Personal Distribution List Names

The following is an example of backing up all Personal Distribution List names.

Action	Octel Overture 200/300 Description and Response
1. @FLOPPY <input type="text" value="Enter"/>	<p>The following menu is displayed:</p> <pre> 1. BACKUP 2. RESTORE 3. FLOPPY DIRECTORY SELECT FLOPPY OPTION (1 - 3, EMPTY LINE = EXIT). : </pre>
2. :1 <input type="text" value="Enter"/>	<p>The following menu is displayed:</p> <pre> ----- BACKUP ----- 1. NAMES 2. GREETINGS 3. SCRIPT AND SEQUENTIAL MESSAGES 4. PERSONAL-DISTRIBUTION-LIST NAMES 5. PROMPTS 6. ALL NAMES, GREETINGS, SCRIPT AND SEQUENTIAL MESSAGES, PERSONAL-DISTRIBUTION-LIST NAMES SELECT BACKUP OPTION (1 - 6, EMPTY LINE = NONE). : </pre>
3. :4 <input type="text" value="Enter"/>	<p>The following is displayed:</p> <pre> ----- PERS-DIST-LIST NAMES ----- ENTER THE MAILBOX NUMBER TO BACKUP (1-8 DIGITS, ALL, EMPTY LINE = DONE). : </pre>
4. :ALL <input type="text" value="Enter"/>	<p>The following is displayed:</p> <pre> INSERT FLOPPY, PRESS RETURN WHEN READY ENTER TITLE FOR THIS FLOPPY (1 - 14 CHARACTERS) : </pre>

Action**Octel Overture 200/300 Description and Response**5. :ALL PDL

The following is displayed:

```

FORMATTING                                     DONE
BACKING UP PERS-DIST-LIST NAME FOR MAILBOX 420  DONE
BACKING UP PERS-DIST-LIST NAME FOR MAILBOX 421  DONE
BACKING UP PERS-DIST-LIST NAME FOR MAILBOX 422  DONE
BACKING UP PERS-DIST-LIST NAME FOR MAILBOX 423  DONE
BACKING UP PERS-DIST-LIST NAME FOR MAILBOX 424  DONE
BACKING UP PERS-DIST-LIST NAME FOR MAILBOX 425  DONE

-----  BACKUP COMPLETE  -----

-----  BACKUP  -----

1. NAMES
2. GREETINGS
3. SCRIPT AND SEQUENTIAL MESSAGES
4. PERSONAL-DISTRIBUTION-LIST NAMES
5. PROMPTS
6. ALL NAMES, GREETINGS, SCRIPT AND SEQUENTIAL
   MESSAGES,PERSONAL-DISTRIBUTION-LIST NAMES

SELECT BACKUP OPTION (1 - 6, EMPTY LINE = DONE).
:
```

Backing Up Language Prompts

All prompts or a specific prompt for a language can be backed up to floppy diskettes.

Action

Octel Overture 200/300 Description and Response

1. @FLOPPY

The following menu is displayed:

```

1. BACKUP
2. RESTORE
3. FLOPPY DIRECTORY

SELECT FLOPPY OPTION (1 - 3, EMPTY LINE = EXIT).
:
```

2. :1

The following menu is displayed:

```

-----  BACKUP  -----

1. NAMES
2. GREETINGS
3. SCRIPT AND SEQUENTIAL MESSAGES
4. PERSONAL-DISTRIBUTION-LIST NAMES
5. PROMPTS
6. ALL NAMES, GREETINGS, SCRIPT AND SEQUENTIAL MESSAGES,
   PERSONAL-DISTRIBUTION-LIST NAMES

SELECT BACKUP OPTION (1 - 6, EMPTY LINE = NONE).
:
```

3. :5

The following menu is displayed:

```

-----  BACKUP PROMPTS  -----

1. ENGL US--V  Version#  __
2. SPAN US--V  Version#  __

SELECT LANGUAGE ( 1 - 2, EMPTY LINE = DONE)
:1
```

4. :1

Select the language to backup. The following is displayed:

```

ENTER PROMPT NUMBER

(1 - 4 DIGITS, ALL, EMPTY LINE = DONE)
:ALL

INSERT FLOPPY, PRESS RETURN WHEN READY
```

Action**Octel Overture 200/300 Description and Response**

5. :ALL

The following is displayed:

```
-----  BACKUP OF PROMPTS COMPLETE  -----  
  
-----  BACKUP  -----  
  
1. NAMES  
2. GREETINGS  
3. SCRIPT AND SEQUENTIAL MESSAGES  
4. PERSONAL-DISTRIBUTION-LIST NAMES  
5. PROMPTS  
6. ALL NAMES, GREETINGS, SCRIPT AND SEQUENTIAL.  
   MESSAGES, PERSONAL-DISTRIBUTION-LIST NAMES
```

12.3 FLOPPY DISKETTE RESTORE PROCEDURES

This section includes restore procedures to be used when restoring with floppy diskettes. If you plan to restore over the LAN, refer to the *Feature Description* volume, LAN Backup and Restore chapter. Floppy diskette restore procedures are used to restore

- All names.
- An individual name on a mailbox.
- An individual name to a different mailbox.
- All greetings.
- An individual greeting on a mailbox.
- All scripted and sequential messages.
- All scripted or sequential messages for an individual mailbox.
- Personal Distribution List names for all mailboxes.
- Personal Distribution List names for an individual mailbox.
- System prompts
- All names, greetings, scripted and sequential messages, and Personal Distribution List names.

There is also a way to restore greetings or messages to a mailbox different than the one from which it was originally saved.

If a caller is currently logged onto a mailbox that is about to be restored, the Octel Overture 200/300 waits until that caller has logged off (or hung up) before proceeding to restore the messages to the mailbox.

The restore may be aborted at any time by pressing Escape.

-  If restore is aborted, the restore procedure must be restarted from the beginning. If restoring prompts, all prompt diskettes must be re-entered beginning with Diskette #1.

Restoring All Names, Greetings, Scripted Messages, Sequential Messages, and Personal Distribution List Names

The following is an example of restoring all names, greetings, scripted messages, sequential messages, and Personal Distribution List names.

Action	Octel Overture 200/300 Description and Response
1. @FLOPPY <input type="text" value="Enter"/>	<p>The following menu is displayed:</p> <pre> 1. BACKUP 2. RESTORE 3. FLOPPY DIRECTORY SELECT FLOPPY OPTION (1 - 3, EMPTY LINE = EXIT). : </pre>
2. :2 <input type="text" value="Enter"/>	<p>The following menu is displayed:</p> <pre> ----- RESTORE ----- 1. NAMES 2. GREETINGS 3. SCRIPT AND SEQUENTIAL MESSAGES 4. PERSONAL-DISTRIBUTION-LIST NAMES 5. PROMPTS 6. ALL NAMES, GREETINGS, SCRIPT AND SEQUENTIAL MESSAGES, PERSONAL-DISTRIBUTION-LIST NAMES SELECT BACKUP OPTION (1 - 6, EMPTY LINE = NONE). : </pre>
3. :6 <input type="text" value="Enter"/>	<p>The following is displayed:</p> <pre> INSERT FLOPPY, PRESS RETURN WHEN READY </pre>
4. Insert first disk. Press <input type="text" value="Enter"/>	<pre> TITLE :DISK #1 RESTORING LOCAL-NAME FOR MAILBOX 370 ...DONE RESTORING LOCAL-NAME FOR MAILBOX 371 ...DONE RESTORING LOCAL-NAME FOR MAILBOX 372 ...DONE RESTORING LOCAL-NAME FOR MAILBOX 373 ...DONE RESTORING LOCAL-NAME FOR MAILBOX 374 ...DONE RESTORING LOCAL-NAME FOR MAILBOX 375 ...DONE RESTORING GREETING FOR MAILBOX 254 ...DONE RESTORING GREETING FOR MAILBOX 371 ...DONE RESTORING GREETING FOR MAILBOX 372 ...REACHED END INSERT ANOTHER FLOPPY TO CONTINUE, PRESS RETURN WHEN READY </pre>

Action**Octel Overture 200/300 Description and Response**

5. Insert additional disks.
Press

When Restore is complete, the following is displayed:

```
----- RESTORE COMPLETE -----  
  
----- RESTORE -----  
  
1. NAMES  
2. GREETINGS  
3. SCRIPT AND SEQUENTIAL MESSAGES  
4. PERSONAL-DISTRIBUTION-LIST NAMES  
5. PROMPTS  
6. ALL NAMES, GREETINGS, SCRIPT AND SEQUENTIAL  
   MESSAGES, PERSONAL-DISTRIBUTION-LIST NAMES  
  
SELECT RESTORE OPTION (1 - 6, EMPTY LINE = DONE).  
:
```

Restoring All Names

The following is an example of restoring all names.

Action	Octel Overture 200/300 Description and Response
1. @FLOPPY <input type="text" value="Enter"/>	<p>The following menu is displayed:</p> <pre> 1. BACKUP 2. RESTORE 3. FLOPPY DIRECTORY SELECT FLOPPY OPTION (1 - 3, EMPTY LINE = EXIT). :</pre>
2. :2 <input type="text" value="Enter"/>	<p>The following menu is displayed:</p> <pre> ----- RESTORE ----- 1. NAMES 2. GREETINGS 3. SCRIPT AND SEQUENTIAL MESSAGES 4. PERSONAL-DISTRIBUTION-LIST NAMES 5. PROMPTS 6. ALL NAMES, GREETINGS, SCRIPT AND SEQUENTIAL MESSAGES, PERSONAL-DISTRIBUTION-LIST NAMES SELECT BACKUP OPTION (1 - 6, EMPTY LINE = NONE). :</pre>
3. :1 <input type="text" value="Enter"/>	<p>The following menu is displayed:</p> <pre> ----- RESTORE NAMES ----- 1. LOCAL NAMES 2. NETWORK NAMES 3. ALL NAMES SELECT NAME OPTION (1-3, EMPTY LINE = DONE) :</pre>

Action**Octel Overture 200/300 Description and Response**4. :3

The following is displayed:

```
----- RESTORE OF LOCAL AND NETWORK NAMES -----  
INSERT FLOPPY, PRESS RETURN WHEN READY  
  
TITLE: DISK #1  
RESTORING LOCAL-NAME FOR MAILBOX 370      ...DONE  
RESTORING LOCAL-NAME FOR MAILBOX 371      ...DONE  
RESTORING LOCAL-NAME FOR MAILBOX 372      ...DONE  
RESTORING LOCAL-NAME FOR MAILBOX 373      ...DONE  
RESTORING LOCAL-NAME FOR MAILBOX 374      ...DONE  
RESTORING LOCAL-NAME FOR MAILBOX 375      ...DONE  
RESTORING NETNAME FOR MAILBOX 7710370     ...DONE  
  
----- RESTORE OF LOCAL AND NETWORK NAMES COMPLETE -----  
  
----- RESTORE -----  
  
1. NAMES  
2. GREETINGS  
3. SCRIPT AND SEQUENTIAL MESSAGES  
4. PERSONAL-DISTRIBUTION-LIST NAMES  
5. PROMPTS  
6. ALL NAMES, GREETINGS, SCRIPT AND SEQUENTIAL  
   MESSAGES, PERSONAL-DISTRIBUTION-LIST NAMES  
  
SELECT RESTORE OPTION (1 - 6, EMPTY LINE = DONE).  
:
```

Restoring Local Names

Individual names or all local names can be restored. The following is an example of restoring local names.

Action	Octel Overture 200/300 Description and Response
1. @FLOPPY <input type="text" value="Enter"/>	<p>The following menu is displayed:</p> <pre> 1. BACKUP 2. RESTORE 3. FLOPPY DIRECTORY SELECT FLOPPY OPTION (1 - 3, EMPTY LINE = EXIT). :</pre>
2. :2 <input type="text" value="Enter"/>	<p>The following menu is displayed:</p> <pre> ----- RESTORE ----- 1. NAMES 2. GREETINGS 3. SCRIPT AND SEQUENTIAL MESSAGES 4. PERSONAL-DISTRIBUTION-LIST NAMES 5. PROMPTS 6. ALL NAMES, GREETINGS, SCRIPT AND SEQUENTIAL MESSAGES, PERSONAL-DISTRIBUTION-LIST NAMES SELECT BACKUP OPTION (1 - 6, EMPTY LINE = NONE). :</pre>
3. :1 <input type="text" value="Enter"/>	<p>The following menu is displayed:</p> <pre> ----- RESTORE NAMES ----- 1. LOCAL NAMES 2. NETWORK NAMES 3. ALL NAMES SELECT NAME OPTION (1-3, EMPTY LINE = DONE) :</pre>
4. :1 <input type="text" value="Enter"/>	<p>The following is displayed:</p> <pre> ----- RESTORE OF LOCAL NAMES ----- (1 - 8 DIGITS, ALL, EMPTY LINE = DONE) :</pre>

Action**Octel Overture 200/300 Description and Response**5. :ALL

The following is displayed:

```
INSERT FLOPPY, PRESS RETURN WHEN READY

TITLE: DISK #1
RESTORING LOCAL-NAME FOR MAILBOX 370      ...DONE
RESTORING LOCAL-NAME FOR MAILBOX 371      ...DONE
RESTORING LOCAL-NAME FOR MAILBOX 372      ...DONE
RESTORING LOCAL-NAME FOR MAILBOX 373      ...DONE
RESTORING LOCAL-NAME FOR MAILBOX 374      ...DONE
RESTORING LOCAL-NAME FOR MAILBOX 375      ...DONE

----- RESTORE OF ALL LOCAL NAMES COMPLETE -----
----- RESTORE -----

1. LOCAL NAMES
2. NETWORK NAMES
3. ALL NAMES

SELECT NAME OPTION (1-3, EMPTY LINE = DONE)
:
```

Restoring a Name to a Different Mailbox

The following is an example of restoring a name to a different mailbox.

Action	Octel Overture 200/300 Description and Response
1. @FLOPPY <input type="text" value="Enter"/>	<p>The following menu is displayed:</p> <pre> 1. BACKUP 2. RESTORE 3. FLOPPY DIRECTORY SELECT FLOPPY OPTION (1 - 3, EMPTY LINE = EXIT). : </pre>
2. :2 <input type="text" value="Enter"/>	<p>The following menu is displayed:</p> <pre> ----- RESTORE ----- 1. NAMES 2. GREETINGS 3. SCRIPT AND SEQUENTIAL MESSAGES 4. PERSONAL-DISTRIBUTION-LIST NAMES 5. PROMPTS 6. ALL NAMES, GREETINGS, SCRIPT AND SEQUENTIAL MESSAGES, PERSONAL-DISTRIBUTION-LIST NAMES SELECT BACKUP OPTION (1 - 6, EMPTY LINE = NONE). : </pre>
3. :1 <input type="text" value="Enter"/>	<p>The following is displayed:</p> <pre> ----- RESTORE NAMES ----- 1. LOCAL NAMES 2. NETWORK NAMES 3. ALL NAMES SELECT NAME OPTION (1-3, EMPTY LINE = DONE) : </pre>
4. :1 <input type="text" value="Enter"/>	<p>The following is displayed:</p> <pre> ----- RESTORE OF LOCAL NAMES ----- (1 - 8 DIGITS, ALL, EMPTY LINE = DONE) : </pre>

Action

Octel Overture 200/300 Description and Response

5. :350,245

350 is the mailbox where the name was located when the name was backed up to floppy; 245 is the mailbox where the name will be restored.

```
INSERT FLOPPY, PRESS RETURN WHEN READY...
```

```
TITLE :DISK #2
```

```
RESTORING NAME FOR MAILBOX 245                ...DONE
```

```
----- RESTORE COMPLETE -----
```

Restoring Network Names

The following is an example of restoring network names.

Action	Octel Overture 200/300 Description and Response
--------	---

1. @FLOPPY

The following menu is displayed:

```

1. BACKUP
2. RESTORE
3. FLOPPY DIRECTORY

SELECT FLOPPY OPTION (1 - 3, EMPTY LINE = EXIT).
:
```

2. :2

The following menu is displayed:

```

----- RESTORE -----

1. NAMES
2. GREETINGS
3. SCRIPT AND SEQUENTIAL MESSAGES
4. PERSONAL-DISTRIBUTION-LIST NAMES
5. PROMPTS
6. ALL NAMES, GREETINGS, SCRIPT AND SEQUENTIAL MESSAGES,
   PERSONAL-DISTRIBUTION-LIST NAMES

SELECT BACKUP OPTION (1 - 6, EMPTY LINE = NONE).
:
```

3. :1

The following menu is displayed:

```

----- RESTORE NAMES -----

1. LOCAL NAMES
2. NETWORK NAMES
3. ALL NAMES

SELECT NAME OPTION (1-3, EMPTY LINE = DONE)
:
```

4. :2

The following is displayed:

```

----- RESTORE OF NETNAMES -----

ENTER LOCATION NUMBER

(1 - 16 DIGITS, ALL, EMPTY LINE = DONE)
:
```

Action

Octel Overture 200/300 Description and Response

5. :ALL

The following is displayed:

```
INSERT FLOPPY, PRESS RETURN WHEN READY

TITLE: DISK#1
RESTORING NETNAME FOR MAILBOX 7710370      ...DONE

----- RESTORE OF ALL NETWORK NAMES COMPLETE -----
----- RESTORE NAMES -----

1. LOCAL NAMES
2. NETWORK NAMES
3. ALL NAMES

SELECT NAME OPTION (1-3, EMPTY LINE = DONE)
:
```

Restoring a Single Greeting

The following is an example of restoring a single greeting.

Action

Octel Overture 200/300 Description and Response

1. @FLOPPY

The following menu is displayed:

```

1. BACKUP
2. RESTORE
3. FLOPPY DIRECTORY

SELECT FLOPPY OPTION (1 - 3, EMPTY LINE = EXIT).
:
```

2. :2

The following menu is displayed:

```

----- RESTORE -----

1. NAMES
2. GREETINGS
3. SCRIPT AND SEQUENTIAL MESSAGES
4. PERSONAL-DISTRIBUTION-LIST NAMES
5. PROMPTS
6. ALL NAMES, GREETINGS, SCRIPT AND SEQUENTIAL MESSAGES,
   PERSONAL-DISTRIBUTION-LIST NAMES

SELECT BACKUP OPTION (1 - 6, EMPTY LINE = NONE).
:
```

3. :2

The following is displayed:

```

----- GREETINGS -----

ENTER THE MAILBOX NUMBER TO RESTORE
(1-8 DIGITS, ALL, EMPTY LINE = DONE).
:
```

4. :372

The following is displayed:

```

INSERT FLOPPY, PRESS RETURN WHEN READY

Title : DISK #2
RESTORING GREETING FOR MAILBOX 372      ...DONE

----- RESTORE COMPLETE -----
```

Restoring a Greeting to a Different Mailbox

The following is an example of restoring a greeting to a different mailbox.

Action	Octel Overture 200/300 Description and Response
1. @FLOPPY <input type="text" value="Enter"/>	<p>The following menu is displayed:</p> <pre> 1. BACKUP 2. RESTORE 3. FLOPPY DIRECTORY SELECT FLOPPY OPTION (1 - 3, EMPTY LINE = EXIT). : </pre>
2. :2 <input type="text" value="Enter"/>	<p>The following menu is displayed:</p> <pre> ----- RESTORE ----- 1. NAMES 2. GREETINGS 3. SCRIPT AND SEQUENTIAL MESSAGES 4. PERSONAL-DISTRIBUTION-LIST NAMES 5. PROMPTS 6. ALL NAMES, GREETINGS, SCRIPT AND SEQUENTIAL MESSAGES, PERSONAL-DISTRIBUTION-LIST NAMES SELECT BACKUP OPTION (1 - 6, EMPTY LINE = NONE). : </pre>
3. :2 <input type="text" value="Enter"/>	<p>The following is displayed:</p> <pre> ----- GREETINGS ----- ENTER THE MAILBOX NUMBER TO RESTORE (1-8 DIGITS, ALL, EMPTY LINE = DONE). : </pre>
4. :374,245 <input type="text" value="Enter"/>	<p>374 is the mailbox where the greeting was located when the name was backed up to floppy; 245 is the mailbox where the greeting will be restored.</p> <pre> INSERT FLOPPY, PRESS RETURN WHEN READY TITLE: DISK #2 RESTORING GREETING FOR MAILBOX 245 ...DONE ----- RESTORE COMPLETE ----- </pre>

Restoring a Scripted or Sequential Mailbox

The following is an example of restoring a Scripted or Sequential mailbox.

Action	Octel Overture 200/300 Description and Response
1. @FLOPPY <input type="text" value="Enter"/>	<p>The following menu is displayed:</p> <pre> 1. BACKUP 2. RESTORE 3. FLOPPY DIRECTORY SELECT FLOPPY OPTION (1 - 3, EMPTY LINE = EXIT). : </pre>
2. :2 <input type="text" value="Enter"/>	<p>The following menu is displayed:</p> <pre> ----- RESTORE ----- 1. NAMES 2. GREETINGS 3. SCRIPT AND SEQUENTIAL MESSAGES 4. PERSONAL-DISTRIBUTION-LIST NAMES 5. PROMPTS 6. ALL NAMES, GREETINGS, SCRIPT AND SEQUENTIAL MESSAGES, PERSONAL-DISTRIBUTION-LIST NAMES SELECT BACKUP OPTION (1 - 6, EMPTY LINE = NONE). : </pre>
3. :3 <input type="text" value="Enter"/>	<p>The following is displayed:</p> <pre> ----- SCRIPTED/SEQUENTIAL MESSAGES ----- ENTER THE MAILBOX NUMBER TO RESTORE (1-8 DIGITS, ALL, EMPTY LINE = DONE). : </pre>
4. :370 <input type="text" value="Enter"/>	<p>The following is displayed:</p> <pre> INSERT FLOPPY, PRESS RETURN WHEN READY... TITLE :DISK #2 RESTORING SCRIPTED/SEQUENTIAL MESSAGE FOR MAILBOX 370 DONE RESTORING SCRIPTED/SEQUENTIAL MESSAGE FOR MAILBOX 370 DONE RESTORING SCRIPTED/SEQUENTIAL MESSAGE FOR MAILBOX 370 DONE RESTORING SCRIPTED/SEQUENTIAL MESSAGE FOR MAILBOX 370 DONE ----- RESTORE COMPLETE ----- ----- SCRIPTED/SEQUENTIAL MESSAGES ----- ENTER THE MAILBOX NUMBER TO RESTORE (1-8 DIGITS, ALL, EMPTY LINE = DONE). : </pre>

Restoring All Personal Distribution List Names

The following is an example of restoring all Personal Distribution List names.

Action	Octel Overture 200/300 Description and Response
1. @FLOPPY <input type="text" value="Enter"/>	<p>The following menu is displayed:</p> <pre> 1. BACKUP 2. RESTORE 3. FLOPPY DIRECTORY SELECT FLOPPY OPTION (1 - 3, EMPTY LINE = EXIT). : </pre>
2. :2 <input type="text" value="Enter"/>	<p>The following menu is displayed:</p> <pre> ----- RESTORE ----- 1. NAMES 2. GREETINGS 3. SCRIPT AND SEQUENTIAL MESSAGES 4. PERSONAL-DISTRIBUTION-LIST NAMES 5. PROMPTS 6. ALL NAMES, GREETINGS, SCRIPT AND SEQUENTIAL MESSAGES, PERSONAL-DISTRIBUTION-LIST NAMES SELECT BACKUP OPTION (1 - 6, EMPTY LINE = NONE). : </pre>
3. :4 <input type="text" value="Enter"/>	<p>The following is displayed:</p> <pre> ----- PERS-DIST-LIST NAMES ----- ENTER THE MAILBOX NUMBER TO RESTORE (1-8 DIGITS, ALL, EMPTY LINE = DONE). : </pre>
4. :ALL <input type="text" value="Enter"/>	<p>The following is displayed:</p> <pre> INSERT FLOPPY, PRESS RETURN WHEN READY... TITLE :DISK #1 RESTORING PERS-DIST-LIST NAMES FOR MAILBOX 420 DONE RESTORING PERS-DIST-LIST NAMES FOR MAILBOX 421 DONE RESTORING PERS-DIST-LIST NAMES FOR MAILBOX 422 DONE RESTORING PERS-DIST-LIST NAMES FOR MAILBOX 423 DONE RESTORING PERS-DIST-LIST NAMES FOR MAILBOX 424 DONE RESTORING PERS-DIST-LIST NAMES FOR MAILBOX 425 DONE ----- RESTORE COMPLETE ----- ----- PERS-DIST-LIST NAMES ----- ENTER THE MAILBOX NUMBER TO RESTORE (1-8 DIGITS, ALL, EMPTY LINE = DONE). : </pre>

Restoring Language Prompts

The following is an example of restoring language prompts.

 If Works for Serenade is being used, after a language is restored, Works for Serenade must be restarted. Refer to the Works for Serenade documentation.

Action	Octel Overture 200/300 Description and Response
1. @FLOPPY <input type="text" value="Enter"/>	<p> The ports are forwarded before this procedure starts.</p> <p>The following menu is displayed:</p>
	<pre data-bbox="657 598 1461 819"> 1. BACKUP 2. RESTORE 3. FLOPPY DIRECTORY SELECT FLOPPY OPTION (1 - 3, EMPTY LINE = EXIT). :</pre>
2. :2 <input type="text" value="Enter"/>	<p>The following menu is displayed:</p>
	<pre data-bbox="657 913 1461 1249"> ----- RESTORE ----- 1. NAMES 2. GREETINGS 3. SCRIPT AND SEQUENTIAL MESSAGES 4. PERSONAL-DISTRIBUTION-LIST NAMES 5. PROMPTS 6. ALL NAMES, GREETINGS, SCRIPT AND SEQUENTIAL MESSAGES, PERSONAL-DISTRIBUTION-LIST NAMES SELECT BACKUP OPTION (1 - 6, EMPTY LINE = NONE). :</pre>
3. :5 <input type="text" value="Enter"/>	<p>The following menu is displayed:</p>
	<pre data-bbox="657 1333 1461 1606"> ----- RESTORE PROMPTS ----- 1. RESTORE A LANGUAGE 2. ADD A LANGUAGE 3. RESTORE A PROMPT SELECT RESTORE OPTION (1 - 3, EMPTY LINE = DONE) :</pre>
4. :1 <input type="text" value="Enter"/>	<p>The language menu is displayed:</p>
	<pre data-bbox="657 1711 1461 1890"> 1. ENGLISH Version# xx 2. BRITISH Version# xx SELECT LANGUAGE (1 - 2, EMPTY LINE = DONE) :</pre>

Action**Octel Overture 200/300 Description and Response**5. :2

The following is displayed:

```
INSERT FLOPPY, PRESS RETURN WHEN READY

TITLE: DISK #1
LANGUAGE: BRITISH VERSION: 6E
ARE YOU SURE YOU WANT TO DO THIS?
```

6. :Y

The following is displayed:

```
RESTORING PROMPT 8           ...DONE
RESTORING PROMPT 9           ...DONE
RESTORING PROMPT 10          ...DONE

----- RESTORE OF PROMPTS COMPLETE -----

----- RESTORE PROMPTS -----

1. RESTORE A LANGUAGE
2. ADD A LANGUAGE
3. RESTORE A PROMPT

SELECT RESTORE OPTION (1 - 3, EMPTY LINE = DONE)
:
```

12.4 FLOPPY DIRECTORY

The FLOPPY command displays the mailbox number and type of message backed up.

Action	Octel Overture 200/300 Description and Response
--------	---

1. @FLOPPY

The following menu is displayed:

```

1. BACKUP
2. RESTORE
3. FLOPPY DIRECTORY

SELECT FLOPPY OPTION (1 - 3, EMPTY LINE = EXIT).
:
```

2. :3

The following is displayed:

```

----- FLOPPY DIRECTORY -----

INSERT FLOPPY, PRESS RETURN WHEN READY

TITLE: DISK #2
MAILBOX 370          NAME
MAILBOX 371          NAME
MAILBOX 372          NAME
MAILBOX 373          NAME
MAILBOX 374          NAME
MAILBOX 375          NAME
MAILBOX 254          GREETING
MAILBOX 371          GREETING
MAILBOX 372          GREETING (PART 1)

1. BACKUP
2. RESTORE
3. FLOPPY DIRECTORY

SELECT FLOPPY OPTION (1 - 3, EMPTY LINE = EXIT).
:
```

12.5 ERRORS

During the floppy backup and restore process, one of several errors may occur. Possible errors include attempts to

- Back up a nonexistent message or mailbox
- Restore a nonexistent message
- Restore a nonexistent mailbox

Errors can also occur if an incorrect diskette is used. Examples of the kind of error messages that may occur are shown in the screen below.

```
INSERT FLOPPY. PRESS RETURN WHEN READY.  
  
CANNOT USE CONFIGURATION FLOPPY!  
YOU MUST INSERT A DIFFERENT FLOPPY. PRESS RETURN WHEN READY.  
  
CANNOT USE SOFTWARE UPDATE FLOPPY!  
YOU MUST INSERT A DIFFERENT FLOPPY. PRESS RETURN WHEN READY.  
  
* * * DISK WRITE PROTECTED. FIX IT! * * *  
  
ERROR - COULD NOT FORMAT FLOPPY!  
PLEASE INSERT ANOTHER FLOPPY. PRESS RETURN WHEN READY.  
:
```

12.6 HARD DISK PROCEDURES

This section describes the procedures used for restoring, replacing, adding, and removing a hard disk drive, and for upgrading languages. This section also describes the hard disk drive utility programs used while performing the hard disk procedures.

Preparation

The following equipment is needed for the Hard Disk Procedures and should be assembled and verified prior to starting.

- Hard disk drive(s) to be used for replacement
 - Software diskettes for the current release
 - System prompt diskettes for the current release
-  Verify that the software diskettes and system prompt diskettes are for the same software release.
- A terminal and printer (or terminal with hardcopy capability) for communicating with the Octel Overture 200/300 and for obtaining a printed copy of all message server inputs and responses.

Procedures

The Hard Disk Procedures included in this section are

- ADD.** To add a drive to a message server. Refer to Hard Disk Add in this section.
- REMOVE.** To remove a drive from a multiple-drive message server. Refer to Hard Disk Remove in this section.
- REPLACE.** To replace a disk drive in a multiple-drive message server. Refer to Hard Disk Replace in this section.
- RESTORE.** To restore a message server to operation when system drive(s) must be replaced or the software is to be updated. Refer to Hard Disk Restore in this section.

Commands

The utility programs used while performing the hard disk procedures are

- DSKMAP
- DSKTST
- DISKO

DSKMAP

The DSKMAP utility displays the last known status of all drives as recorded by the Voice Control Unit (VCU) in the Octel Overture 200/300. DSKMAP can be run from the hard disk or from the software diskette.

Example:

```

@DSKMAP
  SLOT: 1      2      3      4      5
-----+-----
SHELF B |      |      | System 1 | System 2 |
         |      |      | ID:S1 ACTIVE | ID:S2 ACTIVE |
         |      |      |-----+-----
  SLOT: 1      2      3      4
-----+-----
SHELF C | Voice 1 | Voice 2 | Voice 3 | Voice 4 |
         | ID: V1 ACTIVE | ID: EMPTY | ID: EMPTY | ID: EMPTY |
         |-----+-----
    
```

ID is the status of a drive and can be any of the following:

Status	Explanation
ACTIVE	Drive is valid and currently operating.
VALID	Drive is approved for use, but requires rebuild to become active.
INVALID	Drive configuration is not valid.
UNKNOWN	Drive configuration is valid, but does not match the rest of the system.
ILLEGAL	Drive is not an Octel Overture 200/300 drive.
ERROR	Drive is, or is considered to be, dead.
EMPTY	Drive slot is, or appears to be, empty.

- ☞ OCC MISMATCH on the screen indicates that the Option Control Chip (OCC) data on the system disk(s) does not match the OCC data of the system EEPROM. Proper procedures should be followed. Check the Hardware Error Table to see if the OCC is faulty.
- ☞ ID MISMATCH on the screen indicates that the drive has previously been installed in a different drive slot. It must be removed and installed in the correct slot, or a Restore procedure must be performed.

DSKTST

The DSKTST utility tests the drive slot specified, updates the last known status record of the VCU, and displays the status. DSKTST can be run from the hard disk or from the software diskette.

Example:

```

@DSKTST C1
  CURRENT STATUS
Slot  Type  ID  Status
-----+-----
C1   Voice1  --  EMPTY  Not Cfgd
    
```

An explanation of the entries in the display follows.

- Slot.** Slot number for which status is given. The alphabetic character identifies the Octel Overture 200/300 shelf; the numeric character identifies the slot number.

Octel Overture 200	Octel Overture 300
System 1	System 1
System 2	System 2
Voice 1	Voice 1
	Voice 2
	Voice 3
	Voice 4

- Type.** Identifies the type and sequence of the drive slots, as one of the following:
- ID.** Identifies the type and sequence of the disk drives, as previously recorded on the drive itself. When physically installed in the correct slot, the drive appears as

Octel Overture 200	Octel Overture 300
S1	S1
S2	S2
V1	V1
	V2
	V3
	V4

- Status.** Gives the status of the drive, as one of the following:

Active	Valid
Invalid	Unknown
Illegal	Error
Empty	

Refer to the status entry explanations in the DSKMAP section of this chapter.

- Configured.** Identifies the drive as one of the following:
 - Configured — Drive is within the number of drives currently configured.
 - Not Configured — Drive is not being utilized as its position is greater than the number of drives currently configured.

DISKO

The DISKO utility, available when the Octel Overture 200/300 is booted from floppy software using the Update diskettes, prepares the message server for

- Adding a disk
- Removing a disk
- Replacing a disk

- Restoring system
- Upgrading languages
- Copying a disk (3.0)

☞ DISKO prepares the message server for software upgrades. Option 6, `UPGRADE SYSTEM`, is used only for upgrades. The instructions for upgrades are not covered in the PRM. Support Notes that accompany the upgrade diskettes detail the procedure to follow.

☞ DISKO allows drives to be copied. Option 7, `DISK COPY`, is used only when a drive is failing and needs to be replaced or to create a backup before performing an upgrade.

DISKO is accessible **only** after booting the Octel Overture 200/300 from the software diskettes. It **cannot** be run from the hard disk.

```
@disko

CURRENT STATUS
Slot  Type      ID  Status
-----
B3   System1    S1   ACTIVE  Configured
B4   System2     --   EMPTY   Not Cfgd
C1   Voice1      --   EMPTY   Not Cfgd
C2   Voice2      --   EMPTY   Not Cfgd
C3   Voice3      --   EMPTY   Not Cfgd
C4   Voice4      --   EMPTY   Not Cfgd

DISK OPTIONS
1. ADD DISK
2. REMOVE DISK
3. REPLACE A DISK
4. RESTORE SYSTEM
5. UPGRADE LANGUAGES
6. UPGRADE SYSTEM
7. DISK COPY

Select option to be performed
(1-7 - Empty line = EXIT)
:7
```

Hard Disk Add

This section provides the procedures to follow when adding a drive to a message server. Adding a drive to a message server is usually done to increase system storage or to add the optional redundancy feature.

Action	Octel Overture 200/300 Description and Response
--------	---

Prepare the System

1. Forward ports.

Boot the System

2. Make sure software diskette #1 (for the correct release level) is write-protected.
3. Insert software diskette #1 (for the correct release level) into the floppy drive.
4. Adjust the baud rate of the terminal/teleprinter to 300, 1200 or 9600 baud.
5. Press the Reload button to boot from floppy diskette.
6. When prompted, insert disk 2.

The following message is printed.

```

CPU                               Model 300-6039-001           Rev 02F
486                               Step 27                    12MB

Testing Processor...PASSED
.
.
.

----- SYSTEM SOFTWARE RELEASE S.X.X.X (XX/XX/XX) -----
Copyright(c) 199X Octel Communications Corp.
All Rights Reserved.
TUE 11/08 08:44:58 19XX ID: S/N:000000 PBX:00
(Modem enabled) Last Logon : 00/00 00:00
@WAITING FOR VCU READY
SYSTEM INITIALIZATION SUSPENDED!
PASSWORD:
@

```

At this point the Octel Overture 200/300 has completely booted from floppy diskette.

Action**Octel Overture 200/300 Description and Response**

7. Enter the password. Press To log on to system.
8. Install the disk. Refer to the Hardware Replacement chapter, Hard Disk Drive (HD) Replacement section, for procedures to follow for physical installation of a drive. Hard disks may be hot plugged.
9. @DSKTST At the @ prompt enter the slot number for the added drive. The VCU tests the slot and updates its status record.

Repeat DSKTST for each drive to be added.
10. @DSKMAP Reviews the status of all drive slots.

```

@DSKMAP
  SLOTT:  1      2      3      4      5
-----+-----
SHELF B |          |          | System 1 | System 2 |
        |          |          | ID:S1 ACTIVE | ID:S2 ACTIVE |
        |          |          |          |          |
-----+-----
  SLOTT:  1      2      3      4
-----+-----
SHELF C | Voice 1 | Voice 2 | Voice 3 | Voice 4 |
        | ID: V1 ACTIVE | ID: EMPTY | ID: EMPTY | ID: EMPTY |
        |          |          |          |          |
-----+-----

```

Choose the Correct Disk Option

11. @DISKO The following menu is presented:

```

@DISKO

CURRENT STATUS
Slot  Type ID      Status  Configured
-----
  B3   System1  S1     ACTIVE   Configured
  B4   System2  S2     ACTIVE   Configured
  C1   Voice1    V1     ACTIVE   Configured

DISK OPTIONS

1. ADD DISK
2. REMOVE DISK
3. REPLACE A DISK
4. RESTORE SYSTEM
5. UPGRADE LANGUAGES
6. UPGRADE SYSTEM

Select option to be performed
(1-5 - Empty line = EXIT)
:1

Drive in slot C1 has been removed.

```

Action	Octel Overture 200/300 Description and Response
--------	---

12. Choose option 1 —
ADD DISK .

The Octel Overture 200/300 displays the following screen. (There may be a delay before the screen appears.)



```
Selected drive in slot C1 has been added
```

Reload the System

13. Make sure the configuration backup diskette is write-enabled.
14. Insert the configuration backup diskette into the FD.
15. Press the lower button on the CPU.
16. Log on to the system using the maintenance password.
17. Verify correct system operation.

To reload the system.

Refer to the Installation chapter, Octel Overture 200/300 Testing section, in this volume.

 If adding Redundancy, refer to the Electronic Feature Delivery section of this chapter for procedures about how to add system features. Refer to the *Feature Description* volume, Hard Disk Redundancy chapter, for details about the feature.

Hard Disk Copy

This section provides the procedure to follow when copying a drive in the message server. This procedure applies when you intend to create a back up before performing an upgrade or when you intend to replace a failing drive.

Disk copy is not allowed from a COD drive to a non-COD drive. See documentation on the A>L DMAP command to understand how to determine the drive status.

The drive created in the disk copy procedure can ONLY be used in the same slot used by the source drive, and only in the same message server. Ensure that the target drive is a spare and all contents of the target drive are overwritten in the disk copy procedure.

If a non-COD drive is copied to a COD drive, COD storage equal to that used on the source drive must be enabled in order for contents of the destination drive to be accessible when the procedure is complete. The copy will work even without the authorization, but the message server will not function correctly until the necessary hours are authorized. It is advisable to ensure that authorization is complete before the procedure is started.

Action	Octel Overture 200/300 Description and Response
--------	---

Prepare the System

- | | |
|--|--|
| 1. Forward poRts. | |
| 2. Write protect the source drive. | Use the WPDISK /E <slot> command to enable write protect. The Octel Overture 200/300 will continue to run, but the write protected drive will not accept new messages. |
| 3. Enter the Voice Control Unit (VCU) | Use the @VCUCON command to access the Voice Control Unit. |
| 2. Make sure write protect is enabled on the source drive | Use the A> L DM command to verify write protection. |
| 3. Insert the destination drive into an empty drive slot. If there is no empty drive slot, remove a drive from one of the message-only slots to make room for the destination drive. | The drive is physically removed; there is no procedure required. |

Boot the System

- | | |
|---|--|
| 4. Check the status of the destination drive. | Use the A> L DM command to show the system drive status. |
| 5. Make sure the software diskette #1 (for the correct release level) is write-protected and insert that diskette into the following drive. | |

6. Adjust the baud rate of the terminal/teleprinter to 300, 1200, or 9600 baud.
7. Press the Reload button to boot from floppy disk.
8. Insert diskette #2 when prompted.
9. Press
10. Initialize slot information on destination drive.
11. Disable write protect on the source drive.

To log on to the Octel Overture 200/300.

Use the @DSKTST <shelf/slot> to initialize slot information on the destination drive. For example, @DSKTST B3. The VCU tests the slot and updates its status record.

Use the WPDISK /D <slot> command to disable write protect on the source drive.

Choose the Correct Disk Option

12. @DISKO

The following menu is presented:

```

@disko

CURRENT STATUS
Slot  Type      ID      Status
-----
B3  System1    S1      ACTIVE  Configured
B4  System2     --      EMPTY   Not Cfgd
C1  Voice1      --      EMPTY   Not Cfgd
C2  Voice2      --      EMPTY   Not Cfgd
C3  Voice3      --      EMPTY   Not Cfgd
C4  Voice4      --      EMPTY   Not Cfgd

DISK OPTIONS
1. ADD DISK
2. REMOVE DISK
3. REPLACE A DISK
4. RESTORE SYSTEM
5. UPGRADE LANGUAGES
6. UPGRADE SYSTEM
7. DISK COPY

Select option to be performed
(1-7 - Empty line = EXIT)
:7

```

13. Choose option 7 — COPY DISK

The Octel Overture 200/300 displays the following screen. (There may be a delay before the screen appears.)

```
Select source drive slot( Empty line = EXIT) :b3
Select destination drive slot( Empty line = EXIT) :b4
Disk copying will take long time.
Are you sure you want to do this? (Y/N,empty line = NO)
:y"
```

- 14. Power off the system
- 15. Remove the source drive.
- 16. Replace the source drive with the destination drive.
- 17. If a drive was removed in step 5, replace the drive in its original slot.
- 18. Log on to the system.
- 19. Verify correct system operation.

Hard Disk Remove

This section provides the procedures to follow when removing a drive from a multiple-drive message server. This procedure applies when you intend to remove a disk without immediately replacing it.

Action	Octel Overture 200/300 Description and Response
Remove the Drive(s)	
1. Forward ports.	
2. Remove the hard disk(s) from the system.	Refer to the Hardware Replacement chapter, Hard Disk Drive Replacement section, for Hard Disk Removal procedures. Hard disks may be hot plugged.

Boot the System

3. Make sure the software diskette #1 (for the correct release level) is write-protected.
4. Insert software diskette #1 (for the correct release level) into the FD.
5. Adjust the baud rate of the terminal/teleprinter to 300, 1200, or 9600 baud.
6. Press the Reload button to boot from floppy diskette.
7. Insert diskette #2 when prompted.

```

CPU                               Model 300-6004-101      Rev XX
486....                            12 MB
.....1200 BAUD MODEM.....
BOOTING FROM FLOPPY DISK
..XBOOT...

----- SYSTEM SOFTWARE RELEASE X.X.X.X (MM/DD/YY) -----
DAY MM/DD HH:MM:SS YYYY ID:000 S/N:000000 PBX:00

(MODEM ENABLED) LAST LOGON: MM/DD HH:MM
@WAITING FOR VCU READY
LOADING VCU WITH FILE F:VCU
VCU STARTED
SYSTEM INITIALIZATION SUSPENDED!
PASSWORD:
@

```

At this point the Octel Overture 200/300 has completely booted from floppy diskette.

Action Octel Overture 200/300 Description and Response

- 8. Press To log on to the Octel Overture 200/300.
- 9. @DSKTST At the @ prompt enter the slot number for the removed drive. The VCU tests the slot and updates its status record.

Repeat DSKTST for each drive removed.
- 10. @DSKMAP Views the status of all drive slots.

```

@DSKMAP
  SLOT: 1      2      3      4      5
-----+-----
SHELF B |      |      | System 1 | System 2 |
        |      |      | ID: S1  | ID: S2  |
        |      |      | ACTIVE | ACTIVE |
-----+-----
  SLOT: 1      2      3      4
-----+-----
SHELF C | Voice 1 | Voice 2 | Voice 3 | Voice 4 |
        | ID: UNKNOWN | ID: EMPTY | ID: EMPTY | ID: EMPTY |
-----+-----
    
```

Choose the Correct Disk Option

- 11. @DISKO The following menu is presented:

```

          CURRENT STATUS
Slot  Type ID      Status  Configured
-----+-----
  B3   System1  S1     ACTIVE   Configured
  B4   System2  S2     ACTIVE   Configured
  C1   Voice 1  --     ACTIVE   Configured

          DISK OPTIONS

1. ADD DISK
2. REMOVE DISK
3. REPLACE A DISK
4. RESTORE SYSTEM
5. UPGRADE LANGUAGES

Select option to be performed
(1-5 - Empty line = EXIT)
:
    
```

- 12. Choose option 2 — REMOVE DISK. After several seconds, the Octel Overture 200/300 displays

```

Remove drive in slot C1 and repeat DISKO REMOVE command.
    
```

Action**Octel Overture 200/300 Description and Response**

13. Repeat the DISKO command and again choose option 2 – REMOVE DISK.

```
@DISKO

          CURRENT STATUS
Slot  Type ID      Status  Configured
-----
   B3   System1    S1     ACTIVE   Configured
   B4   System2    S2     ACTIVE   Configured
   C1   Voice 1    --     ACTIVE   Not Configured

DISK OPTIONS

1. ADD DISK
2. REMOVE DISK
3. REPLACE A DISK
4. RESTORE SYSTEM
5. UPGRADE LANGUAGES
6. UPGRADE SYSTEM

Select option to be performed
(1-5 - Empty line = EXIT)
:2

Drive in slot C1 has been removed.
```

Reload the System

14. Make sure the configuration backup diskette is write-enabled.
15. Insert the configuration backup diskette into the FD.
16. Press the lower button on the CPU. To reload the system.
17. Log on to the system using the maintenance password.
18. Verify correct system operation. Refer to the Installation chapter, Octel Overture 200/300 Testing section, in this volume.

Hard Disk Replace

These procedures provide the steps to replace a hard disk drive on a message server configured with multiple drives.

-  When doing the Hard Disk Replace procedures, make sure that the diskettes being used are for the correct release level.

Action	Octel Overture 200/300 Description and Response
--------	---

Prepare the System

1. Forward ports.
2. Remove the hard disk(s) to be replaced. Hard disks may be hot plugged.

Boot the System

3. Make sure the software diskette #1 (for the correct release level) is write-protected.
4. Insert software diskette #1 (for the correct release level) into the FD.
5. Adjust the baud rate of the terminal/teleprinter to 300, 1200, or 9600 baud.
6. Press the Reload button to boot from floppy diskette.

Action **Octel Overture 200/300 Description and Response**

7. Insert Code Floppy #2 when prompted, press

The following message is printed.

```

CPU                      Model 300-6039-001          Rev 02F
486                      Step 27                    12MB

Testing Processor...PASSED
Testing System Voltage/Temp...PASSED
Testing ROM Checksum...PASSED
Testing PIT...PASSED
Testing DMA...PASSED
Testing UART...PASSED
Testing Modem...PASSED
Testing TDM Crosspoint...PASSED
Testing Floppy...PASSED
Testing RTC...PASSED
Testing BIC...PASSED
Testing OCC...PASSED
Testing WDT...PASSED
Testing Control Bus Interface...PASSED

Testing COMPLETED
Booting from floppy disk file XBOOT.IM
Image loaded
Loading Image from Floppy Disk
Loading file VMS1_2.IM
Please insert code floppy #2 & Press Return..
Loading file VMS2_2.IM
Image loaded

----- SYSTEM SOFTWARE RELEASE S.X.X.X (XX/XX/XX) -----
Copyright(c) 199X Octel Communications Corp.
All Rights Reserved.
TUE 11/08 08:44:58 19XX ID: S/N:000000 PBX:00
(modem enabled) Last Logon : 00/00 00:00
@WAITING FOR VCU READY
SYSTEM INITIALIZATION SUSPENDED!

```

At this point the Octel Overture 200/300 has completely booted from floppy diskette.

Install the hard disk and continue

8. Install the replacement hard disk(s).

Refer to the Hardware Replacement chapter in this volume. Hard disks may be hot plugged.

9. Press

To log on to the Octel Overture 200/300.

10. @DSKTST

At the @ prompt enter the slot number for the replaced drive. The VCU tests the slot and updates its status record.

Repeat DSKTST for each drive to be replaced.

Action

Octel Overture 200/300 Description and Response

11. @DSKMAP Reviews the status of all drive slots.

```

@DSKMAP
  SLOT: 1      2      3      4      5
-----+-----
SHELF B|      |      | System 1 | System 2 |
      |      |      | ID:S1 ACTIVE | ID: UNKNOWN |
-----+-----
  SLOT: 1      2      3      4
-----+-----
SHELF C| Voice 1 | Voice 2 | Voice 3 | Voice 4 |
      | ID: EMPTY | ID: EMPTY | ID: EMPTY | ID: EMPTY |
-----+-----
    
```

Choose the Correct Disk Option

12. @DISKO The following menu is presented:

```

          CURRENT STATUS
Slot  Type  ID  Status  Configured
-----+-----
B3   System1  S1  ACTIVE  Configured
B4   System2  --  UNKNOWN  Configured
C1   Voice1   --  EMPTY   Not Configured
C2   Voice2   --  EMPTY   Not Configured
C3   Voice3   --  EMPTY   Not Configured
C4   Voice4   --  EMPTY   Not Configured

DISK OPTIONS

1. ADD DISK
2. REMOVE DISK
3. REPLACE A DISK
4. RESTORE SYSTEM
5. UPGRADE LANGUAGES
6. UPGRADE SYSTEM

Select option to be performed
(1-5 - Empty line = EXIT)
:
    
```

13. 3 - REPLACE A DISK. The following is presented:

```

:3
Select drive slot to be replaced: (Empty line = EXIT)
:
    
```

Action	Octel Overture 200/300 Description and Response
--------	---

14. Enter the number of the drive slot to be replaced.

The Octel Overture 200/300 displays the following screen. (There may be a delay before the screen appears.)



```
:B4
Selected drive has been replaced.
```

Reload the System

15. Make sure the configuration backup diskette is write-enabled.

16. Insert the configuration backup diskette into the floppy drive.

17. Press the lower button on the CPU.

To reload the system.

18. Press

To display the boot process.

19. Log on to the system using the maintenance password.

20. Verify correct system operation.

Refer to Installation, Octel Overture 200/300 Testing section, in this volume.

21. @L H

To list the Hardware Error Table.

If errors appear, refer to the System Errors And Traffic Peg chapter.

Hard Disk Restore

These procedures provide the steps to restore a message server where the

- Octel Overture 200/300 is configured as a one-disk system and the hard disk needs replacement.
- Octel Overture 200/300 is configured as a multiple-disk system and both of the system disks need replacement.

 When doing the Hard Disk Restore procedures, make sure that the diskettes being used are for the correct release level.

Action	Octel Overture 200/300 Description and Response
Preparation	Back up greetings, names, scripted and sequential messages, and Personal Distribution List names. Refer to the Backup and Restore of Greetings, Names, Scripted and Sequential Messages, Personal Distribution List Names, and Prompts section in this chapter.

Replace the Hard Disk

1. Forward ports.
2. Remove the hard disk(s) to be replaced. Hard disks may be hot plugged.
3. Install the replacement hard disk(s). Refer to the Hardware Replacement chapter, Hard Disk Drive Replacement section, for Hard Disk Replacement procedures. Hard disks may be hot plugged.

Two floppy diskettes are required to boot the Octel Overture 200/300.

4. Make sure software diskettes #1 and #2 (for the correct release level) are write-protected.
5. Insert software diskette #1 into the Floppy Drive (FD).

Action**Octel Overture 200/300 Description and Response**

6. Press the Reload button to boot from floppy diskette. When prompted, insert software diskette #2 into the FD.

The following messages are printed:

```

CPU                               Model 300-6039-001           Rev 02F
486                               Step 27                    12MB

Testing Processor...PASSED
Testing System Voltage/Temp...PASSED
Testing ROM Checksum...PASSED
Testing PIT...PASSED
Testing DMA...PASSED
Testing UART...PASSED
Testing Modem...PASSED
Testing TDM Crosspoint...PASSED
Testing Floppy...PASSED
Testing RTC...PASSED
Testing BIC...PASSED
Testing OCC...PASSED
Testing WDT...PASSED
Testing Control Bus Interface...PASSED

Testing COMPLETED
Booting from floppy disk file XBOOT.IM
Image loaded
Loading Image from Floppy Disk
Loading file VMS1_2.IM
Please insert code floppy #2 & Press Return..
Loading file VMS2_2.IM
Image loaded

----- SYSTEM SOFTWARE RELEASE S.X.X.X (xx/xx/xx) -----
Copyright(c) 19xx Octel Communications Corp. All Rights Reserved.
TUE 11/08 08:44:58 19xx ID: S/N:000000 PBX:00
(Modem enabled) Last Logon : 00/00 00:00
@WAITING FOR VCU READY
LOADING VCU WITH FILE F:VCU.IM
VCU STARTED
SYSTEM INITIALIZATION SUSPENDED!
PASSWORD:
@

```

When the prompt SYSTEM INITIALIZATION SUSPENDED! appears, the Octel Overture 200/300 has completely booted from floppy.

7. Press twice.

The Octel Overture 200/300 requests a password.

 If the above messages does not appear, press the reload button and reboot from floppy.

8. Enter the maintenance password.
9. Remove the software diskette from the FD.

To log on to the Octel Overture 200/300.

Action**Octel Overture 200/300 Description and Response****Test Diskettes**

Each diskette (software diskette for the correct release level, prompt diskette, and the backup configuration diskette) must be tested before completing the remainder of this procedure.

10. Insert a diskette into the floppy drive.

11. @TE F 1

Octel Overture 200/300 prompts

```
TEST 01 COMPLETE
```

If any diskette fails the test, a replacement must be obtained before continuing with this procedure. Refer to the Maintenance Commands chapter, Floppy Disk Drive Diagnostics section, for a description of this diagnostic error.

12. Repeat steps 10 and 11 for each diskette.

Choose the Correct Disk Option

13. Insert Diskette #3 (for the correct release level) into the FD.

14. @DSKTST

At the @ prompt enter the slot number for the restored drive. The VCU tests the slot and updates its status record.

Repeat DSKTST for each drive to be restored.

```
@DSKTST B3
CURRENT STATUS
Slot  Type      ID      Status
-----
B3   System1    S1     Active   Configured
```

15. @DISKO

The following menu is presented:

CURRENT STATUS

Slot	Type	ID	Status	
B3	System1	S1	UNKNOWN	Configured
B4	System2	S2	UNKNOWN	Configured
C1	Voice1	--	EMPTY	Not Cfgd
C2	Voice2	--	EMPTY	Not Cfgd
C3	Voice3	--	EMPTY	Not Cfgd
C4	Voice4	--	EMPTY	Not Cfgd

DISK OPTIONS

1. ADD DISK
2. REMOVE DISK
3. REPLACE A DISK
4. RESTORE SYSTEM
5. UPGRADE LANGUAGES
6. UPGRADE SYSTEM
7. DISK COPY

Select option to be performed
(1-7 - Empty line = EXIT)

.

Action	Octel Overture 200/300 Description and Response
--------	---

16. 4 – RESTORE SYSTEM.

The following is then presented:

```
:4
Enter number of drives
(1 - 6, Empty line = EXIT)
```

17. Enter the number of drives in your system.

The Octel Overture 200/300 displays

```
:
Purchased Quantity of Languages: 2
Current Allocated Quantity: 0
Enter quantity of languages desired (1-4, Empty Line = 1):
```

18. Enter the quantity of languages desired.

The Octel Overture 200/300 displays

```
Allocation quantity selected = 1
ARE YOU SURE? (Y/N, empty line = N): Y
```

19. Enter Y.

If all the information is correct, answer Y to this question. The Octel Overture 200/300 displays

```
Proceeding with Restore. . .
DONE
@
```

Create the Directory

20. @SUBMIT F:CREDIR

For the Octel Overture 200/300, this step reformats the hard disk file system partition and creates and initializes the filesystem directory structure.

```
Filename: @ (#) credir 5.8
Date: MM/DD/YY

F:CREDIR reformats the hard disk filesystem partition and
creates and initializes the filesystem directory structure

NOTE: AFTER BEGINNING THIS STEP, THE CURRENT FILESYSTEM IS

----- COMPLETELY IRRETRIEVABLE -----

BE VERY CERTAIN YOU ARE READY TO PROCEED!!
MAKE SURE NO ERRORS HAVE OCCURRED DURING
PREVIOUS STEPS!!
```

21. Press

To continue the procedure.

```

---- Press Return to continue ----
FKOUT 05 81 09
SETVAR DIRWRCHK 0
variable = DIRWRCHK, address = 0x2ax7f5, old value = 1,
new value = 0
Are you sure you want to change the value?

```

22. Enter Y

To change the value. The Octel Overture 200/300 displays

```

HFORM
HFORM deletes all data on the hard disk file system.
Are you sure you want to do this?

```

23. :Y

To confirm your selection. When initialization is complete, the Octel Overture 200/300 prompts

```

HFORM completed successfully. Disk removed
CRE H:XBOOT.IM 88
.
.
.
Configuration files will be created or re-sized as needed.
Are you sure you want to do this?

```

24. :Y

To confirm your selection and create the configuration files.
If no errors were detected, continue with the next step.

 F:MFGINIT allows F:LOADCODE to be run without doing F:RESTORE for those occasions with there is not Release 7 configuration to restore (for example a new system).

25. @SUBMIT F:MFGINIT

Restore System Software

26. @SUBMIT F:LOADCODE

Copies software from the floppy diskettes to the hard disk. This step loads the operating code into the files just created. You are prompted when to insert each diskette.

When the operating code is successfully copied, the Octel Overture 200/300 prompts

27. Insert the Models Diskette
Enter

The Octel Overture 200/300 displays

```

PLEASE INSERT THE MODELS DISKETTE
*****
---- Press Return to continue ----
DCOPY F:MODELS H:MODELS
DCOPY F:MODDAT H:MODDAT

```

```
OPTION CONTROL CHIP UPDATED  
RECOMBINE SUCCESSFUL!  
*****  
F:loadcode IS NOW COMPLETE
```

- ☞ The system attempts to access system drives 1 and 2. The following message appears if the system is configured for only system drive 1. This message is correct only if system drive 2 is **not** configured.

```
VCU XBOOT device invalid or not present; operation  
skipped.
```

28. Press twice.

Action	Octel Overture 200/300 Description and Response
Restore System Voice Prompts	Copies the system prompts to hard disk.
29. Make sure you have a complete set of prompt diskettes (for the correct release level).	The number of prompt diskettes may vary by language.
30. Check to make sure that the revision level of the prompt diskettes is the correct revision level for the Octel Overture 200/300 software release being restored.	
31. @FLOPPY <input type="text" value="Enter"/>	The following is displayed:
	<pre> ----- FLOPPY BACKUP RESTORE ----- ----- MAIN MENU ----- @FLOP 1. BACKUP. 2. RESTORE. 3 FLOPPY DIRECTORY. SELECT FLOPPY OPTION (1-3, EMPTY LINE = EXIT). : </pre>
: 2 <input type="text" value="Enter"/>	The following is displayed:
	<pre> :2 ----- RESTORE ----- 1. NAMES 2. GREETINGS 3. SCRIPT AND SEQUENTIAL MESSAGES 4. PERSONAL-DISTRIBUTION-LIST NAMES 5. PROMPTS 6. ALL NAMES, GREETINGS, SCRIPT AND SEQUENTIAL MESSAGES, PERSONAL-DISTRIBUTION-LIST NAMES SELECT RESTORE OPTION (1- 6, EMPTY LINE = DONE) : </pre>
: 5 <input type="text" value="Enter"/>	The following is displayed:

----- RESTORE PROMPTS -----

1. RESTORE A LANGUAGE
2. ADD A LANGUAGE
3. RESTORE A PROMPT

SELECT RESTORE OPTION (1 - 3, EMPTY LINE = DONE)
:

Action

Octel Overture 200/300 Description and Response

 **For Hard Disk Restore**, the option **Restore a Language cannot be used**. Use the option **Add a Language**.

: 2

Insert the Prompt Diskettes as prompted. The following is displayed:

```

INSERT FLOPPY, PRESS RETURN WHEN READY

LANGUAGE: ENGLISH      VERSION: xx
ARE YOU SURE YOU WANT TO DO THIS? Y
RESTORING PROMPT 8      ...DONE
RESTORING PROMPT 9      ...DONE
.
.
.
RESTORING PROMPT 510    ...DONE
RESTORING PROMPT 511    ...DONE

INSERT NEXT FLOPPY TO CONTINUE, PRESS RETURN WHEN READY

RESTORING PROMPT 811    ...DONE
RESTORING PROMPT 812    ...DONE
.
.
.
RESTORING PROMPT 1050   ...DONE
RESTORING PROMPT 1051   ...DONE

----- RESTORE COMPLETE -----

----- RESTORE -----

1. NAMES
2. GREETINGS
3. SCRIPT AND SEQUENTIAL MESSAGES
4. PERSONAL-DISTRIBUTION-LIST NAMES
5. PROMPTS
6. ALL NAMES, GREETINGS, SCRIPT AND SEQUENTIAL
   MESSAGES, PERSONAL-DISTRIBUTION-LIST NAMES

SELECT RESTORE OPTION (1- 6, EMPTY LINE = DONE)
:
```

32. Press Enter twice

To return to the @ prompt.

 If more than one language was allocated, add additional language now.

33. Remove the last prompt diskette from the FD.

The number of prompt diskettes may vary by language.

Reload the System

34. Press the lower button on the CPU.

To reload the system. Monitor the boot process until the SYSTEM INITIALIZATION SUSPENDED! prompt appears. Press Enter until you reach the password prompt.

You may see a message similar to the following message appears. Proceed to step 35.

```
VCU STARTED  
NO SLOT CONFIGURED IN THE SYSTEM. INSTALL PROCEDURES MUST  
BE RUN. SYSTEM INITIALIZATION SUSPENDED.
```

35. Press
Enter password.

To log on to the Octel Overture 200/300.

Reinstall the Configuration

36. After the Octel Overture 200/300 has booted from the hard disk, insert the configuration backup diskette into the FD.

37. @INSTA

The Octel Overture 200/300 responds with the following:

```

- - - - - SYSTEM INSTALLATION DIALOG - - - - -
DAY MM/DD HH:MM:SS YYYY ID:000 SN:000000 PBX:00

NEW CONFIGURATION INSTALLATION.

CLEARING ALL TABLES. . . DONE.
INITIALIZING ALL USER DIRECTORIES . . .
NOTE: Message Waiting setup 8:00 AM to 18:00 PM because
defaults were 0.
DONE.

```

The Octel Overture 200/300 then gives the following messages to indicate the status of the reinstall. Answer the questions. Refer to *Configuration* volume, INSTALL chapter.

```

Do you wish to PRE-LOAD any table from a previous INSTALL
from your DISKETTE? ( Y/N, empty line = N )

:Y

Insert desired DISKETTE in drive. Press RETURN when ready...

PRE-LOAD ALL configuration tables?
:Y

```

Next, the Octel Overture 200/300 prompts you to insert the diskette.

When the pre-load is complete, the following message is printed:

```

TABLE PRE-LOAD COMPLETE
Do you wish to set the system DATE and TIME? (Y/N, empty line = N)

```

Action**Octel Overture 200/300 Description and Response**

A series of messages is printed to indicate which tables have been pre-loaded. On completion, the following messages are printed:

```
INSTALL COMPLETE.

WAIT...
DONE.

SAVE configuration to a diskette? (Y/N, empty line = N).
:
```

If you are reloading from diskette, the information does not need to be resaved, press . When complete, the system header and the following message are printed:

```
DAY MM/DD HH:MM:SS YYYY (SYSTEM NAME) ID:000 S/N:000000
PBX:00

- - - - - SYSTEM INSTALLATION COMPLETED - - - - -
```

Reload the System

38. Press the lower button on the CPU.

To reload the system. Monitor the boot process until the SYSTEM INITIALIZATION SUSPENDED! prompt appears. Press Enter until you reach the password prompt.

39. Log on to the Octel Overture 200/300 using the maintenance password.

40. Restore, if backup is available, or record greetings, names and prompts.

41. Verify correct system operation.

Place test calls to all ports and check for normal operation. Refer to the Installation chapter, Octel Overture 200/300 Testing section, in this volume.

12.7 ADDING LANGUAGES

When more than one language is used, disk space must be allocated and prompts must be installed for each additional language added. This section describes the procedures to upgrade the disk space and to add language prompts using floppy diskettes. If you plan to add languages over the LAN, refer to the *Feature Description* volume, LAN Backup and Restore chapter.

- ☞ Disk space can be allocated and languages added before Order Administration increases the number of purchased languages. Languages installed, but not purchased, cannot be used. The first language installed (Language 1) is the only language used if additional languages have been added, but not purchased.

Upgrade Languages

This section provides the procedures to follow to prepare the system disk(s) for more than one language. Up to a maximum of four languages can be installed.

-  Disk space for the additional prompts can be allocated and languages added before they have been purchased. Order Administration can increase the number of languages installed on the message server to a maximum of four.

When the DISKO option, Upgrade Language is entered, the message server prompts to enter the quantity of languages desired. The amount of reallocated disk space is determined by the number of languages entered. The upgrade can take several hours.



When Upgrade Language is performed, the voice storage capacity on each system drive is decreased by approximately one hour per language installed. Each system drive must have at least one hour of voice storage for each language installed, as prompts are stored redundantly.

Action

Octel Overture 200/300 Description and Response

Prepare the System

1. Forward ports.

Boot the System

2. Make sure software diskette #1 (for the correct release level) is write-protected.
3. Insert software diskette #1 (for the correct release level) into the FD.
4. Adjust the baud rate of the terminal/teleprinter to 300, 1200 or 9600 baud.

Action **Octel Overture 200/300 Description and Response**

5. Press the Reload button to boot from floppy diskette. The following messages are printed:

```

CPU                               Model 300-6039-001           Rev 02F
486                               Step 27                   12MB

Testing Processor...PASSED
.
.
.

----- SYSTEM SOFTWARE RELEASE S.X.X.X (XX/XX/XX) -----
Copyright(c) 199X Octel Communications Corp.
All Rights Reserved.
TUE 11/08 08:44:58 19XX ID: S/N:000000 PBX:00
(Modem enabled) Last Logon : 00/00 00:00
@WAITING FOR VCU READY
LOADING VCU WITH FILE F:VCU
VCU STARTED
SYSTEM INITIALIZATION SUSPENDED!
PASSWORD:
@

```

At this point the Octel Overture 200/300 has completely booted from floppy diskette.

6. Press . To log on to system.
7. @DSKMAP Reviews the status of all drive slots.

```

@DSKMAP
  SLOT: 1           2           3           4           5
-----+-----+-----+-----+-----+
SHELF B |           |           | System 1 | System 2 |           |
         |           |           | ID:S1 ACTIVE | ID:S2 ACTIVE |           |
-----+-----+-----+-----+-----+
  SLOT: 1           2           3           4
-----+-----+-----+-----+
SHELF C | Voice 1 | Voice 2 | Voice 3 | Voice 4 |
         | ID: V1 ACTIVE | ID: EMPTY | ID: EMPTY | ID: EMPTY |
-----+-----+-----+-----+

```

Choose the Correct Disk Option

Action

Octel Overture 200/300 Description and Response

8. @DISKO

The following menu is presented:

```

CURRENT STATUS
Slot      Type      ID      Status      Configured
-----
  B3      System1   S1      ACTIVE      Configured
  B4      System2   S2      ACTIVE      Configured
  C1      Voice1    V1      ACTIVE      Configured
  C2      Voice2    --      EMPTY      Not Configured
  C3      Voice3    --      EMPTY      Not Configured
  C4      Voice4    --      EMPTY      Not Configured

DISK OPTIONS

1. ADD DISK
2. REMOVE DISK
3. REPLACE A DISK
4. RESTORE SYSTEM
5. UPGRADE LANGUAGES
6. UPGRADE SYSTEM

Select option to be performed
(1-6 - Empty line = EXIT)
:
```

9. Choose option 5 —
UPGRADE LANGUAGES

After several seconds, the Octel Overture 200/300 displays

```

:5
Current Languages Loaded:      1
                             1=ENGLISH      VERSION xx

Purchased Quantity of Languages:  2
Current Allocated Quantity:      1

Enter Quantity of languages desired (1 - 4, Empty Line =
2):2
Allocation Quantity selected = 2
ARE YOU SURE? (Y/N, EMPTY LINE = N):Y
Proceeding with Re-allocation.....

Re-Allocation is complete.
@
```

 If the number of languages installed exceeds the number purchased, the system prompts with the message LANGUAGE QTY EXCEEDS OCC MAX before proceeding with the re-allocation. Before these languages can be used, Order Administration must configure the OCC for more languages.

Action	Octel Overture 200/300 Description and Response
Reload the System	
10. Make sure the configuration backup diskette is write-enabled.	
11. Insert the configuration backup diskette into the FD.	
12. Press the lower button on the CPU.	To reload the system.
13. Log on to the system using the old maintenance password.	
14. Verify correct system operation.	Refer to the Installation chapter, Octel Overture 200/300 System Testing section, in this volume.

After the disk has been reallocated for more languages, follow the steps for Adding Language Prompts to add the required language(s).

Adding Language Prompts

The following are the steps to add a language to the Octel Overture 200/300.

- ☞ Before adding a second set of language prompts, verify that the Disk Option procedure to Upgrade Languages has been performed. Disk space must be reallocated before additional languages are added.
- ☞ To restore a language, refer to the Restoring Language Prompts section in this chapter.

Action	Octel Overture 200/300 Description and Response
--------	---

☞ The ports are forwarded before this procedure starts.

1. @FLOPPY

The following menu is displayed:

```

1. BACKUP
2. RESTORE
3. FLOPPY DIRECTORY

SELECT FLOPPY OPTION (1 - 3, EMPTY LINE = EXIT).
:
```

2. :2

The following menu is displayed:

```

----- RESTORE -----

1. NAMES
2. GREETINGS
3. SCRIPT AND SEQUENTIAL MESSAGES
4. PERSONAL-DISTRIBUTION-LIST NAMES
5. PROMPTS
6. ALL NAMES, GREETINGS, SCRIPT AND SEQUENTIAL
   MESSAGES, PERSONAL-DISTRIBUTION-LIST NAMES

SELECT RESTORE OPTION (1 - 6, EMPTY LINE = DONE).
:
```

3. :5

The following menu is displayed:

```

SELECT RESTORE OPTION (1 - 3, EMPTY LINE = DONE)
:
----- RESTORE PROMPTS -----

1. RESTORE A LANGUAGE
2. ADD A LANGUAGE
3. RESTORE A PROMPT
```

Action**Octel Overture 200/300 Description and Response**4. :2

The following is displayed:

```

INSERT FLOPPY, PRESS RETURN WHEN READY

FLOPPY LANGUAGE: ENGLISH  VERSION xx

ADDING PROMPTS FOR LANGUAGE ENGLISH VERSION xx

RESTORING          PROMPT 234
RESTORING          PROMPT 235

INSERT NEXT FLOPPY, PRESS RETURN WHEN READY

RESTORING          PROMPT 334
RESTORING          PROMPT 335

----- RESTORE OF PROMPTS COMPLETE -----

----- RESTORE PROMPTS -----

1.  RESTORE A LANGUAGE
2.  ADD A LANGUAGE
3.  RESTORE A PROMPT

SELECT RESTORE OPTION (1 - 3, EMPTY LINE = DONE)
:
```

The number of languages that can be added is equal to the number of languages previously allocated during DISKO. Repeat steps 1 through 4 for each language that is added.

 When language prompts are added, Works for Serenade must be restarted. Refer to the Works for Serenade documentation.

Symbols

- . (dot) UPDATE prompt, *IV*: 4-35
- , (colon) INSTALL prompt, *IV*: 4-35
- @ (at sign) Operating system prompt, *IV*: 4-35
- + (plus) auto-increment input aid, *IV*: 1-6

Numbers

- 25-pair cable, *IV*: 3-2, 4-14
 - connecting, *IV*: 4-45
- 32-pin telco connector, *IV*: 2-2
- 50-pin telco connector, *IV*: 2-2

A

- Adaptive Integration, *V*: 1-1, 2-1 to 2-11
 - Called Party Identification, *V*: 2-1
 - CPI call records, *V*: 2-1
 - enhanced DTMF in-band integration, *V*: 2-3
 - mailbox features available, *V*: 2-11
 - MD110, *V*: 14-1
 - Message Waiting Indication, *V*: 2-1
 - Northern Telecom/NPIC, *V*: 13-1
 - Overture 200/300 proprietary card integrations, *V*: 2-5
 - Overture 200/300 responses to calls
 - called party identification, *V*: 2-10
 - called party status, *V*: 2-9
 - multicabinet call answering, *V*: 2-10
 - multicabinet messaging, *V*: 2-10
 - RS-232C data link integrations, *V*: 2-4
 - types of, *V*: 2-3 to 2-8
- ADD command
 - LOCATION Table
 - collocated analog networking, *VI*: 5-30
 - digital networking, *VI*: 5-20
 - remote analog networking, *VI*: 5-13
 - NUMBERING PLAN Table
 - collocated analog networking, *VI*: 6-14
 - digital networking, *VI*: 6-10
 - remote analog networking, *VI*: 6-6
 - ROUTE Table
 - collocated analog networking, *VI*: 7-6
 - remote analog networking, *VI*: 7-4
- Adding features. *See Electronic feature delivery/removal*
- Addressing messages, overlapping mailbox addresses and network prefixes, *VI*: 2.1-7
- Administrative password, *IV*: 6-13
- AI. *See Adaptive Integration*
- Air exhaust, *IV*: 2-3, 2-9

- Air filter, *IV*: 2-3, 2-9
 - replacement, *IV*: 9-35 to 9-36
- Air intake, *IV*: 2-9
- Alarm
 - diagnostic, test, *IV*: 6-37
 - relays, *IV*: 8-5
- Alarm relays, *IV*: 2-1
- Alphabetic name
 - digital networking, *VI*: 3-18
 - OctelNet, *VI*: 2.1-21
- AMIS analog networking
 - See also Protocol 4; Remote analog networking, AMIS; Remote analog networking, Protocol 5*
 - self system number, *VI*: 2.1-52
 - system number, *VI*: 2.1-52
 - use pub/pvt number, *VI*: 2.1-52
- Analog networking
 - multiple network outcalls, *VI*: 2-2
 - overview, *VI*: 2-1 to 2-5
 - AMIS, *VI*: 2-1
 - collocated, *VI*: 2-1
 - gateway, *VI*: 2-2
 - OctelNet, *VI*: 2-1
 - Voicenet, *VI*: 2-1
 - protocols, *VI*: 2-3 to 2-5
- Analog standby for LAN message delivery, digital networking, *VI*: 3-19 to 3-20
- Announce calls to intercept index, INSTALL program, *IV*: 1-22
- Answering modes, *IV*: 3-2
- APIC. *See Serial Integration Card*
- Application Delays, *IV*: 6-43 to 6-60
 - how to modify, *IV*: 6-45, 6-54
 - how tones are recognized, *IV*: 6-43
 - modifiable indexes, *IV*: 6-47 to 6-54
- APURGE command, *IV*: 6-9
- ASCII name. *See Alphabetic name*
- AT&T Definity Adaptive Integration
 - configuration requirements, *V*: 7.1-7
 - maintenance commands, *V*: 7.1-47 to 7.1-56
- AT&T Definity G3 Adaptive Integration, *V*: 7.1-1
- ATTIC board installation, *V*: 7.1-38
- Definity G3 configuration
 - COR, *V*: 7.1-9
 - coverage paths, *V*: 7.1-20
 - hunt group, *V*: 7.1-19
 - naming conventions, *V*: 7.1-8
 - port extensions, *V*: 7.1-17
 - station extensions, *V*: 7.1-23
 - trunk groups, *V*: 7.1-22
- hardware requirements, *V*: 7.1-7
- installation, *V*: 7.1-29 to 7.1-56
- installation checklist, *V*: 7.1-51 to 7.1-56

- AT&T Definity G3 Adaptive Integration
(continued)
- Overture 200/300 configuration, V: 7.1-25 to 7.1-56
 - Called Party Identification, V: 7.1-26
 - Overture 200/300 configuration, Message Waiting Indication, V: 7.1-25
 - software requirements, V: 7.1-7
 - testing, V: 7.1-29 to 7.1-56
 - testing procedure, V: 7.1-32 to 7.1-38
- AT&T Definity G3 Adaptive Integration with APIC, configuration, hunt group, V: 12.1-15
- AT&T Definity G3 Conventions, V: 7.1-8
- AT&T Integration Card, IV: 2-20
- AT&T System 75 Adaptive Integration, V: 7.2-1 to 7.2-56
- ATTIC board installation, V: 7.2-39
 - configuration requirements, V: 7.2-7
 - hardware requirements, V: 7.2-7
 - installation, V: 7.2-29 to 7.2-56
 - installation checklist, V: 7.2-51 to 7.2-56
 - maintenance commands, V: 7.2-47 to 7.2-56
 - Overture 200/300 configuration, V: 7.2-25 to 7.2-56
 - Called Party Identification, V: 7.2-26
 - Message Waiting Indication, V: 7.2-25
 - software requirements, V: 7.2-7
- System 75 configuration
- COR, V: 7.2-9
 - coverage paths, V: 7.2-20
 - hunt group, V: 7.2-18
 - naming conventions, V: 7.2-8
 - port extensions, V: 7.2-17
 - station extensions, V: 7.2-23
 - trunk groups, V: 7.2-21
 - testing procedure, V: 7.2-32 to 7.2-38
- AT&T System 85 Adaptive Integration with APIC
- configuring System 85, V: 12.3-8
 - testing, V: 12.3-21 to 12.3-34
- AT&T System 85 Adaptive Configuration with APIC, APIC configuration changes, V: 12.3-10
- AT&T System 85 Adaptive Integration, V: 7.3-1 to 7.3-49
- ATTIC board installation, V: 7.3-34
 - call coverage
 - call coverage groups, V: 7.3-2
 - calls forwarding all calls, V: 7.3-2
 - Called Party Identification
 - direct calls from external trunks, V: 7.3-3
 - direct internal calls, V: 7.3-4
 - forwarded external calls, V: 7.3-4
 - forwarded internal calls, V: 7.3-5
 - configuration requirements, V: 7.3-6
 - hardware requirements, V: 7.3-6
 - installation, V: 7.3-25 to 7.3-41
 - installation checklist, V: 7.3-45 to 7.3-49
 - maintenance commands, V: 7.3-42 to 7.3-44
 - Overture 200/300 configuration, V: 7.3-21 to 7.3-24
 - Called Party Identification, V: 7.3-22
 - Message Waiting Indication, V: 7.3-21
 - software requirements, V: 7.3-6
- System 85 configuration
- ATTIC link digital phone and Overture 200/300 port extensions, V: 7.3-9
 - call coverage, V: 7.3-19
 - Centralized System Management, V: 7.3B-1 to 7.3B-32, 12.3B-1 to 12.3B-14
 - naming conventions, V: 7.3-8
 - station extensions, V: 7.3-20
 - System Management Terminal, V: 7.3A-1 to 7.3A-11, 12.3A-1 to 12.3A-7
 - trunk groups, V: 7.3-19
 - testing, V: 7.3-25 to 7.3-41
 - testing procedure, V: 7.3-28 to 7.3-34
- AT&T System 85 Adaptive Integration with APIC, V: 12.3-1
- APIC board installation, V: 12.3-27
- configuration
- call coverage, V: 12.3-13
 - hunt group, V: 12.3-12
 - station extensions, V: 12.3-14
 - trunk groups, V: 12.3-14
- configuration requirements, V: 12.3-7
- configuring, naming conventions, V: 12.3-8
- hardware requirements, V: 12.3-7
- installation, V: 12.3-21 to 12.3-34
- Overture 200/300 configuration, V: 12.3-15 to 12.3-34
- software requirements, V: 12.3-7
- ATTIC. *See AT&T Integration Card*
- Auto transfer, to assistance index, INSTALL program, IV: 1-22
- Automatic purge, Network Name Confirmation, VI: 4-1
- Automatic terminal logout, IV: 4-36
- AX mode
- See also Primary Answering*
 - port, IV: 3-3

B

- Backup
- all messages, IV: 12-4
 - all names, IV: 12-6
 - greetings by COS, IV: 12-12
 - language prompts, IV: 12-20
 - local names, IV: 12-8
 - network names, IV: 12-10
 - personal distribution list names, IV: 12-18

Backup (continued)
 scripted or sequential mailbox, *IV*: 12-16
 single greeting, *IV*: 12-14
 Backup procedures, *IV*: 12-3 to 12-21
 Basic MIB, digital networking, SNMP, *IV*: 11B-2
 Baud rate
 command, *IV*: 6-9
 external modem, *IV*: 4-17
 internal modem, *IV*: 4-19, 4-20
 auto adjust, *IV*: 4-19, 4-20
 Beep, diagnostic test, *IV*: 6-32
 BITTST command, *IV*: 6-9
 Block Messages, *IV*: 6-56 to 6-60
 Boot ROM diagnostic errors, *IV*: 8-1 to 8-3
 Buscom call diverter, *IV*: 3-15
 Busy
 extension, *IV*: 3-2
 extension test, *IV*: 4-52

C

Cabinet
 inside front view, *IV*: 9-4, 9-9
 inside rear view, *IV*: 9-6, 9-11
 inspecting, *IV*: 4-1
 rear view, *IV*: 9-10
 unpacking, *IV*: 4-1
 weight, *IV*: 4-1
 Cabinet specifications
 clearances, *IV*: 2-2, 2-8
 depth, *IV*: 2-2, 2-8
 height, *IV*: 2-2, 2-8
 weight, *IV*: 2-2, 2-8
 width, *IV*: 2-2, 2-8
 Cabinet weight, *IV*: 4-1
 Cable, length, *IV*: 4-46
 Call Detail Record, *IV*: 7-22
 commands, *IV*: 7-25
 configuring log, *IV*: 7-26
 display filters, *IV*: 7-25, 7-33
 display specifications, *IV*: 7-32
 displaying, *IV*: 7-28, 7-29
 examples, *IV*: 7-37
 LOG command, *IV*: 7-1
 Namesend activity trace log, *IV*: 7-40
 setting display specifications, *IV*: 7-30
 Status types, *IV*: 7-24
 transaction types, *IV*: 7-22
 Call diverter, *IV*: 3-15
 Call Process Trace Log
 AUX, *IV*: 7A-1
 Event, *IV*: 7A-1
 Call processing
 flow, networking, *VI*: 2.1-26
 MD110, *V*: 14-3
 Call processing protocols, analog networking,
VI: 2-3, 2.1-3
 Call Processing Trace, digital networking, *VI*: 3-53
 Call processing trace, *IV*: 7-5 to 7-21
 description of screen, *IV*: 7-6
 integration activity, *IV*: 7-15
 listing, *IV*: 6-3
 LOG command, *IV*: 7-1
 message activity, *IV*: 7-15
 network location activity, *IV*: 7-15
 printing the CPT log, *IV*: 7-6
 types of trace activities, *IV*: 7-6
 Call Queuing
 INSTALL program, *IV*: 1-22
 message mailbox index, INSTALL program,
IV: 1-22
 Call records, MD110, *V*: 14-3
 Called Party Identification, *V*: 1-1, 1-2
 Adaptive Integration, *V*: 2-1
 CPI call records, *V*: 2-1
 ITT 3100 Adaptive Integration, *V*: 9-1
 Mitel SX-2000 Adaptive Integration, *V*: 10.3-1
 NEAX-2400 Adaptive Integration, *V*: 5-2
 Northern Telecom Adaptive Integration for NPIC,
V: 13-2
 SL-1 Adaptive Integration, *V*: 6-2
 Capacity on demand, list feature screen, explanation,
IV: 6-41
 Central Office
 changes, *IV*: 3-5
 sample letter, *IV*: 3-7
 trunking, *IV*: 3-6 to 3-7
 Central Processing Unit, *IV*: 2-22
 Centrex, *IV*: 3-4
 installations, *V*: 4-9
 Centrex Adaptive Integration, *V*: 4-1
 call forwarding, *V*: 4-1
 call forwarding unrestricted source, *V*: 4-6
 call record, *V*: 4-3
 Called Party Identification, *V*: 4-1
 configuration, *V*: 4-6
 data link, *V*: 4-1, 4-2, 4-3, 4-12, 4-14
 DMS-100, *V*: 4-4
 forwarding, *V*: 4-1, 4-3
 hunt group, *V*: 4-1, 4-6
 installation, *V*: 4-12
 limitations, *V*: 4-4
 message desk, *V*: 4-13
 message desk number, *V*: 4-8
 message desk terminal number, *V*: 4-8

- Centrex Adaptive Integration (continued)
 - message taking mode, *V*: 4-8
 - Message Waiting Indication, *V*: 4-1
 - RS-232 interface port, *V*: 4-12
 - sequential forwarding, *V*: 4-4
 - serial data link. *See data link*
 - SL-100, *V*: 4-4
 - SMDI call records, *V*: 4-13
 - stutter dial tone, *V*: 4-2
 - UCD group, *V*: 4-1
 - uniform call distribution, *V*: 4-5
 - VMX System configuration, *V*: 4-7 to 4-11
- Centrex services, *IV*: 3-6
- Circular hunt group, *IV*: 3-2
- Class of Service, system performance report by COS, *IV*: 5-35 to 5-37
- CLEAR command
 - hardware, *IV*: 6-4, 8-4
 - integration, *IV*: 6-4
 - maintenance, *IV*: 6-3
 - Network Failure Table, *IV*: 6-4
 - peg, *IV*: 6-4, 8-37
 - report, *IV*: 6-4
 - round trip time for message waiting, *IV*: 6-4
- CLEAR REPORT command, *IV*: 5-4
- Client server protocol trace, *IV*: 7-20
- CMD PING command
 - digital networking, *IV*: 6-27, 11-6
 - LAN troubleshooting, *IV*: 6-27
- CO. *See Central Office*
- Collocated analog networking
 - call processing, *VI*: 2.2-3
 - configuration, *VI*: 2.2-6 to 2.2-15
 - COS attributes, *VI*: 2.2-15 to 2.2-16
 - interrelationships of tables, *VI*: 2.2-5
 - LOCATION Table, *VI*: 2.2-9 to 2.2-11, 5-28 to 5-32
 - LOCATION Table form, sample, *VI*: 2.2-10
 - NUMBERING PLAN Table, *VI*: 2.2-11 to 2.2-14, 6-12 to 6-15
 - NUMBERING PLAN Table form, sample, *VI*: 2.2-13
 - operation, *VI*: 2.2-3 to 2.2-5
 - planning, *VI*: 2.2-1 to 2.2-16
 - ROUTE Table, *VI*: 2.2-6 to 2.2-9, 7-5 to 7-7
 - ROUTE Table form, sample, *VI*: 2.2-8
 - system parameters, *VI*: 2.2-15
 - test, *VI*: 2.2-16
- Collocated integration, digital networking, *VI*: 3-32
- Collocated networking, INSTALL program, *IV*: 1-14
- Commands
 - administrative password, *IV*: 6-13
 - CLEAR, *IV*: 6-3
 - hardware, *IV*: 8-4
 - hardware error, *IV*: 6-4
 - integration, *IV*: 6-4
 - Network Failure Table, *IV*: 6-4
 - peg, *IV*: 8-37
 - report, *IV*: 6-4
 - round trip time for message waiting, *IV*: 6-4
 - traffic peg, *IV*: 6-4
 - CMD PING, *IV*: 6-27, 11-6
 - Courtesy up, port, *IV*: 6-39
 - Courtesy down
 - channel 1, *IV*: 6-7
 - port, *IV*: 6-39
 - Courtesy down/Courtesy up, *IV*: 6-7
 - Courtesy up, port, *IV*: 6-7
 - courtesy up/down, *IV*: 6-6
 - DCSTAT, *IV*: 6-25
 - DEX, *IV*: 6-29
 - disk information status, L DMAP, *IV*: 6-31
 - EXPORTNAMES, *IV*: 6-9
 - FINDMBOX, *IV*: 6-24; *VI*: 3-48
 - floppy disk drive, *IV*: 6-9
 - GWLSTAT, *IV*: 6-10
 - HELP, *IV*: 6-10
 - INSTALL, *IV*: 4-35, 6-10
 - L DMAP, *IV*: 6-10
 - LANSTAT, *IV*: 6-23, 11-7
 - LCSTAT, *VI*: 3-49
 - LIST, *IV*: 6-1
 - call processing trace, *IV*: 6-3
 - features, *IV*: 6-1, 6-40
 - hardware, *IV*: 8-4
 - hardware errors, *IV*: 6-1
 - header, *IV*: 6-1, 6-19
 - integration status, *IV*: 6-2
 - mailbox, *IV*: 6-2, 6-17, 6-18
 - network domain, *IV*: 6-2
 - network failures, *IV*: 6-2
 - network mailbox, *IV*: 6-2, 6-22
 - peg, *IV*: 6-2, 8-37
 - port, *IV*: 6-2, 6-27
 - report, *IV*: 6-3
 - round trip time for message waiting, *IV*: 6-3
 - Visual Mailbox, *IV*: 6-3
 - LIST CCM, *IV*: 6-1
 - list, *IV*: 6-15
 - LIST CLERR, *IV*: 6-1
 - LIST NET DOMAIN, *VI*: 3-47
 - LIST REPORT, *VI*: 3-66
 - digital information, *VI*: 3-63
 - LOG, *IV*: 6-11; *VI*: 3-53
 - LOG PR CPT, *VI*: 3-53
 - maintenance password, *IV*: 6-13

Commands (continued)

- message waiting lamp, *IV*: 6-12
 - relite, *IV*: 6-12
- miscellaneous, *IV*: 6-8 to 6-17
 - APURGE, *IV*: 6-9
 - BAUD, *IV*: 6-9
 - BITTST, *IV*: 6-9
 - CPURGE, *IV*: 6-9
 - DEX, *IV*: 6-9
 - DKSMAP, *IV*: 6-9
 - DSKTST, *IV*: 6-9
 - FLOPPY, *IV*: 6-9
 - HELP, *IV*: 6-10
 - INSTALL, *IV*: 6-10
 - ISTAT, *IV*: 6-10
 - LANG, *IV*: 6-10
 - LANSTAT, *IV*: 6-11
 - MODEM DISABLE, *IV*: 6-12
 - MODEM ENABLE, *IV*: 6-12
 - MON2, *IV*: 6-12
 - MWLRECALC, *IV*: 6-12
 - MWOFF, *IV*: 6-12
 - MWRELITE, *IV*: 6-12
 - PASSWORD, *IV*: 6-12
 - Patch, *IV*: 6-13
 - PORT STATUS, *IV*: 6-15, 6-34
 - Print tone, *IV*: 6-14
 - PRTMAP, *IV*: 6-15, 6-28
 - RESTART, *IV*: 6-15
 - SDBG, *IV*: 6-15
 - TIME, *IV*: 6-15
 - UPINTG, *IV*: 6-16, 6-34
- modem disable, *IV*: 6-12
- modem enable, *IV*: 6-12
- monitor terminal #2, *IV*: 6-12
- NAMESEND, *VI*: 3-14
- NAMESTAT, *VI*: 3-50
- operating system, *IV*: 4-35
- reports password, *IV*: 6-13
- ring-through diagnostic test, *IV*: 6-33
- SDBG, *IV*: 6-15
- shutdown/startup, *IV*: 6-6
- summary, *IV*: 6-1 to 6-16
- Courtesy down OctelAccess Server, CDGWL, *IV*: 6-8
- Courtesy up OctelAccess Server, CUGWL, *IV*: 6-8
- system service mode
 - GWLSTAT, *IV*: 6-10
 - SHUTDOWN, *IV*: 6-8
 - STARTUP, *IV*: 6-8
- TEST, *IV*: 6-4
 - alarm, *IV*: 6-4
 - alarm diagnostic, *IV*: 6-37
 - echo, *IV*: 6-4
 - fax loopback, *IV*: 6-6
 - floppy, *IV*: 6-5
 - hard disk drive (DEX), *IV*: 6-6
 - integration, *IV*: 6-6
 - LAN status, *IV*: 6-6
 - line 1, *IV*: 6-5, 6-32
 - line 2, *IV*: 6-5, 6-33
 - line 4, *IV*: 6-5
 - line 5, *IV*: 6-5, 6-32
 - network, *IV*: 6-5
 - SNMP manager system, communication with, *IV*: 6-6
 - system forwarding diagnostic, *IV*: 6-39
 - system initialization, *IV*: 6-39
 - system status, *IV*: 6-5, 6-40
 - test, *IV*: 6-4
 - TEST LAN, *VI*: 3-43 to 3-46
 - TEST SNMP, *IV*: 11B-11 to 11B-12
 - traffic peg count table, *IV*: 8-37
 - UPDATE, *IV*: 4-35
 - update integration, *IV*: 6-16
 - VCU, *IV*: 6-16
- Disk status, *IV*: 6-10
- Company Greeting mailbox index, INSTALL program, *IV*: 1-18
- Components, part numbers, *IV*: 9-56
- Configuration
 - collocated analog networking, *VI*: 2.2-6 to 2.2-15
 - digital networking, *VI*: 3-34 to 3-42
 - configuration tables, *VI*: 3-21 to 3-22
 - CUSTOM PROMPT Table, *VI*: 3-41
 - LOCATION Table, *VI*: 3-38 to 3-40
 - ADD command, *VI*: 3-39
 - MODIFY command, *VI*: 3-40
 - NUMBERING PLAN Table, *VI*: 3-41
 - ADD command, *VI*: 3-41
 - SNMP, *IV*: 11B-7 to 11B-9
 - SYSTEM PARAMETER Table, *VI*: 3-34 to 3-38
 - DTIC, *IV*: 10-3 to 10-9
 - LAN card, SLOTS Table, *IV*: 11-2
 - mailbox status, *IV*: 6-17
 - message server for MD110 integration, *V*: 14-14
 - package, *IV*: 1-7
 - port status, *IV*: 6-27, 6-28
 - remote analog networking, *VI*: 2.1-33 to 2.1-66
 - COS attributes, *VI*: 2.1-64 to 2.1-67
 - LOCATION Table, *VI*: 2.1-44 to 2.1-54
 - NUMBERING PLAN Table, *VI*: 2.1-54 to 2.1-59
 - ROUTE Table, *VI*: 2.1-41 to 2.1-44
 - system parameters, *VI*: 2.1-59 to 2.1-64
 - system, *IV*: 4-44

Configuration forms, networking, *VI*: 2.2-6
 Configuration requirements, MD110 and Octel
 Overture 200/300 message servers, *V*: 14-9
 Connecting
 connector blocks, *IV*: 4-46
 external modem, *IV*: 4-17 to 4-19
 internal modem, *IV*: 4-19 to 4-21
 Overture 200/300, *IV*: 4-45
 overview, *IV*: 4-45
 PBX, *IV*: 4-45
 verifying the equipment, *IV*: 4-45
 wiring, *IV*: 4-47
 Connecting the terminal, *IV*: 4-16, 4-38
 pin assignment, *IV*: 4-16
 Console, *IV*: 3-4
 COS attributes
 collocated analog networking,
 VI: 2.2-15 to 2.2-16
 remote analog networking, *VI*: 2.1-64 to 2.1-67
 Courtesy down command, channel 1, *IV*: 6-7
 Courtesy up command, *IV*: 6-6
 port, *IV*: 6-7
 CPI. *See Called Party Identification*
 CPT. *See Call processing trace*
 CPU
 See also Central Processing Unit
 replacement, *IV*: 9-13
 CPURGE command, *IV*: 6-9
 CSP. *See Client server protocol trace*
 CUSTOM PROMPT Table
 collocated analog networking, *VI*: 2.2-15
 digital networking, *VI*: 3-41
 CX mode. *See Secondary Answering*

D

DAC. *See Direct Access Card*
 Damage report, *IV*: 4-1
 DATA to DTMF translations, remote analog
 networking, *VI*: 2.1-84
 DC power source, DC subassemblies,
 field wiring, *IV*: 9-53
 DC voltage test points, *IV*: 4-37
 DCD signal, *IV*: 4-18
 DCSTAT command, digital networking, *IV*: 6-25
 DDD, *VI*: 7-2
 Dedicated modem connection, *IV*: 4-17
 Default
 existing mailbox, *IV*: 1-10
 INFORMATION Table, *IV*: 1-17
 new mailbox, *IV*: 1-10
 security code, *IV*: 1-10
 Default password, *IV*: 6-12
 ADD command, NETWORK SCHEDULE Table,
 VI: 8-5
 DELETE command
 LOCATION Table
 collocated analog networking, *VI*: 5-32
 digital networking, *VI*: 5-27
 remote analog networking, *VI*: 5-16
 NETWORK SCHEDULE Table, *VI*: 8-6
 NUMBERING PLAN Table
 collocated analog networking, *VI*: 6-15
 digital networking, *VI*: 6-11
 remote analog networking, *VI*: 6-7
 ROUTE Table
 collocated analog networking, *VI*: 7-7
 remote analog networking, *VI*: 7-4
 Delivery of messages, network, *VI*: 2.1-19
 DEX command, *IV*: 6-6, 6-9, 6-29 to 6-31
 Diagnostic commands and software tools, digital
 networking, *VI*: 3-59 to 3-61
 Diagnostic program
 alarm test, *IV*: 6-37
 beep test, *IV*: 6-32
 DTMF test, *IV*: 6-32
 features test, *IV*: 6-40
 floppy disk drive, *IV*: 6-28 to 6-29
 hard disk drive, *IV*: 6-29 to 6-31
 line interface card, *IV*: 6-32
 port status, *IV*: 6-34
 ring-through test, *IV*: 6-33
 selftesting, *IV*: 6-17
 system forward test, *IV*: 6-39
 system initialization test, *IV*: 6-39
 system status test, *IV*: 6-40
 terminal operated program, *IV*: 6-17
 tone test, *IV*: 6-32
 Diagnostic tools
 digital networking, *VI*: 3-47 to 3-52
 remote analog networking, *VI*: 2.1-75
 Dial-by-Name, *VI*: 2.1-21, 3-18
 DID or Centrex services, *IV*: 3-6
 DID/E&M trunk interface, *IV*: 3-4, 3-6
 Digital Line Card, *IV*: 2-18
 Digital Network Performance Report,
 IV: 5-13 to 5-16; *VI*: 3-66 to 3-69
 Digital Networking
 Digital Network Performance Report,
 IV: 5-13 to 5-16
 maintenance and troubleshooting
 CMD PING command, *IV*: 6-27
 DCSTAT command, *IV*: 6-25
 FINDMBOX command, *IV*: 6-24
 LANSTAT command, *IV*: 6-23

- Digital networking, *VI*: 3-1 to 3-69
 - advantages of, *VI*: 1-4, 3-2 to 3-3
 - analog standby for LAN message delivery, *VI*: 3-19 to 3-20
 - call processing features, *VI*: 3-10
 - collocated integration, *VI*: 3-32
 - configuration, *VI*: 3-34 to 3-42
 - SNMP, *IV*: 11B-7 to 11B-9
 - CUSTOM PROMPT Table, *VI*: 3-41
 - diagnostic tools, *VI*: 3-47 to 3-52
 - Digital Network Performance Report, *VI*: 3-66 to 3-69
 - FINDMBOX command, messages and descriptions, *VI*: 3-49
 - gateway/tandeming cases, *VI*: 3-26 to 3-34
 - installation, *VI*: 3-42
 - hardware, *VI*: 3-42
 - internet addresses, *IV*: 11A-1 to 11A-5, 11B-1 to 11B-12; *VI*: 3-25
 - internet addresses and subnet masks, using UPDATE, *VI*: 3-25
 - IP addresses, *IV*: 11A-1 to 11A-5, 11B-1 to 11B-12
 - special (reserved), *IV*: 11A-2
 - LAN card, *IV*: 11-1
 - installing, *IV*: 11-5
 - testing, *IV*: 11-6
 - LIST NF command, *VI*: 3-50
 - LOCATION Table, *VI*: 3-9, 3-38 to 3-40, 5-17 to 5-27
 - ADD command, *VI*: 3-39
 - MODIFY command, *VI*: 3-40
 - maintenance and troubleshooting, *VI*: 3-47 to 3-62
 - CMD PING command, *IV*: 11-6
 - FINDMBOX command, *VI*: 3-48
 - LANSTAT command, *IV*: 11-7
 - LCSTAT command, *VI*: 3-49
 - LIST NET DOMAIN command, *VI*: 3-47
 - LOG command and Call Processing Trace, *VI*: 3-53
 - NAMESEND command, *VI*: 3-14
 - NAMESTAT command, *VI*: 3-50
 - traffic pegs, *IV*: 11-9 to 11-10; *VI*: 3-56 to 3-59
 - message gateway cases, *VI*: 3-26 to 3-31
 - messaging and call processing, *VI*: 3-10 to 3-11
 - messaging features, *VI*: 3-10
 - MIB, Internet MIB-II standard, *IV*: 11B-2
 - NameNet, *VI*: 3-18
 - alphabetic (ASCII) name propagation, *VI*: 3-18
 - alphabetic (ASCII) name verification, *VI*: 3-18 to 3-21
 - Namesend feature, *VI*: 3-12 to 3-17
 - configuration, *VI*: 3-12 to 3-14
 - network error types and remedies, *VI*: 3-52
 - Network Failure Table, *VI*: 3-51
 - network test, *VI*: 3-43 to 3-46
 - TEST LAN command, *VI*: 3-43 to 3-46
 - Network Traffic Report, digital information, *VI*: 3-63 to 3-65
 - NUMBERING PLAN Table, *VI*: 3-8, 3-41, 6-8 to 6-11
 - ADD command, *VI*: 3-41
 - Octel private MIB, *IV*: 11C-1 to 11C-13
 - listing, *IV*: 11C-2
 - sample session for obtaining from Internet, *IV*: 11C-1
 - planning for, *VI*: 3-21 to 3-24
 - configuration tables, *VI*: 3-21 to 3-22
 - information required for LAN connection, *VI*: 3-22 to 3-25
 - reports, *VI*: 3-63 to 3-69
 - requirements for networking across servers in a UNP, *VI*: 3-11
 - review of numbering plan issues, *VI*: 3-3
 - Simple Network Management Protocol, *IV*: 11B-1 to 11B-12
 - SLOTS Table, *IV*: 11-2
 - SNMP, *IV*: 11B-1 to 11B-12; *VI*: 3-23
 - CONFIG, *IV*: 11B-3
 - DNETSTAT, *IV*: 11B-5
 - HWERRTABLE, *IV*: 11B-5
 - LOCTABLE, *IV*: 11B-4
 - private MIB, *IV*: 11B-3 to 11B-6
 - private MIB information refresh, *IV*: 11B-6
 - query tracing, *IV*: 11B-6
 - system parameters, *IV*: 11-3; *VI*: 3-38
 - TEST SNMP command, *IV*: 11B-11 to 11B-12
 - messages, *IV*: 11B-11
 - trap, Hardware Error Table entries for, *IV*: 11B-10
 - trap CP trace, example, *IV*: 11B-10
 - trap notification, *IV*: 11B-7
 - trap report, example, *IV*: 11B-9
 - traps, *IV*: 11B-7 to 11B-12
 - Subnet addresses, *IV*: 11A-3
 - subnet masks, *IV*: 11A-4
 - SYSTEM PARAMETER Table, *VI*: 3-34 to 3-38
 - taking out of service, *IV*: 11-10 to 11-12; *VI*: 3-33
 - when to use Courtesy Down, *IV*: 11-10
 - TEST LAN command, messages and descriptions, *VI*: 3-44
 - troubleshooting, *VI*: 3-59 to 3-63
 - diagnostic commands and software tools, *VI*: 3-59 to 3-61
 - installation problems, *VI*: 3-62
 - LAN network problems, *VI*: 3-62
 - message delivery problems, *VI*: 3-61
 - numbering plan problems, *VI*: 3-62
 - real-time name problems, *VI*: 3-62

Digital networking (continued)
 uniform numbering plan, *VI*: 3-3 to 3-9
 advantages of, *VI*: 3-4 to 3-5
 configuring a server to be in, *VI*: 3-8 to 3-10
 domain, *VI*: 3-3
 how it works, *VI*: 3-6 to 3-8
 requirements for creating, *VI*: 3-6

Digital trunk interface card (DTIC),
IV: 10-1 to 10-20

Direct Access Card, *IV*: 2-19

Direct department calling, *IV*: 3-12

Direct In Line feature, *IV*: 3-3, 3-9
 PBX without, *IV*: 3-12

Directing trunks. *See Preparing the Phone System*

Disk drive backplane, replacement,
IV: 9-46 to 9-48

Disk EX command, *IV*: 6-6

Disk information status, *IV*: 6-31

Disk usage report, *IV*: 5-25 to 5-26

DISKO command, hard disk drive procedures,
IV: 12-43

DLC16, *IV*: 2-18

Domain. *See Uniform numbering plan*

Domain digital networking
 uniform numbering plan, *VI*: 3-3 to 3-9
 uniform numbering plan advantages, *VI*: 3-4

Double-interrupted ringback, *IV*: 1-26

DPNSS Integration, *V*: 15-1 to 15-24
 A-law, *V*: 15-1
 DTIC card, *V*: 15-1
 message server configuration, *V*: 15-3
 message types, *V*: 15-14
 rejection cause code table, *V*: 15-15
 SLOTS Table configuration, *V*: 15-4
 Status command, *V*: 15-10
 system parameters used, *V*: 15-3
 testing installation, *V*: 15-7
 trace, *V*: 15-12
 troubleshooting, *V*: 15-10

Drive status, *IV*: 6-31

DSKMAP command, *IV*: 6-9
 hard disk drive procedures, *IV*: 12-41

DSKTST command, *IV*: 6-9
 hard disk drive procedures, *IV*: 12-42

DTIC
See also DTIC
 hardware, *IV*: 10-1 to 10-3
 how to configure, *IV*: 10-3 to 10-9
 installation, *IV*: 9-20
 pin assignments, *IV*: 4-26
 replacement, *IV*: 9-19 to 9-23
 troubleshooting and maintenance,
IV: 10-10 to 10-20

DTMF, diagnostic test, *IV*: 6-32

DTMF In-band Integration, *V*: 3-1 to 3-14
 Adaptive Integration optional software, *V*: 3-1
 configuration tables affected
 COS Table, *V*: 3-12
 SLOTS Table, *V*: 3-12
 SYSTEM PARAMETER Table, *V*: 3-12
 TRANSLATION Table, *V*: 3-12
 TRUNK GROUP Table, *V*: 3-12
 USER Table, *V*: 3-12
 DTMF call records, *V*: 3-1
 list trace, *V*: 3-13
 operation, *V*: 3-3 to 3-4
 PBX considerations, *V*: 3-5

DTMFINT Table
 call record format, *V*: 3-6
 order of elements, *V*: 3-6
 default, *V*: 3-6
 DTMF call record, *V*: 3-6
 field format specifications
 fill DTMF digit, *V*: 3-8
 fix, *V*: 3-8
 lead or trail, *V*: 3-8
 length, *V*: 3-8
 system parameters, *V*: 3-8
 terminating DTMF digit, *V*: 3-9
 VAR, *V*: 3-9

E

Electrical current, *IV*: 4-3

Electronic feature delivery, *IV*: 12-1 to 12-2

Enhanced DTMF In-band Integration
See also DTMF In-band Integration
 benefits, *V*: 3-1
 PBX considerations, *V*: 3-5

Entering configuration database, *IV*: 4-44

Equipment requirements, *IV*: 4-14

Error message, boot ROM diagnostics, *IV*: 8-1

Error types, hardware, *IV*: 8-5

Errors, during backup and restore, *IV*: 12-40

Extension number, test, *IV*: 4-50

External modem, *IV*: 4-17 to 4-19
 baud rate, *IV*: 4-17

F

Fan, replacement, *IV*: 9-33 to 9-35

Fan tray, Overture 300, *IV*: 2-9

Fax application processor, *IV*: 2-20
 replacement, *IV*: 9-24 to 9-25

Cabinet

- inside front view, *IV*: 2-5, 2-11
- outer enclosure, *IV*: 2-2
- Overture 200 rear view, *IV*: 2-6
- Overture 300 inside rear view, *IV*: 2-13
- Overture 300 rear view, *IV*: 2-12
- shelf A, *IV*: 2-8
- shelves B and C, *IV*: 2-8

Features

- adding. *See Electronic feature delivery/removal*
- diagnostic test, *IV*: 6-40
- LIST command, *IV*: 6-40

FIFO Queuing. *See* Call Queuing**FINDMBOX command**

- digital networking, *IV*: 6-24; *VI*: 3-48
- messages and descriptions, *IV*: 6-24; *VI*: 3-49

Flags, list mailbox, *IV*: 6-18**FLOPPY command, *IV*: 6-9****Floppy directory, *IV*: 12-39****Floppy disk drive**

- diagnostics, *IV*: 6-28 to 6-29
- replacement, *IV*: 9-28 to 9-30

Floppy diskette drive. *See* Load/backup device**Floppy drive unit, replacement, *IV*: 9-30 to 9-33****Fujitsu Focus 9600 PBX, Adaptive Integration, *V*: 4-1****Functional test, PBX, *IV*: 4-51****G****Gateway, Protocol 2, 4, and 5, *VI*: 2.1-16****Gateway cases, digital networking, message gateway, *VI*: 3-26 to 3-31****Gateway statistics, *IV*: 6-10****Gateway/tandem cases, digital networking, *VI*: 3-26 to 3-34****Group fax number, INSTALL program, *IV*: 1-23****H****Hard disk drive, *IV*: 2-25**

- add, *IV*: 12-45 to 12-77
- commands, *IV*: 12-41 to 12-77
 - DISKO, *IV*: 12-43
 - DSKMAP, *IV*: 12-41
 - DSKTST, *IV*: 12-42
- diagnostic test, *IV*: 4-39
- diagnostics, *IV*: 6-29
- maintenance, *IV*: 9-25
- procedures, *IV*: 12-41 to 12-70
- remove, *IV*: 12-51
- replace, *IV*: 12-54 to 12-77

replacement, *IV*: 9-25 to 9-28**reset, *IV*: 4-39****restore, *IV*: 12-58 to 12-77****upgrade languages, *IV*: 12-72 to 12-77****Hard Disk Redundancy, *IV*: 2-26****Hard drive status, physical size, *IV*: 6-31****Hardware**

- 50-pin teleco connector, *IV*: 2-2
- AC to DC conversion, *IV*: 9-51 to 9-53
- air exhaust, *IV*: 2-3, 2-9
- air filter, *IV*: 2-3, 2-9
- AT&T Integration Card, *IV*: 2-20
- Central Processing Unit, *IV*: 2-22
- description, *IV*: 2-1 to 2-26
- digital networking, installation, *VI*: 3-42
- Direct Access Card, *IV*: 2-19
- DTIC, *IV*: 10-1 to 10-3
- Fax Application Processor, *IV*: 2-20
- hard disk drive, *IV*: 2-25
- installation, *IV*: 4-37 to 4-39
- installation checklist, *IV*: 4-59
- integration cards, *IV*: 2-20
- LAN card, *IV*: 2-20, 11-1
- LAN card hardware kit, *VI*: 3-1
- load/backup device, *IV*: 2-9, 2-25
- Loopstart Line Interface Cards, *IV*: 2-18
- Mitel Integration Card, *IV*: 2-21
- Northern Telecom SL-1 Integration Card, *IV*: 2-21
- Option Control Chip, *IV*: 2-24
- Overture 200 cabinet, *IV*: 2-2
- Overture 200/300 cabinet description, *IV*: 2-1
- Overture 300 fan tray, *IV*: 2-9
- Overture 300 power line filter, *IV*: 2-8
- PIC
 - AT&T, *IV*: 2-21
 - NPIC, *IV*: 2-21
- Power Supply Unit, *IV*: 2-22
- replacement, *IV*: 9-12 to 9-55
 - air filter, *IV*: 9-35 to 9-36
 - digital trunk interface card, *IV*: 9-19
 - disk drive backplane, *IV*: 9-46
 - fan panel, *IV*: 9-33 to 9-34
 - fan tray, *IV*: 9-34 to 9-35
 - fax application processor, *IV*: 9-24
 - floppy disk drive, *IV*: 9-28
 - floppy drive unit, *IV*: 9-30
 - hard disk drive, *IV*: 9-25
 - integration card, *IV*: 9-15
 - line interface card, *IV*: 9-14
 - load resistor assembly, *IV*: 9-48
 - local area network card, *IV*: 9-17
 - motherboard assembly, *IV*: 9-36
 - option control chip, *IV*: 9-53 to 9-56

Hardware (continued)

- power filter assembly, *IV*: 9-50 to 9-51
 - power supply unit, *IV*: 9-30
 - printed circuit assemblies, *IV*: 9-12
 - ROLM Integration Card, *IV*: 2-21
 - RS-232C Connector, *IV*: 2-2
 - Serial Integration Card, Meridian 1, *IV*: 2-21
 - shelf B Motherboard, *IV*: 2-24
 - shelf C Motherboard, *IV*: 2-24
 - system terminal port, *IV*: 2-1
 - system/voice disk drives, *IV*: 2-3, 2-9
 - system/voice disks, *IV*: 2-25
 - Telemarketing Line Card, *IV*: 2-19
 - Voice Control Unit, *IV*: 2-21
 - voice disk drives, *IV*: 2-9
 - voice storage disks, *IV*: 2-25
 - Works ACP card, *IV*: 2-19
 - Works disk drive, *IV*: 2-3, 2-9
 - Works hard disk, *IV*: 2-25
- Hardware errors, *IV*: 8-4 to 8-36
- Hardware requirements, MD110, *V*: 14-8
- HD. *See Hard Disk*
- HELP command, *IV*: 6-10
- Hunt group, *IV*: 3-2, 3-8
- test, *IV*: 4-53
- Hunt groups. *See Preparing the Phone System*

I

Incoming call

- call processing report, *IV*: 5-23
 - processing, *IV*: 3-3
- Incoming Call Restriction, INSTALL program, *IV*: 1-20
- Initial digits expected, NUMBERING PLAN Table, *VI*: 6-3, 6-8, 6-13
- Inspecting, cabinet, *IV*: 4-1
- INSTALL
- command, *IV*: 4-35, 4-44
 - entering configuration database, *IV*: 4-44
 - program, *IV*: 4-44
- INSTALL program, *IV*: 1-1 to 1-33
- announce calls to intercept index, *IV*: 1-22
 - auto transfer to assistance index, *IV*: 1-22
 - Call Queuing, *IV*: 1-22
 - Call Queuing message mailbox index, *IV*: 1-22
 - command, *IV*: 6-10
 - Company Greeting mailbox index, *IV*: 1-18
 - default answers, *IV*: 1-1
 - default existing mailbox, *IV*: 1-10
 - default new mailbox, *IV*: 1-10
 - default security code, *IV*: 1-10
 - Enter key, *IV*: 1-1

- entering, *IV*: 1-4
 - exiting, *IV*: 1-5
 - before INSTALL is complete, *IV*: 1-28 to 1-33 - exiting and continuing, *IV*: 1-29
 - group fax number, *IV*: 1-23
 - Incoming Call Restriction, *IV*: 1-20
 - intercept position, *IV*: 1-18
 - LOCATION Table, *IV*: 1-15
 - maximum message length index, *IV*: 1-22
 - maximum number of messages index, *IV*: 1-22
 - message with auto transfer index, *IV*: 1-22
 - networking
 - protocol 2, *IV*: 1-15
 - protocol 4, *IV*: 1-15
 - protocol 5, *IV*: 1-15
 - protocols 1 and 3, *IV*: 1-15 - offsite dial system parameter digits index, *IV*: 1-22
 - offsite end with sysp digits, *IV*: 1-22
 - offsite prefix digits index, *IV*: 1-21
 - offsite speak delay index, *IV*: 1-21
 - offsite speak times index, *IV*: 1-21
 - order of questions, *IV*: 1-2
 - pre-load all tables, *IV*: 1-31, 1-32
 - questions for "other" phone systems, *IV*: 1-26 to 1-27
 - quick greeting activation index, *IV*: 1-22
 - reinstall, *IV*: 1-29
 - reinstallation, *IV*: 1-4
 - Return key, *IV*: 1-1
 - serial number, *IV*: 1-8
 - Single Digit Menus, *IV*: 1-20
 - understanding, *IV*: 1-1 to 1-3
 - using, *IV*: 1-4 to 1-6
- Installation
- 48 VDC power supply unit, *IV*: 4-10
 - air filter, *IV*: 9-36
 - cabinet requirements, *IV*: 4-14
 - checklist, *IV*: 4-58 to 4-60
 - DC subassemblies, *IV*: 9-52, 9-53
 - field wiring, *IV*: 9-53 - digital networking, *VI*: 3-42
 - digital trunk interface card, *IV*: 9-20
 - disk drive backplane, *IV*: 9-47
 - fan panel, *IV*: 9-34
 - fan tray, *IV*: 9-35
 - fax application processor, *IV*: 9-25
 - floppy disk drive, *IV*: 9-29
 - hard disk drive, *IV*: 9-27
 - hardware, *IV*: 4-37 to 4-39
 - integration card, *IV*: 9-16
 - LAN card, *IV*: 9-17
 - line interface card, *IV*: 9-15
 - load resistor assembly, *IV*: 9-49
 - materials, *IV*: 4-10

- Installation (continued)
- motherboard assembly, *IV*: 9-38, 9-40
 - option control chip, *IV*: 9-55
 - power filter assembly, *IV*: 9-50
 - power supply unit, *IV*: 9-32
 - procedure, *IV*: 4-11
 - procedures, *IV*: 4-4 to 4-14
 - power requirements, *IV*: 4-4
 - site requirements, *IV*: 4-4
 - required equipment, *IV*: 4-14
 - 25-pair cable, *IV*: 4-46
 - RS-232C cable, *IV*: 4-14
 - terminal, *IV*: 4-14
 - software, *IV*: 4-44
- Installation checklist
- AT&T Definity G3 Adaptive Integration, *V*: 7.1-51 to 7.1-56
 - AT&T System 75 Adaptive Integration, *V*: 7.2-51 to 7.2-56
 - AT&T System 85 Adaptive Integration, *V*: 7.3-45 to 7.3-49
 - ITT 3100 Adaptive Integration, *V*: 9-16 to 9-19
 - Meridian 1 Adaptive Integration, *V*: 11-39 to 11-45
 - Mitel SX-2000 Adaptive Integration, *V*: 10.3-50 to 10.3-53
 - ROLM 9751 Adaptive Integration, *V*: 8.2-33 to 8.2-35
 - ROLM Adaptive Integration, *V*: 8.1-36 to 8.1-38
 - SL-1 Adaptive Integration, *V*: 6-38 to 6-44
- Installation problems, digital networking, *VI*: 3-62
- Installation requirements, MD110, *V*: 14-8 to 14-9
- Installing connector blocks, *IV*: 4-46
- Installing LAN card, *IV*: 11-2
- Intecom PBX, Adaptive Integration, *V*: 4-1
- Integration
- activity log, *IV*: 7-15
 - DPNSS, *V*: 15-1 to 15-2
 - update, *IV*: 6-33
- Integration calling statistics report, *IV*: 5-33 to 5-34
- Integration card, *IV*: 2-20
 - replacement, *IV*: 9-15 to 9-16
- Intercept, position, INSTALL program, *IV*: 1-18
- Intercept extension, test, *IV*: 4-56
- Interface, cable, *IV*: 4-16
- Internal modem, *IV*: 4-19 to 4-21
 - baud rate, *IV*: 4-19, 4-20
- International line interface card, (ILIC), *IV*: 2-18
- Internet addresses
- background information, *IV*: 11A-1 to 11A-5, 11B-1 to 11B-12
 - digital networking, *VI*: 3-25
 - using UPDATE, *VI*: 3-25
 - Internet MIB-II standard, SNMP, *IV*: 11B-2
 - InWATS (1-800) services, *IV*: 3-6
- IP addresses
- See also Internet addresses*
 - special (reserved), *IV*: 11A-2
- ISDN Integration, *V*: 16-1
 - DTIC Card, *V*: 16-1
 - Information Table, *V*: 16-3
 - Installing the DTIC, *V*: 16-5
 - message server configuration, *V*: 16-3
 - Slots Table, *V*: 16-3
 - status commands, *V*: 16-9
 - system parameters used, *V*: 16-3
 - Testing the installation, *V*: 16-6
 - trace, *V*: 16-11
 - troubleshooting, *V*: 16-9
- Isolation transformer, *IV*: 4-9
- ISTAT command, *IV*: 6-10
- ITT 3100 Adaptive Integration, *V*: 9-1 to 9-19
 - call records, *V*: 9-14
 - Called Party Identification, *V*: 9-1
 - functional considerations, *V*: 9-3
 - hardware requirements, *V*: 9-5
 - installation, *V*: 9-12
 - data cable pinouts, *V*: 9-13
 - data link cable connection, *V*: 9-12
 - installation checklist, *V*: 9-16 to 9-19
 - ITT 3100 configuration, *V*: 9-7
 - access codes and keys, *V*: 9-7
 - line card, *V*: 9-7
 - link, *V*: 9-7
 - Message Waiting Indication, *V*: 9-1
 - multilevel forwarding, *V*: 9-3
 - Overture 200/300 configuration, *V*: 9-10
 - Message Waiting Indication, *V*: 9-10
 - PBX configuration, extension requirements, *V*: 9-6
 - PBX requirements, *V*: 9-5 to 9-6
 - sequential forwarding, *V*: 9-3
 - software requirements, *V*: 9-6
- ## L
- LAN card, *IV*: 2-20
 - hardware, *IV*: 11-1
 - installing, *IV*: 11-5, 11-10
 - replacement, *IV*: 9-17 to 9-19
 - system parameters, *IV*: 11-3
 - taking out of service, *IV*: 11-10
 - testing, *IV*: 11-6
- LAN network problems, troubleshooting, *VI*: 3-62
- LAN status, test, *IV*: 6-6

- LAN troubleshooting, CMD PING command,
IV: 6-27
- LANG command, IV: 6-10
- Languages, upgrade procedure, IV: 12-72 to 12-77
- LANSTAT command, IV: 6-11, 11-7
digital networking, IV: 6-23
- LCSTAT command, digital networking, VI: 3-49
- LIC. *See Line Interface Card*
- Line 1, test diagnostics, IV: 6-32
- Line 2, test diagnostics, IV: 6-33
- Line 4, test diagnostics, IV: 6-33
- Line 5, test diagnostics, IV: 6-32
- Line Interface Card, diagnostics, IV: 6-32
- Line interface card, IV: 2-18
replacement, IV: 9-14 to 9-15
- LIST command
call processing trace, IV: 7-8
features, IV: 6-1, 6-40
features diagnostic, IV: 6-40
hardware, IV: 8-4
hardware errors, IV: 6-1
header, IV: 6-1, 6-19
integration status, IV: 6-2
- LOCATION Table
collocated analog networking, VI: 5-30
digital networking, VI: 5-18
remote analog networking, VI: 5-11
- mailbox, IV: 6-2, 6-17, 6-18
- network domain, IV: 6-2
- network failures, IV: 6-2
- network mailbox, IV: 6-2, 6-22
- NETWORK SCHEDULE Table, VI: 8-4
- NUMBERING PLAN Table
collocated analog networking, VI: 6-13
digital networking, VI: 6-9
remote analog networking, VI: 6-4
- peg, IV: 6-2, 8-37
- port, IV: 6-2, 6-27
- report, IV: 6-3
- round trip time for message waiting, IV: 6-3
- ROUTE Table
collocated analog networking, VI: 7-6
remote analog networking, VI: 7-3
- trace, IV: 6-3, 7-8
- user statistics report, IV: 5-3
- Visual Mailbox, IV: 6-3
- List commands, IV: 6-1 to 6-3
- List Feature screen, how to read, capacity on demand,
IV: 6-41
- LIST HE command, remote analog networking,
VI: 2.1-76
- LIST NET command, remote analog networking,
VI: 2.1-75
- LIST NET DOMAIN command, digital networking,
VI: 3-47
- LIST NF command
digital networking, VI: 3-50
remote analog networking, VI: 2.1-77
- LIST REPORT command, IV: 5-2
digital networking, VI: 3-63, 3-66
remote analog networking, VI: 2.1-97
- List Visual Mailbox, command, IV: 6-3
- Load resistor assembly, replacement,
IV: 9-48 to 9-49
- Load/backup device, IV: 2-9, 2-25
- LOC command, PR CPT, call processing trace,
IV: 7-12
- Local Area Network card, replacement,
IV: 9-17 to 9-19
- Location, trace activity, IV: 7-15
- Location code, zero (0), VI: 2.1-5
- LOCATION Table, VI: 5-1 to 5-32
collocated analog networking,
VI: 2.2-9 to 2.2-11, 5-28 to 5-32
how to configure, VI: 5-28
using UPDATE, VI: 5-29 to 5-32
- collocated networking, using INSTALL, VI: 5-29
- digital networking, VI: 3-9, 3-38 to 3-40,
5-17 to 5-27
- ADD command, VI: 3-39
how it is used, VI: 5-17
how to configure, VI: 5-17
- MODIFY command, VI: 3-40
using INSTALL, VI: 5-18
using UPDATE, VI: 5-18 to 5-28
- entering network schedule, VI: 5-14, 5-15
- INSTALL program, IV: 1-15
- overview, VI: 5-1
- remote analog networking, VI: 2.1-44 to 2.1-54,
5-2 to 5-16
- embed autocopy (OctelNet), VI: 5-6
- embedded name (OctelNet), VI: 5-6
how it is used, VI: 5-4
how to configure, VI: 5-4
- serial number (OctelNet), VI: 5-6
using INSTALL, VI: 5-7 to 5-11
using UPDATE, VI: 5-11 to 5-17
- secondary entries, collocated analog networking,
VI: 5-31
- secondary location, remote analog networking,
VI: 5-16
- LOCATION Table form
collocated analog networking, VI: 2.2-9
authorized length, VI: 2.2-11
has system, VI: 2.2-11
location name, VI: 2.2-11
primary location, VI: 2.2-11

LOCATION Table form (continued)

- protocol, *VI: 2.2-11*
- public/TIE network numbers, *VI: 2.2-11*
- route choices, *VI: 2.2-11*
- same location, *VI: 2.2-11*
- sample, *VI: 2.2-10*
- digital networking, *VI: 3-38*
- remote analog networking, *VI: 2.1-44*
 - authorized length, *VI: 2.1-51*
 - embed autocopy (AMIS), *VI: 2.1-54*
 - embedded name (OctelNet), *VI: 2.1-53*
 - has system, *VI: 2.1-51*
 - include SELF (Protocol 2), *VI: 2.1-52*
 - location name, *VI: 2.1-51*
 - primary location, *VI: 2.1-51*
 - priority/deferred port mailbox (Protocol 2), *VI: 2.1-52*
 - protocol, *VI: 2.1-51, 5-4*
 - public/TIE network numbers, *VI: 2.1-51*
 - route choices, *VI: 2.1-51*
 - same location, *VI: 2.1-51*
 - SELF OctelNet serial number, *VI: 2.1-54*
 - self system number (AMIS), *VI: 2.1-52*
 - serial number (OctelNet), *VI: 2.1-53*
 - system number (AMIS), *VI: 2.1-52*
 - use Pub/Pvt number (AMIS), *VI: 2.1-52*
- sample
 - Protocol 2, *VI: 2.1-47*
 - Protocol 4, *VI: 2.1-48*
 - Protocol 5, *VI: 2.1-49*
 - Protocols 1 and 3, *VI: 2.1-46*

LOG

- command, *IV: 6-11*
- options, *IV: 7-1, 7-2*

Log

- moves, adds, and changes, *IV: 7-43*
- server activity trace, *IV: 7-50*

LOG command, *IV: 7-1*

- AUX activities, *IV: 7-21*
- digital networking, *VI: 3-53*
- Event activities, *IV: 7-21*
- examples of PR CPT, *IV: 7-14*

LOG PR CPT command, digital networking, *VI: 3-53***M**

MAC log

- See also* Moves, adds, changes
- configuration table entries logged, *IV: 7-43*
- system distribution list changes logged, *IV: 7-48*
- extended mailbox changes logged, *IV: 7-48*

Mailbox

- add in ranges, input aid, *IV: 1-6*

- auto-increment, input aid, *IV: 1-6*
- configuration status, *IV: 6-17*
- LIST command, *IV: 6-2, 6-17, 6-18*
- usage report, *IV: 5-31*

Mailbox INFORMATION Table, *IV: 1-18*Mailboxes, capacity on demand, list feature screen, *IV: 6-41*

Maintenance

- application delays, *IV: 6-43 to 6-55*
- boot ROM diagnostics, *IV: 8-1 to 8-3*
- call processing trace, *IV: 7-5 to 7-21*
- CLEAR command, *IV: 6-3*
- command summary, *IV: 6-1 to 6-16*
- courtesy up/down commands, *IV: 6-6 to 6-8*
- diagnostics, *IV: 6-17 to 6-42*
- diagrams, *IV: 9-1 to 9-11*
- digital networking, *VI: 3-47 to 3-62*
 - CMD PING command, *IV: 6-27*
 - DCSTAT command, *IV: 6-25*
 - FINDMBOX command, *IV: 6-24; VI: 3-48*
 - LANSTAT command, *IV: 6-23*
 - LCSTAT command, *VI: 3-49*
 - LIST NET DOMAIN command, *VI: 3-47*
 - LOG command and Call Processing Trace, *VI: 3-53*
 - NAMESEND command, *VI: 3-14*
 - NAMESTAT command, *VI: 3-50*
 - traffic pegs, *VI: 3-56 to 3-59*

DTIC, *IV: 10-10 to 10-20*hardware errors, *IV: 8-4 to 8-36*hardware replacement, *IV: 9-12 to 9-55*

LAN card

- CMD PING command, *IV: 11-6*
- LANSTAT command, *IV: 11-7*
- traffic pegs, *IV: 11-9 to 11-10*

LIST command, *IV: 6-1*password, *IV: 6-13*preventive, *IV: 9-1 to 9-11*remote analog networking, *VI: 2.1-75 to 2.1-102*

- LIST HE command, *VI: 2.1-76*
- LIST NET command, *VI: 2.1-75 to 2.1-76*
- LIST NF command, *VI: 2.1-77 to 2.1-93*
- traffic pegs, *VI: 2.1-85 to 2.1-89*

shutdown/startup commands, *IV: 6-6 to 6-8*test commands, *IV: 6-4 to 6-6*traffic peg count table, *IV: 8-37 to 8-59*Maintenance and troubleshooting, remote analog networking, *VI: 2.1-75 to 2.1-102*Marking messages unplayable, *IV: 6-56*Maximum message length, Protocol 2, *VI: 2.1-62*Maximum message length index, INSTALL program, *IV: 1-22*Maximum number of messages index, INSTALL program, *IV: 1-22*

MD110

- adaptive integration, *V*: 14-1 to 14-31
 - call processing
 - direct internal calls, *V*: 14-4, 14-5
 - forwarded external calls, *V*: 14-4
 - forwarded internal calls, *V*: 14-5
 - message waiting, *V*: 14-6
 - call records, *V*: 14-3
 - called party Identification, *V*: 14-1
 - configuration checklist, *V*: 14-19
 - configuration recommendations, *V*: 14-12
 - configuration requirements, *V*: 14-9, 14-10
 - hardware requirements, *V*: 14-8
 - hunt group initiation, *V*: 14-12
 - ICU port settings for integration with message server, *V*: 14-11
 - message server configuration, *V*: 14-14 to 14-20
 - COS attributes, *V*: 14-14
 - System Parameter indexes, *V*: 14-15 to 14-18
 - message waiting indication, *V*: 14-1
 - requirements, hardware and software, *V*: 14-8
 - software requirements, *V*: 14-8
 - testing, adaptive integration, *V*: 14-21 to 14-29
 - traffic pegs, *V*: 14-30
- MD110 configuration, restart message server, *V*: 14-18
- Meridian 1 Adaptive Integration, *V*: 11-1 to 11-45
- Called Party Identification
 - direct calls from external trunks, *V*: 11-2
 - direct internal call, *V*: 11-3
 - forwarded external calls (RNA or busy), *V*: 11-2
 - forwarded internal calls, *V*: 11-3
 - hardware requirements, *V*: 11-4
 - installation checklist, *V*: 11-39 to 11-45
 - maintenance commands, *V*: 11-36 to 11-38
 - Overture 200/300 configuration
 - Called Party Identification, *V*: 11-15
 - Message Waiting Indication, *V*: 11-15
 - PBX configuration, *V*: 11-6 to 11-14
 - customer datablock, *V*: 11-6, 11-7
 - customer telephones, *V*: 11-14
 - incoming trunks, *V*: 11-6
 - link modular telephone extensions, *V*: 11-8
 - PBX requirements, *V*: 11-4 to 11-5
 - SIC8 board installation, *V*: 11-35
 - software requirements, *V*: 11-5
 - telephone installation, *V*: 11-17 to 11-19
 - testing, *V*: 11-20 to 11-34
 - testing procedure, *V*: 11-20 to 11-35
 - testing requirements, *V*: 11-20

Message

- activity log, *IV*: 7-15
 - length, *IV*: 4-57
 - traced activity, *IV*: 7-15
- Message address, overlapping mailbox addresses and network prefixes, *VI*: 2.1-7
- Message Block and Message Purge, *IV*: 6-56 to 6-60
- Message center, *IV*: 3-4
- Message delivery problems, digital networking, *VI*: 3-61
- Message delivery window, *VI*: 2.1-20, 8-1
- Message priority level, *VI*: 8-1, 8-2
- Message redundancy, networking, *VI*: 2.1-3, 3-10
- Message status, *IV*: 6-19
 - original message types, *IV*: 6-20
- Message waiting, test, *IV*: 4-57
- Message Waiting Indication, *V*: 1-1, 1-2
 - Adaptive Integration, *V*: 2-1
 - Adaptive Integration considerations, Round trip command, *V*: 2-6
 - display phone, *V*: 1-1
 - ITT 3100 Adaptive Integration, *V*: 9-1
 - lamp, *V*: 1-1
 - Mitel SX-2000 Adaptive Integration, *V*: 10.3-2
 - NEAX-2400 Adaptive Integration, *V*: 5-1
 - SL-1 Adaptive Integration, *V*: 6-1
 - stutter dial tone, *V*: 1-1
- Message waiting notification
 - integration activity, *IV*: 7-15
 - offsite dial system parameter digits index, INSTALL program, *IV*: 1-22
 - offsite end sysp digits, INSTALL program, *IV*: 1-22
 - offsite prefix digits index, INSTALL program, *IV*: 1-21
 - offsite speak delay index, INSTALL program, *IV*: 1-21
 - offsite speak times index, INSTALL program, *IV*: 1-21
- Message with auto transfer index, INSTALL program, *IV*: 1-22
- Messages, TEST SNMP, *IV*: 11B-11 to 11B-12
- Messaging, flow, networking, *VI*: 2.1-28
- Messaging and call processing, digital networking, *VI*: 3-10 to 3-11
- Messaging protocols, analog networking, *VI*: 2-3, 2.1-3
- Messaging-only protocols, analog networking, *VI*: 2.1-3
- MIB
 - basic, *IV*: 11B-2
 - Internet MIB-II standard, *IV*: 11B-2 to 11B-12

- MIB (continued)
 private, *IV*: 11B-3 to 11B-6, 11C-1 to 11C-13
 listing, *IV*: 11C-2
 sample sessions for obtaining from Internet,
IV: 11C-1
- MIC. *See Mitel Integration Card; Mitel SX-100/SX-200 Analog Adaptive Integration; Mitel SX-2000 Adaptive Integration*
- Miscellaneous commands
 APURGE, *IV*: 6-9
 BAUD, *IV*: 6-9
 BITTST, *IV*: 6-9
 CPURGE, *IV*: 6-9
 DEX, *IV*: 6-9
 DSKMAP, *IV*: 6-9
 DSKTST, *IV*: 6-9
 FLOPPY, *IV*: 6-9
 INSTALL, *IV*: 6-10
 ISTAT, *IV*: 6-10
 LANG, *IV*: 6-10
 LANSTAT, *IV*: 6-11
 MODEM DISABLE, *IV*: 6-12
 MODEM ENABLE, *IV*: 6-12
 MON2, *IV*: 6-12
 MWLRECALC, *IV*: 6-12
 MWOFF, *IV*: 6-12
 MWRELITE, *IV*: 6-12
 PASSWORD, *IV*: 6-12
 Patch command, *IV*: 6-13
 PORT STATUS, *IV*: 6-15, 6-34
 Print tone command, *IV*: 6-14
 PRTMAP, *IV*: 6-15, 6-28
 RESTART, *IV*: 6-15
 SDBG, *IV*: 6-15
 TIME, *IV*: 6-15
 UPINTG, *IV*: 6-16, 6-34
- Mitel Integration Card, *IV*: 2-21
- Mitel SX-100/SX-200 Analog Adaptive Integration,
V: 10.2-1 to 10.2-40
 installation, *V*: 10.2-17 to 10.2-33
 maintenance commands, *V*: 10.2-34 to 10.2-37
 PBX configuration, system options, *V*: 10.2-10
 testing, *V*: 10.2-17 to 10.2-33
 VMX System configuration,
V: 10.2-13 to 10.2-16
- Mitel SX-200 Digital Adaptive Integration
 Called Party Identification
 direct calls from external trunks,
V: 10.1-2, 10.2-2
 direct internal calls, *V*: 10.1-3, 10.2-3
 forwarded external calls, *V*: 10.1-2, 10.2-2
 forwarded internal calls, *V*: 10.1-4, 10.2-4
 configuration requirements, *V*: 10.1-5
 installation, *V*: 10.1-23 to 10.1-40
 testing, *V*: 10.1-23 to 10.1-40
- Mitel SX-2000 Adaptive Integration,
V: 10.3-1 to 10.3-53
 call coverage, *V*: 10.3-2
 Called Party Identification, *V*: 10.3-1
 direct calls from external trunks, *V*: 10.3-7
 direct internal calls, *V*: 10.3-8
 forwarded external calls, *V*: 10.3-7
 forwarded internal calls, *V*: 10.3-8
 configuration requirements, *V*: 10.3-10
 hardware requirements, *V*: 10.3-10
 installation, *V*: 10.3-25 to 10.3-45
 installation checklist, *V*: 10.3-50 to 10.3-53
 maintenance commands, *V*: 10.3-46
 Message Waiting Indication, *V*: 10.3-2
 MIC board installation, *V*: 10.3-37
 PBX configuration
 call rerouting, *V*: 10.3-18
 MIC extensions, *V*: 10.3-15
 naming conventions, *V*: 10.3-13
 station extensions, *V*: 10.3-19
 trunks and trunk groups, *V*: 10.3-17
 PBX limitations, *V*: 10.3-11
 software requirements, *V*: 10.3-10
 testing, *V*: 10.3-25
 testing procedure, *V*: 10.3-26 to 10.3-53
 VMX System configuration,
V: 10.3-20 to 10.3-24
- Modem, *IV*: 6-17
 connecting, *IV*: 4-17, 4-19
 dedicated connection, *IV*: 4-17
 disable, *IV*: 6-12
 enable, *IV*: 6-12
 external, *IV*: 4-17 to 4-19
 internal, *IV*: 4-19 to 4-21
- MODIFY Command, NETWORK SCHEDULE
 Table, *VI*: 8-6
- MODIFY command
 LOCATION Table
 collocated analog networking, *VI*: 5-31
 digital networking, *VI*: 5-25
 remote analog networking, *VI*: 5-14
- NUMBERING PLAN Table
 collocated analog networking, *VI*: 6-14
 digital networking, *VI*: 6-10
 remote analog networking, *VI*: 6-7
- ROUTE Table
 collocated analog networking, *VI*: 7-7
 remote analog networking, *VI*: 7-4
- SLOTS Table, DTIC card, *IV*: 10-7
- Modifying configuration database, *IV*: 4-44
- MON2 command, *IV*: 6-12

Motherboard
 shelf B, *IV*: 2-24
 shelf C, *IV*: 2-24
 system reset signal, *IV*: 2-24

Motherboard assembly
 diagram, *IV*: 9-36
 replacement, *IV*: 9-36 to 9-45

Moves, adds, changes, *IV*: 7-43 to 7-49

Moving the equipment on-site, *IV*: 4-3

MPURGE Command, *IV*: 6-58

Multilocation networking, INSTALL program,
IV: 1-14

Multiple network outcalls
 networking, *VI*: 2-2
 remote analog networking, *VI*: 2.1-3

Multiple network prefixes per location, *VI*: 2.1-34

Multipoint outcalling
 networking, *VI*: 2-2
 remote analog networking, *VI*: 2.1-3
 secondary entries, collocated analog networking,
VI: 5-31

MWI. *See* Message Waiting Indication

MWLRECALC command, *IV*: 6-12

MWOFF command, *IV*: 6-12

MWRELITE command, *IV*: 6-12

MX mode. *See* Message Center

N

Name retrieval, network, *VI*: 2.1-21

NameNet
 digital networking, *VI*: 3-18
 alphanumeric (ASCII) name propagation,
 VI: 3-18
 alphanumeric (ASCII) name verification,
 VI: 3-18 to 3-21
 OctelNet, *VI*: 2.1-21 to 2.1-22

Names Directory. *See* Dial-by-Name

Names propagation, network, *VI*: 2.1-22

Namesend activity trace log, *IV*: 7-40

NAMESEND command, digital networking,
VI: 3-14

Namesend feature, digital networking,
VI: 3-12 to 3-17
 configuration, *VI*: 3-12 to 3-14

NAMESTAT command, digital networking,
VI: 3-50

NEAX-2400 Adaptive Integration, *V*: 5-1 to 5-17
 application delays, *V*: 5-8
 Called Party Identification, *V*: 5-2
 data link, *V*: 5-9

installation, *V*: 5-9
 checklist, *V*: 5-14
 limitations, *V*: 5-3
 MCI call records, *V*: 5-11
 MCI operation, *V*: 5-1
 Message Center Interface, *V*: 5-1
 Message Waiting Indication, *V*: 5-1
 Overture 200/300 configuration, *V*: 5-6 to 5-8
 Called Party Identification, *V*: 5-7
 Message Waiting Indication, *V*: 5-6
 PBX configuration, *V*: 5-4 to 5-5
 extension requirements, *V*: 5-4
 MCI feature, *V*: 5-4
 NEAX-2400 line cards, *V*: 5-4

NEC Adaptive Integration. *See* NEAX-2400 Adaptive
 Integration

NETNAM DELETE command, Network Name
 Confirmation, *VI*: 4-6

NETNAM LIST command, Network Name
 Confirmation, *VI*: 4-3

NETNAM program, Network Name
 Confirmation, *VI*: 4-3

NETNAM RENUM command, Network Name
 Confirmation, *VI*: 4-6

NETNAM UPDATE command, Network Name
 Confirmation, *VI*: 4-4

NETNAM UPDATE commands, Network Name
 Confirmation, *VI*: 4-5

Network error types and remedies, digital networking,
VI: 3-52

Network Failure Table, *VI*: 2.1-77, 3-51
 CLEAR command, *IV*: 6-4

Network location name, NUMBERING PLAN Table,
VI: 6-3, 6-8, 6-12

Network mailbox length, *VI*: 6-9, 6-13
 NUMBERING PLAN Table, *VI*: 6-2, 6-3, 6-13

Network mailbox status, *IV*: 6-20

Network message delivery schedule, *VI*: 2.1-19

Network Name Confirmation, *VI*: 4-1 to 4-6
 automatic purge, *VI*: 4-1
 digital networking, *VI*: 4-2
 how to modify Network Names Table, *VI*: 4-3
 how to set up, *VI*: 4-1
 how to use Network Names table, *VI*: 4-3 to 4-6
 NETNAM DELETE command, *VI*: 4-6
 NETNAM LIST command, *VI*: 4-3
 NETNAM program, *VI*: 4-3
 NETNAM RENUM command, *VI*: 4-6
 NETNAM UPDATE command, *VI*: 4-4
 NETNAM UPDATE commands, *VI*: 4-5
 OctelNet, *VI*: 4-2
 Protocol 2, *VI*: 4-2

- Network Name Confirmation (continued)
 Protocol 3 networking, VI: 4-1
 wildcard characters, VI: 4-3
- Network name retrieval, VI: 2.1-21
- Network Names. *See Network Name Confirmation*
- Network operation
 collocated analog networking, VI: 2.2-3 to 2.2-5
 remote analog networking, VI: 2.1-23 to 2.1-102
- Network reports
 Digital Network Performance Report,
 IV: 5-13 to 5-16; VI: 3-66 to 3-69
 digital networking, VI: 3-63 to 3-69
 Network Traffic Report, digital information,
 VI: 3-63 to 3-65
- NETWORK SCHEDULE Table, VI: 8-1 to 8-7
 considerations when configuring, VI: 8-3
 how to configure, VI: 8-3
 how to use, VI: 8-2
 message delivery window, VI: 8-1
 message priority level, VI: 8-1
 non-overlapping window, VI: 8-3
 overlapping window, VI: 8-3
 using UPDATE, VI: 8-4
- Network summary information form, sample
 Protocol 2, VI: 2.1-38
 Protocol 4, VI: 2.1-39
 Protocol 5, VI: 2.1-40
 Protocols 1 and 3, VI: 2.1-37
- Network test, digital networking, VI: 3-43 to 3-46
 TEST LAN command, VI: 3-43 to 3-46
- Network Traffic Report, VI: 2.1-97
 digital information, VI: 3-63 to 3-65
- Networking, IV: 1-14
*See also AMIS; Collocated analog networking;
 Collocated digital networking; Digital
 networking; OctelNet; Remote analog
 networking; Remote digital networking;
 Voicenet*
- blocking live network calls, VI: 2.1-26
 configuring Network Schedule Table, VI: 2.1-58
 Digital, maintenance and troubleshooting
 CMD PING command, IV: 6-27
 DCSTAT command, IV: 6-25
 FINDMBOX command, IV: 6-24
 LANSTAT command, IV: 6-23
 digital, VI: 3-1 to 3-69
 location activity log, IV: 7-15
 location test, IV: 6-5
 multiple network prefixes per location,
 VI: 2.1-34
 network traffic report, IV: 5-16 to 5-20
 overview, VI: 1-1 to 1-4
 AMIS analog, VI: 1-2
 analog, VI: 1-2 to 1-3
 collocated analog, VI: 1-2
 digital, VI: 1-4
 domain digital, VI: 1-4
 gateway, VI: 1-3
 OctelNet analog, VI: 1-3
 remote digital, VI: 1-4
 Voicenet analog, VI: 1-2
 protocol 2, INSTALL program, IV: 1-15
 protocol 4, INSTALL program, IV: 1-15
 protocols 1 and 3, INSTALL program, IV: 1-15
 redundancy for network messages,
 VI: 2.1-3, 3-10
 spoken node name for network failure messages,
 VI: 2.1-35
- Night mode, IV: 3-14
- Node name, spoken for network failure messages,
 VI: 2.1-35
- Northern Telecom Adaptive Integration with NPIC,
 V: 13-1 to 13-30
 Called Party Identification, V: 13-2
 direct calls from external trunks, V: 13-2
 direct internal call, V: 13-3
 forwarded external calls (RNA or busy),
 V: 13-2
 forwarded internal calls, V: 13-4
 hardware requirements, V: 13-5
 installation, V: 13-1 to 13-30
 PBX configuration, V: 13-6 to 13-14
 customer datablock, V: 13-6, 13-7
 customer telephones, V: 13-11
 incoming trunks, V: 13-6
 PBX requirements, V: 13-5
 software requirements, V: 13-5
- Northern Telecom SL-1 Integration Card (SLIC),
 IV: 2-21
- NPIC
*See also Northern Telecom Adaptive Integration
 with NPIC; Serial Integration Card*
 pin assignment, IV: 4-24
- Number of digits to strip, NUMBERING PLAN
 Table, VI: 6-3, 6-9, 6-13
- Number of digits to strip from self, NUMBERING
 PLAN Table, VI: 6-3, 6-9, 6-13
- Numbering plan problems, digital networking,
 VI: 3-62
- NUMBERING PLAN Table, IV: 1-15;
 VI: 6-1 to 6-15
 collocated analog networking, VI: 2.2-11 to 2.2-14,
 6-12 to 6-15
 how it is used, VI: 6-12
 how to configure, VI: 6-12
 initial digits expected, VI: 6-13
 network location name, VI: 6-12
 network mailbox length, VI: 6-13

NUMBERING PLAN Table (continued)

- number of digits to strip, VI: 6-13
- number of digits to strip from self, VI: 6-13
- using INSTALL, VI: 6-13
- using UPDATE, VI: 6-13

digital networking, VI: 3-8, 3-41, 6-8 to 6-11

- ADD command, VI: 3-41
- how it is used, VI: 6-8
- how to configure, VI: 6-8
- initial digits expected, VI: 6-8
- network location name, VI: 6-8
- network mailbox length, VI: 6-9
- number of digits to strip, VI: 6-9
- number of digits to strip from self, VI: 6-9
- using INSTALL, VI: 6-9
- using UPDATE, VI: 6-9

remote analog networking, VI: 6-2 to 6-7

- how it is used, VI: 6-2
- how to configure, VI: 6-2
- initial digits expected, VI: 6-3
- network location name, VI: 6-3
- network mailbox length, VI: 6-3
- number of digits to strip, VI: 6-3
- number of digits to strip from self, VI: 6-3
- using INSTALL, VI: 6-4
- using UPDATE, VI: 6-4

NUMBERING PLAN Table form

- collocated analog networking, VI: 2.2-12
 - initial digits, VI: 2.2-14
 - location name, VI: 2.2-14
 - network mailbox length, VI: 2.2-14
 - number of digits to strip, VI: 2.2-14
 - number of digits to strip from SELF, VI: 2.2-14
 - sample, VI: 2.2-13
- remote analog networking, VI: 2.1-54 to 2.1-59
 - initial digits, VI: 2.1-57
 - location name, VI: 2.1-57
 - network mailbox length, VI: 2.1-57
 - number of digits to strip, VI: 2.1-57
 - number of digits to strip from SELF, VI: 2.1-58
- sample, remote analog networking, VI: 2.1-56

O

OCC. *See Option Control Chip*

Octel Private MIB, IV: 11C-1 to 11C-13

- listing, IV: 11C-2
- sample session for obtaining from Internet, IV: 11C-1

Octel supplied password, IV: 4-35

OctelAccess Server

- exportnames command, IV: 6-9
- GWLSTAT command, IV: 6-10
- log, server activity trace, IV: 7-50

OctelNet, VI: 2.1-2

- See also Remote analog networking, OctelNet; Remote analog networking, Protocol 5*
- embed autocopy, VI: 2.1-54, 5-6
- embedded name, VI: 2.1-53, 5-6
- fax feature, VI: 2.1-16
- SELF OctelNet serial number, VI: 2.1-54
- serial number, VI: 2.1-53, 5-6
- system mailbox, COS attributes, VI: 2.1-34

OctelNet analog networking. *See Protocol 5*

Offsite

- dial system parameter digits index, INSTALL program, IV: 1-22
- end with sysp digits, INSTALL program, IV: 1-22
- prefix digits index, INSTALL program, IV: 1-21
- speak delay index, INSTALL program, IV: 1-21
- speak times index, INSTALL program, IV: 1-21

Operating Line Voltage, IV: 4-3

Operating system, command, IV: 4-35

Option control chip, IV: 2-24, 12-2

- replacement, IV: 9-53 to 9-56

Outcalling. *See Message waiting notification*

Overlapping mailbox addresses and network prefixes, VI: 2.1-7

Overtemperature protection, IV: 2-23

Overture 200, Motherboard, IV: 2-23

Overture 300

- Motherboard, IV: 2-23
- rack mounting, IV: 4-40 to 4-43

P

Part numbers

- Octel Overture 200 components, IV: 9-56
- Octel Overture 200/300 components, IV: 9-57
- Octel Overture 300 components, IV: 9-56

Pass/fail, installation checklist, IV: 4-60

Password, default, IV: 6-12

PASSWORD command, IV: 6-12

Patch, command, IV: 6-13

PBX database changes. *See Preparing the Phone System*

PBX integration

- See also Adaptive Integration; AT&T System 75 Adaptive Integration; AT&T System 85 Adaptive Integration; Centrex Adaptive Integration; Enhanced DTMF In-band Integration; ITT 3100 Adaptive Integration; Meridian 1 Adaptive Integration; Mitel SX-100/SX-200 Analog Adaptive Integration; Mitel SX-2000 Adaptive Integration; NEAX-2400 Adaptive Integration*

PBX Integration (continued)

NPIC; ROLM Adaptive Integration; SL-1 Adaptive Integration

Adaptive Integration, *V: 1-1, 2-1 to 2-11*

enhanced DTMF in-band, *V: 2-3*

Overture 200/300 proprietary card, *V: 2-5*

RS-232C data link, *V: 2-4*

standard DTMF, *V: 1-1, 1-2*

System 85/APIC. *See AT&T System 75 Adaptive Integration*

PBX preparation

See also Preparing the Phone System

installation checklist, *IV: 4-59*

PCA. *See Line interface card; Printed circuit assembly*

Phantom number, *IV: 3-9*

Phone system

changes, *IV: 3-5, 3-8 to 3-11*

InWATS service, *IV: 3-6*

trunk hunting group, *IV: 3-6*

trunking, *IV: 3-6*

how the Overture 200/300 works with,
IV: 3-1 to 3-4

how the Voice system works with, *IV: 3-1 to 3-4*

InWATS service, *IV: 3-6*

ports, *IV: 3-8*

preparing, *IV: 3-1 to 3-15*

service provider letter, sample, *IV: 3-11*

survey, *IV: 3-5*

without DIL feature, *IV: 3-12*

PIC

AT&T, *IV: 2-21*

Northern Telecom Meridian 1 and SL-1,
IV: 2-21

Pin assignments, *IV: 4-21 to 4-34*

APIC, *IV: 4-30*

AT&T integration card, *IV: 4-28*

DAC I/O panel EP EXT connector, *IV: 4-33*

DAC I/O panel power connector, *IV: 4-33*

Digital Trunk Interface Card (DTIC), *IV: 4-26*

Direct Access Card, *IV: 4-32*

DLC16, *IV: 4-24*

external alarm port J5, *IV: 4-34*

ILC12, *IV: 4-25*

international line interface card, *IV: 4-25*

line interface card, *IV: 4-22, 4-23*

Mitel integration card, *IV: 4-22*

Northern Telecom SL-1 integration card,
IV: 4-27

NPIC, *IV: 4-24*

ROLM integration card, *IV: 4-22*

Serial Integration Card (SIC8), Meridian 1,
IV: 4-29

SIC8 I/O, *IV: 4-31*

telemarketing line card, *IV: 4-23*

Planning

collocated analog networking, *VI: 2.2-1 to 2.2-2*

digital networking, *VI: 3-21 to 3-24*

remote analog networking, *VI: 2.1-4 to 2.1-20*

Port

busy test, *IV: 4-54*

configuration status, *IV: 6-27, 6-28*

configuring, *IV: 3-8*

extension, *IV: 3-8*

LIST command, *IV: 6-27*

PRTMAP command, *IV: 6-28*

ring-no-answer test, *IV: 4-54*

statistics report, *IV: 5-27 to 5-30*

status command, *IV: 6-15*

status diagnostic test, *IV: 6-34*

Port extension, test, *IV: 4-51*

Port INFORMATION Table, *IV: 1-18*

Ports, capacity on demand, list feature screen,
IV: 6-41

Power failure, *IV: 1-9, 2-1*

Power filter assembly, replacement,
IV: 9-50 to 9-51

Power line filter, Overture 300, *IV: 2-8*

Power requirements, *IV: 4-4, 4-8*

Power supply, fuse, *IV: 9-33*

Power supply conversion, AC to DC conversion,
IV: 9-51 to 9-53

Power supply fuse, remove, replace, *IV: 9-33*

Power Supply Unit, *IV: 2-22*

input voltage, *IV: 2-22*

overtemperature protection, *IV: 2-23*

system power fail signal, *IV: 2-23*

system reset signal, *IV: 2-23*

Power supply unit, *IV: 4-10*

replacement, *IV: 9-30 to 9-33*

Power up, *IV: 4-37*

Pre-installation, installation checklist, *IV: 4-58*

PREFIX DIGITS Table, Centrex installations,
V: 4-9

Preventive maintenance, *IV: 9-1 to 9-11*

Primary answering mode, port, *IV: 3-3*

Print Tone, command, *IV: 6-14*

Printed circuit assembly

installation, *IV: 9-13*

replacement, *IV: 9-12 to 9-14*

Private MIB, SNMP, *IV: 11B-3 to 11B-6*

Procedures, *IV: 12-1 to 12-77*

backup, *IV: 12-3 to 12-21*

all messages, *IV: 12-4*

all names, *IV: 12-6*

greetings by COS, *IV: 12-12*

language prompts, *IV: 12-20*

Procedures (continued)

- local names, *IV*: 12-8
- network names, *IV*: 12-10
- personal distribution list names, *IV*: 12-18
- scripted or sequential mailbox, *IV*: 12-16
- single greeting, *IV*: 12-14
- errors, during backup and restore, *IV*: 12-40
- hard disk drive, *IV*: 12-41 to 12-70
 - add, *IV*: 12-45
 - commands, *IV*: 12-41 to 12-77
 - DISKO, *IV*: 12-43
 - DSKMAP, *IV*: 12-41
 - DSKTST, *IV*: 12-42
 - remove, *IV*: 12-51
 - replace, *IV*: 12-54
 - restore, *IV*: 12-58
- languages, upgrade, *IV*: 12-72 to 12-77
- restore
 - all messages, *IV*: 12-23
 - all names, *IV*: 12-25
 - greeting to different mailbox, *IV*: 12-34
 - language prompts, *IV*: 12-37
 - adding, *IV*: 12-76
 - local names, *IV*: 12-27
 - name to different mailbox, *IV*: 12-29
 - network names, *IV*: 12-31
 - personal distribution list names, *IV*: 12-36
 - scripted or sequential mailbox, *IV*: 12-35
 - single greeting, *IV*: 12-33
- Prompts
 - expanding disk space for, *IV*: 12-72
 - system maintenance, *IV*: 4-35
- Protocol 4. *See AMIS analog networking; Remote analog networking, AMIS*
- Protocol 5. *See OctelNet; Remote analog networking, Protocol 5*
- Protocols, analog networking, *VI*: 2-3 to 2-5
- Protocols 1, 2, and 3. *See Remote analog networking; Voicenet*
- PSU. *See Power Supply Unit*
- Purge messages, *IV*: 6-56 to 6-60

Q

- Quick greeting activation index, INSTALL program, *IV*: 1-22

R

Rack mounting

- considerations, *IV*: 4-41
- Overture 300, *IV*: 4-40
- preinstallation, *IV*: 4-41

- Range numbering, mailbox, *IV*: 1-6
- Real-time name problems, digital networking, *VI*: 3-62
- Receiving the equipment, *IV*: 4-1 to 4-3
 - installation checklist, *IV*: 4-58
- Redundancy for network messages, *VI*: 2.1-3
 - networking, *VI*: 3-10
- Reinstallation, *IV*: 1-4
- Remote analog networking, *VI*: 2.1-1 to 2.1-102
 - See also AMIS analog networking; OctelNet; Voicenet*
 - AMIS, *VI*: 2.1-1
 - message length, *VI*: 2.1-14
 - self system number, *VI*: 2.1-52
 - system number, *VI*: 2.1-14, 2.1-52
 - use pub/pvt number, *VI*: 2.1-52
 - call processing flow, *VI*: 2.1-26 to 2.1-42
 - completing configuration forms, *VI*: 2.1-33
 - configuration, *VI*: 2.1-33 to 2.1-66
 - COS attributes, *VI*: 2.1-64 to 2.1-67
 - Protocol 2, *VI*: 2.1-65
 - Protocol 4, *VI*: 2.1-66
 - Protocols 1 and 3, *VI*: 2.1-65
 - DATA to DTMF translations, *VI*: 2.1-84
 - diagnostic tools, *VI*: 2.1-75
 - example, *VI*: 2.1-23
 - gateway, *VI*: 2.1-1
 - Protocols 2, 4, and 5, *VI*: 2.1-16 to 2.1-18
 - interrelationships of tables, *VI*: 2.1-32
 - LIST HE command, *VI*: 2.1-76
 - LIST NET command, *VI*: 2.1-75
 - LIST NF command, *VI*: 2.1-77
 - LIST REPORT command, *VI*: 2.1-97
 - location code, *VI*: 2.1-5
 - LOCATION Table, *VI*: 2.1-44 to 2.1-54, 5-2 to 5-16
 - LOCATION Table form
 - sample for Protocol 2, *VI*: 2.1-47
 - sample for Protocol 4, *VI*: 2.1-48
 - sample for Protocol 5, *VI*: 2.1-49
 - sample for Protocols 1 and 3, *VI*: 2.1-46
 - locations with different length mailboxes, *VI*: 2.1-7
 - maintenance and troubleshooting, *VI*: 2.1-75 to 2.1-102
 - messaging flow, *VI*: 2.1-28 to 2.1-42
 - multiple network outcalls, *VI*: 2.1-3
 - NameNet for OctelNet, *VI*: 2.1-21 to 2.1-22
 - network error reasons, Protocol 2, *VI*: 2.1-81
 - network error types and remedies
 - Protocol 2, *VI*: 2.1-78
 - Protocol 4, *VI*: 2.1-81
 - Protocol 5, *VI*: 2.1-83
 - Network Failure Table, *VI*: 2.1-77
 - network traffic report, *VI*: 2.1-67

- Remote analog networking (continued)
 - numbering plan, *VI: 2.1-5 to 2.1-11*
 - NUMBERING PLAN Table, *VI: 6-2 to 6-7*
 - NUMBERING PLAN Table form, *VI: 2.1-54 to 2.1-59*
 - sample, *VI: 2.1-56*
 - OctelNet, *VI: 2.1-2*
 - alphabetic (ASCII) name, *VI: 2.1-21 to 2.1-22*
 - COS attributes, for OctelNet system mailbox, *VI: 2.1-34*
 - embed autocopy, *VI: 2.1-54*
 - embedded name, *VI: 2.1-53*
 - fax feature, *VI: 2.1-16*
 - SELF OctelNet serial number, *VI: 2.1-54*
 - serial number, *VI: 2.1-53*
 - troubleshooting, *VI: 2.1-93*
 - operation, *VI: 2.1-23 to 2.1-102*
 - planning, *VI: 2.1-4 to 2.1-20*
 - all protocols, *VI: 2.1-4 to 2.1-20*
 - for off-network extensions, *VI: 2.1-19*
 - Protocol 2 (with VMX 5000/1000), *VI: 2.1-4, 2.1-12 to 2.1-13*
 - Protocol 4 (AMIS), *VI: 2.1-4, 2.1-13 to 2.1-14*
 - Protocol 5 (OctelNet), *VI: 2.1-4, 2.1-15 to 2.1-16*
 - Protocol 2 (with VMX 5000/1000)
 - mailbox ID, *VI: 2.1-13*
 - message length, *VI: 2.1-13*
 - Network Deferred mailbox, *VI: 2.1-13*
 - Network Priority mailbox, *VI: 2.1-13*
 - remote node ID, *VI: 2.1-13*
 - Protocol 4 (AMIS)
 - message length, *VI: 2.1-14*
 - self system number, *VI: 2.1-52*
 - system number, *VI: 2.1-14, 2.1-52*
 - use pub/pvt number, *VI: 2.1-52*
 - Protocol 5 (OctelNet)
 - embed autocopy, *VI: 2.1-54*
 - embedded name, *VI: 2.1-53*
 - fax feature, *VI: 2.1-16*
 - message length, *VI: 2.1-15*
 - SELF OctelNet serial number, *VI: 2.1-54*
 - serial number, *VI: 2.1-15, 2.1-53*
 - system mailbox, COS attributes, *VI: 2.1-34*
 - protocols, *VI: 2.1-3*
 - ROUTE Table, *VI: 7-2*
 - ROUTE Table form, *VI: 2.1-41 to 2.1-44*
 - sample, *VI: 2.1-42*
 - routing plan, *VI: 2.1-11*
 - summary information form, *VI: 2.1-36*
 - Protocol 2, *VI: 2.1-38*
 - Protocol 4, *VI: 2.1-39*
 - Protocol 5, *VI: 2.1-40*
 - Protocols 1 and 3, *VI: 2.1-37*
 - system parameters
 - all protocols, *VI: 2.1-59 to 2.1-64*
 - Protocol 2, *VI: 2.1-62*
 - Protocol 4, *VI: 2.1-62*
 - Protocol 5, *VI: 2.1-63*
 - TEST NET, messages and descriptions, *VI: 2.1-69*
 - TEST NET command, *VI: 2.1-67*
 - testing, *VI: 2.1-67 to 2.1-102*
 - Protocol 2, *VI: 2.1-72*
 - Protocol 4, *VI: 2.1-73 to 2.1-75*
 - Protocols 1, 3, and 5, *VI: 2.1-67 to 2.1-71*
 - traffic pegs, *VI: 2.1-85 to 2.1-89*
 - traffic report, *VI: 2.1-97 to 2.1-102*
 - feature use totals, *VI: 2.1-102*
 - message delivery, *VI: 2.1-100*
 - names directory, *VI: 2.1-100*
 - network schedule, *VI: 2.1-101*
 - network access totals, *VI: 2.1-101*
 - to location, *VI: 2.1-99*
 - troubleshooting dropped calls, *VI: 2.1-90*
 - troubleshooting network message failures, *VI: 2.1-91*
 - verification diagnostic, TEST NET command, *VI: 2.1-67*
 - Voicenet, *VI: 2.1-1*
- Remote location code, *VI: 2.1-5*
 - Remote networking, INSTALL program, *IV: 1-14*
 - Remove
 - AC subassemblies, *IV: 9-52, 9-53*
 - air filter, *IV: 9-35*
 - digital trunk interface card, *IV: 9-19*
 - disk drive backplane, *IV: 9-47*
 - fan panel, *IV: 9-34*
 - fan tray, *IV: 9-34*
 - fax application processor, *IV: 9-24*
 - floppy disk drive, *IV: 9-29*
 - hard disk drive, *IV: 9-27*
 - integration card, *IV: 9-16*
 - LAN card, *IV: 9-17*
 - line interface card, *IV: 9-14*
 - load resistor assembly, *IV: 9-49*
 - motherboard assembly, *IV: 9-37, 9-39*
 - option control chip, *IV: 9-55*
 - power filter assembly, *IV: 9-50*
 - power supply unit, *IV: 9-31*
 - Reports, *IV: 5-2 to 5-37*
 - CLEAR command, *IV: 6-4*
 - clearing, *IV: 5-4*
 - Digital Network Performance Report, *IV: 5-13 to 5-16; VI: 3-66 to 3-69*
 - digital networking, *VI: 3-63 to 3-69*
 - disk usage, *IV: 5-25 to 5-26*

- Reports (continued)
- incoming call, call processing, *IV*: 5-23
 - integration calling statistics, *IV*: 5-33 to 5-34
 - listing, *IV*: 5-2
 - mailbox usage, *IV*: 5-31
 - network traffic, *IV*: 5-16 to 5-20
 - Network Traffic Report, digital information, *VI*: 3-63 to 3-65
 - password, *IV*: 6-13
 - port statistics, *IV*: 5-27 to 5-30
 - remote analog networking, Network Traffic Report, *VI*: 2.1-97 to 2.1-102
 - system performance, *IV*: 5-5 to 5-15
 - system performance by COS, *IV*: 5-35 to 5-37
 - user calling statistics, *IV*: 5-23 to 5-24
 - user message statistics, *IV*: 5-21 to 5-22
 - user statistics, *IV*: 5-3
 - user status detail, *IV*: 5-32
- Reshipping procedures, *IV*: 4-2
- RESTART command, *IV*: 6-15
- Restore
- all messages, *IV*: 12-23
 - all names, *IV*: 12-25
 - command. *See Procedures*
 - greeting to different mailbox, *IV*: 12-34
 - language prompts, *IV*: 12-37
 - adding, *IV*: 12-76
 - local names, *IV*: 12-27
 - name to different mailbox, *IV*: 12-29
 - network names, *IV*: 12-31
 - personal distribution list names, *IV*: 12-36
 - scripted or sequential mailbox, *IV*: 12-35
 - single greeting, *IV*: 12-33
- Restore procedures, *IV*: 12-22 to 12-38
- RIC. *See ROLM Adaptive Integration; ROLM Integration Card*
- Ring-no-answer, test, *IV*: 4-52
- Ring-through diagnostic test, *IV*: 6-33
- Ringback, *IV*: 1-26
- ROLM 9751 Adaptive Integration, *V*: 8.2-1 to 8.2-35
- ROLM 9751 Adaptive Integration
- Called Party Identification
 - direct internal call, *V*: 8.2-3
 - forwarded external calls (RNA or Busy), *V*: 8.2-2
 - forwarded internal calls, *V*: 8.2-3
 - hardware requirements, *V*: 8.2-4
 - installation checklist, *V*: 8.2-33 to 8.2-35
 - maintenance commands, *V*: 8.2-30
 - Overture 200/300, Called Party Identification, *V*: 8.2-14
 - Overture 200/300 configuration, *V*: 8.2-13 to 8.2-35
 - Message Waiting Indication, *V*: 8.2-13
 - PBX configuration, customer telephones, *V*: 8.2-11
 - RIC board installation, *V*: 8.2-28
 - software requirements, *V*: 8.2-5
 - testing procedure, *V*: 8.2-16 to 8.2-35
- ROLM Adaptive Integration, *V*: 8.1-1 to 8.1-38
- Called Party Identification
 - direct calls from external trunks, *V*: 8.1-2, 8.2-2
 - direct internal call, *V*: 8.1-3
 - forwarded external calls (RNA or Busy), *V*: 8.1-2
 - forwarded internal calls, *V*: 8.1-3
 - hardware requirements, *V*: 8.1-4
 - installation checklist, *V*: 8.1-36 to 8.1-38
 - maintenance commands, *V*: 8.1-33
 - Overture 200/300 configuration, *V*: 8.1-12 to 8.1-38
 - Called Party Identification, *V*: 8.1-12
 - Message Waiting Indication, *V*: 8.1-12
 - PBX configuration
 - customer telephones, *V*: 8.1-11
 - incoming trunks, *V*: 8.1-5
 - port extensions, *V*: 8.1-5
 - RIC display phone extensions, *V*: 8.1-6
 - RIC board installation, *V*: 8.1-30
 - software requirements, *V*: 8.1-4
 - testing procedure, *V*: 8.1-15 to 8.1-38
- ROLM Integration Card, *IV*: 2-21
- ROLM Model 30/80. *See ROLM 9751*
- ROLM Model 30/80 CBX requirements, *V*: 8.2-4
- ROLM Model 30/80 configuration, *V*: 8.2-6
- Round trip time for message waiting
- clearing, *IV*: 6-4
 - listing, *IV*: 6-3
- ROUTE Table, *IV*: 1-15; *VI*: 7-1 to 7-7
- collocated analog networking, *VI*: 2.2-6 to 2.2-9, 7-5 to 7-7
 - digits dialed, *VI*: 7-5
 - drop, *VI*: 7-5
 - how it is used, *VI*: 7-5
 - how to configure, *VI*: 7-5
 - route name, *VI*: 7-5
 - using INSTALL, *VI*: 7-6
 - using UPDATE, *VI*: 7-6
 - overview, *VI*: 7-1
 - remote analog networking, *VI*: 2.1-41 to 2.1-44, 7-2 to 7-4
 - D character, *VI*: 2.1-41
 - DDD, *VI*: 7-3

ROUTE Table (continued)

- digits dialed, *VI: 7-2*
- drop, *VI: 7-2*
- E character, *VI: 2.1-41*
- how it is used, *VI: 7-2*
- how to configure, *VI: 7-2*
- N character, *VI: 2.1-41*
- P character, *VI: 2.1-41*
- route name, *VI: 7-2*
- SPRINT, *VI: 2.1-41, 7-3*
- T character, *VI: 2.1-41*
- using INSTALL, *VI: 7-3*
- using UPDATE, *VI: 7-3*
- WATS, *VI: 2.1-41, 7-3*

ROUTE Table form

- Collocated analog networking, *VI: 2.2-6*
- collocated analog networking
 - can drop, *VI: 2.2-9*
 - D character, *VI: 2.2-7*
 - digits dialed, *VI: 2.2-9*
 - E character, *VI: 2.2-7*
 - N character, *VI: 2.2-7*
 - P character, *VI: 2.2-7*
 - route name, *VI: 2.2-9*
 - sample, *VI: 2.2-8*
 - T character, *VI: 2.2-7*
- remote analog networking
 - DDD, *VI: 2.1-43*
 - digits dialed, *VI: 2.1-43*
 - drop, *VI: 2.1-43*
 - route name, *VI: 2.1-43*
 - SPRINT, *VI: 2.1-43*
 - WATS, *VI: 2.1-43*
- sample, remote analog networking, *VI: 2.1-42*
- RS-232C, *IV: 4-14, 4-16, 4-35*
 - cable length, *IV: 4-16*
 - Centrex, *IV: 6-12*
 - integration error, *IV: 8-9*
- RS-232C, *IV: 2-2*
 - connector, *IV: 2-7*

S

- SAT log. *See* Server Activity Trace log
- SCHEDULE Table, *IV: 1-17*
- SDBG command, *IV: 6-15*
- Secondary location, LOCATION Table, remote analog networking, *VI: 5-16*
- Serenade Domain DigitalNetworking. *See* Domain Digital Networking
- Serial Integration Card, Meridian 1, *IV: 2-21*
- Serial number, INSTALL program, *IV: 1-8*

Serial ports

- first, *IV: 2-22*
- fourth, *IV: 2-22*
- second, *IV: 2-22*
- third, *IV: 2-22*
- Server Activity Trace log, *IV: 7-50*
- Shelf B Motherboard, *IV: 2-24*
- Shelf C Motherboard, *IV: 2-24*
- Shutdown, *IV: 6-6*
- SIC8. *See Meridian 1 Adaptive Integration; Serial Integration Card*
- Simple Network Management Protocol, *IV: 11-3, 11B-1 to 11B-12; VI: 3-38*
See also SNMP
- Single Digit Menus, INSTALL program, *IV: 1-20*
- Site requirements, *IV: 4-4*
- SL-1 Adaptive Integration, *V: 6-1 to 6-44*
 - Called Party Identification, *V: 6-2*
 - direct calls from external trunks, *V: 6-2*
 - direct internal call, *V: 6-3*
 - forwarded external calls (RNA or busy), *V: 6-2*
 - forwarded internal calls, *V: 6-3*
 - hardware requirements, *V: 6-4*
 - installation checklist, *V: 6-38 to 6-44*
 - maintenance commands, *V: 6-35*
 - Message Waiting Indication, *V: 6-1*
 - Overture 200/300 configuration, *V: 6-15 to 6-17*
 - Called Party Identification, *V: 6-15*
 - Message Waiting Indication, *V: 6-15*
 - SL-1 configuration
 - customer datablock, *V: 6-6*
 - customer telephones, *V: 6-13*
 - incoming trunks, *V: 6-6*
 - Overture 200/300 port extensions, *V: 6-7*
 - SLIC link digit display telephone extensions, *V: 6-8*
 - terminal hunt group, *V: 6-4*
 - SL-1 digit display set keyboard layout, *V: 6-8*
 - SLIC board installation, *V: 6-32*
 - software requirements, *V: 6-5*
 - testing, *V: 6-18*
 - testing procedure, *V: 6-19 to 6-38*
- SLIC. *See Northern Telecom SL-1 Integration Card; SL-1 Adaptive Integration*
- SLOTS Table
 - adding a DTIC card, *IV: 10-7*
 - DTIC cards, *IV: 10-5*
 - answering mode, *IV: 10-6*
 - card type, *IV: 10-5*
 - Class of Service, *IV: 10-5*
 - extension #, *IV: 10-5*
 - LSPTAB, *IV: 10-7*

- SLOTS Table (continued)
- outcall, *IV*: 10-6
 - port, *IV*: 10-5
 - slot, *IV*: 10-5
 - SYNC, *IV*: 10-6
 - SYS, *IV*: 10-6
 - LAN card, *IV*: 11-2
 - outcall
 - integrated systems, *IV*: 10-6
 - nonintegrated systems, *IV*: 10-6
 - SMDI. *See Centrex Adaptive Integration*
 - SMSI. *See Centrex Adaptive Integration*
 - SNMP, *IV*: 11-3, 11B-1 to 11B-12; *VI*: 3-23, 3-38
 - See also Simple Network Management Protocol*
 - basic MIB, *IV*: 11B-2
 - CONFIG, *IV*: 11B-3
 - configuring, *IV*: 11B-7 to 11B-9
 - digital networking, system parameters, *IV*: 11-3; *VI*: 3-38
 - DNETSTAT, *IV*: 11B-5
 - HWERRTABLE, *IV*: 11B-5
 - Internet MIB-II standard, *IV*: 11B-2
 - LOCTABLE, *IV*: 11B-4
 - private MIB, *IV*: 11B-3 to 11B-6
 - Private MIB information refresh, *IV*: 11B-6
 - Query tracing, *IV*: 11B-6
 - TEST SNMP command, *IV*: 11B-11 to 11B-12
 - messages, *IV*: 11B-11
 - trap, Hardware Error Table entries for, *IV*: 11B-10
 - trap CP trace, example, *IV*: 11B-10
 - trap notification, *IV*: 11B-7
 - trap report, example, *IV*: 11B-9
 - traps, *IV*: 11B-7 to 11B-12
 - SNMP manager system, test, communication with, *IV*: 6-6
 - Software installation, *IV*: 4-44
 - Software requirements, MD110, *V*: 14-8
 - Split incoming lines, *IV*: 3-4
 - Splitting trunk groups, *IV*: 3-6
 - Spoken node name, for network failure messages, *VI*: 2.1-35
 - SPRINT, *VI*: 7-2
 - Standard DTMF integration, *V*: 1-1 to 1-4
 - Called Party Identification, *V*: 1-2
 - Message Waiting Indication, *V*: 1-2
 - Overture 200/300 / PBX interaction, *V*: 1-3 to 1-4
 - primary and secondary answering, *V*: 1-3
 - secondary answering only, *V*: 1-4
 - Startup, *IV*: 6-6
 - Status, Octel Overture message server, test, *IV*: 6-5
 - Storage, call processing trace logs, *IV*: 7-5
 - Storage hours, capacity on demand, list feature screen, *IV*: 6-41
 - Subnet addresses, digital networking, *IV*: 11A-3
 - Subnet masks, digital networking, *IV*: 11A-4
 - using UPDATE, *VI*: 3-25
 - Subsystem, configurations, *IV*: 2-14 to 2-18
 - Subsystems, *IV*: 2-14 to 2-18
 - additional
 - Overture 300 fan tray, *IV*: 2-9
 - Overture 300 power line filter, *IV*: 2-8
 - system alarm relays, *IV*: 2-1
 - system terminal port, *IV*: 2-1
 - System
 - configuration, *IV*: 4-44
 - forwarding diagnostic test, *IV*: 6-39
 - hardware, *IV*: 4-37 to 4-39
 - initialization diagnostic test, *IV*: 6-39
 - installation, *IV*: 4-41
 - performance report, *IV*: 5-5 to 5-15
 - performance report by COS, *IV*: 5-35 to 5-37
 - removal, *IV*: 4-42
 - serial number, *IV*: 8-37
 - software, *IV*: 4-44
 - startup process, *IV*: 4-38
 - TEST STATUS command, *IV*: 6-40
 - System alarm relays, *IV*: 2-1
 - SYSTEM PARAMETER Table, digital networking, *VI*: 3-34 to 3-38
 - System Parameters, LAN card, *IV*: 11-3
 - System parameters
 - collocated analog networking, *VI*: 2.2-15
 - remote analog networking, *VI*: 2.1-59 to 2.1-64
 - System performance by COS report, *IV*: 5-35 to 5-37
 - System power fail signal, *IV*: 2-23
 - System reset signal, *IV*: 2-23, 2-24
 - System terminal port, *IV*: 2-1, 4-16
 - System/Voice disk drives, *IV*: 2-3, 2-9
 - System/Voice disks, *IV*: 2-25
- ## T
- Tandeming cases, digital networking, *VI*: 3-26 to 3-34
 - Telemarketing Line Card, *IV*: 2-19
 - Teleprinter, *IV*: 4-16
 - Terminal
 - cable. *See* RS-232C
 - cable length, *IV*: 4-16
 - installation, *IV*: 4-16
 - Overture 200/300 approved, *IV*: 4-16

- Terminal (continued)
 - specifications, *IV*: 4-16
 - system terminal port, *IV*: 4-16
- Terminal communications, *IV*: 4-16 to 4-20
 - automatic terminal logout, *IV*: 4-36
 - local access to system, *IV*: 4-35
 - remote access to system, *IV*: 4-36
- Test, *IV*: 4-50 to 4-57
 - busy extension, *IV*: 4-52
 - DC voltage, *IV*: 4-37
 - extension number, *IV*: 4-50
 - functional, *IV*: 4-51
 - hunt group, *IV*: 4-53
 - installation checklist, *IV*: 4-59
 - intercept extension, *IV*: 4-56
 - intercept position extension, *IV*: 4-51
 - message waiting, *IV*: 4-57
 - operational, *IV*: 4-50
 - port busy, *IV*: 4-54
 - port ring-no-answer, *IV*: 4-54
 - ring-no-answer, *IV*: 4-52
 - trunk verification, *IV*: 4-55, 4-56
- TEST command, *IV*: 6-4
 - alarm, *IV*: 6-4
 - alarm diagnostics, *IV*: 6-37
 - channel 1, *IV*: 6-39
 - channel 2, *IV*: 6-39
 - echo, *IV*: 6-4
 - fax loopback, *IV*: 6-6
 - floppy, *IV*: 6-5, 6-28 to 6-29
 - integration, *IV*: 6-6
 - LAN status, *IV*: 6-6
 - line 1, *IV*: 6-5, 6-32
 - line 2, *IV*: 6-5, 6-33
 - line 4, *IV*: 6-5, 6-33
 - line 5, *IV*: 6-5, 6-32
 - network, *IV*: 6-5
 - Overture status, *IV*: 6-5
 - SNMP manager system, communication with, *IV*: 6-6
 - status, *IV*: 6-40
- TEST LAN command
 - digital networking, *VI*: 3-43 to 3-46
 - messages and descriptions, *VI*: 3-44
- TEST NET command, remote analog networking, *VI*: 2.1-67
- TEST SNMP command, *IV*: 11B-11 to 11B-12
 - messages, *IV*: 11B-11 to 11B-12
- Testing
 - collocated analog networking, *VI*: 2.2-16
 - MD110 adaptive integration, *V*: 14-22, 15-7, 16-6
 - remote analog networking, *VI*: 2.1-67 to 2.1-102
- Testing procedure
 - AT&T Definity G3 Adaptive Integration, *V*: 7.1-32 to 7.1-38
 - AT&T System 75 Adaptive Integration, *V*: 7.2-32 to 7.2-38
 - AT&T System 85 Adaptive Integration, *V*: 7.3-28 to 7.3-34
 - Meridian 1 Adaptive Integration, *V*: 11-20 to 11-35
 - Mitel SX-2000 Adaptive Integration, *V*: 10.3-26 to 10.3-53
 - ROLM 9751 Adaptive Integration, *V*: 8.2-16 to 8.2-35
 - ROLM Adaptive Integration, *V*: 8.1-15 to 8.1-38
 - SL-1 Adaptive Integration, *V*: 6-19 to 6-38
- TIME command, *IV*: 6-15
- TLC. *See Telemarketing Line Card*
- touchtone-type telephone, *IV*: 3-2
- Traffic peg count table, *IV*: 5-5
- Traffic pegs, *IV*: 8-38 to 8-59
 - digital networking, *VI*: 3-56 to 3-59
 - LAN card, *IV*: 11-9 to 11-10
 - remote analog networking, *VI*: 2.1-85
- Traffic report, remote analog networking, *VI*: 2.1-97 to 2.1-102
- Troubleshooting
 - digital networking, *VI*: 3-47 to 3-63
 - CMD PING command, *IV*: 6-27
 - DCSTAT command, *IV*: 6-25
 - FINDMBOX command, *IV*: 6-24; *VI*: 3-48
 - installation problems, *VI*: 3-62
 - LAN network problems, *VI*: 3-62
 - LANSTAT command, *IV*: 6-23
 - LCSTAT command, *VI*: 3-49
 - LIST NET DOMAIN command, *VI*: 3-47
 - LOG command and Call Processing Trace, *VI*: 3-53
 - message delivery problems, *VI*: 3-61
 - NAMESEND command, *VI*: 3-14
 - NAMESTAT command, *VI*: 3-50
 - numbering plan problems, *VI*: 3-62
 - real-time name problems, *VI*: 3-62
 - summary of diagnostic commands, *VI*: 3-59 to 3-61
 - traffic pegs, *VI*: 3-56 to 3-59
 - DTIC, *IV*: 10-10 to 10-20
 - LAN card
 - CMD PING command, *IV*: 11-6
 - LANSTAT command, *IV*: 11-7
 - traffic pegs, *IV*: 11-9 to 11-10
 - remote analog networking
 - dropped calls, *VI*: 2.1-90

Troubleshooting (continued)
 network message failures, *VI*: 2.1-91 to 2.1-92
 OctelNet, *VI*: 2.1-93 to 2.1-99

Trunk, *IV*: 3-6
 installation checklist, *IV*: 4-60
 Overture 200/300 test, *IV*: 4-55
 redirection, *IV*: 3-9
 selection, *IV*: 3-10
 verification test, *IV*: 4-56

Trunk groups, splitting, *IV*: 3-6

Trunking, *IV*: 3-6

U

Uniform numbering plan
 collocated digital networking, *VI*: 3-3 to 3-9
 digital networking
 call processing features, *VI*: 3-10
 messaging features, *VI*: 3-10
 requirements for networking across servers in a
 UNP, *VI*: 3-11

Uninterruptible power supply, *IV*: 4-10

UNP. *See Uniform numbering plan*

Unpacking cabinet, *IV*: 4-1

UPDATE
 command, *IV*: 4-35, 4-44
 modifying configuration database, *IV*: 4-44
 program, *IV*: 4-44
 verifying configuration database, *IV*: 4-44

Upgrade languages, *IV*: 12-72 to 12-77

UPINTG command, *IV*: 6-16, 6-34

UPS. *See Uninterruptible power supply*

User calling statistics report, *IV*: 5-23 to 5-24

User message statistics report, *IV*: 5-21 to 5-22

User status detail report, *IV*: 5-32

USER Table, adding mailboxes
 auto-incrementing, *IV*: 1-6
 in ranges, *IV*: 1-6

V

VCU
 See also Voice Control Unit
 replacement, *IV*: 9-13

Verifying configuration database, *IV*: 4-44

Verifying the equipment, *IV*: 4-45

Voice, line interface card, *IV*: 6-32

Voice Control Unit, *IV*: 2-21

Voice disk drives, *IV*: 2-9

Voice storage disks, *IV*: 2-25

Voicenet, *VI*: 2.1-1
 See also Remote analog networking, Protocols 1, 2, and 3

Voicenet analog networking. *See Protocols 1, 2, and 3*

W

WATS, *VI*: 7-2

Wildcard characters, Network Name Confirmation,
 VI: 4-3

Works
 ACP card, *IV*: 2-19
 disk drive, shelf B, *IV*: 2-3, 2-9
 hard disk, *IV*: 2-25

Wrist grounding strap, *IV*: 9-1