





IMPORTANT NOTICES

-  Read the owner's manual thoroughly prior to assembly.
-  Be carefull not to misplace or lose small parts when unpacking.
-  Assembly must be performed by an adult with mechanical experience.
-  Do not allow more than one child to use this product at the same time.
-  Weight limit: 45 pounds (20 kilograms).
Additional warnings enclosed.

Questions?

Call us at 866-467-2967.



© 2002 Copyright Razor USA LLC. All rights reserved.
Specifications subject to change without notice.
Photos by Arthur Cambridge. Rev: 3/02

SPECIFICATIONS SUBJECT TO CHANGE

Razor USA LLC
Cerritos, California 90703
www.razor.com

Razor Jr. Scooter



Owner's Manual and Safety Handbook



Razor Jr. Owner's Manual

+ Safety Handbook

Table of Contents

Parts and Components	3
Assembly	4
Safety Tips	4
Maintenance	7
Limited Warranty	7
Owner Registration and Purchase Data	7

This manual contains important safety, performance and maintenance information. Read the manual carefully before taking your first ride and keep the manual handy for future reference.

AN IMPORTANT MESSAGE TO PARENTS:

This manual contains important safety information. For your child's safety, it is your responsibility to review this information with your child and make sure that your child understands all warnings, cautions, instructions and safety topics. Razor USA recommends that you periodically review and reinforce the information in this manual with younger riders and that you are required to inspect and maintain your child's scooter to insure their safety.

GENERAL WARNING: Scooter riding can be a hazardous

activity even under the best of circumstances. This manual contains many warnings and cautions concerning the consequences of failing to maintain or inspect your Razor Jr. scooter. Many of the warnings say "you may lose control or fall." Because any fall can result in serious injury or death, we do not repeat the warning of possible serious injury or death each time the risk of falling is mentioned.

Razor Jr. Parts and Components

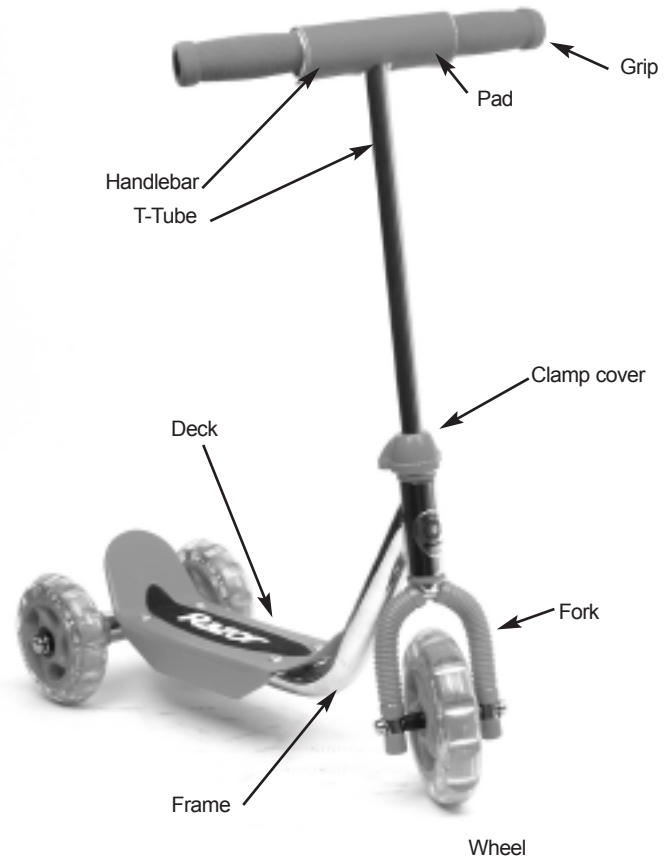

TOOLS REQUIRED FOR PROPER ASSEMBLY

13mm box wrench or adjustable wrench

1. Assembly Instructions

⚠ WARNING: Failure to properly install and tighten the handlebar T-tube and front fork clamp may cause the rider to lose control and fall. Assembly must be performed by an adult with mechanical experience. If you do not understand these instructions or the concept of “tighten securely” seek the assistance of a qualified mechanic.

ASSEMBLY INSTRUCTIONS:

- A. Slide metal washer (B) over the fork tube (A). Slide the fork tube into the steering column (G) until the metal washer seats against the preinstalled plastic steering bushing (C).
- B. With the front wheel pointed straight ahead (and the slot in the fork facing the scooter), slide the clamp assembly (E) onto the fork tube. Align the open end of the clamp with the slot in the fork as shown in H.
- C. Slide the plastic clamp cover (F) up the T-tube and insert the T-tube into the fork tube until the “max. insertion mark on the handlebar assembly is no longer visible. Align the T-tube square to the front wheel.
- D. Secure the handlebars by tightening the clamp nut using a 13mm wrench. Tighten securely, but note that the nut is designed to prevent over-tightening. Slide the plastic cap down over the clamp bracket to prevent injury.
- E. Place the foam for handlebar pad onto handlebar and wrap and secure the the cover with the velcro strips.

2. Razor Jr. Safety Tips

- A. Kids under 8 year of age shouldn't ride the RAZOR Jr. without adult supervision. The Razor Jr. is not recommended for children under the age of 3.

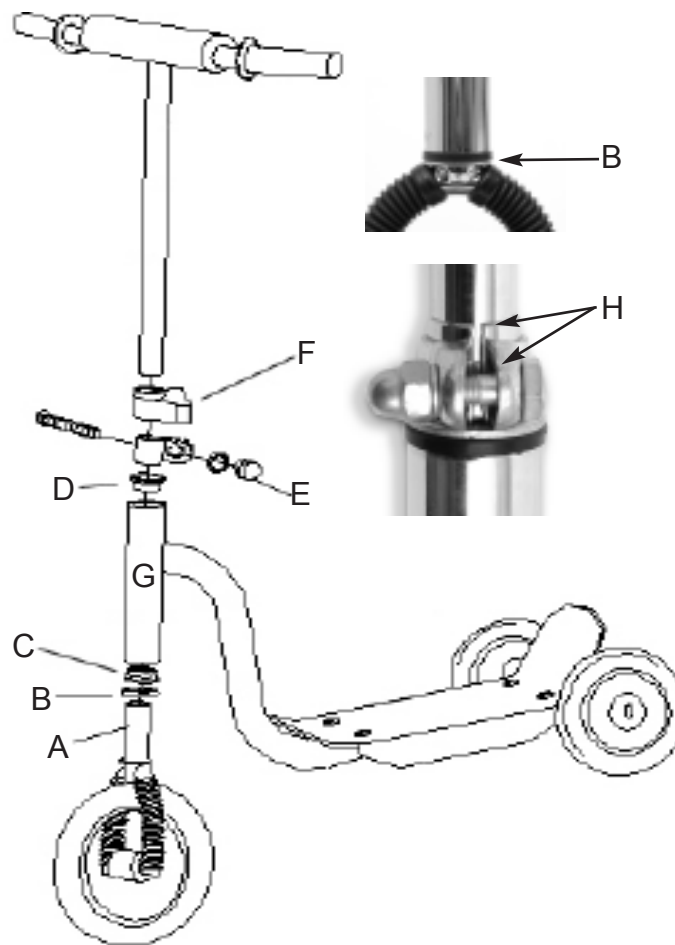

B. Never ride the Razor Jr. at dusk or at night.



WARNING: Do not ride on wet, slippery surfaces or icy conditions. You will lose traction and could fall.

C. Always wear proper protective equipment, such as an ANSI, SNELL, CPSC or ASTM approved helmet. Long sleeve shirt, gloves, long pants, shoes, and elbow and knee pads are recommended. Wear athletic shoes (lace-up shoes with rubber soles). Don't ride barefoot or in sandals.

D. Avoid water, speed bumps, sand, gravel, and anything that could cause you to slip and fall.

E. You will see people on TV and maybe even people you know doing tricks and stunts. These are people who have been practicing on scooters for a very long time. Don't try something until you are ready. Never ride indoors or on the street and watch your surroundings for pedestrians, bikers, boarders, and skaters.

F. Tighten and verify the handlebars are installed correctly before riding.

G. Do not modify the *RAZOR Jr.* in any way.

H. Maintain a hold on the handlebars at all times.

I. Do not ride in crowded public areas.

J. Do not ride down hills or on steep slopes.

K. The maximum weight allowed is 45 pounds (20 kilograms). Heavier riders are advised to purchase the Razor, which is designed for riders up to 220 pounds (100 kilograms).



WARNING: Ride only on smooth hard surfaces. The Razor Jr. was not intended for off-road, hilly terrain, or indoor use. Use caution when near curbs, uneven pavement, potholes or similar conditions.

3. Maintenance

Keep your Razor Jr. clean. Wipe with a damp cloth to remove dust and dirt.

4. Limited Warranty

This Limited Warranty is the only warranty for the Razor Jr. scooter. There is no other express or implied warranties. The only uses for this product are described in this manual.

The manufacturer warrants this product to be free of manufacturing defects for a period of six months from date of retail purchase. This Limited Warranty does not cover grips, the tires and wheels or normal wear and tear, nor any damage, failure or loss caused by improper assembly, maintenance, storage or use of the Razor Jr.

This Limited Warranty will be void if the product is ever: used in a manner other than for recreation; modified in any way; or rented.

The manufacturer is not liable for incidental or consequential loss nor damage due directly or indirectly from the use of this product.

To obtain service under this warranty you must, within the warranty period, contact Razor USA LLC directly at 1-800-GO-Razor or by e-mail at warranty@razor.com. Razor will provide repair parts and/or replacement at its sole discretion.

Authorized warranty service is ONLY available from Razor USA LLC.

7. Owner Registration and Purchase Data

Please register with Razor. This will ensure Razor is able to contact you regarding safety or product updates from the manufacturer. Register via e-mail on the Razor website: www.razor.com or use the mail-in card included in the box.