

Cat. No. 43-1245  
**OWNER'S MANUAL**

Please read before using this equipment.

**AFX-300**

**Deluxe Automatic  
Fax/Data Switch**

**Radio Shack**

## INTRODUCTION

---

Your Radio Shack AFX-300 Deluxe Automatic Fax/Data Switch lets you use your telephone, an answering machine, a fax machine/fax modem, and a data modem all on the same telephone line, eliminating the need and extra expense of two phone lines. When a call comes in, you can either answer it yourself, let your answering machine answer it, or let the AFX-300 answer it. If the AFX-300 hears tones from a fax machine/fax modem, it directs the call to your fax machine/fax modem. If a call comes in from a data modem, the AFX-300 directs the call to your data modem. If the call is a regular voice call, you can carry on a normal conversation, or let the answering machine record the caller's message as usual.

The AFX-300 also includes several special features that let you customize its operation based on your needs. Using either a remote touch-tone phone or one on the same line as the AFX-300, you can adjust the number of rings before it answers, route data modem calls to its fax jack, and more (see the "Special Features" section of this owners manual).



Your AFX-300 is easy to install. It connects to an existing telephone jack and requires no special wiring. The AFX-300 works with most single and multi-line non-KSU (key system unit) telephones, and even has built-in features that are designed to work with distinctive ringing services provided by most phone companies. The AFX-300 is also compatible with most telephone answering machines, fax machines, and fax or fax/data modems.

© 1996 Tandy Corporation.  
All Rights Reserved.

Radio Shack is a registered trademark used by Tandy Corporation.

This fax/data switch has been tested and found to comply with applicable UL and FCC standards.

**Warning:** To prevent fire or shock hazard, do not expose this product to rain or moisture.

	<b>CAUTION</b> RISK OF ELECTRIC SHOCK. DO NOT OPEN.	
<b>CAUTION:</b> TO REDUCE THE RISK OF ELECTRIC SHOCK, DO NOT REMOVE COVER OR BACK. NO USER-SERVICE-ABLE PARTS INSIDE. REFER SERVICING TO QUALIFIED PERSONNEL.		



This symbol is intended to alert you to the presence of un-insulated dangerous voltage within the product's enclosure that might be of sufficient magnitude to constitute a risk of electric shock. Do not open the product's case.



This symbol is intended to inform you that important operating and maintenance instructions are included in the literature accompanying this product.

## **READ THIS BEFORE INSTALLING**

Each device that you connect to the phone line draws power from the phone line. We refer to this power draw as the device's ringer equivalence number, or REN. The REN is shown on the bottom of your AFX-300.

If you are using more than one device on the line, add up all the RENs. If the total is more than five, your phone might not ring and your answering machine might not answer. In rural areas, a total REN of three might impair ringer operation. If ringer operation is impaired, remove a device from the line.

Your AFX-300 complies with Part 68 of *FCC Rules*. You must, upon request, provide the FCC registration number and the REN to your phone company. Both numbers are shown on the bottom of your AFX-300.

You must not connect your AFX-300 to:

- Coin-operated systems
- Party-line systems
- Most electronic key phone systems

The AFX-300 is not compatible with:

- Voice mail services
- Call forwarding services
- Call waiting services
- Fax machines or modems that have a REN greater than 2.0B.

## CONTENTS

---

---

<b>Installation .....</b>	<b>7</b>
Installing Back-Up Batteries .....	7
Making the Connections .....	9
Initializing the AFX-300/Connecting to Power .....	13
Preparing a TAD for Use with the AFX-300 .....	15
Setting the TAD's Ring Number .....	15
Changing the Outgoing Message .....	15
Optional Voice Data Guard .....	17
<b>Operation .....</b>	<b>18</b>
Using a TAD with the AFX-300 .....	19
TAD Operation with a Fax Machine/Fax Modem ...	20
TAD Operation with a Fax Machine/Fax Modem	
and a Data Modem .....	21
Answering Calls in Person .....	22
Letting the AFX-300 Answer Calls .....	23
Switching Fax Calls Manually .....	24
Using a Touch-Tone Phone .....	24
Using a Rotary (Pulse) Phone .....	25
<b>Special Features .....</b>	<b>26</b>
Programming Quick Start .....	27
Programming from an Extension Phone .....	27
Programming from a Remote Phone .....	27
Quick Start Command Chart .....	28
Basic Programming Steps .....	30
Programming from an Extension Phone .....	31
Programming from a Remote Phone .....	32

---

---

Program Command Descriptions .....	33
Changing the Access Code .....	34
Changing the Ring Number Setting .....	35
First Number Distinctive Ring .....	35
Second Number Distinctive Ring .....	36
Turn On/Off the FAX and MODEM Jacks .....	36
Turn On/Off the TAD Jack .....	37
Turn On/Off the Fax Password .....	38
Route Data Modem Calls to the FAX Jack .....	39
Automatic Modem Detection (AMD) .....	39
<b>Questions and Answers .....</b>	<b>40</b>
<b>Care and Maintenance .....</b>	<b>43</b>
If You Have Problems .....	44
The FCC Wants You to Know .....	45
Lightning .....	45

## INSTALLATION

**Caution:** Be sure to perform the procedures in this section in this order, otherwise the AFX-300 might not operate as expected:

1. Install batteries
2. Connect to the phone line
3. Connect your TAD, fax machine/fax modem, and/or data modem
4. Initialize the AFX-300 and connect it to AC power

**Note:** If the AFX-300's operation becomes erratic, disconnect it from AC power, unplug all modular connections, remove the backup batteries, then follow all installation procedures in the order they appear (beginning with "Installing Back-Up Batteries").

### INSTALLING BACK-UP BATTERIES

Your AFX-300 requires two button-cell batteries (supplied) for memory backup in case AC power is disconnected or fails.

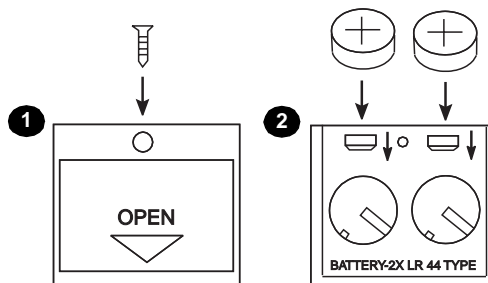

Follow these steps to install the batteries.

1. Remove the battery compartment screw with a small Phillips screwdriver, then remove the cover by sliding it in the direction of the arrow.
2. Insert the batteries into the compartment with the positive (+) sides facing up. The POWER/IN USE indicator turns on.
3. Replace the cover, then reinsert and tighten the screw.

**Notes:**

- The AFX-300's POWER/IN USE indicator flashes slowly during normal use. If it flashes rapidly, replace the batteries. For the longest life, we recommend alkaline batteries, such as Radio Shack Cat. No. 23-115.

**Warning:** Promptly dispose of old batteries and keep them out of reach of young children. Swallowing a button cell battery can be fatal.

- Before you replace the back-up batteries, you must disconnect the AFX-300 from AC power and unplug all modular phone cords.
- Disconnecting AC power while the batteries are removed resets the AFX-300's features to their default settings (see "Special Features" on Page 26).



---

---

## MAKING THE CONNECTIONS

Follow these steps to connect the AFX-300 to the phone line and your answering machine (TAD), fax machine, fax modem, and/or data modem.

1. Plug one end of the AFX-300's modular cord into its **LINE** jack, and plug the other end into your modular telephone line jack.

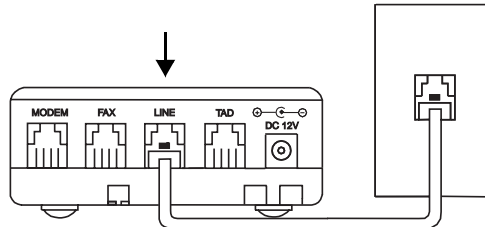

### Notes:

- If your telephone line does not have a modular jack, you must update the wiring. You can convert the wiring yourself, using jacks and adapters available at your local Radio Shack store, or you can have the telephone company update the wiring for you. The telephone company will charge you for the installation of the necessary jacks. The USOC number of the jack to be installed is RJ11C (or RJ11W for a wall plate jack).

- If you have two phone lines and you want to connect the AFX-300 to the second line, you must install a triplex modular adapter, such as Radio Shack Cat. No. 279-469, and connect the AFX-300 to L2. Follow the installation instructions provided with the adapter.
- You can mount the AFX-300 on a standard modular wall plate or directly on a wall using two screws (not supplied), then connect the AFX-300 to the telephone line using a short modular cord (not supplied).

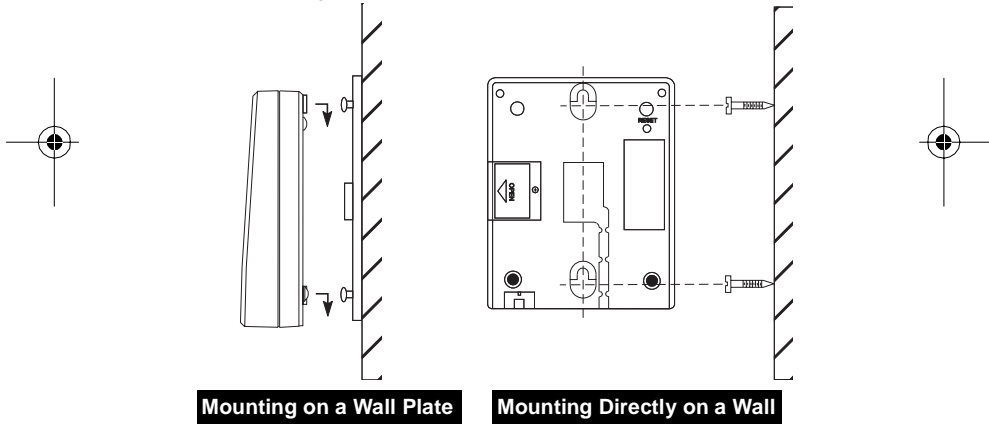

2. To connect a fax machine, fax modem, or fax/data modem, plug its modular plug into the AFX-300's **FAX** jack.

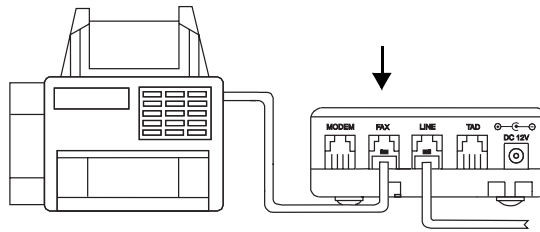

**Notes:**

- If you connected a fax/data modem (one that receives both fax *and* data calls), be sure to set the AFX-300 to route data modem calls to the **FAX** jack (see “Special Features” on Page 26).
  - To ensure optimum compatibility with the AFX-300 and avoid disconnected fax calls due to lengthy connection time:
    - Set the connected fax machine/fax modem’s ring number feature to its minimum setting (typically 1 ring).
    - If the connected fax machine/fax modem has a delayed ring (or answer) feature, turn it off or set it to the minimum delay setting.
3. To connect a TAD to the AFX-300, plug the TAD’s modular plug into the AFX-300’s **TAD** jack. Also, see “Preparing a TAD for Use with the AFX-300” on Page 15.

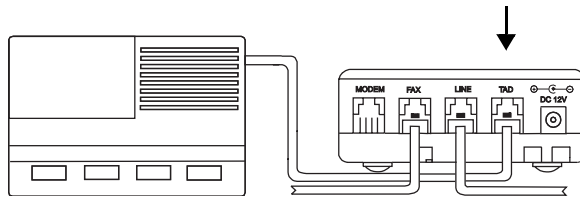

**Notes:**

- If you connect a TAD to the AFX-300, you can connect your telephone to the phone jack on the TAD.
  - If you do not connect a TAD to the AFX-300's **TAD** jack, you can connect your telephone's modular plug directly to this jack.
  - If you installed a triplex adapter, plug your TAD's or telephone's modular cord into the adapter's L1/L2 jack.
4. To connect a data modem to the AFX-300, plug the modem's modular plug into the AFX-300's **MODEM** jack.

**Note:** If you connected both a TAD *and* a data modem to the AFX-300, and do not subscribe to second number distinctive ring service from your telephone company, be sure to turn on the automatic modem detection feature (see "Special Features" on Page 26). Otherwise, the AFX-300 will not switch data modem calls properly.

---

---

## INITIALIZING THE AFX-300/ CONNECTING TO POWER

Follow these steps to initialize the AFX-300 and connect it to AC power.

### Cautions:

- Be sure you install the batteries then connect all of the modular jacks *before* you connect the AFX-300 to power.
- You must follow *all* of these steps, *in order*, to initialize your AFX-300; otherwise, it might not detect when the batteries are low.

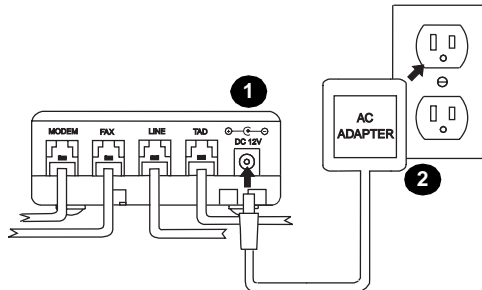

1. Plug the supplied adapter's barrel plug into the AFX-300's DC 12V jack.

2. Plug the adapter's other end into a standard 120-volt AC power outlet.

**Caution:** You must use a Class II, 120V AC/12V DC adapter that delivers at least 400 milliamps. Its center tip must be set to negative and its plug must correctly fit the AFX-300's **DC 12V** jack. The supplied adapter meets these requirements. Using an adapter that does not meet these requirements could damage the AFX-300 or the adapter.

3. Wait about 10 seconds, then unplug the adapter's barrel plug from the AFX-300's **DC 12V** jack.
4. Wait another 10 seconds, then reconnect the adapter's barrel plug to the AFX-300's **DC 12V** jack.
5. Route the AC adapter cord through the AFX-300's strain relief slot.

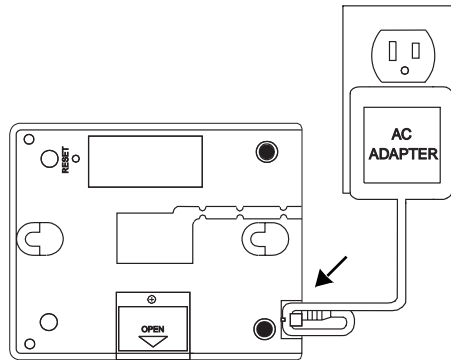

---

---

## PREPARING A TAD FOR USE WITH THE AFX-300

### Setting the TAD's Ring Number

The AFX-300 is preset to direct a call to either the **FAX** or **MODEM** jack after five rings. When you use a TAD with the AFX-300, be sure the TAD is set to answer within four rings. If it is not, either change the ring number on the TAD to 4, or change the ring number on the AFX-300 to at least one number higher than the TAD's ring number (see "Special Features" on Page 26).

### Changing the Outgoing Message

Some fax machines/fax modems do not sound the tones required to make the AFX-300 automatically switch the call and start your fax machine/fax modem (see "Switching Fax Calls Manually" on Page 24). If you connected a TAD to the AFX-300, we recommend you change the TAD's outgoing message to include instructions for callers with that type of fax machine/fax modem, or for those callers who might want to both leave a voice message and send a fax during the call.



---

For example:

*"Hello. You have reached 555-4567. Please leave your name and phone number at the tone, and we will return your call. If you want to send us a fax and you have a touch-tone phone, press one, the pound sign, then one on your telephone to activate our fax machine, then press START on your fax machine. Thanks for calling."*

If you also connected a data modem to the AFX-300, the message might say:

*"Hello. You have reached 555-4567. If you want to leave a message, press any digit on your touch-tone phone, then leave your name and phone number at the tone, and we will return your call. Or, if you want to send us a fax and you have a touch-tone phone, press one, the pound sign, then one on your telephone to activate our fax machine, then press START on your fax machine. Thanks for calling."*

**Note:** If your TAD's message interferes with the AFX-300's operation (for example, calls are not routed properly, the TAD records calls intended for the fax machine/fax modem, etc.), re-record the message and speak more softly.

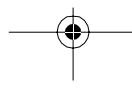
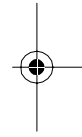
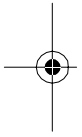



---

---

## OPTIONAL VOICE DATA GUARD

If an extension telephone on the same line as the AFX-300 is in use, the AFX-300 does not let your fax machine/fax modem or data modem access the telephone line or interrupt the call in progress.

However, to prevent an extension telephone (one not plugged into the AFX-300) from interrupting a fax or data transmission that is in progress on the same line as the AFX-300, you must plug that extension phone into an optional voice data guard, such as Radio Shack Cat. No. 43-107.

You can use a voice data guard for these situations:

- When you use cordless telephones, extension telephones, speed dialers, computer modems, or other telephone devices on the same telephone line as your fax machine/fax modem.
- When your answering machine is too far away to easily connect to the AFX-300's **TAD** jack.

To install a voice data guard, follow its supplied instructions.

**Note:** You do not need to use a voice data guard with the AFX-300 if your TAD automatically stops the outgoing message when you pick up an extension phone on the same line as the TAD, and you connected the TAD to the AFX-300's **TAD** jack.

## **OPERATION**

---

---

An incoming call on the phone line connected to the AFX-300 can be answered in any of the following ways:

- **If you connected an answering machine (TAD) to the AFX-300, you can let the TAD answer the call** (see “Using a TAD with the AFX-300” on Page 19).
- **You can answer the call in person** by picking up any phone on the same line as the AFX-300 (see “Answering Calls in Person” on Page 22).
- **You can let the AFX-300 automatically answer the call** (see “Letting the AFX-300 Answer Calls” on Page 23).

Regardless of how a call is answered, if the call is from a fax machine, fax modem, or data modem, the AFX-300 automatically directs the call to the proper device. After the call ends, the AFX-300 automatically resets to answer the next call.

### **Notes:**

- The POWER/IN USE indicator flashes slowly when the AFX-300 is in use.
- If you connected both a TAD and a data modem to the AFX-300, be sure to turn on the AFX-300’s automatic modem detection feature (see “Automatic Modem Detection (AMD)” on Page 39).

- If you subscribe to first number distinctive ring service from your telephone company, the AFX-300 is preset to automatically transfer calls to your fax machine/fax modem, whether the call is a voice call or a call from a fax machine/fax modem or data modem (see “First Number Distinctive Ring” on Page 35).
- If you have two phone lines and subscribe to a call roll-over feature from your telephone company, a fax call might roll over to the other line (the line not connected to the AFX-300) when your fax line is busy. If this happens, the AFX-300 cannot direct that call to your fax machine/fax modem.
- If a caller’s fax machine does not sound fax alert (CNG) tones (tones that indicate the incoming call is a fax call), the AFX-300 cannot automatically switch the call to your fax machine/fax modem, but you can switch it manually (see “Switching Fax Calls Manually” on Page 24).

## USING A TAD WITH THE AFX-300

If you connected a TAD to the AFX-300, you can let the TAD answer calls. How the AFX-300 operates depends on whether you connected only a fax machine/fax modem, or connected a fax machine/fax modem and a data modem.

---

---

## TAD Operation with a Fax Machine/Fax Modem

When the TAD answers a call, the AFX-300 listens during the outgoing message for either fax alert tones or touch-tone commands.

**If the AFX-300 detects fax alert tones**, it automatically disconnects the TAD and directs the call to your fax machine/fax modem.

**If the AFX-300 detects a preset sequence of touch-tone commands**, it either switches the call directly to your fax machine/fax modem or data modem, or is set to accept further commands (see "Switching Fax Calls Manually" on Page 24 and "Special Features" on Page 26).

**If the call is a voice call**, the TAD records the caller's message as usual.

### Notes:

- If the touch-tone sequence detected by the AFX-300 does not match one of its preset sequences, the TAD simply records the touch-tone sounds.
- If no fax alert or touch-tones are detected and the caller is silent, the TAD records the silence and/or hangs up.

---

---

### TAD Operation with a Fax Machine/Fax Modem and a Data Modem

When the TAD answers a call, the AFX-300 listens during the first 20 seconds of the outgoing message for either fax alert tones or touch-tone commands.

**If the AFX-300 detects fax alert tones**, it automatically disconnects the TAD and directs the call to your fax machine/fax modem.

**If the AFX-300 detects a preset sequence of touch-tone commands**, it either switches the call directly to your fax machine/fax modem or data modem, or is set to accept further commands (see "Switching Fax Calls Manually" on Page 24 and "Special Features" on Page 26).

**If the call is a voice call**, the caller must enter a touch-tone command within 20 seconds after the TAD answers to have the call directed to the TAD so it can record the caller's message as usual.

**If no fax alert or touch-tones are detected within 20 seconds after the TAD answers**, the AFX-300 automatically switches the call to your data modem.

---

---

## ANSWERING CALLS IN PERSON

You can answer a call in person by simply picking up any phone on the line (including one connected to the **PHONE** jack on your TAD) before the TAD or AFX-300 answers the call.

**Note:** Because the AFX-300 automatically disables your fax machine when a call is received, you cannot use its built-in telephone (if any) to answer a call in person.

**If you answer a call and the call is a voice call**, talk as usual.

**Note:** If you connected a TAD *and* a data modem to the AFX-300, and you answered the call on a phone connected to the TAD, you must press any touch-tone digit on the phone before you begin the conversation. If you do not, the AFX-300 automatically transfers the call to your data modem after 20 seconds.

**If you answer the call and hear fax alert tones**, simply hang up the phone. The AFX-300 directs the call to your fax machine/fax modem, regardless of whether or not you hang up.

**If you answer the call and hear only silence**, the call is probably from another data modem (a calling modem is silent until prompted by your modem). To transfer the call to a connected data modem, press 1, #, 2, listen for the modem's signals, then hang up the phone.

---

---

## LETTING THE AFX-300 ANSWER CALLS

If you did not connect a TAD, or if you turned off the connected TAD or the AFX-300's **TAD** jack (see "Special Features" on Page 26), and you do not answer the call in person, the AFX-300 automatically answers the call after the preset number of rings.

**Note:** The AFX-300 is preset to answer incoming calls after five rings. To change this setting, see "Special Features" on Page 26.

**If the AFX-300 detects fax alert tones or manual fax switching touch-tones within 5 seconds**, it automatically directs the call to your fax machine or fax modem.

**If the AFX-300 detects a preset sequence of touch-tone commands within 5 seconds**, it either switches the call directly to your fax machine/fax modem or data modem, or is set to accept further commands (see "Switching Fax Calls Manually" on Page 24 and "Special Features" on Page 26).

**If the AFX-300 does not detect fax alert tones or touch-tone commands within 5 seconds**, it automatically switches the call to its **MODEM** jack, even if you did not connect a data modem.

**Note:** If you did not connect a data modem, be sure to program the AFX-300 so it routes data modem calls to the **FAX** jack (see "Special Features" on Page 26). Otherwise, some fax calls might be disconnected.

---

---

## SWITCHING FAX CALLS MANUALLY

Using either a touch-tone or rotary (pulse) phone, you can manually set the AFX-300 to accept a transmission from a fax machine that does not sound a normal fax alert tone.

**Note:** The following procedures apply only to incoming faxes.

### Using a Touch-Tone Phone

During your conversation or when the answering machine answers a call, either you or the caller must press 1, #, then 1 on a touch-tone key pad to activate your fax machine/fax modem. After the code is entered, the sender of the fax must press his/her fax machine's SEND button, then both parties must hang up their handsets.

**Notes:**

- If either party presses a wrong key, wait about 10 seconds before trying again.
- You can use your phone's \* and # keys for other functions, such as computer banking, but the AFX-300 activates your fax machine/fax modem only when you press 1, #, and 1 in that order.





### Using a Rotary (Pulse) Phone

If you are using a rotary (pulse) phone, you can activate your fax machine/fax modem during an incoming call using a phone on the same line as the AFX-300. Dial 3 on the extension telephone to direct the incoming call to your fax machine/fax modem.

**Note:** You can only direct the call using an extension phone on the same line. A caller cannot activate your fax machine/fax modem by dialing 3 on his/her phone.

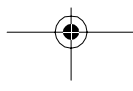
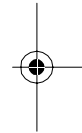

## **SPECIAL FEATURES**

---

The AFX-300 has several special features that let you customize its operation to fit your needs. By entering a preset access code from any touch-tone telephone — either from an extension on the same line as the AFX-300, or after calling from a remote phone — you can do any of the following:

- ☞ Change the preset access code
- ☞ Change the AFX-300's ring number setting
- ☞ Turn on/off first number distinctive ring
- ☞ Turn on/off second number distinctive ring
- ☞ Turn on/off the **FAX** and **MODEM** jacks
- ☞ Turn on/off the **TAD** jack
- ☞ Turn on/off the fax password feature
- ☞ Route data modem calls to the **FAX** jack
- ☞ Turn on/off automatic modem detection (AMD)

**For a quick-start list of programming instructions** (experienced users only) and a summary of the AFX-300's programming commands, see "Programming Quick Start" on Page 27.

**For detailed, step-by-step instructions** on programming the AFX-300, see "Basic Programming Steps" on Page 30.

**For a complete description of a particular feature**, see "Program Command Descriptions" on Page 33.

---

---

## PROGRAMMING QUICK START

This section provides a quick reference for experienced users to start programming the AFX-300. See the "Quick Start Command Chart" on Page 28 for a list of all default settings and remote commands.

### Programming from an Extension Phone

1. Pick up any phone on the same line as the AFX-300.
2. Enter 1, \*, then your 2-digit access code (preset to 99).
3. Enter a remote command.
4. Hang up the phone.

**Note:** To program another feature, repeat these steps.

### Programming from a Remote Phone

1. Dial your phone number.
2. After the TAD or fax switch answers, enter 1, \*, then your 2-digit access code (preset to 99).
3. Enter a remote command within 10 seconds.
4. Hang up the phone.

**Note:** To program another feature, repeat these steps.

---

---

### Quick Start Command Chart

Command	Default Setting	You Press	Number of Times the AFX-300 Beeps
Change the Access Code (New code can be from 00-99)	99	* 1, New Code	2
Change the Ring Number Setting (Ring number can be from 1-7)	5	* 2, Ring Number	2
First Number Distinctive Ring	On	* 3	2 = On 3 = Off
Second Number Distinctive Ring	Off	* 4	2 = On 3 = Off
Turn On/Off the <b>FAX</b> and <b>MODEM</b> Jacks	On	* 5	2 = On 3 = Off

---

---

<b>Command</b>	<b>Default Setting</b>	<b>You Press</b>	<b>Number of Times the AFX-300 Beeps</b>
Turn On/Off the <b>TAD</b> Jack	On	* 6	2 = On 3 = Off
Turn On/Off the Fax Password (The preset password, if on, is 1 # 9 9)	Off	* 7	2 = On 3 = Off
Route Data Modem Calls to the <b>FAX</b> Jack	Off	* 8	2 = On 3 = Off
Turn On/Off Automatic Modem Detection (AMD)	Off	* 9	2 = On 3 = Off

---

---

## BASIC PROGRAMMING STEPS

The following sections provide you with the basic instructions for programming the AFX-300's special features from a local (extension) or remote touch-tone phone.

### Notes:

- You must correctly enter a 2-digit access code each time you program the AFX-300. The AFX-300's access code is preset to 99. To change the code or reset the AFX-300 to the default code, see "Changing the Access Code" on Page 34.
- You can only enter one program command per call from a remote phone or from an extension on the same line.
- Do not set the AFX-300 so both its **TAD** and **FAX** jacks are turned off at the same time. If you do, you might not be able to turn on either one remotely. You must use a touch-tone phone on the same line as your AFX-300 to turn on either jack (see "Programming from an Extension Phone" on Page 27).
- If you connected a programmable TAD to the same line as the AFX-300, the TAD might respond to programming commands intended for the AFX-300. If you are using an extension phone, disconnect or turn off the TAD during programming, then reconnect it when you finish. If you are using a remote phone, turn off the **TAD** jack before you program the other settings (see "Turn On/Off the TAD Jack" on Page 37).

---

---

## Programming from an Extension Phone

**Note:** It is not unusual to hear beeping/buzzing or the operator's voice on the line as you program the AFX-300 from an extension phone.

1. Pick up any phone on the same line as the AFX-300, except the built-in phone (if any) on your fax machine.
2. Press 1, \*, then the 2-digit access code. The AFX-300 beeps once.

**Note:** If you enter the access code incorrectly, simply try again.

3. Enter a remote command by pressing \* then the number(s) for the desired command. The AFX-300 beeps either two or three times, depending on the command you entered. See "Program Command Descriptions" on Page 33.

**Note:** If you enter the programming command incorrectly, simply try again.

4. Hang up the phone.

**Note:** To program another feature, repeat these steps.

---

---

## Programming from a Remote Phone

1. Dial the phone number of the line connected to the AFX-300.
2. Within 10 seconds after the TAD answers, or within 5 seconds after the AFX-300 answers, press 1, \*, then the 2-digit access code. The AFX-300 beeps once.

**Notes:**

- If the AFX-300 answers, the phone stops ringing and you might not hear any other sound.
  - If you enter the access code incorrectly or do not enter it in time, the AFX-300 automatically disconnects the call. If this happens, hang up and start over again from Step 1.
3. Enter a remote command within 10 seconds by pressing \* then the number(s) for the desired command. The AFX-300 beeps either two or three times, depending on the command you entered. See "Program Command Descriptions" on Page 33.

**Note:** If you enter the programming command incorrectly or do not enter it in time, the AFX-300 automatically disconnects the call. If this happens, hang up and start over again from Step 1.

4. Hang up the phone.

**Note:** To program another feature, repeat these steps.



---

---

## PROGRAM COMMAND DESCRIPTIONS

Each of the following sections describes a different AFX-300 special feature and explains how to turn on, turn off, or change that feature when you follow the steps listed in "Basic Programming Instructions." The beginning of each section includes this basic information:

**Touch-Tone Command(s)** — lists the specific touch-tone command sequence you enter to turn on, turn off, or change that feature while programming the AFX-300.

**AFX-300 Response** — tells you how the AFX-300 responds when you correctly enter the appropriate touch-tone command sequence.

**Default Setting** — lists the default setting for that feature.

**Note:** For all special features except "Changing the Access Code" and "Changing the Ring Number Setting," the same touch-tone command is used to both turn on *and* turn off that feature. You can tell whether the feature is turned on or off by the AFX-300's response (two or three beeps).

---

---

## Changing the Access Code

**Touch-Tone Command:** \* 1, then any 2-digit number from 00-99

**AFX-300 Response:** 2 beeps

**Default Setting:** 99

For built-in security against accidental or unwanted changes to its settings, the AFX-300 requires you to enter a 2-digit access code each time you program it. The access code is pre-set to 99, but you can change the code to one you can easily remember.

**Note:** If you change the access code then forget it, you can reset the AFX-300 to accept the default access code of 99. To do this, insert a small, pointed object (such as a straightened paper clip) into **RESET** on the bottom of the AFX-300 and press it gently.

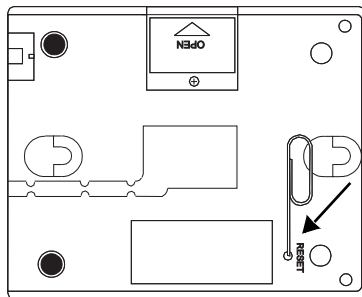

---

---

## Changing the Ring Number Setting

**Touch-Tone Command:** \* 2, then any number from 1-7 (rings)

**AFX-300 Response:** 2 beeps

**Default Setting:** 5 rings

The AFX-300 is preset to answer incoming calls after 5 rings, but you can set it to answer after as few as 1 or as many as 7 rings. This is especially useful if you connected a TAD to the AFX-300, or if you need time to get to the phone to answer calls in person.

## First Number Distinctive Ring

**Touch-Tone Command:** \* 3

**AFX-300 Response:** 2 beeps = On  
3 beeps = Off

**Default Setting:** On

If you subscribe to first number distinctive ring service through your phone company, the AFX-300 is preset to automatically switch calls to your fax machine/fax modem if it detects the first number's distinctive ring pattern. If you subscribe to this service but do not want the AFX-300 to transfer that number's calls to your fax machine/fax modem, you can turn this feature off.

---

---

## Second Number Distinctive Ring

**Touch-Tone Command:** \* 4

**AFX-300 Response:** 2 beeps = On  
3 beeps = Off

**Default Setting:** Off

If you subscribe to second number distinctive ring service through your phone company, the AFX-300 is preset to automatically switch calls to your data modem if it detects the second number's distinctive ring pattern. If you subscribe to this service but do not want the AFX-300 to transfer that number's calls to your data modem, you can turn this feature off.

## Turn On/Off the FAX and MODEM Jacks

**Touch-Tone Command:** \* 5

**AFX-300 Response:** 2 beeps = On  
3 beeps = Off

**Default Setting:** On

The AFX-300 is preset to automatically switch fax or data calls to your fax machine/fax modem or data modem, but it also lets you turn off the **FAX** and **MODEM** jacks (together). This is useful if you are expecting only voice calls, and want all calls to be routed to the AFX-300's **TAD** jack.

---

---

## Turn On/Off the TAD Jack

**Touch-Tone Command:** \* 6

**AFX-300 Response:** 2 beeps = On  
3 beeps = Off

**Default Setting:** On

The AFX-300's **TAD** jack is automatically turned on, so you can easily plug in a TAD and begin using the AFX-300. If the TAD you connected is also programmable (by touch-tones), the AFX-300 lets you turn off its **TAD** jack to prevent the connected TAD from answering calls (even though the TAD might be turned on and set to answer calls) or interfering with touch-tone commands meant for the AFX-300. You might also want to turn off the **TAD** jack if you did not connect a TAD.

---

---

## Turn On/Off the Fax Password

**Touch-Tone Command:** \* 7

**AFX-300 Response:** 2 beeps = On  
3 beeps = Off

**Default Setting:** Off

**Preset Password** (when turned on) = 1 # 9 9

The AFX-300 is preset to automatically switch incoming fax calls to your fax machine/fax modem. For privacy or selective use, you can set the AFX-300 to require a preset password before it accepts fax calls.

**Notes:**

- If you turn on this feature, be sure to give the password to any callers from whom you want to receive faxes.
- The caller must enter the fax password within 5 seconds after the AFX-300 answers or within 20 seconds after the TAD answers (if connected). Otherwise, the AFX-300 automatically transfers the call to its **MODEM** jack, even if you did not connect a data modem.
- The AFX-300's fax password is preset to 1 # 9 9. You cannot change the password.

---

---

## Route Data Modem Calls to the FAX Jack

**Touch-Tone Command:** \* 8

**AFX-300 Response:** 2 beeps = On  
3 beeps = Off

**Default Setting:** Off

The AFX-300 is preset to route incoming data modem calls to its **MODEM** jack, but you can set it so both incoming fax and data modem calls are routed only to the **FAX** jack. This is especially useful if you connected a combined fax/data modem to the AFX-300.

## Automatic Modem Detection (AMD)

**Touch-Tone Command:** \* 9

**AFX-300 Response:** 2 beeps = On  
3 beeps = Off

**Default Setting:** Off

If you connected both a TAD and a data modem to the AFX-300, you can turn on the AFX-300's AMD feature so the AFX-300 can detect an incoming data modem call and automatically switch the call to your data modem.

## QUESTIONS AND ANSWERS

Here are some common questions and answers about how your AFX-300 operates.

### What is line sharing?

Line sharing lets you use one telephone line for more than one purpose. For example, you can use one telephone line for regular calls, fax or modem transmissions, or calls to your answering machine. Line sharing eliminates the need for additional phone lines.

### How does my AFX-300 know its a fax call?

Unless you use the first number distinctive ringing feature, the fax machine must wait for you, the TAD, or the AFX-300 to answer the phone before it knows whether or not the call is a fax. When a fax machine calls, it repeatedly sounds a 1/2-second tone followed by a 3-second pause on the phone line (fax alert tone) until another fax machine responds. The AFX-300 listens for these tones.

### How does my AFX-300 know its a data modem call?

Unless you use the second number distinctive ringing feature, the data modem must wait for you, the TAD, or the AFX-300 to answer the phone before it knows whether or not the call is a data modem. When a data modem calls, it makes no sounds at all until your data modem sends it a signal to begin the transmission. The AFX-300 listens for at least 20 seconds of silence (no fax alert tones or touch-tone commands), then automatically transfers the call to your data modem.



---

---

**Can I share my residential line with my fax machine?**

Yes. You can install the AFX-300 at any available modular telephone jack on the telephone line. To prevent calls on other extensions in your home (or office) from interrupting your fax transmissions, we recommend you install a voice data guard (available at you local Radio Shack store) at each extension that shares the line with your fax machine.

**Can I use the AFX-300 on a two-line system?**

Yes. The AFX-300 will work on a 2-line system, if it is connect-  
ed to one of those lines.

**Can I still send faxes like I did before I installed the switch?**

Yes. Installing the switch does not affect outgoing fax opera-  
tion.

**Is there any special information I need to know about receiving faxes from a fax machine that uses auto-dial?**

Yes. Auto-dialing fax machines must connect with the receiv-  
ing fax machine usually within about 35 seconds. Otherwise,  
the transmission ends. This means the combined number of  
rings between the TAD (or AFX-300) and your fax machine/fax  
modem should not exceed five rings. For safety's sake, al-  
ways set your fax machine/fax modem to its lowest ring delay  
and/or ring number setting. Also, if you frequently receive fax  
calls from overseas, you must allow extra time for the call to  
connect (which means using an even lower number of com-  
bined rings).

---

---

**Does the AFX-300 work with an answering machine that has a toll-saver feature?**

Yes, but auto-dialing fax machines must connect with the receiving fax machine usually within about 35 seconds. Otherwise, the transmission ends. This means that if the toll-saver feature requires four rings, you must set the fax machine to respond in one ring.

**Does the AFX-300 work with the call-forwarding feature from my phone company?**

No. If you have forwarded your phone to another number, incoming fax calls never reach your AFX-300 because the calls are switched at the telephone company's central office.

**Does the AFX-300 work with the call-waiting feature from my phone company?**

Yes, but the call-waiting signal might distort an incoming or outgoing fax or data transmission. Some telephone systems let you temporarily turn off the call-waiting feature by dialing a special code. You might want to do that if you send or expect to receive an important fax call. Ask your telephone company if it offers this feature.

## **CARE AND MAINTENANCE**

Your Radio Shack AFX-300 Deluxe Automatic Fax/Data Switch is an example of superior design and craftsmanship. The following suggestions will help you care for the AFX-300 so you can enjoy it for years.

- Keep the AFX-300 dry. If it gets wet, wipe it dry immediately. Liquids can contain minerals that corrode electronic circuits.
- Use and store the AFX-300 only in normal temperature environments. Temperature extremes can shorten the life of electronic devices and distort or melt plastic parts.
- Handle the AFX-300 gently and carefully. Dropping it can damage circuit boards and cases and can cause the AFX-300 to work improperly.
- Keep the AFX-300 away from dust and dirt, which can cause premature wear of parts.
- Wipe the AFX-300 with a damp cloth occasionally to keep it looking new. Do not use harsh chemicals, cleaning solvents, or strong detergents to clean your AFX-300

Modifying or tampering with the AFX-300's internal components can cause a malfunction and invalidate its warranty and void your FCC authorization to use it. If your AFX-300 is not performing as it should, take it to your local Radio Shack store for assistance. If the trouble is harming the telephone lines, the telephone company might ask you to disconnect your AFX-300 until you have resolved the problem.

---

---

## IF YOU HAVE PROBLEMS

If your AFX-300 does not work or works poorly, check the connection to the telephone line. If the reception is noisy when you make a call, hang up the phone's handset. Then pick up the handset and redial the number.

If a power failure occurs while your fax machine/fax modem is operating, the AFX-300 might not operate properly when power is restored. If this happens, follow these steps to reset the AFX-300.

1. Unplug the adapter's barrel plug from the AFX-300's **DC 12V** jack.
2. Wait about 10 seconds, then reconnect the adapter's barrel plug to the AFX-300's **DC 12V** jack.

**Note:** If the AFX-300 still does not work properly, disconnect it from AC power, unplug all modular connections, remove the backup batteries, then follow all installation procedures in order (see "Installation" on Page 7).

If the AFX-300 does not transfer calls to your fax machine/fax modem or data modem, the phone line voltage might be too low. Normal phone line voltage is 48 volts DC. The AFX-300 operates with voltage down to about 43 volts DC. If the phone line's voltage is below 43 volts DC, your AFX-300 might not operate properly. Check with your phone company if you think you have this problem.

---

---

## THE FCC WANTS YOU TO KNOW

In the unlikely event that your AFX-300 causes problems on the phone line, the phone company can disconnect your service. The phone company attempts to notify you in advance. If advance notice is not practical, the phone company notifies you of your right to file a complaint with the FCC.

Also, the phone company can make changes to its lines, equipment, operations, or procedures that could affect the operation of your AFX-300. The phone company notifies you of these changes in advance, so you can take steps to prevent interruption of your phone service.

## LIGHTNING

Your AFX-300 has built-in protection circuits to reduce the risk of damage from surges in phone and power line current. These protection circuits meet or exceed FCC requirements. However, lightning striking the phone line or power lines can damage your AFX-300.

Lightning damage is not common. Nevertheless, if you live in an area that has frequent electrical storms, we suggest that you unplug your AFX-300 during storms to reduce the possibility of damage.

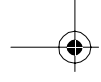

# NOTES

---

---

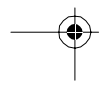
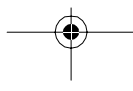
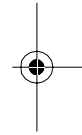
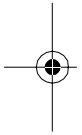

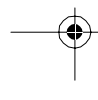
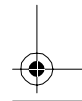
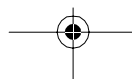
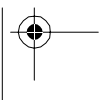
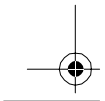
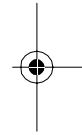
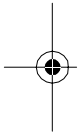
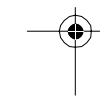

### RADIO SHACK LIMITED WARRANTY

This telephone product is warranted against manufacturing defects in material and workmanship for one (1) year from the date of purchase from Radio Shack company owned stores and authorized Radio Shack franchisees and dealers. Within this period **bring your Radio Shack sales slip** as proof-of-purchase date to any Radio Shack store.

This warranty does not cover damage or failure caused by or attributable to Acts of God, abuse, misuse, improper or abnormal usage, faulty installation, improper maintenance, lightning or other incidence of excess voltage, or any repairs other than those provided by a Radio Shack Authorized Service Facility, or transportation costs. **Radio Shack is not responsible or liable for indirect, special, or consequential damages arising out of or in connection with the use or performance of the product or other damages with respect to loss of property, loss of revenue or profit, or costs of removal, installation or reinstallation.**

EXCEPT AS PROVIDED HEREIN, RADIO SHACK MAKES NO EXPRESS WARRANTIES AND ANY IMPLIED WARRANTIES ARE LIMITED IN DURATION TO THE DURATION OF THE WRITTEN LIMITED WARRANTIES CONTAINED HEREIN. Some states do not allow the limitation or exclusion of incidental or consequential damages and some states do not allow limitation or exclusion of implied warranties; therefore, the aforesaid limitation(s) or exclusion(s) may not apply to the purchaser. There will be charges rendered for repairs to the product made after the expiration of the aforesaid one (1) year warranty period. This warranty gives you specific legal rights and you may also have other rights which vary from state to state.

*We Service What We Sell*

9/94

**RADIO SHACK**  
A Division of Tandy Corporation  
Fort Worth, Texas 76102

Printed in Hong Kong