

PROFILE SERIES 60 AMP BUSWAY

60 AMP BUSWAY SURFACE SUSPENDED T-BAR RECESSED / TRIMLESS

- 12V, 120V, 277V or any combination of two voltages
- One or Two 60 Amp Circuits
- One Independent Neutral per Circuit
- Low 1.41" Height
- 300V Per Circuit Rating
- Continuous Access Slot
- All Aluminum Housing
- Internally Polarized
- Solid Square Copper Conductors
- cULus Listed
- Durable Powder Coat Finish

60 Amp Busway is a continuous, linear power-point for lighting fixtures that is rated at 300 volts – enabling longer runs on a single circuit thus decreasing the number of circuits, power feeds and installation costs.

A full choice of powerfeeds and connectors provide the tools for unlimited possibilities in busway configurations.

60 Amp Busway is offered in three voltage types and in one or two circuits. Voltage can be mixed in two circuit configurations, for example: Two circuit / two neutral busway with 12 volts on one circuit and 277 volts on the second circuit. Each circuit is rated @ 60 amps - 300 volts maximum. The housing serves as a 100% capacity ground.

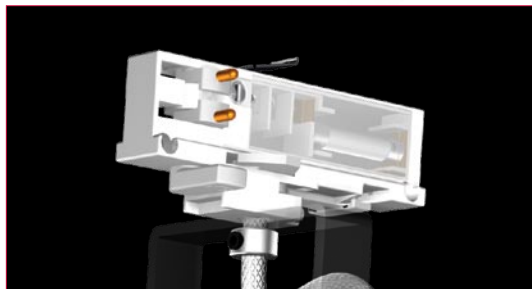
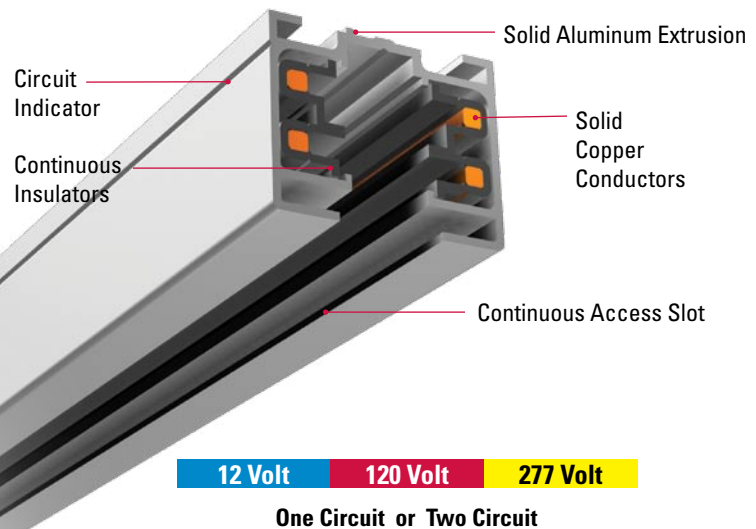

The 60 Amp Busway Adapter fits inconspicuously inside the continuous slot of the busway. The adapter includes a twist-lock lever for secure mechanical installation. The adapter can tap either of the two busway circuits. Each adapter is rated at 15 amps, 300 volts and is individually fused with an on/off switch. All 60 Amp Busway sections and adapters are mechanically interlocked according to system operating voltage. The adapter's overcenter mechanism enables fixtures to rotate up to 370°. The adapter is included with Profile Series Machined or Spun Track Fixtures.

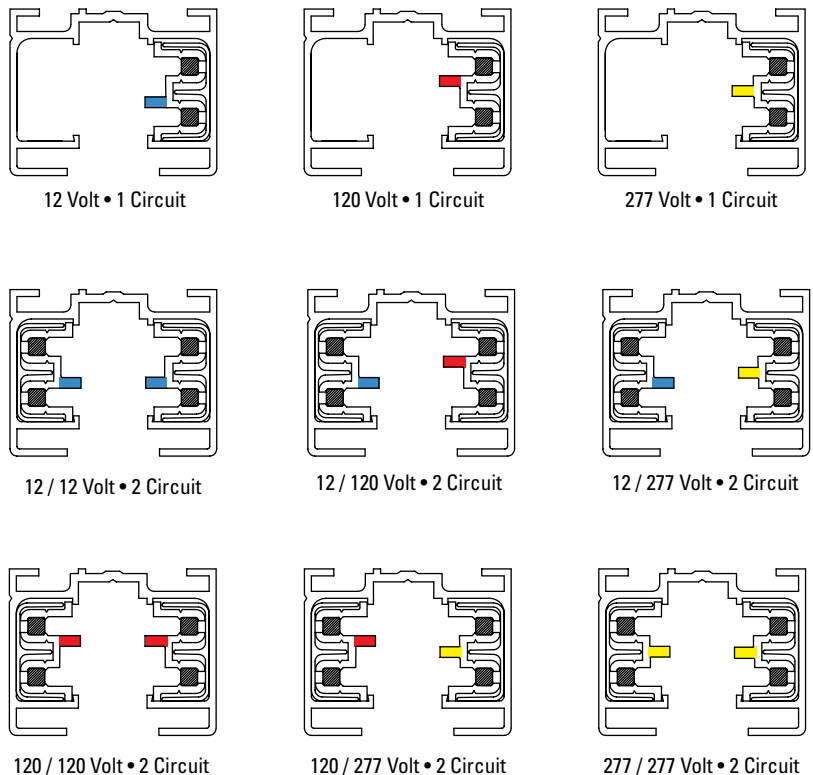

The Advantage of 60 AMP Busway

As opposed to standard 20 amp track, which requires a new circuit connection every twenty feet, 60 AMP Busway allows installations of up to two hundred sixty feet (@ 120V) on one clean, uninterrupted circuit.

This decreased number of home runs minimizes installation time and related costs by eliminating multiple wiring connections and associated electrical componentry. Complex preliminary electrical layouts are also reduced to a minimum.

SURFACE MOUNTED

page 6 - 11

- For mounting to any kind of ceiling or wall surface
- Low 1.41" Height
- Seamless mount to ceiling

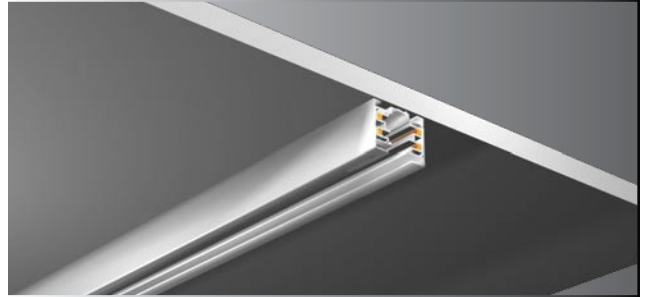

SUSPENSION MOUNTED

page 12 - 17

- For suspended mounting to any kind of ceiling surface
- May be suspended by cable, pipe stem or threaded rod
- Mounting hardware required at 10' intervals only

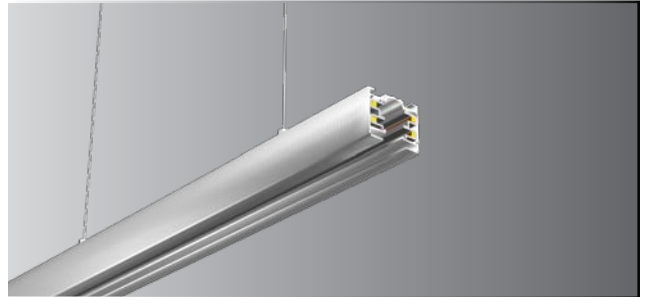

T-BAR MOUNTED

page 18 - 23

- For use with t-bar style grid ceilings
- Doubles as main runner for ceiling material
- Independently supported from ceiling by cable, pipe stem or threaded rod



RECESSED/TRIMLESS MOUNTED

page 24 - 29

- For recessed mounting in drywall ceilings
- Drywall attaches directly to busway
- Above ceiling support by cable, pipe stem or threaded rod
- Trimless installation provides seamless integration with finished ceiling

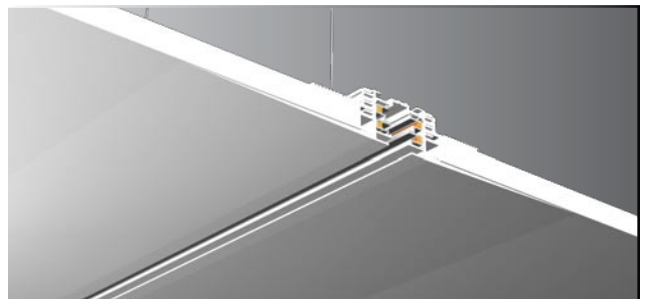

RSA LIGHTING

SURFACE MOUNTED 60 AMP BUSWAY

INSTALLS FLUSH TO CEILING SURFACE - NO GAP
BETWEEN BUSWAY AND CEILING

CLOSURE STRIP COVERS UNUSED SLOT OPENING
FOR A CLEAN LOOK

COMPATIBLE WITH ALL PROFILE SERIES FIXTURES

A FULL SELECTION OF FITTINGS FOR RETURNS
OR INTERSECTIONS IN THE BUSWAY RUN

POWER AND SUPPORT



ACCENT LIGHTS



WALL WASHERS



LIGHTING BY OTHERS

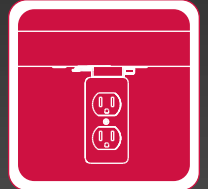

POWER RECEPTACLES

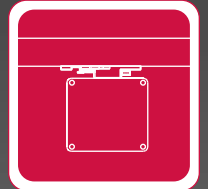

POWER TAPS (NON-LIGHTING)

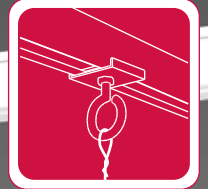

MECHANICAL SUPPORT

SURFACE MOUNTED 60 AMP BUSWAY

BUSWAY SECTIONS FOR SURFACE MOUNTING

Item	Busway Length	Circuits /Voltage	Finish
<input type="checkbox"/> AR60S 60 Amp Busway Section for Surface Mounting 	<input type="checkbox"/> Specify Length (from 1 to 20 feet in 6" increments)	<input type="checkbox"/> 1-12 1 Circuit / 12 Volt	<input type="checkbox"/> WH White
		<input type="checkbox"/> 1-120 1 Circuit / 120 Volt	<input type="checkbox"/> BK Black
		<input type="checkbox"/> 1-277 1 Circuit / 277 Volt	<input type="checkbox"/> IS Industrial Silver
		<input type="checkbox"/> 2-12-12 2 Circuit / 12 Volt + 12 Volt	<input type="checkbox"/> PT Custom Finish (please specify)
		<input type="checkbox"/> 2-12-120 2 Circuit / 12 Volt + 120 Volt	
		<input type="checkbox"/> 2-12-277 2 Circuit / 12 Volt + 277 Volt	
		<input type="checkbox"/> 2-120-120 2 Circuit / 120 Volt + 120 Volt	
		<input type="checkbox"/> 2-120-277 2 Circuit / 120 Volt + 277 Volt	
		<input type="checkbox"/> 2-277-277 2 Circuit / 277 Volt + 277 Volt	

Ordering Example: AR60S - 20 - 2-12-277 - IS

Description: 60 Amp Busway Section for Surface Mounting - 20 foot length - 2 Circuit (12 Volt + 277 Volt) - Industrial Silver Finish

60 Amp Busway is rated at 300 volts maximum per circuit. Housing serves as 100% ground. Complies with U.L. "Finger Safe" standard.

TYPICAL LAYOUT

- Manufactured with 6000 series aluminum
- Flush mount to ceiling surface

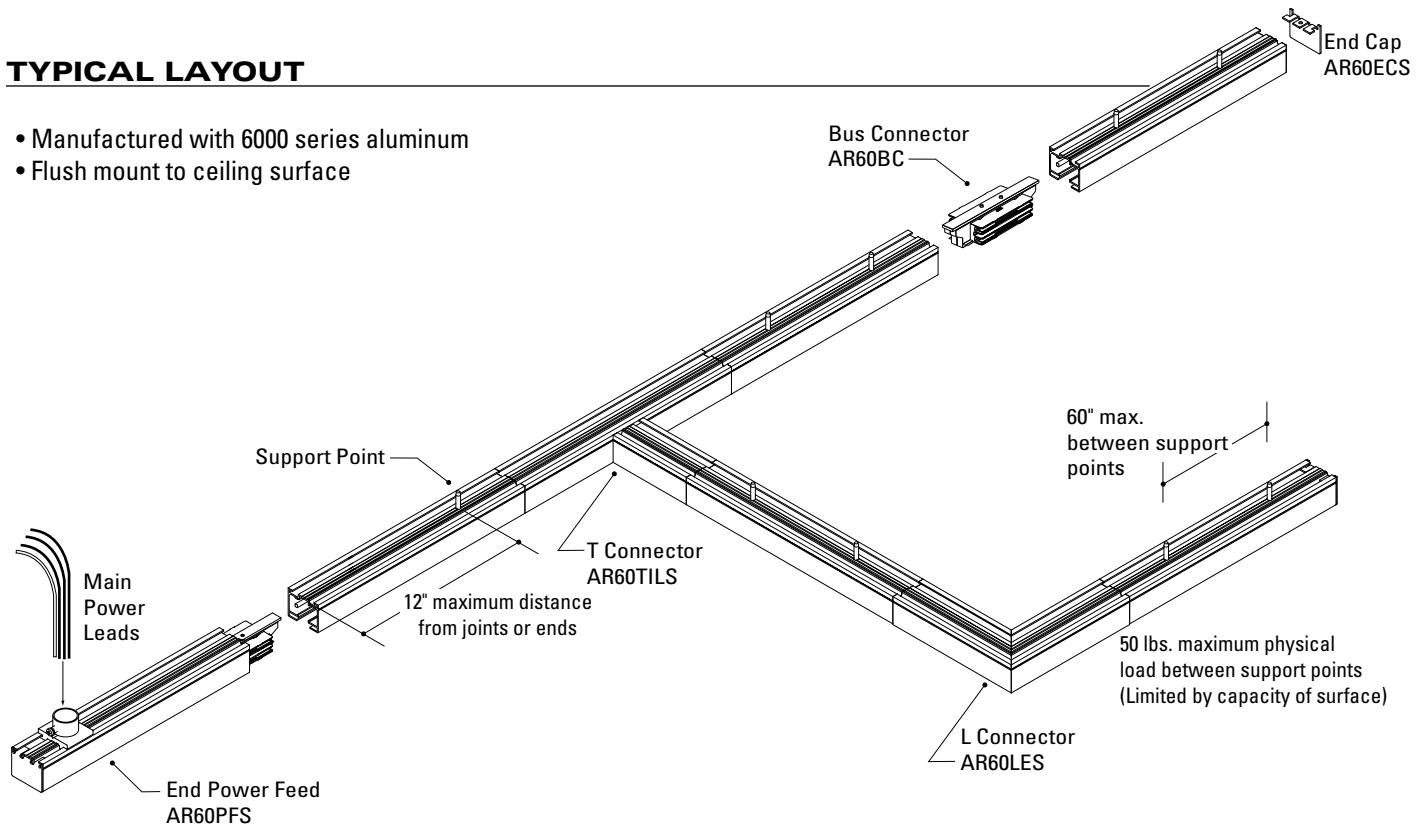

SEE PAGE 78 FOR IMPORTANT INFORMATION REGARDING TITLE 24 AND ASHRAE 90.1 COMPLIANCE

Maximum wattage and run length for single-phase Busway installation:

VOLTAGE	60 AMP BUSWAY	
	Watts	Run
12 VOLTS	720	26 FEET
120 VOLTS	7200	260 FEET
277 VOLTS	16620	595 FEET

Maximum 260' run per 60 Amp / 120 Volt feed assumes <5% voltage drop along an evenly distributed load.

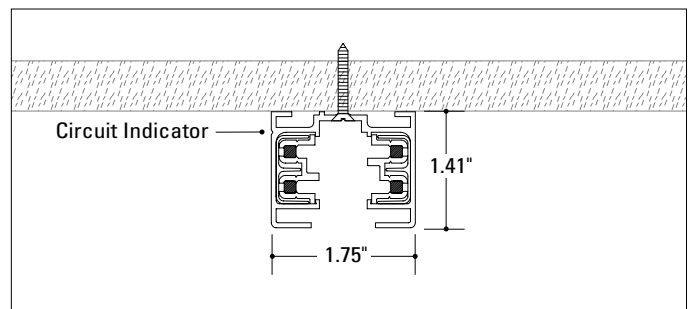

U.S. Patent Number: 6,517,363

SURFACE MOUNTED 60 AMP BUSWAY

POWERFEEDS FOR SURFACE MOUNTED BUSWAY

U.S. Patent Number: 6,517,363

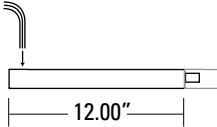
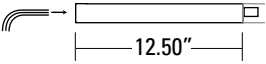
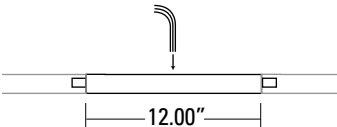
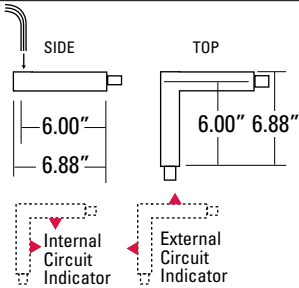
	Item	Circuits	Finish
	<input type="checkbox"/> AR60PFS End Feed (Top) for Surface Mounting	<input type="checkbox"/> 1 1 Circuit <input type="checkbox"/> 2 2 Circuit	<input type="checkbox"/> WH White <input type="checkbox"/> BK Black <input type="checkbox"/> IS Industrial Silver <input type="checkbox"/> PT Custom Finish
	<input type="checkbox"/> AR60EFS End Feed (End) for Surface Mounting	<input type="checkbox"/> 1 1 Circuit <input type="checkbox"/> 2 2 Circuit	<input type="checkbox"/> WH White <input type="checkbox"/> BK Black <input type="checkbox"/> IS Industrial Silver <input type="checkbox"/> PT Custom Finish
	<input type="checkbox"/> AR60CFS Center Feed (Top) for Surface Mounting	<input type="checkbox"/> 1 1 Circuit <input type="checkbox"/> 2 2 Circuit	<input type="checkbox"/> WH White <input type="checkbox"/> BK Black <input type="checkbox"/> IS Industrial Silver <input type="checkbox"/> PT Custom Finish
	<input type="checkbox"/> AR60LFIS 'L' Feed - Surface Mount Internal Circuit Indicator <input type="checkbox"/> AR60LFES 'L' Feed - Surface Mount External Circuit Indicator	<input type="checkbox"/> 1 1 Circuit <input type="checkbox"/> 2 2 Circuit	<input type="checkbox"/> WH White <input type="checkbox"/> BK Black <input type="checkbox"/> IS Industrial Silver <input type="checkbox"/> PT Custom Finish

SURFACE MOUNTED 60 AMP BUSWAY

CONNECTORS FOR SURFACE MOUNTED BUSWAY

	Item	Circuits	Finish
	<input type="checkbox"/> AR60LIS 'L' Connector - Surface Mount Internal Circuit Indicator	<input type="checkbox"/> 1 1 Circuit <input type="checkbox"/> 2 2 Circuit	<input type="checkbox"/> WH White <input type="checkbox"/> BK Black <input type="checkbox"/> IS Industrial Silver <input type="checkbox"/> PT Custom Finish
	<input type="checkbox"/> AR60LES 'L' Connector - Surface Mount External Circuit Indicator		
	<input type="checkbox"/> AR60TIRS 'T' Connector - Surface Mount Internal Circuit Indicator Right	<input type="checkbox"/> 1 1 Circuit <input type="checkbox"/> 2 2 Circuit	<input type="checkbox"/> WH White <input type="checkbox"/> BK Black <input type="checkbox"/> IS Industrial Silver <input type="checkbox"/> PT Custom Finish
	<input type="checkbox"/> AR60TILS 'T' Connector - Surface Mount Internal Circuit Indicator Left		
	<input type="checkbox"/> AR60TERS 'T' Connector - Surface Mount External Circuit Indicator Right		
	<input type="checkbox"/> AR60TELS 'T' Connector - Surface Mount External Circuit Indicator Left		
	<input type="checkbox"/> AR60XS 'X' Connector - Surface Mount	<input type="checkbox"/> 1 1 Circuit <input type="checkbox"/> 2 2 Circuit	<input type="checkbox"/> WH White <input type="checkbox"/> BK Black <input type="checkbox"/> IS Industrial Silver <input type="checkbox"/> PT Custom Finish
	<input type="checkbox"/> AR60BC Bus Connector (Connects two live busway ends)	<input type="checkbox"/> 1 1 Circuit <input type="checkbox"/> 2 2 Circuit	<input type="checkbox"/> WH White <input type="checkbox"/> BK Black <input type="checkbox"/> IS Industrial Silver

MONOPOINT CANOPY





Surface Mount	Item	Voltage	Finish
	<input type="checkbox"/> AR60MPS12 Monopoint Canopy Surface Mount with Integral Low Voltage Electronic Transformer. 75W max.	<input type="checkbox"/> 120 <input type="checkbox"/> 277 (one circuit only)	<input type="checkbox"/> WH White <input type="checkbox"/> BK Black <input type="checkbox"/> IS Industrial Silver <input type="checkbox"/> PT Custom Finish
	<input type="checkbox"/> AR60MPS Monopoint Canopy Surface Mount for Remote Transformer or 120V or 277V direct wire	<input type="checkbox"/> 12 <input type="checkbox"/> 120 <input type="checkbox"/> 277 (one circuit only)	

Other monopoint canopy designs are available. See page 22 for Recessed w/ Trim or page 28 for Recessed Trimless.

SURFACE MOUNTED 60 AMP BUSWAY

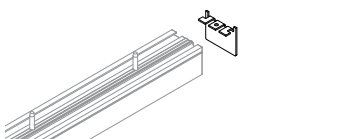
ACCESSORIES FOR SURFACE MOUNTED BUSWAY

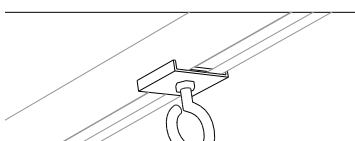
U.S. Patent Number: 6,517,363

	Item	Finish
	<input type="checkbox"/> AR60ECS End Cap w/ Set Screw	<input type="checkbox"/> WH White <input type="checkbox"/> BK Black <input type="checkbox"/> IS Industrial Silver <input type="checkbox"/> PT Custom Finish
	<input type="checkbox"/> AR60CS Closure Strip - 96" Length - Field Cuttable (Covers open/unused busway slot)	<input type="checkbox"/> WH White <input type="checkbox"/> BK Black <input type="checkbox"/> IS Industrial Silver
	<input type="checkbox"/> AR60HB Hanger Bolt Attachment Non-electrical device for suspension of accessories from the Busway.	<input type="checkbox"/> WH White <input type="checkbox"/> BK Black <input type="checkbox"/> IS Industrial Silver <input type="checkbox"/> PT Custom Finish
	<input type="checkbox"/> AR60STC T-Bar Ceiling Mounting Clip	

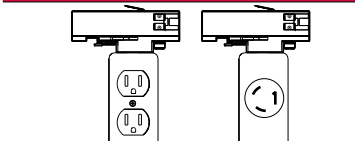
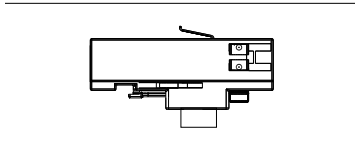
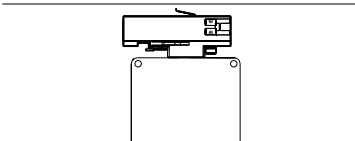
	Item	Voltage	Finish
	<input type="checkbox"/> AR60RC 3 Prong Receptacle Box (120V only) <input type="checkbox"/> AR60RCTL Twist-Lock Receptacle Box 15 Amp fused receptacle in J-Box with Busway adapter.	<input type="checkbox"/> 120 <input type="checkbox"/> 277	<input type="checkbox"/> WH White <input type="checkbox"/> BK Black <input type="checkbox"/> IS Industrial Silver <input type="checkbox"/> PT Custom Finish
	<input type="checkbox"/> AR60FA Fixture/Pendant Adapter Busway adapter to accommodate fixtures by others. Fused 15 Amp Max.	<input type="checkbox"/> 12 <input type="checkbox"/> 120 <input type="checkbox"/> 277	<input type="checkbox"/> WH White <input type="checkbox"/> BK Black <input type="checkbox"/> IS Industrial Silver
	<input type="checkbox"/> AR60JB J-Box Powertap Busway adapter with attached j-box to provide power for non-lighting equipment. Fused 15 Amp Max.	<input type="checkbox"/> 12 <input type="checkbox"/> 120 <input type="checkbox"/> 277	<input type="checkbox"/> WH White <input type="checkbox"/> BK Black <input type="checkbox"/> IS Industrial Silver <input type="checkbox"/> PT Custom Finish

SUSPENSION MOUNTED 60 AMP BUSWAY

SUSPENSION METHODS INCLUDE CABLE, STEM
OR THREADED ROD

CLOSURE STRIP COVERS UNUSED SLOT OPENING
FOR A CLEAN LOOK

COMPATIBLE WITH ALL PROFILE SERIES FIXTURES

A FULL SELECTION OF FITTINGS FOR RETURNS
OR INTERSECTIONS IN THE BUSWAY RUN

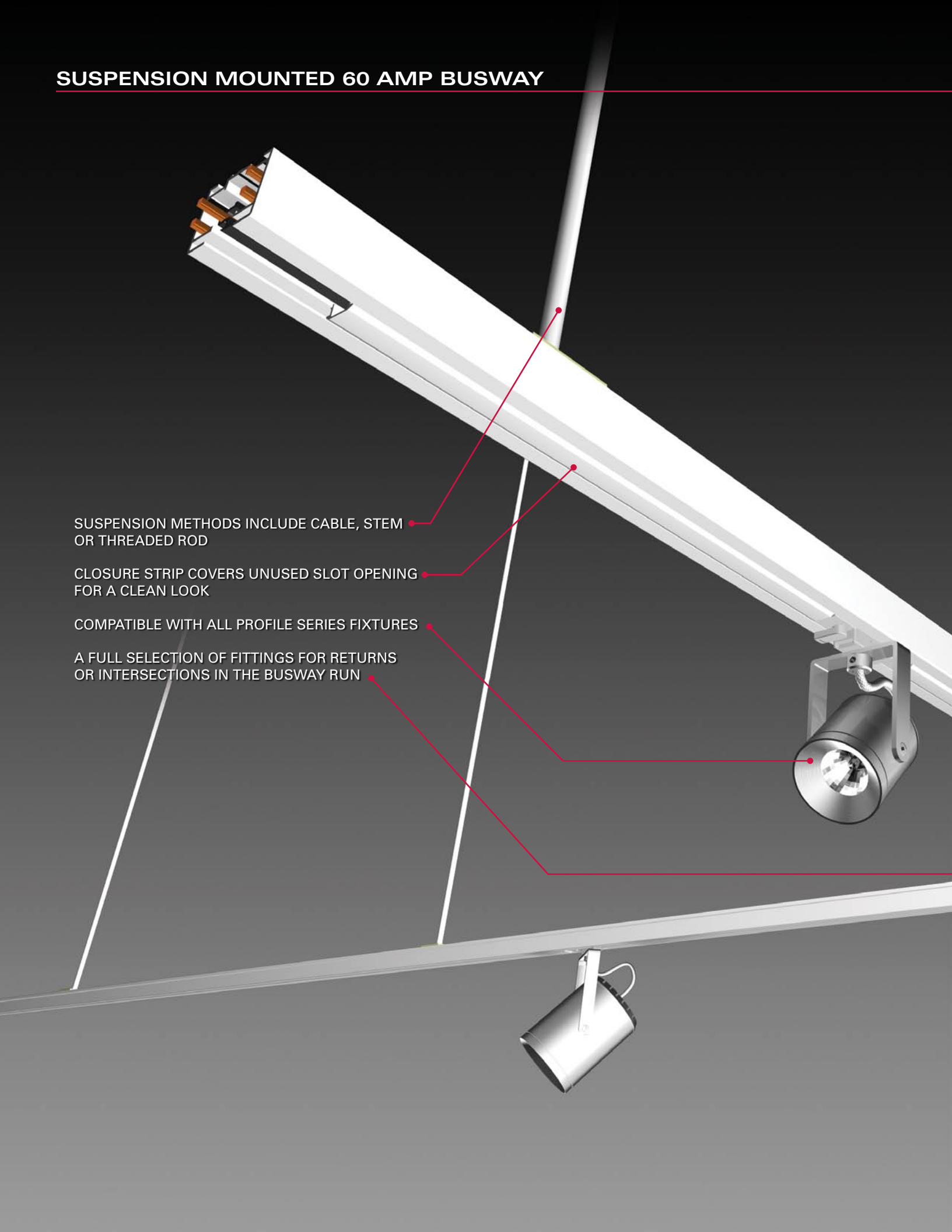

POWER AND SUPPORT



ACCENT LIGHTS

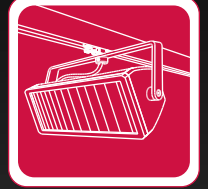

WALL WASHERS



LIGHTING BY OTHERS

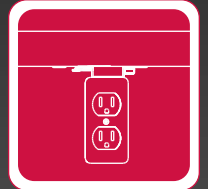

POWER RECEPTACLES

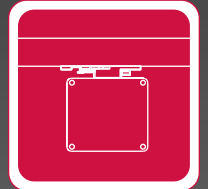

POWER TAPS (NON-LIGHTING)

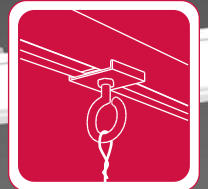

MECHANICAL SUPPORT

SUSPENSION MOUNT 60 AMP BUSWAY

BUSWAY SECTIONS FOR SUSPENDED MOUNTING

Item	Busway Length	Voltage / Circuits	Finish
<input type="checkbox"/> AR60S 60 Amp Busway Section Suspended Mounting 	<input type="checkbox"/> Specify Length (from 1 to 20 feet in 6" increments)	<input type="checkbox"/> 1-12 1 Circuit / 12 Volt	<input type="checkbox"/> WH White
		<input type="checkbox"/> 1-120 1 Circuit / 120 Volt	<input type="checkbox"/> BK Black
		<input type="checkbox"/> 1-277 1 Circuit / 277 Volt	<input type="checkbox"/> IS Industrial Silver
		<input type="checkbox"/> 2-12-12 2 Circuit / 12 Volt + 12 Volt	<input type="checkbox"/> PT Custom Finish (please specify)
		<input type="checkbox"/> 2-12-120 2 Circuit / 12 Volt + 120 Volt	
		<input type="checkbox"/> 2-12-277 2 Circuit / 12 Volt + 277 Volt	
		<input type="checkbox"/> 2-120-120 2 Circuit / 120 Volt + 120 Volt	
		<input type="checkbox"/> 2-120-277 2 Circuit / 120 Volt + 277 Volt	
		<input type="checkbox"/> 2-277-277 2 Circuit / 277 Volt + 277 Volt	

Ordering Example: AR60S - 20 - 2-12-277 - IS

Description: 60 Amp Busway Section - Suspended Mounting - 20 foot length - 2 Circuit (12 Volt + 277 Volt) - Industrial Silver Finish

60 Amp Busway is rated at 300 volts maximum per circuit. Housing serves as 100% ground. Complies with U.L. "Finger Safe" standard.

TYPICAL LAYOUT

- Manufactured with 6000 series aluminum
- Many suspension methods available

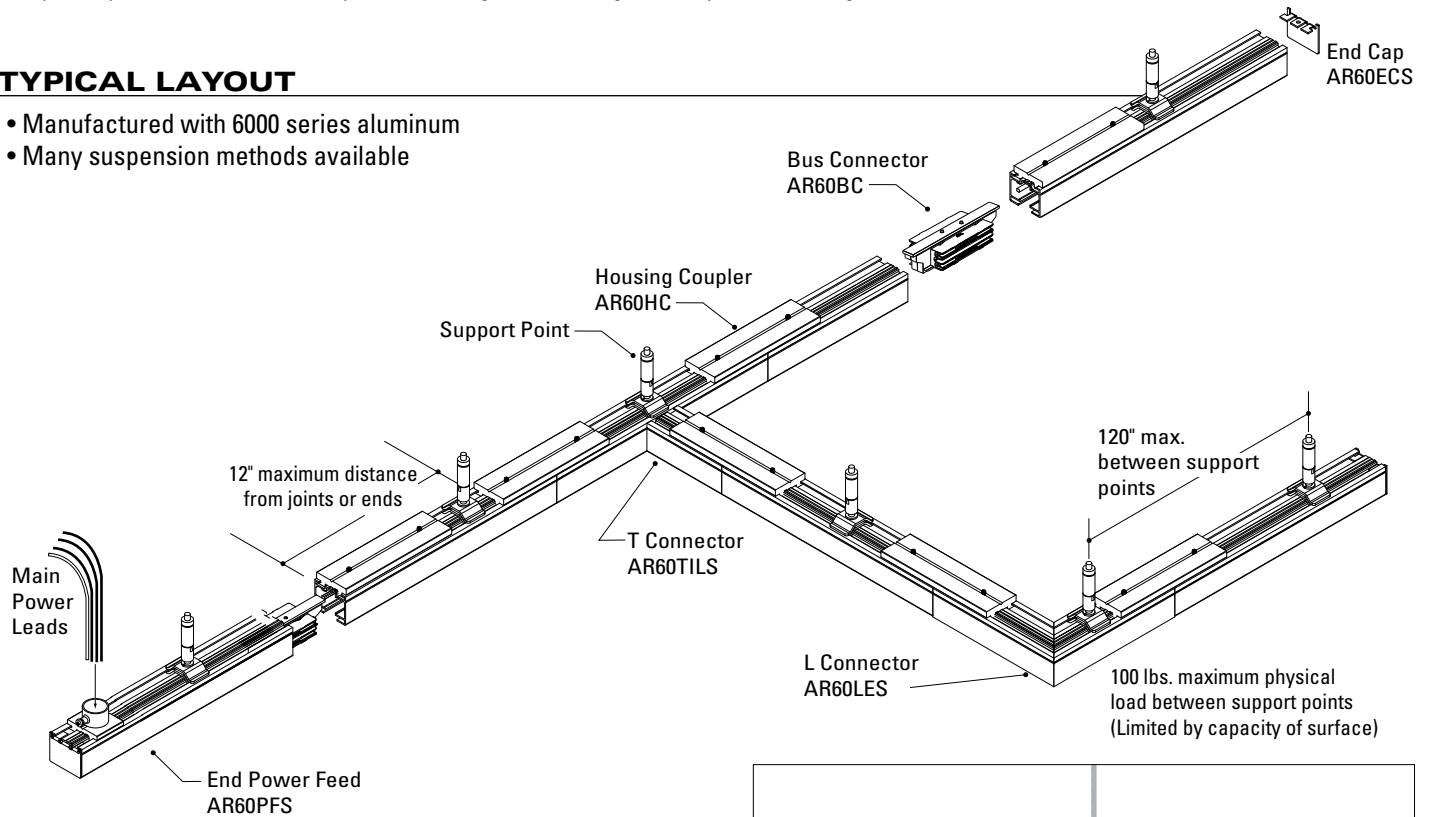

SEE PAGE 78 FOR IMPORTANT INFORMATION REGARDING TITLE 24 AND ASHRAE 90.1 COMPLIANCE

Maximum wattage and run length for single-phase Busway installation:

VOLTAGE	60 AMP BUSWAY	
	Watts	Run
12 VOLTS	720	26 FEET
120 VOLTS	7200	260 FEET
277 VOLTS	16620	595 FEET

Maximum 260' run per 60 Amp / 120 Volt feed assumes <5% voltage drop along an evenly distributed load.

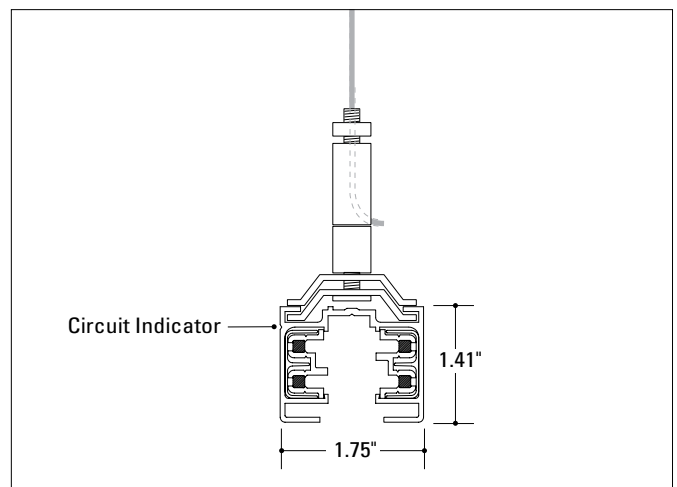

U.S. Patent Number: 6,517,363

SUSPENSION MOUNT 60 AMP BUSWAY

MOUNTING HARDWARE FOR SUSPENSION MOUNTED BUSWAY

U.S. Patent Number: 6,517,363

	Item	Finish
	<input type="checkbox"/> AR60CB Cable Suspension Kit Includes adjustable Cable Lock and 36" of suspension cable. Custom cable lengths available.	<input type="checkbox"/> WH White <input type="checkbox"/> BK Black <input type="checkbox"/> IS Industrial Silver <input type="checkbox"/> PT Custom Finish
	<input type="checkbox"/> AR60TH Threaded Coupler For accepting 1/4 - 20 threaded rod or eyebolts. Eyebolts and threaded rod by others.	<input type="checkbox"/> WH White <input type="checkbox"/> BK Black <input type="checkbox"/> IS Industrial Silver <input type="checkbox"/> PT Custom Finish
	<input type="checkbox"/> AR60SM Stem Suspension Coupler For accepting 1/8" NPT pipe stem. Ceiling connection by others.	<input type="checkbox"/> WH White <input type="checkbox"/> BK Black <input type="checkbox"/> IS Industrial Silver <input type="checkbox"/> PT Custom Finish
	<input type="checkbox"/> AR60SCK Stem / Canopy Kit Includes stem and canopy for securing to junction box (custom lengths are available)	<input type="checkbox"/> 12 12" Stem <input type="checkbox"/> 18 18" Stem <input type="checkbox"/> 24 24" Stem <input type="checkbox"/> 36 36" Stem <input type="checkbox"/> 48 48" Stem <input type="checkbox"/> WH White <input type="checkbox"/> BK Black <input type="checkbox"/> IS Industrial Silver <input type="checkbox"/> PT Custom Finish

POWERFEEDS FOR SUSPENSION MOUNTED BUSWAY

	Item	Circuits	Finish
	<input type="checkbox"/> AR60PFS End Feed (Top) for Suspension Mounting	<input type="checkbox"/> 1 1 Circuit <input type="checkbox"/> 2 2 Circuit	<input type="checkbox"/> WH White <input type="checkbox"/> BK Black <input type="checkbox"/> IS Industrial Silver <input type="checkbox"/> PT Custom Finish
	<input type="checkbox"/> AR60EFS End Feed (End) for Suspension Mounting	<input type="checkbox"/> 1 1 Circuit <input type="checkbox"/> 2 2 Circuit	<input type="checkbox"/> WH White <input type="checkbox"/> BK Black <input type="checkbox"/> IS Industrial Silver <input type="checkbox"/> PT Custom Finish
	<input type="checkbox"/> AR60CFS Center Feed (Top) for Suspension Mounting	<input type="checkbox"/> 1 1 Circuit <input type="checkbox"/> 2 2 Circuit	<input type="checkbox"/> WH White <input type="checkbox"/> BK Black <input type="checkbox"/> IS Industrial Silver <input type="checkbox"/> PT Custom Finish
	<input type="checkbox"/> AR60LFIS 'L' Feed - Suspension Mount Internal Circuit Indicator <input type="checkbox"/> AR60LFES 'L' Feed - Suspension Mount External Circuit Indicator	<input type="checkbox"/> 1 1 Circuit <input type="checkbox"/> 2 2 Circuit	<input type="checkbox"/> WH White <input type="checkbox"/> BK Black <input type="checkbox"/> IS Industrial Silver <input type="checkbox"/> PT Custom Finish

SUSPENSION MOUNTED 60 AMP BUSWAY

CONNECTORS FOR SUSPENSION MOUNTED BUSWAY



	Item	Circuits	Finish
	<input type="checkbox"/> AR60LIS 'L' Connector - Suspension Mount Internal Circuit Indicator <input type="checkbox"/> AR60LES 'L' Connector - Suspension Mount External Circuit Indicator	<input type="checkbox"/> 1 1 Circuit <input type="checkbox"/> 2 2 Circuit	<input type="checkbox"/> WH White <input type="checkbox"/> BK Black <input type="checkbox"/> IS Industrial Silver <input type="checkbox"/> PT Custom Finish
	<input type="checkbox"/> AR60TIRS 'T' Connector - Suspension Mount Internal Circuit Indicator Right <input type="checkbox"/> AR60TILS 'T' Connector - Suspension Mount Internal Circuit Indicator Left <input type="checkbox"/> AR60TERS 'T' Connector - Suspension Mount External Circuit Indicator Right <input type="checkbox"/> AR60TELS 'T' Connector - Suspension Mount External Circuit Indicator Left	<input type="checkbox"/> 1 1 Circuit <input type="checkbox"/> 2 2 Circuit	<input type="checkbox"/> WH White <input type="checkbox"/> BK Black <input type="checkbox"/> IS Industrial Silver <input type="checkbox"/> PT Custom Finish
	<input type="checkbox"/> AR60XS 'X' Connector - Suspension Mount	<input type="checkbox"/> 1 1 Circuit <input type="checkbox"/> 2 2 Circuit	<input type="checkbox"/> WH White <input type="checkbox"/> BK Black <input type="checkbox"/> IS Industrial Silver <input type="checkbox"/> PT Custom Finish
	<input type="checkbox"/> AR60BC Bus Connector (Connects two live busway ends)	<input type="checkbox"/> 1 1 Circuit <input type="checkbox"/> 2 2 Circuit	<input type="checkbox"/> WH White <input type="checkbox"/> BK Black <input type="checkbox"/> IS Industrial Silver

U.S. Patent Number: 6,517,363

SUSPENSION MOUNTED 60 AMP BUSWAY

ACCESSORIES FOR SUSPENSION MOUNTED BUSWAY

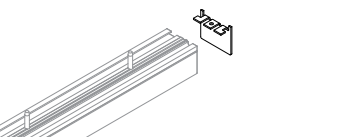
U.S. Patent Number: 6,517,363

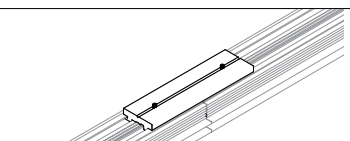
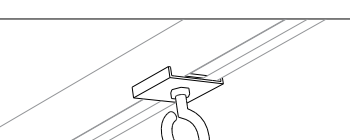
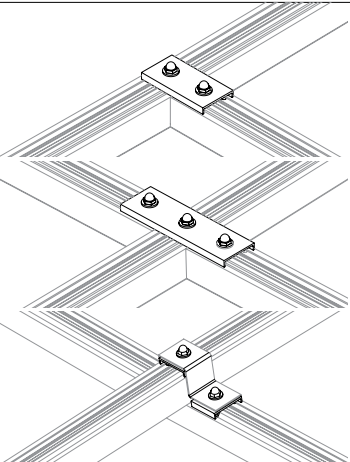
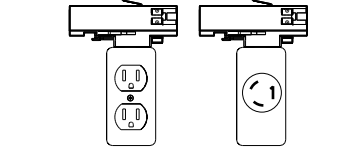
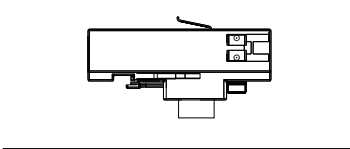
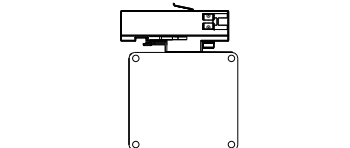
	Item	Finish	
	<input type="checkbox"/> AR60ECS End Cap w/ Set Screw	<input type="checkbox"/> WH White <input type="checkbox"/> BK Black <input type="checkbox"/> IS Industrial Silver <input type="checkbox"/> PT Custom Finish	
	<input type="checkbox"/> AR60CS Closure Strip - 96" Length - Field Cuttable (Covers open/unused busway slot)	<input type="checkbox"/> WH White <input type="checkbox"/> BK Black <input type="checkbox"/> IS Industrial Silver	
	<input type="checkbox"/> AR60HC Housing Coupler (Provides joint support above busway)	<input type="checkbox"/> WH White <input type="checkbox"/> BK Black <input type="checkbox"/> IS Industrial Silver <input type="checkbox"/> PT Custom Finish	
	<input type="checkbox"/> AR60HB Hanger Bolt Attachment Non-electrical device for suspension of accessories from the Busway.	<input type="checkbox"/> WH White <input type="checkbox"/> BK Black <input type="checkbox"/> IS Industrial Silver <input type="checkbox"/> PT Custom Finish	
	<input type="checkbox"/> AR60GBT Grid Bracket "T" Connect (non-powered) Provides an inexpensive method for securing two busway sections together to form a "T" or "L" configured intersection.	<input type="checkbox"/> WH White <input type="checkbox"/> BK Black <input type="checkbox"/> IS Industrial Silver <input type="checkbox"/> PT Custom Finish	
	<input type="checkbox"/> AR60GBX Grid Bracket "X" Connect (non-powered) Provides an inexpensive method for securing three busway sections together to form an "X" configured intersection.		
	<input type="checkbox"/> AR60GU Grid Bracket "Over/Under" Connect (non-powered) Provides an inexpensive method for securing two busway sections together on different planes to form a "T" or "X" configured intersection.		
	Item	Voltage	Finish
	<input type="checkbox"/> AR60RC 3 Prong Receptacle Box (120V only) <input type="checkbox"/> AR60RCTL Twist-Lock Receptacle Box 15 Amp fused receptacle in J-Box with Busway adapter.	<input type="checkbox"/> 120 <input type="checkbox"/> 277	<input type="checkbox"/> WH White <input type="checkbox"/> BK Black <input type="checkbox"/> IS Industrial Silver <input type="checkbox"/> PT Custom Finish
	<input type="checkbox"/> AR60FA Fixture/Pendant Adapter Busway adapter to accommodate fixtures by others. Fused 15 Amp Max.	<input type="checkbox"/> 12 <input type="checkbox"/> 120 <input type="checkbox"/> 277	<input type="checkbox"/> WH White <input type="checkbox"/> BK Black <input type="checkbox"/> IS Industrial Silver
	<input type="checkbox"/> AR60JB J-Box Powertap Busway adapter with attached j-box to provide power for non-lighting equipment. Fused 15 Amp Max.	<input type="checkbox"/> 12 <input type="checkbox"/> 120 <input type="checkbox"/> 277	<input type="checkbox"/> WH White <input type="checkbox"/> BK Black <input type="checkbox"/> IS Industrial Silver <input type="checkbox"/> PT Custom Finish

T-BAR GRID CEILING MOUNTED 60 AMP BUSWAY



UNIVERSAL T-BAR CLIP ACCOMMODATES HARDWARE BY GRID CEILING MANUFACTURERS

FLANGE DOUBLES AS CEILING SUPPORT

CLOSURE STRIP COVERS UNUSED SLOT OPENING FOR A CLEAN LOOK

COMPATIBLE WITH ALL PROFILE SERIES FIXTURES

A FULL SELECTION OF FITTINGS FOR RETURNS OR INTERSECTIONS IN THE BUSWAY RUN



POWER AND SUPPORT



ACCENT LIGHTS



WALL WASHERS



LIGHTING BY OTHERS

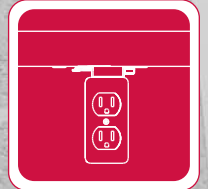

POWER RECEPTACLES



POWER TAPS (NON-LIGHTING)

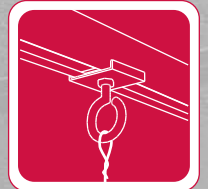

MECHANICAL SUPPORT

T-BAR CEILING MOUNTED 60 AMP BUSWAY

BUSWAY SECTIONS FOR T-BAR CEILING MOUNTING

Item	Busway Length	Voltage / Circuits	Finish
<input type="checkbox"/> AR60T 60 Amp Busway Section for T-Bar Mounting	<input type="checkbox"/> Specify Length (from 1 to 20 feet in 6" increments)	<input type="checkbox"/> 1-12 1 Circuit / 12 Volt <input type="checkbox"/> 1-120 1 Circuit / 120 Volt <input type="checkbox"/> 1-277 1 Circuit / 277 Volt <input type="checkbox"/> 2-12-12 2 Circuit / 12 Volt + 12 Volt <input type="checkbox"/> 2-12-120 2 Circuit / 12 Volt + 120 Volt <input type="checkbox"/> 2-12-277 2 Circuit / 12 Volt + 277 Volt <input type="checkbox"/> 2-120-120 2 Circuit / 120 Volt + 120 Volt <input type="checkbox"/> 2-120-277 2 Circuit / 120 Volt + 277 Volt <input type="checkbox"/> 2-277-277 2 Circuit / 277 Volt + 277 Volt	<input type="checkbox"/> WH White <input type="checkbox"/> BK Black <input type="checkbox"/> IS Industrial Silver <input type="checkbox"/> PT Custom Finish (please specify)



Ordering Example: AR60T - 20 - 2-12-277 - IS

Description: 60 Amp Busway Section for T-Bar Mounting - 20 foot length - 2 Circuit (12 Volt + 277 Volt) - Industrial Silver Finish

60 Amp Busway is rated at 300 volts maximum per circuit. Housing serves as 100% ground. Complies with U.L. "Finger Safe" standard.

TYPICAL LAYOUT

- Manufactured with 6000 series aluminum
- For use with t-bar type ceilings
- Has a 1" surface flange that doubles as ceiling panel support

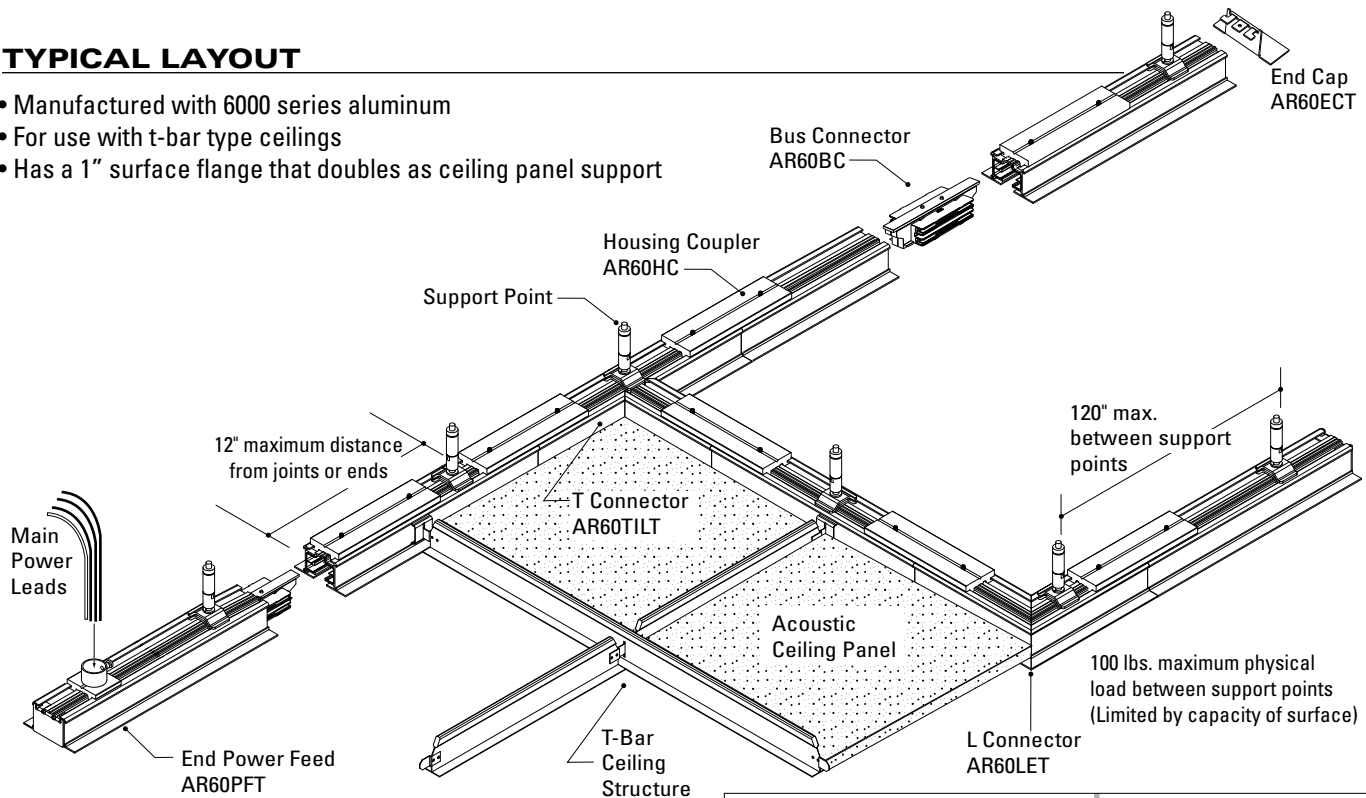

SEE PAGE 78 FOR IMPORTANT INFORMATION REGARDING TITLE 24 AND ASHRAE 90.1 COMPLIANCE

Maximum wattage and run length for single-phase Busway installation:

VOLTAGE	60 AMP BUSWAY	
	Watts	Run
12 VOLTS	720	26 FEET
120 VOLTS	7200	260 FEET
277 VOLTS	16620	595 FEET

Maximum 260' run per 60 Amp / 120 Volt feed assumes <5% voltage drop along an evenly distributed load.

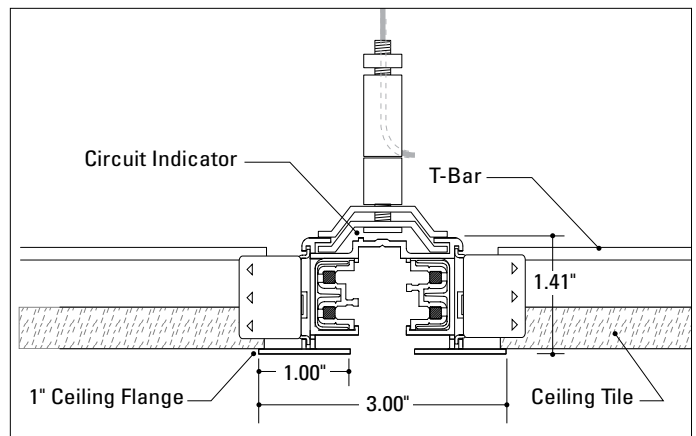

U.S. Patent Number: 6,517,363

T-BAR CEILING MOUNTED 60 AMP BUSWAY

MOUNTING HARDWARE FOR T-BAR CEILING MOUNTED BUSWAY

U.S. Patent Number: 6,517,363

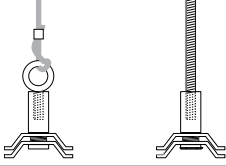
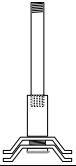
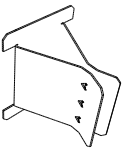
	Item	Finish
	<input type="checkbox"/> AR60CB Cable Suspension Kit Includes adjustable Cable Lock and 36" of suspension cable. Custom cable lengths available.	<input type="checkbox"/> WH White <input type="checkbox"/> BK Black <input type="checkbox"/> IS Industrial Silver <input type="checkbox"/> PT Custom Finish
	<input type="checkbox"/> AR60TH Threaded Coupler For accepting 1/4" - 20 threaded rod or eyebolts. Eyebolts and threaded rod by others.	<input type="checkbox"/> WH White <input type="checkbox"/> BK Black <input type="checkbox"/> IS Industrial Silver <input type="checkbox"/> PT Custom Finish
	<input type="checkbox"/> AR60SM Stem Suspension Coupler For accepting 1/8" NPT pipe stem. Ceiling connection by others.	<input type="checkbox"/> WH White <input type="checkbox"/> BK Black <input type="checkbox"/> IS Industrial Silver <input type="checkbox"/> PT Custom Finish
	<input type="checkbox"/> AR60TBC T-Bar Attachment Clip Universal clip secures most types of T-Bar ceiling hardware to busway lengths. Two clips per foot are supplied with busway lengths.	

POWERFEEDS FOR T-BAR CEILING MOUNTED BUSWAY

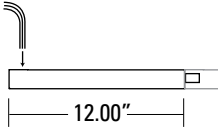
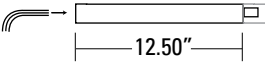
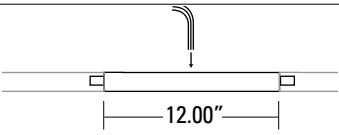
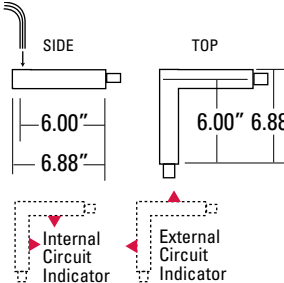
	Item	Circuits	Finish
	<input type="checkbox"/> AR60PFT End Feed (Top) for T-Bar Mounting	<input type="checkbox"/> 1 1 Circuit <input type="checkbox"/> 2 2 Circuit	<input type="checkbox"/> WH White <input type="checkbox"/> BK Black <input type="checkbox"/> IS Industrial Silver <input type="checkbox"/> PT Custom Finish
	<input type="checkbox"/> AR60EFT End Feed (End) for T-Bar Mounting	<input type="checkbox"/> 1 1 Circuit <input type="checkbox"/> 2 2 Circuit	<input type="checkbox"/> WH White <input type="checkbox"/> BK Black <input type="checkbox"/> IS Industrial Silver <input type="checkbox"/> PT Custom Finish
	<input type="checkbox"/> AR60CFT Center Feed (Top) for T-Bar Mounting	<input type="checkbox"/> 1 1 Circuit <input type="checkbox"/> 2 2 Circuit	<input type="checkbox"/> WH White <input type="checkbox"/> BK Black <input type="checkbox"/> IS Industrial Silver <input type="checkbox"/> PT Custom Finish
	<input type="checkbox"/> AR60LFIT 'L' Feed - T-Bar Mount Internal Circuit Indicator <input type="checkbox"/> AR60LFET 'L' Feed - T-Bar Mount External Circuit Indicator	<input type="checkbox"/> 1 1 Circuit <input type="checkbox"/> 2 2 Circuit	<input type="checkbox"/> WH White <input type="checkbox"/> BK Black <input type="checkbox"/> IS Industrial Silver <input type="checkbox"/> PT Custom Finish

T-BAR CEILING MOUNTED 60 AMP BUSWAY

CONNECTORS FOR T-BAR CEILING MOUNTED BUSWAY

	Item	Circuits	Finish
	<input type="checkbox"/> AR60LIT 'L' Connector - T-Bar Mount Internal Circuit Indicator <input type="checkbox"/> AR60LET 'L' Connector - T-Bar Mount External Circuit Indicator	<input type="checkbox"/> 1 1 Circuit <input type="checkbox"/> 2 2 Circuit	<input type="checkbox"/> WH White <input type="checkbox"/> BK Black <input type="checkbox"/> IS Industrial Silver <input type="checkbox"/> PT Custom Finish
	<input type="checkbox"/> AR60TIRT 'T' Connector - T-Bar Mount Internal Circuit Indicator Right <input type="checkbox"/> AR60TILT 'T' Connector - T-Bar Mount Internal Circuit Indicator Left <input type="checkbox"/> AR60TERT 'T' Connector - T-Bar Mount External Circuit Indicator Right <input type="checkbox"/> AR60TELT 'T' Connector - T-Bar Mount External Circuit Indicator Left	<input type="checkbox"/> 1 1 Circuit <input type="checkbox"/> 2 2 Circuit	<input type="checkbox"/> WH White <input type="checkbox"/> BK Black <input type="checkbox"/> IS Industrial Silver <input type="checkbox"/> PT Custom Finish
	<input type="checkbox"/> AR60XT 'X' Connector - T-Bar Mount	<input type="checkbox"/> 1 1 Circuit <input type="checkbox"/> 2 2 Circuit	<input type="checkbox"/> WH White <input type="checkbox"/> BK Black <input type="checkbox"/> IS Industrial Silver <input type="checkbox"/> PT Custom Finish
	<input type="checkbox"/> AR60BC Bus Connector (Connects two live busway ends)	<input type="checkbox"/> 1 1 Circuit <input type="checkbox"/> 2 2 Circuit	<input type="checkbox"/> WH White <input type="checkbox"/> BK Black <input type="checkbox"/> IS Industrial Silver

MONOPOINT CANOPY

Recessed / Rectangular Trim	Item	Voltage	Finish
	<input type="checkbox"/> AR60MPT12 Monopoint Canopy Recessed w/ Trim with Integral Low Voltage Electronic Transformer. 75W max.	<input type="checkbox"/> 120 <input type="checkbox"/> 277 (one circuit only)	<input type="checkbox"/> WH White <input type="checkbox"/> BK Black <input type="checkbox"/> IS Industrial Silver <input type="checkbox"/> PT Custom Finish
	<input type="checkbox"/> AR60MPT Monopoint Canopy Recessed w/ Trim for Remote Transformer or 120V or 277V direct wire	<input type="checkbox"/> 12 <input type="checkbox"/> 120 <input type="checkbox"/> 277 (one circuit only)	

Other monopoint canopy designs are available. See page 10 for Surface Mounted or page 28 for Recessed Trimless.

T-BAR CEILING MOUNTED 60 AMP BUSWAY

ACCESSORIES FOR T-BAR MOUNTED BUSWAY

U.S. Patent Number: 6,517,363

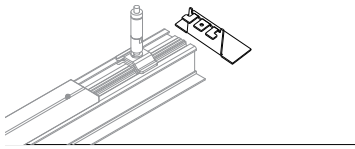
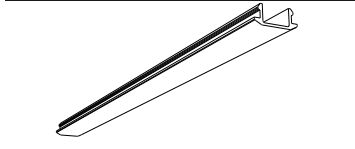
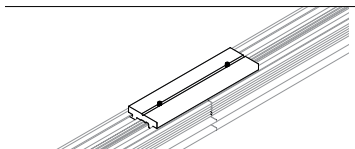
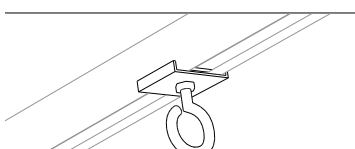
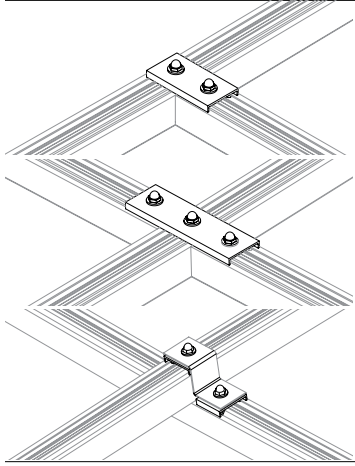
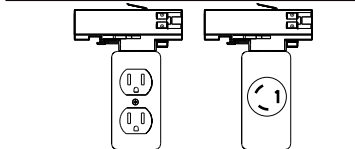
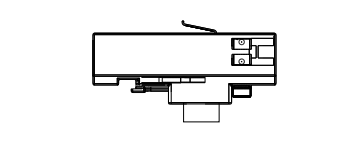
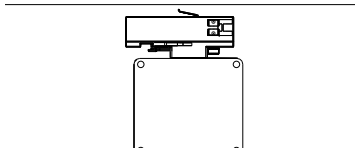
	Item	Voltage	Finish
	<input type="checkbox"/> AR60ECT End Cap w/ Set Screw		<input type="checkbox"/> WH White <input type="checkbox"/> BK Black <input type="checkbox"/> IS Industrial Silver <input type="checkbox"/> PT Custom Finish
	<input type="checkbox"/> AR60CS Closure Strip - 96" Length - Field Cuttable (Covers open/unused busway slot)		<input type="checkbox"/> WH White <input type="checkbox"/> BK Black <input type="checkbox"/> IS Industrial Silver
	<input type="checkbox"/> AR60HC Housing Coupler (Provides joint support above busway)		<input type="checkbox"/> WH White <input type="checkbox"/> BK Black <input type="checkbox"/> IS Industrial Silver <input type="checkbox"/> PT Custom Finish
	<input type="checkbox"/> AR60HB Hanger Bolt Attachment Non-electrical device for suspension of accessories from the Busway.		<input type="checkbox"/> WH White <input type="checkbox"/> BK Black <input type="checkbox"/> IS Industrial Silver <input type="checkbox"/> PT Custom Finish
	<input type="checkbox"/> AR60GBT Grid Bracket "T" Connect (non-powered) Provides an inexpensive method for securing two busway sections together to form a "T" or "L" configured intersection.		<input type="checkbox"/> WH White <input type="checkbox"/> BK Black <input type="checkbox"/> IS Industrial Silver <input type="checkbox"/> PT Custom Finish
	<input type="checkbox"/> AR60GBX Grid Bracket "X" Connect (non-powered) Provides an inexpensive method for securing three busway sections together to form an "X" configured intersection.		
	<input type="checkbox"/> AR60GU Grid Bracket "Over/Under" Connect (non-powered) Provides an inexpensive method for securing two busway sections together on different planes to form a "T" or "X" configured intersection.		
	Item	Voltage	Finish
	<input type="checkbox"/> AR60RC 3 Prong Receptacle Box (120V only) <input type="checkbox"/> AR60RCTL Twist-Lock Receptacle Box 15 Amp fused receptacle in J-Box with Busway adapter.	<input type="checkbox"/> 120 <input type="checkbox"/> 277	<input type="checkbox"/> WH White <input type="checkbox"/> BK Black <input type="checkbox"/> IS Industrial Silver <input type="checkbox"/> PT Custom Finish
	<input type="checkbox"/> AR60FA Fixture/Pendant Adapter Busway adapter to accommodate fixtures by others. Fused 15 Amp Max.	<input type="checkbox"/> 12 <input type="checkbox"/> 120 <input type="checkbox"/> 277	<input type="checkbox"/> WH White <input type="checkbox"/> BK Black <input type="checkbox"/> IS Industrial Silver
	<input type="checkbox"/> AR60JB J-Box Powertap Busway adapter with attached j-box to provide power for non-lighting equipment. Fused 15 Amp Max.	<input type="checkbox"/> 12 <input type="checkbox"/> 120 <input type="checkbox"/> 277	<input type="checkbox"/> WH White <input type="checkbox"/> BK Black <input type="checkbox"/> IS Industrial Silver <input type="checkbox"/> PT Custom Finish

RECESSED/TRIMLESS MOUNTED 60 AMP BUSWAY



ACCOMMODATES DRYWALL CEILINGS FROM 1/2" TO 1-3/8" THICK.

CEILING MUDDING COMPOUND IS APPLIED RIGHT TO THE EDGE OF THE OPENING

CLOSURE STRIP COVERS UNUSED SLOT OPENING FOR A CLEAN LOOK

COMPATIBLE WITH ALL PROFILE SERIES FIXTURES

A FULL SELECTION OF FITTINGS FOR RETURNS OR INTERSECTIONS IN THE BUSWAY RUN



POWER AND SUPPORT



ACCENT LIGHTS



WALL WASHERS



LIGHTING BY OTHERS

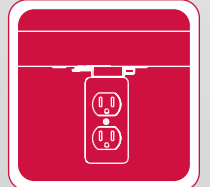

POWER RECEPTACLES

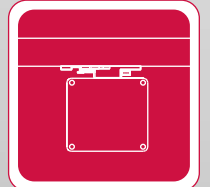

POWER TAPS (NON-LIGHTING)

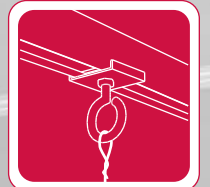

MECHANICAL SUPPORT

RECESSED/TRIMLESS MOUNTED 60 AMP BUSWAY

BUSWAY SECTIONS FOR RECESSED/TRIMLESS MOUNTING

Item	Busway Length	Voltage / Circuits	Finish
<input type="checkbox"/> AR60R 60 Amp Busway Section for Recessed Mounting 	<input type="checkbox"/> Specify Length (from 1 to 20 feet in 6" increments)	<input type="checkbox"/> 1-12 1 Circuit / 12 Volt	<input type="checkbox"/> WH White
		<input type="checkbox"/> 1-120 1 Circuit / 120 Volt	<input type="checkbox"/> BK Black
		<input type="checkbox"/> 1-277 1 Circuit / 277 Volt	<input type="checkbox"/> IS Industrial Silver
		<input type="checkbox"/> 2-12-12 2 Circuit / 12 Volt + 12 Volt	<input type="checkbox"/> PT Custom Finish (please specify)
		<input type="checkbox"/> 2-12-120 2 Circuit / 12 Volt + 120 Volt	
		<input type="checkbox"/> 2-12-277 2 Circuit / 12 Volt + 277 Volt	
		<input type="checkbox"/> 2-120-120 2 Circuit / 120 Volt + 120 Volt	
		<input type="checkbox"/> 2-120-277 2 Circuit / 120 Volt + 277 Volt	
		<input type="checkbox"/> 2-277-277 2 Circuit / 277 Volt + 277 Volt	

Ordering Example: AR60R - 20 - 2-12-277 - IS

Description: 60 Amp Busway Section for Recessed Mounting - 20 foot length - 2 Circuit (12 Volt + 277 Volt) - Industrial Silver Finish

60 Amp Busway is rated at 300 volts maximum per circuit. Housing serves as 100% ground. Complies with U.L. "Finger Safe" standard.

TYPICAL LAYOUT

- Manufactured with 6000 series aluminum
- Can accommodate 1/2" - 1 3/8" drywall
- Provides seamless installation

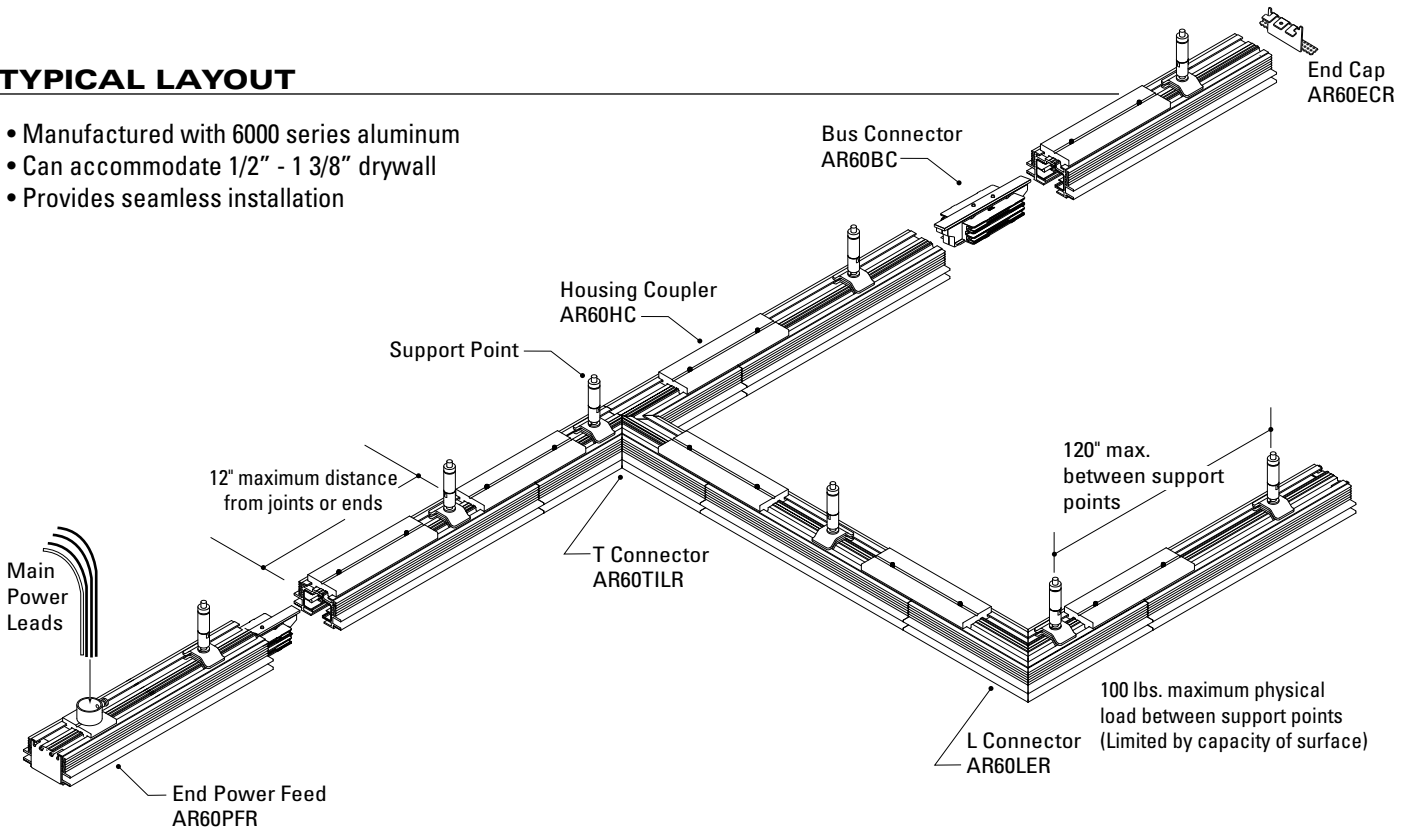

SEE PAGE 78 FOR IMPORTANT INFORMATION REGARDING TITLE 24 AND ASHRAE 90.1 COMPLIANCE

Maximum wattage and run length for single-phase Busway installation:

VOLTAGE	60 AMP BUSWAY	
	Watts	Run
12 VOLTS	720	26 FEET
120 VOLTS	7200	260 FEET
277 VOLTS	16620	595 FEET

Maximum 260' run per 60 Amp / 120 Volt feed assumes <5% voltage drop along an evenly distributed load.

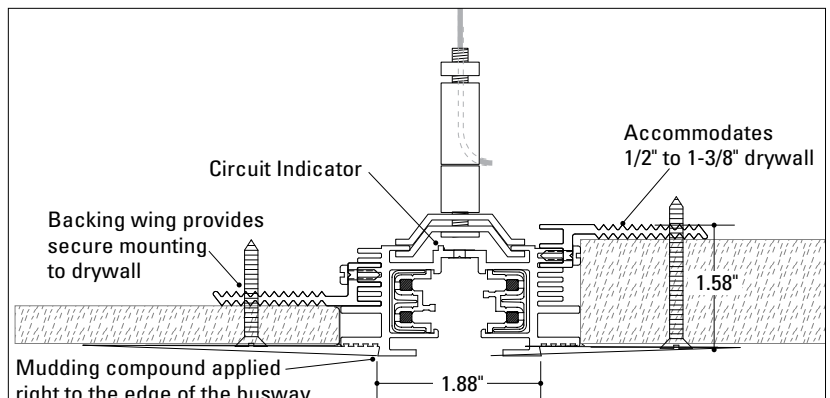

U.S. Patent Number: 6,517,363

RECESSED/TRIMLESS MOUNTED 60 AMP BUSWAY

MOUNTING HARDWARE FOR RECESSED/TRIMLESS MOUNTED BUSWAY

U.S. Patent Number: 6,517,363

	Item	Finish
	<input type="checkbox"/> AR60CB Cable Suspension Kit Includes adjustable Cable Lock and 36" of suspension cable. Custom cable lengths available.	<input type="checkbox"/> WH White <input type="checkbox"/> BK Black <input type="checkbox"/> IS Industrial Silver <input type="checkbox"/> PT Custom Finish
	<input type="checkbox"/> AR60TH Threaded Coupler For accepting 1/4 - 20 threaded rod or eyebolts. Eyebolts and threaded rod by others.	<input type="checkbox"/> WH White <input type="checkbox"/> BK Black <input type="checkbox"/> IS Industrial Silver <input type="checkbox"/> PT Custom Finish
	<input type="checkbox"/> AR60SM Stem Suspension Coupler For accepting 1/8" NPT pipe stem. Above ceiling connection by others.	<input type="checkbox"/> WH White <input type="checkbox"/> BK Black <input type="checkbox"/> IS Industrial Silver <input type="checkbox"/> PT Custom Finish

POWERFEEDS FOR RECESSED/TRIMLESS MOUNTED BUSWAY

	Item	Circuits	Finish
	<input type="checkbox"/> AR60PFR End Feed (Top) for Recessed Mounting	<input type="checkbox"/> 1 1 Circuit <input type="checkbox"/> 2 2 Circuit	<input type="checkbox"/> WH White <input type="checkbox"/> BK Black <input type="checkbox"/> IS Industrial Silver <input type="checkbox"/> PT Custom Finish
	<input type="checkbox"/> AR60EFR End Feed (End) for Recessed Mounting	<input type="checkbox"/> 1 1 Circuit <input type="checkbox"/> 2 2 Circuit	<input type="checkbox"/> WH White <input type="checkbox"/> BK Black <input type="checkbox"/> IS Industrial Silver <input type="checkbox"/> PT Custom Finish
	<input type="checkbox"/> AR60CFR Center Feed (Top) for Recessed Mounting	<input type="checkbox"/> 1 1 Circuit <input type="checkbox"/> 2 2 Circuit	<input type="checkbox"/> WH White <input type="checkbox"/> BK Black <input type="checkbox"/> IS Industrial Silver <input type="checkbox"/> PT Custom Finish
	<input type="checkbox"/> AR60LFIR 'L' Feed - Recessed Mount Internal Circuit Indicator <input type="checkbox"/> AR60LFR 'L' Feed - Recessed Mount External Circuit Indicator	<input type="checkbox"/> 1 1 Circuit <input type="checkbox"/> 2 2 Circuit	<input type="checkbox"/> WH White <input type="checkbox"/> BK Black <input type="checkbox"/> IS Industrial Silver <input type="checkbox"/> PT Custom Finish

RECESSED/TRIMLESS MOUNTED 60 AMP BUSWAY

CONNECTORS FOR RECESSED/TRIMLESS MOUNTED BUSWAY

	Item	Circuits	Finish
	<input type="checkbox"/> AR60LIR 'L' Connector - Recessed Mount Internal Circuit Indicator <input type="checkbox"/> AR60LER 'L' Connector - Recessed Mount External Circuit Indicator	<input type="checkbox"/> 1 1 Circuit <input type="checkbox"/> 2 2 Circuit	<input type="checkbox"/> WH White <input type="checkbox"/> BK Black <input type="checkbox"/> IS Industrial Silver <input type="checkbox"/> PT Custom Finish
	<input type="checkbox"/> AR60TIRR 'T' Connector - Recessed Mount Internal Circuit Indicator Right <input type="checkbox"/> AR60TILR 'T' Connector - Recessed Mount Internal Circuit Indicator Left <input type="checkbox"/> AR60TERR 'T' Connector - Recessed Mount External Circuit Indicator Right <input type="checkbox"/> AR60TELR 'T' Connector - Recessed Mount External Circuit Indicator Left	<input type="checkbox"/> 1 1 Circuit <input type="checkbox"/> 2 2 Circuit	<input type="checkbox"/> WH White <input type="checkbox"/> BK Black <input type="checkbox"/> IS Industrial Silver <input type="checkbox"/> PT Custom Finish
	<input type="checkbox"/> AR60XR 'X' Connector - Recessed Mount	<input type="checkbox"/> 1 1 Circuit <input type="checkbox"/> 2 2 Circuit	<input type="checkbox"/> WH White <input type="checkbox"/> BK Black <input type="checkbox"/> IS Industrial Silver <input type="checkbox"/> PT Custom Finish
	<input type="checkbox"/> AR60BC Bus Connector (Connects two live busway ends)	<input type="checkbox"/> 1 1 Circuit <input type="checkbox"/> 2 2 Circuit	<input type="checkbox"/> WH White <input type="checkbox"/> BK Black <input type="checkbox"/> IS Industrial Silver

MONOPOINT CANOPY

Recessed / Rectangular Trimless	Item	Voltage	Finish
	<input type="checkbox"/> AR60MPR12 Monopoint Canopy Recessed Trimless with Integral Low Voltage Electronic Transformer. 75W max. Accommodates drywall ceiling from 1/2" to 1 1/8" thick.	<input type="checkbox"/> 120 <input type="checkbox"/> 277 (one circuit only)	<input type="checkbox"/> WH White <input type="checkbox"/> BK Black <input type="checkbox"/> IS Industrial Silver <input type="checkbox"/> PT Custom Finish
	<input type="checkbox"/> AR60MPR Monopoint Canopy Recessed Trimless for Remote Transformer or 120V or 277V direct wire Accommodates drywall ceiling from 1/2" to 1 1/8" thick.	<input type="checkbox"/> 12 <input type="checkbox"/> 120 <input type="checkbox"/> 277 (one circuit only)	<input type="checkbox"/> WH White <input type="checkbox"/> BK Black <input type="checkbox"/> IS Industrial Silver <input type="checkbox"/> PT Custom Finish

Other monopoint canopy designs are available. See page 10 for Surface Mounted or page 22 for Recessed w/ Trim.

RECESSED/TRIMLESS MOUNTED 60 AMP BUSWAY

ACCESSORIES FOR RECESSED/TRIMLESS BUSWAY

U.S. Patent Number: 6,517,363

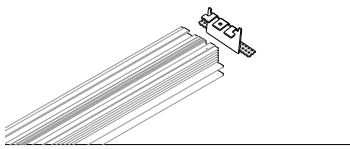
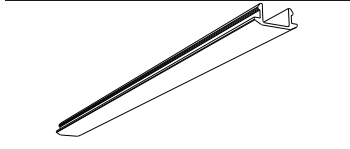
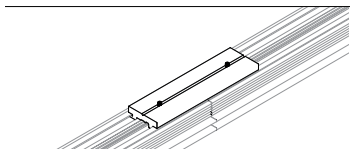
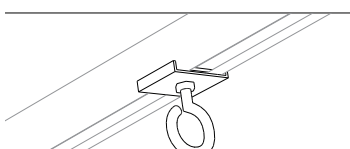
	Item	Finish
	<input type="checkbox"/> AR60ECR End Cap w/ Set Screw	<input type="checkbox"/> WH White <input type="checkbox"/> BK Black <input type="checkbox"/> IS Industrial Silver <input type="checkbox"/> PT Custom Finish
	<input type="checkbox"/> AR60CS Closure Strip - 96" Length - Field Cuttable (Covers open/unused busway slot)	<input type="checkbox"/> WH White <input type="checkbox"/> BK Black <input type="checkbox"/> IS Industrial Silver
	<input type="checkbox"/> AR60HC Housing Coupler (Provides joint support above busway)	<input type="checkbox"/> WH White <input type="checkbox"/> BK Black <input type="checkbox"/> IS Industrial Silver <input type="checkbox"/> PT Custom Finish
	<input type="checkbox"/> AR60HB Hanger Bolt Attachment Non-electrical device for suspension of accessories from the Busway.	<input type="checkbox"/> WH White <input type="checkbox"/> BK Black <input type="checkbox"/> IS Industrial Silver <input type="checkbox"/> PT Custom Finish

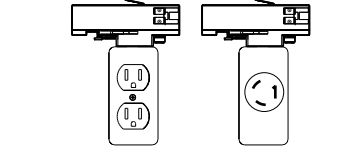
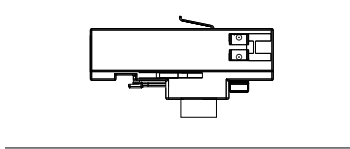
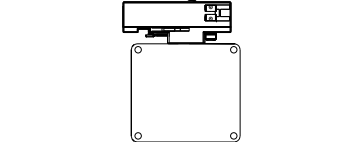
	Item	Voltage	Finish
	<input type="checkbox"/> AR60RC 3 Prong Receptacle Box (120V only) <input type="checkbox"/> AR60RCTL Twist-Lock Receptacle Box 15 Amp fused receptacle in J-Box with Busway adapter.	<input type="checkbox"/> 120 <input type="checkbox"/> 277	<input type="checkbox"/> WH White <input type="checkbox"/> BK Black <input type="checkbox"/> IS Industrial Silver <input type="checkbox"/> PT Custom Finish
	<input type="checkbox"/> AR60FA Fixture/Pendant Adapter Busway adapter to accommodate fixtures by others. Fused 15 Amp Max.	<input type="checkbox"/> 12 <input type="checkbox"/> 120 <input type="checkbox"/> 277	<input type="checkbox"/> WH White <input type="checkbox"/> BK Black <input type="checkbox"/> IS Industrial Silver
	<input type="checkbox"/> AR60JB J-Box Powertap Busway adapter with attached j-box to provide power for non-lighting equipment. Fused 15 Amp Max.	<input type="checkbox"/> 12 <input type="checkbox"/> 120 <input type="checkbox"/> 277	<input type="checkbox"/> WH White <input type="checkbox"/> BK Black <input type="checkbox"/> IS Industrial Silver <input type="checkbox"/> PT Custom Finish