



Mobile DVD-Video Player
Lecteur DVD-Vidéo mobile
Reproductor Movil de DVD-VIDEO

CX-D3000U

Operating Instructions

Manuel d'instructions

Manual de instrucciones



Safety Information

ENGLISH

WARNING:

TO REDUCE THE RISK OF FIRE OR ELECTRIC SHOCK, DO NOT EXPOSE THIS PRODUCT TO RAIN OR MOISTURE.

TO REDUCE THE RISK OF FIRE OR ELECTRIC SHOCK, AND ANNOYING INTERFERENCE, USE ONLY THE INCLUDED COMPONENTS.

WARNING:

NOT FOR USE WHERE VIDEO MONITOR IS VISIBLE TO DRIVER TO AVOID RISK OF SERIOUS INJURY OR POSSIBLE VIOLATION OF STATE LAWS.

CAUTION:

THIS PRODUCT IS A CLASS I LASER PRODUCT. HOWEVER THIS PRODUCT USES A VISIBLE/ INVISIBLE LASER BEAM WHICH COULD CAUSE HAZARDOUS RADIATION EXPOSURE IF DIRECTED. BE SURE TO OPERATE THIS PRODUCT CORRECTLY AS INSTRUCTED.

USE OF CONTROLS OR ADJUSTMENTS OR PERFORMANCE OF PROCEDURES OTHER THAN THOSE SPECIFIED HEREIN MAY RESULT IN HAZARDOUS RADIATION EXPOSURE.

DO NOT OPEN COVERS AND DO NOT REPAIR YOURSELF. REFER SERVICING TO QUALIFIED PERSONNEL.

Apparatus Claims of U.S. Patent Nos. 4,631,603, 4,577,216, and 4,819,098, licensed for limited viewing uses only.

This product incorporates copyright protection technology that is protected by method claims of certain U.S. patents and other intellectual property rights owned by Macrovision Corporation and other rights owners. Use of this copyright protection technology must be authorized by Macrovision Corporation, and is intended for home and other limited viewing uses only unless otherwise authorized by Macrovision Corporation. Reverse engineering or disassembly is prohibited.

Panasonic welcomes you to our ever growing family of electronic product owners. We know that this product will bring you many hours of enjoyment. Our reputation is built on precise electronic and mechanical engineering, and our products are manufactured with carefully selected components and assembled by people who take pride in their work. Once you discover the quality, reliability, and value we have built into this product, you too will be proud to be a member of our family.

☐ Use This Product Safely

When Driving

The driver must not operate the color LCD monitor. Operating the color LCD monitor may lead to carelessness and cause an accident. Stop your car in a safe location when operating the unit.

When Washing Your Car

Do not expose the product to water or excessive moisture. This could cause electrical shorts, fire or other damage.

When Parked

Parking in direct sunlight can produce very high temperatures inside your car. Give the interior a chance to cool down before switching the unit on.

Use the Proper Power Supply

This product is designed to operate with a 12 V DC, negative ground battery system (the normal system in a North American car).

Disc Mechanism

Do not insert coins or any small objects. Keep screwdrivers and other metallic objects away from the disc mechanism and disc.

Use Authorized Servicenters

Do not attempt to disassemble or adjust this precision product. Please refer to the Servicenter list included with this product for service assistance.

Protect the Software

When you leave the car, be sure to eject the disc from this unit and bring it out.

For Installation

This product should be installed in a horizontal position with the front end up at a convenient angle, but not more than 30°.

The user should bear in mind that in some areas there may be restrictions on how and where this unit must be installed. Consult your dealer for further details.

☐ Features

- DVD video, Video CD, and Music CD playback
- MP3 playback from CD-R/RW discs
- Digital audio output terminal for upgrading to Dolby Digital and dts surround [Requires separately sold optical cable (CA-LRD60) and digital surround processor (CY-AC300)].

The figure on the right shows an example of a combination recommended. See page 40 for information on how to connect the wires.

CX-D3000U Add-on DVD Player System

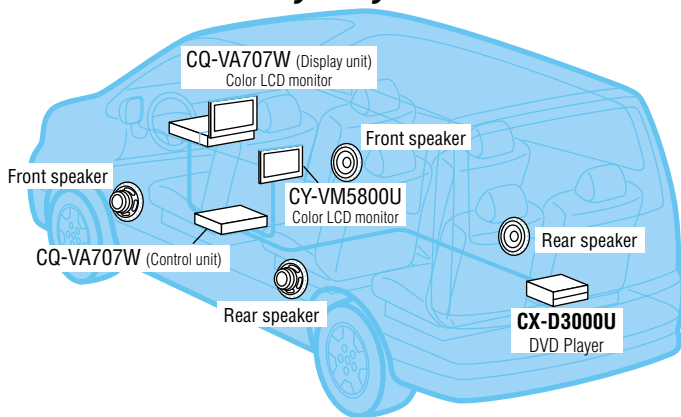

Find the model number and serial number on either the back or bottom of the product. Please record them in the space below and retain this booklet as a permanent record of your purchase to help with identification in case of theft.

MODEL NUMBER **CX-D3000U**

SERIAL NUMBER _____

DATE PURCHASED _____

FROM _____



Contents

Preparation

- Safety Information (2)**
- Use This Product Safely (4)**
- Features (4)**
- Discs that can be Played Back (10)**
- Accessories (11)**
- Remote Control Unit Preparation (11)**



Disc Operations

Page 12 – 21

- Inserting/Ejecting a disc, Playback, Stop (12)**
- Selecting a Menu Item (14)**
- Go to Beginning, Fast Forward/Fast Reverse (15)**
 - Pause, Slow Playback, Scan Play (16)**
 - Random Play, Repeat Play (17)**
 - Direct Title/Chapter/Track/Folder/File Selection (18)**
 - On-Screen Displays (OSD) (19)**
 - DVD Menu, Title Menu (20)**
 - Switching the Subtitle Language, Switching the Audio Language, Switching the Angle, Switching between Stereo and Monaural (21)**

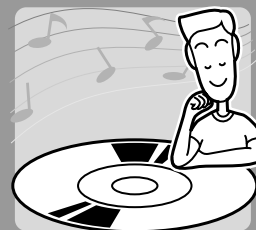

User Settings

Page 22 – 25

- Menu Language, Subtitle Language, Audio Language, TV Aspect*1 (22)**
 - TV Mode*2, On-Screen Messages, Audio Output Level, D. Range Compression (24)**
- *1 This setting determines the monitor's aspect ratio.
- *2 This setting determines the video format when viewing video on a wide screen with a 4:3 aspect ratio.

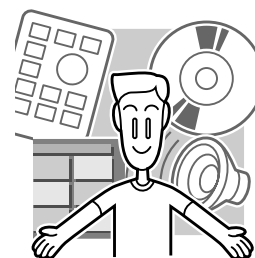

When required

- Troubleshooting (26)**
- Notes on MP3 (32)**
- Notes on Disc (34)**
- Language Code List (35)**
- Definition of Terms (36)**
- Specifications (45)**

Installation

- Installation Guide (37)**
- Electrical Connections (40)**

Discs that can be Played Back

ENGLISH
1

Disc	Mark (logo)	Disc size	Video format	Audio format	Region No.
		5" (12 cm)	NTSC	LPCM, MPEG 1/MPEG 2, Dolby Digital	1 All
CD, CD TEXT		3" (8 cm)		LPCM (CD-DA*), MP3	

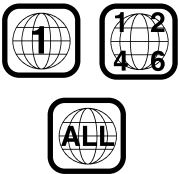

Battery Installation

- 1 Remove the battery holder.**
Pull the battery holder by position B while pushing position A in the direction indicated by the arrow.
- 2 Install the battery on the battery holder.**
- 3 Insert the battery holder back into its original position.**

Battery Notes

- Battery type: Panasonic lithium battery (CR2025) (included)
- Battery life: Approximately 6 months with normal use (at room temperature)

- Remove and dispose of an old battery immediately.
- Do not disassemble or short the battery. Do not throw a battery into a fire.
- Keep batteries away from children to avoid the risk of accidents.
- Be careful to observe proper local disposal rules when you dispose of batteries.

Point the remote control unit at the remote control signal receiver.



Disc Operations

Preparation

Check the monitor connection setting. (page 40–43)

Turn the car's ignition switch ACC or ON.
(ACC indicator*1 lights.)

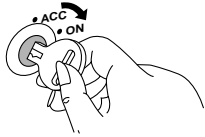

ACC indicator*1

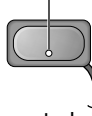

Remote control signal receiver*2

*1ACC indicator lights when the remote control signal receiver is connected. (page 40)

Turn the monitor switch to ON.

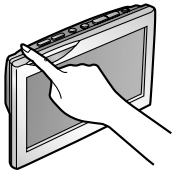

1 Open the cover.

When a disc is already loaded:



Caution:

- The player can only play the following types of discs: DVD video, video CD, CD and CD-DA data recorded CD-R and CD-RW, and MP3 data recorded CD media (CD-ROM, CD-R, CD-RW).
- If a disc contains both CD-DA data and MP3 data, just the data type recorded at the beginning of the disc is played.
- Refer to page 34 about notes on CD-Rs/RWs.
- Refer to page 32 about notes on MP3.
- Do not use irregularly shaped discs.
- Do not use discs that have a seal or label attached.
- Do not insert the foreign object into the disc slot.

This system is designed so that you cannot see the moving picture while you are driving.

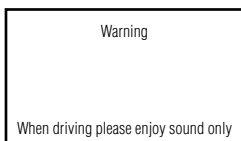

Not all CD media containing MP3 data will play back normally. For details, see "Notes on MP3" (page 32).

2 Insert the disc.

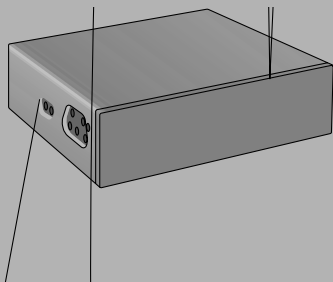

- The power turns to ON and playback begins automatically.
- Before loading a disc, check to make sure that a disc is not already loaded.

Ejecting the disc:



- You can eject the disc even when the power is off.
- You can eject a disc even when ACC is off by pressing [▲] (eject).

3 Close the cover.

- Always close the cover completely when using the player.

To turn the power off:



DVD Video

Video CD

CD

MP3

- Playback starts.

Note:

- When the menu screen appears, refer to "Selecting a Menu Item" (page 14).

DVD Video

Video CD

CD

MP3

(During playback)

- Playback stops.

Note:

- Press [▶] (PLAY) again, and play will resume from the point where [■] (STOP) was pressed. (Continued playback function).

To cancel continued playback: (In the stop mode)



Disc Operations (continued)

ENGLISH
5

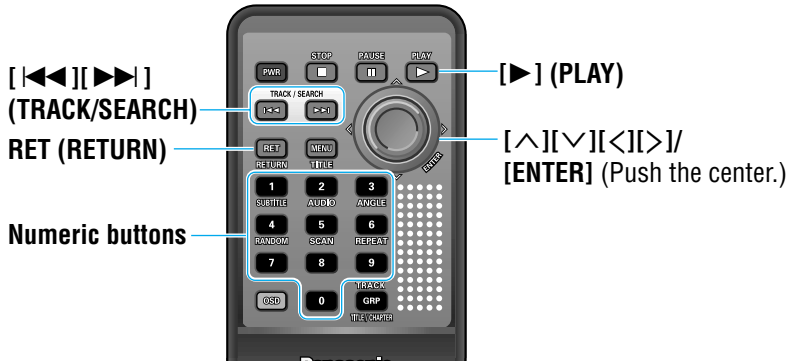

DVD Video

Video CD

CD

MP3

DVD Video

1 Select Item.

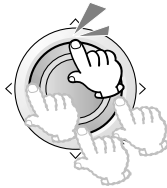

(Example)

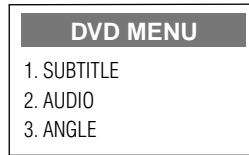

2 Finalize selection (ENTER).

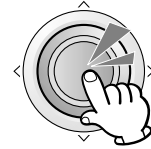

Selecting a Menu Item

DVD Video/Video CD with Playback Control

1 Select Item.

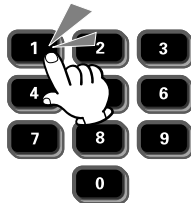

(Example: Video CD with playback control)

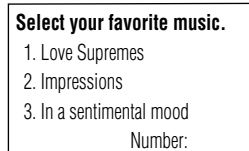

2 Finalize selection (ENTER).



(Example: "1")

To input the number again:



Note:

- Operations vary according to the disc. For details, refer to the guide provided with the disc.

DVD Video

Video CD

CD

MP3

Go to Beginning



(Backward) (Forward)

[▶▶]: Next chapter/track/file.

[◀◀]: Beginning of the current chapter/track/file.
For the previous chapter/track/file, press twice.

MP3 only



[^]: Next folder

[v]: Previous folder

Note:

- If the selected folder does not contain any MP3 files, the nearest MP3 file in the order of playback will be played.
- If the total of files and folders exceeds 254, successful playback may not be performed.

DVD Video

Video CD

CD

MP3

Fast Forward/ Fast Reverse

Forward

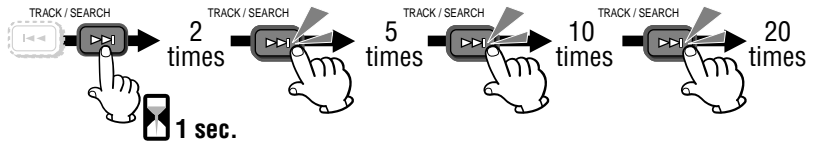

Reverse

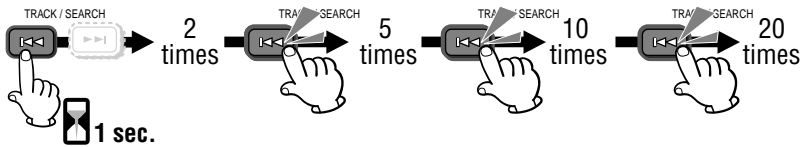

To stop fast-forwarding and start fast-reversing:



To stop fast-reversing and start fast-forwarding:

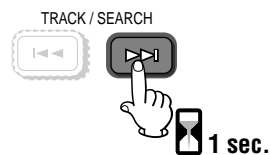

To resume normal playback:



Remote control unit

When pressing
pause:

- Each time you press [▶||] on this player:

Main unit

Pause
↕
Playback



Disc Operations (continued)

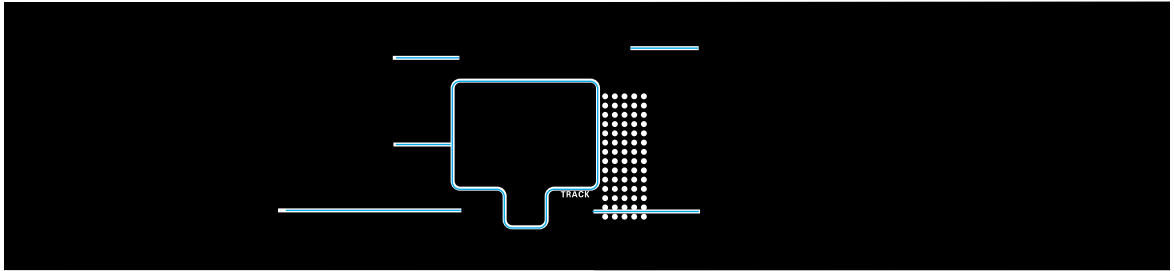

DVD Video

Video CD

CD

MP3

Direct Title/Chapter/ Track/Folder/ File Selection

1 Select the input mode.

(During playback)



Each time the button is pressed,

DVD video

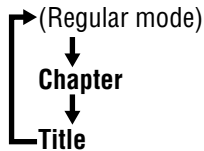

CD

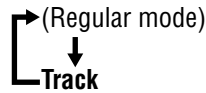

MP3

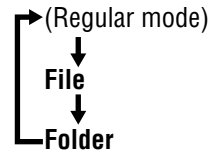

2 Input the desired number.

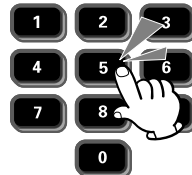

To input the number again:



3 Finalize selection (ENTER).



- The corresponding title/chapter/track/file on the selected folder/file starts playing.

Note:

- If a non-existent title/chapter/track/folder/file number is input and entered, the command is invalid and the display returns to regular mode.
- Title selections (only for DVD video) can be made even in the stop mode.

DVD Video Video CD CD MP3

(During playback) 

Each time you press this button, the display changes according to the disc type.

DVD video

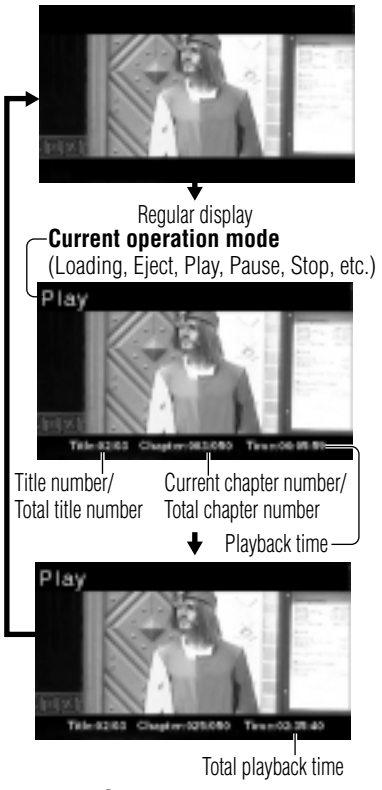

Video CD

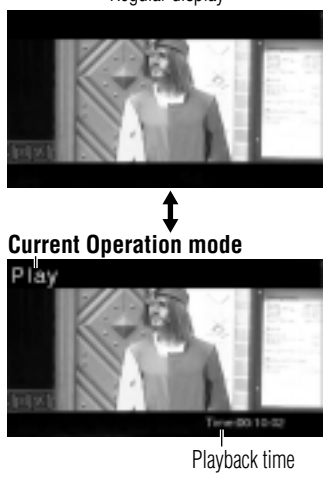

Music CD

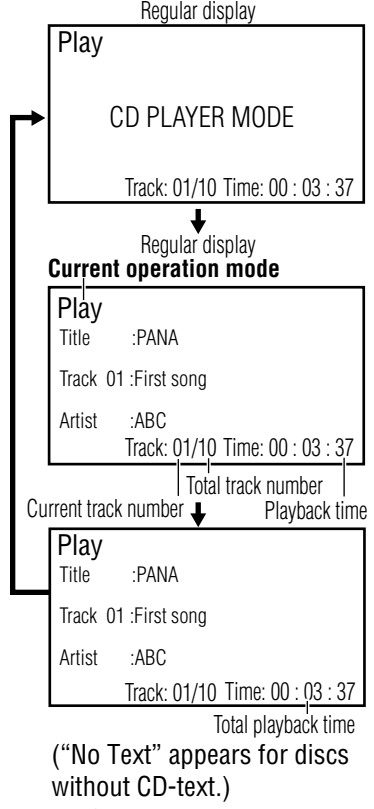

MP3

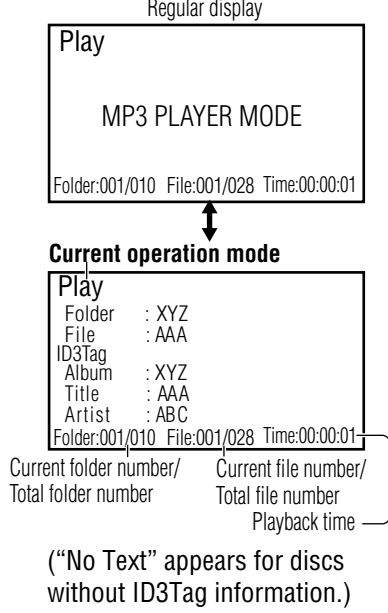

On-Screen Displays (OSD)

Note:

- Each display may sometimes show "---". This is not a malfunction.
- The On-Screen Display may not be displayed properly when the display size (Aspect) of the connected display unit is set to "Zoom". In this case, select the other display size type: NORMAL, JUST or FULL.



Disc Operations (continued)

ENGLISH
11

DVD Video

Video CD

CD

MP3

DVD Video

Video CD

CD

MP3

DVD Video Video CD CD MP3

Switching the Subtitle Language*

(During playback)

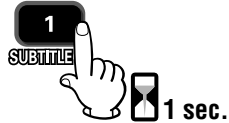

- The subtitle language is switched every time this is pressed for more than 1 second.

DVD Video Video CD CD MP3

Switching the Audio Language*

(During playback)

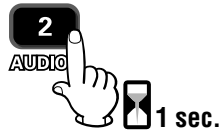

- The audio language is switched every time this is pressed for more than 1 second.

DVD Video Video CD CD MP3

Switching the Angle*

(During playback)

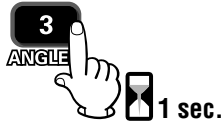

- The angle is switched every time this is pressed for more than 1 second.

DVD Video Video CD CD MP3

Switching between Stereo and Monaural*

(During playback)

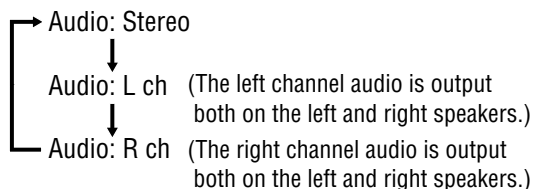

- Stereo is switched to monaural or vice versa every time this is pressed for more than 1 second.

* If no operation is performed for 5 seconds, the display returns to the regular mode.

Note:

- Initially, the subtitle language and the audio language are the language that is set in the user settings. (If this language has not been recorded, the language that is displayed is determined by the disc.)
- There may be brief delay before the subtitles appear.
- It may not be possible to switch subtitles/audio languages unless the unit is at the DVD menu or is at the user settings.
- The number of subtitle languages/audio languages depends on the disc. (Some discs have only one languages.)
- Some discs do not support the angle function. See the operating manual with the disc for details.



User Settings

1 (While disc stopped, or no disc.) Display "Main Menu".

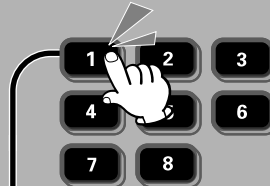
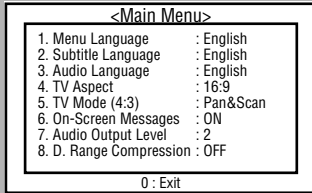

(Example: "1. Menu Language")

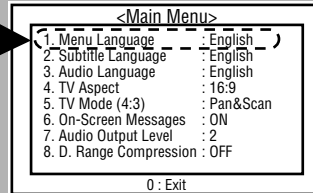

DVD Video

Video CD

CD

MP3

DVD Video

Video CD

CD

MP3



DVD Video

Video CD

CD

MP3

DVD Video

Video CD

CD

MP3

3 Select each item.

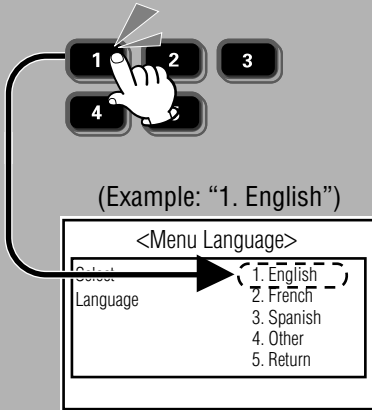

4 Finish the setting.

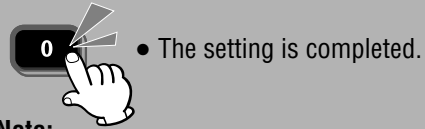

Note:

- To apply changes to settings, be sure to press [0] at the end.
- After the user settings have been changed and entered, the player returns to the start of the disc and begins playback.
- When the disc has predetermined language or other settings, the user settings are not reflected.

- 1. English
- 2. French
- 3. Spanish
- 4. Other: (page 35)
- 5. Return: The display returns to "Main Menu".

- 1. English
- 2. French
- 3. Spanish
- 4. Other: (page 35)
- 5. Disp Off: Subtitle language is not displayed.
- 6. Return: The display returns to "Main Menu".

Note:

- A disc supporting closed captioning and subtitles may overlap each other on the screen. In this case, turn the subtitle off.

- 1. English
- 2. French
- 3. Spanish
- 4. Other: (page 35)
- 5. Return: The display returns to "Main Menu".

- 1. 4:3: When a conventional monitor is connected.
- 2. 16:9: When a wide-screen monitor is connected.
 - Wide screen video can be played on the full screen.
- 3. Return: The display returns to "Main Menu".



User Settings (continued)

1 (While disc stopped, or no disc.)
Display
"Main Menu".

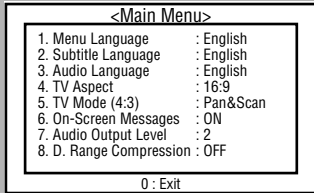

2 Select each setting menu.



(Example:
"7. Audio Output Level")

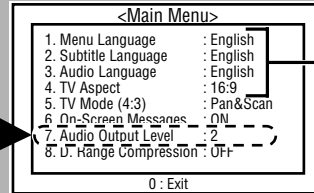

DVD Video

Video CD

CD

MP3

DVD Video

Video CD

CD

MP3

DVD Video

Video CD

CD

MP3

DVD Video

Video CD

CD

MP3

3 Select each item.

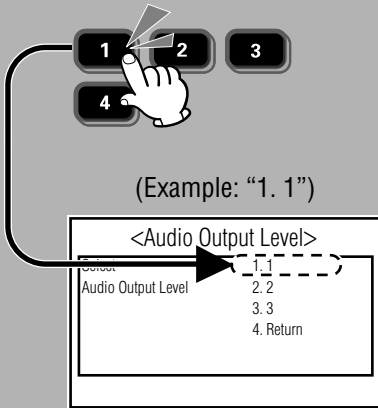

4 Finish the setting.

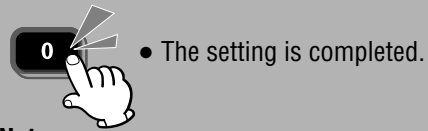

Note:

- To apply changes to settings, be sure to press [0] at the end.
- After the user settings have been changed and entered, the player returns to the start of the disc and begins playback.
- When the disc has predetermined language or other settings, the user settings are not reflected.

- 1. **Pan & Scan:** Plays in Pan & Scan mode
- 2. **Letterbox:** Plays in Letter Box mode
- 3. **Return:** The display returns to "Main Menu".

Note:

- If "Pan & Scan" or "Letterbox" is already set in the software, this setting is ignored.

- 1. **ON:** When power is turned on, On-Screen Display messages such as "Play" and "Pause" will always be displayed on the screen for 5 seconds.
- 2. **OFF:** When power is turned on, On-Screen Display messages such as "Play" and "Pause" will not be displayed on the screen.
- 3. **Return:** The display returns to "Main Menu".

- 1. **1:** Minimum Level
- 2. **2:** Middle level
- 3. **3:** Maximum level
- 4. **Return:** The display returns to "Main Menu".

Note:

- We recommend that you select the default when you use this player in the system configurations (page 40–43), and adjust the volume control on the display unit or stereo unit concerned to this player. See the display unit operating manual for details.

- 1. **Minimum:** Most compressed mode: TV broadcasts, etc.
- 2. **Standard:** Mode recommended by software creators for listening at low volumes.
- 3. **OFF:** Does not compress the dynamic range.
- 4. **Return:** The display returns to "Main Menu".

Note:

- When it is difficult to hear comparatively small sound (such as movie dialogue), setting "Minimum" will make those sounds easier to hear.



Troubleshooting

Preliminary Steps

Check and take steps as described in the tables below.

If You Suspect Something Wrong

Immediately switch the power off. Disconnect the power connector and check that there is neither smoke nor heat from the product before asking for repairs. Never try to repair the product yourself because it is dangerous to do so.

Caution:

- Do not use the product if it malfunctions or is something wrong.
- Do not use the product in abnormal condition, for example, without sound, or with smoke or foul smell, which can cause ignition or electric shock. Immediately stop using it and call the store where you purchased it.

Error Display Messages

Error Display	Cause/Step
<p>Error</p> <p>Playback Error</p> <p>Please eject.</p>	<ul style="list-style-type: none"> • Disc is dirty, scratched or upside down. • A disc that has data other than CD-DA or MP3 type is loaded. <p>⇒ Check the disc.</p> <ul style="list-style-type: none"> • An attempt was made to play a PAL disc. <p>⇒ Eject the disc.</p>
<p>Error</p> <p>This type of disc cannot be played.</p> <p>Please eject.</p>	<ul style="list-style-type: none"> • Disc is dirty, scratched or upside down. • A disc that has data other than CD-DA or MP3 type is loaded. <p>⇒ Check the disc.</p> <ul style="list-style-type: none"> • An attempt was made to play a PAL disc. <p>⇒ Eject the disc.</p> <ul style="list-style-type: none"> • The player for some reason cannot read the file you are trying to play. (File recorded in an unsupported file system, compression scheme, data format, file name extension, damaged data, etc.) <p>⇒ Select a file that the player can read. Confirm the type of data recorded on the disc. Create a new disc if need.</p>
<p>Error</p> <p>Mechanical Error</p> <p>Please eject.</p>	<ul style="list-style-type: none"> • The player will not operate for some reason. <p>⇒ Eject the disc. If the disc is not ejected when you press [▲] (eject), then simply press the reset switch (page 31).</p>
<p>Error</p> <p>This disc may not be played in your region. Please eject.</p>	<ul style="list-style-type: none"> • An attempt was made to play a disc with a region number that was not "1" or "ALL". <p>⇒ Eject the disc.</p>

Troubleshooting Tips

Common

Trouble	Cause/Step
No power.	<p>Car's engine switch is not on. → Turn your car's ignition switch to ACC or ON.</p> <p>Cables are not correctly connected. → Connect cables correctly. → Connect the battery cable to the terminal that is always active. → Connect the accessory cable to your car's ACC source. → Connect the grounding wire to a metal part of the car.</p> <p>Fuse is burnt out. → Call the store where you purchased the unit, or your nearest Servicenter (see the attached sheet) and ask for fuse replacement.</p>
No sound.	<p>Cables are not correctly connected. → Connect cables correctly.</p> <p>Condensation (dew). → Wait for a while before use.</p>

DVD/Video CD/CD

Trouble	Cause/Step
The disc is inside but there is no sound.	<p>Disc is upside down. → Place disc in the correct direction with the label side up.</p> <ul style="list-style-type: none"> • Disc is dirty. • Disc has scratches. <p>→ Clean the disc, referring to the section on "Notes on Disc". (page 34)</p> <p>→ The player can only play the following types of discs: DVD video, Video CD, CD and CD-DA data recorded CD-R and CD-RW, and MP3 data recorded CD media (CD-ROM, CD-R, CD-RW).</p> <p>→ The player may not successfully play back a CD-R/RW that is made in combination of writing software, a CD recorder (CD-R/RW drive) and a disc which are incompatible one another. Refer to instructions for the concerned devices for details.</p> <p>You are trying to play a dts CD or DVD. → The player cannot play audio on dts CDs or DVDs unless a digital surround processor is used (page 42-43).</p>



Troubleshooting (continued)

□ DVD/Video CD/CD (continued)

Trouble	Cause/Step
Sound skips, bad sound quality (e.g. caused by noise).	<ul style="list-style-type: none"> • Disc is dirty. • Disc has scratches. <p>→ Clean the disc, referring to the section on “Notes on Disc”. (page 34)</p> <p>→ The player may not successfully play back a CD-R/RW that is made in combination of writing software, a CD recorder (CD-R/RW drive) and a disc which are incompatible one another. Refer to instructions for the concerned devices for details.</p>
Sound skips due to vibration.	<p>Mounting angle is over 30°.</p> <p>→ Adjust mounting angle to less than 30°.</p> <p>Instable mounting.</p> <p>→ Mount the player securely with the mounting parts, referring to the section on installation.</p>
The disc is not ejected.	<ul style="list-style-type: none"> • Disc is defective. • Mechanical trouble. <p>→ Open the cover and press [▲] (eject). If the disc still does not eject, press the reset switch (page 31).</p>
CD-text is not displayed normally.	<ul style="list-style-type: none"> • Disc is dirty. • Disc has scratches. <p>→ Clean the disc, referring to the section on “Notes on Disc”. (page 34)</p>
Time is counted but no sound comes out.	<p>The first track of a mix mode disc was reproduced. (Mix mode is a format in which data except music is recorded on the first track and music data is recorded on other than the first track in a session.)</p> <p>→ This player does not support mix mode discs. Playback the disc containing only music data or only MP3 data.</p>
The picture does not appear on the monitor.	<p>Cables are not correctly connected.</p> <p>→ Connect cables correctly.</p> <p>→ Check the settings for the monitor itself.</p> <p>→ Stop the car and apply the parking brake.</p>
The buttons do not work.	<p>Some operations are not permitted with certain discs.</p> <p>→ Refer to the guide provided with your disc.</p> <p>Two REMOTE IN connectors are connected.</p> <p>→ Do not connect the remote control signal receiver when remote control signals can be received by the display unit.</p>
Video CD menu playback does not work.	<p>→ Video CD menu playback works only when playing a video CD that has the playback control feature.</p>
The picture becomes distorted while fast forwarding or reversing.	<p>→ A certain amount of distortion is normal.</p>

□ DVD/Video CD/CD (continued)

Trouble	Cause/Step
No subtitles appear.	<p>Subtitles must be recorded on the disc, or they will not appear. → Refer to the guide provided with your disc.</p>
It is difficult to hear small sound. (Dolby digital DVD software only)	<p>→ Set “D. Range Compression” to “Minimum”.</p>
The sound volume level is too low or too high.	<p>→ Adjust the output level at the menu of “Audio Output Level”.</p>
Cannot switch the audio language/subtitle language/angle.	<ul style="list-style-type: none"> • It is not possible to switch if the disc does not have multiple audio languages/subtitle languages/angles recorded on it. → Refer to the guide provided with your disc. • Some discs permit switching through a menu screen. • Sometimes, switching angle is possible only with certain scenes.
The audio/subtitle language selected in the user settings is not used.	<p>If audio or subtitles in that language are not recorded on the disc, the audio or subtitles do not switch to that language. (Some discs permit switching through a menu screen.) → Refer to the guide provided with your disc.</p>
Messages in the menu screen are not in the desired language.	<p>→ Check the setting for “Menu Language” in the user settings.</p>

□ MP3

Trouble	Cause/Step
No playback.	<p>The disc does not conform to any of the file systems supported by this player. → Insert a disc that conforms to the file systems (ISO 9660 Level 1, Level 2, Joliet, Romeo or Apple Extension to ISO 9660).</p> <p>The “.mp3” file name extension is missing in the MP3 files. → Make sure to add the “.mp3” extension to each MP3 file name.</p>
Poor recording quality, sound skipping.	<p>→ The recording quality differs depending on the encoding software used, and on settings such as the bit rate. Set the bit rate within the range specified in the specifications chart (page 45). It is recommended to set the bit rate to “128 kbps or more” and “Fixed”.</p> <p>High-speed writing was executed when MP3 data was recorded on the disc. → Decrease writing speed as low as possible.</p>



Troubleshooting (continued)

❑ MP3 (continued)

Trouble	Cause/Step
It takes too long for playback to start.	The folders and files recorded on the disc are layered too much. → As checking of files takes longer in this case, do not record any unnecessary folders or files other than MP3 on the disc.
Files are not played in the desired order.	Files or folders are not recorded in the desired playback order. → Some writing software lets you specify the recording order by adding a prefix in the range of "01"–"99", etc. to the file name. For details, refer to the user manual of your writing software.
Folder/file name is not displayed correctly.	The disc does not conform to the file systems supported by this player. → Insert a disc that conforms to the file systems (ISO 9660 Level 1, Level 2, Joliet, Romeo or Apple Extension to ISO 9660).
	→ There may be a problem with your writing software or CD recorder (CD-R/RW drive). For details, refer to the user manual of your writing software.
File playing time is not displayed correctly.	You played a VBR (Variable Bit Rate) format file. → The file playing time of VBR (Variable Bit Rate) format file is sometimes displayed incorrectly.

❑ Remote control unit

Trouble	Cause/Step
Buttons are invalid for operation.	Battery polarities are reversed. → Insert the battery correctly.
	Wrong battery. → Check the battery.
	The battery has run down. → Replace the battery.
	Remote control unit is facing the wrong direction. → Direct the remote control unit at the remote control signal receiver.

What to do if the player does not operate no matter which button you press

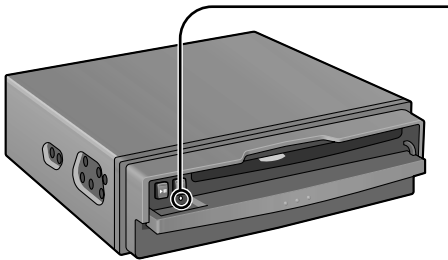

Reset switch

Press this switch with a tough pointed object.

- The player returns to the power off, and turn the power on again.

Caution:

- Press this switch when any operation buttons do not work. If the player does not become restored even after pressing the switch, contact your nearest Panasonic Servicenter for service.

Maintenance

Your product is designed and manufactured to ensure a minimum of maintenance. Use a dry soft cloth for routine exterior cleaning. Never use benzine, thinner or other solvents.

Product Servicing

If the suggestions in the charts do not solve the problem, we recommend that you take it to your nearest authorized Panasonic Servicenter. The product should be serviced only by a qualified technician.

Replacing the Fuse

Use fuses of the same specified rating (5 A). Using different substitutes or fuses with higher ratings, or connecting the product directly without a fuse, could cause fire or damage to the product.

If the replacement fuse fails, contact your nearest Panasonic Servicenter for service.



Notes on MP3

□ What is MP3?

MP3 (MPEG audio layer 3) is the compression format of digital audio. It is developed by MPEG (Motion Picture Experts Group). Using this compression format, you can record the contents of about 10 music CDs on a single CD media. (This figures refer to data recorded on a 650 MB CD-R or CD-RW at a fixed bit rate of 128 kbps and a sampling frequency of 44.1 kHz.)

Note:

- MP3 encoding and writing software are not supplied with this product.
- CD writing software is not supplied with this product.

□ Points to remember when making MP3 files

- High bit rate and high sampling frequency are recommended for high quality sounds.
- Selecting VBR (Variable Bit Rate) is not recommended because playing time is not displayed properly and sound may be skipped.
- The playback sound quality differs depending on the encoding circumstances. For details, refer to the user manual of your own encoding software and writing software.
- It is recommended to set the bit rate to “128 kbps or more” and “fixed”.

Caution:

- **Never assign the “.mp3” file name extension to a file that is not in the MP3 format. This may not only produce noise from the speaker damage, but also damage your hearing.**

□ Display information

■ Displayed items

CD-TEXT

- Title
- Track
- Artist

MP3

- Folder
- File

MP3 (ID3 tag)

- Album
- Title
- Artist

■ Displayable characters

- Displayable length of file name/folder name: within 99 characters
- Name files and folders in accordance with the standard of each file system. Refer to the instructions of writing software for details.
- ASCII character set can be displayed.

ASCII character set

A to Z, a to z, digits 0 to 9, and the following symbols:
(space) ! " # \$ % & ' () * + , - . / : ; < = > ? @ [\] ^ _ ` { | } ~

Note:

- With some software in which MP3 format files have been encoded, the character information may not be displayed properly.
- Undisplayable characters and symbols will be converted into an asterisk.

❑ Recording MP3 files on a CD-media

- You are recommended to minimize the chances of making a disc that contains both CD-DA files and MP3 files.
- If CD-DA files are on the same disc as MP3 files, the songs may not play in the intended order, or some songs may not play at all.
- Do not record files other than MP3 files and unnecessary folder on a disc.
- The name of MP3 file should be added by rules as shown in the following descriptions and also comply with the rules of each file system.
- You may encounter trouble in playing MP3 files or displaying the information of MP3 files recorded with certain writing software or CD recorders.

- The file extension “.mp3” should be assigned to each file depending on the file format.
- This unit does not have the play list function.
- Although Multi-session recording is supported, the use of Disc-at-Once is recommended.
- Packet writing software is not supported.

Supported file systems

ISO 9660 Level 1/Level 2, Apple Extension to ISO 9660, Joliet, Romeo

Note:

- Apple HFS, UDF 1.50, Mix CD (CD Extra) is not supported.

Compression formats (Recommendation: “Points to remember when making MP3 files” on the previous page)

Compression method	Bit rate	VBR	Sampling frequency
MPEG 1 audio layer 3 (MP3)	32 kbps—320 kbps	Yes	32, 44.1, 48 kHz
MPEG 2 audio layer 3 (MP3)	8 kbps—160 kbps	Yes	16, 22.05, 24 kHz

❑ Folder selection order/file playback order (example)

Note:

- This unit counts the number of folders irrespective of the presence or absence of MP3 file.
- If the selected folder does not contain any MP3 files, the nearest MP3 files in the order of playback will be played.
- Playback order may be different from other MP3 players even if the same disc is used.
- “ROOT” appears when displaying the root folder name.

Maximum number of files/folders:

- Maximum number of files/folders: 999 (files+folders)
- Maximum number of files in one folder: 255
- Maximum depth of trees: 8
- Maximum number of folders: 255 (Root folder is included.)

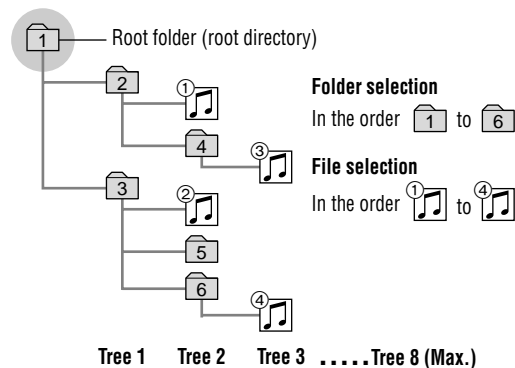

❑ Copyright

It is prohibited by copyright laws to copy, distribute and deliver copyrighted materials such as music without the approval of copyright holder except enjoying yourself personally.

❑ No warranty

Above description complies with our investigations as of September 2003. It has no warranty for reproducibility and displayability of MP3.



Notes on Disc

Notes on CD-Rs/RWs

- You may have trouble playing back some CD-R/RW discs recorded on CD recorders (CD-R/RW drives), either due to their recording characteristics or dirt, fingerprints, scratches, etc. on the disc surface.
- CD-R/RW discs are less resistant to high temperatures and high humidity than ordinary music CDs. Leaving them inside a car for extended periods may damage them and make playback impossible.
- This player may not successfully play back a CD-R/RW that was made by the combination of writing software, a CD recorder (CD-R/RW drive) and a disc if they are incompatible one another.
- This player cannot play the CD-R/RW discs if the session is not closed.
- This player cannot play the CD-R/RW discs which contains other than CD-DA or MP3 data.
- Be sure to observe the instructions of CD-R/RW disc for handling it.

Maintenance

How to hold the disc

- Do not touch the surface of the disc.
- Do not scratch the disc.
- Do not bend the disc.
- When not in use, keep the disc in the case.

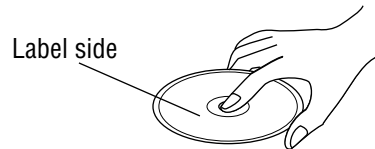

Do not use irregularly shaped discs.

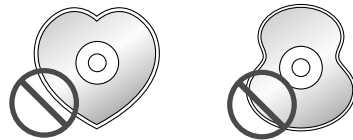

Do not leave discs on the following places:

- Direct sunlight
- Near car heaters
- Dirty, dusty and damp areas
- Seats and dashboards

Disc cleaning

Use a dry, soft cloth to wipe from the center outward.

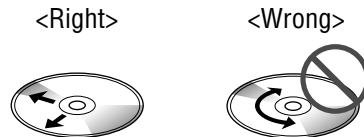

Do not attach any seals or labels to your discs.

Do not write on the disc label in a heavy pen or ballpoint pen stroke.



Language Code List

In “Other” cases (Menu Language, Subtitle Language, Audio Language) (page 22)

1 Input the four digit language code. (See below.)



To input the number again:



2 Finalize the selection (ENTER).

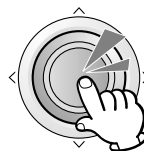

• Setting is finished and the display returns to “Main Menu”.

Code	Language Name
6565	Afar
6566	Abkhazian
6570	Afrikaans
6577	Ameharic
6582	Arabic
6583	Assamese
6588	Aymara
6590	Azerbaijani
6665	Bashkir
6669	Byelorussian
6671	Bulgarian
6672	Bihari
6678	Bengali; Bangla
6679	Tibetan
6682	Breton
6765	Catalan
6779	Corsican
6783	Czech
6789	Welsh
6865	Danish
6869	German
6890	Bhutani
6976	Greek
6978	English
6979	Esperanto
6983	Spanish
6984	Estonian
6985	Basque
7065	Persian
7073	Finnish
7074	Fiji
7079	Faroese
7082	French
7089	Frisian
7165	Irish
7168	Scots Gaelic
7176	Galician
7178	Guarani
7185	Gujarati
7265	Hausa
7273	Hindi
7282	Croatian

Code	Language Name
7285	Hungarian
7289	Armenian
7365	Interlingua
7378	Indonesian
7383	Icelandic
7384	Italian
7387	Hebrew
7465	Japanese
7473	Yiddish
7487	Javanese
7565	Georgian
7575	Kazakh
7576	Greenlandic
7577	Cambodian
7578	Kannada
7579	Korean
7583	Kashmiri
7585	Kurdish
7589	Kirghiz
7665	Latin
7678	Lingala
7679	Laotian
7684	Lithuanian
7686	Latvian, Lettish
7771	Malagasy
7773	Maori
7775	Macedonian
7776	Malayalam
7778	Mongolian
7779	Moldavian
7782	Marathi
7783	Malay
7784	Maltese
7789	Burmese
7865	Nauru
7869	Nepali
7876	Dutch
7879	Norwegian
7982	Oriya
8065	Punjabi
8076	Polish
8083	Pashto, Pushto

Code	Language Name
8084	Portuguese
8185	Quechua
8277	Rhaeto-Romance
8279	Romanian
8285	Russian
8365	Sanskrit
8368	Sindhi
8372	Serbo-Croatian
8373	Singhalese
8375	Slovak
8376	Slovenian
8377	Samoan
8378	Shona
8379	Somali
8381	Albanian
8382	Serbian
8385	Sundanese
8386	Swedish
8387	Swahili
8465	Tamil
8469	Telugu
8471	Tajik
8472	Thai
8473	Tigrinya
8475	Turkmen
8476	Tagalog
8479	Tonga
8482	Turkish
8484	Tatar
8487	Twi
8575	Ukrainian
8582	Urdu
8590	Uzbek
8673	Vietnamese
8679	Volapük
8779	Wolof
8872	Xhosa
8979	Yoruba
9072	Chinese
9085	Zulu



Definition of Terms

Digital audio output connector (Optical)

The digital audio output connector (optical) converts electrical signals into optical signals and transfers them to the amplifier. Consequently, it has a number of features including its immunity from electrical interference from external sources and its ability to prevent the generation of noise and its minimal effect on the external environment.

Dolby Digital

Dolby Digital is a digital sound compression technique developed by the Dolby Laboratories Licensing Corporation.

Supporting 5.1-channel surround sound, as well as stereo (2-channel) sound, this technique enables a large quantity of sound data to be efficiently recorded on a disc.

Manufactured under license from Dolby Laboratories. "Dolby" and the double-D symbol are trademarks of Dolby Laboratories. Confidential unpublished works. © 1992–1997 Dolby Laboratories. All rights reserved.

Interactive DVD

An interactive DVD is DVD software which includes multiple angles, multiple plot endings, etc.

Letterbox screen

This refers to a screen on which the playback picture of wide-screen DVDs or Video CDs appears with black bands running along the top and bottom.



Linear PCM audio (LPCM)

This refers to a signal recording format used in CDs. While CDs are recorded in 44.1 kHz/16 bit, DVDs are recorded in 48 kHz/16 bit up to 96 kHz/24 bit, thus achieving higher quality audio than that of CDs.

MPEG (Moving Picture Experts Group)

MPEG is an international standard format for the compression of motion video as defined by the Moving Picture Experts Group, a working committee which functions under the auspices of the International Standardization Organization and International Electrotechnical Commission. The Group established the MPEG 1 standard in 1991 and the MPEG 2 standard in 1994. MPEG 2 builds on MPEG 1 with many improvements, and it yields a higher picture quality level.

Pan & Scan screen

This refers to a screen on which the playback picture of wide-screen DVDs or Video CDs is cut off at the left and right sides.



Playback control (Video CD)

If the Video CD has "With Playback Control" or others written on the disc surface or on the jacket, the scenes or information to be viewed (or listened to) can be selected interactively with the screen by looking at the menu shown on the screen.

In these instructions, playback using the menu screen is referred to as the "menu play" for video CDs. This player supports Video CDs with playback control.

Title, Chapter (DVD)

DVDs are divided into some large sections (titles) or some small sections (chapters). Each section is numbered; these numbers are called "Title number" or "Chapter number".

Title 1		Title 2	
Chapter 1	Chapter 2	Chapter 1

Track (Video CD/CD)

Video CDs or CDs are divided into some sections (tracks). Each section is numbered; these numbers are called "Track number".

Track 1	Track 2	Track 3	Track
---------	---------	---------	-------------



Installation Guide



WARNING

The installation information is designed for experienced installers and is not intended for non-technical individuals. It does not contain warnings or cautions of the potential dangers involved in attempting to install this product.

Any attempt to install this product in a motor car by anyone other than a qualified installer could cause damage to the electrical system and could result in serious personal injury or death.

Installation hardware

No.	Item	Diagram	Q'ty
			4

Before you begin installation, look for the items which are packed with your product.

- **Warranty Card**...Fill this out promptly.
- **Panasonic Servicenter List for Service Directory** ...Keep for future reference in case the product needs servicing.

Required tools

You'll need a screwdriver, and the following:



⑥

Overview

This product is designed for professional installers. However, if you are not a professional, you should consult your first aid kit and follow the instructions in the manual. (Please refer to the manual above.)

- In order to install the product, you must disconnect the power.
- Consult your local electrical code for more information.



Installation Guide (continued)

☐ Identify all leads

The first step in installation is to identify all the car wires you'll use when hooking up your sound system.

As you identify each wire, we suggest that you label it using masking tape and a permanent marker. This will help avoid confusion when making connections later.

Note:

- Do not connect the power connector to the product until you have made all connections. If there are no plastic caps on the stereo hooking wires, insulate all exposed leads with electrical tape until you are ready to use them. Identify the leads in the following order.

Power Lead

If your car has a radio or is pre-wired for one: Cut the connector wires one at a time from the plug (leaving the leads as long as possible) so that you can work with individual leads.

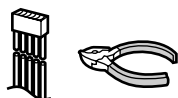

Turn the ignition on to the accessory position, and ground one lead of the test bulb to the chassis.

Touch the other lead of the test bulb to each of the exposed wires from the cut radio connector plug. Touch one wire at a time until you find the outlet that causes the test bulb to light.

Now turn the ignition off and then on. If the bulb also turns off and on, that outlet is the car power lead.

If your car is not wired for an audio unit: Go to the fuse block and find the fuse port for radio (RADIO), accessory (ACC), or ignition (IGN).

Battery Lead

If your DVD player has a yellow lead, you will need to locate the car's battery lead. Otherwise you may ignore this procedure. (The yellow battery lead provides continuous power to maintain a clock, memory storage, or other function.)

If your car has a radio or is pre-wired for one: With the ignition and headlights off, identify the car battery lead by grounding one lead of the test bulb to the chassis and checking the remaining exposed wires from the cut radio connector plug.

If your car is not wired for an audio unit: Go to the fuse block and find the fuse port for the battery which is usually marked BAT.

☐ Connect all leads

Now that you have identified all the wires in the car, you're ready to begin connecting them to the DVD player wires. The wiring diagram (page 40) shows the proper connections and color coding of the leads.

We strongly recommend that you test the unit before making a final installation.

You can set the unit on the floor and make temporary connections to test the unit. Use electrical tape to cover all exposed wires.

Important:

- Connect the red power lead last, after you have made and insulated all other connections.

Ground

Connect the black ground lead of the power connector to the metal car chassis.

Battery

Connect the yellow battery lead to the correct radio wire or to the battery fuse port on the fuse block.

Power

Connect the red power lead to the correct power cord according to your system configuration by referring to the wiring diagram.

If the player functions properly with all these connections made, disconnect the wires and proceed to the final installation.

Final installation

Lead Connections

Connect all wires, making sure that each connection is insulated and secure. Bundle all loose wires and fasten them with tape so they won't fall down later.

Congratulations! After making a few final checks, you're ready to enjoy your mobile DVD player.

Final checks

1. Make sure that all wires are properly connected and insulated.
2. Turn on the ignition to check the unit for proper operation.

If you have difficulties, consult your nearest authorized professional installer for assistance.

Preparation

- We strongly recommend that you wear gloves for installation work to protect yourself from injuries.

- Disconnect the cable from the negative \ominus battery terminal (see caution below).
- The product should be installed in a horizontal position with the front end up at a convenient angle, but not more than 30° .

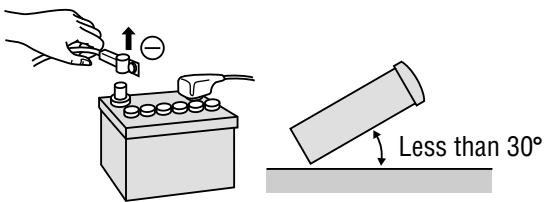

Caution:

- Do not disconnect the battery terminals of a car with a trip or navigational computer since all user settings stored in memory will be lost. Instead take extra care with installing the unit to prevent shorts.

How to install the product

The diagram below shows an example in which this product is installed to the floor. Consult a qualified servicing engineer or your dealer for information on installing this product to a different location.

When installing the unit with the L-Shaped Brackets ③

- 1 Attach the L-shaped brackets ③ on both sides of product with the binding-head screws ②.

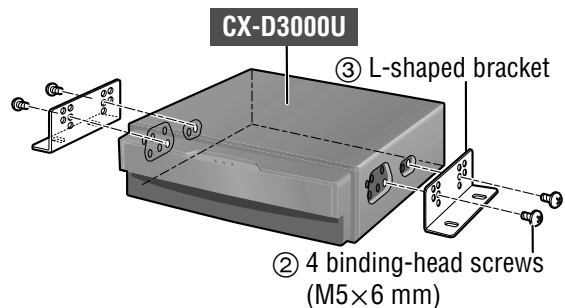

- 2 Install the product with tapping screws ①.

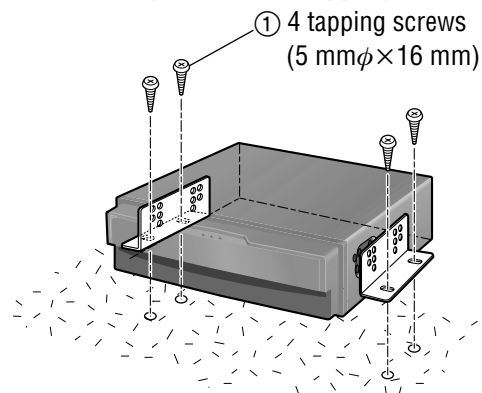

If you plan to attach the product to the floor, avoid dusty locations.

Caution:

- All other installation methods required the use of dedicated metal fittings. Consult with a qualified servicing engineer or your dealer if other methods are required.
- When drilling holes in the car, make sure that you do not damage any pipes or wiring on the underside of the car.
- When installing the product, make sure that the cord is positioned in a location where it will not be pinched or damaged when the seat slides forward or backward.



Electrical Connections

□ Wiring diagram

Examples of system combination:

- In-dash monitor/receiver (CQ-VA707W, option)
- Rear seat monitor (CY-VM5800U, option)

Accessories used for wiring

No.	Item	Q'ty
④	Power connector	1
⑥	Cord clamp	1
⑦	RCA cord	1
⑧	Double-sided tape	1

Attaching the remote control signal receiver

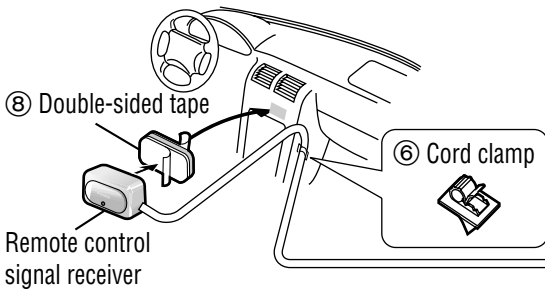

- When connecting or disconnecting the cord, be absolutely sure to take hold of the molded part of the plug (and not the cord itself) and proceed. When connecting the cord, be sure to push it all the way in.
- Do not accidentally connect a radio antenna, etc.

Not used.

Side brake (parking brake) connection lead (page 44)

- Be sure to connect this as a safety measure.

ACC power lead
To ACC power, +12 V DC.

Battery lead
To the car battery, continuous +12 V DC.

- Connect the battery power cord to a connector that is always supplied with power from the car battery.

Ground lead
To a clean, bare metallic part of the car chassis.

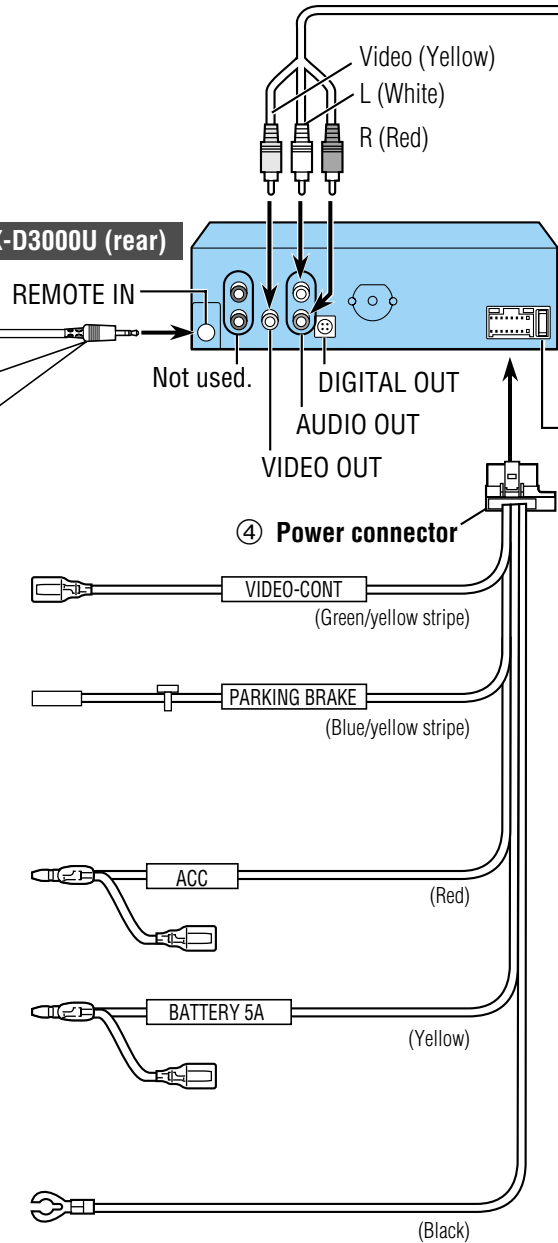

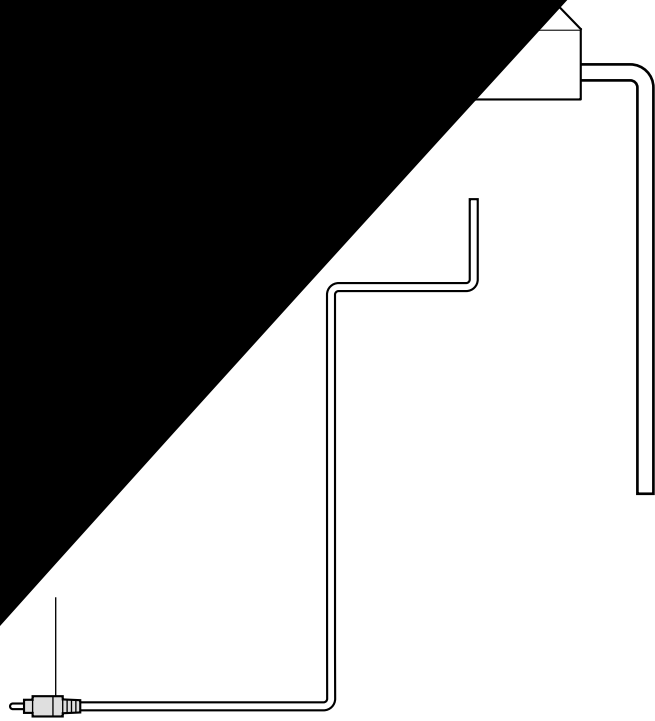

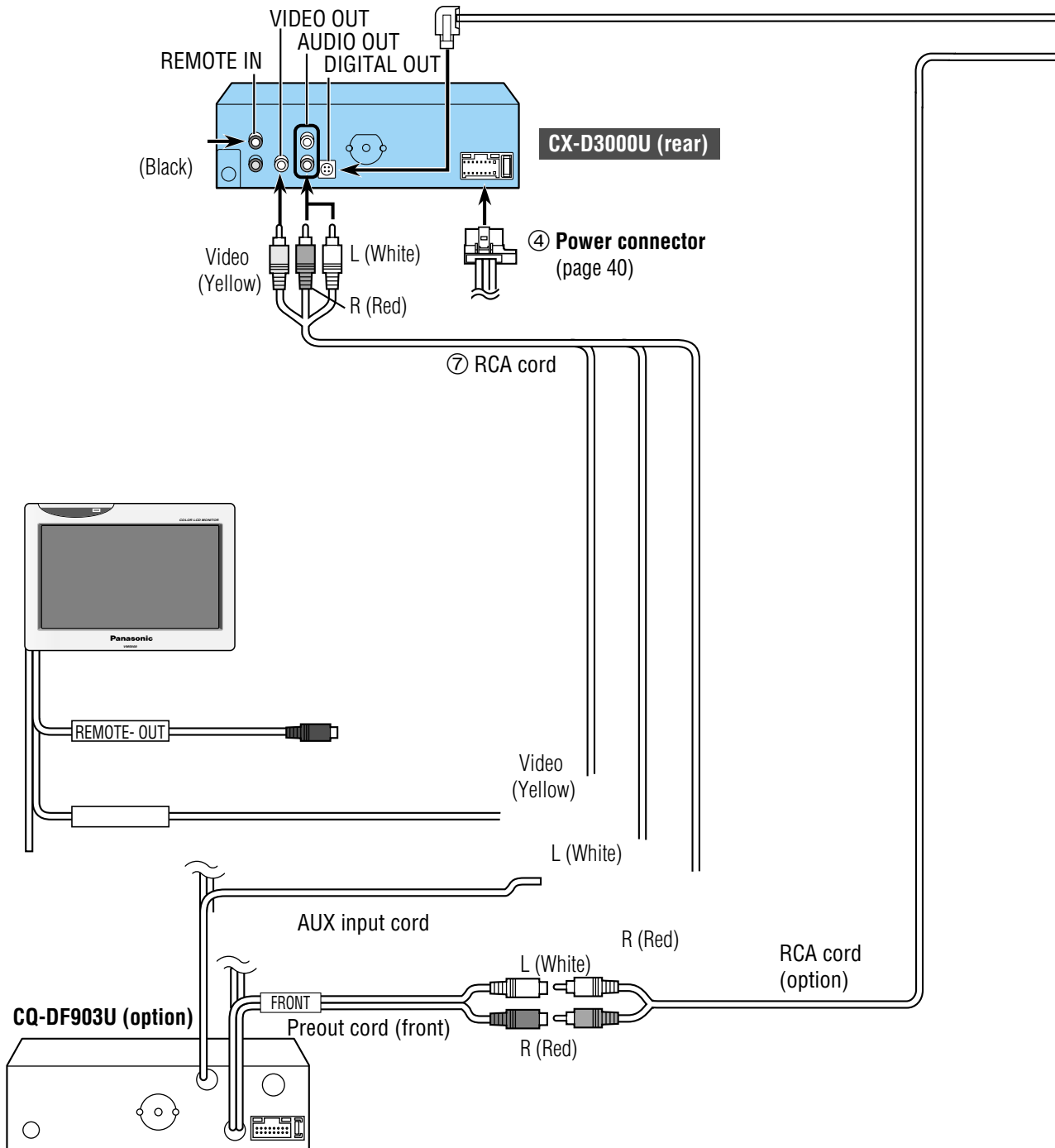

Optical Fiber Cable (CA-LRD60: option)
Notes on handling optical fiber cable:

- Do not bend the cable sharply.
- Do not allow the cable to be damaged by getting it caught in the door, placing a heavy object on it, etc.

Note:

- For wiring, carefully read the operating instructions for the devices connected.

CY-AC300
Operating unit

Operating unit/main unit connecting cord

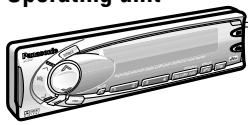

CY-AC300 Main unit (option)

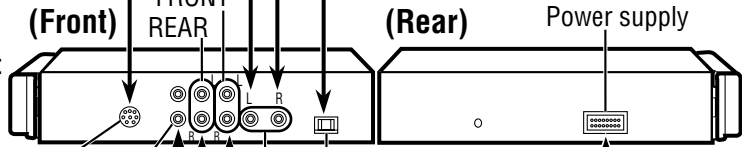

RCA cord (option) (When a two-way cord is used.)

L (White) R (Red)

CY-M7052 (option) (Top)

Amplifier control power cord (Blue/white stripe)

Subwoofer

L (White) R (Red) L (White) R (Red)

L (White) R (Red) L (White) R (Red)

CY-M9054 (option) (Top)

Amplifier control power cord (Blue/white stripe) (Connect to AMP-CONT)

Left speaker (rear) Right speaker (rear) Left speaker (front) Right speaker (front)

External amplifier control lead

AMP-CONT MAX 0.1A

Power connector

(Black/green stripe) (Black)

Center speaker EAB-CF2 (option)



Electrical Connections (continued)

□ Connecting side brake (parking brake) connection lead

Caution:

- For safety, be sure to ask your nearest professional installer to do this connection.

Side brake (parking brake)

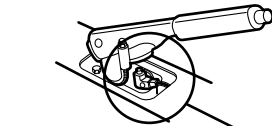

The side brake (parking brake) switch position varies with the car model.

For details on the exact location of the parking brake switch in your car, contact your dealer.

Foot brake

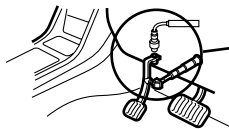

Parking brake switch

Cords connected to the vehicle.

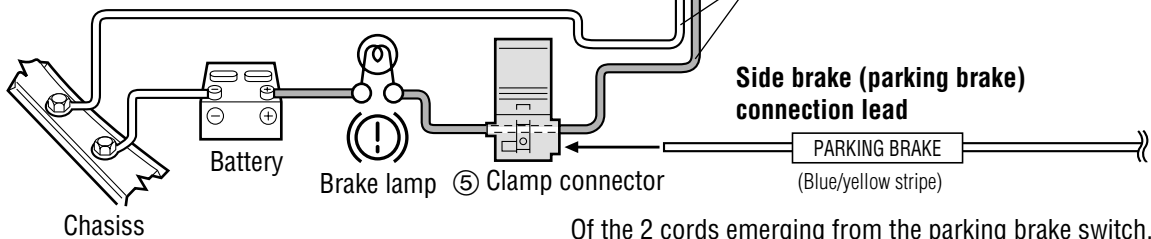

Of the 2 cords emerging from the parking brake switch, connect the player's parking brake cord to the one that is not connected to the vehicle's chassis while the brake is in the released state.

Connecting the Clamp Connector ⑤

- Attach the clamp connector to the vehicle cord at a suitable position.
- Note that if the cord being clamped onto is too thin (0.3 mm^2 or less), the connection may not be adequate.

- 1 Push the end of the side brake cord into the hole on the clamp connector. Place the vehicle cord into the groove in the clamp connector.

- 2 While making sure that the cords do not slip out of the clamp connector, press the element down with a pair of pliers.

- 3 Close the cover until it snaps shut.

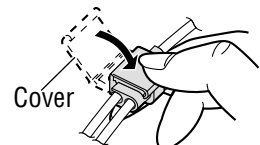
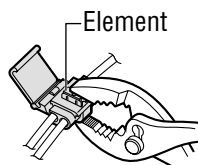
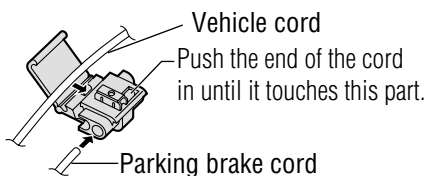



Specifications

Supply voltage: 12 V DC (11 V–16 V), test voltage 14.4 V, negative ground

Current consumption: Less than 1.7 A

Signal system: NTSC 1.0 Vp-p 75 Ω RCA pin jack

Discs played:
(1) DVD-Video disc
5" (12 cm) single-sided, single-layer/double-layer
5" (12 cm) double-sided, single-layer/double-layer
3" (8 cm) single-sided, single-layer/double-layer
3" (8 cm) double-sided, single-layer/double-layer
(2) Compact disc (CD-DA, Video CD, CD-R, CD-RW)
5" (12 cm) disc
3" (8 cm) disc

Audio output level: 2.5 Vrms Max. (at 600 Ω)

Audio signal

output characteristics: (1) Frequency response: 20 Hz–20 kHz (CD)
20 Hz–22 kHz (DVD video 48 kHz sampling)
20 Hz–44 kHz (DVD video 96 kHz sampling)
(2) S/N ratio: 95 dB (IHF, A)
(3) Wow and Flutter: Below measurable limits

Dimensions (W×H×D): 7"×1¹⁵/₁₆"×6¹/₈" (178×50×155 mm)

Weight: 2 lbs. 14 oz (1.3 kg)

Digital audio output:

Disc	Sound recording format	Optical digital audio output from connector
DVD	Dolby Digital	Dolby Digital bitstream (1–5.1 ch)
	DTS*	DTS bitstream (1–5.1 ch) (The analog portion is not output.)
	Linear PCM (48 kHz 16/20/24 bit)	Linear PCM (2 ch) (48 kHz sampling/16 bit only)
Video CD	MPEG 1	MPEG 1 bitstream
	Linear PCM	Linear PCM (2 ch) (44.1 kHz sampling/16 bit)
CD	Linear PCM	Linear PCM (2 ch) (44.1 kHz sampling/16 bit)
	DTS*	DTS bitstream (1–5.1 ch) (The analog portion is not output.)
MP3	MP3	Linear PCM (2 ch) (32 kHz/44.1 kHz/48 kHz sampling/16 bit)

*DTS only works with optical outputs.

“DTS” and “DTS Digital Out” are trademarks of Digital Theater Systems, Inc.

Above specifications comply with EIA standards.

Note:

• Specifications and design are subject to modification, without notice, due to improvements in technology.

**Panasonic Consumer Electronics
Company, Division of Matsushita
Electric Corporation of America**
One Panasonic Way, Secaucus,
New Jersey 07094
<http://www.panasonic.com>

**Panasonic Sales Company.
Division of Matsushita Electric of
Puerto Rico, Inc. ("PSC")**
Ave. 65 de Infanteria, Km. 9.5
San Gabriel Industrial Park,
Carolina, Puerto Rico 00985
<http://www.panasonic.com>

Panasonic Canada Inc.
5770 Ambler Drive,
Mississauga, Ontario
L4W 2T3
<http://www.panasonic.ca>