

Pioneer

DJ MIXER

DJM-250-K

DJM-250-W

<http://www.prodjnet.com/support/>

The Pioneer website shown above offers FAQs, information on software and various other types of information and services to allow you to use your product in greater comfort.

Operating Instructions

Thank you for buying this Pioneer product. Please read through these operating instructions so you will know how to operate your model properly. After you have finished reading the instructions, put them away in a safe place for future reference. In some countries or regions, the shape of the power plug and power outlet may sometimes differ from that shown in the explanatory drawings. However the method of connecting and operating the unit is the same.

IMPORTANT SAFETY INSTRUCTIONS

- 1) Read these instructions.
- 2) Keep these instructions.
- 3) Heed all warnings.
- 4) Follow all instructions.
- 5) Do not use this apparatus near water.
- 6) Clean only with dry cloth.
- 7) Do not block any ventilation openings. Install in accordance with the manufacturer's instructions.
- 8) Do not install near any heat sources such as radiators, heat registers, stoves, or other apparatus (including amplifiers) that produce heat.
- 9) Do not defeat the safety purpose of the polarized or grounding-type plug. A polarized plug has two blades with one wider than the other. A grounding type plug has two blades and a third grounding prong. The wide blade or the third prong are provided for your safety. If the provided plug does not fit into your outlet, consult an electrician for replacement of the obsolete outlet.
- 10) Protect the power cord from being walked on or pinched particularly at plugs, convenience receptacles, and the point where they exit from the apparatus.
- 11) Only use attachments/accessories specified by the manufacturer.
- 12) Use only with the cart, stand, tripod, bracket, or table specified by the manufacturer, or sold with the apparatus. When a cart is used, use caution when moving the cart/apparatus combination to avoid injury from tip-over.
- 13) Unplug this apparatus during lightning storms or when unused for long periods of time.
- 14) Refer all servicing to qualified service personnel. Servicing is required when the apparatus has been damaged in any way, such as power-supply cord or plug is damaged, liquid has been spilled or objects have fallen into the apparatus, the apparatus has been exposed to rain or moisture, does not operate normally, or has been dropped.



D3-7-13-69_En

NOTE:

This equipment has been tested and found to comply with the limits for a Class B digital device, pursuant to Part 15 of the FCC Rules. These limits are designed to provide reasonable protection against harmful interference in a residential installation. This equipment generates, uses, and can radiate radio frequency energy and, if not installed and used in accordance with the instructions, may cause harmful interference to radio communications. However, there is no guarantee that interference will not occur in a particular installation. If this equipment does cause harmful interference to radio or television reception, which can be determined by turning the equipment off and on, the user is encouraged to try to correct the interference by one or more of the following measures:

- Reorient or relocate the receiving antenna.
- Increase the separation between the equipment and receiver.
- Connect the equipment into an outlet on a circuit different from that to which the receiver is connected.
- Consult the dealer or an experienced radio/TV technician for help.

D8-10-1-2_A1_En

This Class B digital apparatus complies with Canadian ICES-003.

D8-10-1-3_A1_En

Information to User

Alterations or modifications carried out without appropriate authorization may invalidate the user's right to operate the equipment.

D8-10-2_A1_En

IMPORTANT NOTICE

THE MODEL NUMBER AND SERIAL NUMBER OF THIS EQUIPMENT ARE ON THE REAR OR BOTTOM. RECORD THESE NUMBERS ON PAGE 19 FOR FUTURE REFERENCE.

D36-AP9-1_A1_En_PSV

WARNING

This equipment is not waterproof. To prevent a fire or shock hazard, do not place any container filled with liquid near this equipment (such as a vase or flower pot) or expose it to dripping, splashing, rain or moisture.

D3-4-2-1-3_A1_En

WARNING

Before plugging in for the first time, read the following section carefully.

The voltage of the available power supply differs according to country or region. Be sure that the power supply voltage of the area where this unit will be used meets the required voltage (e.g., 230 V or 120 V) written on the side panel.

D3-4-2-1-4*_A1_En

WARNING

To prevent a fire hazard, do not place any naked flame sources (such as a lighted candle) on the equipment.

D3-4-2-1-7a_A1_En

Operating Environment

Operating environment temperature and humidity: +5 °C to +35 °C (+41 °F to +95 °F); less than 85 %RH (cooling vents not blocked)

Do not install this unit in a poorly ventilated area, or in locations exposed to high humidity or direct sunlight (or strong artificial light)

D3-4-2-1-7c*_A1_En

WARNING: Handling the cord on this product or cords associated with accessories sold with the product may expose you to chemicals listed on proposition 65 known to the State of California and other governmental entities to cause cancer and birth defect or other reproductive harm.

Wash hands after handling.

D36-P5_B1_En

This product is for general household purposes. Any failure due to use for other than household purposes (such as long-term use for business purposes in a restaurant or use in a car or ship) and which requires repair will be charged for even during the warranty period.

K041_A1_En

POWER-CORD CAUTION

Handle the power cord by the plug. Do not pull out the plug by tugging the cord and never touch the power cord when your hands are wet as this could cause a short circuit or electric shock. Do not place the unit, a piece of furniture, etc., on the power cord, or pinch the cord. Never make a knot in the cord or tie it with other cords. The power cords should be routed such that they are not likely to be stepped on. A damaged power cord can cause a fire or give you an electrical shock. Check the power cord once in a while. When you find it damaged, ask your nearest PIONEER authorized service center or your dealer for a replacement.

S002*_A1_En

The Safety of Your Ears is in Your Hands

Get the most out of your equipment by playing it at a safe level – a level that lets the sound come through clearly without annoying blaring or distortion and, most importantly, without affecting your sensitive hearing. Sound can be deceiving. Over time, your hearing “comfort level” adapts to higher volumes of sound, so what sounds “normal” can actually be loud and harmful to your hearing. Guard against this by setting your equipment at a safe level BEFORE your hearing adapts.

ESTABLISH A SAFE LEVEL:

- Set your volume control at a low setting.
- Slowly increase the sound until you can hear it comfortably and clearly, without distortion.
- Once you have established a comfortable sound level, set the dial and leave it there.

BE SURE TO OBSERVE THE FOLLOWING GUIDELINES:

- Do not turn up the volume so high that you can't hear what's around you.
- Use caution or temporarily discontinue use in potentially hazardous situations.
- Do not use headphones while operating a motorized vehicle; the use of headphones may create a traffic hazard and is illegal in many areas.

S001a_A1_En

If the AC plug of this unit does not match the AC outlet you want to use, the plug must be removed and appropriate one fitted. Replacement and mounting of an AC plug on the power supply cord of this unit should be performed only by qualified service personnel. If connected to an AC outlet, the cut-off plug can cause severe electrical shock. Make sure it is properly disposed of after removal. The equipment should be disconnected by removing the mains plug from the wall socket when left unused for a long period of time (for example, when on vacation).

D3-4-2-2-1a_A1_En

CAUTION

The **ON/OFF** switch on this unit will not completely shut off all power from the AC outlet. Since the power cord serves as the main disconnect device for the unit, you will need to unplug it from the AC outlet to shut down all power. Therefore, make sure the unit has been installed so that the power cord can be easily unplugged from the AC outlet in case of an accident. To avoid fire hazard, the power cord should also be unplugged from the AC outlet when left unused for a long period of time (for example, when on vacation).

D3-4-2-2-2a*_A1_En

Contents

How to read this manual

The names of displays, menus, and buttons in this manual are enclosed in brackets. (e.g. [MASTER] channel, [ON/OFF], [File] menu)

01 Before start

Features	5
System setup example	5
What's in the box	5

02 Connections

Names of Parts	6
Connecting the input/output terminals.....	7
About the AC adapter.....	8

03 Operation

Control panel.....	10
About the power switch of this unit	10
Basic operations (mixer section)	11
Using the filter function (filter section).....	12
Selecting the crossfader's curve characteristics (crossfader section).....	12
Starting playback of a Pioneer DJ player using the fader (fader start section)	12
Monitoring the sound over headphones (headphones section).....	13
Using a microphone or external device (MIC/AUX section).....	13

04 Additional information

Troubleshooting.....	14
Block Diagram	14
About trademarks and registered trademarks	15
Specifications.....	15

Before start

Features

This unit is a DJ mixer that carries over the technology of the Pioneer DJM series, the world standard in club sound. It is a standard type unit equipped with the basic functions required for mixing, enabling full-fledged DJ play easily.

SOUND COLOR FILTER

Each channel is equipped with a SOUND COLOR FILTER function by which filter effects can be achieved simply by turning a large control. This lets you arrange and mix tracks intuitively for DJ performances.

3-BAND EQUALIZER

This unit is equipped with a 3-band equalizer allowing the volume of the high, medium and low frequency ranges to be adjusted separately. Not only can the tone be adjusted to your tastes, the sound for a certain range can be turned completely off by turning the control all the way counterclockwise (isolator function).

MIC/AUX INPUT

This unit is equipped with three sets of AUX inputs for input of audio signals from external devices (computers, portable audio sets, TVs, synthesizers, etc.), as well as a microphone input. It can be used not only for DJ performances, but also as a pre-amp to appreciate music.

XLR OUTPUT

This unit is equipped with XLR balanced outputs featuring little loss of audio signal quality, enabling DJ performances with high sound quality. Also, it can be connected to powered speakers or other devices supporting XLR inputs without any changes to the terminals.

System setup example

A DJ system like the one shown on the diagram below can be achieved by combining this unit with a DJ player and peripheral equipment.

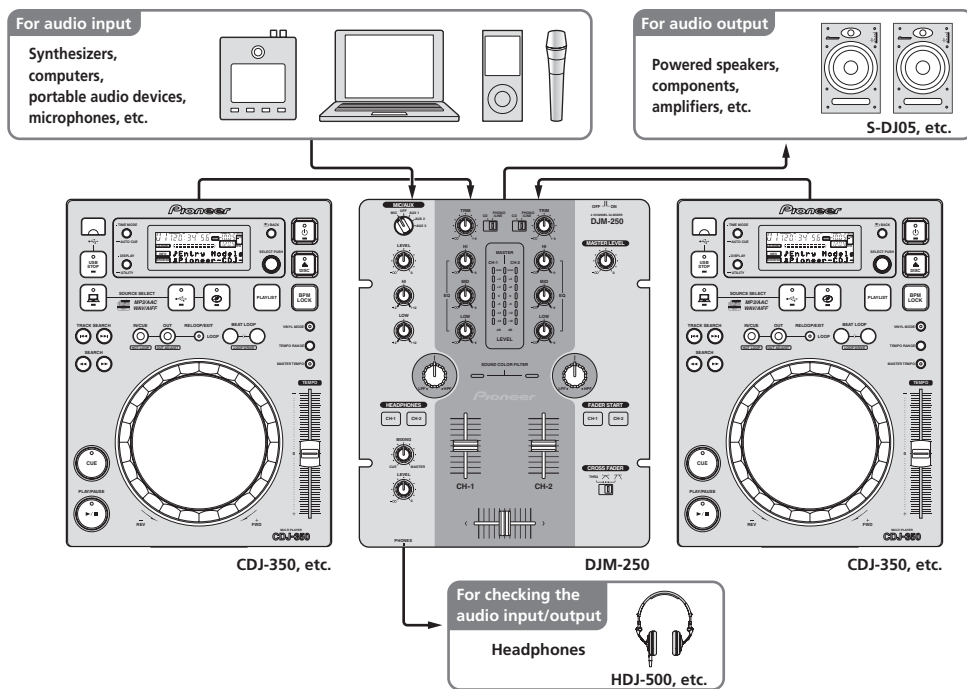

What's in the box

- AC adapter
- Power plug
- Operating instructions (this document)

Connections

Be sure to turn off the power and unplug the AC adapter from the power outlet before making or changing connections between devices. Wait until all connections between devices have been completed before connecting the AC adapter.

Only use the AC adapter included with this unit.

Refer to the operating instructions for the component to be connected.

Names of Parts

Rear panel, front panel

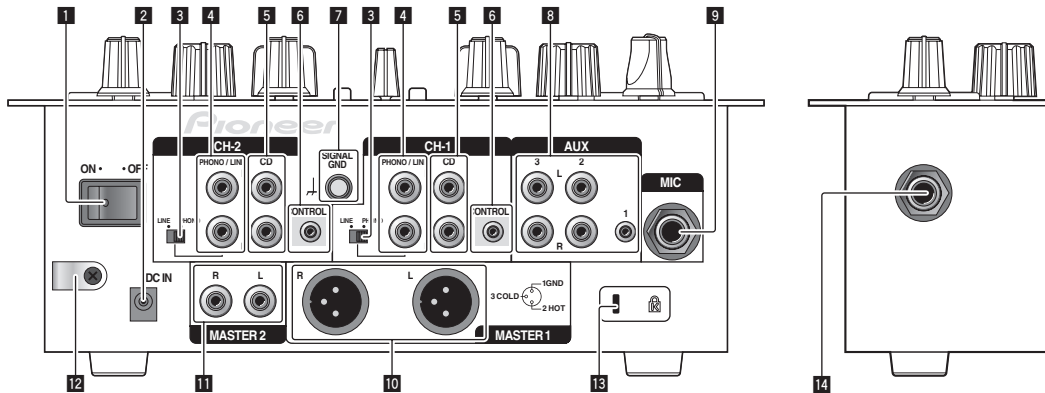

1 ON/OFF switch (page 10)

Turns this unit's power on and off.

2 DC IN terminal

Connect to a power outlet using the included AC adapter (with the power plug mounted). Wait until connection of all equipment is completed before connecting the AC adapter. Only use the included AC adapter.

3 PHONO/LINE selector switch (page 7)

Switches the function of the [PHONO/LINE] terminals.



CAUTION

When switching the [PHONO/LINE] selector switch, set [MASTER LEVEL] to [-∞]. Note that noise may be generated and sound output at a high volume.

4 PHONO/LINE terminals (page 7)

Connect a phono level output device (analog player (for MM cartridges), etc.) or a line level output device (DJ player, etc.) here. Switch the terminals' function according to the connected device using the [PHONO/LINE] selector switch on this unit's rear panel.

5 CD terminals (page 7)

Connect to a DJ player or other line level device.

6 CONTROL terminal (page 7)

Connect using a control cord (included with Pioneer DJ players).

7 SIGNAL GND terminal (page 7)

Connect an analog player's ground wire here. This helps reduce noise when the analog player is connected.

8 AUX terminals (page 7)

Connect to the output terminals of external devices (computers, portable audio sets, TVs, synthesizers, etc.).

9 MIC terminal (page 7)

Connect to a microphone.

10 MASTER 1 terminals (page 7)

Connect powered speakers, etc., here.

- Compatible with XLR connector type balanced outputs.

11 MASTER 2 terminals (page 7)

Connect powered speakers, etc., here.

- Compatible with RCA pin-jack type unbalanced outputs.

12 Cord hook

Hook the AC adapters' power cord here.

13 Kensington security slot

14 PHONES jack (page 7)

Connect headphones here.

Connecting the input/output terminals

- When creating a DVS (Digital Vinyl System) combining a computer, audio interface, etc., be careful in connecting the audio interface to this unit's input terminals and in the settings of the input selector switches. Also refer to the operating instructions of the DJ software and audio interface.

Rear panel, front panel

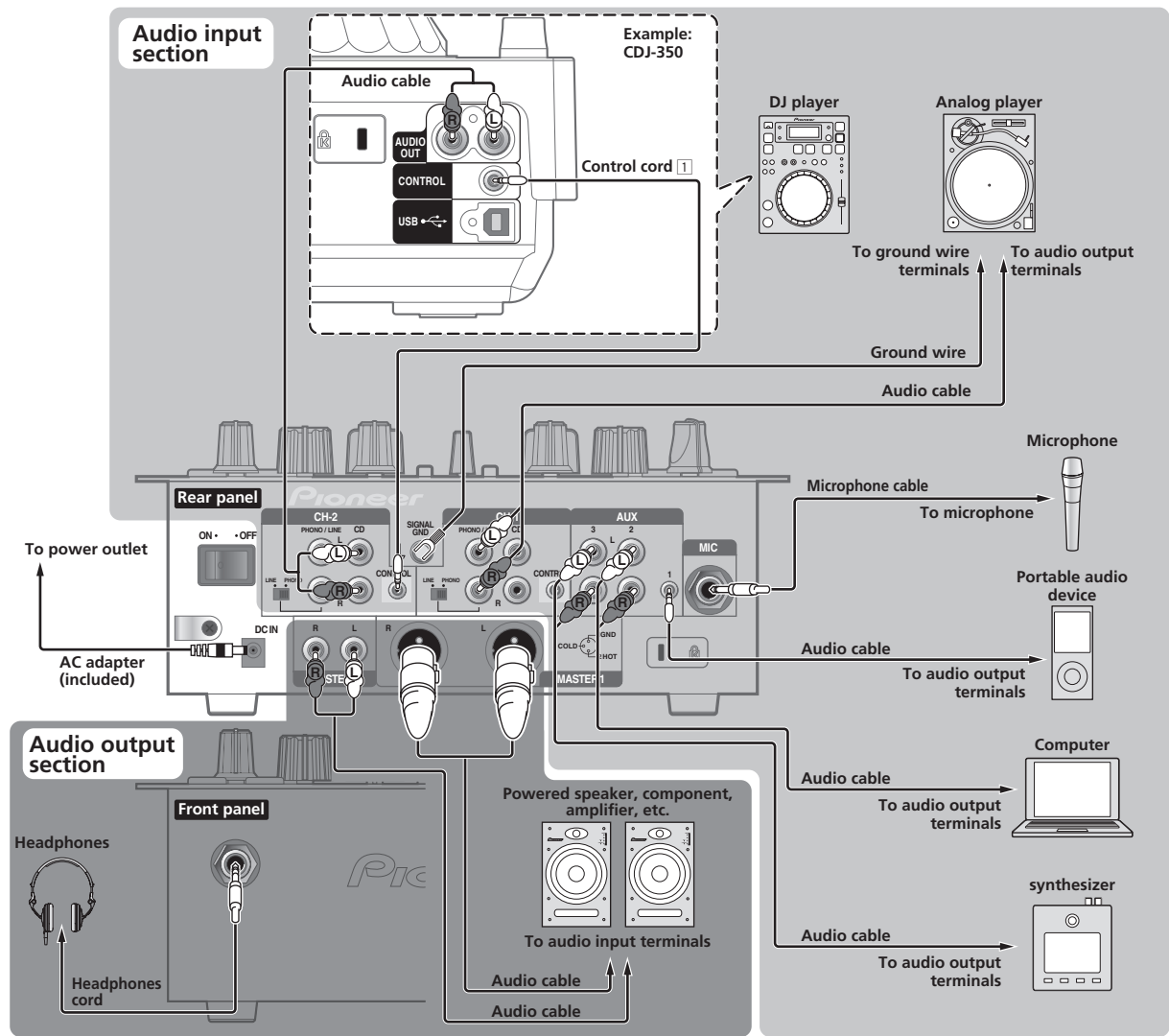

1 To use the fader start function, connect a control cord (page 12). The fader start function can only be used when connected to a Pioneer DJ player.

❖ Cord hook

Loosen the cord hook's screw and pinch the AC adapters' power cord under the hook.

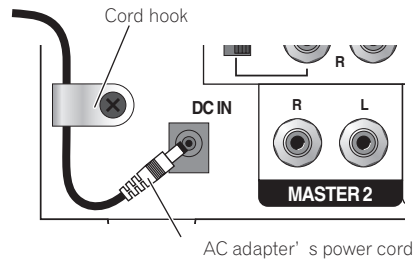

- Place the cord hook out of reach of children. If a child should swallow it, contact a physician immediately.

About the AC adapter

Safety instructions

To ensure your personal safety and to maximize the full operating potential of your unit, read and follow these safety instructions.

Read & Retain Instructions

Read all operating and user information provided with this product.

Cleaning

Use a damp cloth to clean the exterior housing. Avoid using any fluids including liquid, aerosol or alcohol-based cleaning products.

Water or Moisture

Avoid operating or locating this product near water or other sources of fluid.

Accessories

Do not place this product on an unstable cart, stand, or table. The product may fall and be seriously damaged.

Ventilation

Do not block or cover this product in use. This unit should not be placed in a built-in installation unless properly ventilated.

Environment

Avoid placing this product in a location with exposure to large quantities of dust, high temperatures, high humidity, or subject to excessive vibrations or shocks.

Power Sources

Operate this product only from the recommended power sources. If you are unsure of the power source, consult an authorized Pioneer representative.

Power-Cord Protection

When unplugging the unit, pull on the plug – not on the cord. Do not handle the cord or plug with wet hands; doing so could cause an electric short or shock. Do not allow anything to pinch or rest on the power cord and do not place in a walkway.

Power

Turn OFF the system before installing this or any other hardware device.

Overloading

Avoid connecting too many devices to a single wall socket or power source as this can cause fires or short circuits.

Object & Liquid Entry

Never push inappropriate objects in to the device. Avoid spilling any liquids in to or on the outside of the drive.

Servicing

Opening or removing the cover exposes you to possible electrical shock or other danger. Contact a Pioneer authorized service representative for repairing this product (refer to the enclosed Service & Support Card).

Damage Requiring Service

Unplug the unit and refer servicing to qualified service personnel in the following situations:

- When the power cord, plug, or chassis is damaged.
- If liquid has been spilled, or objects have fallen into the product.
- If the product has been exposed to rain or water.
- If the product does not operate normally when the operating instructions are followed. Adjust only those controls that are covered by the operating instructions. Improper adjustment of other controls may result in damage and can require extensive work by a qualified technician to restore the unit to its normal operation.
- When the product exhibits a distinct change in performance – this indicates a need for service.

Check that there are no irregularities with the AC adapter or power plug, then insert the power plug into the specified position of the AC adapter using the specified procedure until a click is heard. For details, see *Mounting the power plug* on page 9.

If there are irregularities with the AC adapter or power plug, ask your nearest Pioneer authorized service center or your dealer to carry out repair work.

- Do not place the AC adapter cord around your neck. Doing so could result in suffocation.
- Do not use this unit with a coin, paper clip or other metal object stuck between the AC adapter and power plug. Doing so could cause a short circuit, leading to fire or electric shock.

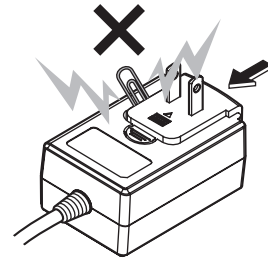

- When mounting the AC adapter on a wall outlet, make sure there is no space between the AC adapter and the wall outlet. Faulty contact or a coin, paper clip or other metal object getting stuck in the space could cause a short circuit, leading to fire or electric shock.

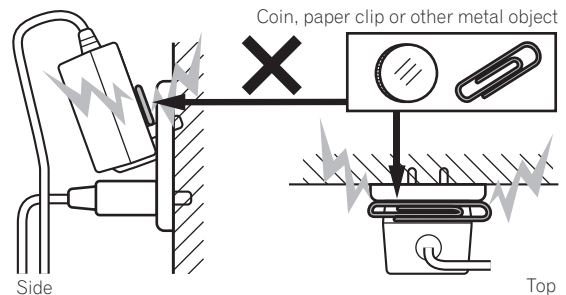

- The power plug could come detached from the AC adapter and remain in the power outlet if someone trips on the AC adapter's power cord or if something hits the AC adapter. If this happens, remove the power plug remaining in the outlet with dry hands, holding it as shown on the diagram below and without touching metal parts. Do not use any tools to remove it.

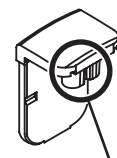
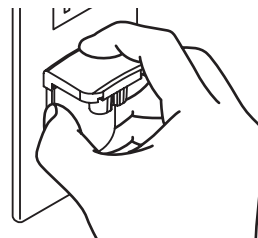

Mounting the power plug

Slide the power plug along the guide rails in the AC adapter unit as shown on the diagram below, then press in until a click is heard.

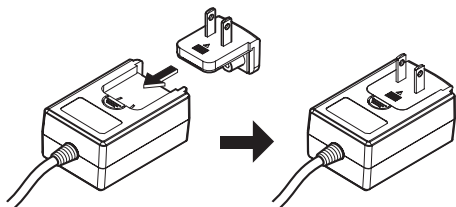

❖ Removing the power plug

While pressing the [PUSH] button on the AC adapter unit, slide the power plug away from the adapter as shown on the diagram below to remove it.

Once the power plug is mounted, there is no need to remove it.

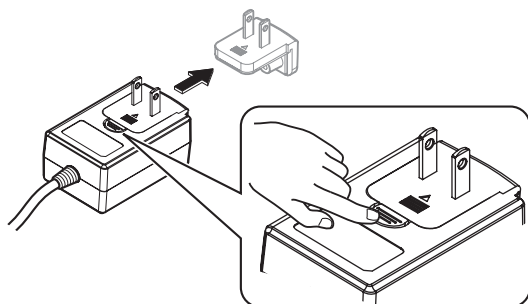

Power plug

The power plug shown below is included with this product.

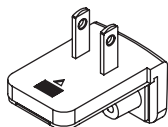

Operation

Control panel

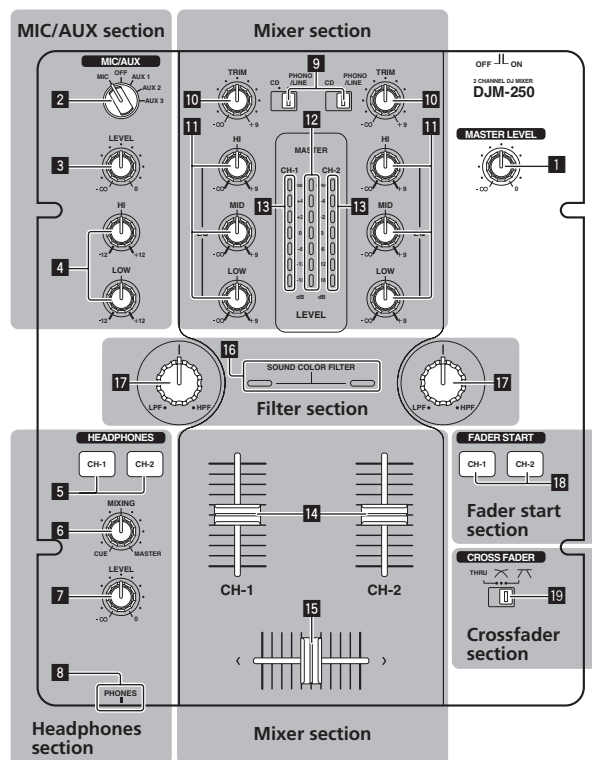

1 MASTER LEVEL control (page 11)

MIC/AUX section

This section handles the sound of microphones or external devices (computers, portable audio sets, TVs, synthesizers, etc.) (page 13).

- 2** MIC, OFF, AUX 1, AUX 2, AUX 3 input selector switch
- 3** LEVEL control (MIC/AUX section)
- 4** HI, LOW controls

Headphones section

The sound being input to this unit can be checked over headphones (page 13).

- 5** CH-1, CH-2 buttons (headphones section)
- 6** MIXING control
- 7** LEVEL control (headphones section)
- 8** PHONES jack

Mixer section

Two sets of audio signals can be adjusted separately for basic DJ mixing (page 11).

- 9** CD, PHONO/LINE input selector switch
- 10** TRIM control
- 11** EQ (HI, MID, LOW) control
- 12** Master level indicator
- 13** Channel level indicator
- 14** Channel fader
- 15** Crossfader

Filter section

- 16** SOUND COLOR FILTER indicator
- 17** SOUND COLOR FILTER control

Fader start section

- 18** CH-1, CH-2 buttons (fader start section)

Crossfader section

- 19** THRU, \wedge , ∇ (crossfader curve selector switch)

About the power switch of this unit

To turn the power on

Set the [ON/OFF] switch on this unit's rear panel to [ON]. This turns this unit's power on (page 6).

Basic operations (mixer section)

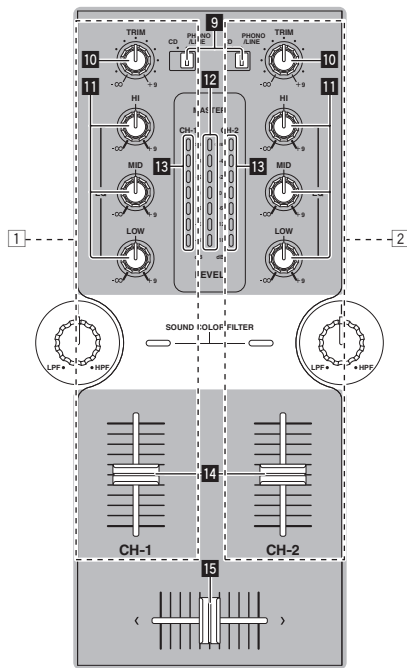

Outputting sound

Check that this unit is properly connected to the DJ player, etc., before outputting sound. For instructions on connections, see *Connecting the input/output terminals* on page 7.

Set the volume of the powered speakers connected to the [MASTER 1] and [MASTER 2] terminals to a suitable level. Note that sound will be output at a high volume if the volume is set too high.

For instructions on monitoring the sound, see *Monitoring the sound over headphones (headphones section)* on page 13.

❖ To output the sound of channel 1 [CH-1] 1

To output the sound of channel 2 ([CH-2] 2), perform the procedure below replacing [CH-1] with [CH-2].

1 Switch the [CH-1] 1 [CD, PHONO/LINE] input selector switch 9.

Select the input source for [CH-1] from among the devices connected to this unit.

- [CD]: Selects the DJ player connected to the [CD] terminals.
- [PHONO/LINE]: Selects the device connected to the [PHONO/LINE] terminals.

2 Turn the [CH-1] 1 [TRIM] control 10 clockwise.

Adjusts the audio level input to the [CH-1] terminal.

The [CH-1] channel level indicator 18 lights when audio signals are being properly input to [CH-1].

Adjust the [TRIM] control so that the orange indicator lights where the track's volume is highest (at the climax, etc.)

Be careful that the red indicator does not light, or the sound could be distorted.

3 Move the [CH-1] 1 channel fader 14 away from you.

The level of the sound output from the [CH-1] terminals is adjusted.

4 Switch [THRU, ㄨ, ㄨ] (the crossfader curve selector switch) 19.

This switches the crossfader's curve characteristics. For details, see *Selecting the crossfader's curve characteristics (crossfader section)* on page 12.

5 Move the crossfader 15.

Switch the channel whose sound is output from the speakers.

- Left edge: The [CH-1] sound is output.
 - Center position: The sound of [CH-1] and [CH-2] is mixed and output.
 - Right edge: The [CH-2] sound is output.
- This operation is not necessary when the [THRU, ㄨ, ㄨ] (crossfader curve selector) switch is set to [THRU].

6 Turn the [MASTER LEVEL] control 1 clockwise.

Sound is output from the speakers.

The master level indicator 12 on the control panel lights.

Adjust [MASTER LEVEL] so that the orange indicator lights at the point in the track where the volume is loudest (the climax, etc.).

Be careful that the red indicator does not light, or the sound could be distorted.

Adjusting the sound quality

Turn the [CH-1] 1 or [CH-2] 2 EQ (HI, MID, LOW) control 11.

Refer to *Specifications* on page 15 for the range of sound that can be adjusted by each control.

- The sound for that range can be turned completely off by turning the control all the way counterclockwise (isolator function).

Mixing using the faders

Prepare the unit in advance so that the sound of [CH-1] 1 is being output from the speakers. For instructions on preparation, see *Outputting sound* on page 11.

❖ Mixing using the channel faders

1 Set [THRU, ㄨ, ㄨ] (the crossfader curve selector switch) 19 to [THRU].

2 Switch the [CH-2] 2 [CD, PHONO/LINE] input selector switch 9.

3 Turn the [CH-2] 2 [TRIM] control 10 clockwise.

4 Press the [CH-2] button 5 in the headphones section.

The sound of [CH-2] is monitored from the headphones.

5 Turn the [MIXING] control 6.

Adjust the monitor volume balance of the sound output from the [MASTER 1] or [MASTER 2] terminals (the [CH-1] sound) and the [CH-2] sound.

6 Operate the DJ player connected to the [CH-2] terminals.

While checking the sound over the headphones, adjust the tempo of [CH-2] track to match the tempo of [CH-1] track.

7 While moving the [CH-2] 2 channel fader to the back, move the [CH-1] 1 channel fader to the front.

While checking the sound output from the speakers, operate the channel faders to substitute the sound of [CH-1] with the sound of [CH-2]. Mixing is completed once only the [CH-2] sound is being output from the speakers.

❖ Mixing using the crossfader

1 Set [THRU, ㄨ, ㄨ] (the crossfader curve selector switch) 19 to [ㄨ] or [ㄨ].

2 Operate [CH-2] 2.

Operate as described in steps 2 to 6 under *Mixing using the channel faders* on page 11.

3 Move the crossfader 15 gradually towards the right.

While checking the sound output from the speakers, operate the crossfader to substitute the sound of [CH-1] with the sound of [CH-2].

Mixing is completed once only the [CH-2] sound is being output from the speakers.

Using the filter function (filter section)

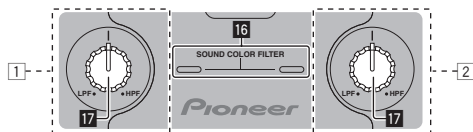

Each channel is equipped with a SOUND COLOR FILTER function by which filter effects can be achieved simply by turning a large control. The treble or bass sound can be removed by turning the [SOUND COLOR FILTER] control 17.

Turn the [CH-1] 1 or [CH-2] 2 [SOUND COLOR FILTER] control 17.

The effect is applied to the sound and the indicator's color changes. The effect type and indicator color differs according to the direction in which the [FILTER] control is turned, as shown on the table below.

Direction of rotation	Description of effect	Indicator
Left	Applies the effect of the treble sound fading out. (LPF: low pass filter)	Red (flashing)
Center	—	Orange (lit)
Right	Applies the effect of the bass sound fading out. (HPF: high pass filter)	Green (flashing)

Mixing using the SOUND COLOR FILTER control

Prepare the unit in advance so that the sound of [CH-1] 1 is being output from the speakers. For instructions on preparation, see *Outputting sound* on page 11.

For instructions on monitoring the sound, see *Monitoring the sound over headphones (headphones section)* on page 13.

1 Operate the crossfader and [CH-2] 2.

Operate as described in steps 2 to 6 under *Mixing using the channel faders* on page 11.

2 Turn the [CH-2] 2 [SOUND COLOR FILTER] control 17 fully clockwise.

3 Move the [CH-2] 2 channel fader 14 away from you.

4 While turning the [CH-1] 1 [SOUND COLOR FILTER] control 17 counterclockwise from the center, turn the [CH-2] 2 [SOUND COLOR FILTER] control 17 towards the center.

While checking the sound output from the speakers, operate the [SOUND COLOR FILTER] controls 17 and replace the [CH-1] and [CH-2] sound.

Move the [CH-1] 1 channel fader 14 towards the front. Mixing is completed once only the sound of [CH-2] is output from the speakers.

Selecting the crossfader's curve characteristics (crossfader section)

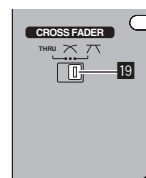

- [THRU]: Choose this when you do not want to use the crossfader.
- [Gradual curve symbol]: Set here for a curve that rises gradually.
- [Steep curve symbol]: Set here for a curve that rises steeply. (When the crossfader moves away from either the left or right edge, the sound is immediately output from the opposite side.)

Starting playback of a Pioneer DJ player using the fader (fader start section)

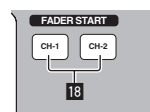

If you connect a Pioneer DJ player using a control cable (supplied with a DJ player), you can start playback of control other operations of the DJ player with the fader of this unit.

The fader start function can only be used when connected to a Pioneer DJ player.

Connect this unit and Pioneer DJ player beforehand. For instructions on connections, see *Connecting the input/output terminals* on page 7.

To start playback using the channel faders

1 Set [THRU, Gradual curve symbol, Steep curve symbol] (the crossfader curve selector switch) 19 to [THRU].

2 Press the [CH-1] or [CH-2] button 18 in the fader start section.

Turn the fader start function on.

3 Move the channel fader 14 to the very front.

4 Set the cue on the DJ player.

The DJ player pauses playback at the cue point.

5 Move the channel fader 14 away from you.

Playback starts on the DJ player.

- If you set the channel fader back to the original position, the player instantaneously returns to the cue point already set and pauses playback (back cue).

To start playback using the crossfader

- 1 Set [THRU, 7, 7] (the crossfader curve selector switch) 19 to [7] or [7].
- 2 Press the [CH-1] or [CH-2] button 18 in the fader start section.
Turn the fader start function on.
- 3 Move the crossfader 15.
Move the crossfader to the opposite edge from the channel for which you want to use the fader start function.
- 4 Set the cue on the DJ player.
The DJ player pauses playback at the cue point.
- 5 Move the crossfader 15.
Playback starts on the DJ player.
 - If you set the crossfader back to the original position, the player instantaneously returns to the cue point already set and pauses playback (back cue).

Monitoring the sound over headphones (headphones section)

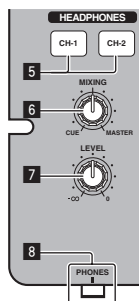

- 1 Connect headphones to the [PHONES] terminal.
For instructions on connections, see *Connecting the input/output terminals* on page 7.
- 2 Press the [CH-1] or [CH-2] button 5 in the headphones section.
Select the channel you want to monitor.
 - [CH-1]: The sound of [CH-1] is monitored.
 - [CH-2]: The sound of [CH-2] is monitored.
 - This operation is not necessary to monitor the [MASTER 1] or [MASTER 2] (master channel) sound.
- 3 Turn the [MIXING] control 6.
 - When turned counterclockwise: The volume of [CH-1] and [CH-2] becomes relatively louder.
 - Center position: The volume of the [CH-1] and [CH-2] sound is the same level as the [MASTER 1] and [MASTER 2] sound.
 - When turned clockwise: The volume of [MASTER 1] and [MASTER 2] become relatively louder.
- 4 Turn the [LEVEL] control 7 in the headphones section clockwise.
Sound is output from the headphones.
 - When the [CH-1] or [CH-2] button in the headphones section is pressed again, monitoring is canceled.
 - [MASTER 1] and [MASTER 2] monitoring cannot be canceled.

Using a microphone or external device (MIC/AUX section)

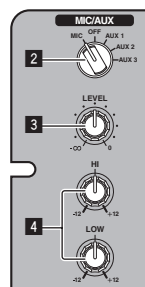

- 1 Switch the [MIC, OFF, AUX 1, AUX 2, AUX 3] input selector switch 2.
 - [MIC]: The microphone connected to the [MIC] terminal is selected.
 - [AUX1-3]: Selects the external device connected to the [AUX1-3] terminals.
 - 2 Turn the [LEVEL] control 3 in the MIC/AUX section clockwise.
The sound of the microphone or external device is output from the speakers.
-
- ## Adjusting the sound quality
- Turn the [HI] or [LOW] control 4 in the MIC/AUX section.
Refer to *Specifications* on page 15 for the range of sound that can be adjusted by each control.

Additional information

Troubleshooting

- Incorrect operation is often mistaken for trouble or malfunction. If you think that there is something wrong with this component, check the points below. Sometimes the trouble may lie in another component. Inspect the other components and electrical appliances being used. If the trouble cannot be rectified after checking the items below, ask your nearest Pioneer authorized service center or your dealer to carry out repair work.
- This unit may not operate properly due to static electricity or other external influences. In this case, proper operation may be restored by turning the power off, waiting 1 minute, then turning the power back on.

Problem	Check	Remedy
The power is not turned on.	Is the included AC adapter properly connected?	Connect the included AC adapter properly to the power outlet. (page 7) Properly attach the included AC adapter's power cord to this unit's cord hook. (Page 7)
	Is the [ON/OFF] switch for power supply set to [ON]?	Set the [ON/OFF] switch for power supply to [ON]. (Page 10)
No sound or small sound.	Is the [CD, PHONO/LINE] input selector switch set to the proper position?	Switch the [CD, PHONO/LINE] input selector switch to the channel's input source. (Page 11)
	Is the [PHONO/LINE] selector switch on this unit's rear panel set to the proper position?	Switch the terminals' function using the [PHONO/LINE] selector switch on this unit's rear panel. (Page 6)
	Are the [TRIM], [channel fader], [crossfader] and [MASTER LEVEL] controls set to the proper positions?	Set the [TRIM], [channel fader], [crossfader] and [MASTER LEVEL] controls to the proper positions. (Page 11)
	Are the connected powered speakers, etc., properly set?	Properly set the external input selection, volume, etc., on the powered speakers, etc.
Distorted sound.	Are the connection cables properly connected?	Connect the connection cables properly. (page 7)
	Are the terminals and plugs dirty?	Clean the terminals and plugs before making connections.
	Is [MASTER LEVEL] set at the proper position?	Adjust the [MASTER LEVEL] control so that the master level indicator's orange indicator lights at the peak level. (Page 11)
Can't crossfade.	Is [TRIM] set at the proper position?	Adjust the [TRIM] control so that the channel level indicator's orange indicator lights at the peak level. (Page 11)
	Is the [THRU, \wedge , \wedge] (crossfader curve selector) switch set to [THRU]?	Set the [THRU, \wedge , \wedge] (crossfader curve selector) switch to a position other than [THRU]. (Page 11)
Can't fader start a DJ player.	Is the [CH-1] or [CH-2] button in the fader start section set to the off position?	Set the [CH-1] or [CH-2] button in the fader start section to the on position. (page 12)
	Is the control cord properly connected?	Connect this unit and DJ player with a control cord. (page 7)
	Are the audio cables properly connected?	Connect this unit to the audio output terminal of a DJ player with an audio cable. (page 7)
Sound is distorted when an analog player is connected to this unit's [PHONO/LINE] terminals. Or, lighting of the channel level indicator does not change even when the [TRIM] control is turned.	Have you connected an analog player with a built-in phono equalizer?	If the analog player is equipped with a built-in phono equalizer, connect it to the [CD] terminals. (page 7)
	Is an audio interface for computers connected between the analog player and this unit?	If the analog player has a PHONO/LINE selector switch, switch it to PHONO. If the computer audio interface's output is line level, connect it to the [CD] terminals. (page 7) If the analog player has a PHONO/LINE selector switch, switch it to PHONO.

Block Diagram

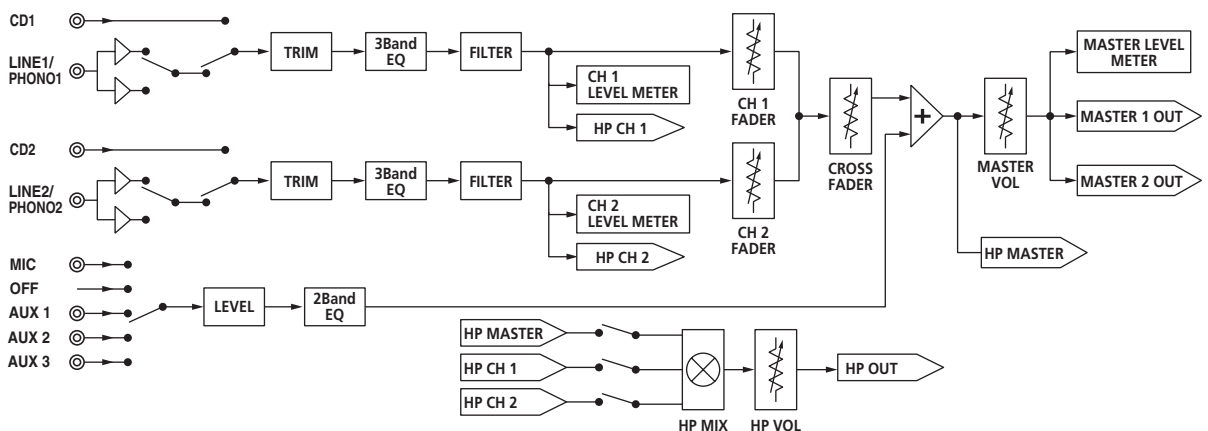

About trademarks and registered trademarks

- Pioneer is a registered trademark of PIONEER CORPORATION.
- The names of companies and products mentioned herein are the trademarks of their respective owners.
- When playing music files you have acquired on this unit, we kindly ask you to respect copyrights.

Specifications

AC adapter

Power..... AC 100 V to 240 V, 50 Hz/60 Hz
 Rated current 800 mA
 Rated output..... DC 5 V, 3 A

General – Main Unit

Main unit weight 3.1 kg (6.83 lb)
 Max. dimensions 240 mm (W) × 107.7 mm (H) × 300.2 mm (D)
 (9.45 in. (W) × 4.24 in. (H) × 11.8 in. (D))
 Tolerable operating temperature +5 °C to +35 °C (+41 °F to +95 °F)
 Tolerable operating humidity 5 % to 85 % (no condensation)

Audio Section

Sampling rate 48 kHz
 A/D, D/A converter 24 bits
 Frequency characteristic
CD/LINE/AUX/MIC 20 Hz to 20 kHz

S/N ratio (rated output)

CD 91 dB
LINE 91 dB
PHONO 86 dB
MIC 80 dB

Total harmonic distortion (**CD — MASTER 1**) 0.007 %

Standard input level / Input impedance

CD -12 dBu/10 kΩ
LINE -12 dBu/47 kΩ
PHONO -48 dBu/47 kΩ
MIC -52 dBu/10 kΩ
AUX 1 -12 dBu/10 kΩ
AUX 2, 3 -12 dBu/10 kΩ

Standard output level / Load impedance / Output impedance

MASTER 1 +6 dBu/10 kΩ/330 Ω
MASTER 2 +2 dBu/10 kΩ/1 kΩ
PHONES +2 dBu/32 Ω/33 Ω

Rated output level / Load impedance

MASTER 1 +22 dBu/10 kΩ
MASTER 2 +18 dBu/10 kΩ

Crosstalk (**CD**) 74 dB

Channel equalizer characteristic

HI -∞ to +9 dB (13 kHz)
MID -∞ to +9 dB (1 kHz)
LOW -∞ to +9 dB (70 Hz)

MIC/AUX equalizer characteristics

HI -12 dB to +12 dB (10 kHz)
LOW -12 dB to +12 dB (100 Hz)

Input/output terminals

CD input terminal

RCA pin jack 2 sets

PHONO/LINE input terminals

RCA pin jack 2 sets

MIC input terminal

Phone jack (Ø 6.3 mm) 1 set

AUX input terminal

RCA pin jack 2 sets

Mini phone jack (Ø 3.5 mm) 1 set

MASTER output terminal

RCA pin jacks 1 set

BALANCED OUTPUT output terminal

XLR connector 1 set

PHONES output terminal

Stereo phone jack (Ø 6.3 mm) 1 set

CONTROL terminal

Mini phone jack (Ø 3.5 mm) 2 sets

- The specifications and design of this product are subject to change without notice.



Pioneer Electronics(USA) Inc.

Limited Warranty

Additional information

WARRANTY PERIOD

For the period specified below from the date of original purchase (the warranty period), Pioneer Electronics(USA) Inc. (Pioneer) warrants that the products described below, if purchased directly from Pioneer or from an authorized Pioneer dealer or distributor in the United States and installed and operated according to operating instructions enclosed with the unit, will be repaired or replaced with a unit of comparable value, at the option of Pioneer, without charge to you for parts or labor for actual repair work if such products fail to function properly under normal use due to a manufacturing defect. Parts supplied under this warranty may be new or rebuilt at the option of Pioneer.

PRODUCTS COVERED	MODEL PREFIX	WARRANTY PERIOD	
		Parts	Labor
DJ Compact Disc Player	CDJ, CMX	1 YEAR	1 YEAR
DJ DVD Player	DVJ	1 YEAR	1 YEAR
Digital Media Player	DMP	1 YEAR	1 YEAR
DJ Mixer	DJM	1 YEAR	1 YEAR
DJ Effector	EFX	1 YEAR	1 YEAR
Video Switcher	VSW	1 YEAR	1 YEAR

This warranty covers the product during the warranty period whether in the possession of the original owner or any subsequent owner.

WHAT'S NOT COVERED

This warranty does not cover the A-B Cross Fader in the DJ Mixer (model prefix DJM). This warranty does not cover any appearance item, any damage to the product resulting from alterations, modifications not authorized in writing by Pioneer, accident, misuse or abuse, damage due to lightning or to power surges or personal injury due to excessive sound pressure levels. This warranty does not cover the cost of parts or labor which would be otherwise provided without charge under this warranty, obtained from any source other than a Pioneer Authorized Service Company or other designated location. This warranty does not cover defects or damage caused by the use of unauthorized parts or labor, or from improper maintenance.

PRODUCTS WITH ALTERED, DEFACED OR REMOVED SERIAL NUMBERS SHALL VOID THIS WARRANTY.

YOUR RIGHTS

SOME STATES DO NOT ALLOW THE EXCLUSION OR LIMITATION OF INCIDENTAL OR CONSEQUENTIAL DAMAGES, SO THE FOLLOWING LIMITATIONS OR EXCLUSIONS MAY NOT APPLY TO YOU.

THE ABOVE WARRANTIES ARE IN LIEU OF AND EXCLUDE ALL OTHER WARRANTIES, EXPRESSED OR IMPLIED, INCLUDING WITHOUT LIMITATION IMPLIED WARRANTIES OF MERCHANTABILITY AND FITNESS FOR ANY PARTICULAR PURPOSE. IN NO EVENT SHALL PIONEER BE LIABLE FOR INCIDENTAL OR CONSEQUENTIAL DAMAGES ARISING OUT OF LOSS OF USE OR CLAIMS ASSERTED ON THE BASIS OF TORT (INCLUDING NEGLIGENCE), CONTRACT, OR OTHERWISE.

TO OBTAIN SERVICE

Pioneer has appointed a number of Authorized Industrial Service Companies throughout the U.S.A. should your product ever require service. To receive warranty service you will need to present your sales receipt or, if rented, your rental contract showing place and date of original purchase transaction.

Should it become necessary to ship the unit, you will need to package the product and send it, transportation prepaid, to an Authorized Service Company in the U.S.A. Carefully package the product using adequate padding material to prevent damage in transit. The original container is ideal for this purpose. Include in the package your name, address, telephone number where you can be reached during business hours, a copy of your sales receipt, and a detailed description of the problem.

To find the name and address of the nearest Pioneer Authorized service location, to obtain warranty service or for additional information about this warranty, please call or write:

PIONEER ELECTRONICS(USA) INC.
CUSTOMER SUPPORT DIVISION
P.O. BOX 1760
LONG BEACH, CALIFORNIA 90801-1760
1-800-872-4159

DO NOT RETURN ANY PRODUCT TO ABOVE ADDRESS. IT IS NOT A SERVICE LOCATION.

TO ORDER REPLACEMENT PARTS CALL 800-228-7221

RECORD THE PLACE AND DATE OF PURCHASE FOR FUTURE REFERENCE

Model No. _____ Serial No. _____ Purchase Date _____

Purchased From _____

KEEP THIS INFORMATION AND YOUR SALES RECEIPT IN A SAFE PLACE

To register your product, find the nearest authorized service location, to purchase replacement parts, operating instructions, or accessories, please go to one of following URLs :

Pour enregistrer votre produit, trouver le service après-vente agréé le plus proche et pour acheter des pièces de rechange, des modes d'emploi ou des accessoires, reportez-vous aux URL suivantes :

In the USA/Aux Etats-Unis

<http://www.pioneerelectronics.com>

In Canada/Aux Canada

<http://www.pioneerelectronics.ca>

S018_B1_EnFr

© 2011 PIONEER CORPORATION.
All rights reserved.

PIONEER CORPORATION

1-1, Shin-ogura, Saiwai-ku, Kawasaki-shi, Kanagawa 212-0031, Japan

PIONEER ELECTRONICS (USA) INC.

P.O. BOX 1540, Long Beach, California 90801-1540, U.S.A. TEL: (800) 421-1404

PIONEER ELECTRONICS OF CANADA, INC.

340 Ferrier Street, Unit 2, Markham, Ontario L3R 2Z5, Canada TEL: 1-877-283-5901, 905-479-4411

K002_PSV_CU

Printed in China

<DRB1581-A>
<502-DM250A-3135>