

Concerning Compact Discs



Only compact discs bearing this mark can be used with this unit.

However, continued use of irregular shape CDs can damage the unit.



How to remove a disc from its case

How to store the disc in its case

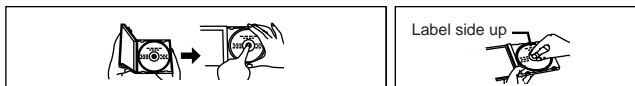

How to hold a disc

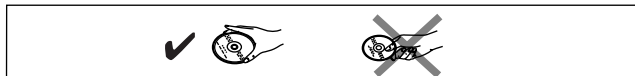

If the surface is dirty

Wipe it with a damp cloth and then wipe dry.
Wipe from the center toward the circumference.

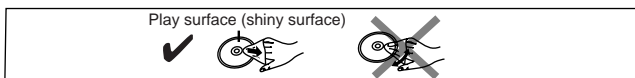

Handling precautions

- If you are taking the CD from a cold to a warm environment, moisture may form on the CD. Wipe this off with a soft, dry, lint-free cloth before using the CD.
- Do not write on the label side with a ball-point pen or other writing instrument.
- Do not use record cleaning sprays, benzene, thinner, static electricity prevention liquids or any other solvent.
- Do not attach labels or stickers to CDs. (Do not use CDs with exposed adhesive from tape or left over peeled off stickers.)

- Do not use scratch-proof protectors or covers other than those specified for use with this unit.
- Storage precautions**
Be sure to store CDs in their cases to protect them from dust, scratches, and warping.
- Do not place or store CDs in the following places**
 - Locations exposed to direct sunlight
 - Humid or dusty locations
 - Locations directly exposed to a heat vent or heating appliance
 - In the glove compartment or on the rear deck of an automobile

Portable CD player

Panasonic

Operating Instructions

Dear Customer

Thank you for purchasing this product. For optimum performance and safety, please read these instructions carefully.

SL-CT470



Note:

The "EB" indication shown on the packing case indicates United Kingdom.



Supplied Accessories

Check the packing carton for these accessories.

AC adaptor	1 pc.	Stereo earphones	1 pc.
For United Kingdom (RFEA403B-S)		(RFEV335P-KS)	
For Others (RFEA403A-S)		External battery case	1 pc.
Wired remote control	1 pc.	(RFA1139-H)	
(RFEV033P-SS)			

Use numbers indicated in parentheses when asking for replacement parts.

Before connecting, operating or adjusting this product, please read these instructions completely. Please keep this manual for future reference.



Matsushita Electric Industrial Co., Ltd.

Osaka 542-8588, Japan

(En) RQT5348-B

F0100YH0

CAUTION!

THIS PRODUCT UTILIZES A LASER. USE OF CONTROLS OR ADJUSTMENTS OR PERFORMANCE OF PROCEDURES OTHER THAN THOSE SPECIFIED HEREIN MAY RESULT IN HAZARDOUS RADIATION EXPOSURE. DO NOT OPEN COVERS AND DO NOT REPAIR YOURSELF. REFER SERVICING TO QUALIFIED PERSONNEL.

WARNING:

TO REDUCE THE RISK OF FIRE, ELECTRIC SHOCK OR PRODUCT DAMAGE, DO NOT EXPOSE THIS APPLIANCE TO RAIN, SPLASHING, DRIPPING OR MOISTURE.

Marking sign is located on bottom of the unit.

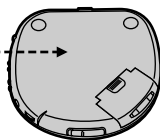

Bottom of the unit

DANGER	INVISIBLE LASER RADIATION WHEN OPEN AND INTERLOCK DEFEATED. AVOID DIRECT EXPOSURE TO BEAM.	(Bottom of product)
ADVARSSEL	USYNLIG LASERSTRÅLING VED ÅBNING, NÅR SIKKERHEDSAFBRYDERE ER UDE AF FUNKTION. UNDGÅ UDSETTELSE FOR STRÅLING.	(Påsat under apparatet)
VARO!	AVATTAESSA JA SUOJALUKITUS OHITETTAESSA OLET ALLTIHINA NÄKYMÄTÖNTÄ LASERSÄTEILYLLE. ÄLÄ KATSO SÄTEESEEN.	(Tuotteen pohjassa)
VARNING	OSYNLIG LASERSTRÅLING NÅR DENNIA DEL ÄR ÖPPNAD OCH SPÄRREN ÄR URKOPPLAD. BETRakta EJ STRÅLEN.	(Apparatens undersida)
ADVARSSEL	USYNLIG LASERSTRÅLING NÅR DEKSEL ÅPNES OG SIKKERHEDSLÅS BRYTES. UNNGÅ EKSPONERING FOR STRÅLEN.	(Produktets underside)
VORSICHT	UNSIHTBARE LASERSTRÄHLUNG, WENN ABDECKUNG GEÖFFNET UND SICHERHEITSPERRUNG ÜBERBRÜCKT. NICHT DEM STRAHL AUSSETZEN.	(Unterseite des Gerätes)

Power Supply Preparations

Refer to the specifications (page 6) for information on operating times when using rechargeable batteries or dry-cell batteries.

Using the AC adaptor

Connect the AC adaptor supplied.

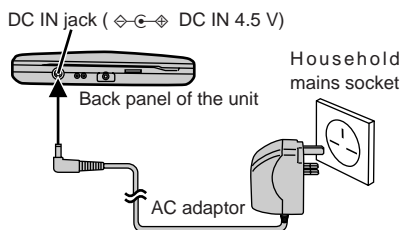

Note

- The configuration of the AC adaptor differs according to the area.
- The unit is in the standby condition when the AC adaptor is connected. The primary circuit is always "live" as long as the AC adaptor is connected to an electrical outlet.

Using rechargeable batteries (not included)

Make sure to recharge the batteries before using them. The unit cannot be used to charge rechargeable batteries other than those specially designed for it.

- Optional batteries
For United Kingdom (HHR-4AHE/2B)
For others (HHR-4AHT/2B)

Recharging procedure

1 Insert the special rechargeable batteries into the unit.

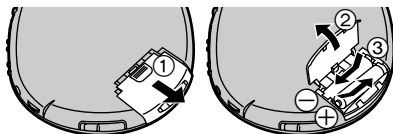

2 Connect the AC adaptor.

Refer to "Using the AC adaptor" for connection instructions. Recharging starts and the "A" charging indicator flashes on and off on the unit's display. When the rechargeable batteries are fully recharged, the charging indicator disappears.

3 When recharging is complete, unplug the AC adaptor from the household mains socket and the DC IN jack.

Note

- Rechargeable batteries have a service life of approximately 300 charge-discharge cycles. If the operating time on one full charge becomes noticeably shorter than it used to be, the battery has reached the end of its service life and should be replaced.
- Recharging may only be performed when the unit is powered off. (It is not possible to recharge the batteries while playing a CD.)
- The AC adaptor and rechargeable batteries may become warm while recharging is in progress. This is not a malfunction.

If the battery lid comes loose

Slide the lid back into place horizontally.

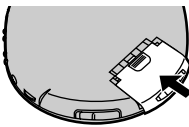

Removing batteries

Push up on the battery in the direction indicated by the arrow. Then lift it out.

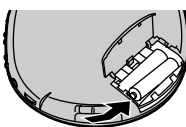

Using dry-cell batteries (not included)

After disconnecting the AC adaptor, insert two LR03 (UM-4) alkaline batteries.

The procedure for inserting and removing dry-cell batteries is identical to that for rechargeable batteries.

When the battery indicator flashes

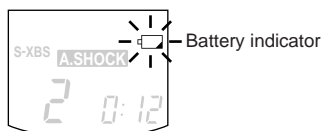

Power is cut off a short while later. Recharge the rechargeable batteries or replace the dry-cell batteries with new ones.

Note

- The length of time the unit will continue to operate between when the battery indicator starts flashing and when the power is cut off differs depending on the type of batteries used.
- The battery indicator may not be displayed if rechargeable batteries other than those designated by Panasonic are used.

Using the car adaptor (not included)

Be sure to obtain the car adaptor (SH-CDC9), available as an optional accessory. The car adaptor can be used to recharge the unit's batteries while in the car.

Using the external battery case

The external battery case allows you to extend the maximum playing time of the unit by loading an additional two LR6 (UM-3) (not included) alkaline batteries.

1 Open the cover of the external battery case and insert the batteries.

Insert the end marked (-) first.

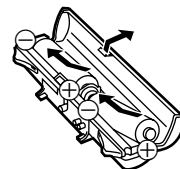

2 Mount the external battery case on the unit.

Insert the protrusions on the external battery case into the three indentations in the unit.

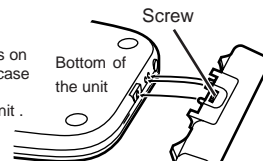

3 Secure in place with the screw.



Reverse the above procedure to remove the external battery case.

For your reference:

- The unit can be powered by the batteries in the external battery case alone. No batteries need to be loaded in the player.
- The maximum playing time will differ depending on the type of batteries (rechargeable/dry-cell) loaded in the unit.

If the cover of the external battery case comes loose:

Insert the protrusions into the holes on either end of the case.

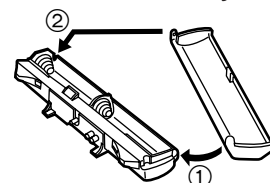

Note

- Though you can use rechargeable batteries in the external battery case, it does not recharge them. (Use dry-cell batteries if possible.)
- If rechargeable batteries and dry-cell batteries are used together, make sure to use fully charged rechargeable batteries and new dry-cell batteries.
- When using four dry-cell batteries, do not mix new and old batteries.

If the unit malfunctions or freezes during use, disconnect the power sources (the AC adaptor or batteries). Re-connect the power source and continue operation.

HOLD Function

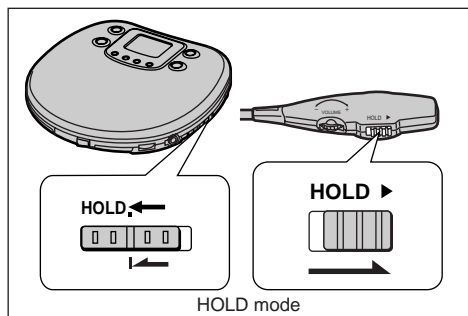

This function causes the unit to ignore short, accidental button presses. (The disc lid can still be opened and closed.)

The HOLD function prevents the following:

- Powering on the unit accidentally (which can cause the batteries to run down).
- Play being cut off unexpectedly in the middle of a selection.

To use the HOLD function

Set [HOLD] to the HOLD position.

The unit and wired remote control have HOLD functions, each of which works independently.

"hold" indication

When the unit is in HOLD mode, pressing any button causes the indication "hold" to appear on the display.

When the unit is powered off

The "hold" indication appears only when [▶||] is pressed.

Before operating the buttons

Be sure to move [HOLD] to release the unit from the HOLD mode.

Sequential Play Basic Play

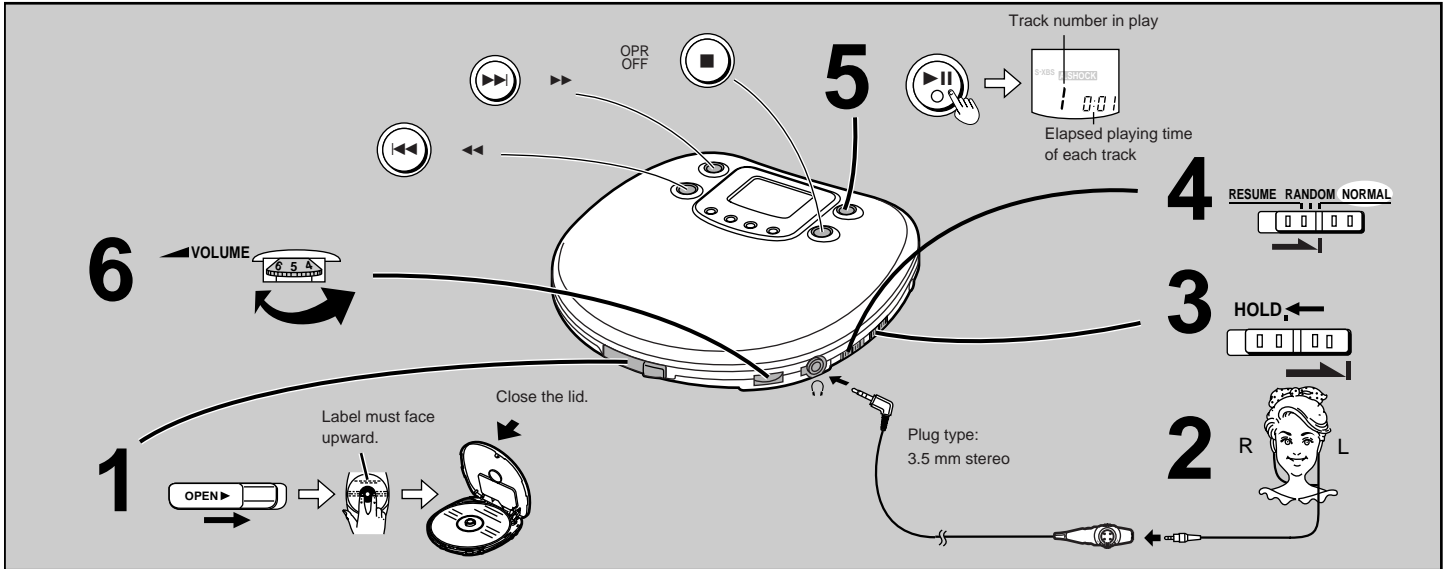

Follow steps 1–6.

In step 2, connect the wired remote control and the stereo earphones to the headphone jack (L). (Plug in firmly.)

• Play stops automatically when all the tracks have been played.

• If the unit has been connected to the car audio system, adjust the volume level between 4 and 6 on the unit, then adjust the volume level on the system.

For your reference:

“no disc” indication

This indication appears for about 30 seconds if [▶||] is pressed when no disc is loaded in the unit or if the disc is not properly secured.

“OPEN” indication

This indication appears for about 10 minutes when the cover is opened. (However, the indication does not appear when the unit is powered off.)

Auto power off function

If the unit is left in stop or paused status for approximately 10 minutes, the unit powers itself off automatically in order to prevent the batteries from running down. (If no disc is loaded in the unit, it powers itself off in about 30 seconds.)

Removing discs

1 Press [■, OPR OFF] to stop play and disc rotation.

2 Slide [OPEN] to open the lid.

3 Press [PUSH] to release the disc.

Do not stop the disc by hand or try to remove it before it stops rotating. This can damage CDs.

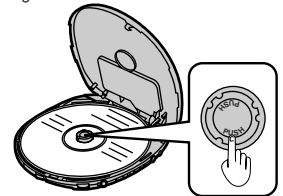

Note

Never insert foreign objects into the unit.

Operation	Button	Display/reference
To pause play	Press during play. 	 Press again to restart play.
To stop play Stop mode	Press during play. OPR OFF 	Total number of tracks Total playing time
To turn off the unit Off mode	Press during stop mode. OPR OFF 	
Skipping tracks	Press during play. Backward Forward	<ul style="list-style-type: none"> • During program play (page 4), these buttons are used to skip forward or back through the programmed sequence of tracks. • During random play (page 4), the skip buttons cannot be used to skip back to tracks that were played previously in the random sequence. • During program play, random play or 1-track repeat play (page 4), search operation is limited to the current track only.
Searching through tracks	 Press and hold during play.	

Location of Controls

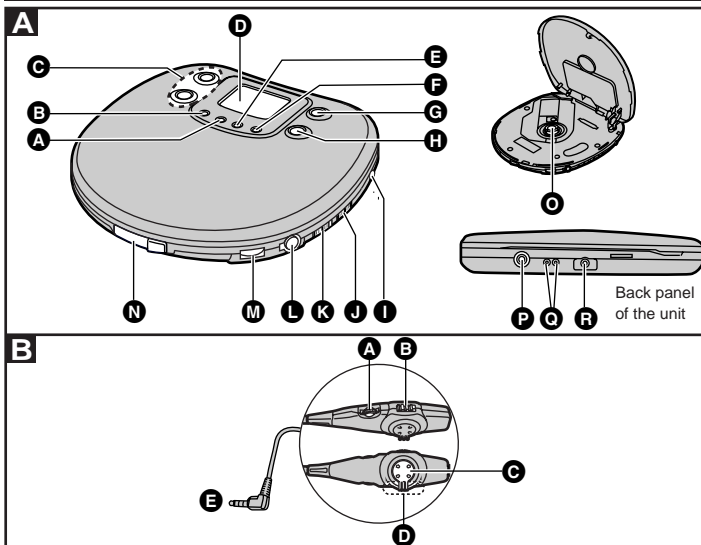

Portable CD player A

- A Memory/recall button (MEMORY/RECALL)
- B EQ button (EQ)
- C Skip/search buttons (|◀, ▶|, ◀◀, ▶▶)
- D Display
- E Repeat button (↺)
- F Anti-shock button (A. SHOCK)
- G Play/pause button (▶||)
- H Stop/operation off button (■, OPR OFF)
- I Out jack (OUT)
- J Hold switch (HOLD)
- K Play mode selector (RESUME, RANDOM, NORMAL)
- L Headphone jack (L)
- M Headphone volume control (VOLUME)

- N Open switch (OPEN)
- O CD release button (PUSH)
- P DC IN jack (⚡ DC IN 4.5 V)
- Q Connection terminal for external battery case
- R Hole for car insulator mounting screw/external battery case

Wired remote control B

- A Volume control (VOLUME)
- B HOLD switch (HOLD)
- C Play/stop/off button (PUSH)
- D Skip/search selector (+, -)
- E Plug

Other Play Methods

The letters such as **A** in the various illustrations refer to the descriptions in the "Location of Controls" section. (See page 3.)

Skip play

The disc plays from the selected track through to the last track, then play stops automatically.

Preparation: Put unit in stop mode. (See page 3.)

1

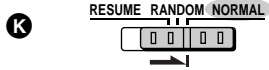

2 Select the desired track.



3



Program play

Up to 24 tracks can be entered in the program.

Preparation: Put unit in stop mode. (See page 3.)

1



2 Select the desired track.



3 Register in sequence.

(The indication "M" and the programmed sequence appear on the display.)

MEMORY/RECALL



4 Repeat steps 2 and 3 to program all the desired tracks.

5



■ **To program the same track in the sequence more than once**

After step 3, press [MEMORY/RECALL] the desired number of times.

■ **If "f" is displayed**

No more tracks may be programmed.

■ **To confirm the contents of the program**

Press [MEMORY/RECALL] while the disc is playing. (The numbers of the programmed tracks appear on the display in sequence.)

■ **To delete the entire program**

Press [MEM. OPR OFF].

Random play

1



2



Release

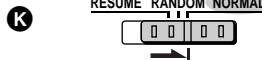

For your reference:

- It is also possible to press [▶▶] while the unit is in stop mode to change the first track to be played. (All tracks are played eventually, regardless of which is played first.)
- Program play is not possible in the random mode.

Resume play

This function allows you to listen from the beginning of the track where play stopped because the unit was powered off (or switched to stop mode). It is useful when listening to CDs in the car, etc.



Release

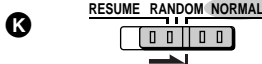

For your reference:

- If [RESUME, RANDOM, NORMAL] is put in the [RESUME] position, the all-track repeat function will be activated automatically as soon as the unit is powered on.
- If power is cut off near the end of a track (off mode), playback may resume from the beginning of the next track.
- If the unit is powered off while a disc was playing and then a new disc is inserted, play will begin from the middle of the new disc because the unit remembers the position where play stopped on the previous disc.

Repeat function

Press during play or stop mode.

E



The setting is switched in the sequence indicated below each time [E] is pressed.

1-track repeat (1)

One track is repeated.

All-track repeat (ALL)

All the tracks on the disc are repeated.

Cancel (no indicator is shown)

For your reference:

If "ALL" is selected during program play, only the tracks in the program are repeated. (The indication "ALL" is not displayed.)

Changing the sound quality

Press during play or stop mode.

B



The setting switches in the sequence indicated below each time [EQ] is pressed.

S-XBS → TRAIN → LIVE → Cancel (no indicator is shown)

S-XBS:

Select this setting to boost the low-range response.

TRAIN:

Select this setting to avoid annoying other passengers with noise from your earphones while riding on the train, or to reduce fatigue when listening for a long period of time.

LIVE:

Select this setting for a live concert effect.

Anti-Shock Function

The anti-shock function works by reading audio data and storing it in memory (up to 40 seconds worth). The unit then fills in interruptions caused by bumps and vibrations with data from the memory. This unit also incorporates a powerful anti-shock mechanism that prevents skipping caused when play speed is changed by swinging of the unit.

Press during play or stop mode.

A.SHOCK

F



The following indicator appears on the display.

D

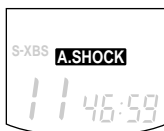

Note

If you have pressed [A.SHOCK] when the unit is in stop mode, press [▶||] to start play.

When bumps continue repeatedly

The message "SORRY" appears on the display and sound is interrupted.

D

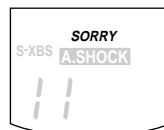

To cancel the anti-shock function

Press [A.SHOCK] again.

Note

The anti-shock setting can be changed during play, but this may cause a slight interruption in the sound because the disc's rotational speed changes.

During the anti-shock operation, the disc rotates at a higher rate than usual in collecting extra audio data.

This could result in a slight increase in disc rotation noise.

Listening to sound with the unit connected to an audio system

The anti-shock function uses digital signal compression technology. It is recommended that the anti-shock function be cancelled if the unit is connected to a home audio system.

Using the Wired Remote Control

The remote control can be operated regardless of the hold mode of the unit.

Preparation:

Release the remote control from the hold mode.

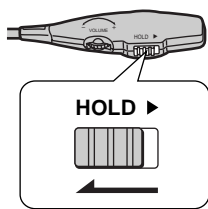

Operation confirmation tones

When an operation button is pressed, a confirmation tone sounds. Refer to the parentheses in the illustration for the different types of confirmation tones.

How to use the wired remote control

To start play	Press once during off or stop mode. (Beep)	Skipping tracks	Turn during play.
To stop play	Press once during play. (Beep...Beep)		Searching through tracks
To turn off the unit	Press and hold during play or stop mode. (Beep...Bee...p)	To adjust the volume	When adjusting the volume using the remote control, position the volume control on the unit between 4 and 6.

Using the Unit with Optional Accessories

Using the unit with an audio system

Use stereo connection cable (not included) to listen to CDs through your home audio system.

- Turn off the amplifier power and connect the cable.
- Do not connect the cable to the PHONO jacks on the amplifier.
- Obtain the optional connecting cable if the amplifier comes with mini-phone jacks.
- Adjust the volume on the amplifier.

Note

- Sound quality changes when S-XBS, TRAIN or LIVE is selected, but volume is reduced by about half.
- You can connect speakers, active or otherwise, with an impedance of 1 kΩ or less to the headphone jacks. Set the unit's volume between 4 and 6.

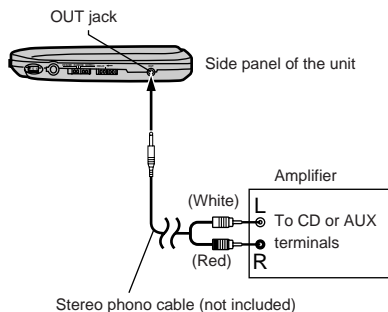

Using the unit with a car audio system

Items to be purchased

For connection to the car audio system:
Car stereo cassette adaptor (SH-CDM10A)

Connect the car stereo cassette adaptor to the unit's headphone jack. (When doing this, keep the unit's VOLUME at a setting between 4 and 6.)

For securing the unit and connecting the power supply:

- Car adaptor (SH-CDC9)
- Car mounting kit (SH-CDF7)
- Car mounting arms, Car insulator

Note

It may not be possible to use the unit with some types of car stereo owing to restrictions imposed by the construction of the car stereo cassette adaptor.

For further details, refer to the instructions of the part concerned.

Maintenance

If the surfaces are dirty

To clean this unit, wipe with a soft, dry cloth.

If the surfaces are extremely dirty, use a soft cloth dipped in a soap-and-water solution or a weak detergent solution.

- Never use alcohol, paint thinner or benzine to clean this unit.
- Before using chemically treated cloth, read the instructions that came with the cloth carefully.

Maintaining the lens

Open the lid and clean the lens as shown in the figure. Use a cotton swab to gently wipe off any finger-prints.

Recommended product: Lens cleaner kit (SZPP1038C)

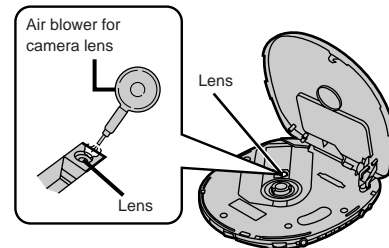

Troubleshooting Guide

Before requesting service for this unit, check the chart below for a possible cause of the problem you are experiencing. Some simple checks or a minor adjustment on your part may eliminate the problem and restore proper operation.

If you are in doubt about some of the check points, or if the remedies indicated in the chart do not solve the problem, refer to the directory of Authorized Service Centers (enclosed with this unit) to locate a convenient service center, or consult your dealer for instructions.

Problem	Check this
Cannot close the cover.	Is the disc properly secured in place?
Cannot play discs.	<ul style="list-style-type: none"> Is the unit in HOLD mode? Is the disc properly secured in place? Is there moisture on the lens? (Wait for about an hour and then try again.)
Cannot remove disc.	Did you press [PUSH] to release the disc?
Tracks on disc do not play in order, starting with the first track.	Is [RESUME, RANDOM, NORMAL] in the [NORMAL] position?
Cannot hear music—too noisy.	<ul style="list-style-type: none"> Have the earphone and wired remote control plugs been inserted firmly? Are the plugs dirty? (Wipe away dirt on plug.) Separate the unit from mobile phones.
TV picture is distorted. Radio reception is noisy.	Are you using the unit too near a TV or tuner? (If the TV or tuner is connected to a simple indoor antenna, connect it to an outdoor antenna.)

Specifications

Audio (Anti-shock off)

No. of channels:	2 (left and right, stereo)
Frequency response:	20 to 20,000 Hz (+0.5 dB to -1.5 dB)
Output voltage:	0.6 V (50 kΩ)
S/N:	More than 96 dB [≠]
Wow and flutter:	Below measurable limit
DA converter:	1 bit, MASH
Headphones output level:	Max. 9 mW+9 mW/ 16 Ω (adjustable)

Pickup

Light source:	Semiconductor laser
Wavelength:	780 nm

General

Operational temperature range:	0 °C—40 °C
Rechargeable temperature range:	5 °C—40 °C
Power supply:	DC 4.5 V
Power consumption:	

Power source	Anti-shock off/on
AC adaptor	3.0 W/3.0 W

When recharging: About 5.6 W

Playing time:

[When used in hold mode with EQ cancelled, at 25 °C, on a flat, stable surface]

Batteries used	Anti-shock off/on
2 Alkaline batteries (LR6)	About 24 hours/ About 30 hours
2 Alkaline batteries (LR03)	About 10 hours / About 13 hours
2 Rechargeable batteries	About 6 hours/ About 8 hours
4 Alkaline batteries	About 38 hours/ About 50 hours
2 Rechargeable and 2 alkaline batteries	About 30 hours/ About 38 hours

The play time may be less depending on the operating conditions.

Recharging time: About 3 hours

Dimensions

(W×H×D):	128×20.7×131 mm
Mass:	188 g (with batteries) 166 g (without batteries)

*These specifications were measured in the anti-shock off mode.

Note:

Specifications are subject to change without notice.

Mass and dimensions are approximate.

Cautions

Selection and care of rechargeable / dry cell batteries

■ Selection

As a safety precaution, the portable CD players made by Panasonic are constructed so it is impossible to recharge ordinary batteries.

Only batteries especially designed for this unit can be recharged.

Special nickel-metal hydride rechargeable batteries:

For United Kingdom:

HHR-4AHE/2B (set of 2)

For others:

HHR-4AHT/2B (set of 2)

For details, check with your dealer.

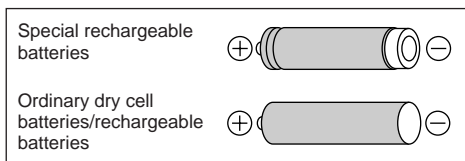

● If rechargeable battery play time is short after recharging, the batteries have reached the end of their service life. Replace them with the recommended replacements.

● Play time may be shorter than usual after recharging batteries for the first time or after they have been unused for a long time. Repeatedly recharge and discharge the batteries if this occurs to restore them to normal.

■ Care

To prevent battery damage, electrolyte leakage and short-circuiting, heed the following points.

● Do not peel off the covering on batteries and do not use if the covering has been peeled off.

- Align the poles ⊕ and ⊖ correctly when inserting the batteries.
- Do not mix different types or makes of batteries or old and new batteries.
- Remove the batteries if you do not intend to use the unit for a long time.
- Do not throw into fire, short-circuit, disassemble, or subject to excessive heat.
- Do not attempt to recharge dry cell batteries.
- Do not allow metal objects to touch the battery terminals as this may cause short-circuiting which is dangerous.
- When carrying batteries in a pocket or bag, ensure no metal objects such as necklaces are placed together with them. Contact with metal may cause short-circuiting which can cause a fire. For safety, carry the batteries in the battery carrying case.

When driving a car

In the interest of traffic safety, do not operate the unit while driving.

AC adaptor

- Handle the AC adaptor carefully. Improper handling is dangerous.
 - Do not touch it with wet hands.
 - Do not place heavy objects on top of it.
 - Do not forcibly bend it.
- Be sure to connect only the AC adaptor provided with the unit.
- Disconnect the AC adaptor from the power outlet if the unit is not going to be used for a long time.

Unit

No altering or remodeling

This can cause malfunctioning.

No dropping or strong impacts

This may damage the unit.

Locations to be avoided

Avoid using the unit in the following locations since they can cause malfunctioning.

1. Bathrooms and other moisture-prone places
2. Warehouses and other dusty places
3. Very hot places near heating appliances, etc.

Do not leave the unit exposed to direct sunlight for long periods of time

This may deform or discolor the cabinet and may also cause malfunctioning.

Precautions for Listening with the Headphones or Earphones

- Do not play your headphones or earphones at a high volume. Hearing experts advise against continuous extended play.
- If you experience a ringing in your ears, reduce volume or discontinue use.
- Do not use while operating a motorized vehicle. It may create a traffic hazard and is illegal in many areas.
- You should use extreme caution or temporarily discontinue use in potentially hazardous situations.
- Even if your headphones or earphones are the open-air type designed to let you hear outside sounds, don't turn up the volume so high that you can't hear what's around you.