

Panasonic

Quad Speed
PCMCIA CD-ROM Player

Model No. **KXL-D740**

Operating Instructions



Actual product may differ from photo.

Please read before using and store in a safe place.

Thank you for purchasing the Panasonic Quad Speed PCMCIA CD-ROM Player KXL-D740.

End-User License Agreement

THIS IS A LEGAL AGREEMENT BETWEEN YOU AND PANASONIC. CAREFULLY READ ALL THE TERMS AND CONDITIONS OF THIS AGREEMENT PRIOR TO OPENING THE PACKET OF SOFTWARE PROGRAM. OPENING THE PACKET INDICATES YOUR ACCEPTANCE OF THESE TERMS AND CONDITIONS. If you do not agree to these terms and conditions, return the unopened packet and the other components of the Panasonic product to the place of purchase and your money will be refunded. No refunds will be given for the product that have an opened packet or missing components.

1. COPYRIGHT:

Panasonic has the right to license or has been granted to license the enclosed software program ("SOFTWARE"), developed and copyrighted by Kyushu Matsushita Electric Co., Ltd. or its licensor ("Licensor"). You acknowledge that you are receiving only a LIMITED LICENSE TO USE the SOFTWARE and related documentation, and that you shall obtain no title, ownership nor any other rights in or to the SOFTWARE and related documentation, all of which title and rights shall remain with Licensor and Panasonic.

2. LICENSE:

(1) You have the non-exclusive right to use the one copy of the SOFTWARE on a single computer used by single user. Installation of the SOFTWARE on a network server for the purpose of distribution to one or more other computers shall not be granted in this Agreement. (2) You may not copy, reproduce, or permit to be copied or reproduced, the SOFTWARE or related documentation for any purpose, except that you may either (a) make a reasonable quantity of copies of the SOFTWARE solely for backup or archival purposes, or (b) transfer the SOFTWARE to a single hard disk, provided that you keep the original solely for backup or archival purposes. All other copies of the SOFTWARE are in violation of this Agreement. (3) You may not rent or lease the SOFTWARE, but you may transfer your right under this License Agreement on a permanent basis, provided that you transfer this Agreement, all copies of the SOFTWARE, all related documentation and your Panasonic product, and the recipient thereof agrees the terms of this Agreement. (4) You may not reverse engineer, decompile or disassemble the SOFTWARE, except that in European Union and European Free Trade Association, you may have the limited right to reverse engineer, decompile or disassemble the SOFTWARE solely to the extent specifically permitted by the terms and conditions of Article 6 of the European Community's Directive for the Legal Protection of Computer Programs, OJL 122/42 (17 May 1991). (5) You may not use, copy, modify, alter, or transfer the SOFTWARE, or any copy thereof, in whole or in part, except as expressly provided in this Agreement.

3. TERM:

This license is effective until terminated. You may terminate this Agreement at any time by destroying the SOFTWARE and related documentation and all copies thereof. This license will also terminate if you fail to comply with any term or condition of this Agreement. Upon such termination, you agree to destroy all copies of the SOFTWARE and related documentation.

4. LIMITED WARRANTY:

Within ninety (90) days of your receipt of the SOFTWARE, Panasonic warrants that the storage media on which the SOFTWARE are furnished is free from defect in materials and workmanship under normal use, and that it will repair or at its option replace any defective media at no charge to you, provided that such defective media is returned to Panasonic within such ninety (90) days period.

5. LIMITATION OF LIABILITY:

EXCEPT AS STATED ABOVE, NEITHER PANASONIC NOR PANASONIC'S SUPPLIER MAKES OR PASSES ON TO YOU OR OTHER THIRD PARTY, ANY WARRANTY OR REPRESENTATION INCLUDING, BUT NOT LIMITED TO, THE IMPLIED WARRANTY OF MERCHANTABILITY AND FITNESS FOR A PARTICULAR PURPOSE.

WITHOUT LIMITING THE GENERALITY OF THE FOREGOING, NEITHER PANASONIC NOR PANASONIC'S SUPPLIER WARRANTS THAT THE SOFTWARE WILL BE ERROR-FREE OR THAT IT WILL MEET YOUR REQUIREMENTS.

NEITHER PANASONIC NOR PANASONIC'S SUPPLIER SHALL BE LIABLE FOR ANY DAMAGE SUFFERED BY YOU INCLUDING, BUT NOT LIMITED TO, CONSEQUENTIAL, INCIDENTAL SPECIAL OR PUNITIVE DAMAGES.

THE ABOVE LIMITATIONS SHALL APPLY REGARDLESS OF THE FORM OF ACTION WHETHER IN CONTRACT, TORT (INCLUDING NEGLIGENCE), STRICT PRODUCT LIABILITY OR OTHERWISE, EVEN IF SUCH PARTY HAS BEEN ADVISED OF THE POSSIBILITY OF SUCH DAMAGES.

WARNING

- The power source voltage of this AC adaptor is listed on the nameplate. Plug the AC adaptor only into an outlet with the proper voltage.
- To prevent fire or shock hazard, do not expose this product to rain or any type of moisture.

CAUTION

- When you operate this equipment, the outlet should be near the equipment and should be easily accessible.
- To prevent the SCSI interface connector from static electricity damage, before you touch it, discharge any static electricity from your hands by touching a grounded metal surface, such as the screw on the plate cover of an electrical outlet.

Any details given in these Operating Instructions are subject to change without notice.

CAUTION FOR LASER

This product utilizes a laser.

Use of control, adjustment or performance of procedures other than those specified herein may result in hazardous radiation exposure.

Do not open covers and do not repair yourself. Refer servicing to qualified personnel.

Laser diode properties

Material	GaAlAs
Laser output	Less than 52.65 μ W
Wave length	790 nm
Emission duration	Continuous

(This output is the value measured at the distance of 200 mm from the objective lens surface.)

FOR USERS IN UNITED STATES ONLY

This equipment has been tested and found to comply with the limits for a Class B digital device, pursuant to Part 15 of FCC Rules. These limits are designed to provide reasonable protection against harmful interference in a residential installation.

This equipment generates, uses and can radiate radio frequency energy and, if not installed and used in accordance with the instructions, may cause harmful interference to radio communications.

However, there is no guarantee that interference will not occur in a particular installation. If this equipment does cause harmful interference to radio or television reception, which can be determined by turning the equipment off and on, the user is encouraged to try to correct the interference by one or more of the following measures:

- Reorient or relocate the receiving antenna.
- Increase the separation between the equipment and receiver.
- Connect the equipment into an outlet on a circuit different from that to which the receiver is connected.
- Consult the dealer or an experienced radio/TV technician for help.

The user may find the booklet "Something About Interference" available from FCC local regional offices helpful.

FCC Warning: To assure continued FCC emission limit compliance, the user must use only the recommended shield interfacing cable when connecting to a host computer. Also, any unauthorized changes or modifications to this equipment would void the users authority to operate this device.

FOR USERS IN CONTINENTAL UNITED STATES ONLY

Technical Support and Service Parts Calls

If you have read this manual and tried the troubleshooting procedures, and you are still having difficulty, please contact the store from which the unit was purchased. Panasonic Communications & Systems Company will repair this product with new or refurbished parts free of charge for two (2) years from the date of purchase.

You may also call the technical support telephone number (24 hours/7 days).

**The technical support number is: 1-800-PANA-SYS
(1-800-726-2797)**

The service parts number is: 1-800-332-5348

The serial number of this unit may be found on the label located at the bottom of the unit. Write this number below and keep this book along with your proof of purchase to serve as a permanent record of your purchase or for future reference.

MODEL NO. KXL-D740 NAME OF DEALER _____

SERIAL NO. _____ DATE OF PURCHASE _____

IBM and PC DOS are trademarks of International Business Machines Corporation. Microsoft®, Windows® and MS-DOS® are registered trademarks of Microsoft Corporation in the United States and/or other countries. Photo CD is a trademark of Eastman Kodak Company. Sound Blaster is a trademark of Creative Technology Ltd.

All other brands and product names are trademarks or registered trademarks of their respective companies.

Microsoft MS-DOS® CD-ROM Extensions Copyright © Microsoft Corporation. 1986-1993, All rights reserved.

All Rights Reserved, © COPYRIGHT 1995 KYUSHU MATSUSHITA ELECTRIC CO., LTD.

■ Features:

- **Quad Speed external drive (Max. 600 KB/s).**
- **Operates on AC Adaptor, Six (6) "AA" size Batteries (not supplied) or Rechargeable Battery (Option).** (☞ P. 13-16)
- **Can be connected to a notebook/desktop computer which has PCMCIA card slot with supplied PC card and PCMCIA cable.** (☞ P. 17, 18)
- **Can be connected to a desktop computer with purchase of SCSI board and SCSI cable.** (☞ P. 18)
- **Both CD-ROM and audio CD can be played when attached to your computer.** (☞ P. 24)
- **Can be used independently as an audio CD player.** (☞ P. 25)
- **Compatible with MPC level 1, MPC level 2*.**
 - * The capability differs depending on the personal computer or software.
- **Supports CD-DA, CD-ROM XA, CD-ROM, Photo CD Multisession, VIDEO CD*, CD-I*.**
 - * When using VIDEO CD or CD-I, commercial MPEG Boards are required on the computer side.

Use the player with computer (☞ P. 24)

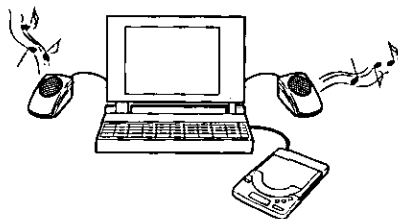

Sound system devices such as the optional KXL-D20 may be required.

Use the player independently (☞ P. 25)

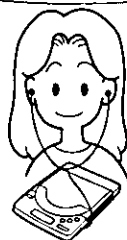

Headphones are not supplied.

Important:

- Please use CD-ROMs with the marking below.

COMPACT
disc

- Please use audio CDs with the marking below.

COMPACT
disc
DIGITAL AUDIO

Table of Contents

End-User License Agreement	4
Technical Support and Service Parts Calls	7

Precautions	10
Accessories	10
Part Names	11
Power Supply	13
Using supplied AC adaptor	13
Using rechargeable battery (option)	13
Using alkaline batteries (not supplied)	16

Before using



Connecting Player to Computer	17
To a notebook computer	17
To a desktop computer	18
Power On	19
Software Installation	20
Before installing software	20
Installing under DOS	21
Installing under Windows 95	22

Setup



Inserting/Removing a CD	23
Using the Player with Computer	24
Playing a CD-ROM	24
Playing an audio CD	24
Using the Player Independently	25
Playing an audio CD	25

Operation



Error Messages on Computer	26
README File	27
Troubleshooting	29
Details of Setup Disk Software	31
SCSI ID Number and Terminator	34
Maintenance	35
Specifications	36
Index	38
Options	back cover

General Information



Precautions

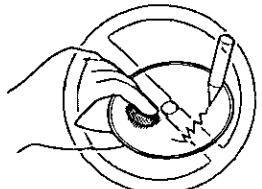

- Do not scratch or smudge the surface of CD.

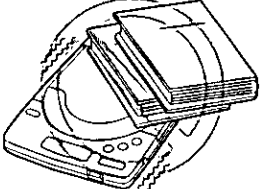

- Do not place heavy objects on the player.
- Do not shake or subject to intense vibration.

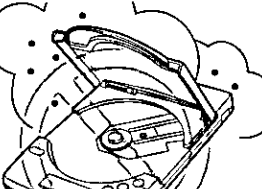

- Keep disc cover closed to protect from dust.

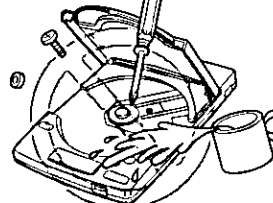

- Do not disassemble the player.
- Do not spill liquid.

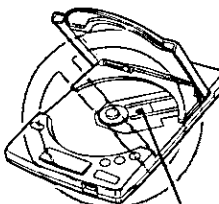

lens

- Do not touch the lens.

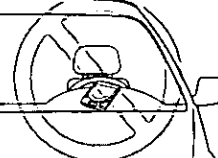

- Do not expose the player to direct sunlight or heat. Especially do not leave it in a hot automobile.

- Do not play CD-ROM/audio CD while transporting.
- Do not use near any appliance that may cause vibration.

Accessories

Make sure that the following accessories are included with the player.

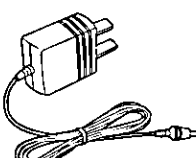
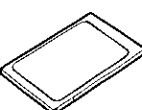
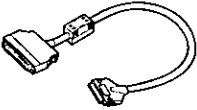
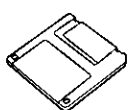
			
AC adaptor (KX-WZ315) (P. 13)	PC card (Interface card) (P. 17)	PCMCIA cable (P. 17) [The shape may differ from the product.]	Setup disk (P. 20)
• Operating instructions		• Warranty card	

Part Names

Top view

Disc cover (P. 23)

Lock switch (P. 23)

Locks the disc cover by sliding the Lock switch toward the rear of the player.

OPEN button (P. 23)

Opens the disc cover.

Display (P. 12)

VOLUME control

(P. 25)

Adjusts the volume of headphones (0~10).

POWER switch (P. 19)

Turns the power on/off.

(STOP button) (P. 25)

Stops playing audio CD.

(Forward skip button)

(P. 25)

Skips to the next track(s).

PHONES jack (P. 25)

Connects your headphones (not supplied).

(Reverse skip button)

(P. 25)

Skips to the previous track(s) or returns to the beginning of the track being played.

▶|| /CHG (PLAY/PAUSE button)

Starts/pauses playing audio CD (P. 25) or charges the optional rechargeable battery by pressing this button (P. 14).

Rear/Bottom view

Battery cover

(P. 13, 16)

DC IN jack

(P. 13)

DIP switch (P. 34)

Sets the SCSI ID number.
Sets the terminator ON or OFF.

SCSI interface connector

(P. 17)



Part Names

Display messages

Message/Indication	Description
	With a CD-ROM inserted in the player, if you press , , or , a blinking message "AUDIO DISC ONLY" appears.
	When data is being transferred, a blinking message "BUSY" appears.
	CD is not inserted, or the inserted CD is not recognized because either the CD is placed with the label side facing down, or it is damaged, dirty, wet, etc.
	When CD-ROM is inserted, a message "on" is displayed. While CD-ROM or audio CD is recognizing, a blinking message "on" appears.
	Audio CD is recognized.
	The disc cover is open.
	When the battery is low, this blinking indication appears.
	This blinking indication appears while the rechargeable battery (option) is being charged.

Power Supply

The supplied AC adaptor, rechargeable battery (option) or Alkaline batteries (not supplied) can be used for power source of the player.

Using supplied AC adaptor

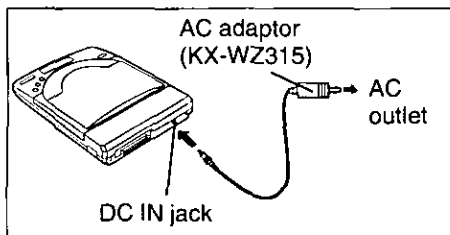

Connect one end of the AC adaptor to DC IN jack and the other end to household AC outlet.

Caution:

- Use only the supplied AC adaptor (KX-WZ315), since other adaptors may damage the player.

Using rechargeable battery (option)

Optional rechargeable battery (KXL-D30) needs to be purchased. Before initial use, please charge the rechargeable battery (P. 14).

Note:

- When using the rechargeable battery, the data transfer rate may decrease and the access time may increase.

Installing rechargeable battery

Make sure the player is off.

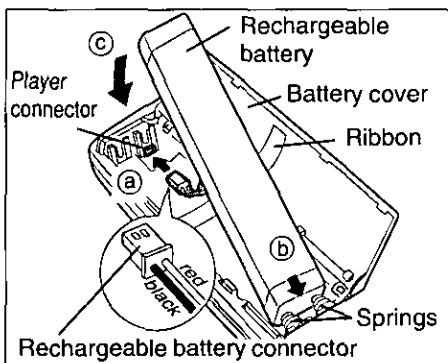

- 1 Open the battery cover by sliding and lifting it up.
- 2 Insert the rechargeable battery connector into the player connector (a).
- 3 Install the rechargeable battery (c) placing the ribbon underneath it and pressing the springs (b).
- 4 Close the battery cover by pressing it down and sliding it back.

Note:

- If the player is not going to be used for more than two (2) months, remove the rechargeable battery to maintain the battery life.









Charging rechargeable battery

Charge the rechargeable battery:

- Before initial use.
- When the blinking mark "  " appears on the player's display.

Caution:

- Do not charge the rechargeable battery using a charger other than this player.

- 1 Install the rechargeable battery** ( P. 13 "Installing rechargeable battery").
- 2 Connect the supplied AC adaptor** ( P. 13).
- 3 Turn on the player by pressing the POWER switch** ( P. 19).
- 4 Press**  **on the player until the mark "CHG  " appears.**
Charging starts and it will complete automatically when the mark "CHG  " disappears and the power goes off. A full battery charge requires a maximum of three (3) hours.
 - To stop charging, turn off the power.

Notes:

- While charging no operation can be performed.
- If you charge the rechargeable battery under extremely low or high temperature, the charging capacity may reduce. Please charge the rechargeable battery within an appropriate temperature range of 5°C to 35°C.
- If the blinking mark "  " appears while using the rechargeable battery with the computer attached, connect the AC adaptor. Otherwise the computer may not function properly.





■ Supplemental charging function:

Charging starts automatically when the rechargeable battery is installed, the AC adaptor is connected and the power is on. While being charged no mark appears on the player's display.

In this case, a full charge may not be done. To charge the rechargeable battery fully, follow the steps 1 to 4 above.

Refreshing rechargeable battery

If the rechargeable battery seems to run down sooner than usual (maybe because of repetitive short-term charging and discharging), refresh the rechargeable battery two to three times by following the instructions below.

1. Disconnect the AC adaptor.
2. Play an audio CD repeatedly until the blinking mark "  " appears and the power goes off.
 - When all music finish playing, power will go off. Turn the power on and play an audio CD again.
3. Connect the AC adaptor, turn on the player and press  on the player until the mark "CHG  " disappears.
4. Charge the rechargeable battery until the mark "CHG  " appears and the power goes off.



Charging, Refreshing, Replacing rechargeable battery

Replacing rechargeable battery (option)

Replace the rechargeable battery:

- If the rechargeable battery quickly runs down even after refreshing (it has reached the end of its life).

Note:

- The rechargeable battery will charge approximately 300 times under optimum condition.

■ Removing the rechargeable battery:

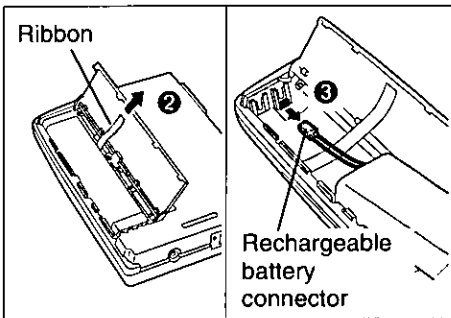

- ① Open the battery cover.
- ② Pull the ribbon upward.
- ③ Disconnect the rechargeable battery connector by pulling its cable carefully, then remove the rechargeable battery.
- ④ Close the battery cover.

Using alkaline batteries (not supplied)

Six (6) "AA" size alkaline batteries are required.

Alkaline battery Precautions:

If improperly used, the batteries may leak and cause corrosion. Therefore, observe the following:

- Install batteries according to the diagram.
- Do not mix old and new batteries, or carbon and alkaline battery types.
- Remove all batteries when not using the player for extended periods.
- **Do not charge, short-circuit, disassemble, heat, or dispose of in fire.**

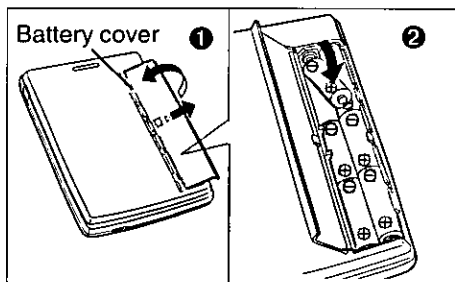

1 Open the battery cover by sliding and lifting it up.

2 Install six "AA" size batteries (not supplied).

Make sure the polarities (+, -) match the diagram.

3 Close the battery cover.

■ Replacing the Batteries:

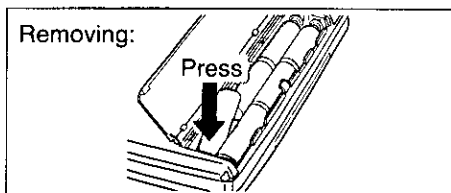

Replace the batteries when blinking mark "  " appears on the display.

Notes:

- When using the alkaline battery, the data transfer rate may decrease and the access time may increase.
- If the blinking mark "  " appears while using the alkaline battery with the computer attached, connect the AC adaptor. Otherwise the computer may not function properly.
- If batteries are installed with the ribbon placed underneath, it is easier to remove the batteries by pulling the ribbon upward.

Connecting Player to Computer

To a notebook computer

You can connect the player to a notebook computer with a PCMCIA Type II card slot by using the supplied PC card and PCMCIA cable.

Notes:

- Use only the supplied PC card and cable with this player.
- You can hear the computer sound if your computer has built-in sound system device, otherwise a sound system device such as the optional KXL-D20 is required.

Make sure both the notebook computer and the player are off.

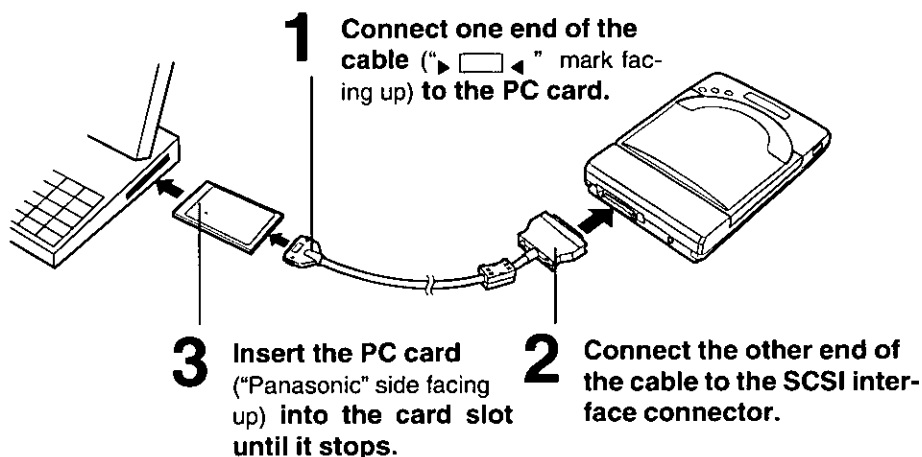

Note:

- On some computers you might have to insert the PC card with the "Panasonic" side facing down. The card is keyed so it can only be installed in the correct direction.

■ Disconnecting PC card from PCMCIA cable:

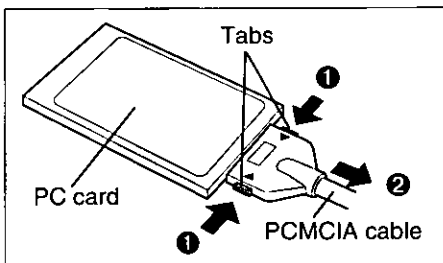

Pull the PCMCIA cable while pressing the side tabs of the PCMCIA cable.

Caution:

- Do not force the PCMCIA cable, since this can damage the PC card or cable.



Connecting Player to Computer

To a desktop computer

SCSI board and SCSI cable *1 are required.

For further information, refer to your SCSI interface manual.

Panasonic recommends either an Adaptec AHA-1542C or Future Domain TMC-1670, etc. The SCSI board must be "ASPI" compatible.

If your desktop computer has a PCMCIA card slot, you can connect the player to the computer by using the supplied PC card and PCMCIA cable. Refer to "To a notebook computer" (P. 17).

Cautions:

- *1 • Use a shielded SCSI cable of 1.5 m (4.9 ft.) or shorter.
- Plug half-pitch or full pitch end of SCSI cable into computer and the half-pitch end into the player.

■ Daisy chain connection:

You can connect this player to other SCSI devices (up to seven devices). Make sure that each SCSI device has different SCSI ID number.

For setting the SCSI ID number and terminator of this player, refer to "SCSI ID Number and Terminator" (P. 34).

<Example>

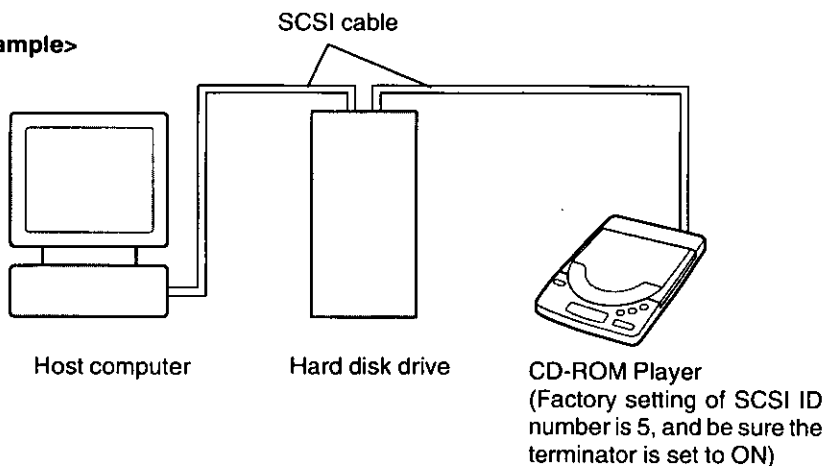

Note:

- You can hear the computer sound by installing the Sound board.

Power On

Turn on the player by pressing the **POWER** switch, and then turn on the computer.

A blinking message "on" appears on the display of the player.

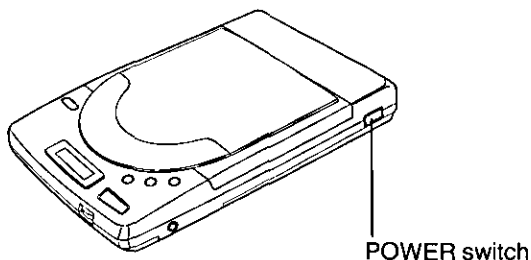

- To turn off the player, press the **POWER** switch again. The display message(s) will disappear.

Note:

- If the player is not going to be used for an extended period, unplug the AC adaptor from both the player and AC outlet to save power consumption. (Approximately 1.0 W power is consumed when the player is OFF and the AC adaptor is connected.)

■ **Power Save Function (except when charging the optional rechargeable battery):**

The player enters the Sleep Mode under the following conditions to save power.

- When using with computer, and no command is sent to the player from the computer for more than 4 minutes.
- When using the player independently, and no button of the player is pressed for more than 4 minutes.

During the Sleep Mode, the laser and spindle motor stop.

The player automatically re-starts when it receives a command from the computer or a button on the player is pressed.



Software Installation

Before installing software

You need to install the software so that your computer can access the player.

Before installing the software, make sure either of the following is installed.

- **Card Manager** (Card Services/Socket Services) [supplied with your computer]
 - When using a computer with PCMCIA card slot.For more information about Card Manager, refer to your computer manual. Even if a Card Manager is not installed and your computer has PCMCIA Controller i82365 100% compatible LSI, a program (ASPIF365.SYS) that will operate your CD-ROM will be automatically installed.
- **ASPI Manager** [mostly supplied with SCSI board]
 - When using a desktop computer with SCSI board.

Notes:

- You may find it convenient to install the software directly onto your C drive (hard disk).
- Installation can be done under DOS or Windows 95. If you are currently in Windows 3.1, 3.11, please **EXIT** Windows 3.1, 3.11 before installing software.

System requirement

The Setup disk can be used only in an IBM or IBM compatible computer with a 3.5" floppy disk drive.

System requirements:

For Notebook Computer

- IBM or IBM Compatible Computer
- PCMCIA Type II Card Slot
[PCMCIA Controller i82365 100% compatible LSI or IBM Card Service (PCMCIA 1.07, 2.00) or SystemSoft (PCMCIA 2.01, 2.10) or Phoenix PCPLUS (PCMCIA 2.00, 2.01, 2.10) or CardTalk]
- PC DOS 5.0 to 7.0, MS-DOS 5.0 to 6.2 or Windows 95



For Desktop Computer

- IBM and IBM Compatible Computer with SCSI Board including ASPI Manager (Adaptec AHA-1542C, Future Domain TMC-1670, etc.)
- PC DOS 5.0 to 7.0, MS-DOS 3.3 to 6.2 or Windows 95

Making back-up copy

Before installing software, it is recommended that you make a back-up copy by referring to your computer's manual and store the original in a safe place.

Installing under DOS

Make sure that you have connected the player to your computer ( P. 17, 18), and both the player and your computer are turned on ( P. 19).

To install the software onto your C drive, follow the steps below:

- 1** Insert the supplied Setup disk into drive A or B.
- 2** Type A: (or B:) and press **Enter** .
- 3** Type INSTALL and press **Enter** . The following message appears.

```
CD-ROM Drive Software Installation Program
Version 1.00 *1
All Rights Reserved, (C) COPYRIGHT 1995
KYUSHU MATSUSHITA ELECTRIC CO., LTD.

Press [Esc] to quit, any other key to continue.
```

- 4** Press any key except for **Esc** , and follow the instructions on your computer screen.

After restarting the computer, the following message appears which indicates that the software installation is complete.

Note:

- If you want to confirm a message, press **Pause** to pause the message. To resume, press any key.



```
CD-ROM Device Driver
KMECD Ver. 1.71 *1 (950829) *2
All Rights Reserved, (C) COPYRIGHT 1994, 1995
KYUSHU MATSUSHITA ELECTRIC CO., LTD.
(C) Copyright 1994, 1995 RATOC System Inc. Osaka Japan

CD-ROM SCSI ID NO. : 5*3: MATSHITAKME CD-ROM02 1.00*1
Device name : PCMCIACD
```

and then,

```
MSCDEX Version 2.23 *1
Copyright (C) Microsoft Corp. 1986-1993. All rights reserved.
Drive D*4: = Driver PCMCIACD unit 0
```

- *1 Version number may change.
- *2 Date may change.
- *3 SCSI ID number assigned to a CD-ROM drive.
- *4 A drive letter assigned to a CD-ROM drive.

If an error message appears, refer to "Error Messages on Computer" ( P. 26), "README File" ( P. 27) or "Troubleshooting" ( P. 29).



Installing under Windows 95

Make sure that the PCMCIA cable is connected to the PC card and to the player.

1 Power on your computer.

Windows 95 automatically starts.

2 Power on the player (P. 19) and then insert the PC card to your computer's PCMCIA card slot (P. 17, step 3).

"New Hardware Found" window appears only when the inserted card is not previously registered in Windows 95.

3 Click .

"Driver from disk provided by hardware manufacturer" is selected and "Install From Disk" window appears.

4 Insert the supplied Setup disk into drive A (or B), and click .

The initial screen appears and the driver has been installed.

Inserting / Removing a CD

Inserting a CD

To insert a CD, follow the instructions below.

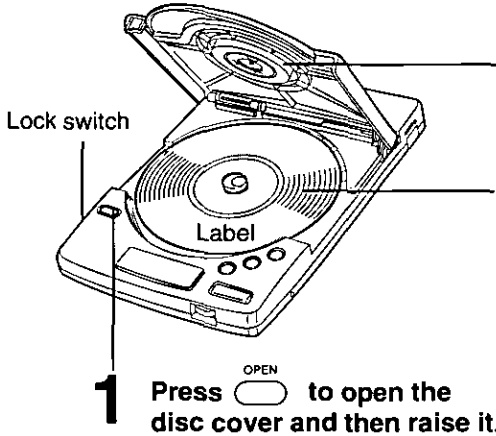

- 3 Close the disc cover.
- 2 Place a CD onto the center spindle.

Note:

- Insert CD with the disc's label facing up.

Note:

- To transport the player, remove the CD and slide the Lock switch toward the rear of the player, otherwise the disc cover may open and the player or the CD may get damaged.

Removing a CD

To remove a CD, follow the instructions below. Make sure that a blinking message "BUSY" does not appear on the player's display, and the Lock switch is not slid toward the rear of the player.

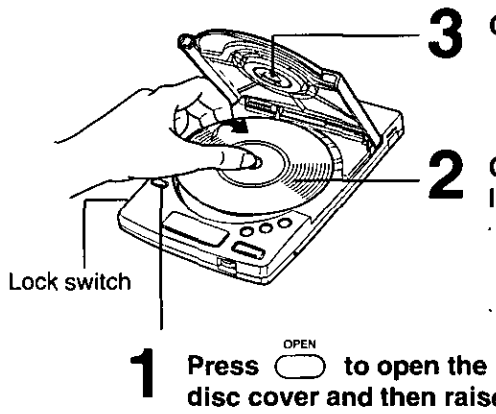

- 3 Close the disc cover.
- 2 Carefully remove the CD by lifting it.

Note:

- Replace the CD in its original case.

Software Installation



Inserting/Removing a CD

Using the Player with Computer

After the software installation (P. 20), you are ready to play game/photo/audio/video CDs.

Insertion/Removal with Power On (For DOS/Windows 3.1, 3.11)

If your computer has a Card Service and ASPIFMNGR.SYS is being used, PC card can be removed or inserted from/into the PCMCIA card slot of computer without turning off your computer.

However, when you start running your computer, make sure that PC card is inserted into the PCMCIA card slot and the player is on. If ASPIF365.SYS and ASPIFDBK.SYS are being used, Insertion/Removal with power on is not possible.

With Windows 95 Insertion/Removal is possible at any time.

Note:

- If your computer has more than one slot, and if you want to re-insert the PC card, make sure to insert it into the same slot it was inserted before.

Playing a CD-ROM

- To listen to the computer sound of CD-ROM, it needs for the desktop computer user to install Sound Blaster [Creative Technology Ltd.], etc., and it is recommended to install the optional KXL-D20 for the notebook computer user.
- To play VIDEO CD or CD-I, commercial MPEG Boards [REAL Magic LITE (SIGMA DESIGNS Ltd.) is recommended] is required on the computer side.

Notes:

- Some CD-ROMs are soundless.
- The computer sound of some CD-ROMs can be listened only through the PHONES jack of the player. Connect your headphones to the PHONES jack of the player or, if your sound system device has a Line-in jack, connect an audio connecting cable (not supplied) to the Line-in jack of the sound system device and to the PHONES jack of the player.





Playing an audio CD

To operate audio CD on computer, install **audio CD control software** (not supplied) (for DOS users) or use the Media Player in Accessories (for Windows 3.1, 3.11 users). If Windows 3.1, 3.11 is used, be sure to add "[MCI] CD Audio" at Drivers in Control Panel.

You can listen to the audio CD through either of the following methods.

- Connect your headphones or amplified speaker to the PHONES jack of the player.
- Connect one end of an audio connecting cable (not supplied) to the Line-in jack of your sound system device and the other end to the PHONES jack of the player.

Note:

- While playing an audio CD with your computer, buttons , ,  and  on the player cannot be used.



Using the Player Independently

Playing an audio CD

If you are using batteries, you can enjoy listening to music under stable conditions. It is recommended not to play an audio CD while walking or jogging. If you want to play an audio CD without disconnecting from your computer, be sure to open and close the disc cover before playing to guarantee the player's buttons function properly.

Caution:

- It is not safe to listen to headphones while driving a car.

Be sure the VOLUME control is set to 2~4 to avoid hearing very loud sound.

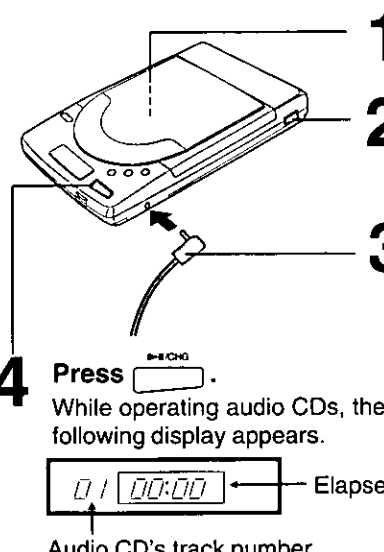

1 Insert an audio CD (P. 23).

2 Press POWER switch to turn on the player.

3 Plug your headphones (not supplied) into the PHONES jack.

4 Press  .





While operating audio CDs, the following display appears.

 Elapsed time

Audio CD's track number

Note:

- You can also listen to the music by connecting amplified speakers (not supplied).

Button	Function
	Starts/pauses playing an audio CD.
	Skips to the next track by pressing once. Continues skipping tracks if you hold down.
	Returns to the beginning of the track being played by pressing once. Skips to the previous track by pressing once when the elapsed time is 00:00. Continues reversing tracks if you hold down.
	Stops playing an audio CD.



Error Messages on Computer

When installing the software

Message	Recommendation
Illegal Directory Name!	Don't use more than eight characters.
	Don't use invalid characters such as "\", "*", etc.
Disk Error!	Make sure that your floppy disk or hard disk is not damaged.
	Don't install the CD-ROM Drive Software onto a protected disk.
File not found!	Make sure that CD-ROM Drive Software has been installed onto disk inserted into drive A or B.
This installation was failed!	Re-install the software correctly.
	Make sure that your computer has PCMCIA slot.
	Make sure that the connection between your computer and the Card Slot Board has been made properly.

When restart the computer after installing software

Refer to the following items of the README File (P. 27).

1. ASPI Manager
2. CD-ROM Device Driver
3. MSCDEX.EXE

README File

The README File on the supplied Setup disk contains additional information on system troubleshooting and it is copied to the hard disk (normally to C:\CDRM) during installation, except Windows 95.

1. ASPI Manager
2. CD-ROM Device Driver
3. MSCDEX.EXE
4. Error Messages when installing software
5. Sample CONFIG.SYS Files
6. I/O Base Address
7. Supplement and Troubleshooting Guide

Read or print this file if you have difficulty in installing the CD-ROM drive.

Viewing the README.TXT File in DOS

- 1 At the DOS prompt (C:\), type MORE <\CDRM\README.TXT
- 2 Press .

Viewing the README.TXT File in Windows 3.1, 3.11

- 1 Double-click the Notepad icon of Accessories.
- 2 Select "Open" from the File menu.
- 3 Double-click the directory name.
(Normally it is C:\CDRM)
- 4 Select the file name "README.TXT".
- 5 Click .



Viewing the README.TXT File in Windows 95

When installing under Windows 95, README File is not automatically copied to the hard disk. To view the file, follow the instructions below.

- 1** Double-click the My Computer icon.
- 2** Insert the supplied Setup Disk.
- 3** Double-click the 3½ Floppy icon.
- 4** Double-click the README icon.





Troubleshooting

When trouble occurs, check the following points before returning the player for service.

Trouble	Possible Cause	Solution
Turn on the POWER switch, but nothing appears on the display.	AC adaptor is not plugged into the outlet or DC IN jack correctly.	Plug in the AC adaptor correctly (P. 13).
	The alkaline batteries or rechargeable battery are/is not installed correctly, or dead.	Install the alkaline batteries/rechargeable battery properly, charge the rechargeable battery or replace with new batteries (P. 13, 14, 16).
The data of CD-ROM is not transmitted to your computer.	The PCMCIA cable or PC card is not connected to the player or to the computer properly.	Properly connect the PCMCIA cable or PC card (P. 17).
	The SCSI cable is not connected to the player or to the desktop computer properly.	Properly connect the SCSI cable.
	There are duplicate SCSI ID numbers in computer system.	Set different SCSI ID number for each device in your system (P. 34).
	The software is not installed correctly.	Install the software correctly (P. 20).
	PCMCIA cable pin is bent or broken.	Contact an Authorized Panasonic Service Center.
	The terminator switch of the player is set to OFF.	Turn the terminator switch ON (P. 34).
You cannot listen to sound.	Headphones are not connected.	Connect the headphones to the PHONES jack firmly (P. 25).
	VOLUME control are set to "0".	Set the VOLUME control to a higher level.
Transmission speed of data slows down.	Using the alkaline batteries/rechargeable battery with computer.	Use the AC adaptor.
	The notebook computer has entered the power management mode.	Set the CPU speed of the notebook computer faster in power management or use the AC adaptor.
Disc cover can not be opened.	The Lock switch is slid toward the rear of the player.	Slide the Lock switch to opposite direction.



Troubleshooting

Trouble	Possible Cause	Solution
AC adaptor is connected/rechargeable battery or batteries is/are installed, but buttons/POWER switch of player do not function.		Disconnect the AC adaptor/remove the batteries or rechargeable battery and then connect the AC adaptor/install the batteries or rechargeable battery.
"no DISC" message appears on player's display even after inserting a CD, Sound skips, or data can not be read.	CD is placed with the label side facing down.	Place the CD with the label side facing up (P. 23).
	CD without  or  mark is used.	Use the CD marked with  or  .
	CD may have become dirty.	Clean the CD (P. 35).
	CD is damaged.	Replace with another CD.
	The player or/and CD are damp or moist, because the player or/and CD may be moved from a cold place to a warm place.	Remove the CD from the player and do not use the player and CD for 1 hour.
The optional rechargeable battery runs down too soon.	The rechargeable battery capacity has been reduced and the battery life has been shortened by being charged too often after using for short periods.	Refresh the rechargeable battery (P. 15). If the battery runs down quickly even after refreshing, replace with new one.
The optional rechargeable battery can not be charged.	AC adaptor is not connected, the rechargeable battery is not installed or POWER switch of the player is not on.	Connect the AC adaptor, install the rechargeable battery or turn on the POWER switch of the player (P. 14).

Details of Setup Disk Software

About the installation copy

Setup disk contains the following programs (❶, ❷ and ❸). When installing the software, programs ❷ and ❸ are copied entirely. However, in case of program ❶, only one file (❶, ❷ or ❸) is copied, depending on your hardware condition (☞ table below). Installation will automatically choose ❶, ❷ or ❸.

❶ ASPI Manager

File	Condition
❶ ASPIFMGR.SYS	when your computer has both Card Service and Socket Service.
❷ ASPIFDBK.SYS	when your computer has only Databook CardTalk.
❸ ASPIF365.SYS	when your computer has neither Card Service nor Socket Service.

❷ CD-ROM Device Driver KMECD.SYS

❸ Microsoft MS-DOS CD-ROM Extensions MSCDEX.EXE

Options for ASPI Manager (for sophisticated users)

Each file of ASPI Manager has the following options.

❶ ASPIFMGR.SYS

/port=XXX	Since the I/O port is needed for the PC card, add this line and specify the base address at XXX using a hexadecimal number. The PC card occupies 16 bytes of space starting the specified base address. If you don't specify the I/O base address, 240h is applied. If the specified address is already used, you may specify another base address from the following addresses. Also, depending on the computer, the I/O port may need to be specified in the Card Manager. Refer to your computer manual. 140 180 220 230 240 250 260 270 280 290 300 320
/socket=X	When you are using a personal computer with more than two PCMCIA card slots, add this line and specify the slot at X, where you are inserting the PC card. If you specify 0 or you don't specify the slot, the installation program searches all slots, and uses the first available slot.
/BOFF	Setting this option turns off the beep sound that is generated when inserting or removing the PC card.

(Example) DEVICE=C:\CDRM\ASPIFMGR.SYS /port=280 /socket=2



Details of Setup Disk Software

ⓑ ASPIFDBK.SYS

/mem=XXXX	Add this line and specify the memory space's base address to read the card information by the segment address (hexadecimal number). You need to exclude this specified address with the EMS option so that it will not overlap the region of EMS. If you don't specify the base address, ce00 is applied, and 8 KB of memory from ce000 to cfff is used.
/port=XXX	Same as "/port=XXX" in ASPIFMGR.SYS, but address 220, 230, 240 and 250 are not available, and if you don't specify the I/O base address, 300h is applied.
/socket=X	Same as "/socket=X" in ASPIFMGR.SYS.

(Example) DEVICE=C:\CDRM\ASPIFDBK.SYS /port=280 /mem=c800 /socket=2

ⓒ ASPIF365.SYS

/mem=XXXX	Same as "/mem=XXXX" in ASPIFDBK.SYS.
/port=XXX	Since the I/O port is needed for the PC card, add this line and specify the base address at XXX using a hexadecimal number. The PC card occupies 16 bytes of space starting the specified base address. If you don't specify the I/O base address, 240h is applied. If the specified address is already used, specify another base address from the following addresses. 140 180 220 230 240 250 260 270 280 290 300 320
/socket=X	Same as "/socket=X" in ASPIFMGR.SYS.
/I365RST	After setting this option, PCMCIA Controller i82365 should be reset.

(Example) DEVICE=C:\CDRM\ASPIF365.SYS /port=280 /mem=c800 /socket=2

Options for Microsoft MS-DOS CD-ROM Extensions

The format of the MSCDEX program in the AUTOEXEC.BAT file is as follows:

MSCDEX [/V /K /E] /D:[DriverName] /L:[DriveLetter] /M:[Value]

- /V** Displays the list of additional information including how much memory is used by buffers, resident data and resident code.
- /K** Type this only when the CD-ROM media directory is written in Kanji (Japanese).
- /E** Expanded memory (EMS) is usable if this is available in your system. This conserves about 16 KB of main DOS memory.

/D:[DriverName]

Driver name is a required parameter to communicate with the CD-ROM drive. The internal name of KMECD.SYS is PCMCIA CD, and should be substituted for [DriverName].

/L:[DriveLetter]

Drive letter is an alphabetic character assigned to a CD-ROM drive. If there is more than one CD-ROM drive, the alphabetic characters are sequentially assigned starting with the entered drive letter. If no drive letter is entered, next available alphabetic character is assigned.

If you assign except A~M for DriveLetter, you must change the DOS LASTDRIVE statement. In your CONFIG.SYS file, add a line like this:

LASTDRIVE=

Type the alphabetic character (N~Z) assigned to the last valid drive that DOS may use.

/M:[Value]

MSCDEX allocates the memory as sector buffers for caching CD-ROM information. If no buffer size is entered, 10 buffers each of which uses 2048 bytes of memory will be allocated.

For example, to install MSCDEX with an internal name of PCMCIA CD, use expanded memory, and configure the CD-ROM drive as drive H, enter:

MSCDEX /E /D:PCMCIA CD /L:H



SCSI ID Number and Terminator

■ SCSI ID number:

Each SCSI device connected to your computer system has an individual ID number (refer to the respective manuals). Be sure that the CD-ROM SCSI ID number does not conflict with another SCSI device connected to the computer system. Normally personal computer's SCSI ID number is set to 7.

The factory setting of the player's SCSI ID number is set to 5.

■ Terminator:

Set the Terminator switch ON or OFF according to the player's condition.

ON: when the player is connected to the computer system.

OFF: when using independently as an audio player (power consumption can be saved) (P. 25).

The factory setting is **ON**.

Setting

Set the ID number switch (1~3) or Terminator switch (4) ON/OFF by using a pointed object like a pen, and referring to the table below (for ID number).

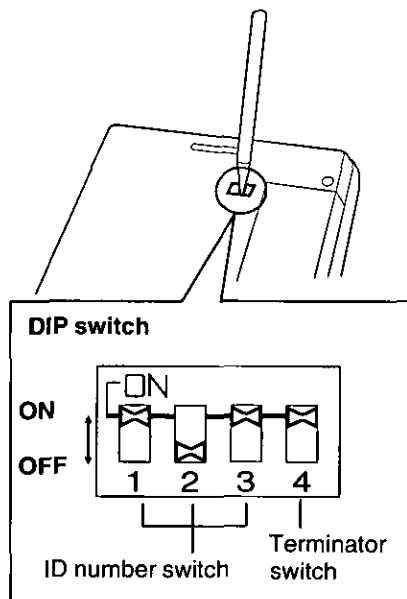

(For SCSI ID number setting)

ID number	ID number switch		
	1	2	3
0	OFF	OFF	OFF
1	ON	OFF	OFF
2	OFF	ON	OFF
3	ON	ON	OFF
4	OFF	OFF	ON
5	ON	OFF	ON
6	OFF	ON	ON
7	ON	ON	ON

: Factory setting.

Example: ID number=5/Terminator=ON

Maintenance

Player

Cautions:

- Do not use benzine, thinner, etc.
- Do not use commercial lens cleaner.

Clean the outside of the player with a soft, dry cloth.



Clean the lens with a dry cotton swab or a lens blower.

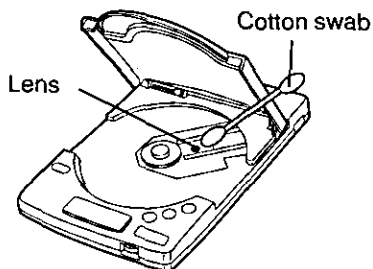

CD

Cautions:

- Do not use solvents such as benzine, record cleaners or anti-static spray for records.
- Do not touch the signal side.
- Do not attach the labels to the disc.
- Do not write on the surface of disc with a pointed object like a pen.

Wipe from the center to the edge with a dry, soft cloth.



Specifications

Power Source:	Refer to the nameplate at the bottom of the unit.
Interface:	PCMCIA/SCSI-1, 2
Buffer Size:	128 KB
Operating Environment (under no damp or moist conditions):	Temperature: 5°C {41°F} to 35°C {95°F} Humidity: 20% to 85% RH
Storage Environment (under no damp or moist conditions):	Temperature: -20°C {-4°F} to 55°C {131°F} Humidity: 15% to 85% RH
Dimensions:	138 (W) × 204 (D) × 35 (H) mm {5.52" × 8.16" × 1.4"}
Mass {Weight}:	0.46 kg {1.014 lb.} (without batteries)
Battery Life [at 20°C (68°F)]:	<ul style="list-style-type: none"> • When using Panasonic alkaline "AA" size batteries Approximately 4 hours when playing audio CD Approximately 2 hours when playing CD-ROM • When using the optional rechargeable battery Approximately 2 hours when playing audio CD Approximately 1 hour when playing CD-ROM
Power Consumption:	<ul style="list-style-type: none"> • When playing CD-ROM (with PC card) 12 W [with AC adaptor] • When player is off 1.0 W [with AC adaptor]
Data Transfer Rate (when using AC adaptor):	150 KB/s (Normal Velocity mode) 600 KB/s (Quad Velocity mode)
Output Connector:	PHONES jack
Compatible CD-ROM Format:	CD-DA (CD) CD-ROM (Mode 1 and Mode 2 Form 1) Photo CD Multi-session CD-ROM XA (Mode 2 Form 2) VIDEO CD CD-I

Access Time* (when using AC adaptor): (The information is based on the test results measured by Panasonic internal test software.)	Access time (Quad Velocity mode) 295 ms typical (1/3 stroke) Fullstroke access time (Quad Velocity mode) 540 ms typical	
Error Rates:	Soft read errors Hard read errors	Less than 10^{-9} Less than 10^{-12}
Audio Performance (Stereo Headphones):	Frequency response S/N Output level	20 Hz~20 kHz More than 80 dB (A Range) 0.6 Vrms
PC Card and PCMCIA Cable:	Card type Power source SCSI Connector Cable Length Data transfer rate PC card Dimensions Mass (Weight) (with cable)	Type II DC 5 V, approximately 80 mA (Typ.) Half-pitch 50-pin 350 mm (without connector) 7.0 MB/s (MAX.) 54 (W) × 85.6 (D) × 5 (H) mm {2.13" × 3.37" × 0.20"} 0.13 kg {0.287 lb.}

* When using optional rechargeable battery and alkaline "AA" size batteries, the access time may increase.



Index

A

AC adaptor	10, 13, 14, 15
Accessories	10
Alkaline batteries	16
Audio CD	24, 25
Audio CD control software	24

B

Back-up copy	20
Battery cover	11, 13, 16

C

Charging rechargeable battery	14
Connecting Player to Computer	17, 18
CD	23, 35
CD-ROM	24

D

Daisy chain	18
DC IN jack	11, 13
Desktop computer	18, 20
Details of Setup Disk Software	31
DIP switch	11, 34
Disc cover	11, 23
Display	11
Display Messages	12
DOS	21, 24, 27

E

Error Messages	26
--------------------------	----

F

Features	8
Forward skip button	11, 25

I

Insertion/Removal with Power On	24
---	----

L

Lock switch	11, 23
-----------------------	--------

N

Notebook computer	17, 20
-----------------------------	--------

O

OPEN button	11, 23
Options	back cover

P

Part Names	11
PC card	10, 17
PCMCIA cable	10, 17
PHONES jack	11, 25
PLAY/PAUSE button	11, 25
Playing audio CD	24, 25
Playing CD-ROM	24
Power On	19
Power Save Function	19
Power Supply	13
Precautions	10

R

README File	27
Rechargeable battery	12, 13, 14, 15
Reverse skip button	11, 25

S

SCSI ID number	11, 34
SCSI interface	18
SCSI interface connector	11, 17
Setup disk	10, 20, 21, 22
Software Installation	20
Specifications	36
STOP button	11, 25

T

Technical Support and Service Parts Calls	7
Terminator	34
Troubleshooting	29

V

VOLUME control	11, 25
--------------------------	--------

W

Windows 3.1, 3.11	24, 27
Windows 95	22, 24, 28



Options

The following options are available through your local authorized parts distributor.

KXL-D30 Rechargeable Battery

KXL-D20 Multimedia Sound Kit

**Panasonic Communications & Systems Company,
Computer Products Division
Division of Matsushita Electric Corporation of America**
Two Panasonic Way, Secaucus, New Jersey 07094

**Panasonic Sales Company
Division of Matsushita Electric of Puerto Rico, Inc.**
San Gabriel Industrial Park, 65th Infantry Avenue KM. 9.5
Carolina, Puerto Rico 00630

Matsushita Electric of Canada Limited
5770 Ambler Drive, Mississauga, Ontario, L4W 2T3

Matsushita Electric Industrial Co., Ltd.
Central P.O. Box 288, Osaka 530-91, Japan
