

BROADCAST[®] engineering

An INTERTEC Publication

June 1993/\$4.50

NAB convention replay

- 1993 Pick Hits
- Exhibitor highlights
- Engineering Conference report
- NAB in perspective

Special Report

- Developments in mag tape
- Radio on-air automation systems

Who says you can't **expand** your old routing switcher?

pro-bel, The Solutions Company,
has the answer to your expansion dilemmas. It
doesn't matter whose routing switcher you have,
or even whether you use several different ones.

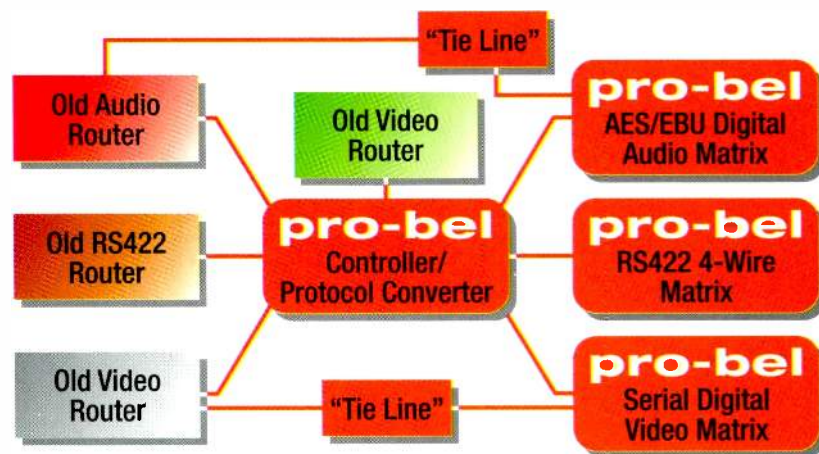

Our vast experience in systems engineering and interfaces enables us to create a system for your facility that extends the life of your existing hardware. You can then expand or add only the matrices you need such as serial digital video, AES digital audio, analog video, analog audio, or RS422 data, and control it all with the *sophisticated and user friendly* Pro-Bel control system. Our unique "tie line" software automatically facilitates digital to analog, and analog to digital path seeking in the system. You can even use your old control panels or add state-of-the-art touch screen control. Call us for more details or a system evaluation and quotation.

pro-bel
INC.

4480 North Shallowford Rd.
Dunwoody, GA 30338-6410

Telephone: (404) 396-1971
Fax: (404) 396-0595

• Atlanta • San Francisco • Boston • Orlando and growing!



Mom Always Said, “Keep Your Hair Combed, Wear Clean Underwear And Put Out A Hellaciously Clean Signal.”



The way Mom felt about keeping everything neat and clean, she'd love our Platinum Series® FM transmitters. They put out the cleanest signal around. So clean, in fact, they outperform the competition, no sweat.

What does all this cleanliness mean to you? Increased market share. Because your signal will be noticeably stronger than your competitors'.

You'll sweep up more revenue. And increase your profits.

What's more, our Platinum Series FM transmitters are simple to maintain and operate. Their solid state technology eliminates the constant fine-tuning demanded by tube transmitters. And decreases recommended maintenance by up to 90%. You won't have to

worry about down time mopping up your revenue.

Attract more listeners with a Platinum Series FM transmitter from Harris Allied, the most trusted name in FM technology. We'll help you make a clean break to the top of your market.

USA 217-222-8200

Fax 217-224-1439

Canada 800-268-6817

Toronto 416-731-3697

Intl. 217-222-8290

Fax 217-224-2764

 **HARRIS
ALLIED**

Contents

June 1993 • Volume 35 • Number 6

BROADCAST
ENGINEERING



Page 22

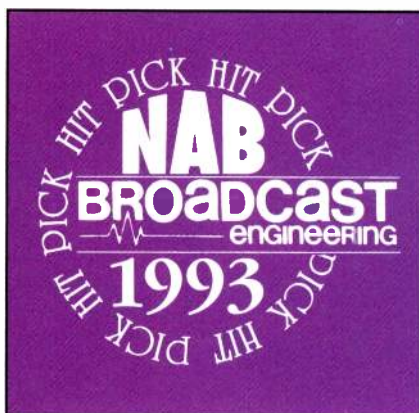

Page 32

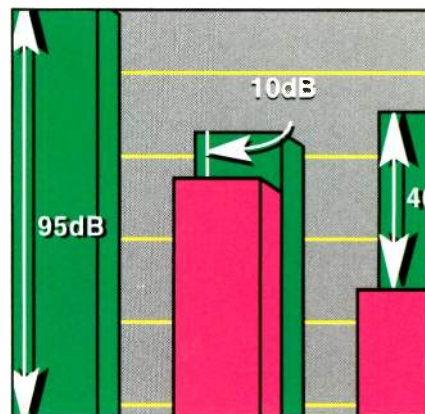

Page 114

NAB CONVENTION REPLAY:

With attendance approaching 65,000, this year's NAB hit a high point in the amount of attendees and exhibitors. Reports indicate that traffic was higher than in previous years, and that customers had their checkbooks open and were ready to buy.

THIS MONTH...

- 22 From the Show Floor:
A Perspective**
By Brad Dick, editor
NAB took the high road this year with record attendance, buying fever and more new products than ever.
- 32 The Pick Hits of NAB '93**
By Skip Pizzi and Steve Epstein, technical editors
BE's panel of industry experts selects the best new products at NAB.
- 47 NAB Engineering Conference Report**
By Skip Pizzi, technical editor
A mind-numbing array of sessions confronted NAB '93 attendees.
- 50 Show of Shows**
By Stefanie Kure, associate editor

DEPARTMENTS:

- 4 News
- 6 Editorial
- 8 FCC Update
- 10 Strictly TV
- 12 re: Radio
- 14 Management for Engineers
- 16 Circuits
- 18 Troubleshooting
- 20 Technology News
- 124 Industry Briefs
- 124 Classifieds
- 128 Advertisers' Index

OTHER FEATURES:

- 114 "Radio in Transition:" On-Air Audio Processing**
By Skip Pizzi, technical editor
Understanding the listener's environment is essential to proper use of today's processing.
- 118 Developments in Magnetic Tape**
By George McBride
Improvements and adjustments continue in the world of magnetic tape.

ON THE COVER:

This year's trek to Las Vegas for the NAB Convention was highlighted with a look at more than broadcast and production equipment. For the first time, multimedia products were shown in an adjacent exhibition area. One often-seen element in multimedia exhibitions are video walls like the one shown. (Photography by Douglas Schwartz Photography, equipment provided by Synelec.)

INTRODUCING THE

S310

The S310 All Format Digital Video Analyser is the first piece of test equipment ever designed to perform comprehensive analysis of any digital video signal or system.

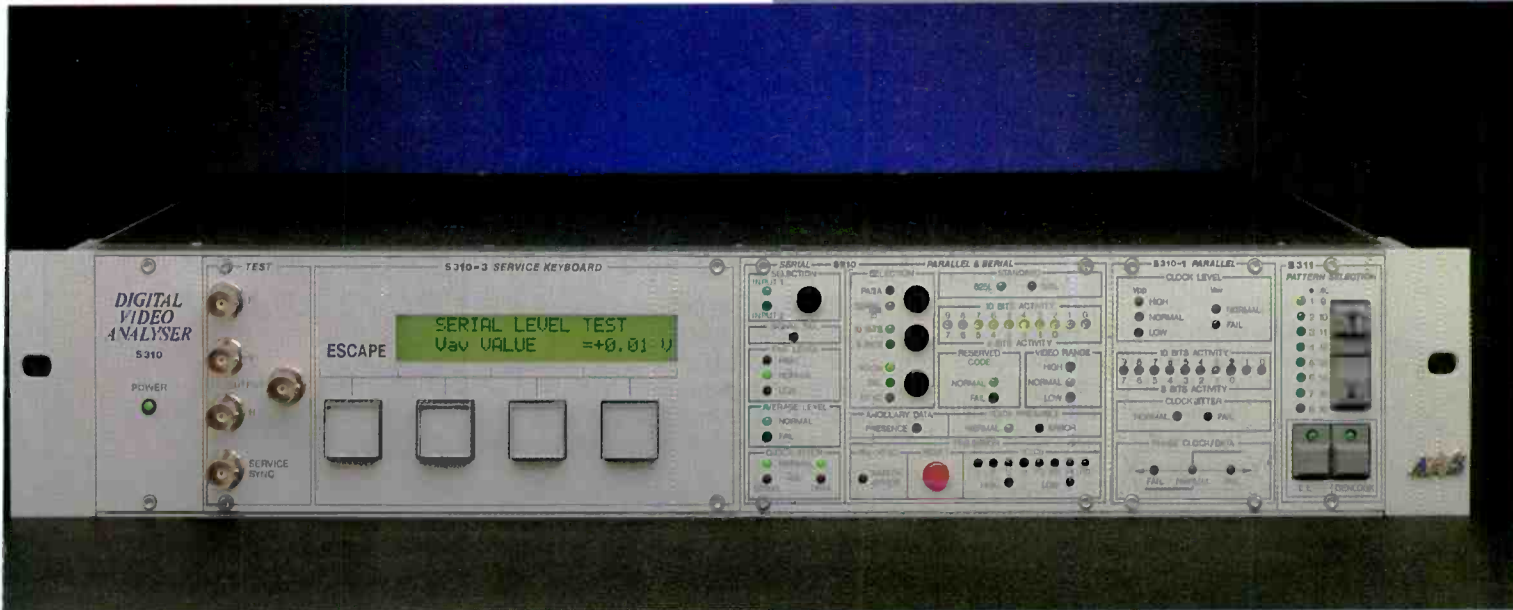

All Format Digital Video Analyser

The S310 is a modular test system that performs comprehensive, on-line testing of all composite or component digital video signals transmitted in either a serial or parallel format. The S310 analyses each signal input for conformance to all international standards, such as CCIR 601, 656, and SMPTE 259M, 244M, etc., and provides quantitative measurements of all system parameters, such as signal amplitudes, jitter, timing errors, phase, etc.

The S310 provides you with all the information you need to determine if your digital video signal is meeting standards, and the power to find out why, if it is not.

The S310 allows you to: _____

- Performance test or troubleshoot any digital video signal or system.
- Performance test or troubleshoot any digital video signal or system.
- Gain detailed signal information for troubleshooting or maintenance purposes.
- Set user selectable alarm functions that provide instant warning of signal parameters failing to meet set standards.
- Do remote monitoring and data logging through RS-232C and RS-422 data ports.
- Use a complete digital pattern generator that offers up to 34 different test and troubleshooting patterns.

AAVS

Advanced Audio Visual Systems
By

SENCORE

3200 Sencore Drive, Sioux Falls, SD 57107
Phone: 1-800-769-AAVS(2287) or (605) 339-0100
Fax: (605) 335-6379

Circle (4) on Reply Card

Call 1-800-769-AAVS(2287)
for more information!

By Dawn Hightower,
senior associate editor

FCC considers HDTV Grand Alliance proposal

The Federal Communication's Advisory Committee on Advanced Television Service (established in 1987) will review a single digital HDTV system proposed by a "Grand Alliance" of entities that had sponsored the four remaining competitive HDTV systems.

The companies (AT&T, the David Sarnoff Research Center, General Instrument, Massachusetts Institute of Technology, North American Philips, Thomson Consumer Electronics and Zenith Electronics) have reached a business and technical agreement and have submitted a merged system proposal.

If the proposed system is recommended by the Advisory Committee and adopted by the FCC, it could place the United States in the forefront of high-definition video technology. An all-digital standard that would enable interoperability among broadcasting, cable, computer and telecommunications technologies has worldwide potential.

Important aspects of the Grand Alliance technical proposal include the employment of progressive scan transmission (where entire picture frames are transmitted sequentially) and the use of so-called "square pixels" (where the dots on a TV screen are arranged in equally spaced rows and columns). These design aspects are important for the interoperability of HDTV with computers, telecommunications and other media and applications. Interlaced scan transmission also would be accommodated in the initial deployment.

The proponents agree that all large-screen HDTV receivers (34 inches in diagonal and above) will incorporate a 60-frame-per-second, 787.5-line or higher progressive scan display mode. Progressive display would be optional for smaller screen receivers. The proponents also concur that all transmission of film material will be in a progressive scan format when HDTV service begins.

The Grand Alliance proponents endorse the objective of migrating the standard to a high line number (i.e. thousand-line plus) progressive scan transmission, as soon as feasible, and will work together to eliminate interlaced scanning format from the transmission path in the future.

To support multiple transmission formats, the merged system will feature

source adaptive processing. To promote system flexibility and extensibility, the merged system also will feature a prioritized, packetized data transport structure. The Grand Alliance agrees to support the proposed HDTV compression system in the International Standards Organization as the MPEG-2 HDTV profile.

DAR subcommittee go-ahead for NASA DAR testing site

The Electronic Industries Association's (EIA) Digital Audio Radio (DAR) Subcommittee has accepted the National Aeronautics and Space Administration's (NASA) offer to use its Lewis Research Center in Cleveland for the testing of DAR propellant systems.

The subcommittee also has extended its testing timetable to allow for the completion of propagation tests in Charlotte, NC, and Seattle. It also will allow potential in-band, on-channel (IBOC) system proponents time to respond to the call for proponents issued by the National Radio Systems Committee (NRSC). Responses were due June 18.

DAR system testing is scheduled to begin in early October at NASA's Lewis Research Center. In addition, the center will supply testing equipment and personnel to assist in testing.

FCC should use terrestrial DAB for digital radio

According to the National Association of Broadcasters (NAB), the introduction of a new satellite radio service, with 30 to as many as 200 channels, could harm local radio stations.

In comments to the Federal Communications Commission (FCC), NAB urged the commission to focus on implementing DAB throughout the existing terrestrial radio services as the most efficient way to introduce DAB to U.S. consumers.

NAB also said that there has been significant progress in the development of terrestrial in-band, on-channel DAB. Nevertheless, it is premature for the commission to set standards for in-band, on-channel DAB because the development process is far from complete. Once development has stabilized, broadcasters and receiver manufacturers will have to test and evaluate these systems.

EDITORIAL

Brad Dick, *Editor*
Skip Pizzi, *Technical Editor*
Steve Epstein, *Technical Editor*
Dawn Hightower, *Senior Associate Editor*
Stefanie Kure, *Associate Editor*
Tom Cook, *Senior Managing Editor*
Carl Bentz, *Directory Editor*

ART

Nenita Gumangan, *Graphic Designer*

BUSINESS

Harry A. McQuillen, *President*
Raymond E. Maloney, *Executive Vice President*
Cameron Bishop, *Group Vice President*
Dennis Triola, *Group Publisher*
Tom Brick, *Marketing Director*
Stephanie Hanaway, *Group Director, Special Projects*
Kathryn Buckley, *Promotions Manager*
Sandra Tomczak, *Promotions Coordinator*
Dee Unger, *Advertising Business Manager*
Mary Birnbaum, *Advertising Production Supervisor*
Shelly Larkey, *Advertising Coordinator*
Greg Hembree, *List Rental Sales*
Doug Coonrod, *Corporate Art Director*
Julie Neely, *Circulation Director*
Customer Service: 913-967-1711

TECHNICAL CONSULTANTS

Ned Soseman, *Contributing Editor*
Eric Neil Angevine, *Broadcast Acoustics*
John H. Battison, *Antennas/Radiation*
Dennis Ciapura, *Radio Technology*
Dane E. Erickson, *P.E., Systems Design*
John Kean, *Subcarrier Technology*
Donald L. Markley, *Transmission Facilities*
Harry C. Martin, *Legal*
Curtis Chan, *Audio/Video Technology*

MEMBER ORGANIZATIONS

Sustaining Members of:
• Acoustical Society of America
• Society of Broadcast Engineers
• Society of Motion Picture and TV Engineers

Member,
American Business Press

Member,
BPA International



BROADCAST ENGINEERING is edited for corporate management, engineers/technicians and other station management personnel at commercial and educational radio and TV stations, teleproduction studios, recording studios, CATV and CCTV facilities and government agencies. Qualified persons include consulting engineers and dealer/distributors of broadcast equipment.

BROADCAST ENGINEERING (ISSN 0007-1994) is published monthly (plus three special issues) and mailed free to qualified persons within the United States and Canada in occupations described above. Second-class postage paid at Shawnee Mission, KS, and additional mailing offices. POSTMASTER: Send address changes to **Broadcast Engineering**, P.O. Box 12960, Overland Park, KS 66282-2960.

SUBSCRIPTIONS: Non-qualified persons may subscribe at the following rates: United States and Canada; one year, \$50.00. Qualified and non-qualified persons in all other countries; one year, \$60.00 (surface mail); \$115.00 (air mail). Subscription information: P. O. Box 12937, Overland Park, KS 66282-2937.

Authorization to photocopy items for internal or personal use, or the internal or personal use of specific clients, is granted by Intertec Publishing, provided that the base fee of U.S. \$2.00 per copy, plus U.S. \$00.00 per page is paid directly to Copyright Clearance Center, 27 Congress Street, Salem, MA 01970 USA. For those organizations that have been granted a photocopy license by CCC, a separate system of payment has been arranged. The fee code for users of the Transactional Reporting Service is 0007-1994/1993 \$2.00 + \$00.00.

CORRESPONDENCE

Editorial and Advertising: 9800 Metcalf, Overland Park, KS 66212-2215. Telephone: 913-341-1300; Editorial fax: 913-967-1905. Advertising fax: 913-967-1904.

©1993 by Intertec Publishing
All rights reserved.

INTERTEC
PUBLISHING CORPORATION

Introducing The Nikon S19x8B

There'll be times it's the only lens for the job.

In the world of ENG/EFP, disasters aren't planned. So you've got to plan ahead. After all, the biggest disaster is being on the scene but too far back to get the shot. That's why Nikon went to great lengths to create the S19x8B Lens for CCD cameras.

For a lens of this range, it's wonderfully light and maneuverable. So you never have to get too close to get close enough. The smooth zoom whisks viewers right into the heart of the subject matter.

From making our own glass to the final QC tests, we make sure the S19x8B is worthy of the Nikon name. Extra-Low Dispersion (ED) glass, Nikon anti-reflection coating, high-flat MTF curve, it has it all, and more, all wrapped up in a rugged housing of magnesium alloy.

And never a time it isn't.



The S19x8B may well be the only lens you ever need. Forget about lugging around a variety of lenses and fumbling around mounting them. The S19x8B's minimum object distance (37") and 8mm minimum focal length, providing expansive wide angle coverage, make it ideal for everyday use as well. That's unsurpassed range for an ENG/EFP lens.

To guarantee you can use it every day, the S19x8B comes with something else that's unsurpassed — Nikon's unique Express Loaner Service. If disaster ever strikes your lens, we'll get you a loaner lens overnight. So now there will never be a time you're really 'out' in the field.

To find out more or for our complete brochure, call 800-NIKON-US or (516) 547-4355 or write: Nikon Electronic Imaging, Dept. D1, 101 Cleveland Avenue, Bayshore, NY 11706.

Nikon
ELECTRONIC IMAGING

©1990 Nikon Inc.

Circle (5) on Reply Card



Editorial

Which fork to the streets of gold?

Yogi Berra once said, "When you come to a fork in the road, take it." Well, if broadcasters were looking for advice on which fork to take in the search for their future, this year's NAB keynote speaker certainly didn't help them decide.

Apple's CEO John Sculley was the speaker at the opening day. In what has traditionally been a position reserved for broadcast or political VIPs, Sculley was neither. And what Sculley said to the attending audience was not encouraging.

His opinions provided neither hope nor encouragement about the attendees' future. In fact, he challenged broadcasters to overthrow the FCC's plan for HDTV.

Outlining his view of the future, he talked of a convergence of the media, publishing, telecommunications and the computer industry into a single interrelated industry.

Sculley suggested that this shift toward interrelation would parallel the changes that resulted when this nation converted from steam power to the internal combustion engine, or from Morse Code transmission to analog telephones. The resulting technological changes will force broadcasters to compete in a world of satellite-delivered signals, 500-channel cable systems and CD-ROM technology.

Enough of the bad news. What was Sculley's suggested solution? It was radical, to say the least. He encouraged TV stations not to focus on a high-definition (HDTV) future, but instead to become a multichannel digital delivery system.

He proposed that broadcasters begin by convincing the FCC to abandon HDTV and divide their 6MHz of spectrum into several digital channels. This space would then be used to create an "intelligent data screen" providing the audience a variety of interactive choices.

Sculley claimed that because of the limited spectrum available to broadcasters, they will have fewer options than other services. "Do you want to sit this revolution out

or do you seize the moment by urging the FCC to turn that 6MHz bandwidth into a new digital service?" he asked. "The choice is yours."

Sculley's presentation was not the kind of rousing, go-get-'em address this group was accustomed to hearing. He told TV broadcasters the future is bleak unless they jump on the computer industry's version of the future. The fact that his approach flies in the face of the FCC's plans doesn't help either.

Broadcasters understand that they have choices to make ahead of them. Most thought the primary choice was when (not if) to adopt HDTV. Now, a widely respected member of the computer industry has just told an entire industry to take different fork in the road.

All we have to do now is figure out which fork leads to the streets of gold.

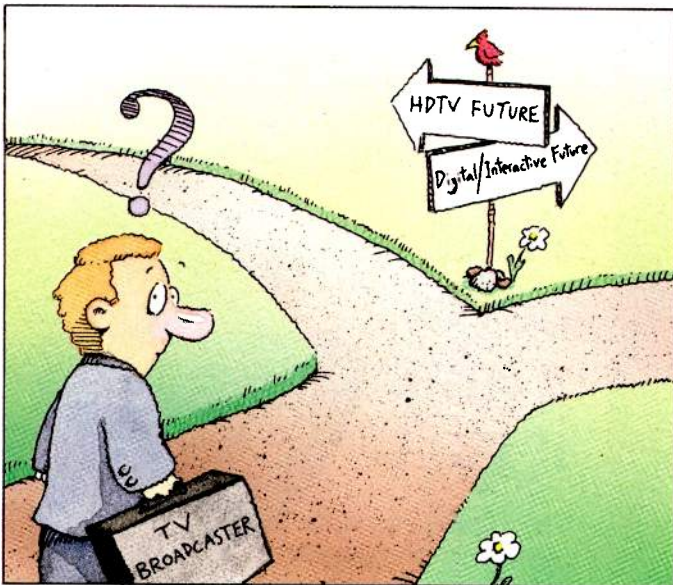

Brad Dick

By Brad Dick, editor

PURE PROGRESS.

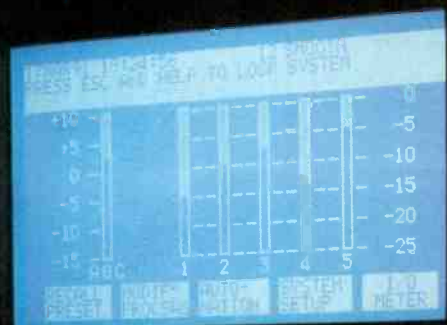

Stations Are Profiting From It.

FM stations around the world are finding more sophisticated ways to keep their listeners from cruising the dial. And OPTIMOD-FM 8200 has become a critical part of their strategy. Why? Because the 8200 is a technological breakthrough with bottom line impact. It lets you create a distinct, powerful sound that results in larger audiences, higher ratings and improved profitability.

Digital Makes the Best Even Better.

Digital technology not only improves the quality of the signal—it makes the OPTIMOD-FM 8200 more programmable, more flexible and more user-friendly. And it can actually help keep capital equipment costs down because it allows stations to expand and upgrade their system

with software, rather than expensive hardware.

A case in point: all current 8200 owners will receive a new software upgrade free of charge. Version 1.0's sonic and operational improvements meet broadcasters' ongoing demands for superior audio performance and increased control—like customized bass response and automatic switching of presets for dayparting.

The New Standard.

The OPTIMOD-FM 8200 is now the new industry standard for digital audio processors. Call your dealer now for a hands-on evaluation of the 8200. In a market where stations live and die by the ratings, you can dominate the dial.

**FEATURE-PACKED
1.0 SOFTWARE**
✓ Improved Sound
✓ Greater Control
CUSTOMIZE Your Sound

OPTIMOD-FM
D I G I T A L

orban[®]

a division of AKG Acoustics, Inc.
1525 Alvarado Street, San Leandro, CA 94577 USA
Phone: (1) 510/351-3500 Fax: (1) 510/351-0500

© 1993 AKG Acoustics, Inc. Orban and OPTIMOD are registered trademarks of AKG Acoustics, Inc. AKG is a registered trademark of Akustische u. Kino-Geräte Ges.m.b.H., Austria.

Circle (6) on Reply Card

FCC Update



Must-carry found constitutional

By Harry C. Martin

On April 8, a 3-judge panel of the U.S. District Court for the District of Columbia upheld the constitutionality of the 1992 Cable Act's must-carry provisions.

Regulations "content-neutral." The court has decided that the must-carry provisions of the Cable Act are "content-neutral" and subject to more relaxed First Amendment scrutiny.

Economic vs. ideologic purpose. The court, after finding the regulations content-neutral, said the government's intention is economic. The court's reasoning is based upon the fact that must-carry is an economic regulation that was designed to create competitive balance in the video industry and to remedy the effects of cable operators' anti-competitive practices.

Cable dominance cited. After determining that a significant government interest is served by the must-carry provisions, the court deferred to Congress' finding that cable operators have obtained a dominant position in the video signal distribution market. They have incentive and the ability to block non-cable programmers' access to the bulk of any prospective viewing audience.

Regulations not overly intrusive. Cable's plaintiffs claim that must-carry infringes on programming choices when alternative remedies, such as requiring installation of an "A/B" selector switch (to provide viewers a free choice between broadcast and cable programming) would remedy the impaired marketplace, but less intrusively. According to the court, the government does not need to demonstrate that it has used the least-restrictive means to accomplish what is primarily economic regulation of an industry that delivers video signals.

Current status. On April 15, the cable plaintiffs' efforts to obtain an injunction from the 3-judge court pending appeal were rebuffed. Under federal law, appeals from the decision of a special 3-judge court denying a constitutional challenge may be taken directly to the Supreme Court.

In the meantime, the FCC's must-carry

Martin is a partner with the legal firm of Reddy, Begley & Martin, Washington, DC.

Due dates for FCC filings

The annual employment report (Form 395-B) for all broadcast stations should have been filed by May 31. Annual ownership reports (Form 323) were due to be filed by June 1 for commercial radio and TV stations in: Arizona, District of Columbia, Idaho, Maryland, Michigan, Nevada, New Mexico, Ohio, Utah, Virginia, West Virginia and Wyoming. Renewal applications for LPTVs in Kansas and Nebraska, and for full-power TV stations in California are due by Aug. 1. Ownership reports for stations in North Carolina, South Carolina, Illinois, Wisconsin and California also are due by Aug. 1.

rules, implementing the must-carry provisions of the 1992 Cable Act, were scheduled to become effective June 2.

The effect of must-carry on cable

With the reregulation and must-carry rules affecting the video delivery marketplace, cable companies have been affected in additional ways. The must-carry rules force cable companies to carry TV signals as part of a basic cable package. Also, cable companies have never had to pay to carry a TV station. However, after Oct. 6 when the retransmit regulations go into effect, cable companies will have to pay or they will lose their right to carry the TV station. In addition, cable companies must carry stations that want to be on cable.

AM expanded band filing window open

The filing window for migration to the AM expanded band (1,605-1,705kHz) opened on May 3 and will close on June 30. Eligibility for expanded band allotments is limited to existing AM licensees. Petitions for migration should be addressed to the AM Branch of the FCC at 1919 M Street, N.W., Washington, DC 20554. The petition must include:

- an opening statement requesting migration;
- a description of the existing band station (call sign, community of license and operating frequency); and

- a statement as to whether the petitioner intends to use AM stereo.

LPTV rules to be amended

The FCC is proposing to amend its rules for the LPTV service by doing the following:

1. Abandoning its "letter perfect" acceptance standard.
2. Narrowing the definition of a "major" change.
3. Expanding the circumstances where terrain shielding can be used to show the absence of objectionable interference.
4. Permitting LPTV operators to use standard 4-letter call signs.

Currently, applications must be "letter perfect" at the close of a filing window or they are returned as defective. Applicants must wait until the next filing window to resubmit their corrected applications. Also, the modified service contour of a facility must be completely encompassed within its authorized service contour in order to qualify as a "minor" change and be eligible for processing without regard to filing window deadlines. The commission also has limited terrain-shielding showings to applications that aren't mutually exclusive, and has required the use of 2-digit, 3-letter call signs for LPTV.

Important dates for must-carry

June 17. Each TV station must decide whether it wants its relationship with local cable systems to be governed by must-carry or retransmission consent. Also, the date by which stations electing must-carry status must notify cable operators of their preferred channel positions.

Sept. 6. Cable operators who wish to drop the signals of stations with which they failed to reach retransmission consent agreements must notify subscribers of the signals being dropped.

Oct. 6. The effective date of the retransmission consent and channel-positioning requirements. ■

Both are reliable. Both are air-cooled.



TTC's HDR Series IOT Transmitter - An Engineer's Best Friend.

With over 26 years of transmitter design experience, it's no surprise that TTC is the leader in high power technology. The HDR Series transmitters are so energy efficient, your lease payment* can be covered by the savings in electric bills! Other HDR Series features include: the NEW High-Performance XLS-5 Exciter, Field-Proven CMOS controller, IEC 215 Safety Standard, Air or Water-cooling and of course, HDTV ready.

*Please contact factory for special lease rates.

A Global Force In Broadcast Transmission Technology

The logo for Television Technology Corporation (TTC) consists of the letters 'TTC' in a bold, blue, sans-serif font, set against a white background with horizontal lines above and below the text.

TELEVISION TECHNOLOGY CORPORATION

650 S. Taylor St., Louisville, CO 80027 (303) 665-8000 Fax: (303) 673-9900

To prepare for the future, call 1-800-TTC-HDTV.

Circle (7) on Reply Card

Strictly TV



Strictly HDTV

Implementation

By Steve Epstein, technical editor, and Curtis Chan

HDTV and its specific terrestrial broadcasting term advanced television (ATV) are the subject of many discussions. The terms ATV and HDTV have been used interchangeably to indicate a 16:9 picture. However, the two terms mean something quite different.

HDTV defines a 16:9 picture with at least twice the horizontal and vertical resolution of NTSC. ATV describes the transmission standard that will be adopted by the FCC for the delivery of 16:9 pictures. Unlike HDTV, which is the production system, ATV defines only the transmission system.

The Association for Maximum Service Television (MSTV) recently released a study titled *The Transition to Advanced Television*. The purpose of this report is to assist TV station owners, managers and engineers to plan for the transition to advanced television. The report details four phases for conversion from NTSC to ATV:

Phase	Capability
1	Pass-through of ATV programming
2	Add local commercials
3	Add local programming
4	Full ATV operation

Estimates put the cost of implementing phase 1 and 2 at approximately \$1.7 million for a typical middle market station. ATV will be transmitted in a second 6MHz channel created from within the current UHF spectrum. Initially, only existing broadcasters may apply for a second channel. Broadcasters must apply within three years, and then they have six years to reach this pass-through point. After that, channels not applied for will be open to all applicants. After year seven, broadcasters must simulcast 50% of their programming, with 100% being simulcast after nine years.

Simulcasting is defined as broadcasting the same material, except commercials and promotions, on both channels within a 24-hour period.

Broadcasting ATV

The FCC's construction requirement

Chan is principal of Chan & Associates, a marketing consulting service for audio, broadcast and post-production, Fullerton, CA.

does not go beyond phase 1. It appears that simply emitting a signal conforming to the broadcast ATV standard would satisfy the requirement. Broadcasters will be required to provide local station identification and be able to provide emergency messages. It is assumed that once the FCC reaches a decision, major programming distributors will begin to distribute ATV programming over their satellite networks.

Passing these signals through the facility to an ATV transmitter would be the simplest way to get on the air with ATV programming. During phase 1, broadcasters may also choose to upconvert existing NTSC programming for broadcast on the ATV channel. Later, as simulcasting is required, stations could downconvert ATV for use on the NTSC channel.

recording and playback facilities could be added, mainly for commercial insertion, but also for programming flexibility.

In order to develop these estimates, certain assumptions were made about existing facilities, including:

1. Existing tower has sufficient capacity to support a new antenna and transmission line, so a new tower would not be needed.
2. Current facility has sufficient capacity for new equipment, so additional racks, floor space and cooling would not be required.
3. Stereo audio facilities already exist.

The coming of ATV

The decoupling of the transmission and production standards of ATV offers several

Subsystem	Cost ranges (Thousands)
Satellite receivers, demodulators, decoder	\$13.5
Character generator/still-store, 28" monitors (2)	\$200
Routing switcher (10x10), master control	\$125
2 ATV VTRs and monitors	\$170
NTSC upconverter, line doubler/tripler	\$19-\$24
ATV-to-NTSC downconverter	\$15-\$20
34" monitor, 17" monitors (7), decoders (8)	\$110-\$119
ATV encoder	\$200-\$280
STL subsystem	\$92.5
ATV modulator, ATV exciter	\$30-\$35
ATV transmission subsystem, including:	\$275.5
ATV transmitter (\$300)	
Transmission line, antenna (\$30C)	
Off-air monitoring and test equipment (\$125.5)	
Total:	\$1,700.5-\$1,804.5

Table 1. Phases 1 and 2 and the cost to broadcasters to implement ATV.

Equipment will have to be purchased to begin implementation of phase 1. A satellite receiver, demodulator and decoder would be used to acquire ATV programming. A small routing switcher (10x10) would distribute the signal, and possibly a master switcher would be used to switch it into the STL. The current STL could possibly multiplex NTSC and ATV, or another STL might be needed for the ATV link. At the transmitter site, an ATV modulator, exciter, transmitter, transmission line and antenna would be added to current transmitting equipment. Stations also would need additional HDTV monitors and test equipment. Depending on individual needs, as stations enter phase 2,

advantages to the broadcaster. They will be able to choose a production format, independent of the broadcast standard. This will allow broadcasters to continue to use and upgrade existing facilities without the fear that tomorrow they will be unusable. Plans and purchases also can be made today that can be integrated into tomorrow's HDTV facility. When the FCC makes a decision on an ATV system, broadcasters can be ready. Current production equipment need not be discarded, but simply integrated into the broadcast system.

Acknowledgment: Thanks to the Association for Maximum Service Television, Inc.

CERAMIC ARMOR

METAL

PARTICLE TAPES

**In Your
Hands
Our
Science
Turns
To Art**

Let your imagination soar!
With Maxell Ceramic Armor Particle
Tape Products, you'll have total
creative control, combining
great versatility, tremendous
reliability and incredible output.
Available in D-2, D-3, DAT,
HD Digital 1" & Betacam SP.
They are the tapes of tomorrow, produced for you, TODAY.

maxell®

Maxell Corporation of America
22-08 Route 2C8, Fair Lawn, New Jersey 07410
1-800-533-2836

Maxell Canada - 105 Sparks Avenue, Willowdale, Ontario, Canada M2H 2S5, (416) 499-5044



Circle (8) on Reply Card

re: Radio



Digital radio progress at NAB '93

By Skip Pizzi, technical editor

For the past few years, semi-annual milestones in the digital radio environment have been provided by the NAB spring convention and the fall NAB Radio show. NAB '93 was no exception, with several significant events defining new territory.

IBOC developments

In-band/on-channel (IBOC) formats were displayed and demonstrated on-air by USA Digital, in its *Acorn FM* and *Acorn AM* systems. The FM-IBOC system was featured in a broadcast test as it was in New Orleans for the NAB Radio '92 show last September. A planned mobile demonstration of the FM system was not presented because of last-minute hardware failure in the prototype mobile receiver. The failure was apparently precipitated by difficulties in the power supply to the mobile receiver.

The Acorn AM system was demonstrated over the air in a true on-channel form for the first time.

The demonstration used an unoccupied AM tower several miles north of the Las Vegas Convention Center for an omnidirectional 200W AM broadcast on 1,660kHz (in the as-yet-unoccupied expanded band). The same audio program was simulcast in standard analog AM and digital IBOC-AM forms on the channel. The digital signal's multiple carriers were placed approximately 25dB below the AM carrier, putting their effective power at 8W to 10W. Although the system's processing delayed the digital signal by several seconds behind the analog (making direct A/B comparison a bit difficult), the digital AM signal exhibited high-fidelity audio (15kHz stereo, 96dB S/N), greatly improved over the subjective quality of the analog AM signal. A single, fixed receiver was available for auditioning the digital signal, but the analog signal could be heard on any expanded-band AM receiver.

Unlike the Acorn FM system (see "re: Radio," December 1992), the Acorn AM design uses the same transmitter for analog and digital signals, thus simplifying transition and reducing implementation costs. The current design goal is to make the Acorn AM system's encoder/exciter a direct plug-in replacement for an AM station's existing C-QUAM exciter.

The Acorn AM system includes active RF equalization and digital noise blanking. It also allows for eventual termination of the standard analog AM signal on the channel and retention of the digital signal without difficulty (unlike current plans for the FM system).

USA Digital hinted that at least some existing FM transmitters might be modified to allow their use for IBOC-FM broadcasts. This would eliminate the need for a low-power and linear second transmitter (plus RF combiner) as employed in the Acorn FM system.

The only other digital radio proponent identified with IBOC system design is Amati/AT&T. This proponent did not demonstrate a system at NAB, but presented a paper detailing its approach. The Amati/AT&T system is IBOC in only the broadest sense. It uses just the fringes of an active FM channel's bandwidth, without the complex signal extraction techniques that lie at the heart of the Acorn system. The Amati/AT&T format can more readily be applied as an interstitial (or adjacent-channel) FM in-band system, where it provides a highly flexible approach. Amati/AT&T's development of an IBOC-AM system was rumored at the show, although there was no confirmation.

New band systems

Two presentations at NAB '93 shed light on *new band* (NB, or *out-of-band*) digital radio systems. The first reported Canadian progress with single-frequency network (SFN) tests of the Eureka 147/DAB system at L-band frequencies. These tests involved two co-channel transmitters separated by approximately 80km (in Toronto and Barrie, Ontario). They mapped the coverage for fixed and mobile reception between the two transmission sites. A guard interval (or blanking period) optimized for SFN application at L-band was used, and mobile reception in the crossover area between the two locations along a radial line between the two sites was examined. Results met or exceeded predicted expectations. Canadian SFN tests will continue, with the planned addition of more overlapping, co-channel transmission sites.

Development status of the NASA/VOA

direct broadcast satellite radio (DBS-R) system also was presented. Work is progressing on the design of a modular receiver for narrowband-channel use at L-band, S-band or even in-band frequencies. Tests will be conducted later this year using a NASA satellite that operates space-to-earth spot beams at frequencies close to the U.S. S-band digital radio spectrum. (See "re: Radio," March 1993.) Some building penetration is expected, using small set-top antennas. Space-diversity reception may be required.

Progress on U.S. testing

With the EIA/NAB tempest over digital radio format testing essentially settled in the form of joint NRSC/EIA tests (see "News," May 1993), the atmosphere was primed for reports on the planned tests. Two papers at NAB '93 considered this topic — one discussed the revised digital radio format testing criteria and the other described the location and logistics of upcoming EIA multipath tests. The latter will be conducted at the Charlotte, NC, test site to be used for ATV tests, in the VHF-TV Channel 6 spectrum (85MHz). A 4MHz-wide pseudorandom noise source will be used as a test signal, with sampling of received signal level tentatively planned to be taken at 0.1 wavelength spacings. Horizontal and vertical polarization data will be recorded separately (and nearly simultaneously) at each test point. The data will be applied to multipath simulation programming for lab tests of proposed digital radio formats.

Another paper described multipath as a statistical phenomenon, requiring specific and massive testing to characterize it properly. The report examined the physics and research of multipath, and lamented the lack of multipath test data in the VHF band. This presentation further underscored the value of the upcoming EIA multipath tests.

The activities at NAB '93 indicated that the radio industry is moving steadily, yet prudently, forward toward digital delivery. With signposts such as these meetings to guide the way, broadcasters can follow the transition process closely and carefully.

MAKE A CLEAN SWEEP WITH PORTABLE ONE



Replace the clutter on your audio test bench with the Portable One *Plus* from Audio Precision. With one instrument you can make 12 different audio measurements. All in a test set designed from the start with 2 channel level, crosstalk and phase measurement capability.

Use the unique AC Mains check function for monitoring power line problems and the built-in wow & flutter meter for measuring analog tape & disc.



The Portable One *Plus* is built to Audio Precision performance and durability standards... so you know you'll get the same superior performance in the field as on the bench.

Clean sweeps are a breeze with the graphic sweeping capabilities of the Portable One *Plus*. Plot amplitude or level (stereo), phase or distortion versus frequency.

The graph may be rescaled after a sweep, and the graphic cursor with numeric readout gives you data readings for each measured point.

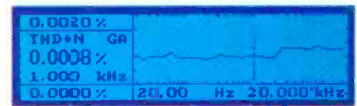

Connect a dot matrix printer for hard copy printouts of both graphs and tabular data, as well as instrument panels and bargraphs.



The Portable One *Plus*... the single instrument solution for both your bench and portable audio testing.



Circle (9) on Reply Card

INTERNATIONAL DISTRIBUTORS: Australia: IRT Electronics Pty. Ltd. Tel: (61) 2 439 3744 Austria: ELSINCO GmbH. Tel: (43) 222 812 1751 Belgium: Trans European Music NV. Tel: (32) 2-466 5010 Bulgaria: ELSINCO, P. e. Strelbishte. Tel: (359) 92 581 698 Canada: GERRAUDIO Distributor. Tel: (416) 696-2775 China, Hong Kong: A.C.E. (Int'l) Co., Ltd. Tel: (852) 424-0367 Czechoslovakia: ELSINCO GmbH. Tel: (43) 222 812 1751 Denmark: nbn Elektronik aps. Tel: (45) 86 57 15 11 Finland: Geratec OY. Tel: (358) 77 13311 France: ETS Mesureur. Tel: (33) (1) 45 83 65 41 Germany: RTW GmbH. Tel: (49) 221 70 91 30 Hungary: ELSINCO KFT. Tel: (36) 112 4854 Israel: Dan-El Technologies, Ltd. Tel: (972) 5-544-1466 Italy: Medea S.r.l. Tel: (39) 24840 1780 Japan: TOYO Corporation. Tel: (E1) 3 5688) 6800 Korea: Myoung Corporation. Tel: (82) 2 784-9942 Malaysia: Test Measurement & Engineering Sdn. Bhd.. Tel: (60) 3 734 1017 Netherlands: TM Audio B.V. Tel: (31) 034 087 0717 New Zealand: Audio & Video Wholesalers. Tel: (64) 7 847-3413 Norway: Lydconsult. Tel: (47) 9 13 03 81 Portugal: Acutron Electroacustica LDA. Tel: (351) 1 9414087 / 9450862 Poland: P.H.J. INTERLAB. Tel: (48) 22 335 454 Singapore: TME Systems Pte Ltd. Tel: (65) 298-2608 South Africa: SOUND FUSION. Tel: (27) 11 477-13 65 Spain: Telco Electronics. S. A. Tel: (34) 1 531-7101 Sweden: Tal & Ton Elektronik AB. Tel: (46) 31 80 36 20 Switzerland: Dr. W.A. Günther AG. Tel: (41) 1 910 41 41 Taiwan: ACESONIC Int'l Co., Ltd. Tel: (886) 2 716-6886 United Kingdom: SSE Marketing Ltd. Tel: (44) 71 387-1262

Audio precision

P.O. Box 2209, Beaverton, OR 97075-3070
(503) 627-0832 FAX: (503) 541-8906
US Toll Free: 1-800-231-735C

Management for Engineers

The thinking worker

What kind of employees do you need?

By Judith E.A. Perkinson

Many manager's jobs would go much smoother if they knew how to bring out the best in their employees and make them thinking workers. Thinking employees can contribute positively to the workforce and enhance job performance. This 4-part series will take a look at how managers can provide the type of work environment that helps productive, thinking workers thrive.

Managing your employees

John just spent two days undoing the damage of his technician who should have foreseen a problem but didn't. The small problem then became a major incident, resulting in equipment damage and major downtime. John knew he would be in trouble with his boss and bemoaned the fact that he couldn't find a decent employee. He couldn't understand why his staff didn't take pride in their work, didn't seem to care, and didn't use common sense to avoid problems. John wondered what in the world had happened to the work ethic.

Well, John has the workforce he deserves. They are a product of his management style. John's management technique is from the old school. He knows only how to boss his employees, not how to manage them.

The chief engineer must be a team leader and develop a work environment in which a thinking worker can exist and thrive.

When John was moving up in the job ranks, he did what he was told and didn't question his supervisor. That approach to management worked when the world was simpler, and before the technological revolution. In the early days, technicians and operators were little more than arms and legs on machines that were coordinated

Perkinson is a senior member of the Calumet Group Inc., Hammond, IN.



by a boss. Now engineers and technicians need to do more and be more. They must be thinking workers.

Thinking workers need a leader

The technology of radio and TV stations has changed drastically. Equipment is more sophisticated and stations are cutting back on the number of personnel. This has increased the workload, and employees are expected to be multidimensional with multiple skills. These changes affect the way that managers must approach the task of managing their employees and their workload. Being knowledgeable in maintaining equipment is not enough. Having the greatest number of years of experience is not enough. Now the chief engineer must be a team leader and develop a work environment in which a thinking worker can exist and thrive.

When managers feel that they have to make all of the decisions and be in control, because they are in charge, they're setting themselves up for frustration, overwork and disappointment. Managers can be more effective when they learn to tap into the knowledge and reasoning abilities of their employees, delegate responsibility and share the decision-making and problem-solving.

What do you want from your employees?

It's time to take stock of what you need and want from your staff. Good work habits, such as showing up to work on time and staying until the job is done are not enough. More important than being there is the quality of the job performance.

It's important for employees to be cooperative and follow instructions. But there are times when employees need to feel free to ask questions and come up with solutions in order to contribute to the decision-making and problem-solving efforts.

The choice is yours

Many managers continue to hold on to the management style of "being the boss" because they do not know how to change, don't want to change or are afraid to

change. It's not an easy transition. Our management styles are often modeled after the people who managed us. Unfortunately, we pick up good and bad habits of those models. If you have never worked in a participative work environment, it is hard to know where to start.

If you want to create a positive working environment, you need to prepare your workforce to think and work together as a team. Next month's column will focus on creating that team environment.

Do you have a management question?

Since 1986, the "Management for Engineers" column has addressed the kinds of problems faced by new supervisors and technical managers. The solutions provided have helped thousands of *BE* readers become better managers and advance personally and professionally. Now we'd like to do even more.

Fax your management questions to *Broadcast Engineering* magazine. Reader-provided questions and concerns will be selected as topics for discussion in upcoming columns. Neither the station nor the reader will be identified, so be as specific as possible in describing your dilemma. Reader questions selected will be addressed only in the column. No personal responses can be provided.

This is a chance to voice your management concerns and have them addressed in the "Management for Engineers" column.

Send your management questions to:

Via fax:
Management for Engineers
c/o of Editor
Broadcast Engineering magazine
913-967-1905

Mailing address:
Management for Engineers
c/o Editor
Broadcast Engineering magazine
9800 Metcalf
Overland Park, KS 66212

**OTARI'S NEW R-DAT:
PROFESSIONAL QUALITY WITHIN YOUR REACH.**



When you've had enough of unreliable "warmed-over" consumer decks, we've got a *professional* R-DAT for you at an affordable price.

Our new DTR-90 delivers the rock-solid reliability and superb sound that have made Otari audio machines the choice of professionals everywhere, and at the same time delivers all the performance and features you'll ever need.

For example, so you can make changes fast and easily, the DTR-90 is the only R-DAT available with individual record insert on Ch. 1, Ch. 2, and time-code channel. And its user-friendly front panel features an LCD screen that gives you powerful functions often relegated to DIP switches in other R-DATs—you can even detach the control section of the front panel and use it as a remote unit!

You'll also appreciate the optional Time-code Card with its chase synchronizer for tight lock with VTRs and ATRs, as well as features like read-after-write and punch-in, punch-out.

And if you need a complete electronic editing system, you can't do better than couple the DTR-90 with Otari's CB-149 editor for flawless digital editing.

For the complete story on this quality-built and affordable R-DAT, call Otari at (415) 341-5900.



Otari Corporation
378 Vintage Park Drive
Foster City, CA 94404
U.S.A.
(415) 341-5900
Fax: (415) 341-7200

Otari Corporation
U.S.A.
(415) 341-5900
Fax: (415) 341-7200

Otari Inc.
Japan
(0424) 81-8626
Fax: (0424) 81-8633

Otari
(UK) Ltd.
United Kingdom
(0753) 580777
Fax: (0753) 542600

Otari
Deutschland GmbH
Germany
02159 50861-3
Fax: 02159/1778

Otari Singapore
Pte., Ltd.
Singapore
(65) 743-7711
Fax: (65) 743-6430

Circuits

PLD basics

Logic description file

By John T. McGaughey

In the final part of this series on PLD basics, the system requirements (described in Part 3) will be translated into a logic description file.

At this point, the input and output signals have been determined and named. (See Table 1.) These signals are adequate to begin working on the logic equations section of the file. Although the actual levels required at each pin are not yet defined, they aren't needed to begin work on the equations. The actual levels at the pins as determined by external constraints will be handled in the pin declaration section. Figure 1 shows the four basic logic operators used in the compiler. Parentheses also are allowed to force evaluation of a logic expression in a particular way or to make the expression easily readable.

Network alarms

The first group of equations to be written involves the network alert alarm LEDs. Because all four will function identically, only one network alert will be examined. Recall in Part 3 that when a network alert alarm is active, the LED will flash. In addition, if a lamp test is requested, it should be turned on steadily. The first equation in Figure 2 describes this action for the network alert 1 LED. The term in parentheses causes the LED to flash when the network alert 1 alarm is active. This is logically *or'd* with the lamp test to keep the LED on continuously when requested.

McGaughey is an instructor at the University of Georgia Center for Continuing Education, Athens, GA.

INPUTS	OUTPUTS
Pin 1 = Network_Alert_1;	Pin 16 = Network_Alert_1_LED;
Pin 2 = Network_Alert_2;	Pin 17 = Network_Alert_2_LED;
Pin 3 = Network_Alert_3;	Pin 18 = Network_Alert_3_LED;
Pin 4 = Network_Alert_4;	Pin 19 = Network_Alert_4_LED;
Pin 11 = Network_Alert_1_EN;	Pin 15 = On-Air;
Pin 13 = Network_Alert_2_EN;	Pin 14 = Audio_Alarm;
Pin 21 = Network_Alert_3_EN;	
Pin 22 = Network_Alert_4_EN;	
Pin 5 = EBS;	
Pin 6 = Mic_1;	
Pin 7 = Mic_2;	
Pin 8 = Mic_3;	
Pin 9 = Flash;	
Pin 10 = Lamp_Test	

Table 1. The input and output signals for the logic compiler.

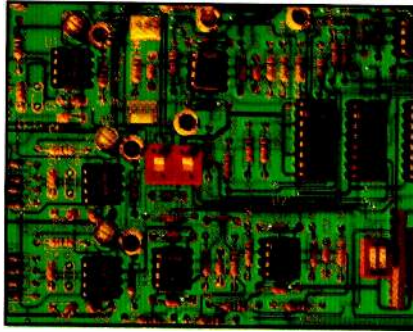

```

NETWORK_ALERT_1_LED = (NETWORK_ALERT_1 & FLASH)
                        # LAMP_TEST;

MIC_ACTIVE = MIC_1
             # MIC_2
             # MIC_3;

AUDIO_ALARM = (NETWORK_ALERT_1 & NETWORK_ALERT_1_EN
              # NETWORK_ALERT_2 & NETWORK_ALERT_2_EN
              # NETWORK_ALERT_3 & NETWORK_ALERT_3_EN
              # NETWORK_ALERT_4 & NETWORK_ALERT_4_EN
              # EBS
              # LAMP_TEST)
              & IMIC_ACTIVE;

ON-AIR = MIC_ACTIVE
         # LAMP_TEST;
    
```

Figure 2. The final logic equations for the audio alarm and on-air outputs.

The other three equations are identical in form, but simply use their respective input and output signal names.

The next step involves generating the enable signal for the sonalert system. The specifications for this section are more complex than the LED drive but can be described fairly easily. First, consider that, in general, the alarm will sound if any of the network alert alarms are active unless masked. Next, if the EBS input or lamp test is active, the alarm should sound. However, if any microphones are active, the alarm should not activate because the sound will be broadcast.

The compiler allows creation of logic equations that are not assigned to specific pins. These are called intermediate variables, and they allow complex expressions

to be broken down into smaller parts. An intermediate variable called MIC-ACTIVE is created as shown in Figure 2. It will be active if any microphone is on. In this way, the intermediate variable can be used in other equations. Figure 2 shows the final equations for the audio alarm and on-air outputs. The intermediate variable appears in both equations.

```

# OR
& AND
! INVERSION
$ EXCLUSIVE OR
    
```

Figure 1. The four basic logic operators used in the compiler.

What if it is necessary at this point to add an unforeseen input to the system, such as from a weather alert radio? If this is a TTL-based design, the equation may have to be started over. Because two extra pins are available on the PLD, one for the input and one for the LED, the only change requires adding a new equation and changing another.

A good question to ask is how much was saved by using a PLD over a gate-based design? By reverse-designing the system in TTL, seven IC packages were needed before the change and nine afterward. This results in a smaller and easily constructed system with greater reliability. ■

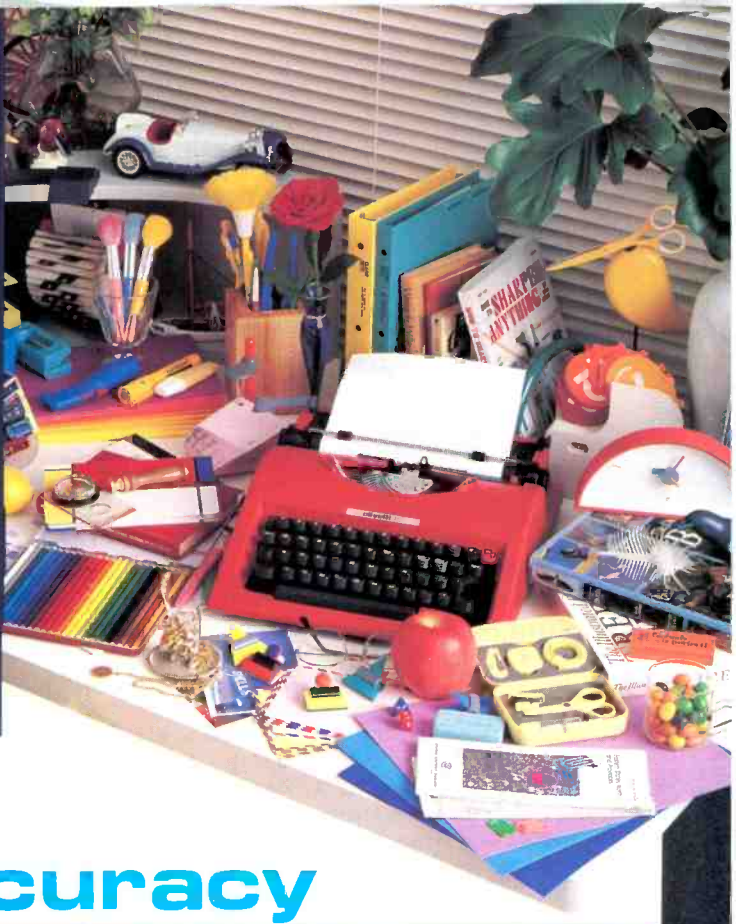

No One Measures Up To ShibaSoku® Accuracy

Designing and producing superior test instruments that are the industry's measure for accuracy

Performance engineering is clearly seen in ShibaSoku's CM205N Auto Setup Color Monitor. It reproduces images with the highest Color and Luminance Fidelity, but never adds or masks even minor video defects.

Only True NTSC Monitor

Utilizing Test and Measurement expertise, **ONLY ShibaSoku manufactures monitors to true NTSC specifications.** The NTSC Decoder uses I/Q Chroma Demodulation, tuned to Human-Eye color perception, for richer, more accurate Chroma saturation with less cross-color noise. The 205 has excellent Luminance Frequency response and uses a 0.28mm Dot Pitch, 20" Precision In-Line Dot CRT, able to display over 900 TV lines with Adjustment Free Convergence, accurate to $\pm 0.2\text{mm}$.

Auto Setup—Plus

ShibaSoku's Auto Setup system provides acute accuracy and longer-term color temperature stability with impeccable chromaticity reproduction, to ± 0.002 points on the CIE x/y scale — accurate as the best color analyzer. Unlike other systems, the Optical Sensor and CPU circuitry reduce measurement errors from compensation adjustments and eliminate optical filters in the probe. Auto Setup operation is executed with an internal CAL signal generator. Five Color temperature memories store Contrast and Brightness data, the R,G,B Gain and Bias levels. Manual Front panel controls have Preset, UNCAL switches for two

separate settings without using Auto Setup. High Voltage Beam current detection circuitry ensures better Luminance stability plus higher luminance performance (to 88fL).

Standard Features/Options

- + 3 Composite Video inputs
- + Component and RGB inputs
- + Y C input
- + D1 Component Digital Option
- + D2, D3 Composite Digital Option
- + Auto Setup on any Input Signal
- + PAL Decoder Option
- + Dynamic Double Focus system
- + Wideband CCD Comb filter
- + 3 Line Comb filter
- + High Voltage Protection
- + HV Stand-by function (Saves CRT life)
- + Power supply monitoring & protection
- + Sync, Burst circuit monitoring
- + Automatic Degauss operation
- + Chroma Gain compensation circuit
- + Variable Aperture compensation
- + Color/Mono Split Screen function
- + Independent Preset UNCAL switches
- + Residual Subcarrier indication
- + H/V Pulse Cross modes

Full Line of Companion Models

The Multi-standard CM206N (900 TV line CRT) is capable of a combination of 3 decoders: NTSC, PAL, SECAM. D1, D2 and D3. Auto Setup is optional in addition to the decoders. Other Auto Setup models include: the 20"

CM201N, 14" CM141N, and Multi-standard CM202 and CM141, all 700 TV line CRTs.

Lasts Too Long

ShibaSoku's monitor design philosophy, anchored in Test and Measurement precision, is dedicated to giving video pros the means to inspect a video signal for ANY flaws or errors. There are many picture monitors, but only one line of Reference Quality monitors offers years of reliable, stable service. You get longer-term stability, sharper focus and resolution, and higher luminance control, which truly let you see what you've been missing in your video signal. Optimum ShibaSoku performance is demanded by top professionals. In fact, some users report having our monitors On-line for over a Decade. It seems the only way to get a new one into service is by engineering the Advancements you need.

Find out more about the monitor that lets you see what you need to see — circle the reader service card number below.

Visit Booth #16619 at NAB '93

ASACA®

Asaca/Shibasoku Corporation of America
12509 Beatrice St., Los Angeles, CA 90066
(310) 827-7144 FAX (310) 306-1382

Circle (11) on Reply Card

Troubleshooting

Care and feeding of coaxial transmission lines

Transmission lines

By Dean W. Sargent

Now that your system has been installed and it can be pressurized, it's ready to go on the air, right? Not yet. That line has been in all kinds of places and weather conditions since it was made and installed. It is full of unwanted air. For years, engineers have put dry nitrogen in the line, thinking it would soak up the contaminants. It was just a matter of opening a valve on the antenna or cracking a flange and letting the dry nitrogen run through for a little while. However, that won't get the job done right.

Moisture, and whatever else is in the atmosphere, will "hide" in all kinds of places inside a line, especially at connectors and insulators. A better approach is to put a vacuum pump on the system and evacuate it to approximately 24 inches of mercury. The pump should run all day. Without opening the system to air, close the pump and open the line to a nitrogen supply. It is surprising how much nitrogen the line takes when there is nothing else in it.

Figure 1 shows a gassing system. This system uses a gas barrier at the top of the vertical run as well as the usual one in the input of the line. The top gas barrier is located just before the elbow complex. It will allow the line to be opened at the complex for termination purposes without losing pressure in the main line.

The gassing system

The copper tube at the top will allow the upper section and the antenna to be re-evacuated and then re-pressurized after measurements are completed.

When the gas barrier is installed at the top of the vertical run, a section of transmission line should be placed approximately one foot long between it and the elbow complex. This will allow you to remove the elbow complex without having the gas barrier coming apart.

So, why is a separate copper tube run from the top? Why not just evacuate everything? The answer is *time*. It takes a long time to evacuate a long transmission line, but a relatively short time to evacuate only the antenna.

It is possible for a component to be

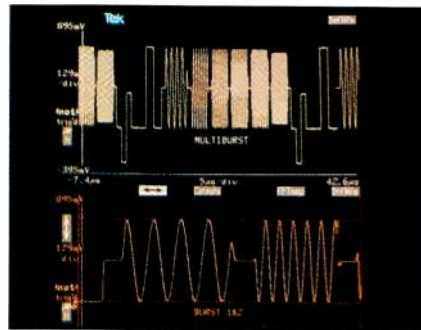

faulty and cause a line to be destroyed, but this is extremely rare. The majority of all line failures are a result of contamination. Few line failures are the result of lightning, and these are usually near misses, not direct hits. The best insurance policy is to keep the line clean and use only dry nitrogen.

Another common question: "How often should I change a bullet or a watchband spring?" It all depends on how much power is being run, how often the transmitter is turned on and off, ambient temperature differential (both cause expansion and contraction of the inner on the bullet or spring), and whether the line is contaminated. If the history of the line is not

known, it's a safe bet to have it changed every 10 years.

It is rare to have a line fail in less than 10 years. Many lines will last for 15 or 20 years. If maintained properly, the watchband spring or bellows line should last indefinitely. If the line is opened for any reason, the O rings should be changed.

When installing new line with spring hangers, the hangers should be properly tensioned or there will be problems down the line. Springs are tensioned with temperature and line length considered. Make a board of the proper spring length and use it to set each spring. That way all springs will at least be tensioned the same.

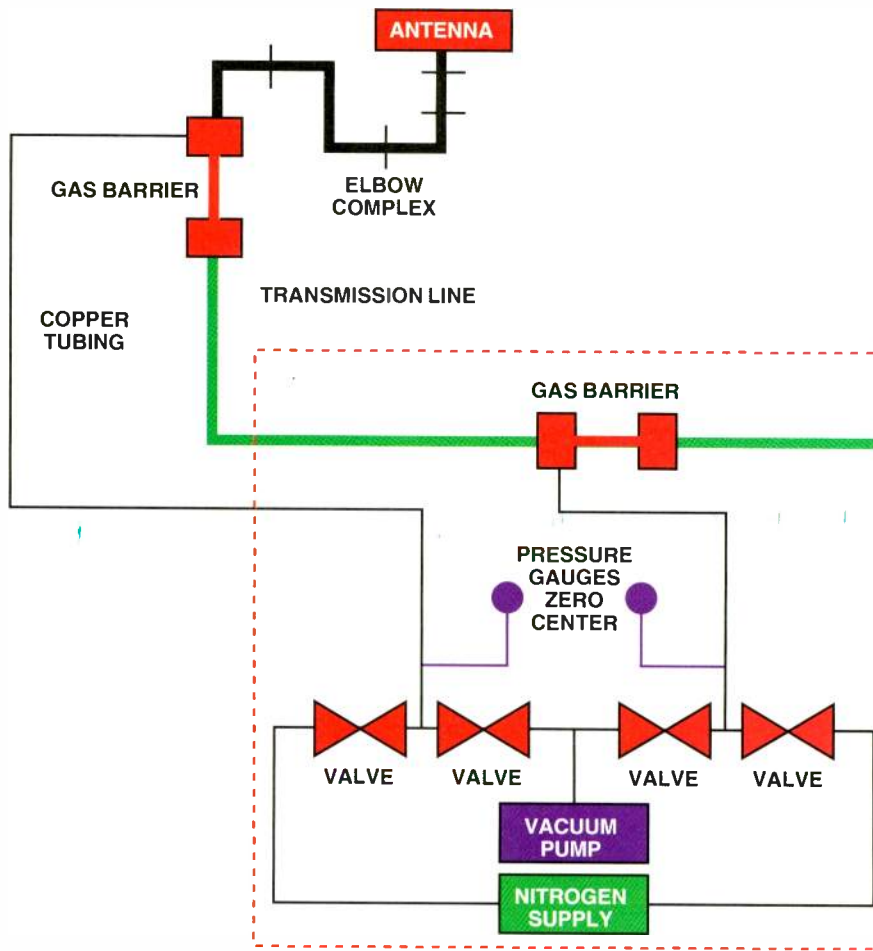

Figure 1. Transmission line and antenna gassing system.

Sargent is president of D.W. Sargent Broadcast Service, Inc., Cherry Hill, NJ.



Make Waves.

Actual Photo From SuperWarp™ Effect

With SuperWarp™, a new option for the Abekas A51+ Digital Special Effects System. Or try a burst. Slats. An oil drop effect. Even dual-sided page turns with one channel.

SuperWarp™ lets you create sophisticated images that used to require a high-end effects machine.



And you get all the control and flexibility that you need. So now you can give your clients a spectacular range of effects. At a price that won't sink your budget.

Abekas

A Carlton Company
A DECADE OF DIGITAL

For Details: 415-369-5111 • Atlanta 404-451-0637 • Chicago 708-699-9400 • Dallas 214-385-4544 • Los Angeles 818-955-6446 • New York 516-939-9000 • San Francisco 415-369-6791

Circle (12) on Reply Card

Technology News

Super LCDs and IC cubing

By Curtis Chan

Flat-panel displays and integrated circuits have been the subject of technological investigations and international sanctions. The potential market for low-cost, high-resolution, flat-panel displays and dense, low-cost ICs is staggering. This month's column centers on two recent advances in flat-panel liquid crystal display (LCD) and IC development.

Faster, denser, high-resolution LCDs

Low cost, high-resolution flat-panel color and gray scale LCDs have been produced using a new fabrication process similar to standard semiconductor processing techniques. The displays will start with a 640×480 pixel LCD followed by a 1,280×1,024 pixel version. Standard IC fabrication techniques are used to place control transistors for the LCD pixels onto a silicon wafer. This is in contrast to the factories needed for thin-film transistor fabrication on glass, currently used for active-matrix flat-panel displays.

The 2-step process involves taking the top layer of an IC wafer (3μm - 5μm thick), with the thin-film transistors on it, and placing it on a piece of glass. The glass subassembly is then assembled into a flat-panel LCD. In contrast, the normal production method involves growing silicon on glass, in a process similar to *epitaxy* (a process of growing one crystal layer upon another).

Epitaxially grown silicon is amorphous. It provides no regular crystalline orientation on which to base the growth of the new silicon layers.

The mobility of electrons in amorphous silicon is about $1/500$ of the electron mobility in single-crystal silicon (used for standard IC wafers). Thin-film transistors grown in single-crystal silicon are 500 times faster than those grown in amorphous silicon. LCDs made from this process will be fast enough to display video-rate information without ghosting or showing artifacts common with present LCD technology.

Another benefit of having the transis-



tors fabricated on normal single-crystal silicon wafers is that it yields displays with 500 lps (lines-per-inch resolution), approximately five times greater than standard LCDs. The next goal is to attain 1,000 lps, putting the displays into ATV/HDTV territory. The final benefit is low cost. Because they can be produced in any IC fabrication house, the overall cost of the displays will be significantly reduced.

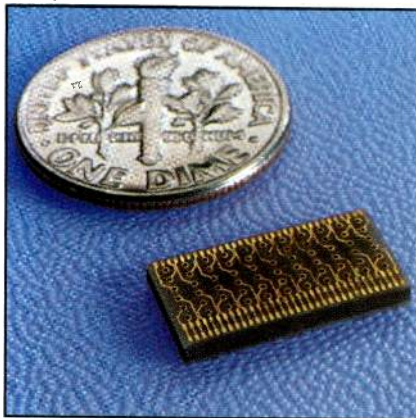

A 3-D memory short stack, 4Mbit 512K×8 SRAM built using IC cubing techniques. (Photo courtesy of Irvine Sensors Corporation.)

IC cubing

IC manufacturers and designers have been plagued with the problem of reducing distances between and inside chips. Doing so would offer faster processing speeds, higher integration levels and lower power requirements. A process called *cubing* has been developed that dramatically reduces board real-estate. Using this technique, an IC stack the size of a sugar cube can replace a PC's main motherboard.

This 3-D cubing process dates back to the early '80s in a joint DARPA (Defense Advanced Research Projects Agency) project. The project's aim was to speed signal processing and reduce interference while reducing weight and volume. The 3-D stacking was explored as an efficient alternative to existing planar IC packaging.

A stacking technique that assembles IC wafers thinned to as little as 0.2mm and extremely thin layers of laminate is used. The configuration increases density and

thermal conductivity. Reliability is improved by eliminating most of the interconnect junctions. Putting the chips closer to one another shortens the signal line, reducing capacitance and minimizing I/O drive currents. The benefit of the cubing process is higher throughput and reduced manufacturing costs because of the elimination of several levels of packaging.

Two cubing varieties have been developed: full stack and short stack. In full stacks, as many as 100 chips are mounted in a $1/2$ -inch-high cube. Short stacks contain up to 10 chips. A 3-D memory short stack 4Mbit SRAM (static random-access-memory) package measuring 7.1mm×13.7mm and 1.5mm high has already been produced. Further developments target reducing parallel processing modules to the size of a microcassette and offering packaged and unpackaged designs. The unpackaged stacks will affect hybrid multichip modules and chip-on-board packaging techniques.

Benefits galore

Benefits to broadcasters are numerous. Manufacturers will be able to take advantage of reduced board space and increased processing power. The increase in processing power, coupled with increased capability and lower-priced memory stacks, may significantly enhance onboard intelligence. Such features as interactive intelligence, enhanced diagnostics and internal add-on options are possible. Production workstations could have near-supercomputer processing capabilities with dramatic increases in memory capacity for a fraction of the cost.

These two technologies are nearing commercial viability at a time when broadcasters are looking toward HDTV. The potential size and weight reductions offered by super LCDs and IC cubing could have an impact on the design, manufacture and cost of future HDTV equipment. Cost savings to broadcasters and their audience could mean HDTV becomes a reality even sooner than predicted.

Acknowledgment: The author would like to thank these two companies for their assistance: Kopin Corporation, Taunton, MA, for LCD technology and Irvine Sensors Corporation, Costa Mesa, CA, for 3-D cubing.

Chan is the principal of Chan & Associates, a marketing consulting service for audio, broadcast and post-production, Fullerton, CA.



YOU NO LONGER HAVE TO BE AFRAID OF THE DARK.



INTRODUCING JVC'S REVOLUTIONARY KY-27 2 LUX CAMERA.

JVC[®]
PROFESSIONAL

Every once in while a new video camera comes along that will set the standards by which all other cameras of its type will be measured against.

JVC presents its low-light, 2/3" 3-CCD, high resolution KY-27 video camera.

The KY-27 features JVC's exclusive LoLux technology, which enables the camera to shoot in available light as low as 2 Lux. The latest in the long line of technological firsts from JVC, LoLux combines 24dB of electrical gain with an additional 6dB, which is produced by JVC's unique CCD pixel readout system, for a total of 30dB. All without the noise and picture degradation normally associated with this degree of gain.

In addition to 750 lines of horizontal resolution and 62dB signal to noise ratio, the KY-27 boasts a full range of automatic features, such as enhanced ALC, Full-Time Auto White and Full Auto Shooting. And the camera performs equally well when docked to your favorite VTR, or in stand-alone ENG and studio configurations.

Once you're armed with the KY-27 you'll never be afraid of shooting in low-light conditions ever again.

For additional information please visit your JVC dealer or call
1-800-JVC-5825.



Circle (14) on Reply Card

From the show floor:

NAB took the high road this year with record attendance, buying fever and more new products than ever.

By Brad Dick, editor



A perspective

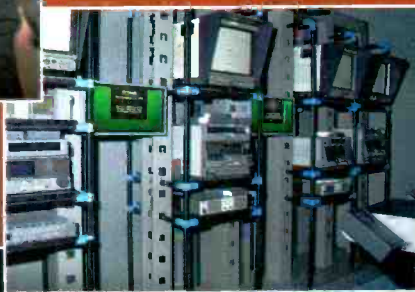

I recall the excitement that used to accompany a trip to the NAB convention when AM stereo was the hot issue. That controversy faded and then there was LPTV. Recently, HDTV has been a primary focus for attendees. The technical and political posturing that accompanies these and other advances are always fun to cover.

This year's NAB was different on several fronts. First, an attendance record was set with more than 64,000 rallying at the Las Vegas Convention Center. Second, the three giants in the VTR business rolled out their wares for battle on the tape format front. Third, the addition of the multimedia exhibition gave an additional flavor to the overall show. For most attendees, the multimedia exhibition had little to do with their jobs. After all, isn't multimedia something used in the latest Sega or Nintendo game? Not so, according to multimedia proponents. If you believe their scenarios, broadcasting will either become a provider of multimedia entertainment or as obsolete as the dinosaur.

Finally, widening evidence points to ATV as a reality in our lifetime. Manufacturers lined up to provide products to help in that transition.

THIS YEAR IN LAS VEGAS, NO ONE HAD TO GAMBLE ON THE FUTURE.

At Sony we deliver innovative products compatible with your needs today, as well as tomorrow. Proof is your response to the introduction of Digital Betacam® VTRs, which contributed to Sony's most successful NAB ever. Digital Betacam VTRs deliver the reliable, cost-effective digital component quality you want, while remaining compatible with analog Betacam – the format of choice in the broadcast and production community. So if you want to gamble, play blackjack. But for a sure bet on the digital component future, look to Sony. For more information call 1-800-635-SONY, ext. A500.

INNOVATION AT WORK.

ETTE RECORDER DVW-A500

Digital

SONY

BETACAM

Sony Business and Professional Group, 3 Paragon Drive, Mountlake, NJ 07645-1735. ©1993 Sony Corporation of America. Sony and Betacam are trademarks of Sony.



Coming in droves

Although the attendance set a record, it is not known exactly how many were traditional NAB attendees and how many came only because of the multimedia exhibition. It doesn't really matter, because this same successful package can be expected next year.

Attendees showed an upbeat mood as they toured the exhibition. Budgets were available for new products and many were buying right from the show floor. Exhibitor after exhibitor talked of selling products based on booth demonstrations. One exhibitor had to order replacement components because his systems were sold from under him. Not a bad way to finish the day.

The crowds concentrated on the exhibit floor. Although the session rooms had healthy attendance, it was the equipment that drew most of the attention. The air of buying was everywhere as exhibitors bragged of making sales and signing contracts.

Tape formats

The battle of VTR giants began on day one. Ampex, Panasonic and Sony each had new VTR technology. Traditionally, these companies arrange their press conferences to consecutively run on the same day. This allows the press to see the new products from all three companies in one day.

On Sunday, Ampex, Panasonic and Sony offered their solutions to today's and tomorrow's videotape recording needs. Although Ampex officially unveiled its DCT digital component production system at last year's NAB, working systems did not appear until last summer's IBC Convention in Amsterdam. The demonstrations at

this year's NAB were convincing in that DCT really does work.

The machine will handle three sizes of cassettes, providing up to three hours of record time. It uses the 19mm, D-2 cassettes. One important feature is its ability, within seconds, to switch between 525 and 625 recording formats. According to company-provided information, DCT tape drives have already been sold to several production houses and are being well accepted. (For a complete description of the DCT drive, see page 68 in the February 1993 issue of *Broadcast Engineering*.)

The battle of tape formats from Japa-



nese-based manufacturers Panasonic and Sony got off to a rousing start on Sunday afternoon. Panasonic unveiled its long-talked-about and recently named tape format, D-5. The series of machines will record in three modes: 10-bit 4:2:2; 8-bit 13.5MHz; and 18MHz 16:9.

Sony unveiled its Digital Betacam format. The format launch includes four machines, two recorder/players and two players. One unique feature is that two of the VTRs are capable of not only recording/playing digital signals, but also playing back standard analog

Betacam tapes.

Compression headache

Of significance is the difference in Panasonic's signal compression compared with the Ampex and Sony approaches. The Ampex and Sony formats rely on some form of video signal compression before recording. The Panasonic format does not. Sony calls its scheme *coefficient recording*. (See page 160 in the March 1993 issue of *Broadcast Engineering* for a description of the Digital Betacam format.)

The area of video signal compression is not fully understood by many users. Certainly the mere fact that each of the companies has developed its own approach to recording the digital component signals is cause for careful study.

At each company press conference, questions dealt with the effects of compression. Would the viewer be able to see it? How many times could a signal be re-recorded before the compression artifacts became noticeable? The companies provided assurances that their approaches had none of the limitations for which video compression has been labeled. Or in the case of Panasonic, the assurance was that non-compression was the only safe approach.

Whether video compression equates to any quality degradation is a point the industry doesn't fully understand. Although the manufacturers may provide their positions on the compression issue, the users will ultimately decide whether compression is a factor in their selection of new tape recorders. Only time and the sale of machines will answer the question.

Multimedia invades NAB

The third unique aspect of this year's convention was the arrival of the PC and Mac computer types, otherwise known as multimedia. Although the exact definition of multimedia remains manufacturer-specific, the overall direction is clear. Multimedia represents the computer industry's version of tomorrow — which would be com-



Advanced wireless intercom system



Vega Q600

- Rugged, reliable, metal beltpack remotes
- Hybrid UHF/VHF operation to conserve scarce VHF frequencies
- Inexpensive VHF monitor receivers to lower system costs
- High-quality, low-noise, low-distortion audio
- Up to six beltpacks per master station
- Designed specifically for broadcast and production
- Directly compatible with all standard wired intercoms
- Many advanced circuit and system design features

In the studio or on the set, Vega's wireless intercom systems are the choice of professionals who demand ruggedness, reliability, broadcast-quality audio, and a full set of professional features. Designed from the ground up for broadcast and production work, the Q600 UHF/VHF system provides all the functions and technical capa-

bilities required for these demanding applications.

The Q600 system provides continuous, full-duplex, hands-off communications between up to six people plus an unlimited number of "listen-only" users.

The QTR-600 beltpack remotes are extremely easy to use and provide operation similar to that of hard-wired intercom beltpacks. They are compatible with popular dynamic or electret headsets, such as Beyer, Clear-Com, and Telex. The cases are welded aircraft aluminum alloy with a high-impact, molded Cylolac (ABS) control panel that will withstand the roughest use.

One QX-600 master station supports up to six QTR-600 remotes with "hands-free" two-way communications, and an unlimited number of PL-2 receivers for listen-only users. Circuitry is provided to interface external line audio with the system or to link two QX-600s into a 12-user system. The master station is directly compatible with all standard wired intercom systems such as Clear-Com, RTS, ROH, Telex, and many others via internal programming switches. A local headset position and extensive

control, adjustment, and monitoring provisions are also included.

The PL-2 VHF mini-receiver provides a high-performance, low-cost solution to providing one-way "listen-only" communications. Very often, individuals need to receive instructions but are not required to speak. Using PL-2 receivers for this application avoids the expense of additional full two-way remotes and can significantly lower the cost of a typical system. The PL-2 is fully compatible with the Q600 system and is designed to provide reliable communications in the most demanding RF environments.

When the job demands hands-free, full-duplex operations in the most demanding environment, go with the Vega Q600, the system recommended by professionals worldwide.

VEGA

a MARK IV company

9900 East Baldwin Place
El Monte, California 91731-2294
Telephone: (818) 442-0782
Toll-Free Telephone: 800-877-1771
Fax: (818) 444-1342
FaxBack: (818) 444-2017
Toll-Free FaxBack: 800-274-2017

Circle (15) on Reply Card

WANTED DEAD OR ALIVE:

YOUR OLD FM BROADCAST ANTENNAS

*Any Brand, Any Size,
Working or Not!*

Trade in your old antenna
and receive a discount on
the purchase of a new
JAMPRO

PENETRATOR Series

FM Antenna System

*Send us your rustiest,
crustiest, dustiest old
antennas.*

We'll take 'em all!



JAMPRO ANTENNAS, INC.

*When you want more than
just an antenna.*

6340 Sky Creek Drive
Sacramento, CA 95828
(916) 383-1177

Fax: (916) 383-1182

*Certain rules and restrictions apply.
Contact factory for details.*

Circle (16) on Reply Card

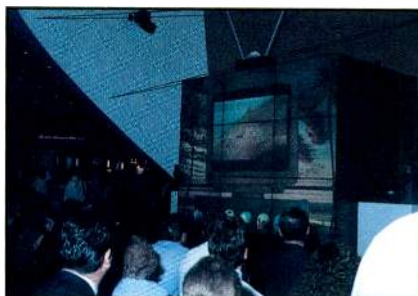

plete with interactivity, Windows-based features and more options than the average user will ever need.

Many attendees saw the multimedia portion of the convention as primarily a novelty, something interesting, but not directly related to what they did. Certainly many felt that multimedia applications were not directly related to the broadcast and production industries. Many also felt the multimedia hoopla was just that, and not of concern to their future. The multimedia exhibition hall was seen by some as a computer show floor for PC and Mac applications, with limited broadcast- and production-related applications.

Even so, at the Consumer Electronic Show this month, exhibitors are expected to release a wide range of hardware and software multimedia products. Interactive movies where you plot the whodunit scenario to music and huge database storage applications are but the tip of the multimedia iceberg.

Broadcasters need not think their futures depend solely on multimedia compatibility. Not everyone thinks the world of Windows-type applications, multimedia, CD-ROM and similar applications are going to eliminate the need for traditional broadcasting.

The crowds at the multimedia hall ranged from empty to semi-crowded. The broadcast attendees appeared to view the additional exhibition as more of a computer show than an industry-related exhibition. Although it certainly wasn't a computer flea-market atmosphere, the fit between multimedia and broadcast/production applications is not clear. There were true aficionados of the gee-whiz technology, but they were outnumbered by the pros in the other hall.

ATV in your future

The rumors of HDTV developments continue, but one aspect has not been lost on broadcasters. A second, and widely discussed, issue at this year's show was ATV. In other words, a digital transmission system capable of

How does your salary stack up against the competition?

If you're involved in determining salary compensation for broadcast personnel, you can gain valuable insight from the Salary Survey.

Arm yourself with all the facts by ordering the results of this survey for only **\$145**. This bound edition is filled with more than 125 pages of data, tables, graphs and charts detailing survey results.

You can purchase this valuable survey by calling Diane Mason at (913) 967-1735. MasterCard, Visa or American Express cards are accepted.

Or you can mail your check to:

Broadcast Engineering Salary Survey

**P. O. Box 12901
Overland Park, KS
66282-2901**

Please allow three to four weeks for delivery.

BROADCAST
engineering

There are just a couple of things we can't supply to broadcasters... buildings and voice talents.

Call AEQ and you will find almost everything you need for your local radio station or for your international broadcast network.

Our talented engineers can provide you with Systems Engineering Design, state of the art equipment, technical advice and, most of all, the expertise obtained through the set up of over a hundred radio stations using our own designed equipment over the last ten years.

Do not hesitate. Choose somebody who knows. Choose AEQ.

AEQ MP-10 Portable Mixer.
Allows program production and news report from anywhere with an available telephone line.

AEQ SYSTEL-3000 Multipoint Multiconference System.
Allows full duplex simultaneous intercommunication of up to 9 people.
Controlled via PC or through AEQ CR-01 remote control console.

AEQ TH-02 Digital Hybrid.
The ultimate solution to talk show problems.

AEQ BC-2000 Broadcast Mixing Console.
Complete Modular design. 18, 25 or 35 module versions.

- ❖ Power Amplifiers
- ❖ Digital Telephone Hybrids
- ❖ Frequency Line Extenders
- ❖ Distribution Amplifiers
- ❖ Broadcast Mixing Consoles
- ❖ Broadcast Portable Mixers
- ❖ Self Powered Monitors
- ❖ Line Amplifiers
- ❖ Line Equalizers
- ❖ "Turn-key" Projects
- ❖ ...and much more !



APLICACIONES ELECTRONICAS QUASAR, S.A.

HEADQUARTERS: C/ Rey Pastor, 36 - Pol. Ind. Leganés - 28914 Madrid - ESPAÑA - Phone: + 34 1 686 13 00 - Fax: + 34 1 686 44 92
AEQ AMERICA: 2211 South 48th Street, Suite H - Tempe, AZ USA 85282 - Phone: + 1 602 431 0334 - Fax: + 1 602 431 0497

Circle (17) on Reply Card

STANTRON BROADCAST RACKS... SIMPLICITY AND STRENGTH

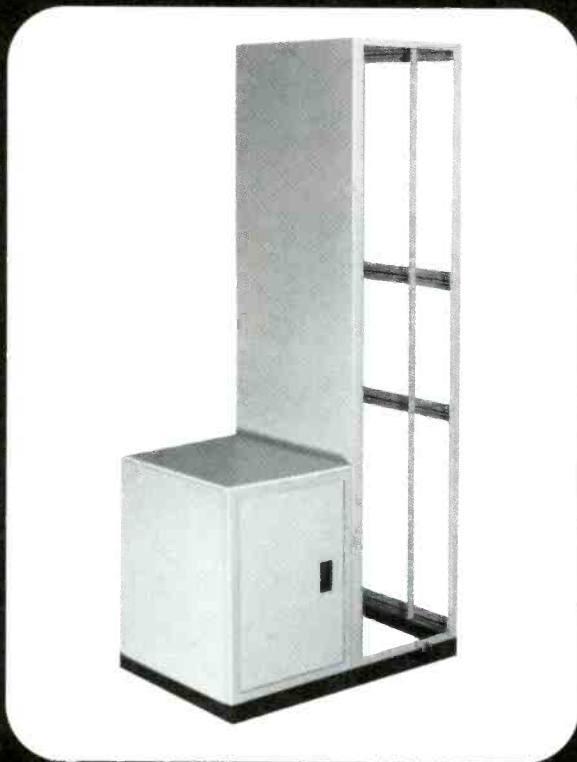

BROADCAST SYSTEM RACKS by Zero Stantron offers you the safety and security of all welded construction. Simply designed and practical, Stantron rack frames and accessories offers you a choice of 11 heights, 3 depths and 22 colors *all standard*. Stantron matches their depth in racks with an equally wide selection of rack system accessories. From plain to A. C. outlet bases, caster plate dollies and lashed, hemmed or formed side panels, Stantron's standard accessories meet any custom requirement. *Stantron products give you a choice with welded construction that counts.*

Stantron ...
Engineered with safety and reliability.



12224 MONTAGUE STREET BOX 4527 • PACOIMA, CA 91331-4527
PHONE (818) 890-3445 • 1-(800) 821-0019
FAX (818) 890-4460

Circle (18) on Reply Card



handling HDTV signals. However, the ATV scenario means HDTV-compatible, but not necessarily requiring full-time HDTV program transmission. Many believe that a relatively long-term combination of HD network programming and local enhanced NTSC programming may be all that's required to be carried on an ATV channel. This transition scenario makes the change to an ATV/HDTV future more financially compatible.

Sony gave attendees a look at its version of how the ATV transition process might be carried out. Although the demo was product-specific, the overall scheme was applicable to any station.

Many manufacturers demonstrated 16x9 compatible equipment. Such products make the transition much easier for stations and production facilities. Now the FCC needs to select the transmission standard. (See "News," on page 4, for the latest word on what's been called the grand alliance of HDTV proponents.)

This year's NAB convention was certainly worth attending. The wide range and quantity of new products was nothing short of astounding, and probably a record. The industry is in the early stages of a long overdue recovery.

Brad Dick

By Brad Dick, editor

Free Catalog & Audio/Video Applications
 Routing Switchers (St-A/V) (24,16,12,8,4,2 stations)
 Video & Audio Dist. Amps. RGB-Sync Dist. Amps.
 OPAMP LABS INC (213) 934-3566
 1033 N Sycamore Av LOS ANGELES CA, 90038

Mic, EQ, Line, Tape, Photo, Osc, Trans, Video, ACN, Pwr. Supp.
 Press Boxes 1-in/16-out Video/Audio 2-in/24-out Audio

Circle (87) on Reply Card

DIGITAL CLOSED CAPTIONING
 Caption your D2/D3 videotapes completely in the digital domain! DCC, The Digital Closed Caption Interface connects between any conventional analog caption encoder (including PC-based) and your D2/D3 tape machines, making the process 100% digital! Installs in seconds. Available now. \$2000.
 Queue Systems 7985 Santa Monica Blvd. West Hollywood, CA 90046 (818) 895-8510

Circle (88) on Reply Card



Trust Harris Allied to make it a smooth transition

IOT efficiency with HDTV capability. That's what you'll get with the all-new Harris Sigma™ Series, a family of 15–240 kW UHF TV transmitters.

Designed from the ground up specifically for the HDTV transition, Sigma sums Harris' experience in broadcast transmission innovation, digital technology, solid state design and total systems integration.

Sigma provides you with exceptional redundancy, headroom and protection with such features as main/standby exciters, EEV-approved thyatron crowbar protection for the IOT and reserve IPA power.

You'll appreciate the low-maintenance design with user-friendly controls, easy

sub-assembly access and the lowest ambient noise level available. Our field-proven IPA and newly developed exciter should give you years of trouble-free operation. What's more, a wide range of configurations and options will ensure you get the best transmitter for your application now or when you move to HDTV.

We invite you to find out why Sigma is *the* no-compromise choice for now and the future. Trust Harris Allied to make it a smooth transition. The world's leader in broadcast technology.

Phone: 217-222-8200

Fax: 217-224-1439

 **HARRIS
ALLIED**

THE TRANSITION TRANSMITTER



The Pick Hits of NAB '93

BE's panel of industry experts selects the best new products at NAB.

By Skip Pizzi and Steve Epstein,
technical editors

Like a well-oiled machine, **Broadcast Engineering's** team of master technical managers again combed the exhibition floor at NAB in search of the best and brightest new products. This year featured the largest Pick Hits panel ever assembled, reflecting the growing diversity of the industry (see the related article, "Judges and Rules," on pg. 42).

Although some panelists noted a drop in the number of new products at this year's show, there were still enough to make selection of the top 10 difficult. As always, the radio and audio experts cast their votes for 10 new radio products, while the video and TV veterans selected 10 new TV products.

For radio, the judges included network, station, group and consulting engineers and managers. The TV panelists represented stations, cable and broadcast networks, video post facilities and consulting companies. The fruits of their labor represent this year's best of show at NAB '93, listed in alphabetical order.

Radio Pick Hits

**Corporate Computer Systems:
CDQ-1000 digital audio codec**

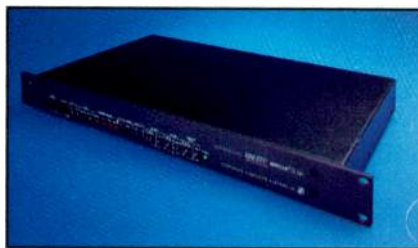

This codec is designed for use on Switched-56 and ISDN telco services, offering outputs at 56kbit/s and 64kbit/s. It is the first to provide CCITT G.722 and MUSICAM data-reduction algorithms in a single box. MUSICAM can be operated with standard 48kHz sampling (providing 8.2kHz mono audio into 56/64kbit/s paths, decodable by any ISO/MPEG Layer II decoder), or at a unique 24kHz sampling rate (providing 10kHz audio decodable by another CDQ-1000). The widely used G.722 system (7.5kHz audio) also is onboard, providing a versatile interface for switched digital audio transmission. Full-duplex operation, automatic synchronization and rate/algorithm sensing, high error tolerance and Delta/Sigma A/D-D/A converters are included.

Circle (300) on Reply Card

**CRL Systems/Circuit Research Lab
DAA-100 digital audio analyzer**



This portable audio test-signal generator and path analyzer provides two independent outputs in either analog or A EBU modes, for testing of analog or digital gear. Each generator channel can be independently set to sine, triangle or square wave functions, selectable in 1Hz increments (1Hz to 22kHz) and 1° interchannel phase steps (0° to 359°). The generator section can be set to 32kHz, 44.1kHz, 48kHz sampling rates or to an external clock. The analyzer section can lock to a sampling rate from 25kHz to 55kHz, decoding and A/D converting AES/EBU or SPI data. An LCD screen displays all channel status bits, user bits, incoming sampling rate and link errors. A speaker, headphone

WITHOUT LEAVING
THE PRESENT BEHIND.





DVW-A500

Sony unveils a full line of Digital Betacam® VTRs to give you a high performance, workhorse format with the ability to record a 10-bit SMPTE-259M signal.



BVM-1911

Sony combines the quality and reliability of the BVM monitor series with the flexibility of either 4:3 or 16:9, set-up or no set-up, contact closure control or RS-422A control, and more.



BVW-400A

Sony Betacam SP[®] analog component acquisition products are ideal thanks to their small size, light weight, low power consumption and high quality images, giving you component signal integrity throughout the production process.

SONY

MOVE INTO THE
FUTURE OF TELEVISION.

DVW-A500

Digital BETACAM

VIDEO INPUT
SELECT

SIF

COMPOSITE

COMPONENT

REMOTE

1

2

RS-232C

VIDEO MONITOR SELECT
CH-2 CH-3 CH-4

OPER

DIGITAL VIDEOCASSETTE RECORDER DVW-A500 Digital BETACAM

BETACAM SP

ANALOG

CH-2 CH-3 CH-4 CUE

REC

INPUT SELECT

AUDIO INPUT/MONITOR SELECT

VIDEO INPUT SELECT

REMCTE

CH-1 CH-2 CH-3 CH-4

BIF

MONITOR SELECT

ANALOG

COMPONENT

COMPONENT

RS232C

REVERSE

FORWARD

PLAYER RECORDER

PULL FOR VARIABLE

CH-2 CH-3 CH-4 CUE

REC

REC INHIBIT

DIGITAL

LTC

INSERT

CUE TIME CODE

TRIM

CH-2 CH-3 CH-4

AUDIO OUT

DELETE

ENTRY

EDIT REVIEW

IN OUT

00:00:00:00

HOURS MINUTES SECONDS FRAMES

RESET

PREREAD CONF1 PB EE

CH/OFF CH/OFF

SET UP TIME CODE

MENU SET HOLD

COUNTER

U/BT TC CTL

STANDBY PREROLL REC EDIT REC INHIBIT

EJECT REW PLAY F.FWD STOP

SHUTTLE JOG VAR

REVERSE FORWARD

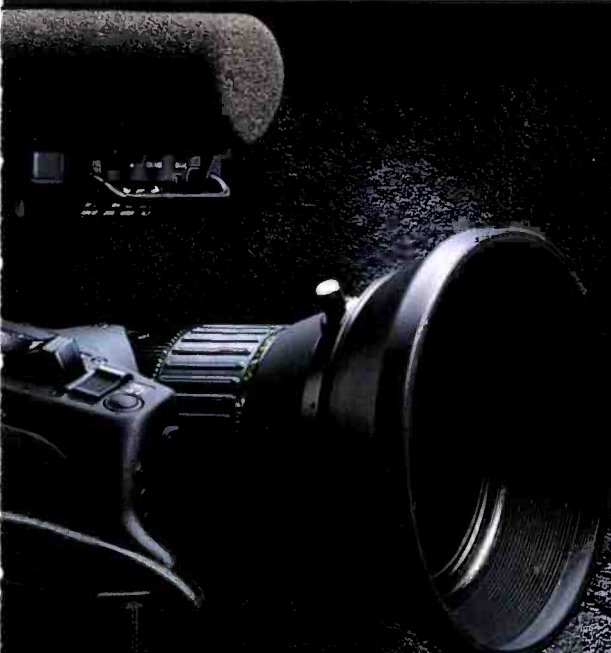

INTRODUCING
THE SONY INTEGRATED
DIGITAL COMPONENT SYSTEM.
BACK-PROOF. FUTURE-PROOF.
WITH ECONOMIC PROOF.

BVE-2000

The BVE-2000 editor connects to as many as 12 VTRs, controlling up to 6 in any one edit. Plus it features Advanced List Management capabilities.



DVS-2000C

This compact one mix/effects component digital video switcher offers 12 inputs. Its high performance processor provides superior Chroma Key and Frame Memory capability.

DMX-E3000

Designed for the digital editing environment, our DMX-E3000 audio mixer ensures advanced audio-follow-video performance.

Features include 16 inputs, 4-channel audio, standard 24-bit AES/EBU digital I/O, analog monitoring outputs and built-in preview switcher.

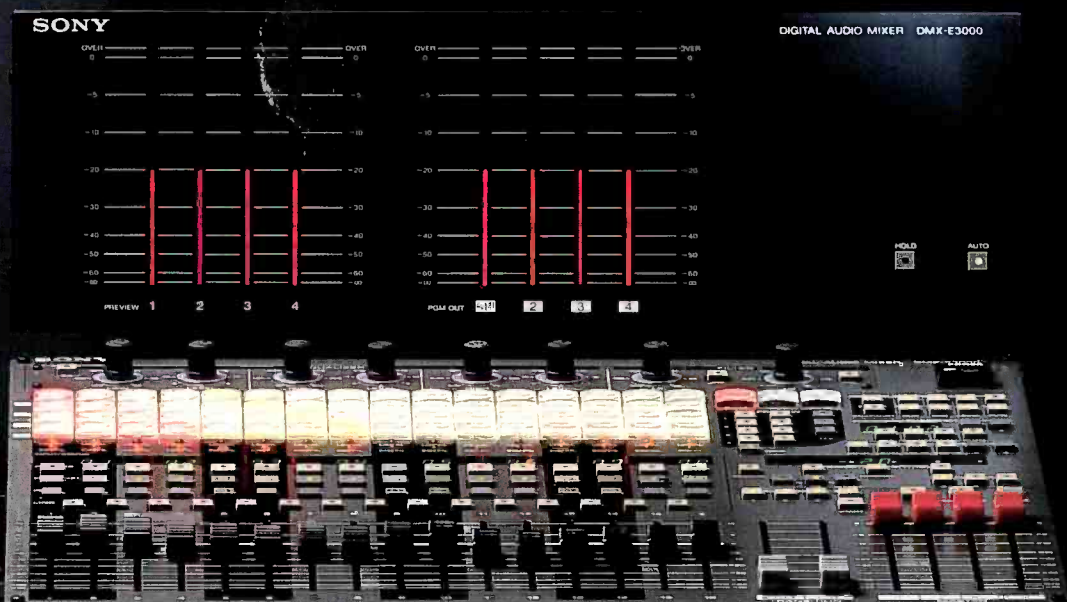

DME-3000

The DME-3000 digital effects system offers a powerful combination of 10-bit frame-processing and high quality digital effects such as page turns, lighting and ripple.

THE FUTURE IS HERE. NOW.

Picture the superior quality of digital component. Sharp colors, clean keys, dazzling effects and outstanding multi-generational copies. Now picture it in a full line of products. Products that are compatible with your existing analog component equipment; that complement each other and let you build an all-digital suite at your own pace – one piece at a time or all at once. Products that will take you into the future of television.

Introducing Sony's affordable line of digital production products. Now, you can move into digital component without abandoning your current investment.

BACK-PROOF

Although the world of television is evolving, one thing is certain: analog acquisition and archive material will be around for years to come. That's why with our new digital component system, going forward doesn't mean leaving the past behind. Take our breakthrough line of Digital Betacam recorders and players. The DVW-A500, for instance, provides full playback capability with Betacam and Betacam SP tapes, bringing your analog material into the digital domain. Additionally, analog component source VTRs can be directly interfaced to the DVS-2000C switcher and DME-3000 digital effects system.

FUTURE-PROOF

Since all current Advanced Television transmission proposals combine a component digital signal and a wide screen aspect ratio, your production system will be better prepared for the future if it has the ability to match this combination. Our Digital Betacam recorders and players bring you the superior quality of digital component recording, and as with all Sony VTRs, are at home in both 4:3 and 16:9 aspect ratios. For viewing, the

BVM-1911 monitor has also been designed to display either aspect ratio. Similarly, the DVS-2000C switcher and DME-3000 digital effects unit are software switchable between both ratios.

ECONOMIC PROOF

Perhaps the best feature of our new digital component equipment is its price-to-performance* ratio. These products were designed to make digital component quality available to a wide range of industry users at a cost comparable to current analog component systems – and a value comparable to high-end production systems.

Sony has accomplished this not through compromise, but through innovative use of today's technology. Each system component has the features you've come to expect. For example, the Digital Betacam VTRs come complete with built-in standard analog interfaces and video/audio pre-read. They also utilize Coefficient Recording – our unique, cost-effective implementation of Bit Rate Reduction technology. And every component has Serial Digital Interface, which makes installing your system both simple and economical by using a single coaxial cable. Furthermore, we offer you the flexibility to build a system at your own pace – all at once or piece by piece. All in all, making the transition to digital component without abandoning your current investment, is now an affordable reality.

Superior quality. Compatibility. Affordability. In a full line of digital component products that put the future of television within easy reach. Today.

For details and more information, call 1-800-635-SONY, ext. 2200.

INNOVATION AT WORK.

©1993 Sony Corporation of America.
All rights reserved.

SONY®

Sony Business and Professional Group
3 Paragon Drive
Montvale, NJ 07645-1735

*Based on manufacturer's suggested retail price.

Sony, Betacam, Betacam SP and the Digital Betacam logo are trademarks of Sony.

jack and line output are provided for audio monitoring.

Circle (301) on Reply Card

Cylink: AirLink wireless modem

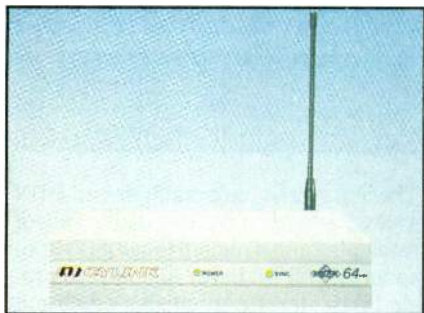

The judges were impressed by the novel nature of this wireless modem that uses BPSK spread-spectrum transmission in the 902-928MHz band. No FCC licensing or common-carrier intervention is required for its operation. The product includes a family of devices, operating at synchronous data rates of 64kbit/s, 128kbit/s and 256kbit/s. RF bandwidths for the spread-spectrum transmissions are 5MHz, 10MHz and 20MHz, respectively. A 6-inch omni whip antenna is used for short haul (<1,000 feet) transmissions; a 24-inch optional yagi antenna offers path lengths of 10 miles or more. Combined with data-reduction codecs, a pair of AirLinks can offer a bidirectional digital audio RPU system. User-selectable frequencies allow multiple units to share the same line-of-sight paths.

Circle (302) on Reply Card

ENCO Systems: DAD486x digital audio delivery system



Operating on a standard 486 PC platform, this user-friendly digital audio storage/automation system offers an intuitive touchscreen interface and flexible design. Modular hardware and user-configurable software allow the product to be customized to each station's needs and growth. Automation accommodates simple live assist or total walkaway. Optional modules provide interface to popular traffic/billing systems, outboard machine control, satellite recording and audio switching. Audio

storage can be mixed between linear PCM and Dolby AC-2, ISO/MPEG Layer II or other data-reduction modes. Simple editing is accomplished on a touchscreen displaying graphic waveforms. Networked operation is supported along with text display for announcer or news copy. Sigma-Delta conversion is used, with 64x oversampling on A/D and 8x oversampling on D/A.

Circle (303) on Reply Card

Modulation Sciences: Model RDS-1 RDS/RBDS generator



Using a somewhat different approach to RDS generation than most, this device takes the form of a PC plug-in card for IBM and compatible computers. The transmitted RDS data is software controlled, allowing phase-in of features following increased audience demand, or as a station desires. It also provides a simple method of dynamic programming and continual reconfiguration of the RDS datastream, to allow changes with dayparts or programming types, or for toggling of certain displays between alternating messages. The system supports the European RDS and U.S. RBDS standards. Changes can be entered on the host PC or via modem from a remote PC, using the included remote-control software. Current values of all parameters are continually shown on the PC's monitor.

Circle (304) on Reply Card

Radio Design Labs: Rack-Up series



These products are a series of 24VDC-powered modules that can be adhesively attached, bracket-mounted (flush or under-cabinet) or rack-mounted (three to a 1-rack unit mount). Current offerings include the RU-MX5, a 5-input audio mixer, with four selectable line/mic inputs and one line-level input, line or mic-level out-

put, phantom powering capability, LED level indication and expandability; RU-DA4D, a 2x4 or 1x8 audio DA with isolated, individually adjustable outputs and LED audio presence indicators; RU-SM12, a precision dual-channel audio meter using horizontal LED display, selectable peak/average or L+R/L-R displays and individual channel calibration. (RU-VDA4, a 1x4 video DA also is available.) Power supply regulation is provided internally by each unit.

Circle (305) on Reply Card

Scientific-Atlanta: Encore DSR-3610 digital satellite receiver



Continuing its pioneering in digital satellite distribution, S/A offers this flexible receiver that accepts S/A's original DATS format and the data-reduced SEDAT system. The single rack-unit device includes two audio output channels with an option for two more. Digital outputs also are provided in AES/EBU and the undecoded (compressed) SEDAT/OSI modes. The receiver is agile between 950MHz and 1,450MHz, and can be used with LNBs of ±2MHz stability or better. Each receiver is individually addressable, and its configuration can be downloaded from a central network computer. Configuration data is held in non-volatile memory. Sixteen opto-isolated closures (relays optional) are provided for remote machine control by the network. A printer/text port and headphone output also are fitted.

Circle (306) on Reply Card

Shure: FP22 stereo+1 headphone amplifier



Similar to its predecessor, the FP12, this battery-powered belt-box is a headphone amplifier, but adds stereo and 16dB qui-

eter performance. The FP22 also incorporates a unique feature that allows mixing of another mono source (mic/line switchable) into the stereo headphone feed, with separately adjustable mix levels between the two signals. Because the device provides a balance control for the stereo input and a mono switch for the headphones, three separate audio sources could be mixed to a mono headphone feed. The amplifier offers more than 80dB of gain to two sets of headphones (either 1/4-inch or miniphone stereo), and includes a 30dB pad on the stereo input. Inputs are bridging with loop-through jacks. External power jack accepts 12-24VDC.

Circle (307) on Reply Card

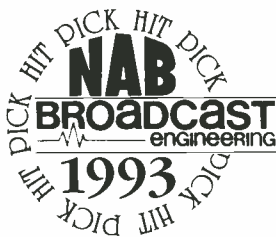

Tascam: DA-88 digital multitrack recorder



This 8-track digital audio recorder uses Hi8 cassettes at just a little more than standard speed for 100 minutes of recording on a 120-minute 8mm tape. Operating in fairly familiar tape-recorder fashion, the deck offers seamless, automatic punch-in/out with rehearsal, and an 80-second maximum fast-wind time from one end to another of a tape. Multiple DA-88s can be ganged together synchronously to increase tracks in increments of eight, up to a total of 128 tracks. Sampling rates of 44.1kHz and 48kHz are supported. Varispeed of ±6% and Delta-Sigma converters are included. Options include a full-function remote control that can accommodate up to six DA-88s (48 tracks), video synchroniza-

tion and AES/EBU or SPDIF digital audio interfaces.

Circle (308) on Reply Card

Telos: Zephyr digital network audio transceiver



This innovative unit combines an ISDN terminal adapter (TA, the equivalent of the telephone instrument for an ISDN line) and an ISO/MPEG Layer III codec to provide 15kHz stereo plus auxiliary data and 7.5kHz backhaul audio over one ISDN line (2B+D), all in a single box. The 2-rack unit device also is compatible with Switched-56. Each unit can operate at either end of a transmission path. Mic/line-level analog audio inputs are provided, along with send and receive level meters, an LCD status display, autodialer and front-panel DTMF keypad. An RS-232 remote-control port and headphone output also are fitted. Line output is switchable between -10dBV and +4dBm. The product is useful for remote feeds or as a backup STL.

Circle (309) on Reply Card

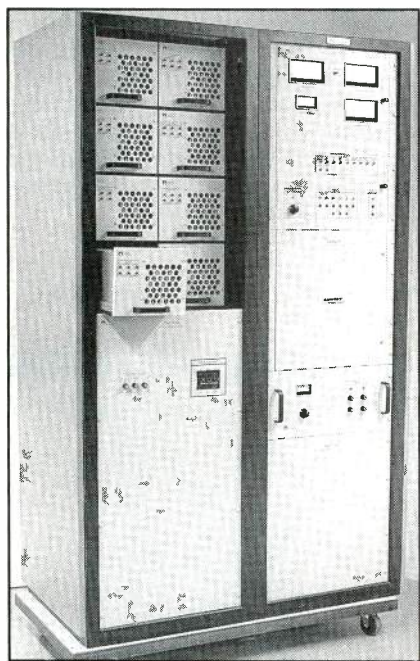

Totally solid state AMPFET ND 10 10kW AM

FOR THE WORLD'S STRONGEST AM TRANSMITTERS, LOOK TO NAUTEL.

Nautel AM transmitters keep you on the air with an unmatched combination of value, performance and reliability.

Low cost of ownership — with typical efficiency ratings up to 80 percent, a totally solid state Nautel transmitter pays for itself in tube replacement and utility.

Superior audio transparency — Nautel AM transmitters utilize inherently linear digital Pulse Duration Modulation for the cleanest sound you can broadcast. Audio is ruler-flat throughout the range and distortion is typically less than 0.5%.

Field-proven reliability — Nautel transmitters give you multiple protection systems for both power line and lighting transients, VSWR protection, soft failure design, reserve cooling and safe on-air servicing.

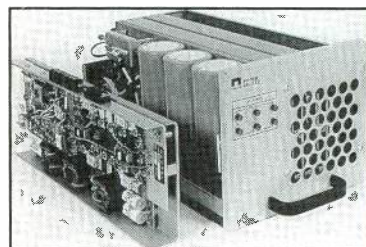

Removable AM Power Module

Make a strong transmitter choice. Call us today for all the facts on our totally solid state AM and FM transmitters.



Nautel Maine Inc.
201 Target Industrial Circle
Bangor, Maine 04401 USA
Phone: (902) 823-2233

Nautel
(Nautel Electronic Laboratories Limited)
R. R. #1, Tantallon, Halifax County
Nova Scotia, Canada B0J 3J0
Fax: (902) 823-3183

Circle (20) on Reply Card

“The thing is just impossible to screw up! The DM-80’s non-destructive editing is the only way to go, and revisions are extremely easy and very quick!”

–David Esch, Director of
Commercial Production
WPNT Chicago

“We looked at DAWs for a year—no other product could even come close to the DM-80’s price/performance ratio.”

–Bill Robinson,
Production Director
WQCD N.Y., NY

“I love this machine! It’s reliable, and user friendly. I can edit in 1/3 the time, and I wasn’t familiar with disk recorders—the DM-80 is easy to learn and use.”

–Michael Cook,
Program Director
KSJJ/KPRB Redmond, OR

Broadcast professionals speak out about the DM-80 Digital Audio Workstation!

“I’ve been editing on tape half my life, and was hesitant to give up “rocking the reels”—but I found this machine is incredibly easy to edit with. And its expandable storage put it way ahead of the competitors we compared.”

–George Zahn,
Operations Director
WVXU Cincinnati

“The DM-80 is a great production tool—it really changed our sound! I like its fast and easy editing capabilities.”

–Mike Britton,
Production Director
KODY/KXNP, North Platte, NE

“The DM-80 does more than DAWs costing twice as much. It’s very rugged—you can set it up and forget about it. And it’s easy to use.”

–Tony Diggs,
Chief Engineer
WKHK Richmond, VA

“It’s like a digital studio in your lap! The DM-80 is a very affordable, portable, high quality digital editing system.”

–Howard Silberberg,
Sound Engineer
United Nations Radio
N.Y., NY

“We originally chose the DM-80 because of its user friendliness. Then we discovered the real magic of this device: a promo announcement that normally would take 4 hours can be done in 30 minutes.”

–Tom Collins, Director
International College of
Broadcasting & Recording, Dayton

“The DM-80’s editing is much more precise than the other DAW we own. We also like the convenient EQ settings right on the fader unit.”

–Rob Thomas,
Chief Engineer
WKRZ, Pittston, PA

We couldn't say it any better.

Call (213) 685-5141, Ext. 337, or FAX (213) 722-0911 for more information about the DM-80 Digital Audio Workstation for the magic of hard disk recording and random access editing at your fingertips.



Circle (21) on Reply Card

TV Pick Hits

Dielectric: 7000 series calorimeter



Looking for an easy way to make RF power measurements? The Dielectric 7000 series calorimetric sensor works with any fluid compatible with copper, nylon, brass or stainless steel. The unit self-adjusts for fluid property changes with temperature variations. A convenient front-panel LCD display shows power, flow rate and temperature in English or metric units. Options include a remote display and an RS-232 interface. Sensors are available in three flow rates, up to 30GPM, and use 3/4-inch hose barbs for input and output connections. The display unit contains a flow

computer that can be set up to display heat flow with an overall accuracy of 0.25%. Features include non-volatile RAM and self-diagnostics. It is available in 115V and 230V configurations.

Circle (310) on Reply Card

Dynatech: D²S² digital storage system

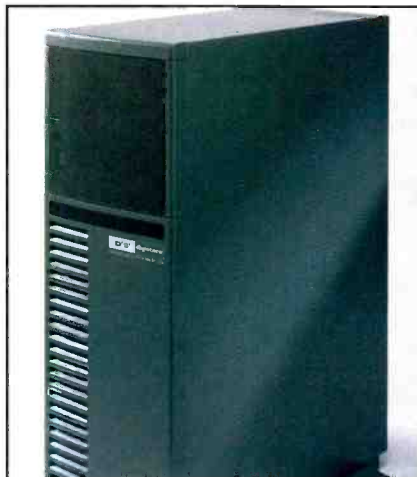

The Digistore is a multichannel digital storage unit that allows instant access to

video, with a variety of quality standards, from component digital to Beta-SP and S-VHS. Each DigiStore can perform any combination of playback, record or off-line archive functions simultaneously, and on multiple output channels. A single unit can hold more than 30 minutes of video spots and program segments. Because it is digital, internal editing, sequencing and off-line archiving can be accomplished with no generation loss. An automated program delay feature allows the same machine to play back video with a variable time shift, hours or seconds after it is recorded. Optional software modules allow connections for ad insertion, newsroom systems and master control automation.

Circle (311) on Reply Card

Hewlett Packard: QA100 Quality Advisor video test device



The QA100 is a real time digital measurement, monitor and correction device with

Clark Listens...

Clark listens to its customers and designs its complete line of audio/video cable accordingly. Now you can listen to Clark's new 700 Series snakes that are designed, as usual, with the customer in mind.

Why not give Clark a listen?



Cables available cut to length and terminated to your specs.



1-800-CABLE-IT!

1801 Holste Road • Northbrook, IL 60062

Listen to Clark!

Circle (22) on Reply Card

NEWTech '93

A MAJOR NEW COMMUNICATIONS INDUSTRY SHOW



Miami Beach, Florida

September 29 - October 1, 1993, Miami Beach Convention Center

Produced in conjunction with the RTNDA and SBE annual conventions

The first jointly produced exhibition of
The Radio-Television News Directors Association
and The Society of Broadcast Engineers

For information on Exposition space call: Eddle Barker, EBA Inc., 800-225-8183

For Convention information call: SBE, 317-253-0122 or RTNDA, 202-467-5200

Circle (23) on Reply Card

Sync To An All-Time Low.

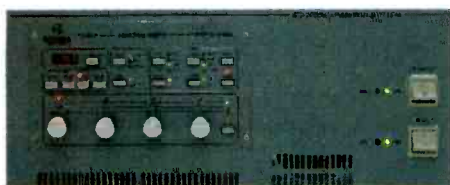
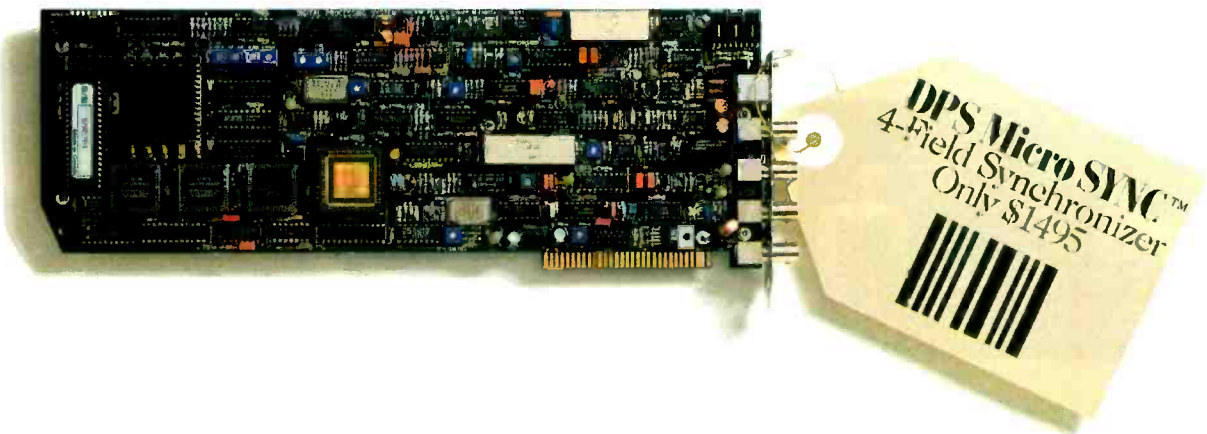

ES-2000 12-Channel Expansion System

It's the first TRUE Video Synchronizer on a PC® card, giving you an affordable way to synchronize any direct color video signal including satellite, network, mobile and ENG feeds. Unlike infinite window TBCs with their performance-limiting Y/C separator circuits, the MicroSYNC utilizes 4-Field Composite Processing for transparent NTSC performance.

Merely insert one or more MicroSYNC cards into a DPS ES-2200 Dual Channel or ES-2000 12-Channel Rackmount Expansion System. Both provide power

and control for any combination of DPS MicroSYNC, Personal TBC®, V-Scope™, VDA™ or Routing Switcher cards. Or choose the AVS-2400 MicroSYNC AV system which combines both audio and video synchronizers in one convenient frame.

You'll find that the MicroSYNC performs like the real thing, with digitally controlled proc amp settings, black clip, nonvolatile memory, adjustable vertical blanking width, two clamp speeds and a

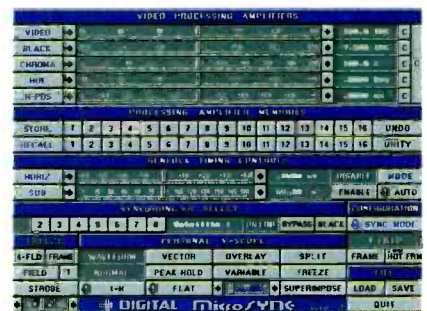

choice of hot switch modes. Production effects include Freeze Frame, Freeze Field and Variable Strobe.

Now more than ever, the video industry is keeping a close eye on the bottom line. Which makes this high quality synchronizer a smart buy for TV stations, mobile operators, production facilities and cable companies alike. So call DPS today and get the lowdown on the new MicroSYNC.



DIGITAL
PROCESSING SYSTEMS INC.

Circle (24) on Reply Card

In the U.S. call (606) 371-5533 Fax: (606) 371-3729 • In Canada call (416) 754-8090 Fax: (416) 754-7046

serial and parallel digital I/O designed to ensure legal video levels. Component and composite analog outputs are provided. It can operate in two modes, monitor only "Show Illegal," or auto-correct "Make Legal." Based on operator-adjustable limits, saturation is reduced to produce legal picture levels, resulting in a clean signal, as close to the original video as possible. A cursor on a component monitor output provides pixel-specific data in one of five user-selectable formats. The cursor is activated by front-panel keys or a PC-compatible serial mouse. Remote control is possible with an optional remote panel or a computer using RS-422.

Circle (312) on Reply Card

ImMix: VideoCube media processor



A Macintosh-based real time media processor, with two video channels, four audio channels and an independent title track. New compression technology allows capture of up to one hour of broadcast-quality video (60 fields/s) and up to two hours of CD-quality stereo audio on a hard disk drive. Expansion modules provide up to an additional five hours of video and 10 hours of audio. Features include 35 pre-built effects and the capability to build more. Two independent keyers provide chroma-keying, full linear keying, and a choice of video or matte fills. The VideoCube includes an integrated, 3-axis rotational digital video effects generator. The character generator is an internal graphics board, which provides access to the extensive library of TrueType fonts available for the Mac.

Circle (313) on Reply Card

Nova: NovaMate TBC/frame sync

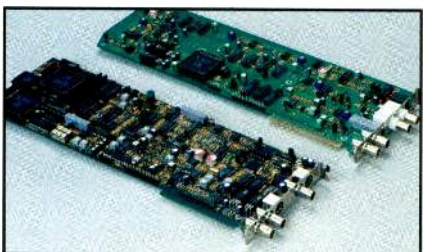

A plug-in TBC/frame sync card for IBM-PC compatibles and Amiga 2000 comput-

ers. Full-function control is provided through an RS-232 port or the optional NovaTrol remote-control unit. The unit is a full bandwidth TBC, up to 6MHz, with 480 lines of resolution and has Y/C and composite I/O ports. Sampling is 8-bit component, with Y and C processing. Freeze frame, field one and two modes with variable strobe are provided. An adaptive digital comb filter reduces cross color and chroma noise. Included is a master genlock card with blackburst and advanced sync. The NovaMate can be operated in single, dual or up to 14 channel configurations. A 3-rack unit NovaFrame can accommodate up to 15 NovaCards.

Circle (314) on Reply Card

NVision: NV5000 universal sync generator



The NV5000 is a 1-rack unit chassis providing a common timing reference for simultaneously locking NTSC video, PAL video, AES/EBU digital audio and SDIF-2 digital audio to a common reference. All outputs are locked together and available simultaneously. It can function as a free-running master sync generator or can be locked to an external 5MHz rubidium timing reference or external NTSC or PAL video source. The AES/EBU and SDIF-2 word clock outputs are simultaneously available in three sampling rates: 48kHz, 44.1kHz and 44.056kHz. Alignment tone output level and frequency can be selected independently for each sampling frequency. Video color bars and blackburst for NTSC and PAL outputs also are selectable from the front panel.

Circle (315) on Reply Card

Odetics: Omnicart multichannel automation system



This highly integrated multichannel automation system is able to run up to eight

lists concurrently. Lists may be assigned for automated recording, compiling or on-air replay. The system manages all functions, including recording, inventory management, break tape compilation and on-air integration of spots and program material. Omnicart provides storage for 300 multicassettes, using a maximum of 14 VTRs. External devices, including switchers, still-stores, character generators and other VTRs, can be controlled by the system. Omnicart may be used to source two or more separate station feeds or can coordinate regional spot insertion on up to six feeds of a network signal. Accurate time line control permits synchronized replay of events even when the events are in different lists.

Circle (316) on Reply Card

Philips: Ghost-cancellation system (implemented on the Tektronix 1910 and 200 VITS inserters)



Ghost canceling is the first major improvement to NTSC broadcasting since color. To implement the system, Philips has developed two generations of advanced digital filter chips and a new family of ghost-cancellation hardware platforms and corresponding software algorithms.

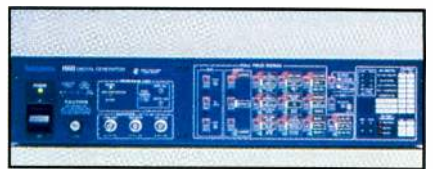

TV receivers with built-in ghost-canceller modules were demonstrated at NAB '93. Set-top ghost cancelers that can be added



to existing televisions also are being developed. The Koo GCR (Ghost Cancellation Reference, invented by David Koo, Philips Laboratories) is broadcast on line 19 of the vertical blanking interval. In addition, Philips intends to adapt ghost-cancellation technology to provide the channel equalization required by tomorrow's digital TV systems. (Editor's note: Tektronix and Leitch have received non-exclusive

LIVE SLOW MOTION

ADMIRE

THE PERFORMANCE

WITHOUT MISSING

THE ACTION

WITH 4:2:2 DIGITAL

LIVE SLOW MOTION

The problem with slow motion is that athletes rarely wait for it to finish. While the commentator is admiring the performance in replay, the show continues. What are you missing? With the Digital Slow Motion from EVS the answer is . . . Nothing.

Digital Live Slow Motion is a new powerful 4:2:2 digital tool that uses the very latest generation of RAM capabilities to continue recording even while you are showing a replay. Because everything is RAM stored digitally, you get instant access, instant replay and superb quality images.

What's more Digital Live Slow Motion offers excellent additional features:

- Search while recording live action.
- 20 to 300 + seconds of instant access material (capacity varies according to RAM size and data compression ratio).
- Definition of segments in RAM for instant playback.
- Component digital and composite input/output in PAL or NTSC.
- Compact size for OB trucks, 5U of rack height.
- Target tracking e.g. track the path of a tennis ball with a pointer.
- Auto fading.
- Library with instant access to several hundred still pictures for use as a backdrop to score round-ups, player biographies or title sequences.

Perfect for outside broadcasts and easy to use. Digital Live Slow Motion will give you the best of live TV. All of it.

Call EVS now or post the coupon.

EVS BROADCAST EQUIPMENT
Rue Courtois 22, B4000 Liège Belgium.

Please send me details on
Digital Live Slow Motion.

Name

Company

Address

EVS BROADCAST EQUIPMENT

Rue Courtois 22, B4000

Liège Belgium.

Telephone: 32/41/22 00 70

Fax: 32/41/22 22 98

LIVE
SLOW MOTION

L.S.M

Circle (25) on Reply Card

EVS
BROADCAST EQUIPMENT

licenses to use the Koo GCR in their VITS inserters.)

Circle (317) on Reply Card

Sony: Digital Betacam series of VTRs



The DVW series of component digital VTRs makes possible the recording of component digital signals, including four channels of 20-bit digital audio that can be independently edited, within a Betacam-size VTR. The DVW-500 and A500 are digital playback/recorders; the A500 also can play back, but not record, current Beta-SP tapes. The DVW-510 and A510 are digital playback-only machines, with the A510 also capable of Beta-SP playback. All four machines have dynamic tracking playback.

The DVW series is equipped with serial digital interface (SDI) that conforms to the SMPTE 259M. This format allows a 4:2:2 component digital video signal embedded with digital audio to be carried via a single coaxial cable and interconnected with other SDI-equipped devices.

Circle (318) on Reply Card

Tektronix: Pathfinder TSG90 NTSC signal generator



A powerful hand-held combination of test signals, ID capabilities and audio tones. The Pathfinder allows quick and easy access to basic functions, including 16 video test signals, audio tones, or creating an ID message of up to 32 characters. For the more demanding user, the Pathfinder provides menu-driven flexibility to change and store selections. The tone menu allows selection of 13 audio tone frequencies, (from 50Hz to 20kHz), an audio sweep and tone levels (0dBu, +4dBu and +8dBu). From the ID menu choose ID position or the ID cycle, which displays four ID captions in a continuous loop, at a selectable rate. Up to eight sets of ID captions and four unique front-panel configurations can be stored for quick recall.

Circle (319) on Reply Card

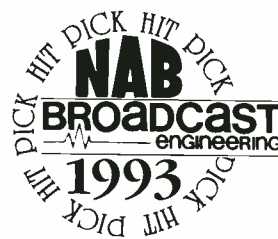

THE NSi EQUIPMENT TRACKING SYSTEM

Eliminate duplicate acquisitions and save money.

The CBS and NBC Television Networks are tracking and archiving over 25,000 pieces of equipment and assets for the broadcast of the 1992 Olympics. To help them perform this task they chose *The NSi Equipment Tracking System*.

From Broadcasting to Healthcare, Insurance to Manufacturing—if you need inventory control and asset management, you need *The NSi Equipment Tracking System*.

KEY FEATURES

- PC-based system
- Catalogs equipment and assets and tracks location
- User defined database
- Query searches by key word, wildcard, and cross reference
- Items can be assigned to integrated groups
- Keeps maintenance records
- Custom report generator
- Creates shipping lists and labels
- Interfaces to optional bar code reader
- Generates Code 39 bar code labels
- Links to accounting systems via ASCII export
- Easy-to-use, menu-driven, on-line help
- Single-user and multi-user versions available



For more information and free self-running demo disk, call or fax:
Nesbit Systems Inc. • Phone: 609-799-5071 • Fax: 609-799-9540

Circle (26) on Reply Card

MICROTIME

is moving ahead...
in Realtime Online.

With the acquisition of new facilities in California and a powerful new COMPOSIUM™ partner for our IMPACT™ Multi-source Digital Effects system, the new Microtime moves to the forefront of realtime online creative video production for broadcast and post.

In mid-July, we'll introduce the newest Compositum software, Version 4.5, and exciting enhancements for our IMPACT Digital Effects Systems. Microtime will provide full engineering support and service for all currently installed systems.



IMPACT™ SERIES

Variable Image
Transformers

- Multi-source Digital Effects
- True 3D Fly-Through Objects
- Fully Field Upgradable
- Render-free Manipulation
- DVE Price/Performance Leader

COMPOSIUM™

Digital Compositor/
Total Graphic
Workstation

- Realtime Multi-layer Digital Compositor
- Full-featured Paint System
- Unsurpassed 4:4:4:4 Image Quality
- Realtime Effects Channel
- Multi-format I/Os

"With 22 years of video leadership and a solid product base, we're committed to continuing the performance innovations and engineering support that are Microtime."

David E. Acker
President,
Microtime

"Congratulations! This is the kind of impact we've been waiting for."

Ed Ackerman
Absolute Post,
Burbank, CA

Operating in Realtime Online — IMPACT and COMPOSIUM plus the rest of our video signal processing product line support your creativity with speed, simplicity and incredible time/cost savings. Call your nearest Microtime office and we'll show you *how simple!*

**See Microtime Realtime Online
at Montreux...Booth A431**

MICROTIME

New Microtime Inc. - An Andersen Group Company

Corporate Office:
Bloomfield, CT 06002
(203) 242-4242 • Fax (203) 242-3321

Western Regional Office:
Sunnyvale, CA 94086
(408) 745-0882 • Fax (408) 745-0883

Atlanta (404) 972-1852 • Chicago (708) 253-6868 • Dallas (214) 644-0232

Judges

Radio judges:

John Battison, P.E.
Consulting Engineer
Battison & Associates
Loudonville, OH

Gerry Dalton
Chief Engineer
KKDA-AM/FM
Dallas, TX

Chris Durso
Chief Engineer
KPBS-FM
San Diego, CA

Kirk Harnack
President
Harnack Engineering
Memphis, TN

Ray Klotz
General Manager
KCNQ
Lake Isabella, CA

Chriss Scherer
Assistant Engineer
WDOK/WRMR
Cleveland, OH

Milford Smith
Vice President, Radio Engineering
Greater Media
East Brunswick, NJ

Herb Squire
Chief Engineer
WQEW/WQXR
New York

Mike Starling
Director, Technical Operations
National Public Radio
Washington, DC

Andy Vallon
Manager, Technical Services
CBS Radio Network
New York



TV judges:

Marvin Born
Vice President, Engineering
WBNS-TV
Columbus, OH

Ken Hunold
Audio/Video Project Engineer
ABC Engineering Laboratory
New York

Mark McKeen
Director of Engineering
The Weather Channel
Atlanta, GA

Phil Mendelson
Chief Engineer
Digital Magic
Santa Monica, CA

John C. O'Donnell
Director of Engineering

WQED
Pittsburgh, PA

Karl Renwanz
Vice President
Director of Broadcast Operations
WHDH-TV
Boston, MA

Dean Sargent
President
D.W. Sargent Broadcast Service, Inc.
Cherry Hill, NJ

Joe Snelson
Group Director of
Engineering
Meredith Corp./KCTV
Kansas City, MO

Roy Trumbull
Assistant Chief Engineer
KRON-TV
San Francisco, CA

Rules

BE's Pick Hits judges operate anonymously. Each year they look for new products that meet the following criteria:

- 1. Products must be new and not shown at a previous NAB.** In some cases, distinguishing a new product from a modified older one is difficult. For Pick Hits purposes, a new product is one with a new model number or designation.
- 2. Products must have some positive impact on the user's everyday work.** Judges search for equipment that will be used on a regular basis. Products should provide new solutions to common problems.
- 3. Products must offer substantial improvement over previous technology.** Unique circuit architecture need not be included, but some new approach or application must be involved in the product's design.
- 4. The prices of the products must be within reach of their intended users.** The judges seek products appropriate to a wide range of facilities.
- 5. The products must be available for purchase within calendar 1993.** Equipment must be on display on the show floor and currently (or imminently) in production. Judges take the exhibitor's word on availability dates. Products demonstrated in private showings do not qualify.



**Video On Tape
Is Ancient History.**



Introducing The D²S² Di

The world's first digit

Here's where evolution can take you: To a revolutionary storage system with digital superiority. D²S² - Dynatech Digital Storage Systems - from Dynatech.



Imagine Instant Random Access At Your Fingertips

D²S² DigiStore is the *only* video storage medium that can record a 30-second spot 15 seconds before it runs. It's the *only* medium that allows a news producer to reorder a rundown at will, even during the newscast. DigiStore's "ping-pong" delay allows an affiliate to simultaneously record and play back a live feed with an automated time delay - from several hours to a few seconds. And imagine the potential for remotes, where a single machine can record, play back and archive simultaneously.

Use it for spot insertion, news playback, feed recording, post-production or program delivery. With DigiStore's simultaneous playback and record capability, you'll no longer have to fight to find an available tape deck at air time. And you can run back-to-back without fear of exceeding cart machine speeds.

The D²S² DigiStore System stores hours of video in a digitally based format allowing instant on-line random access to any spot, news package or program recorded on the system. No rewinds. No pre-rolls. No TRELs. No last-minute, tape-coordinator sprints. Just professional ease and instant access run by your fingertips, not your feet.



DigiStore From Dynatech.

digital video storage system

Calculate Low Lifecycle Costs

Minute-for-minute, D²S²'s initial cost is significantly less than any electro-mechanical tape-based system of comparable video quality. Our "plug and play" installation will save you time from the beginning. And you'll save labor costs with DigiStore's Windows™ based random-access playlist, cart emulation software and interfaces to Dynatech newsroom and automation systems.

Maintaining, rebuilding and replacing electro-mechanical decks is a heavy investment. Compare that cost to the 25-year Mean-Time-Between-Failure on the DigiStore's hard disks. What do you spend on videotapes? Not anymore. Imagine no missed revenue from spot make-goods, botched as-run validations and miscued feeds.

Capture High Quality Video Imagery And Broadcast-Quality Stereo Audio

No compromises. Dynatech's unique Parallel Processing Compression™ optimizes video and audio quality at a price point that suits your needs. All information is recorded without alternate field drop. Each field recording is automatically adjusted for maximum clarity. Your video record and playback performs at a breakthrough level—the kind of quality you expect from Dynatech's leadership in digital technology.

Move your operation into the new age with D²S² DigiStore. Walk upright. Make history.

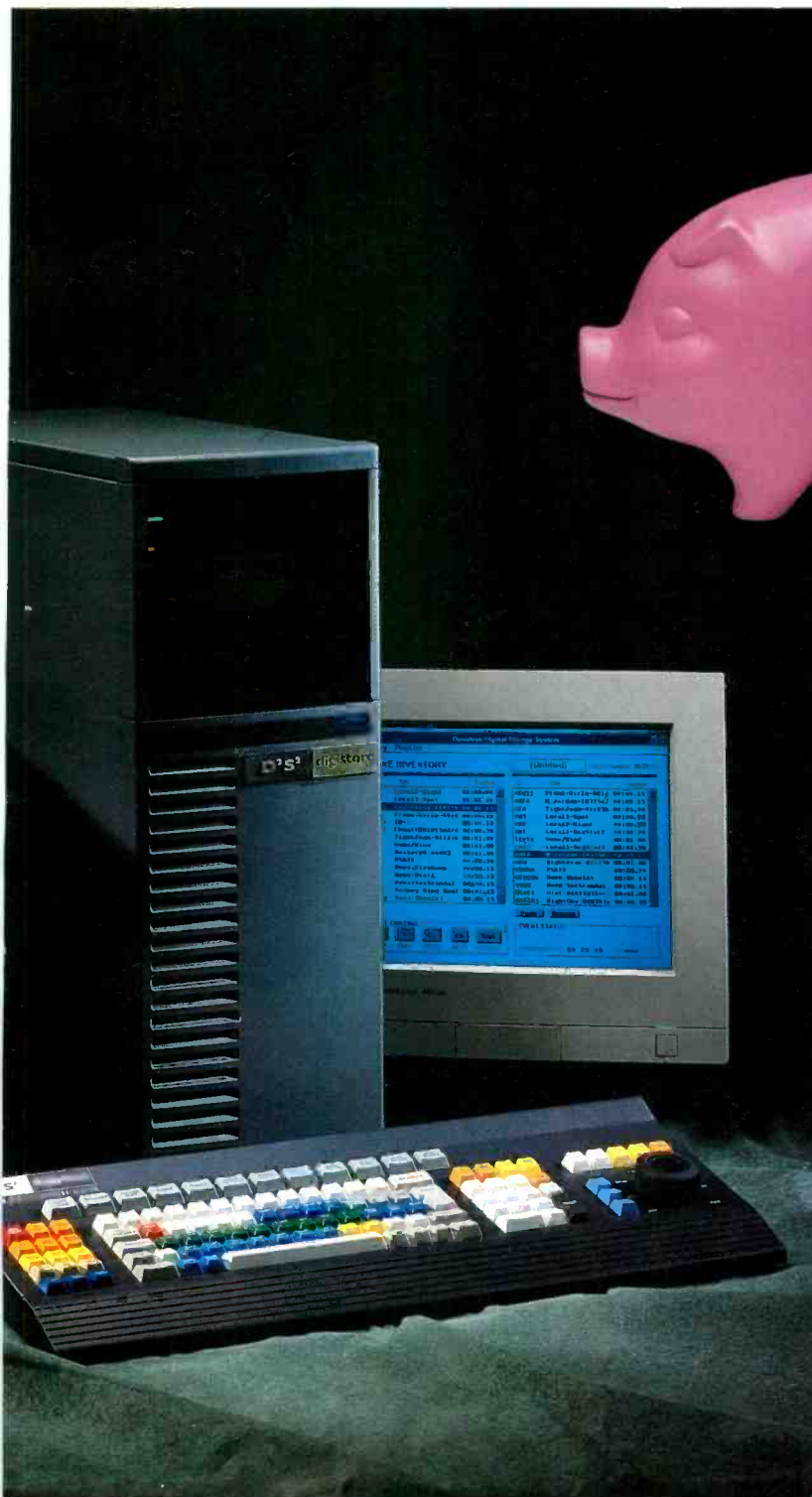

D Y N A T E C H
V I D E O G R O U P

The best professional video in the world

Compare The Power of D²S² With Decks and Carts

Videotape Decks And Cart Machines

- Delayed Gratification

Rewinds, fast-forward and pre-rolls mean slow response to changing playlists and edit decisions.

- Maintenance And Support Overhead

Electro-mechanical devices require ongoing maintenance. Shuffling cassettes tie up technicians and tape coordinators.

- One Channel Per VTR, One Operation At A Time

Videotape machines were designed to record or to play back on a single channel.

- No Remedy For On-Air Failure

If a VTR fails to play back properly, on-line backup is rarely available.

- Fixed Duration

Most tapes store no more than 30 minutes of video, and to ensure flexibility, most operations store no more than one piece of video per cassette.

- Generation Loss

Re-recording original analog tape to change formats, edit or make copies results in visual degradation.

- Linear Playback

In order to play back video, you must record and rewind.

- Dedicated Function

VTR and cart machines are typically configured for a single-purpose use within a facility.

- Broadcast-Quality Stereo Audio

- "Plug And Play" Protocols

Dynatech Digital Storage System

- Instant Access

The power of non-linear access in the vertical interval enables instant changes in cueing for playback and recording.

- Low Lifecycle Costs

Disk drives with a MTBF of 25 years require little maintenance, and ending the tape shuffle reduces engineering overhead by hundreds of man-hours per year.

- Multi-Channel, Simultaneous Input, Output, Archive

Multi-channel design allows instant access to video within your facility. Each DigiStore can perform any combination of playback, record or off-line archive simultaneously—and on multiple output channels.

- Field Accurate On-Line Redundancy

For high-end operations choosing this feature, digital mirroring and timing of video storage ensures fault-tolerant playback.

- Expandable Mass Storage

On-line disk stores hours of video. A single unit holds scores of spots and program segments. Modular disk arrays add archiving and program output.

- Digital Dubbing

Internal editing and sequencing and off-line archiving of digitally stored data result in no generation loss.

- "Ping-Pong" Playback

Automated program delay feature allows the same machine to play back video with a variable time shift, hours or seconds after it's recorded.

- Multi-Function Interfaces

CartWare, NewsWare and AdWare modules create flexible, intimate software linkages with ad insertion, newsroom systems and master control automation.

- CD-Quality Stereo Audio

- "Plug And Play" Protocols

D²S² DigiStore's singular place in digital video is a result of natural selection. DigiStore evolved from the synergy of Dynatech's video group, a dynamic consortium of high technology companies with proven expertise in taking the next step up.



Circle (28) on Reply Card

D²S² digistore

DYNATECH DIGITAL STORAGE SYSTEM

6400 Enterprise Lane, Madison, WI 53719 U.S.A. 608-276-4680



NAB Engineering Conference report

A mind-numbing array of sessions confronted NAB '93 attendees.

By Skip Pizzi, technical editor

The Bottom Line

If you attended NAB '93, you likely missed a lot more than you read about in the conference program. Even if there were three of you, that wouldn't have solved the problem. Plenty of good information was on hand, and capturing it all would have taken several encyclopedia-sized volumes and weeks worth of study. If that's not an appealing prospect, read on for a brief, yet comprehensive overview of the trends in the trade, as evidenced at NAB '93.

S

The decidedly upbeat mood at NAB '93 was reflected in a record number of attendees at the show. The official figure of 64,510 is a whopping 22% increase over last year. International attendance, which has been the only real growth area in the last two years, was up by 33% over 1992. At 11,523, international registration accounted for 18% of total attendance.

Aside from the massive show floor at the Las Vegas Convention Center, the conference also featured an unprecedented number of parallel conference tracks. Among these were the traditional *Broadcast Engineering Conference* and *HDTV World*. They were joined by the debut of *Multimedia World*, which was accompanied by its own separate exhibit floor at the adjacent Las Vegas Hilton (dubbed the digital suburbs by some attendees).

Major issues

- **Datacasting:** Opportunities in non-audio/non-video broadcasting were never more apparent at a broadcast convention. Auxiliary data transmissions using subcarriers or in the VBI were emphasized in the short term, with the open-ended nature of future digital broadcast transmissions providing great potential for further growth. A full day of sessions provided introductory tutorials on the subjects (a half-day each for radio and TV applications). Several demonstration

booths between the session rooms and the exhibition floor ran radio and TV examples of datacasting throughout the convention.

For radio, the RBDS system was on the air on most FM stations in Las Vegas. Most of these stations have been running RBDS since last January's Consumer Electronics Show in Las Vegas. Receivers were on hand to demonstrate how a full FM dial of RBDS works.

TV data discussions and demonstrations considered enhanced closed-captioning features and other proposed VBI services for program-related data. The latter allows broadcasters to transmit programming data (about the current and upcoming programs) on line 21, field 2, for display through a properly equipped receiver's closed-caption decoder. The now standardized ghost-canceling system, which also uses the VBI (line 19) was demonstrated. (Before the convention, the FCC accepted an amendment to the VBI rules authorizing these systems in a Report and Order on Docket 92-305. It was adopted on May 5.)

The new program-related data protocol is contained in EIA's proposed *Extended Data Services (EDS)*, a voluntary standard for all line 21 data nearing completion, under the draft standard EIA-608. It will allow on-screen data about the station and current program to be displayed almost imme-

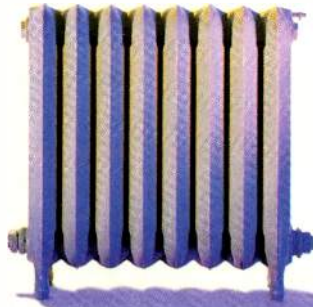

HOT METAL.



REALLY HOT METAL.



YIKES!

Introducing the 3M BC-Metal videocassette. The hot, new Betacam SP™ tape designed to raise the standards by which all others are judged and

destined to popularity. In fact, we wouldn't be surprised if you've already heard about it. But if you haven't, rest assured, you will.

3M Audio and Video Markets Division
3M Center, St. Paul, MN 55144
Within the 703 area code: 1-800-831-8726
All other US: 1-800-752-0732 ©1993 3M

3M

Circle (29) on Reply Card



GOOD DEAL!

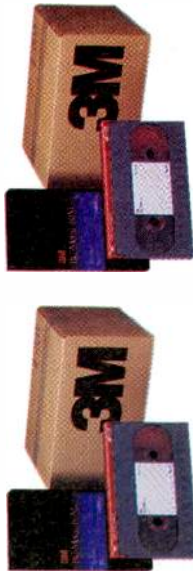

GREAT DEAL!

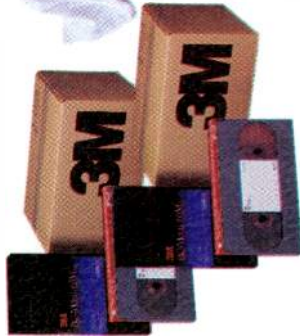

YOU MUST BE KIDDING!

Introducing New 3M BC-Metal Videocassettes

Given the outstanding performance, unsurpassed reliability and competitive pricing of our new Betacam SP™ videocassettes, they're a value all by themselves.

But as an introductory offer, when you purchase at least one case of BC-Metal between July 1 and August 31, 1993, you'll receive an additional case of equal or lesser value absolutely FREE. No kidding!

What's more, with a copy of your invoice from the introductory offer, you'll also receive an exclusively-designed, 100% cotton T-shirt.

Call your 3M distributor for full details. Or call 1-800-752-0732 for your nearest 3M sales office (1-800-831-8726 in area code 703). Or simply complete this card and drop it in the mail. But hurry, because it will probably be a long time before an offer this great comes along again.

___ Yes. Please send me full details on the 3M BC-Metal introductory offer.

Name _____

Position _____

Company _____

Address _____

City/State/Zip _____

Telephone (_____) _____

*One offer of free case and T-shirt per customer. Offer good in U.S.A. only. Offer ends August 31, 1993. T-shirt may be redeemed through September 30, 1993.



Audio and Video Markets Division

St. Paul, MN 55144-1000

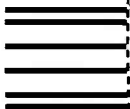

NO POSTAGE
NECESSARY
IF MAILED
IN THE
UNITED
STATES

BUSINESS REPLY MAIL

FIRST CLASS MAIL PERMIT NO. 4508 ST. PAUL, MN

POSTAGE WILL BE PAID BY ADDRESSEE

Corporate Promotions
445 Etna Street
Suite 60
St. Paul, MN 55106-9932

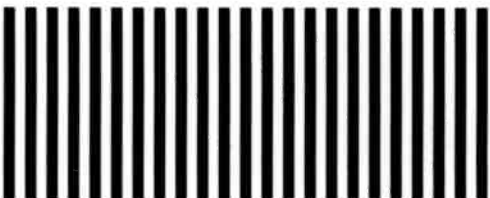

EBS at NAB

During the SBE's EBS Summit at NAB '93, no one disagreed that the current EBS system needs help, but a pair of proponents vigorously disagreed on just how to do it. TFT and Sage Alerting Systems emerged as champions of two different approaches. The former advocates an overhaul and enhancement of the existing system; the latter calls for an RBDS-based replacement.

Both of the systems propose to replace the existing daisy-chain configuration with a web distribution system, providing added robustness and multiple entry points. Station-based receivers for both systems also can be programmed to scan multiple sources for data input.

TFT calls its method the Emergency Information System (EIS). It allows the use of relatively inexpensive upgrades to existing EBS receivers at stations. The system combines the signaling protocol of the National Weather Service's Weather Radio Specific Area Message Encoder (WRSAME) system with the web architecture of the Emergency Alerting System (EAS, also known as the Improved Colorado Emergency

Broadcast System, ICEBS) and the data capacity of the Emergency Data Information System (EDIS). It also preserves the audible warning tones of current EBS and NOAA weather radios. EIS can be compatibly fitted with an RBDS component to augment its standard on-air alerting approach. It also is compatible with closed-captioning, teletext and other alerting systems.

The Sage system would allow longer messages in its strictly RBDS approach. It also envisions alerting on alternate devices, such as a smoke detector-like alarm with a built-in RBDS receiver, or a television that automatically turns on when it receives an emergency message in its VBI.

The FCC will conduct tests of 16 different proposed systems (including the two previously described) beginning this summer in Denver. The commission hopes to have a new system selected by the end of the year, and expects that different elements from several proposals may be incorporated into the final recommendation. □

diately upon tune-in (including elapsed time since program start and perhaps a 4-line text description of the show). The data shows up during a commercial or other program breaks. Channel grazers

An on-air demonstration of a full in-band/on-channel (IBOC) AM system was presented for the first time

may be encouraged to stay with a channel even if they tune in during a commercial. This feature generated significant interest among managers at the show.

- **Video compression:** Continuing progress was reported in development of algorithms that incorporate improved motion estimation or prediction, improved robustness for broadcast (incorporating graceful failure modes) and integrated multichannel surround sound. Although the MPEG format appeared in hardware and software at the show, work continues on MPEG2 and other systems. An international MPEG

standard is scheduled to be set in 1994. Discussion of the lack of single-frame access to MPEG and other systems generated some concern among attendees. Objective testing of video compression algorithms also was discussed. This area will see even closer examination in view of the tape format battle between Ampex, Panasonic and Sony. Although Panasonic's D-5 uses no compression, the Ampex and Sony recording schemes do. You can expect to see a lot of posturing and discussion on this issue within the next year.

- **Audio compression:** Although several new hardware applications of audio data-reduction algorithms were well received at the show (see "Pick Hits," on page 32), concern mounted over multigenerational coding artifacts (see "re: Radio," September 1992). Progress also was reported on objective testing of data-reduction algorithm performance.

- **Digital radio broadcasting:** A full day was devoted to the subject of digital radio broadcasting, allowing in-depth discussion of the field's current status. Most terrestrial proponents made presentations, along with a report from DBS system proponent NASA/VOA. Other papers covered multipath analysis, upcoming on-air

comparative testing, plans for consumer receivers, potential implementation costs and current tests of the Eureka 147/DAB format in Canada. USA Digital presented an on-air demonstration of a full in-band/on-channel (IBOC) AM system for the first time. However, the company was unable to present its planned mobile IBOC FM demonstration because of equipment shipping and installation problems. Meanwhile, rumors persisted that a competing AM IBOC system was going to be announced. (See "re: Radio," page 12, for more details.)

Sculley questioned the wisdom of broadcast TV's pursuit of HDTV.

- **HDTV:** At the 3rd HDTV World conference, updates and demonstrations were presented on HDTV production techniques from around the world. U.S. transmission system discussions took place in a context that preceded the May 1993 announcement of the so-called Grand Alliance of ATV proponents, but nevertheless detailed the testing (objective and subjective) and channel allotment processes from over-the-air and cable perspectives. (See "News," page 4.)

- **Multimedia:** The first *Multimedia World* conference at NAB logically concentrated on basic, tutorial discussions of the technology. It also featured a series of sessions devoted to production techniques for multimedia projects. Specific potential connections of multimedia to broadcasting also were highlighted. The large number of highly placed speakers from multimedia-related industries on the conference program gave testimony to the potential importance of a broadcasting component to the future of multimedia.

Many of these sessions were accompanied by printed papers. Three separate proceedings have been published by NAB for the *Broadcast Engineering*, *HDTV World* and *Multimedia World* conferences. Recordings of most sessions also are available on audiocassette. Getting all of this under your belt will certainly take some time — probably right up until it's time to get ready for the 1994 convention. The earlier date for next year's show (March 20-24, in Las Vegas again) puts your preparation time for NAB '94 less than nine months away. ■

Show of Shows

By Stefanie Kure, associate editor



The following list provides an overview of the new products introduced at NAB '93. This year's Pick Hits are identified in the text and are discussed in greater detail, beginning on page 32. To receive information about any of the products in the listing, circle the appropriate Reader Service Number.

A

AAVS/Advanced Audio Visual Systems

EVA: complete automation control system for broadcast stations, network master controls and video libraries; based on EBus.

S-90 MOSAIC: video multiplexer places 4, 13-, or 16-image matrix on screen from any of 36 asynchronous inputs.

Access 2000: cable industry program guide and promotion system.

Model S-310: all-format digital video analyzer.

Circle (350) on Reader Service Card

Abekas Video Systems

A51 effects: true 3-D perspective, rotation, location, corner-pinning; 16-input source selector.

A57 effects system: 10-bit frame-based; maximizes limited switcher M/E resources with input pre-transform and background keys.

A66 recorder options: SCSI/Ethernet interface for file transfers; conforms to CCIR-601.

A72 titler: instant font access, character sizing and attribute adjustment; keyframe animation.

A82 production switcher: composite digital processing; ASPiK adaptive sub-pixel intelligent keying; networking capability; two digital keyers.

A84 component digital switcher: features framestore-based layered video architecture; 4-, 6-, 8-layer configurations; 10- or 8-bit CCIR-601 I/O.

A42 digital still store: compact storage of high-quality images; easy operation.

A34 SOLO production system: combines TBC, audio/video switching, mixing, two channels of digital effects and time code in integrated package.

A29 Video Legalizer: ensures that the wider range of color available in component video is properly limited when converted to NTSC broadcast specifications.

A27 D-2 to D-1 converter: decodes, converts NTSC digital composite with associated key signal to digital component video and key; parallel or serial input; D-2/reference, composite analog/reference and D-2 serial/reference output.

A83 component digital switcher: three mix/effects modules, for post-production, broadcast; user-definable inputs, signal system networking.

A65 digital disk recorder: 25-second capacity switchable between 525/625 standards; conforms to CCIR-601, SMPTE RP-125.

A65/A66 Ethernet interface enhancements: window transfer feature for Ethernet image file transfers between computers and the A65/A66 digital

disk recorders.

A65/A66 VideoTools package: for SCSI and Ethernet applications; specifically designed for Silicon Graphics workstations; includes a GUI and a new SCSI driver.

A57 video combiner: combines two A57 effects channels in the digital domain over live background without using switcher keyer resources.

A51 + effects: enhanced A51 includes Superwarp effects option with ripples, single-pass page turn; allows existing A51 channels to be upgraded.

A28 D-1 to D-2 converter: decodes, converts digital component video with associated key to digital composite video and key.

A26 D/A converter: converts digital component video with key to analog component video with key; optional parallel or serial I/O.

A25 A/D converter: takes analog component video with key to digital component video with key optional parallel or serial I/O.

Software options for DDRs: Segments Playback lets users randomly play back video from disk in real time.

Circle (352) on Reader Service Card

ACCUM

Axial 2020: visual on-line editing system.

Digital Image Store: for video and key.

ICM 4224 Image Compositing module: provides 4:2:2 switching and layering.

RTD 4224: real time 10-bit video, key data recorder.

RTD 4200: composite digital, real time 10-bit disk recorder.

WSD workstation disk: desktop real time disk recorder.

RAVE: non-linear, on-line editing system with 10-bit D-1 and D-2 image quality.

Circle (353) on Reader Service Card

Accu-Weather

Accu-Call 900: service for weather, sports information, horoscopes and other features as revenue source based on charges paid by callers.

The Weather Show: presentations in 15 seconds or longer segments prepared by Accu-Weather to focus on conditions in stations area.

UltraGraphix 386/486: PC HR graphics access, paint, display system.

UltraGraphix-PLUS: PC graphics access, paint, display system; uses highest resolution of 8-, 16-, 24- or 32-bit graphics systems.

NEXRAD: products using NEXRAD radar system.

Circle (354) on Reader Service Card

Accurate Sound Corporation

Model 315/925: high-speed audio duplicator electronics; amplifiers, bias generator.

Model 4000: cassette recorder; twin drive permits two recordings or sequential taping; logging, time-delay with 24 hours on a single c-90 cassette.

Circle (355) on Reader Service Card

Acoustic Systems

Series BB: voice-over booths; 3'x3'x7' to 8'x8'x7' internal dimensions.

BB/Econoline series: voice-over booths.

BB/Proline series: standard-sized voice-over booths.

Circle (356) on Reader Service Card

Acoustical Solutions/Alpha Audio

Acoustical forms: in pyramid-, wedge-shaped products.

Alphasorb: Fiberglass panels, fabric covered.

Sound Barrier: absorber in blanket, vinyl barrier forms.

Soundtex: acoustical wall fabric.

Circle (357) on Reader Service Card

Acrodyne Industries

ADAM: "Acrodyne Digital Amplitude Modulation" demonstration of VHF and UHF broadcasting; 10-bit analog/digital converter, instantaneously switched solid-state power amplifiers provide ultra-high efficiency; universal compatibility with CCIR, color and HDTV system formats.

TLH/1K system: solid-state 1kW VHF TV translator/transmitter.

TLU/100SE: solid-state 100W UHF TV translator.

TLU/1KSCE: solid-state UHF TV transmitter/translator; 1kW output rating.

TRU/30KV: single-tetrode 30kW UHF TV transmitter/translator.

TRH/1K and TRH/2K: 1kW/2kW solid-state VHF TV transmitters

Circle (358) on Reader Service Card

Adams-Smith

Q-GEN: generates ADR talent cue displays; multiformat time-code unit inserts LTC, MIDI code into video.

Serial Manager: inter-product interface via RS-232C/422 and MIDI I/O.

Circle (359) on Reader Service Card

ADC Telecommunications

Digital Audio Patch Bay: digital ready audio patching; standard designs accommodate AES/EBU digital audio signals.

RS-422 Patch by Exception: 9-pin bay allows cost-effective patching of any digital signal using 9-pin connectors.

Circle (360) on Reader Service Card

ADM Systems

Post-Pro: post-production console; 8/12/16-input with 4x1 preselectors; 3-band EQ; VCA control.

Chromatec TVD-10: in-picture audio level meter.

Chromatec TVD-25: in-picture audio level meter.

Chromatec TVD-25C: component ver., TVD-25.

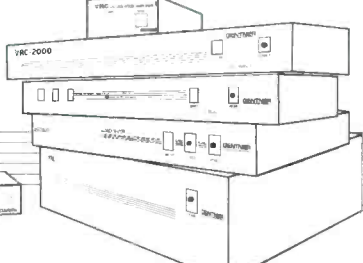

REMOTE CONTROL

AUDIO PROCESSING

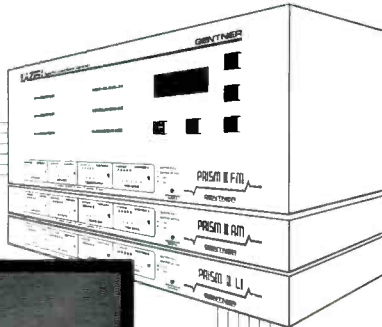

Broadcast's Premier Telephone System!

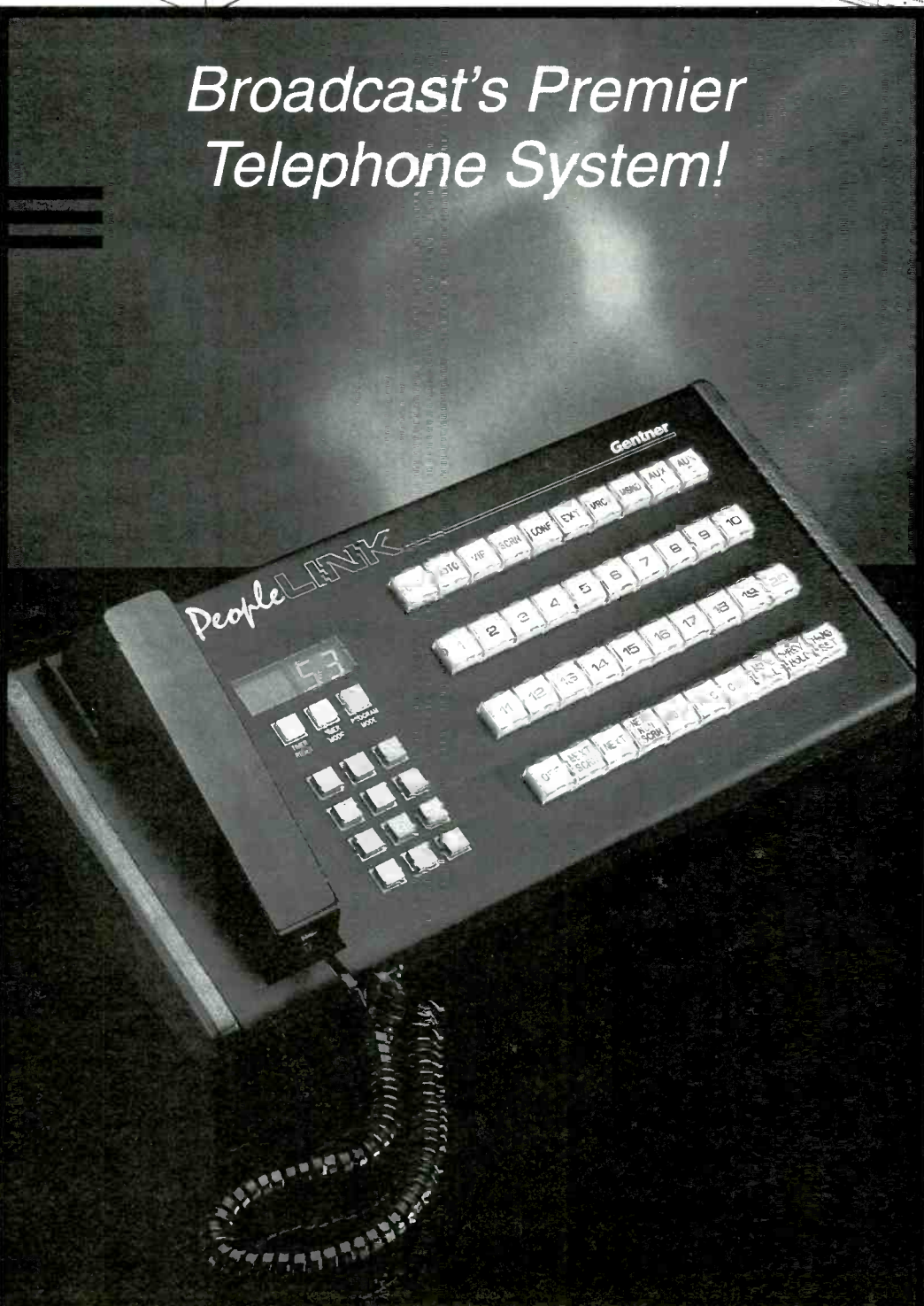

DIGITAL STORAGE

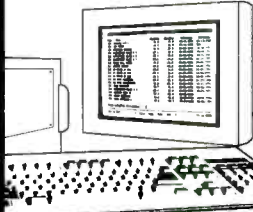

AUDIO ROUTING AND DISTRIBUTION

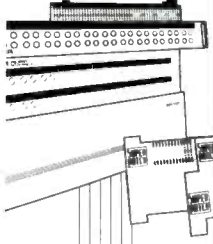

No other telephone system on the market has the versatility and expandability of the PeopleLink System

FREQUENCY EXTENSION



TELEPHONE INTERFACE

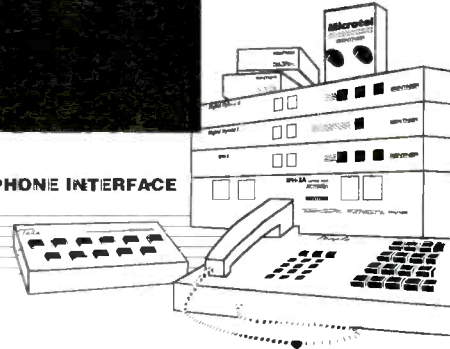

Gentner

Gentner Communications Corporation
Professional Audio Products

1825 Research Way / Salt Lake City, Utah 84119 / (801) 975-7200 / FAX (801) 977-0087

Circle (30) on Reply Card



MARK IS YOUR PERFORMANCE SOURCE FOR GRID ANTENNAS

- *Constructed Of 6063 Aluminum For Long Service Life
- *Low Windloading Characteristics
- *Universal Mount For Easy Installation
- *4 - 15 Foot Diameters
- *Frequency Bands 335 - 2700 MHz
- *De-icing Available

MANUFACTURING LINE-OF-SITE ANTENNAS FOR OVER 40 YEARS



Radiation Systems, Inc.
Mark Antennas Division

1757 Winthrop Drive, Des Plaines, IL 60018 U.S.A.
Tel 708-298-9420 * Fax 708-635-7946

Circle (31) on Reply Card

AS-101 Audio Switcher

- Illuminated and legible control buttons
- Instant or overlap switching
- Front panel accessible level controls
- Options include: RS-232 interface, remote control, relay-follow-switch outputs
- Network proven quality and reliability

10 Stereo In - 1 Stereo Out

P.O. Box 1342 Bellingham, WA 98227
1-800-645-1061 FAX (206) 676-4822

Conex Electro-Systems, Inc.

Circle (32) on Reply Card

RUGGED CASES For Broadcast Equipment

- 220 off-the-shelf roto-molded sizes for fast delivery.
- Expert custom cushioning engineered for your most delicate equipment.
- Call us for a free color catalog.

HARDIGG CASES™

393 North Main Street, So. Deerfield, MA 01373
Tel: (413) 665-2163, Fax: (413) 665-8061

Circle (33) on Reply Card

- Chromatec TVD-35:** in-picture audio level meter.
- Chromatec TVD-35C:** component video version of the TVD-35.
- Bel BDE-5000S:** stereo broadcast profanity delay unit.
- Bel BDE-6000SF/S:** digital audio lay-off recorders.
- Bel BDE-7000SD/SDA:** digital audio delay synchronizers.
- Bel BDE-8000S:** 8-channel audio frame delay synchronizer.
- Post-Pro:** audio console for 1", on-line editing suite.
- Post-Pro II:** audio console designed for needs of the D-2 suite.
- RM1010:** stereo switching matrix; designed to be inserted between a line level stereo source and its load.
- RM1168:** mix-minus matrix; features 16 inputs to eight outputs.
- RM1040:** metering system; features 0.5dB resolution per segment.

Circle (361) on Reader Service Card

Adrienne Electronics

- AEC-Box 8/18/28:** stand-alone LTC/VITC generators.
- AEC-Box 89:** parallel adapter for serial remote VTRs.
- MCLTC, MC-VITC, MC-VLTC, LTC/VITC:** plug-in cards for IBM PS/2 PCs.
- VTR emulator mode:** for AEC-Box 2/10/20 time-code readers.

Circle (362) on Reader Service Card

Adtec Productions

- Active 64-16 multi-channel controller:** automates playback, record and commercial insertion for 16 transports over 16 channels.
- Active 64-16/Telecaster 4A:** combined system incorporates up to 4 integral character generators.
- ARC series:** line of table-top racks for head-ends or vans where space and weight are of concern.
- LITE-NING:** low-cost playback controller capable of controlling eight transports on two channels.
- Telecaster 1:** low-cost character generator.
- Telecaster 4A:** low-cost playback controller can control 16 transports over 5 channels.

Circle (363) on Reader Service Card

Advance Products

- AV2C-42J PIXMobile:** 42" table, cabinet, adjustable height.
- AV6-54J PIXMobile series:** 54" table, optional cabinet, adjustable height.
- AVOH-39J, CTOH-39JS:** A/V tables features overhead projector well, shelves for computer equipment.
- CT-31JS series:** 31" tables on 4" casters; monitor shelf; for non-dedicated computer applications.
- VT5CM-54J:** A/V table; cabinet, locking doors, adjustable shelf.

Circle (364) on Reader Service Card

Advanced Broadcast Systems

- Smart One:** UHF Computer Supervised transmitter with intelligent interfaces; ATV/HDTV ready.
- HEP-3/HEP-3a:** solid-state pulsing systems designed for use with the BCD, ABC or ACE elements of the new generation klystrons.

Circle (365) on Reader Service Card

Advanced Designs

- ADPRAD 32:** Collins turbulence detection with DOPRAD, time-lapsing, 32-bit graphics with VISTA board, display control, map builder.
- DOPRAD III:** Collins turbulence detection weather radar system.
- WDDS weather data display systems:** custom configurations for end-user specifications.
- DOPRAD Storm Path analyzer option:** integrated option to DOPRAD weather radar system.

Circle (366) on Reader Service Card

Advanced Digital Imaging

- Digital Magic:** D-1, Betacam, MII component compatible digital disk recording system for Macintosh.

Circle (367) on Reader Service Card

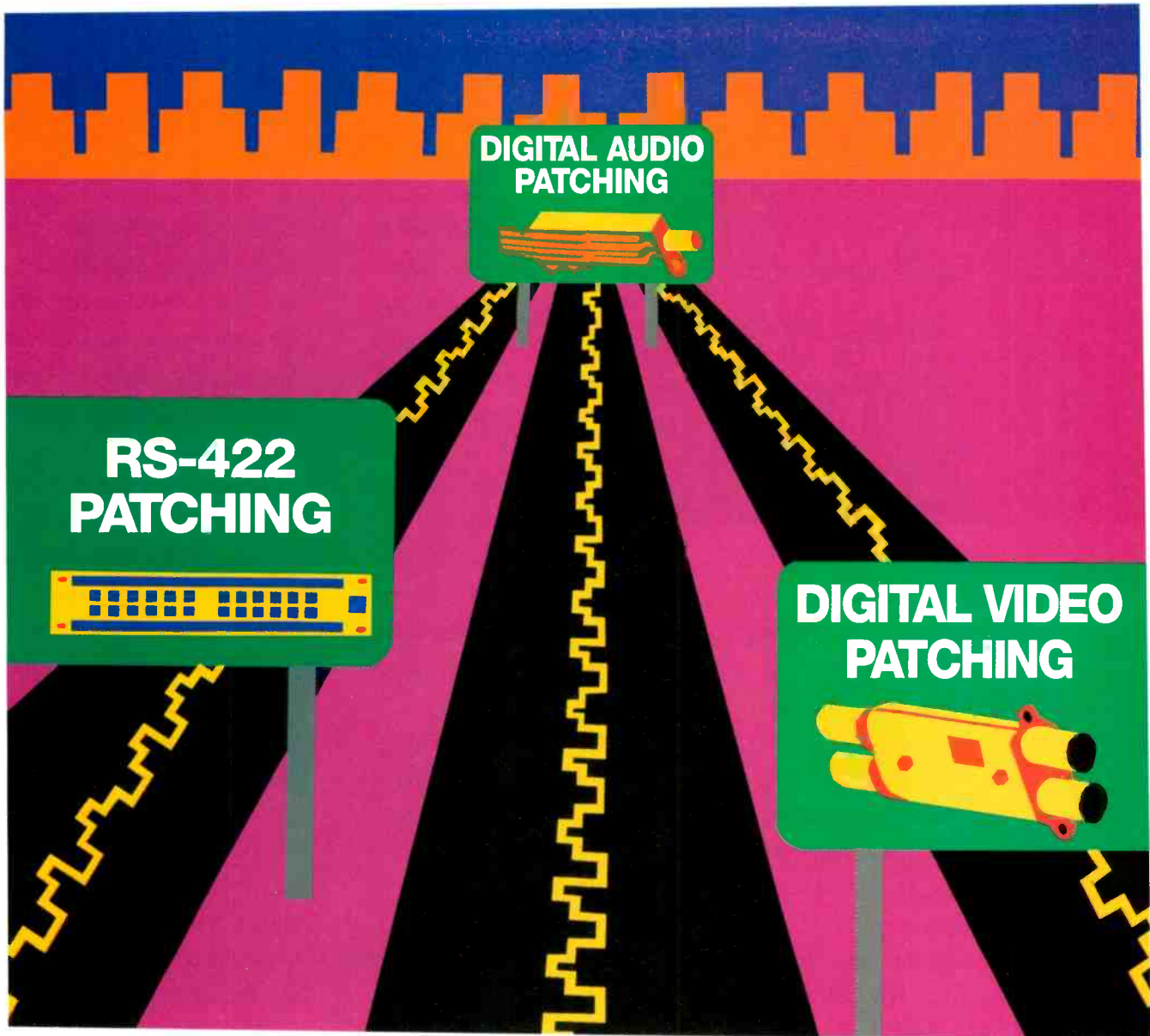

Three-Way Access To The Digital World.

Whether it's digital audio, digital video or machine control between VTRs and edit controllers, ADC's digital patch panels provide for the access, monitor and test of digital circuits throughout your studio or station.

Digital Video Panels

All ADC coax video jack panels are designed for composite analog, HDTV and serial digital video circuits, including D1, D2 and D3.

Digital Audio Panels

ADC's fully-normalled digital jackfields patch AES/EBU signals up to 100 meters. High-speed, data-grade cabling assures error-free transfer of the digital signal. The patented QCP split

cylinder contact ensures gas-tight connections that can be reconfigured up to 200 times.

Machine Control Panels

ADC Patch By Exception bays allow you to cost-effectively increase the number of ports available for your edit controllers and handle data applications up to 20 Mb/s, including 10 Mb/s Ethernet, T1 and ISDN.

For more information on ensuring the quality of your digital signal with ADC's full line of digital patching products, circle the reader service number below or call us at 1 800 726-4266.

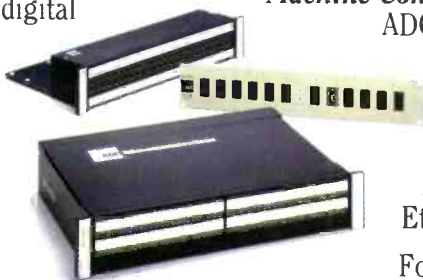

ADC Telecommunications

EVER WONDER WHAT SYSTEM CAN MAKE YOU MORE CREATIVE AND MORE COMPETITIVE?

Just when you thought your edit suite was complete, someone comes along and introduces "a better way" of doing things.

Your clients tell you they want it because it will give them more creative freedom.

Your business sense tells you if you don't buy it, your clients will go down the street to the post house that did buy it.

The trouble is, creativity has its price. D-1 digital component systems can cost a small fortune—and demand high maintenance while delivering low editability.

On the other hand, disk-based systems are powerful creative tools, but sources have to be transferred in real-time and the systems are limited to specific applications of short duration.

And perhaps worst of all is that gnawing concern that the technology you buy today may not be the technology you need tomorrow.

Not just a new product, a new perspective.

Ampex takes a different approach.

We looked at how best to apply the creative power of digital component technology to the practical competitive needs of your business—today and tomorrow.

The result is the Ampex DCT® system.

It gives your clients whole new worlds of creative freedom to explore, yet it gives you the flexibility to use the system in a full range of post-production applications.

So, for example, you can use it to produce a complex multilayered commercial in the morning, then turn right around and use it to edit a full-length television feature in the afternoon.

No other system in the world gives you that kind of capability.

And instead of gathering dust waiting for the right client to come along, it's generating revenue meeting the needs of all your clients all the time.

There are systems and there are "systems."

DCT from Ampex is the first complete digital component system available from one manufacturer.

And it is the *only* digital component system *designed* as a system.

It's an entirely new *solution* that, for the first time, makes digital component technology practical.

Each component has a full CCIR-601

industry-standard digital component interface, so it fits seamlessly with any other digital component equipment you might have or might acquire, from digital effects systems to real-time disk controllers to graphics systems to character generators.

In fact, DCT from Ampex can be the "glue" that pulls all your digital component devices together into a cohesive, flexible, powerful system.

Yet if you haven't made an investment in digital component technology, the DCT system is also the perfect entry point to this exciting resource. Every component in the system is optimized to match the operational characteristics of the other components, resulting in unprecedented levels of integration, performance, and efficiency.

It includes every element you need to implement a full CCIR-601 capability:

- DCT 700d Tape Drive
- DCT 700t Tape Cartridges
- DCT 700s Post-Production Switcher
- DCT 700e Edit Controller
- DCT 500a ADO® Digital Effects
- DCT 700i Analog Interface
- DCT 710i Distribution Amplifier

And every component offers you unmatched power, performance, and reliability.

The DCT 700d Tape Drive, for instance, is simply the best editing tape drive in the world. It is built

for demanding professionals, and employs the most advanced tape transport mechanism ever designed.

The DCT 700t Tape Cartridges were designed in parallel with the drive to provide unprecedented performance, consistency, and interchange, delivering a level of

be unavailable on the market.

The fact is, we thought of everything. So not only do you get the convenience of buying from one manufacturer, but you also get the security of knowing your system will *actually work* together when it's installed.

The Ampex DCT system is

The company that has been the leader in applying technical innovation to solve practical problems.

That's why the DCT system *today* is already more than a generation ahead of any other digital component system on the market—or on the drawing board.



compatibility unmatched by any other post-production system on the market today.

The DCT 700s Post-Production Switcher may well be the first sensible digital switcher ever designed, offering big-switcher performance and versatility in a small package, with unrivaled transparency in a full 4:2:2 digital component signal system.

The DCT system even includes the key interconnect equipment, because we knew these devices would otherwise

compact, sophisticated, and powerful. It was conceived and designed expressly to meet the demands of post production in a digital component environment, and to meet both the creative *and* competitive demands of your business.

It's not where you are, it's where you're going.

DCT is the digital component system from Ampex, the company that has been creating video solutions longer than anyone in the world.

So while other people keep waiting for the "next" millennium, you can seize all the advantages of this one now.

With DCT from Ampex.

AMPEX
DCT[®]

Ampex Systems Corporation
401 Broadway, M.S. 3-23, Redwood City, CA 94063-3199
©1993 Ampex Systems Corporation

Advent Communications

Lynx 2000-MA: lightweight, fast vehicle with Mantis flyaway package.

Mantis 1500, Mantis 1900 Ku-band: compact SNG terminals.

NewSwift: satellite earth terminal designed to be transported by station wagon, 4-wheel drive vehicle or minivan.

AVR 3950 satellite receiver: designed for professional FM satellite TV applications.

Circle (368) on Reader Service Card

AEQ

CR-01 remote control console: for Systel-3000.

Systel-3000: digital multiconferencing telephone system; enhanced design supports 16 telephone lines in full duplex.

BC-500 broadcast mixing desk: designed for small broadcast stations, very complete at a small price.

Automatic recording system:

TLE-02: portable frequency extender, digital hybrid.

Line distribution amplifier:

AM-03 audio monitor: stereo design, self-powered with input selector, phase display.

TH-02 Ext: enhanced version of TH-02 digital hybrid.

"European Standard" modular system: for audio signal processing; open system allows new compatible modules to be incorporated later; available in six modules.

Circle (369) on Reader Service Card

AF Associates

Product line includes: Turnkey systems design, engineering and fabrication; consulting engineering services; Radamec-EPO camera robotics, RP-2 pedestal, See-and-Select video touch-screen controller.

Circle (370) on Reader Service Card

AKAI

S2800/S2800 Studio/S3000 and S3200 model samplers: all feature a 32-voice architecture, 16-bit (64x oversampling) A/D conversion, 20-bit (8x oversampling) D/A conversion, and expanded program editing capabilities.

CD3000 sampler: world's first sampler to include a built-in CD-ROM drive; also includes five CD-ROM discs; 8Mb standard memory, expandable to 16Mb; SCSI port allows connection to external hard disks and other compatible devices.

DD1000 version 3.0 software: for use with DD1000, DD1000i and DD1000s; can control up to six DSP functions: Pitch Shift and Varispeed.

QMacII editing software: for use with DD1000, DD1000i and DD1000s; can control up to six DD1000's, allowing play commands to be sent to all units simultaneously.

DR4d hard disk recorder: 4-track hard disk recorder allows for affordable multitrack digital audio recording.

Circle (371) on Reader Service Card

AKG Acoustics

Blue Line: modular mics; ModuLock positive bayonet coupling; TransAct transducer capsules.

C 547 boundary mic: hypercardioid; non-reflective, low profile, visually unobtrusive.

C 647 gooseneck mic: studio mic with gooseneck mount; high-gain before feedback, hypercardioid pattern.

DSE 7000 Ver 3.0/3.5 software/hardware options: for DSE-700 workstation; include true tape-style listening, automatic punch-in; edit and mix features include new "move," "swap," library and "copy edit length" functions.

Qusted Q108 speakers: integrated processor, amplifier with optimized transient response.

Tri-Power series: additional models to the line of microphones.

C5900, C5600: condenser microphones.

C522/MS: dedicated M/S stereo microphone system for location production.

CK68/ULS: double barrel shotgun capsule for use with C460B modular mic system.

CK94: Figure-8 condenser capsule for use with Blue Line modular mic system.

Circle (372) on Reader Service Card

Alamar USA

Novell Gateway: permits automation, media management, net delay, time shifts and satellite recording and control to be performed via terminals of a Novell LAN.

Interface controller card: ESBUS/ESnet permits MC-2075 communication with BTS machine control.

MC-2075: automation system for 486 50MHz PC with XENIX/OS

MC-900: controls four automation channels, 64 devices.

MC-950FX: automation uses Sony Flexicart, other VTRs, laser disk recorders, master control switching, routers, still-stores, titlers.

Media Manager IV: central library management on RISC computer; bar code media tracking.

Mini-Media Manager: library management catalogs all media within the facility.

NDP-100SX: net delay for automatic time shift of 1 minute to 24 hours with 486SX-20 under XENIX/OS.

SC-2100: dual-interface, general purpose device programs; each controller handles two serial devices.

SPS-100SX: satellite resource management automates dish position, receiver frequency, audio subcarrier tuning, routing, VTR record/playback functions.

Circle (373) on Reader Service Card

Alcatel Network Systems/Telspanc

1741 VC video codec: for transmission of high-definition TV signals (1250/50 and 1125/60 standards) with reduced bit rate.

1718 VC (DIVA I) video codec: designed for telecom networks; select from electrical interfaces 140Mbit/s or 155Mbit/s.

Circle (374) on Reader Service Card



SCA Data Systems, Inc.

The Leading Manufacturer in SCA Products

Standard Products

- RD-57 RDS Generator
- 9600 BPS subcarrier data system
- Music 4® four channel audio/data system
- PG 57-3 phase-locked paging generator

Introducing

- Music 4® plus 9600 high speed data and audio system

SCA questions...We are the solution.

225 Arizona Avenue, Suite 350, Santa Monica, CA 90401 • Tel. 310/576-0655 • Fax. 310/576-0566

Circle (36) on Reply Card

Alden Electronics

WSR-88D, ALRAD: Doppler radar units with PC software for NEXRAD data acquisition.
MSAT-90 software program: menu-driven, window-based software system provides access to all of the data from the National Weather Service.
LPATS data service: lightning position and tracking service.
Video Information System: used to display LPATS data.
C-Band Satellite Data System: consists of a 2m antenna system and an Alden network receiver.
NEXRAD Information Dissemination Service: disseminates NEXRAD products for private sector.
Circle (375) on Reader Service Card

Alesis

ADAT: 8-track digital recorder uses S-VHS media; 16 units for 128 tracks; SMPTE TC; proprietary timing reference.
AI-1 interface: for ADAT to AES/EBU and S/PDIF with sample rate converter.
AI-2: single-rack space SMPTE/EBU time-code synchronizer for the ADAT digital multitrack recorder.
RMB option: 32-channel remote meter bridge for ADAT.
X-2 recording console: 24-channel, 24-tape monitor, 8-bus recording mixer.
BRC: master remote control for the ADAT digital recording system.
Circle (376) on Reader Service Card

Alexander Batteries

BPI-11: 13.2V, 1.5Ah replacement for Sony NP1.
BPIA: 12V, 1.8Ah for Sony NP1A.
BPIB: 12V, 2.2Ah for Sony NP1A and NP1.
Personal Smart Charger: microprocessor-based Rapid Charger/Conditioner.
Circle (377) on Reader Service Card

Alias

3DCD Volume 1: CD-ROM content library with hundreds of megabytes of 3-D models.
Open Digital Studio: provides open interfaces to the Alias modeling format and rendering functions.
Circle (378) on Reader Service Card

Allen Avionics

AVS filters: miniature packaged, LP video filters.
Isolation transformers:
Model 2873: zero-loss active video delays.
TDL-487: video delay lines for Video Toaster.
AVS series miniature low-pass video filters
Circle (379) on Reader Service Card

Allen Osborne Associates

Telescopic Hilomasts: include NH, NK, NL, NX, NY series of pneumatically operated mobile telescoping masts.
Circle (380) on Reader Service Card

Allied Tower

Product line includes: communications towers
Circle (381) on Reader Service Card

Alpha Image

Alphie: digital production switcher.
Circle (382) on Reader Service Card

Alpha Lyracon/Panamsat

Product line includes: Program distribution, transmission.
Circle (383) on Reader Service Card

ALTA Group

AP-30 production system: 4:2:2 analog video component switcher, effects, linear keyer, accessories; recording to videotape.
Centaurus SSR-1 still store: for 179 fields, 85 frames on removable hard drive.
Circle (384) on Reader Service Card

Altec Lansing

Model 8553B equalizer: tamper proof, program-

mable room EQ for control rooms, studios.

Model 1674C mixer: hands-off automatic operation; gain sharing, multiple mic system.

M100 loudspeaker: compact, 2-way monitor loudspeaker.

1684A mixer: expandable automatic microphone mixer.

1712A limiter: high-performance compressor limiter uses a feed-forward design.

9441A amp: 100W, dual-channel power amplifier.

9442A amp: 150W dual-channel power amplifier.
Circle (385) on Reader Service Card

Altronic Research

Air-cooled loads: 6700 series 5-75kW; Omegaline 6400 series 1-5kW.
Circle (386) on Reader Service Card

Amber Electro Design

Amber 7000: analog, digital audio generator, analyzer on 386/40MHz computer under Windows; digital processing, FFT analysis.
Circle (387) on Reader Service Card

AMCO Engineering

Catalog 450 Rev A: contains illustrations and descriptions of Amco's monitoring enclosures.
Catalog 500B: three styles of 19", 24" consoles.
Monitoring enclosures: single, multibay configurations, accessories; pedestal bases, sloped front and vertical frames.
Circle (388) on Reader Service Card

AMEK Consoles/TAC

BCIII modules: include BC348 for four mono mix-minus outputs; BC344 4-into-2 monitor mixer; BC324 quad group module.
EINSTEIN: automated mixer; compact, comprehensive metering, monitoring; 64 inputs, 4-band EQ; 24 balanced group outputs and tape returns.
Big by Langley: superconsole system; combines an on-board automation system with a recall system and in-line flexibility.
Circle (389) on Reader Service Card

VidCAD Teaches Your PC to Speak Engineer

The central graphic displays a grid of icons for VidCAD software. The categories shown are:

- Cable Commands:** CC, CE, PT, TD, etc.
- Architectural:** CAP, CG, KRI, DP, HF, WI, WO, WP, etc.
- VDP Furniture:** Winsted, Stantron, Emcor, GKM, Egipto, Generic, Blank Panel, etc.
- Utilities:** CDOC, Import text, Layer Change, Extract EX data, etc.
- PathTOOLS:** PC, PH, PE, RA, etc.

Callout boxes on the left and right describe key features:

- Create cable in 10 Sec in Dwg & dBase
- Cable labels, runlists, bill-of-materials
- Draw system interconnects from dBase
- Front/rear jack panels from dBase
- Full 3-D architectural tool set
- Extensive 3-D furniture library
- Auto cable length calculations
- 2-D & 3-D ergonomic analysis tools

Making Design into Reality

Facilities design and documentation software so fast, flexible and easy to use. You don't need to be an AutoCAD expert, draftsman, clerk-typist or programmer.

VDP • The CableDOC Company

• 749 Carver Road • Las Cruces, NM 88005 • (505) 524-8959 • Fax (505) 524-9669 • Sales (800) VidCAD-6 (US and Canada)
Circle (37) on Reply Card



American Broadcast Systems

MicroCart 100: PC-based automation in Windows environment.

Circle (390) on Reader Service Card

American Studio Equipment

CA04: small grip head.

ME160: 12K ear extensions; set of three.

Circle (391) on Reader Service Card

Ampex Corporation

DCT system: CCIR-601 digital component production system; high-quality multi-generation, digital layering capability for post-production; includes a new format 19mm digital component tape drive DCT 700d, DCT 700s post production switcher, DCT 700e edit controller, DCT 500a ADO digital effects system.

DST 600 series tape drive: single, stand-alone tape drive based on a robust 19mm helical-scan format; used for storing and retrieving large amounts of data; moves data at very high transfer rates.

Circle (392) on Reader Service Card

Ampex Recording Media

Product line: Video, audio recording media in all popular formats.

Circle (393) on Reader Service Card

AMS Neve

AMS Logic 1: options include built-in surround sound and optional joystick.

AMS Logic 2: large format, dynamically automated digital console; reconfigurable for film, video post, broadcast, music recording.

AMS Logic 3: dynamically automated mixing console with integral digital workstation, assignable control surface.

Neve 55 series: cost-effective broadcast analog console; 24-56 inputs.

Neve Capricorn: compact digital mixing console for music recording.

Circle (394) on Reader Service Card

AMX Corporation

Master port: expander.

AXU-MLCD uni-mount: mini-LCD panel.

Softkey+: liquid crystal touch panel.

AMX/Prism media retrieval system: manages media equipment operation and classroom program routing from a central location.

Circle (395) on Reader Service Card

Anchor/ROH

HME 3: standard intercom.

Passive audio monitor: 1-, 2-, 4-channel configurations in 3.5" high panels.

THX digital spectrum analyzer: analyzes sound systems' frequency response, theater's background noise and reverberation.

AN-100 powered monitor: features line-level RCA inputs, plus 1/4" phone inputs for microphones or musical instruments.

Circle (396) on Reader Service Card

Andrew Corporation

2.4M, 3.6M ESA systems: motorized and complete with controllers and receivers.

3.7M, 4.6M ES Antennas: carry Intelsat F-1, type approvals (F-1 for 4.6M); significantly reduces field test costs, expedites system turn on.

60 kilowatt ALP: antenna for full service.

9.3M ESA system: Intelsat B station system.

HDTV broadcast system: 12GHz, developed for international applications.

Hot-Plot, dB Freebie: software programs for HMD/MMDS coverage and power contours.

HRLine: rigid transmission line; increases reliability by 800%.

ValuLine Series additions: 18GHz and 23GHz microwave antennas.

Circle (397) on Reader Service Card

Angenieux Corporation

20x8.5: 20x zoom; coatings reduce chromatic aberration; 0in MOD; Multi Range Extender for on-air selection of extenders; Teleshot focus feature; for 2/3" CCD cameras.

14x FPL series: lightweight ENG/EFP lens; f/1.6 for 2/3", f/1.4 for 1/2"; lower light capability; CCD optimized; integrated UV filter.

14x6.6: ENG lens for 1/2" cameras.

14x8.5: rugged design for 2/3" cameras.

14x Anamorphic: lens converts 4:3 aspect ratio camera to 16:9 HD format; 14x6.7 for 2/3", 14x5.6 for 1/2" with focusing to 2.6 feet; 8.8 pound lens is 10.6 inches long; 30% wider horizontal angle in 16:9 mode.

15x6.5/15x5: extremely wide angle lens for studio and OB CCD cameras.

Circle (398) on Reader Service Card

Anjon & Associates

Playmotion Version 1.48: 3-D character animation program; object and file compatible with Macintosh, IBM PC/Windows and Commodore Amiga.

Circle (399) on Reader Service Card

Antenna Concepts

MMDS slot antenna: for wireless cable; wideband directional or omnidirectional.

Broadcast antennas: complete line of UHF and FM antennas, circularly polarized, linearly polarized, horizontally polarized directional and omnidirectional models available.

Circle (400) on Reader Service Card

Antenna Technology

PROFLINE systems: digital audio satellite systems for radio and CATV networks.

Vanguard Instruments VI 2.0: high-precision, multifunction satellite spectrum analyzer, receiver, monitor; covers 900-2000MHz with 10MHz bandwidth.

Circle (401) on Reader Service Card

Anthro

Technology furniture: mobile, modular carts in various sizes for use with computers, rack equipment, multimedia applications.

Circle (402) on Reader Service Card

Anton/Bauer

Automatique: On-camera light control circuit for Gold Mount bracket system; turns on camera light when VTR starts recording.

DM-4 discharge module/battery evaluator: diagnostic accessory for Logic Series MP-4D charger.

Logic Series digital battery system: advanced NiCad battery and charging technology with on-board microprocessor and LCD display.

MP-4D: Logic series 4-position sequencing fast charger; multifunction LCD display.

UltraLight 2: on-camera accessory light; low voltage; compact size; quick change head modules, filters, lamps.

Satellite: portable light requires no cables, light stands or special batteries.

Circle (403) on Reader Service Card

Anvil Cases

Transitainer: air- and water-tight reusable case for transporting valuable equipment.

Courier carrying cases: molded A.B.S. shell; lightweight; available in various depths.

Rotorack rackmount cases: line of rotationally molded cases; lightweight; waterproof.

Exhibit PRO case: can hold everything needed to set up a 10'x10' or larger booth.

Circle (404) on Reader Service Card

Aphex Systems

Model 400 Digidocoder: FM stereo generator; HP limit. LP filter; digital control, analog processing.

Model 8126: modular audio DA; no transformers; 6 out by 1 in; servo balanced.

Model 9901: parametric EQ uses tone shaping with overlapping filter bands for multiple EQ settings in a given bandwidth.

Dominator II: single-channel multiband peak limiter with zero overshoot.

Type C² Aural Exciter: improved circuitry makes it quieter, more musical and easier to use.

Circle (405) on Reader Service Card

Applied Digital Technology

SST option: sequence store option for the VSS.D1 digital disk recorder.

VSS.D.1: digital disk recorder; provides six to eight minutes of real time video record or playback plus storage for 150 stills.

Circle (406) on Reader Service Card

Applied Memory Technology

Model 7422 component video recorder: digital system with 100s disc-based, real time, 4:2:2 storage.

Circle (407) on Reader Service Card

Arrakis Systems

Digilink audio system: includes units to replace standard cart machines, cassette/reel recorders in live, automated radio.

TrakStar-8: multitrack hard disk recorder.

TrakStar-2: digital recorder/editor for multihour audio program production.

Circle (408) on Reader Service Card

Arriflex

Electronic Ballasts: for 575W, 1.2kW, 400W, 600W, 12kW.

ArriSoft/Fresnel: portable light kit includes ArriSoft 1000, ARRI 650 Fresnels; ArriSoft accepts 500/750/1kW lamps; interchangeable reflector.

ArriSun HMI: fixtures for 2.5kW, 400W.

Compact HMI fixtures: 575W, 1.2kW, 2.5kW.

ArriSoft 1000, 2000: softlights, interchangeable reflectors.

16SR-3 camera: 54mm PL mount makes it easy to change the format from normal to Super 16 filming.

535B: lightweight companion camera to 535.

Geared Head 2: smaller, lighter version of Geared Head.

Circle (409) on Reader Service Card

ART/Applied Research & Technology

The Phantom series: 16-, 24-input recording consoles.

Multiverb LTX: includes 250 multiple effects combinations; three simultaneous effects; 16-bit processing.

SGX series: production processors; SGX-T2 multi-effector, pitch transposer, programmable preamp; SGX-LT preamp and effects processor.

STX-2000/SGX-Nightbass: integrated digital effects designed to provide extensive effects for guitar, bass guitar players; uses 12AX7 tube preamp stage.

DRX 2100 Wonder Processor: studio and live sound 24-bit digital audio processor.

SGX-Nitro: 1 high rack-mounted signal processor/preamp/pitch transposer/tuner.

Circle (410) on Reader Service Card

ASACA ShibaSoku

AD725D automatic distortion analyzer: capable of analyzing -120dB distortion; digital filter provided.

AG31A audio analyzer: numerous digital signals available for evaluating any kind of digital audio equipment.

AU50A audio D/A converter: for AG31A; when combined with model AX50A input adapter, it is possible to accept a large number of channels.

CC61B1 color encoder: capable of RGB or Y, R-Y, B-Y component signal; equipped with gen-lock.

CM22C6 HDTV 20" color monitor: .31mm dot pitch, in-line CRT; more than 850 lines of resolution; quality sharpness and luminance.

CM205N6: 20" HR (900 TV lines) auto setup monitor.

CM206N6: 20" HR (900 TV lines) multistandard



S VHS

With Panasonic's S-VHS newsgathering systems you can lower the cost of being there without lowering the quality of your look on-air.



Panasonic Digital Signal Processing cameras dock directly to our S-VHS VTRs. DSP gives camera operators the benefit of Panasonic Emmy award winning technology: near-instant set-up on the scene or in the newsroom; on a pedestal or on your shoulder; outdoors, indoors, day or night.

Panasonic's AG-7000 and AG-5000 Series S-VHS VTRs provide news departments with rugged,

fully featured edit bay systems with multiple audio tracks, S-component video, and available SMPTE Time Code.

TO GET THE NEWS, YOU HAVE TO BE THERE.

Need tape stock in the field? S-VHS and VHS are so widely available, it's virtually impossible to be caught without stock.

You can even roll "amateur" VHS video into your program.

S-VHS from Panasonic. It's everywhere and anywhere. Think of it as the next best thing to a bigger budget.

Panasonic
Broadcast & Television Systems Company



"COME AGAIN!"
"Whadya Say?"

It's Basic

When it's air time, and you have to worry about; a fast-paced camera sequence, unpredictable sequence timing, audience reaction, VTR cuts and commercial breaks – clean, clear, efficient communication shouldn't be among your concerns.

NAB '93 - Show of Shows

auto setup monitor.

RT81A multichannel signal generator: wide bandwidth range of 30-2,100MHz; accepts M, B/G, D/K, I, L formats.

TG21A1 TV test signal generator: able to configure PAL, component, Y/C and test pattern signals.

TG33A6 HDTV test signal generator: can generate high-resolution test pattern.

TG94C TV test signal generator (EDTV/NTSC): advanced NTSC aspect ratio of 16:9 and 4:3; generates 12 different test signals.

TP22AX: NTSC/PAL pattern generator (monoscope) equipped with gen-lock.

Circle (411) on Reader Service Card

ASC Audio Video Corporation

ASC Clean & Trace software: PC-based software with facilities for clean and trace functions of all industry-standard EDL formats.

Linear and Non-Linear Editing System: expandable, upgradable off-line system for videotape or Virtual Recorder.

Virtual Recorder: emulates videotape machine without the tape; capacity for 1/2-hour video, two audio tracks and SMPTE time code.

Case 3.0 Edit Controller: the ability to manage up to seven bins of 1,000 edits each.

Circle (412) on Reader Service Card

Associated Production Music

Broadcast 2 series: 30 selected CDs with updates; commercial, full length cuts.

Circle (413) on Reader Service Card

Astrodesign/Mira Vision

MC2001 multimedia scan converter: multi-window display for NTSC, computer graphic images.

Synthevision HM7010A: background link-up for chroma-key synthesis; links 2-/3-D computer graphic background image to pan, zoom, tilt, focus.

MC2000: multimedia scan converter.

DE-640: NTSC digital color encoder.

DD-660: NTSC color decoder converts NTSC composite video signals and Y/C separate signals (S connector) into analog component R/G/B signals.

VG-829/VG-815/VG-825: series of programmable video signal generators.

VG-816/VG-817: TV/HDTV test pattern generators.

Circle (414) on Reader Service Card

AT&T

Product line: communications equipment services.

Circle (415) on Reader Service Card

ATI Audio Technologies

System 10,000 modular amplifiers: distribution, line-buffer, microphone units; 10 interchangeable plug-in modules per frame.

Circle (416) on Reader Service Card

Audi-Cord

Product line includes: Audio cart recorders/players, DL series and S series.

Circle (417) on Reader Service Card

Audio Accessories Inc.

DCE/Audio Accessories AES/EBU patchbay: digital audio patchbay; guarantees proper AES/EBU 110Ω line impedance, termination and waveform.

Circle (418) on Reader Service Card

Audio Action

FEX 01-10 Sound Effects Library: digitally mastered material; wide range of effects.

Joseph Weinberger Ltd. series: 10 CDs include ethnic, classic, jazz, guitar, other types.

KOKA Media: CDs of music, effects.

Zzebras series: CDs include new age, jazz, pop, world music, dance, rap, R&B, Funk; Sitcom Comedy materials.

Circle (419) on Reader Service Card

Audio Developments

AD006-13 Flex-EQ: 2-channel, 2-band peak/dip, parametric equalizer.

AD083 Flex-EQ The Ultimate Equalizer: parametric design with non-interacting control over all parameters.

AD146 on-location mixer: 4-output with M-S decoding; 6-12 inputs with mic/line modules.

AD261 ENG mixer: stereo; M-S decoding; four mic/line XLR input connectors.

Circle (420) on Reader Service Card

Audio/Digital

Product line: Audio delay products, TC-4 digital processors with profanity delay.

Circle (421) on Reader Service Card

Audio Ltd.

See Murry Rosenblum Sound Assoc.

Circle (1200) on Reader Service Card

Audiomation Systems/Sellmark

Uptown 990: hardware for Uptown automation systems.

Uptown Automation System Film Software: for film and AV post-production.

Uptown Automation System 990/LIVE: for live sound applications.

Circle (422) on Reader Service Card

Audiopak

Compact Cassette/DCC components: leader tape, graphite liners for Compact Cassettes, Digital Compact Cassette units.

Circle (423) on Reader Service Card

Audio Precision

ATS-1: GPIB-controlled audio test set for general purpose audio testing.

Enhanced FAST TRIG: software demonstration yielding up to 160 measurements with a stimulus of less than one second.

Circle (424) on Reader Service Card

Audio Processing Technology Ltd.

ACE100 PC expansion card: includes simultaneous playback record features.

DSM100 digital audio transceiver: enhanced with Inverse Multiplexer (I-MUX) option.

DSM100 ISDN multiplexer: full-bandwidth audio transmission for one to three 56/64kbps data lines; full-duplex inverse multiplexer, terminal adapter to ISDN phone.

Pro-Link: provides dial-up full bandwidth digital audio; combines an ISDN terminal adapter with an intelligent 6-channel inverse multiplexer in a single, compact unit.

Circle (425) on Reader Service Card

Audio Services Corporation

PSC M-4: portable audio mixer.

Circle (426) on Reader Service Card

Audio Technica US

AT825 OnePoint: stereo mic for pro DAT.

MT830R: ultra-miniature condenser mic for lavalier or concealed applications.

AT4033: transformerless studio condenser microphone.

AT822 OnePoint: stereo mic for field recording, DAT and video camera compatible.

AT933 Engineered Sound Microline: miniature and subminiature condenser microphones.

Circle (427) on Reader Service Card

Audio Video Engineering

Product line includes: video hum stop coils.

Circle (428) on Reader Service Card

Auditronics

800 series: on-air consoles; stereo program, audition, utility, aux, two mono output buses.

850 series: production consoles, similar to 800 series for smaller market news, on-air and production; integrated in-line processing, preselection.

AirMaster 90: low-cost consoles for broadcast with satellite delivery and live-assist operations.

Circle (429) on Reader Service Card

Augan Instruments

Enhanced 408 OMX: optical multitrack recorder/editor.

408 S OMX: optical multitrack recorder/editor includes DSP board.

808 OMX: 19" expansion optical multitrack recorder/editor give 408 OMX an addition four input channels.

Circle (430) on Reader Service Card

Aurora Systems

Liberty: HR paint. animation; hardware/software or software only.

Liberty 2.0: addition to Liberty paint and 2 1/2-D animation software program.

Circle (431) on Reader Service Card

Autogram

Mini-Mix 8: mixer with two stereo, one mono output buses; 12 stereo inputs; VCA devices; cue amp, speaker.

Circle (432) on Reader Service Card

AVCOM of VA

SDM-42A spectrum display monitor: panoramic signal display for VHF scanners, communications receivers, such as ICOM R-7000.

NASA 1000A network and spectrum analyzer: combined analyzer package.

Circle (433) on Reader Service Card

AVID Technology

Broadcast series: Media Recorder digitizes signals directly to disk for editing; Newscutter quick program editor for TV news environment; Airplay direct-to-air broadcast of digital programming.

AudioVision 2.0: cost-effective multitrack digital audio editing system; sync-locks digital picture to audio for fast, precise editing.

Media Composer ONLINE: random-access video editor; advanced editing functionalities.

Media Suite Pro: complete desktop video production system; software and boards for Macintosh.

Film Composer: digital non-linear editing system

designed for film and video editors; based pm new 5/0 software; 24fps playback for NTSC and PAL.

All-Digital Broadcast News products: NewsCutter digital non-linear editing system provides instant random access to materials stored on high-speed disks. AirPlay disk-based digital playback system eliminates need for pre-roll. Media Recorder VTR replacement system captures incoming feeds directly to disk in real time; records 16-bit digital audio, compressed digital video and time code to high-speed disk drives.

Open Media Framework: cross-platform, cross-application standard for the exchange of digital media.

Circle (434) on Reader Service Card

Avitel Electronics

ADA 3233, ADA 3234: audio DAs with remote gain control; 3233 single-, 3234 dual-channel.

ERF 3300: communication frame.

TSL RMA assemblies: standard rack-mount cabinets for videocassette units, monitors; by Television Systems Ltd.

VDA 3214: 3-channel component analog VDAs; 5 outputs; 30MHz, 50MHz bandwidth EQ; clamp.

VDA 3320: serial digital video DA.

VDF 1026: serial digital video patch panel.

DSE 3325: digital video CCR 601 component serialiser.

Circle (435) on Reader Service Card

AVS Broadcast

CYRUS standards converter upgrade: alters system to full motion-compensated interpolation; 10-bit processing with 5.5MHz video bandwidth; D-1, D-2 interfaces; analog composite NTSC, PAL, SECAM and component YC-525/-625.

DX120, DX210: digital format translators.

EOS TV standards converter: bidirectional conversion among all composite and analog component standards.

INTEGRA upgrade: digital mixer with digital video effects; 4:2:2 architecture; internal routing with priority positioning; multiformat interfacing.



"Great shot!"
"Nice move!"

Quality Production, Quality Intercom... No Coincidence!

Anyone who's been on the working side of a hectic control room knows that the relationship between communication and a successful production is basic. So, as production demands increase, make sure your most basic piece of equipment, the intercom, is the one that broadcasters the world over rank best — an RTS Intercom System!

Check out the new modular series, it has all the quality and reliability that RTS is famous for, with system costs that fit just about any budget. And as always, you'll benefit from the same knowledgeable customer support on which the industry has come to rely. In New York, call (201) 891-6002; in the Midwest: (313) 360-0430; in Burbank, CA: (818) 566-6700.

When it comes to communication, let's get down to basics.



Shown here, the MCE 325 User Station with MCS 325 Speaker Station in various modular combinations. Shown above, Model 802 Master Station.

RTS BY TELEX

Circle (38) on Reply Card

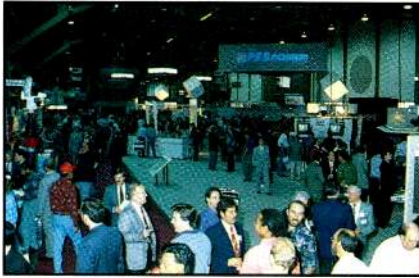

ISIS Q: standards convert upgrade with adaptive digital comb filter, motion adaptive post processor; chrominance, luminance noise reduction feature.

Circle (436) on Reader Service Card

Access USA

Product line includes: RDS communications systems and pagers, featuring alphanumeric, worldwide, multilingual paging with serial downloading capability to PC or printer.

Circle (1206) on Reader Service Card

Aydin Corporation-HPA/Magnetics

2100 TC/2100TC3.0 series: C-Band TWT power amplifiers.

2100 TK series: Ku-band TWT power amplifiers.

2100KC/2200KS/2100KKU: series of klystron high-power amplifiers.

Circle (437) on Reader Service Card

B

BAF Communication

VSAT-18: EBS mobile satellite uplink.

IFB-MSI: IFB management system.

SNV 3.7a: network sports uplink.

SNV-8000c: satellite news vehicle.

SNV-8000E: satellite news vehicle.

DPS-2000: Dual-Path uplink RF system.

SNV 4600LP A&B: satellite news vehicle.

ENG/EFP-20: remote production vehicle.

Circle (438) on Reader Service Card

Band Pro Film/Video

From SM Technologies: time-code sender.

From the Track Factory: SuperTrack versatile tracking system.

Rear viewfinder mount.

From Keywest: Magic Dolly with Black Track mini jib arm; battery busy box.

For Steadicam: Genio remote control system.

From Alfred Chrosziel: 4x4 Mark III mattebox with wide angle housing.

From Elmo: lipstick cameras with underwater housing, remote control, environmental housing.

Circle (439) on Reader Service Card

BARCO Industries

CVM 2551: 20" multistandard viewing monitor; rack-mount.

Digital inputs: for CVS/CVM 2000; series of D-1, D-2 digital input boards for serial and parallel signals.

FSM 860: field strength monitor for CATV headend; monitors, supervises, evaluates level, modulation of all carriers in a cable or similar RF network.

HDM 2051, HDM 2081: 20" and 32" HD multistandard units with CVS "intelligent monitor" philosophy; with auto setup; for any of the five existing HDTV signals.

CPM 2000 series: grade 3 monitors; 21" or 28" flat square CRT; menu-driven; composite inputs; quad decoder; component RGB/S-VHS input, optional RF input.

CVM 2137, CVM 2537: 14" CVM 2000 series; minimum outside dimensions for OB van or monitor walls; front mounted keyboard (-2537); soft keys on lower bezel margin (-2137).

CVM 2500 series: grade 2 monitors; 14" hi-res, 20" medium-res CRT; menu-driven; composite inputs; quad decoder; component RGB/S-VHS input.

CVM 2070: 28" multistandard viewing monitor.

TC450: frequency agile converter for cable, satellite reception.

CVS series: intelligent rack-mountable master control monitor; available in two dimensions: CVS 37IH (14"/37cm) and CVS 51IH (20"/51cm).

CVM 2000 series: control color monitors with auto setup; available in two sizes: CVM2037 (14"/37cm) and CVM 2051 (20"/51cm).

Circle (440) on Reader Service Card

Barco-EMT

BEDAS MOD recorder EMT 466: minimum of 3.2 hours stereo recording capacity; 5" removable, erasable magneto-optical disk media.

EMT 981 system: professional CD player with EMT-981-S remote control cassette operates up to three players.

Circle (441) on Reader Service Card

BASYS

Archive II: full-featured text storage, retrieval system; fast response from RISC hardware.

D-Cart: digital audio editing, playback system with hard disk storage.

LKT 200: pay-per-view system controlling video-disc players.

RMS resource management system: tape tracking, input recording and Lines booking software.

Circle (442) on Reader Service Card

Baron Services

OmniTrac: provides display of severe weather's estimated time of arrival for any populated community in your viewing area; 486-based stand-alone.

OmniLert: dual-control, automated instant alert system; 486-based stand-alone.

Circle (443) on Reader Service Card

B&B Systems

AM-2HR: cost- and space-efficient half-rack stereo phase monitor.

Imagescope IM-1HR: provides CRT display of stereo audio signal showing right/left direction and level in real time.

Circle (444) on Reader Service Card

BCS Broadcast Store

Product line includes: Broadcast equipment sales, brokerage.

Circle (445) on Reader Service Card

Beaveronics

Favag Crisalttime: master and secondary clocks for facilities time keeping.

MobaTime series: programmable master, facilities clock system by Swiss Moser-Baer.

Circle (446) on Reader Service Card

Bec Technologies

AudioPlex/Pro-Line products: 16-channel A/D transmitter, repeater; MP16 16-channel mic pre-amp, splitter; FB2 fiber-optic transceiver module.

Fiber-optic STL systems: modular, digital fiber-optic systems can transmit up to 64 channels of full-bandwidth bidirectional audio.

DataPlex Model FBII: fiber-optic transceiver; multiplexes and demultiplexes up to four audioplex 16-channel conversion and communication.

Circle (447) on Reader Service Card

Beck Associates

Series A modular consoles: accommodate any room and all equipment, including computers, non-rack mount monitors.

Circle (448) on Reader Service Card

Belar Electronics Lab

AMMA-1 digital AM modulation analyzer: remote control, PC and Wizard software.

FMM-2/FMS-2: FM modulation monitor set.

FMRR-1A/FMRR-4 receivers: for FM rebroadcast; -1A fixed frequency, -4 frequency agile.

Circle (449) on Reader Service Card

Belden Wire and Cable (Division of Cooper Industries)

#8281: serial digital cable.

#9180: digital audio cable.

#9292: serial digital cable.

Circle (526) on Reader Service Card

Bencher

VP400 Replicator copystand: supports heavier video, large format still cameras to 40 pounds.

Circle (450) on Reader Service Card

Benchmark Media Systems

Jr. Audio Director: combines mode and level control functions as well as selections for left only, right only mono, stereo, reverse, right channel.

Circle (451) on Reader Service Card

BEXT

PJ 501, PJ 1002: solid-state amps for 500W, 1kW; MOSFET devices; lightweight, low power consumption; switching power supplies.

D series: series of FM amplifiers; available in power levels up to 15kW.

SF 500: Slimline 500W FM amplifier.

SS 1000: 1kW solid-state TV amplifier.

Circle (452) on Reader Service Card

beyerdynamic

MC 834: large diaphragm condenser microphone for on-air, voice-over applications.

TE 170: VHF wireless mic system; DT505 earphones; mini receiver, body pack transmitter.

U 700 series: UHF wireless system; 12 channels in 8MHz band; hand-held, body pack transmitters; enclosed mainframe houses.

MC 833: stereo EFP mic; condenser with internal M-S and X-Y capability; three separate diaphragms.

DT 150: stereo monitoring headphones for in-studio, on-location monitoring.

DT 190 series: headset with microphone; high sensitivity, fast transient response, high rejection characteristics of off-axis sound.

M 424: mini supercardioid dynamic mic with TG-X rare earth neodymium magnets; high sensitivity, tight polar pattern.

HEM 190/191: cardioid and omnidirectional gooseneck mounted, miniature electret, condenser mics.

MV 100: compact, lightweight stereo pre-amp; measures 145mmx 85mmx40mm.

S 150/S 250/S 350: series of VHF wireless microphone systems; all available with hand-held transmitter, pocket pack transmitter.

Circle (453) on Reader Service Card

BGW Systems

Model 2242: high output DA.

Models 85, 200: broadcast quality "U" model amplifiers.

Performance Series 2 stereo power amp: 200W per channel feeding 8Ω loads; welded steel construction with modular circuitry.

Rack-mount PCs: U86, an upgradable ISA bus machine and EISA + local bus design.

Circle (454) on Reader Service Card

Bi-Directional Microwave

HDTV microwave: carries all HD format, Y/C (PA, PB) and digitally compressed formats.

Fiber-optic video transformer.

DS-1, DSC, DS-2 microwave: for telephone, data bypass applications.

Broadcast-quality transceivers: for fixed STL and portable ENG video/audio, telephone and data transfer; available in all frequencies between 10-26GHz.

Circle (455) on Reader Service Card

Bogen Photo

Product line includes: camera support; Mini-Pro tripods.

Circle (456) on Reader Service Card

Bowen Broadcast Service

Product line includes: Replacement parts for RCA automated cart equipment.

Circle (457) on Reader Service Card

Bradley Broadcast Sales

Product line includes: Distributor; Telos telephone systems; Unity audio processors; audio signal bandwidth filters.

Circle (458) on Reader Service Card

Bretford Manufacturing

TVUM: mount brackets for TV monitors.
TVVY20BK: wall/yoke TV mount for 20" monitor.
TVMP: ceiling/wall plate for TV mounts.
TVPW27R-BK: platform/wall TV mount with VCR bracket.
1992 Product Guide: furniture for computer workstations, libraries, editing stations, etc.
TVCY35T-BK: ceiling yoke TV mount for monitors to 35".

Circle (459) on Reader Service Card

Broadcast Automation Inc.

Product line includes: Radio automation equipment.

Circle (460) on Reader Service Card

Broadcast Electronic Services

Betabox BBS-900.

Bittree RS422: patch panel.

TBC/r remote control: presets for unity gain of video, chroma, hue, setup control.

Circle (461) on Reader Service Card

Broadcast Electronics

Air Trak 100: configurable linear console.

AM series: AM transmitters with Class E PAs; AM-1 1kW, AM-5 5kW, AM-10 10kW; full solid-state; C-QUAM stereo.

AM-2.5: 2.5kW addition to line of AM stereo transmitters; features Call E amps delivers overall efficiency of 77%.

Disc Trak: digital cart machines uses 3 1/2" floppies; 112s full-band stereo per disc; 16-bit sampling.

FM-1C: 1kW FM solid-state transmitter based on FX50 exciter.

FM-100C: low-power, solid-state FM transmitter for main or emergency backup applications.

FM-500C transmitter: features a 500W solid-state combined broadband RF power module; output is variable from 0 to full-rated power.

VMC-16: remote control provides full transmitter and facilities monitoring and control via touch-tone phone lines or a built-in computer modem.

Circle (462) on Reader Service Card

Broadcast Microwave Services

Guardian III system: transmitter management software for 1,000 sites of 50 types; supports Guardian I, Gentner, Burk Technology, SVS Computer interface on single phone and/or computer line.

Guardian system: senses conditions at the transmitter plant; shows status on CRT with failure alarm, restoration and in-tolerance conditions.

SVS computer interface: links remote capability with 16-256 input status/measurement channels; 8 to 128 output control channels.

Circle (463) on Reader Service Card

Broadcast Supply West/BSW

Product line includes: Distributor, approximately 200 lines of professional audio, RF/radio products.

Circle (464) on Reader Service Card

Broadcast Video Systems/BVS

CARDKEY: linear keyer, fits in GVG, Leitch Video DA frames.

CP-600: video proc amp; fits in GVG, Leitch Video DA frames.

VM-400: 4x1 video switch matrix; fits GVG, Leitch Video DA frames for composite or component video; expands to 4x4, 8x2 with 3 or 4 layers; remote control via coax.

Delay lines, filters: passive and active types.

RGB/component: transcoders:

YC 700: YC to R-Y, B-Y or RGBS transcoder; plugs directly into a Leitch Video or GVG DA; also available in the FR3 1/2-rack width frame with power supply.

VBI-232: plug-in encoder/decoder; designed to plug into a Leitch Video or GVG DA frame.

Circle (465) on Reader Service Card

Broadcasters General Store

CRL event timer: produces timed relay closures

for day-parting with Audio Signature unit.

Miltronics MCS: multiline coordinating system; cardframe holds 18 auto coupling phone cards or combination of cards with DAs.

Rodman/Brown Desk Jockey: PC-based, hard disk commercial storage/satellite automation system; complete, total automation for 14-day walk-away time.

ST60 VTR controller: by DNF Industries.

CFT Tower Sentry: 24-hour a day, 7 days a week service for monitoring of tower lights.

Circle (466) on Reader Service Card

Bryston

4BNPB power amp: 250W/channel stereo uses soft-start circuit.

8B: 4-channel power amplifier.

Circle (467) on Reader Service Card

BSS/AKG Acoustics

FCS 926/920 Varicurve: parametric EQ/analyzer system; -296 features full digital control of 12 parametric EQ sections.

Circle (468) on Reader Service Card

BTS Broadcast Television Systems

Alamar: master control switcher.

BCS-3000/PC master control: PC-based version BCS 3000 control system.

Betacam SP equipment: VTRs, camcorders, players, peripherals.

DCR 300: D1 VTR includes integral A/D, D/A converters as found in DCR 500.

LDK-910SR, LDK-491: mid-studio camera and ENG/EFP camcorder.

LDK-9SR, LDK 9P-SR: studio and companion portable cameras; features FT-5SR CCD sensors; top-of-the-line systems.

LDK-93SR: frame transfer CCD ENG/EFP camera system.

MARS router: 24x8 matrix; input/output expandable; 30MHz bandwidths; RAM stores configuration with battery backup.

MNR-9: noise reduction system with 3-D median

DIGITAL AUDIO NETWORKING



THE COMPLETE SOLUTION!

The DSM100 Digital Audio Transceiver permits the low cost transmission of professional quality stereo audio between studios. Using both SW56 and ISDN digital telephone lines your studio network can now operate nationally or internationally - without compromising audio quality!

The DSM100 offers:

- Proven **apt-X** professional audio quality
- Bandwidth up to 24KHz Stereo
- Integral SMPTE timecode reader/generator
- Full duplex operation over SW56/ISDN
- Compatible with leased digital lines

Call APT NOW - and get connected!

Audio Processing Technology
 Edgewater Road, Belfast BT3 9JQ Northern Ireland
 Tel 0232 371110 Fax 0232 371137



Audio Processing Technology
 6255 Sunset Boulevard Suite 1026 Los Angeles CA 90028 USA
 Tel 213 463 2963 Fax 213 463 6568

apt-X and apt-X are registered trademarks of Audio Processing Technology Ltd

Circle (39) on Reply Card

filter leaves H/V bandwidth intact; motion detection cuts motion smear; dual 4:2:2 frame stores; grain reduction.

DCR 500: D1 VTR for post-production; no external A/D, D/A converters needed; setup cards for custom operation menus; four units in parallel record HDTV.

Dyad2 keyer: for D-2 VTRs, permits unlimited digital layering.

E\Clips: desktop video production system.

FDL-90 telecine: CCD system with switchable aspect ratios; 4:3, 16:9 in 525-/625-lines.

Motif: titler uses PostScript Type 1 fonts; dynamic motion rolls, crawls; developed with Paltex, Aston Electronics; Vector display effects.

Prizm DVE: full-featured broadcast/post-production DVE with DVEator 3-D graphics maps.

Enhanced Venus: high-density router; 2,048 audio, 1,024 video crosspoints per unit; intermix HDTV video, 400Mbit/s serial digital video, stereo analog audio and AES digital audio.

Diamond-digital series: family of serial component production systems.

Jupiter: PC-based control system; includes a family of flexible control panels, intelligent interface boxes, and protocols and electrical interfaces.

Philips Vector Video Echo Canceler: eliminates unwanted ghosts and echoes from retransmissions of broadcast TV channels on cable TV.

Circle (469) on Reader Service Card

Burk Technology

LX-1: 6-input stereo audio selector.

Model ESL: enhanced speech interface unit for the ARC-16 transmitter remote control system.

Circle (470) on Reader Service Card

Burst Electronics

VDA4: video DA 1x4 gain adjust, 25MHz BW.

PVS-100: production switcher 4-in, prv out, pgm out, key in (TTI), key fill in, GVG 100 protocol.

VDS: video detector/switch 2-in/1-out, tally out detects loss of video on A, switches to B.

VMF-2: 2-channel video mixer/fader 2-in/1-out, dissolve A to B, B to A fade to black, "take" 0.2 to 6 second GPI digital control.

Circle (471) on Reader Service Card



Cablewave Systems/RF Systems

Bogner directional antennas: for low-power, medium-power TV.

E-30 waveguide, connectors: for MMDS/ITFS.

Expanded Flexwell line: new sizes of coaxial cable and elliptical waveguide.

FM power dividers: for directional antenna use.

PAT 8-65: single-polarized, standard truncated design antenna; 6.875-7.125GHz range.

Circle (472) on Reader Service Card

Calaway Editing

CE-400: on-line, off-line edit control; 80486SX CPU, 4MByte memory; VGA color display; 12 RS-422 VTR ports; 9,998-line main EDL memory.

Circle (473) on Reader Service Card

California Amplifier

Low-noise downconverter and Yagi Antenna: second-generation LNBY; integrated 31 channel MMDS used by wireless cable systems for signal reception at subscriber receive sites; 1-piece unit.

Mag-90 LNB: for U.S. TVRO applications; integrated low-noise downconverter with built-in 90° waveguide; output of 950-1,450MHz.

Circle (474) on Reader Service Card

Calzone Case

Studio series: rack cases; protected 8- or 12-unit rack; upper rails slanted; rack rails of tapped steel.

Circle (475) on Reader Service Card

Camera Mart Inc.

Product line includes: Distributor; rental programs;

video, audio production equipment.

Circle (476) on Reader Service Card

Canare Cable/Cables & Connectors

241U-VJ22W-C: video patchbay; 24 dual video 75Ω jacks; baseband analog to serial digital; 1 RU height.

The Stripper: 15-second quick coax cable stripping.

V*5C: 75Ω mult. cable; 3-, 4-, 5-channel; LV-77 (#8281) type low-loss.

DA206: 110Ω cable for AES/EBU digital audio transmission.

RP-C4 RCA video plug: fully crimpable; spec'd for 200MHz bandpass.

BCJ-XJ-TR, BCJ-XP-TR: impedance transformer for AES/EBU digital audio lines; 110Ω XLA female and male to 75Ω BNC receptacle connections.

BPC-C51: 75Ω BNC crimp plug for #8281 cable.

Circle (477) on Reader Service Card

Canon USA/Broadcast Optics

J20ax8B IRS: internal focus zoom lenses for 2/3"; 8-160mm with 2x extender and 20:1 zoom ratio; 0.9m MOD; 50mm with macro at wide end.

YJ17x9.5B KRS: ENG/EFP lens for 2/3" camera; 17:1 zoom ratio and 0.95m MOD; 9.5-162mm.

J33aX Tele: ENG lens; 9:1 zoom ratio; 990mm telephoto capability; internal zoom function; internal focus system with square hood.

PJ40x25B IE telephoto: 25-1,000mm and 2x extender; internal focus system; 40:1 zoom ratio with 5m MOD.

YH17x7B KRS: ENG/EFP lens for 1/2" camera; 17:1 zoom ratio and 0.95m MOD; 7-119mm; 3.2lb.

H20ax6 IRS: internal focus zoom lenses for 1/2"; 6-120mm with 2x extender and 20:1 zoom ratio; 0.9m MOD; 50mm with macro at wide end.

Circle (478) on Reader Service Card

Capitol Production Music

Product line includes: Music libraries.

Circle (479) on Reader Service Card

STORCOOL COMP.

Yes **WE HAVE THE ANSWERS TO ALL YOUR TAPE STORAGE PROBLEMS!**



Stor-Max

Other Space-Saving Storeel Systems include:

- Room Stretcher®
- Stor-Max • Railrider
- Room Stretcher Express®
- Set-Up Trucks
- The Maxi Cart

Storeel Systems offer optimum flexibility, maximum efficiency for storing broadcast tapes and films. Customized systems of top-quality steel or high-impact plastic.

Whatever the size...Worldwide, Storeel can help!



The Maxi Cart

STORCOOL COMP.

If it deserves to be stored, it deserves Storeel!

Call for Free Consultation

3337 W. Hospital Ave. • Atlanta, GA 30341 • (404) 458-3280

Circle (40) on Reply Card

Winsted [®] **Off-The-Shelf Shipping!**

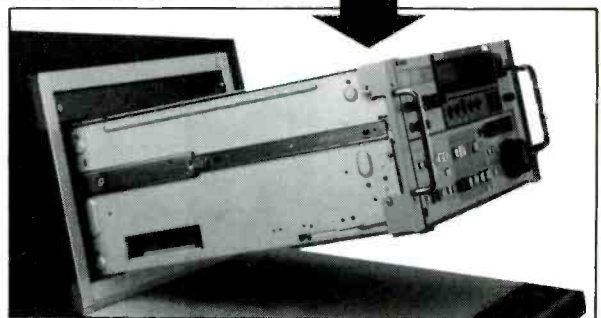

RACK SLIDE KITS

NOW AVAILABLE:
A full line of kits for rack mounted VCRs.

Expensive tape decks pull easily from rack cabinets, stay securely in place for equipment accessibility, head cleaning, and maintenance.

- Designed to fit Sony, JVC, and Panasonic VCRs
- Precision ball bearing slides
- Fast, easy installation

For FREE Full-Line Catalog call toll-free:

800-447-2257

THE WINSTED CORPORATION

10901 Hampshire Ave. So. • Minneapolis, MN 55438

TELEX: 510 601 0887

FAX: 612-944-1546

Circle (41) on Reply Card

In 20x10 and 20x20 Switching, Datatek has it all.

**Digital Video • Digital Audio
Analog Video • Analog Audio**

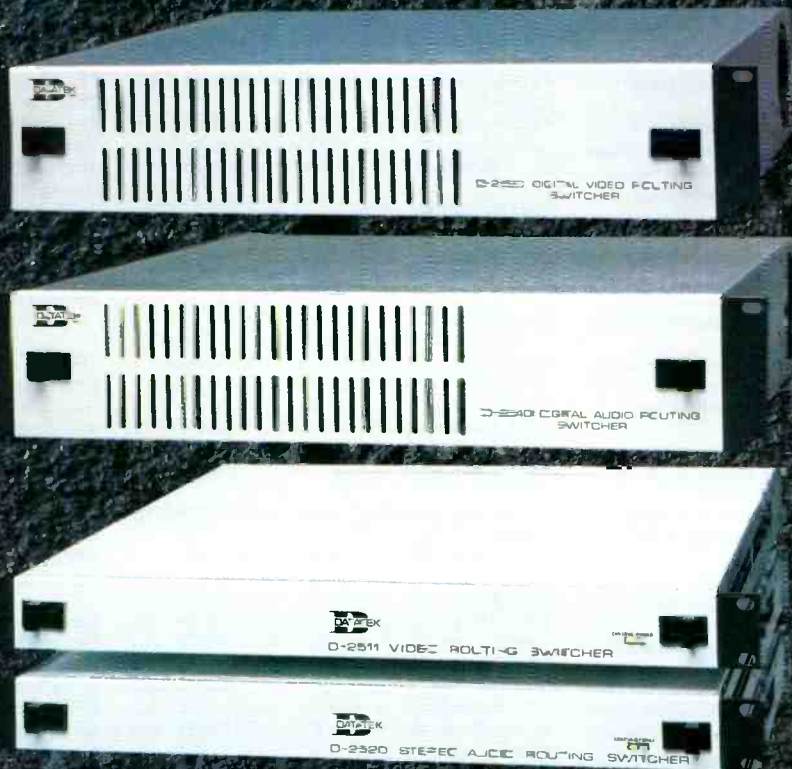

Digital or analog, audio or video, Datatek has a 20x10 or 20x20 switcher to fill your complete needs. Datatek's extensive line of switchers may be used independently of each other or in combination to form flexible and coordinated digital and analog routing systems.

- The D-2530 Serial Digital Video Switcher for C1, D2 and D3 signals (10x10, 20x10, or 20x20 in 2 Rack Units only).
- The companion D-2540 Digital Audio Switcher routes AES/EBU or consumer format signals with sample frequencies to 48 kHz.

For more information, call or Fax:



- The D-2511 Analog Video Switcher features a 40 MHz bandwidth and 20x10 switching in 1 RU or 20x20 switching in 2 RU.
- The D-2535 Wideband Video Switcher is a 100 MHz system for 20x10 in 1 RU.
- The D-2520 Stereo Switcher features matched left and right channel performance with .05% THD at +26 dBu (20x10 in 1 RU or 20x20 in 2 RU).

Each of these cost-effective switchers includes RS-232C or RS-422 control as standard for computer or modem control. A wide selection of control panels is also available for reprogrammable, X-Y, alphanumeric, keypad, pushbutton per source, etc.

Please call or Fax Datatek for more information.

1121 BRISTOL ROAD, MOUNTAINSIDE, NEW JERSEY 07092
PHONE: 908-654-8100 ■ TOLL FREE: 800-882-3100 ■ FAX: 908-232-5381



Carpel Video

Carpel-o-peel: label remover solution; odorless; no clouding or damage to cassette shells.
ST-3: waterproof stopwatch.
T-120: VHS videotape cassettes.
Circle (480) on Reader Service Card

Cartoni USA/Century Precision Ind.

Product line includes: Fluid head and tripod camera support products, the Beta and C series.
Circle (481) on Reader Service Card

CBSI Custom Business Systems

Agency Management System: expanded, improved management of radio stations' business with agencies.
CBSI Windows: multitasking capability to CBSI programs.
CustomNet: consolidated traffic/billing system for multiple stations at a single location.
Circle (482) on Reader Service Card

CCA Electronics

FM broadcast transmitter series: the FM750G, FM1,000G, FM1,500G and FM2,000G series with solid-state design; superhigh-power designs.
Ultra 60 and FM60G FM broadcast exciters: high-performance 60W FM exciter.
Circle (483) on Reader Service Card

CCOR/Comlux

Single-channel system: digital fiber-optic equipment for 9-bit video; 16-bit audio resolution.
Model 3300: addition to 3000 series of digital fiber-optic video transmission systems; applications include point-to-point, long distance links and single-channel fiber circuits.
Circle (484) on Reader Service Card

CEL Electronics

P184 converter: provides D-2/D-3 digital output from NTSC or PAL composite analog input; 8-bit processing.
P186 converter: switchable dual CCIR 601 4:2:2 digital inputs; dual YUV, YCrCb or RGB outputs; 8-/10-bit processing.
P163-RAM: upgrade for Maurice Minor hard-key controller expands effects sequence memory with external memory cards for archiving.
P171: digital video encoder.
ImageCon: PC package converting among graphic standards and TV/video; supports TIF, IFF, FIR, TARGA; optimizes and converts between image standards.
Myriad-fx: image manipulation system; 525-line version.
P272 router: signal distribution with 12 inputs by 5 dual outputs; D-1 or D-2 signals; parallel CCIR 625/601 standard; clocks regenerated.
Worldmaster/P256: standards converter.
Meridian: digital video 3-D effects system; D-1 signal processing.
Circle (485) on Reader Service Card

Cellcast Communications Products

Product line includes: Remote broadcast equipment for radio.
Circle (1202) on Reader Service Card

Central Tower

Scatter-free tower: Central Tower and Jampro Antennas collaborated in this design; antenna sig-

nals pass through tower members; consistent azimuth pattern circularity.

Circle (486) on Reader Service Card

Century Precision Optics

WA-8XC/V: 0.8x wide-angle converter attaches to front of zoom lens; 75mm, 80mm 85mm slip-on step-up rings.
Circle (487) on Reader Service Card

Channematic

ADCART Plus: random access ad insertion shares four VCRs on two channels; electronic directory editor; ROS event mode for sequential insertion.
Adcart/D: digital local ad insertion replaces VCRs with digitized A/V data for analog playback.
CompEdit: compiler-editor; auto preparation of daypart spot reels from traffic schedule with one VCR; V:base software.
Circle (488) on Reader Service Card

Chimera

CronieCones: collapsible units for VideoPro and Daylite Jr. single lights.
Quartz, Daylite Rings: for multiple ARRI, Desisti lights to 4kW open face; second model to 10-12kW.
Circle (489) on Reader Service Card

Christie Electric

CASP/1200, CASP/2000: universal battery support systems.
Circle (490) on Reader Service Card

Chromatek Inc.

9135 HDTV scan converter: built-in NTSC and PAL decoder; accepts RGB, Betacam and MI signals.
9101 scan converter: provides true NTSC (RS-170A) output.
9120 downconverter: high-quality conversion of analog raster-type sources to RS-170A-timed TV broadcast signals.
9125 downconverter: same features as the 9120 plus support of the SMPTE-approved 1125/60 HDTV format
Circle (491) on Reader Service Card

Chyron

MAXINE: single-channel, single-user titler and graphics system; compatible with iNFiNiT! and MAX!; fully anti-aliased, full color.
Centaur video adapter: produces video output from Silicon Graphics IRIS Indigo workstation; PAL, NTSC; installs in R-3000 or R-4000 CPU-based systems.
CODI Font Maker: font-rendering software; additional 3rd-party software packages include CODI MATE, CDI control panel for PCs; CODI-X for Silicon Graphics Indigo and ZFX for Macintosh.
Synesis CG Tools: 3rd-party software package for CODI operation; integral command, text file editor to create/import text from PC-compatible word processors.
Software: for iNFiNiT! and MAX! graphics systems; features message compose editing, flash font and function key enhancements.
Circle (492) on Reader Service Card

Cine 60

Spider-Lite: portable lighting system; 12V light.
Mini-Sun-Gun: 12VDC light can be camera-mounted or hand-held; 23W, 50W, 75W lamps; dichroic filter.
Simultaneous charger: 4-channel system charges 4 batteries in 1 hour.
The VAMP: volt/amp meter tests battery characteristics during use.
Circle (493) on Reader Service Card

Cinema Products

Video SK system: low-cost Steadicam for 8-17lb. professional video cameras.
Circle (494) on Reader Service Card

Cinemills

Super 4000W lighting fixture: single-ended lighting system with reflective mirror.
4K CMC electronic ballast: flicker-free, lightweight.
Circle (495) on Reader Service Card

Cipher Digital

Product line includes: Time-code products, trans-

port synchronizers; random access digital audio recorder CDI-328.

Circle (496) on Reader Service Card

Clark Wire & Cable

590 series: low-loss RGB cables with 3, 4, 5 conductors.
690 series: subminiature RGB cables with 3, 4, 5 conductors.
Composite cables: for remotes; three video, four audio circuits with or without power cable.
Piggypack: camera-mounted unit supplying power, gen-lock, mic/line audio, intercom, video input, tally with single composite cable.
TV7559 SuperFlex: TG-59-style cable; triax, stranded center conductor; five colors available.
ADAT/DA-88 cable harnesses: and components for Alesis ADAT, Tascam DA-88 digital multitrack audio recorders; custom preparation of signal data and control harnesses.
Circle (497) on Reader Service Card

Clear-Com Intercoms

100x100 Matrix Plus: with system linking.
Pro 40 headsets: single, double muff, comfortable, durable.
Matrix Plus II upgrades: LCD user stations, system-wide programming from visual display stations; variable port levels; 10-level priority for IFB.
Circle (498) on Reader Service Card

Clipper Products

Product line includes: Utility, equipment carts.
Circle (499) on Reader Service Card

CMX

CMX Cinema: non-linear editing for video and film; flexibility of high-quality, compressed digital video with 2 full-frame moving image displays.
OMNI 1000E: editing system for high-end on-line applications; multiprocessor architecture for speed, performance; dynamic motion memory.
OMNI 500: on-line, off-line editing control; high-end features for mid-end applications.
AEGLIS: high-end editing system with new controls
Circle (500) on Reader Service Card

Coaxial Dynamics

Model 7998, 7999: variable signal samplers cover 20MHz-1GHz, 1.5MHz-35MHz; available with in-line connector choices.
81070/81071 Watchman: station monitor/alarm; rack-mounted wattmeter complete with power supply and 2 panel-mounted 4 1/2" meters.
Circle (501) on Reader Service Card

Cole Wire and Cable

Product line includes: Audio and video cable, video systems control, ENG/SNG composites, fiber optics and stage lighting cable.
Circle (1205) on Reader Service Card

ColorGraphics Systems

Digital effects loop: option for DP/MAX system; integrates external digital effects device into the compositing workstation.
DP/MAX upgrades: hardware and software development for real time animation.
DP/Mosaic-C: to 8 minutes of digital disk record time with D-1, component analog input, output.
Enhanced chroma processor: includes soften, blur, positioning control of chroma-key mattes for DP/MAX keying capabilities.
Expanded layering software: unlimited numbers of live and still layers; scripting, compositing.
On-line editor software: includes disk cache editing; full-featured editing software with EDL import, modification.
VMAX2.1 software: software release in on-going software development for DP series.
Circle (502) on Reader Service Card

Colortran

ENR 48 Rolling Rack: dimmer system; 48 units for 2.4kW; 48x96 or 48x192 patch panel; 300-400A breaker; DMX, AMX, VMX, 0-10VDC control.
PRO PAK: portable lighting kits have 100-091 Mini Pro, 104-341 Mini Broad instruments; stands, barndoor attachments.
Circle (503) on Reader Service Card

DIGITAL AUDIO • DIGITAL VIDEO

Scenaria

Digital Audio/Video Production System

Audio Recording, Editing, Sweetening and Mixing

- 38-channel, automated digital mixing system
- Digital EQ and dynamics on every channel
- Integral 24-track random access recorder/player
- Multitrack digital audio editor

Random Access Video Storage

- Integral VisiorTrack system

Control of External Devices

- Multiple ATR/VTR serial machine control
- Automated audio/control routing

System Compatibility

- Compatible with ScreenSound and SoundNet
- Multi-user networking capability

Solid State Logic

International Headquarters:-
Begbroke, Oxford, England, OX5 1EU
Tel: (0865) 842300

Paris (1) 34 60 46 66 • Milan (2) 262 24956
Darmstadt (6151) 93 86 80 • Tokyo (3) 54 74 11 44
New York (212) 315 1111 • Los Angeles (213) 463 4444

Circle (43) on Reply Card

SSL DIGITAL

One of three Scenarias at
Post Perfect/Mixed Nuts, New York

Columbine Systems

Master Control Automation: PC-, AS-400-based system for TV facility automates airing of scheduled events; returns as-run schedule to traffic for closed-loop reconciliation.

Sales Quadrant: sales analysis software, version 2; examines past, present, projected revenues.

Circle (504) on Reader Service Card

Comark Communications/Thomson-CSF

Dual Use: UHF TV transmitter.

IOX transmitter: IOT technology for NTSC, D-HDTV applications; exciter with proprietary, patented full bandwidth linearity correction, IEC-215 safety features.

Circle (505) on Reader Service Card

Comband Technologies

CT-1000 system: for multichannel, multimode scrambling in wireless CATV; encoder/IF modulator, system controller, addressable converter; compatible transmission products for MDS, MMDS, ITFS, OFS operations.

Circle (506) on Reader Service Card

Communications Data Services

Engineering services: Real world propagation coverage predictions with Sun Microsystems SPARC-based workstation; 3-D digital terrain data on CD-ROM; on-line software for RF engineering.

Circle (507) on Reader Service Card

Comprehensive Video Supply

CV Technologies Digital Edit Master: non-linear editing system for Amiga.

Visual Log Master software: for IBM PCs and compatibles; allows random access cataloging of video scenes.

Product catalog: more than 100 products.

Circle (508) on Reader Service Card

Comprompter

NetVid: network video software; captures video and sends it down the network as data directly to workstation.

ENR upgrades: GraphicMaster link to titler; specifies screen locations; CaptionMaster software; ArcMaster extended archive software; StillMaster still-store.

ENR V2.4 enhancements: full VGA color prompter; changed user group and user/desk group utilities.

PC/LAN compatible: full-featured network software.

PPS Production Prompting System: for ad. agencies, production houses, corporate production facilities.

TOTAPROMPTER portable: production prompting systems for laptop and notebook computers.

Circle (509) on Reader Service Card

Computer Assisted Technologies

BCAM: enhanced maintenance management package; graphic presentations from accumulated data; output to spreadsheets; equipment tracking; on-line technical databases by modem.

CAtest: automated test measurement software.

Circle (510) on Reader Service Card

Computer Concepts

Editing option: for DCS digital commercial system automation.

Circle (511) on Reader Service Card

Computer Engineering Associates

CEA newsroom system enhancements: full-function system with wire capture, assignments, scripting, prompting, inventory, personnel management and machine control interfacing.

Circle (512) on Reader Service Card

Computer Prompting & Captioning Co.

CPC-600 CaptionMaker: closed and open captioning system.

CPC-700 CaptionMaker Plus: SMPTE time-code-

based closed and open captioning system.

Circle (513) on Reader Service Card

Comrex

Talk Console: talk studio in portable package; 1 or 2 phone lines, 2 mic channels; self-adjusting hybrids, mix-minus circuit; dial-cue feature.

Circle (514) on Reader Service Card

Comsat World Systems

Digital Audio Distribution: international digital service through Intelsat network; backhaul and international spot deliveries.

Intelsat-K: network through Ku-band satellite.

TV scheduling service: short-term, occasional-use, videoconferencing services through satellite network.

Circle (515) on Reader Service Card

ComStream Corporation

ABR200: digital audio receiver; 20kHz stereo from Ku-/C-band; multirate, multimode integrated receiver; Musicam (ISO/MPEG) compression.

CM236: digital modulator for video networks by satellite; RS-232/485 remote-control port.

Audio Network Management System (ANMS): PC-based, monitor and control system.

DAC400: audio codec/multiplexer for satellite up-links or point-to-point communications.

Circle (516) on Reader Service Card

Comtech Antenna Systems

1.8m Flyaway: portable, transmit-capable Ku-band antenna.

EC8: satellite antenna controller.

Circle (517) on Reader Service Card

ComTek

High-fidelity IFB products: base station transmitter; high-performance personal receivers; wireless-to-the-ear prompting; cuing systems.

MRC-82P: miniature high-fidelity receiver; IFB, personal communications use.

Circle (518) on Reader Service Card

Comtronix Systems

Product line includes: solid-state RF amplifiers for broadcast, communications, military, laboratory and educations.

Circle (519) on Reader Service Card

Concept Productions

CAPS-CD: computer-assisted programming system; complete audio storage and playback for live or automated radio stations.

Circle (520) on Reader Service Card

Concept W Systems

CP-301 series: universal camera multiplexing systems for NTSC and PAL.

PDC-240HP: intelligent remote power system for cameras using coax.

RVS-230: return video switcher.

Circle (521) on Reader Service Card

Conifer

Integrated receivers: 1-piece antenna/downconverters with 32-52dB gains, noise figures of 1.5dB.

Receiving antennas: 12dB, 18dB, 24dB gains.

Circle (522) on Reader Service Card

Connectronics

JB9600 patchbay system: TT/Bantam connectors on front panel; high density; 3 normalizing options.

XB modular patch panels: uses XLR connectors; 2 rows, 16 connectors or 1 row, 16 connectors.

Circle (523) on Reader Service Card

Continental Electronics

419G/420C: shortwave transmitters for 300kW, 500kW; standard, CCM-controlled carrier level modulation or SSB; RS-232/422 remote control; tetraode PAs.

802B FM exciter: low-power transmitter or 5-50W source for high-power transmitter system; PLL frequency control.

SSM series modulators: provides high-level digital modulation from 48-module circuit; supplies controlled DC plate current based on number of

Digital audio is here.

We get it there.

2 miles on FDDI multimode. 25 miles on singlemode
64 channels bi-directional full bandwidth audio

Fail-Safe FTRC™ Signal Integrity

BEC manufactures fully modular fiber optic digital audio transmission systems for:

- STLs
- Production Facilities
- Satellite Links
- Mobile Production



1101 N. Northlake Way, Suite 3, Seattle, WA 98103
Phone: (206) 632-2431 Fax: (206) 547-1421

Circle (44) on Reply Card

modules active in accordance with audio input level.

T line AM: transmitters with solid-state modules; 312T 300W; 314T 1kW; 314T-1 2.5kW; 315T 5kW; broadband, synthesized frequency control.

816R series: 21.5, 25, 27.5 and 35kW broadcast transmitters.
Circle (524) on Reader Service Card

Control Concepts

LF, LCG series: surge and power protection systems.

Circle (525) on Reader Service Card

Corporate Computer Systems

CDQ-1000: codec transmitting 10kHz digital audio over 1 switched digital circuit (56 or 64 kbps). (See Pick Hits.)

CDQ-2000: multirate ISO Musicam codec; transmits 20kHz stereo or mono digital audio.

PACE: editing workstation for digital audio.

Circle (527) on Reader Service Card

Cortana Corporation

Product line: Lightning, static protection products; Stati-Cat, Stati-Kitty and Stati-TomCat.

Circle (528) on Reader Service Card

Countryman Associates

Product line: Microphones, the EMW series.

Circle (529) on Reader Service Card

COSA/Company of Science & Art

CoSA After Effects: special effects application for Mac users; provides high-end capabilities.

Circle (530) on Reader Service Card

CRL Systems/Circuit Research Labs

Amigo AM: matrix stereo audio processing system; dual-band AGC; 3-band matrix limiter; NRSC output filtering.

SC-100: generates RBDS signals or RDS signals by 100% digital signal processing.

DAA-100, DAA-50: -100 is a 2-channel function generator and AES/EBU audio link analyzer; -50 is a digital audio interface analyzer. (See Pick Hits.)

RBDS & subcarrier: generator system.

TVS-3005: SAP generator.

PMC450F: AM mono audio processor; 2 output filters; can be switched back and forth remotely.

Circle (531) on Reader Service Card

Crouse-Hinds Molded Products

Product line includes: power distribution panel systems and connectors.

Circle (1204) on Reader Service Card

Crouse-Kimzey Company

360 Systems Digtacart: random-access digital audio recorder.

AKG Tri-Power series: stage microphones for vocal, instrumental applications.

Audio Arts R-10: 10-channel audio console.

Ramsa WP-1200: monitor.

Sony DPS-M7: digital sonic effects system.

Telos hybrids: Telos 100 Delta, One-plus-One.

Circle (532) on Reader Service Card

Crown International

SASS-P MkII: stereo ambience microphone.

IQ-2000: computer-controlled audio system.

LM-301, LM-300L: mini dual gooseneck condenser mics.

PCC-170: multifunction supercardioid boundary mic.

CM-311 "differoid" headworn condenser microphone: rejection of background ambience encountered at sporting events.

SMX-6: digital 6x programmable mixer.

Circle (533) on Reader Service Card

Crystal Graphics

TOPAS Professional and TOPAS for the Mac: for the Mac; fully integrated for production of broadcast-quality 3-D animations.

Desktop Animator: fully integrated modeling, rendering and animation package.

3D Designer: integrated 3-D modeling, rendering
Circle (534) on Reader Service Card

CSI Camera Support International

System 40 tripod, head, dolly: for EFP/studio applications.

Daiwa systems: pan/tilt, tripods supporting 8- to 50-pound loads; single-, double-handle options; tilt, pan locks.

ENG tripod: lightweight with 80" over-crowd height.

Soft, hard cases: for all CSI/DAIWA systems.

Daiwa dollies: positive tripod leg attachments, locks; from 25- to 75-pound load; polyurethane tires, roller bearings

Models APT-3DCII and APT-3DCP2, MVH-2D: remote-control pan/tilt heads.

Circle (535) on Reader Service Card

CTE International

S/22 exciter: mono, stereo per FCC, CCIR, CIRT specifications; 20W from modular, redundant design.

VL/1000: 1kW solid-state FM amp with four MOSFET 250W modules; protection, diagnostic features; 25-30W RF drive.

VL/30 exciter: 30W output per FCC, CCIR specifications; program via RS-232 port to control transmitter from a remote PC.

Circle (536) on Reader Service Card

Cycle Sat

Automation Protocol Converter: routes 38.4kbaud data from Cyclecypher receiver for direct serial data interfaces in TV station automation system.

The Flat Antenna: agreement in principle with the Flat Antenna Company; flat antenna, approx. 1" thick; available in 1, 1.5, 2 and 2.5 meter diameters.

Circle (537) on Reader Service Card

Cylink

Airlink: point-to-point wireless connectivity; no FCC licensing required; max. range of 30 miles; supports synchronous data up to 256kb/s, asynchronous to 38.4kb/s or analog voice. (See Pick Hits.)

Circle (538) on Reader Service Card

Dalet Digital Media System

RadioPro Starter Kit: Plug and play digital audio system; live assist and playback; Windows-based user-friendly interface; multitasking system; simultaneous record/playback capabilities.

Circle (539) on Reader Service Card

Da-Lite Screen Company

The Tensioned Cosmopolitan Electrol: electric tensioned screen.

Circle (540) on Reader Service Card

Dan Dugan Sound Design

Model D: automatic mixing controller assists sound operators with multiple live microphones; 8-channel VCA unit patches into audio console.

Circle (541) on Reader Service Card

Daniels Publishing Group

Product line: Publications list broadcast equipment technical data, applications information

Circle (542) on Reader Service Card

Data Center Management

DCM-PC: distributed processing version of newsroom computer.

Circle (543) on Reader Service Card

Data Security Inc.

Type II-A: only degausser approved by Department of Defense to purge classified info from S-VHS and D-1 cassettes; Magnus " cartridges, Ampex 722 reels and all type 2 magnetic media; fully rack mountable; 120V operation.

Circle (544) on Reader Service Card

Datek

D-2530: serial digital video router with 20x10 to 40x40 matrix.

D-2535: wideband video router; 20x10 to 20x20 array; 100MHz bandwidth.



D-2700DAS: AES/EBU digital audio router; transformer coupling; relocking and regeneration feature.

D-2700DVS: serial digital video routing switcher; 64x64 to 256x256 arrays.

D-2540 digital audio switcher: for systems from 20x10 to 40x40.

Circle (545) on Reader Service Card

Data Translation

Media 100: on-line, non-linear video production system; 60-field video output quality

Circle (546) on Reader Service Card

Dataworld

FM allocation map book: FM, FM translators and FM boosters with pictorial data, licensed facilities with applications and construction permits are represented.

LMA/duopoly contour study: available 24 hours a day, 7 days a week via on-line computer system.

Circle (547) on Reader Service Card

David Sarnoff Research Center

Advanced Digital HDTV (AD-HDTV): a digital simulcast HDTV system providing high video and audio quality; features include MPEG++ compression, packetized data structure.

Circle (548) on Reader Service Card

daVinci

3/2 edit package: for daVinci and Renaissance series; aligns telecine with recording VTR.

EDIT/2V, /3V options: VTR/telecine editing facilities; various configurations of recording VTRs with tape and telecine source transports.

Renaissance 8-8-8: component digital color correction with enhancements.

Circle (549) on Reader Service Card

dbx/AKG Acoustics

Model 172 Supergate: uses 24dB/octave voltage-controlled filters for selective isolation of signals requiring gating; parametric controls.

Model 1024: dual buffer amplifier.

Project 1 series: dual compressor/gate (model 266), quad/expander gate (model 274), dual spectral enhancer (model 296).

Model 760X: dual mic pre-amp; 0,-0.15dB from 20Hz-20kHz with functional bandwidth 2Hz-200kHz; features gain trim, polarity reverse, overload indicator, 48V phantom power.

Model 120XP: subharmonic synthesizer; for sound reinforcement, production, mobile DJs.

Circle (550) on Reader Service Card

DDA/Mark IV

DDA interface: audio production console.

Interface console: 8-, 16-, 24-, 32-channel mixers; 4 group buses, 6 auxiliary buses; optional I/O transformers.

QII: mixing console featuring true left-center-right (LCR) panning and four LCR submix groups.

Circle (551) on Reader Service Card

Dedotec USA

DSET-M: location lighting kit; weighs less than 30 pounds with four Dedolight heads, stands, projection attachment.

Circle (552) on Reader Service Card

Delta Electronics

ASE-2: low cost, high-performance AM stereo exciter generates C-QUAM format.

Circle (553) on Reader Service Card

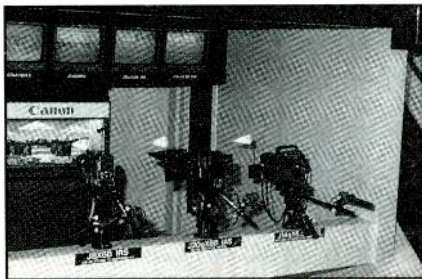

Denny Manufacturing

Electravison electronic proofs: EV-2000 system operates side-by-side with photographic camera to record video proofs of photo shoot.

Circle (554) on Reader Service Card

DENON

DN-1200F: CD changer; 200-disc capacity.
DN-720R cassette deck: variable pitch, adjustable record and bias levels; real time counter.
DN-951FA: CD cart player in on-air CD playback system; AutoTrack selection mode; streamline profile, rugged transport operation.
DN-961FA CD player: drawer load.
TU-680NAB: AMAX AM broadcast monitor; per NRSC, selectable bandwidth IF; C-QUAM stereo.

Circle (555) on Reader Service Card

Diaquest Inc.

ANIMAQ/UX: software video animation controller for UNIX workstations.
Mac ImageNode: networked video input and output system; functions as a frame accurate video gateway between Silicon Graphics and Macintosh platforms.

Circle (556) on Reader Service Card

DIC Digital

Betacam SP cassettes: 5-, 10-, 20-, 30-minute lengths.
Recordable compact disc: available in 18-, 63- and 74-minute capacities.
MQ series: studio pack holds two DAT cassettes, removable session log card for program ID.
AR-4000: dry, non-abrasive DAT drive cleaner.
Polypropylene case: For MQ series; unbreakable, reusable, recyclable, soft cases.

Circle (557) on Reader Service Card

Dielectric Communications

Model 7000 series calorimeter: works with any fluid compatible with copper, nylon, brass or stainless; self adjusts for fluid property changes with temperature variations. (See Pick Hits)
Broadband UHF water column load: for use within the 420-806MHz band; operates with a water/ethylene glycol mixture coolant.

Circle (558) on Reader Service Card

Digidesign

The Session 8 XL: low-cost professional quality hard disk recording system; based on Windows platform.
SampleCell II: stereo 16-bit, 32-voice, 32Mbyte sample playback card for the Macintosh II, Centris and Quadra computers.
Pro Tools 2.0: software upgrade and enhancements to the Pro Tools system.

Circle (559) on Reader Service Card

Digital F/X

WaveFrame 1000: for creating CDs, records digital audio directly to Yamaha YPE-301 encoder and YPR-291 recorder.
WaveFrame 401: digital audio recording system; includes VITC sync, digital I/O, mixing, multitrack punch recording.
Hitchcock: stand-alone non-linear disk-based editor; works with video on Macintosh hard drive; 640x480 pixel array at 30fps.
TidalWave: 6-track software only on hard disk recorder, editor using SGI Indigo platform.

Circle (560) on Reader Service Card

Digital Processing Systems

Personal animation recorder: replaces traditional VCR for recording and real time playback of computer animation sequences.
ES-2000 expansion system: rack-mount chassis holds 12 Personal Series cards; redundant power supplies; front-panel microprocessor control.
DPS-285: master sync, test signal generator.
TBCs, synchronizers: DPS-295 multiformat, transcoding TBC/sync; DPS-265 4-field synchronizer; DPS-375SP multiformat, transcoding PAL TBC/sync; DPS-365 PAL, 8-field synchronizer.
VM-2000 personal V-scope: waveform, vector monitor plug-in card for Amiga 2000, IBM PC/compatible, Video Toaster workstations.
MicroSYNC A/V: 4-field composite video, stereo audio follow synchronizer; full bandwidth composite video bandwidth.
DPS-710/750: color correctors; available in composite and component configurations, NTSC and PAL formats.
Personal TBC IV: for S-video I/O; freeze, variable strobe, GPI trigger, software-controlled color balance optional; DOC, noise reduction.

Circle (561) on Reader Service Card

Digital Vision

DVASC 1000: conceals effects of positive and negative film dust, certain types of scratches; tape dropouts and FM noise; uses 4:2:2 10-bit digital signal processing.
DVIS1000: image stabilizer corrects unwarranted 2-D movement in video images; functions include integral framestore synchronization, horizontal and vertical aperture correction.

Circle (562) on Reader Service Card

Discreet Logic Inc.

FIRE: high-speed paint system for video, print; animated graphic shapes applied to effects; matting.
FLAME V3.5: editing system with fast feedback; compatible with major 3-D systems; for editing, image processing, compositing.
INFerno: for film effects, compositing; capabilities exceed resolutions of 3kx12k at 12-bits per channel; digital editing tools; image filtering; 3-D perspective moves.

Circle (563) on Reader Service Card

Display Devices

DataLite LCD-100: projector accessory for smaller projection devices; electronic servo circuit; operating load of 100lbs.

Circle (564) on Reader Service Card

Di-Tech

5886 and 5887 switchers: 5886 is a 64x64 video switcher; part of the Meridian series; uses the same plug-in modules as the 5881 128x160 switcher; 5887 2-level audio switcher is the same size as the 5886 and has the same features.
224 quad video equalizer: provides 4 independent 1 in, 1 out, variable coaxial cable equalizers.
225 dual video equalizer DA: 1x3 video DA with 2 separate 1,000' equalizers and differential inputs.
418 X-Y display generator: 1 rack unit high; has 16 pushbuttons; data is converted to an RS-170 video output signal for distribution to monitors.
419 source display panel: available in single or dual versions; provides 6-character status display in a 1 rack unit housing.
46 64 control panels: 461 half-bus panel has 10 input assignable buttons for single button switching; 464 is an X-Y panel with 20 button source and destination prefix sets.

Circle (565) on Reader Service Card

Dolby Labs

DP5500 STL: 950MHz operation; advanced digital and RF techniques for high-quality audio, exceptional signal robustness; modular design.
Model 740 spectral processor: 2-channel dynamic equalizer; raises low-level signals in three bands by as much as 20dB without affecting high-level signals.
SRP multitrack series: 24-track Dolby SR processor; individual control of I/O amp/level per track.
Model 430: background noise suppressor for broadband noise reduction in on-location recordings.

Model 422: reference encoder, decoder offering Dolby B-, C-, S-type noise reduction for preparing duplication masters.

Circle (566) on Reader Service Card

Dorrugh Electronics

280 and 380 audio meter: AES/EBU 2-channel digital reading meter; selectable peak-hold function; gate-array technology.

Circle (567) on Reader Service Card

Drastic Technologies

Virtual VCR: compression-based videodisk recorder; supports NTSC and S-VHS signals.

Circle (1208) on Reader Service Card

Dubner International

Scene Stealer: PC/AT board with software, accepts NTSC/PAL video; automatically detects and marks cut points while grabbing B/W images.

Circle (568) on Reader Service Card

D/Vision-Pro

ProEdit/2: editing system; combines IBMPS/2 computer with D/Vision-Pro; turnkey system.

Circle (569) on Reader Service Card

DVS Digital Video Systems

ISP100: image sequence processor; for high-speed capture, display of HDTV sequences; multistandard capability with analog and digital video interfaces.
ISP400 series: modular solid-state image sequence processor; high-speed capture and display of HDTV sequences; multistandard, multi-user capability.

Circle (570) on Reader Service Card

Dwight Cavendish

COPYMASTER 2500: videocassette duplication system; features the 628 series of modules; from 10-2500 slave VCRs; handles PAL, NTSC and SECAM.
VP700: automatic VCR changeover module.
VP-738: 10x10 video and stereo audio matrix routing switcher.

Circle (571) on Reader Service Card

DYNAIR Electronics

DATA Link: combines broadcast-quality video, dual audio and four full-duplex RS-232 signals on one fiber.
DYNA MITE: compact routing switcher with 10x10 video/audio matrix with control in two rack units.
DYNASTY routing switchers: 40MHz, 70MHz bandwidths; expandable to 1,000x1,000 matrix.
DYNOPTICS: fiber-optic systems for audio, video and data; handles high-resolution signals in D-1 and D-2 formats.

Circle (572) on Reader Service Card

Circle (572) on Reader Service Card

Circle (572) on Reader Service Card

Dynatech Corporation

DYNA-128: serial digital routing switcher; co-developed by Alpha Image and Utah Scientific; 128x128 matrix system; offers reclocking on input and output and provides cable equalization for up to 1,000 feet of cable.
D'S² DigiStore: digital video playback and record system; jointly developed by Parallax, Alpha Image, da Vinci, Utah Scientific, Quanta, ColorGraphics, Cable Products Group and NewStar; on-line random access of video allows system to manipulate playlists. (See Pick Hits.)

Circle (573) on Reader Service Card

Dynatech NewStar

Connectivity: demonstrations on linking NewStar II system to hardware and software packages.
NewStar II: Version 2.2 software.
NewStar Multimedia: combines automation capabilities of NewStar with digital disk storage.

Circle (574) on Reader Service Card



EarthWatch Communications

NewsVision: customized software allows artist to

Our Commitment Continues...

With the new
D/ESAM® 400
we offer a total
integration of
highly advanced
technology
and customer
requirements.

*Efficient and
simplified operation*

*Dependability...with
unparalleled support*

Long product life

Lower cost

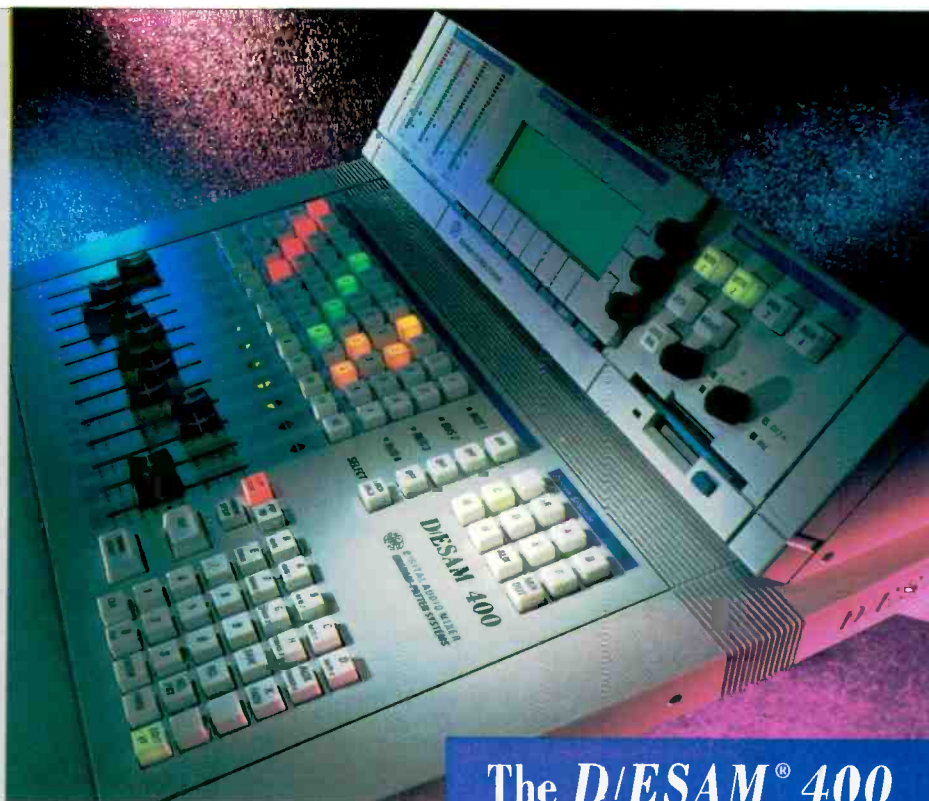

The D/ESAM® 400
Digital Edit Suite Audio Mixer

At Graham-Patten Systems our developments are focused toward your needs...

Award winning digital audio technology utilizes highly advanced signal processing developments. Modular architecture offers an upgrade path to handle your changing needs.

Our exclusive **Virtual Input Matrix** allows analog and digital signals to be intermixed without complicated patching or routing. Adding or changing inputs is easy and inexpensive—giving you long term flexibility.

Complete control using ESAM protocol assures compatibility with any major editing system...now and into the future. Familiar operation gives editors more capability in less time.

For more information contact:

GRAHAM-PATTEN SYSTEMS, INC.

P.O. Box 1960, Grass Valley, California 95945 USA

Telephone: (+1) 916-273-8412 or 800-422-6662

Fax: (+1) 916-273-7458

© 1993 Graham-Patten Systems, Inc. D/ESAM is a registered trade mark of Graham-Patten Systems, Inc.

Circle (45) on Reply Card

create maps instantly; create 3-D models for any location on earth within seconds.

Eastman Kodak Company

Cineon digital film workstations: modular, resolution-independent workstations; designed for film-resolution image processing, compositing and retouching.

Circle (575) on Reader Service Card

Echolab

PC3 video switcher: for broadcast production; card for PCs operates under Windows; standard SMPTE serial interface.

Uniboard mixers: analog component and composite production switchers; in single or dual M/E versions.

PCA board: companion PC card for PC3 switchers; provides audio-follow-video under Windows control or from edit controllers with AMX100 protocol. **MVS switcher series:** single, M/E composite switcher may be upgraded to Y/C or component format by adding 1 or 2 additional video cards.

Circle (576) on Reader Service Card

Econco Broadcast Service

Tube line: rebuilt tubes: 4CX3500A, 4CX7500A, 4CX1200A, 4CX2000A/B/C (8990), 4CX20000D.

Circle (577) on Reader Service Card

Ediflex Systems

Ediflex III digital editing system: non-linear off-line editing with 486 platform, hard disk storage, optional compact MO drives, removable storage; graphic user interface, multicamera capability.

Circle (578) on Reader Service Card

Editing Machines Corporation

PrimeTime: non-linear digital editing system; available as kit containing software and add-in cards or as complete turnkey editing system.

EMC print-to-tape: master projects directly from EMC2; CD-quality 44.1kHz audio available on optical disk and hard drives.

High resolution: " picture quality.

Circle (579) on Reader Service Card

Editing Technologies Corporation

ENSEMBLE PRO: versin 2.0; supports the Dubner International Scene Stealer board; allows user to tie reference video frames to the logging database.

Circle (580) on Reader Service Card

EEG Enterprises

Digital upgrade: available for EEG simple or smart encoder; includes a new chassis; new printed circuit board added to provide D-2 encoding.

EN 250D and EN 270D: encoder options; capable of encoding Line 21 closed-captioning information into analog and digital videos at the same time.

Circle (581) on Reader Service Card

EEV

Leddicon camera tubes: for studio, EFP and ENG cameras; 1/2", 1" and 30mm units.

Power tetrodes: 4CX series for AM/FM transmitters; 5kW, 15kW, 35kW power levels; improved mesh filament design provides longer life, reduced noise and eliminates warm-up variations.

Circle (582) on Reader Service Card

EG+G

Product line includes: Tower, obstruction units.

Circle (583) on Reader Service Card

equipment

Super Maxi Jib: ultraportable, quick-to-assemble crane arm for remote camera control; packs into flight case; five additional 1m sections can be used. **Dino Dolly:** with special arm.

The Rocker: remote head for restricted locations in aircraft, cars, tunnels, elevators.

MicroShot: possibly the world's smallest remote camera control head.

The Roll Mount: remote camera control with pan, tilt and roll features; permits flying, swooping point-of-view shots.

Circle (584) on Reader Service Card

Electronics Research

SHPX/LPX series of FM Antennas: increased bandwidth; improved phase linearity; low VSWR; internal feed; fully pressurized; circular polarization.

Circle (585) on Reader Service Card

Electrosonic Systems

PICBLOC 3 series: expanded product line with high-resolution, high-definition digitizers using HDTV and VGA text/graphics as inputs; multimedia compatibility.

Circle (586) on Reader Service Card

Electro-Voice

635A/B, RE50/B: black finish for ENG/EFP mics designated by /B.

7100 stereo power amp: each channel delivers 75W of continuous average power; current-limiting circuit.

Circle (587) on Reader Service Card

Elenos

SF1000 FM solid-state amplifier: 1kW MOSFET technology; switch mode power supply unit; control and command logic; strip-line type construction.

RF diagnostics remote control: checking, remote-control, diagnostics and troubleshooting of apparatus situated at a distance, directly from studio or mobile units.

Circle (588) on Reader Service Card

EMCEE Broadcast Products

TTS100HS: 100W wireless cable transmitter; maximum coverage potential for large geographic areas; frequency agile, broadband tuning; high-performance system with integral diagnostics.

TTU1000ES: 1kW solid-state UHF transmitter; separate video/audio processing; low parts count; ergonomic design; 4 independent 300W final stage with integral power supply and cooling.

TTV1000ES: 1kW VHF broadcast transmitter; high-performance separate visual/aural system for NTSC, PAL, SECAM; 100% solid-state, low maintenance with soft failure feature.

TUA100E, TVA100E: UHF and VHF amplifiers for low-power broadcast; TUA also usable for translator service.

Wireless cable transmitters: TTS20HSX 20W, TSA50HS 50W units; MSE8033 high-power signal bender for wireless cable.

Circle (589) on Reader Service Card

EMCOR Products/Crenlo

Guide to Emcor Enclosures: focuses on ESQ, Series 10, Emcor I enclosure systems.

Circle (590) on Reader Service Card

ENCO Systems

DAD 486x: digital audio distribution system for multi-user access to CD/DAT audio stored on shared data network; 16-bit sampling with adjustable rate; hard disk storage; programmable playlists. (See Pick Hits.)

Circle (591) on Reader Service Card

Energy-Onix

FM transmitter products: one series offers 30W to 10kW and higher custom powers ratings; a second series uses a single-tube zero-bias triode for outputs from 1.5-35kW; Motorola MOSFET MRF151G solid-state drivers.

Lightning proof: 1kW AM transmitter.

Updated versions: of established AM transmitters from 5-50kW.

Circle (592) on Reader Service Card

ENG Mobile Systems

ENG/EFP, C-Vans: combined standard, optional and custom features for mobile production vehicles.

Circle (593) on Reader Service Card

Ensemble Designs

Catalyst: digital composite keyer, seamless link between analog switcher and D-2, D-3 VTRs; single RU for electronics; 10-bit processing with layering from digital or analog sources.

DP-2 processing amp: digital composite video system; compatible with D-2/D-3; adjusts chroma,

luminance, setup, hue; serial/parallel I/O; gamma.

Circle (594) on Reader Service Card

Enterprise Electronics

Product line includes: Doppler weather radar equipment, DWSR-90CTV systems.

Circle (595) on Reader Service Card

Entertainment Technology Inc.

AC-100: auxiliary control unit incorporates analog controls into digitally based Intelligent Power System.

Intelligent Power System: dimming system; uses distributed dimming scheme.

Circle (596) on Reader Service Card

Equipment Broker (The)

Product line includes: Broadcast, production equipment brokers.

Circle (597) on Reader Service Card

ERGO 90/Ergo Industries

Product line includes: Equipment rack, mounting utilities.

Circle (598) on Reader Service Card

ESE

PC family: four cards for desktop video; black generator, two DA choices, one audio DA.

ES-201 "The Cable Saver DA": 1x4 video DA with separate gain and EQ controls for each output.

ES-770 time controller system: permits control of equipment automation of VTRs, titlers, satellite recorders with 5,000-event capability.

Circle (599) on Reader Service Card

ETC-Electronic Theatre Controls

Sensor: dimming system with 16-bit microprocessors.

Source Four: high-performance ellipsoidal spotlights; design collaboration with Entertec.

Circle (600) on Reader Service Card

Euphonix

CSII control module: integrates digital control for Support Computer and Dynamics Processors; QWERTY keyboard, trackball, color LCD display. **CSII software release V 2.0:** enhancements to automation with LCRS panning software for multiple operator film systems; supports CUBE level option.

Cube Level Option: DCA level option cards for CUBE system to add 48 aux sends, 48 film mix buses, 48 multitrack buses to any CSII console.

The CUBE: digitally controlled analog routing matrix; operates alone or with a mixer; integrates with SnapShot Recall, includes screen-based displays and metering.

The CUBE: modular router, mixing unit operates with CSII mixer or alone; total automation with PC running CubeView software or Euphonix digital control module; dynamic mix automation.

Circle (601) on Reader Service Card

Eventide

DSP4000 Ultra-Harmonizer: audio processing with AES/EBU digital I/O for all-digital signal manipulation in modular software architecture; create effects algorithms by linking modular effects blocks.

VP244 digital logger playback unit: for desktop use; two parts consist of main electronics unit and remote-control console.

Circle (602) on Reader Service Card

Evertz Microsystems

EV-16: Keycode reader head.

KeyPost: film/video list management software program.

Model 4025: integrated film, post-production system.

8025 digital video keyer: keys VITC, characters or other signals into the digital video bitstream.

8001: digital video serial-to-parallel converter.

8002: digital video parallel-to-serial converter.

Circle (603) on Reader Service Card

EVS Broadcast Equipment

Video Paint 7.0: digital graphics system for retouching, rotoscoping, generating multilayered

Never Before Have We Made So Much Noise About Something So Quiet.

The original Shure FP32 set the standard in field production for portable stereo mixers. Now, with the new FP32A, you can count on getting even less. Noise, that is... **30dB less!** In fact, the FP32A is so quiet and improved that it's perfect for use with DAT and other digital recording media.

Professional Mixing You Can Take Anywhere.

The Shure FP32A is a 3-input, 2-output portable mixer specifically designed for:

- Remote audio recording
- Electronic field production
- Electronic news gathering
- Location film production

At just 1.6kg in weight and only 184mm x 161mm x 59mm in size, the FP32A easily goes everywhere. And operation anywhere in the world is never a problem, either. Two 9V alkaline batteries will operate the FP32A for at least 8 hours. Or it can be powered by any 12 to 30 VDC power supply, such as an automotive battery, rechargeable belt pack, or an AC to DC converter.

So Many Features In So Little Space.

No other portable stereo mixer offers comparable performance and as many features in such a compact package. The new FP32A gives you all the features of the original FP32, plus:

- Dynamic range of over 100dB
- 48V phantom, 12V phantom and 12V T (A-B) power
- LED indicators of input levels, output peaks, limiter action, and low battery
- Pop-up pan pots

- Link switch to couple inputs 2 & 3 into a stereo pair
- Mix bus to connect two FP32A mixers together
- Headphone monitoring mode switch and headphone MS stereo matrix
- Monitor switch to route mixer or Monitor In signal to headphones
- Internal DIP switches for over 4,000 customized set-ups
- In all, more than 40 new features and improvements

Designed And Built In The USA By Shure.

Since 1983, broadcast and production engineers have relied upon Shure Field Production products. All FP products are designed to withstand the most extreme real-life operating conditions. You can depend on every FP product for ruggedness, reliability, and outstanding audio quality.

For the Shure FP dealer nearest you, call 1-800-25-SHURE.



A Host Of Applications:

Remote Audio Recording

Live music
Sampling
Nature sounds

Electronic News Gathering

Live events
Sports
Satellite Uplinks

Electronic Field Production

Documentaries
News magazines
Instructional programs

Location Film Production

Features
Stereo ambiance
Samples for post-production



Carrying Case
Shoulder Strap
Mix Bus Cable



FEATURES:	BENEFITS:
Exceptionally low self-noise	Compatible with digital recording and transmission. At least 30dB quieter than FP32!
48V/12V phantom and 12V T(A-B) power	Will operate all condenser mics available.
Balanced transformer inputs and outputs	Superb rejection of hum, RFI, and other interference.
Wide range input gain controls	Handle hot levels without pads.
Input red/green LEDs	Visual indication of optimal gain settings.
Switchable mic/line inputs and outputs	Handle any signal level.
Input low-cut filters	Reduce wind and handling noise.
Pop-up pan pots	Avoid accidental movement.
Link switch	Couples inputs 2 & 3 into a stereo pair.
1kHz tone oscillator	Recording and send level calibration.
Slate tone and mic	Mark beginning of production takes.
Compact VU meters	Can be seen in all lighting conditions unlike LEDs. Not affected by temperature or altitude like LCDs.

FEATURES:	BENEFITS:
Meter lamp	Illumination in low-light situations.
Adjustable output peak limiters	Prevent output overload.
Peak/Limiter output red/green LEDs	Indicate peak level and limiter action.
Mix bus connector and cable	Interconnects two FP32A mixers for 6 inputs.
Headphone mode switch	Monitors mixer output as: stereo; right only; mono; left only.
MS matrix for headphones	Decodes Mid-Side signals into stereo.
Monitor In switch	Switches headphones between mixer output and Monitor In feed.
Tape out 3.5mm jack	Provides stereo, unbalanced, aux level signal.
Flashing red/green power LED	Green for power on; red for low battery.
Non-polarized power jack	Use external 12 to 30 VDC instead of batteries.
Internal DIP switches and trim pots	Customized FP32A operation.
Soft touch knobs with raised indicators	Tactile feedback for no-look mixing.
Black chrome finish	Extreme durability.

Specifications:

Frequency Response

20 to 20 kHz, ± 2 dB

Total Harmonic Distortion

$\leq 0.25\%$ at +4dBm; 50 to 20kHz

Equivalent Input Noise

-127 dBV with 150 Ω source;
20 to 20kHz

Output Noise (input controls full off)

Master full off: ≤ -100 dBV, 20 to 20kHz
Master full on: ≤ -80 dBV, 20 to 20kHz

Low Cut Filters

6dB down at 150Hz; 6dB/octave slope

Limiters

Threshold: 0dBm to +15dBm
Attack time: 1 msec
Release time constant: 0.1 sec or 1 sec

Operating Voltage

Internal: Two 9V alkaline batteries
Battery life: >8 hours for normal use
External: 12 to 30 VDC;
Current draw: 40mA idle at 18V

Dimensions and Weight

58mm H x 161mm D x 184mm W;
(2 1/4" x 6 3/8" x 7 1/4")
without batteries: 1.6 kg; (3.5 lbs)

SHURE®

digital animations.

Video Delay: RAM-based digital player and simultaneous recorder.

RAMSES I, II: compact RAM-based digital recorder.

LSM: instant slo-mo system with simultaneous playback and record.

Circle (604) on Reader Service Card

Extron Electronics

VTG 50 & 100: video test generators.

GLI 250: ground loop isolator.

Pa 1 200: peaking amplifier.

System 8: switcher/projector controller

Circle (351) on Reader Service Card

F

Fairlight ESP

Edit Decision List: for MFX2 digital audio production system.

MFX Tower: fully featured multitrack digital audio workstation.

Circle (605) on Reader Service Card

Faraday Technology Ltd.

Product line includes: video, RF filters, delay lines for conventional and HDTV.

Circle (606) on Reader Service Card

Faroudja Laboratories

LD100 line doubler: accepts NTSC, S-video inputs; also for PAL.

LD100-U line doubler: multistandard unit for NTSC, PAL.

Circle (607) on Reader Service Card

Farpoint Technologies Inc.

Information not available.

Circle (608) on Reader Service Card

FAST Electronics

Video Machine: complete A/B editing system with machine control, for PC or Macintosh, composite or S-VHS NTSC, PAL or SECAM video.

Circle (609) on Reader Service Card

Fast Forward Video

Bandit: transfer full-screen images from Mac or PC to VCRs.

Circle (610) on Reader Service Card

Feral Industries

C-100: TBC/synchronizer; multiple inputs, outputs with transcoding; operates in NTSC and PAL.

C-100 Plus: TBC/synchronizer with adaptive digital comb filter and automatic DOC; multiple I/O.

MICRO: board-level TBC/synchronizer; 4:2:2 processing, automatic DOC; composite and Y/C I/O, gen-lock.

Dual 4:2:2 TBC: stand-alone with RS-232 remote control.

Circle (1207) on Reader Service Card

Fiber Options

Series 100V Video systems: 1-4 video channels over a single fiber.

Series 200D Data systems: video plus data, with or without audio, dual or single fiber operation.

Series 300A Analog Audio systems: voice, control voltages, intercom and telephone interfaces available.

Series 240B video/audio link: stereo audio with video on single multimode fiber.

Series 290B digital control link: carries SMPTE 207M 4-wire machine control on single or multimode fiber.

Series 312B stereo audio link: balanced audio over multimode fiber.

Circle (611) on Reader Service Card

Fidelipac

DCR-1000 Series: digital cartridge machine, stores spots on 3.5" floppy disk, longer elements on 13.3MByte disks.

Elite series: modular furniture for the studio by Murphy.

MX series: modular audio consoles.

Series VI: audio consoles for on-air by Broadcast Audio Division

Circle (612) on Reader Service Card

Flash Technology

FTS 2100 SMART: System Monitoring And Reporting Telemetry; a self-evaluating obstruction lighting system.

EAGLE: PC beacon monitoring for SMART systems.

Circle (613) on Reader Service Card

FloriCal Systems

AirBoss automation: unattended TV on-air switching accepts traffic schedule and ShowTimer cue times.

CardDirector robotic controller: database, control and traffic management for Sony FlexiCart.

ShowTimer enhancement: controls satellite dishes, receivers; includes traffic system and LAN workstations.

TimeShifter: delay live signals by any time increment from seconds to minutes.

Validator: Monitors baseband video and audio, examines and reports each frame.

Circle (614) on Reader Service Card

FM Systems

ATIS EATER: filter removes transmitter ID signals to avoid crosstalk in the demodulator.

Camera Master: hand-held digital meter for sync, white, iris, focus and color burst.

VM771 Video Master: ALC for video signals.

SPM-1: for measuring stereo separation.

Circle (615) on Reader Service Card

Focal Press

Product line includes: Professional, educational and reference material for broadcast and electronic media.

Circle (616) on Reader Service Card

Folsom Research

Otto: broadcast quality autostill video scan converter.

Circle (617) on Reader Service Card

FOR-A

MV-91C Multi-Viewer: 5+1 split screen presents five 1/9 nonsynchronous images and sixth picture as 4/9 on NTSC monitor.

PAM-300 audio mixer: 8-input, stereo output system; for audio-follow-video systems; parallel and serial interface capability.

DVM-400: 10-input digital component switcher.

EC-780 edit controller: enhancement; A/B/C-roll and audio interface option.

HMC-1022 capture camera: 2048x1536 pixel resolution camera with IBM AT interface.

VPS-300 video production system: video switcher with 3D digital effects; compatible with composite, S-VHS and component video.

UDP-2000 Universal Digital Processor: color correction, motion-comp., median and recursive noise reducers; digital interfaces.

UDP-500 universal digital processor: TBC with low-cost, motion-compensated median and recursive noise reducers.

MF-300 Multiflex: low-cost 3-D digital effects generator.

CSS-200 still store: uses JPEG compression to store 200 TV frames on each 50Mbyte removable hard drive; 0.6sec access time. RC or RS-232 control; for NTSC composite with gen-lock inputs.

MVC-200: translates Mac II graphics to true NTSC and PAL formats.

FA-20 TBC card: with S-VHS and composite I/O.

High Definition Digital Camera System: combines HMC-1020 camera and REBO Research ReStore/Pro high def. imaging system to capture HD images into a Mac II.

Circle (618) on Reader Service Card

Forecast Installations

Image Master: edit console.

Circle (619) on Reader Service Card

Fostex

Model DCM100/MIXTAB: digitally controlled mixing system.



Model DT80: linear digital 8-track recorder.

SP-32 speaker: 2-way systems for commercial PAs.

RD-8: digital multitrack recorder

D-10: 2-head professional DAT recorder. (See Pick Hits)

Circle (620) on Reader Service Card

Franklyn R. Beemish

Services include: system, facility engineering, design, construction.

Circle (621) on Reader Service Card

Frezzolini Electronics

AR304 auto-ranging charger: fast "smart" NiCad charger for 12-30V, 1-12Ah packs; 4-channels, lightweight; auto line select.

ARI24 charger: auto-ranging system for 6-15V, 1-12Ah battery packs; 4-channel; fully automatic.

FNP-1SB: high energy output NP-1 type battery.

HMNP, HMNP½: NP-1 camera battery conversions brackets.

Solar Charger: ENG battery, super-compact solar charger.

AR301 charger: single-channel system; auto-ranging for 12-30V, 1-12Ah Nicads; fully automatic.

MF-NP1: mini-fill light with NP-1 battery connector.

SF1: 4 channel charger for NP1 batteries.

Circle (622) on Reader Service Card

Fujinon

A14x8.5EVM: handheld lens for 2/3" cameras, comfortable hand grip and control; 2x extender.

A18x8.5EVM, S18x6.6EVM: lenses for 2/3" and 1/2" cameras; multiposition servo grip, multistep zoom speed; 2x extender.

A20x8BESM, A20x6.2ESM: 2/3", 1/2" lenses for studio production; reduced chromatic aberration, flare, reflections; improved modulation transfer function; 2x extender.

A24x1.5SERD: compact lens for handheld cameras, integral 2x extender.

A8.5X5.5EVM, S8.5X4.2EVM: lenses for 2/3", 1/2" cameras; VM series includes 5-position servo grip, user-selected zoom speeds; 1.7x extender.

A15x8EVM, S15x6.1EVM: aspheric, inner focus lens with "V" grip. High magnification, wide angle.

A8.5x5.5EVM: like A15x8.5 features ultra-wide angle.

A16x9RM/ERM: aspherical lens with high magnification and wide angle for ENG/EFP applications.

Ah66x9.5ESM, Sh66x7.3ESM: world's highest magnification field production lenses.

Ah24x7ESM: multipurpose studio lens.

Ah20x8ESM, Sh20x6.2ESM: studio production workhorses

EPT-10 pan/tilt head: supports loads to 22 lbs; 300° pan, 95° tilt ranges; 90-260VAC power; EOP-20, EOP-30B, DOP-50A controllers offer various control modes, including presets.

EPT-30 pan/tilt head: fully operable underwater to 20 feet; +-300° pan, +-95° tilt; 9°/sec pan and tilt speed; loads to 22 lbs; 24Vdc power required.

HR22x18ES: high-definition lens with 1/3.4 aperture maximum; zoom ratio of 10x or 22x; 2x extender.

HR6x12ERD: HDTV lens for 1" cameras; 2x extender

Tips on Optics: 20-page pocket guide to lens selection.

Circle (623) on Reader Service Card

Full Sail Center for Recording Arts

Courses: film, video production, post-production, lighting, special effects, make-up, set design, creative writing.

Circle (624) on Reader Service Card



Future Store Int'l.
Information not available
 Circle (625) on Reader Service Card

G

G&M Power Products
GM30B Lighting Belt: sun-gun battery with 30V 4Ah rating.
GM4X1NP charger: simultaneously charges four NP1A batteries within one hour.
 Circle (626) on Reader Service Card

Garner Industries
CF750 Type II degausser: meets NSA/DOD requirements for Type II erasure of 7500e media to -90dB.
Model 1400 degausser: erases Type C reels to 14" diameters, VHS, Beta, U-matic, D-I, S-VHS media; 120VAC 60Hz operation.
 Circle (627) on Reader Service Card

GE American Communications
Product line includes: Program delivery services via satellite.
 Circle (628) on Reader Service Card

GE Lighting
Product line includes: Lamps for stage, studio.
 Circle (629) on Reader Service Card

GE Support/RCA Broadcast
Product line includes: Field maintenance service for existing RCA equipment; stage, studio lamps, parts, tech. assistance, training and emergency services.
 Circle (630) on Reader Service Card

Gefen Systems
Filemaster: for AKAI DD1000, AMS Audiofile Plus, Lexicon Opus or Panasonic SV3900; automatic transfer of sound effects from CDs.
NSM CD 3101: 100-CD changer; performs pre-programmed "concerts."
Pioneer CVC-V3000: 300-CD changer; includes software for IBM or Macintosh control.
SFX libraries: collections including Sonic Boom, BBC, DigiFacts.
Touch the Music: touchscreen background music system
 Circle (631) on Reader Service Card

Gennum/Video-Broadcast
GENLIX serial digital chipset: GS9000 decoder, GS9002 encoder, GS9004 equalizer, GS9005 reclocking receiver, GS9007 driver; supports SMPTE 259M serial interface standard and 360Mb/s links.
GF9101 multirate digital filter: for sample rate conversions between 4FSC and 4:2:2.
GS4881 sync separator: analog IC packaged in 8-pin PDIP or SOIC; separates sync for video scanning from 10kHz to 130kHz.
 Circle (632) on Reader Service Card

Gentner Communications
ALS: Assistive Listening Systems products designed to help expedite compliance with Americans with Disabilities Act.
Audisk: digital audio storage system.
Digital Hybrid I: digitally processed hybrid for on-air, recording.
Lazer 2.0: digital limiter, stereo generator for FM;

3-band, wideband and composite limiting.
TI7200: audio teleconferencing interface.
GT line: of group teleconferencing systems for connection to most video CODEC or satellite transceivers.
 Circle (633) on Reader Service Card

GEPCO International
552404 & 552412: 4 and 12 pair configurations of 5524, 110Ω, digital audio twisted pair.
5526: ultra-flexible oxygen free copper patch cable, 110Ω, AES/EBU compatible.
 Circle (634) on Reader Service Card

Getris Images
Dynamic Paint: features morphing, metamorphosis, non-linear paint effects; option for use with Eclipse, Venice products.
Integrated systems: uses Sony DNS-100 still-store in Getris Images systems.
 Circle (635) on Reader Service Card

GML Inc.
GML series 2000: moving fader automation system for video/film.
HRT-9100: all discrete line-level mixer series.
Model 8200: 2-channel parametric EQ.
Model 8300: 4-channel mic pre-amps.
Model 8900: dynamic gain controller.
 Circle (636) on Reader Service Card

John Gorrell Woodworking
Information not available.
 Circle (637) on Reader Service Card

Gorman Redlich
Portable off-site EBS monitor: tunable AM/FM receiver and FCC certified decoder.
 Circle (638) on Reader Service Card

Gotham Audio
Product line includes: Distributors, audio products.
 Circle (639) on Reader Service Card

Graham-Patten Systems
D/EMEM Plus: for D/ESAM 800; enhances memory management to 900 internal registers; to configure virtual machines and other advanced features; disk drive stores entire system memory
D/ESAM 400: digital edit suite mixer; 32 analog/digital inputs.
D/ESAM 800 delay option: to delay audio to match video.
D/ESAM 800 Ver 2.0: upgrade EPROM adds manual crossfades, auto To/From for auto-assembly; other features.
DATS: digital audio interface converters.
 Circle (640) on Reader Service Card

Grass Valley Group
8800 series: range of high-density analog video DAs; based on 8500 series; 8 outputs with 10 DAs per 2-RU frame.
Halo video typography: enhancement to Graphics Factory integrated graphics platform; adds dimensionality to system fonts.
MCF series: multichannel digital fiber-optic transmission system up to 12 channels of 10-bit video, each with four audio channels.
Model 1000 production switcher: component digital system; serial or parallel I/O; 10-bit processing; similar to GVG 110CV.
Model 4000: component digital switcher, similar to GVG 3000.

Performer-SD routing switcher: compact one-RU router for serial digital signals; 10x1 V/A matrix.
Sabre 4100: editing system, with control for up to 36 devices.
SMS-8000 series: modular serial digital format conversion.
SuperEdit Ver. 7.0: software upgrade for VPE editing systems.
PRONTO: ID system offers operation as optional character generator.
MAX-9000 series addition: M9205-N, M9206-N digital audio multiplexer and demultiplexer; units simplify audio distribution.
videoDesigner upgrade: software enhancement.
 Circle (641) on Reader Service Card

Gray Engineering Labs
DTR-313 reader, generator: full featured family with independent LTC, VITC functions, SMPTE and EBU specifications.
VR-321 safe title/safe action: video reticle generator; dual-standard system has size, position control, store/recall functions; crosshair, cross-hatch, keying capabilities.
FDG-345 film data generator: family of tach-locked time code with film data VITC generation.
DR-107B time code reader: SMPTE/EBU unit reads LTC from 1/100 to 1000x play speed, inserts character window of time or user bits.
TCA-143 time code analyzer: shows code phase relative to sync, detects color frame, count error, bit error, with alarms.
 Circle (642) on Reader Service Card

Great American Market
BEAMER: permits existing theatrical fixtures to moving lights; remote controlled rotation; mounts to gel holder of 6" or 8" lensed fixture; may accept analog or DMX control from lighting console; mirror pan range 160°, tilts 90°.
BONJO: a pattern holder that permits rotation of the pattern without removing it from the fixture.
IntellaPattern: stainless steel templates for use in pattern wheel of Intellabeam fixtures.
RDS/Techno-Light: automated lighting system; TACT control console, 6-fixture distribution box, 60 cue capacity.
Shadow Play 5: enlarged catalog of projectable patterns.
TwinSpin: double B pattern rotator for 6" ellipsoidal instrument.
 Circle (643) on Reader Service Card

Group One Ltd.
XTA Electronics: DS400 mic/line distribution system; RT-1 real-time analyzer system; 1¹/₃-octave graphic equalizer.
Focusrite Red Range: RED-1: 4-channel mic pre-amp; RED-2: 2-channel parametric EQ with four distinct EQ sections.
KKR monitor speakers:
 Circle (644) on Reader Service Card

GTE Spacenet
Global News Express: news gathering service by satellite.
 Circle (645) on Reader Service Card

Guicar Television
3D & Normal effects: more than 50 1-minute broadcast quality special effects.
Fantastic Videolibrary: two subject groups; 80 1-minute sequences of sky images; multiple special event cuts in 1-minute lengths.
Videorecorder Video Test: 30-minute videocassette for checking TV/monitor and video tape equipment.
 Circle (646) on Reader Service Card

H

H L Dalis
Product line includes: Distributor for Belden, Neutrik and SwitchCraft, Fluke, Sony, JVC and Denon DAT and S-VHS videotape.
 Circle (647) on Reader Service Card

Halland Broadcast Services
CD Music Libraries: for airplay.
 Circle (648) on Reader Service Card

Hallikainen & Friends
DRC200 enhancement: programmable multisite transmitter remote control systems.
ITO-178: plug-in card for PCs to control Moseley TRC-15, connects to the TEL 171 digital adapter.
TEL-171: converts Moseley TRC-15 to digital metering.
 Circle (649) on Reader Service Card

Hamlet Video International
301 Video Scope: 3-channel composite, component, S-VHS waveform/vectorscope; stereo/mono bar graph, polar audio displays; BNC front-panel probe input; auto NTSC/PAL switching, full screen

The future looks awesome from here.

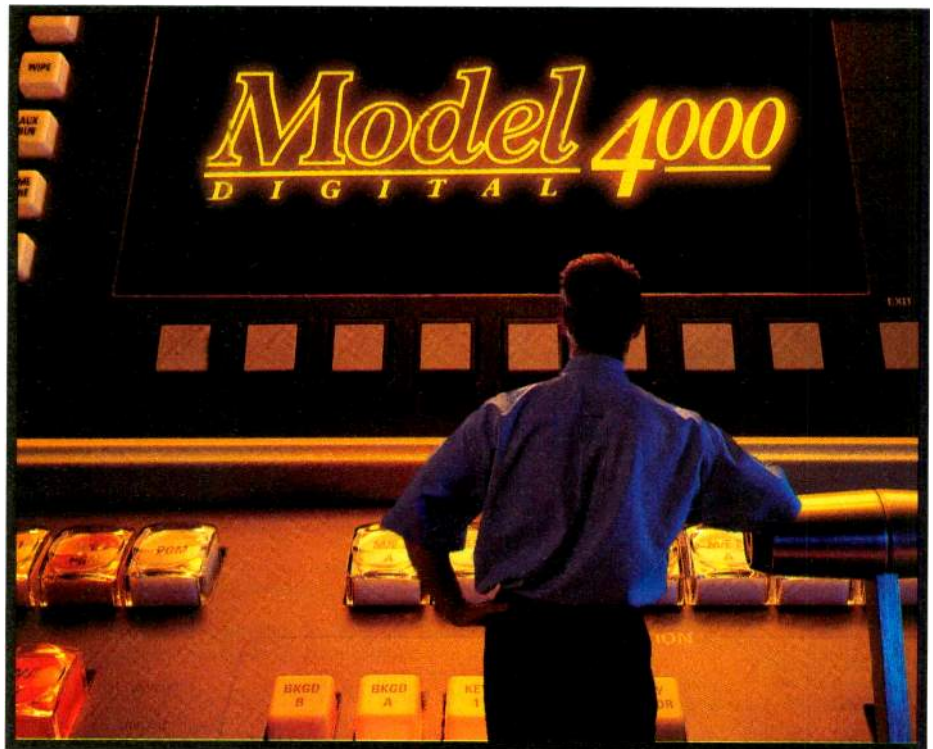

If you've ever wondered what the future of video will look like, here's where you can see it. From the driver's seat of a new 4000 Series Digital Production Switcher.

You'll see video with the crystalline clarity only available from a virtuoso combination of component video technology and advanced digital signal processing. And you'll observe more sophisticated keying power than we've ever engineered into a switcher.

The future will also be a very cost-effective place to work. That's because 4000 Series Production Switchers are built with serial digital technology that slashes the installation costs and ongoing maintenance expenses of analog technology. Not to mention protecting your investment for the long view.

For an up-close look at the performance and value of our 4000 Series Production Switchers, call your GVG customer representative now. But hurry. We wouldn't want the future of video to start without you.

Grass Valley Group

A TEKTRONIX COMPANY

NORTH AMERICA Grass Valley, CA (916) 478-3000 SOUTH AMERICA Miami, Florida (305) 477-5488

Europe Basingstoke, UK (0256) 817817 ASIA Hong Kong (852) 5987118 JAPAN Tokyo (03) 5992-0621

©1992 The Grass Valley Group, Inc.

Circle (46) on Reply Card



or 1/2 and split displays; RS-232 control.

303 Video Scope: composite NTSC/PAL vector, waveform monitor, 5-function user setup memory, software remote options.

304 Video Scope: multistandard with simultaneous component, composite waveform, vector displays on standard or component monitor.

502 Stereo Scope: 4-channel mono, dual stereo on-screen display; shows left/right, sum/difference as VU or PPM and polar plot.

535 Video Scope: 2-channel stereo on screen bar graph display with phase indicator; left/right, middle/side with phase bar; flexible display options operating in composite NTSC or PAL.

MatchCam: camera alignment system; option for Video Scope units.

Micro Scope: hand-held, composite waveform/vector unit.

PC Scope: board-level NTSC/PAL waveform/vector with mono/stereo audio displays; for Amiga, PC or MAC.

Porta Scope: portable Video Scope enclosure.
Circle (650) on Reader Service Card

Hardigg Industries

Product line includes: equipment transport cases.
Circle (651) on Reader Service Card

Harris Allied Broadcast Div.

Harris Sigma Series: IOT UHF TV transmitters; ATV-ready 15-240kW; standard control cabinet for single or dual exciters.

Harris STL/TSL: an ATV/NTSC digital microwave STL/TSL system with both ATV & NTSC on a single 6GHz or 12GHz digital radio.

Harris System Manager: (HSM) monitoring and control system, with alarm.

Harris Platinum series: ATV-ready solid-state VHF TV transmitters.

DC-128: PC based remote control system.

DX-15 digital solid-state transmitter: medium-wave, 15kW solid-state system.

DX-150FA: frequency-agile, 150kW digital solid-state medium wave transmitter.

DT-20FM: 20kW FM transmitter with Digit digital FM exciter.

Harris Allied S-2A: air-transportable satellite uplink; for Ku-/C-band.

Harris Allied S-18A: mobile Ku-band uplink.

Harris Allied S-23: Ku-band uplink and video production center in one vehicle.

TVT Scepter Series: solid-state UHF transmitters.

Harris PT series: solid-state FM transmitter.

HDTV system information.

Platinum Sentry option: provides access to complete transmitter status information and control capability from PCs.

Harris Navigator Series: UHF solid-state TV transmitters.

Digitol remote control: PC-based remote control systems.

Harris single-tube HT series: FM transmitters, 3.5kW to 35kW.

Harris GATES FIVE FA: 5kW frequency-agile, solid-state medium wave transmitter.

Harris solid-state HT series: FM transmitters of modular solid-state design for power levels from 250W to 1kW.

Harris Digit: digital 50W FM exciter.

RBDS equipment: RBDS technology from Re America and others.

Circle (652) on Reader Service Card

Harrison by GLW

Model MPC: Motion Picture Console for total automation dubbing.

Circle (653) on Reader Service Card

HEDCO div. of Leitch

ADA-Mix Box series: -816MB, -881MB stand-alone monaural audio, -883MB stereo audio DAs.

Model VCA-680MB: video clamping amplifier Mix Box.

Xplus series modules: for VSR-16x16, VSR-16x1 serial video and ASR-8x8 AES/EBU audio routers.

PDA-680MB: Mix Box pulse DA.

Models VEA-680MB, -681MB: Mix Box series stand-alone video equalizing and EQ with clamp DAs.

UDA-680MB: Mix Box utility, video DA.

SVD-680MB: Mix Box switchable video delay amp.

GPI-20, GPI-40: 20-I/O and 40-I/O GPI and joystick control panels for Xplus series routers.

Xplus series: routing switcher modules and control panels.

ATG-880: Mix Box series audio tone generator.

Circle (654) on Reader Service Card

Henry Engineering

Digicord: general purpose digital audio recorder.

DigiStor: digital message storage.

Edit Track workstation: for dubbing, voice-over, utility audio control.

Micromixer: 4-input stereo line utility mixer.

Telephone Information Service: provides listener information services; stores 10 messages; callers select message via touch-tone phone.

Twinmatch: dual stereo, impedance, level converter.

Circle (655) on Reader Service Card

Hewlett-Packard

HP 3589A: time-gated spectrum and network analyzer.

Tools for Video Test/Measurement: 1992 product guide focused on oscilloscope and signal analysis instruments.

HP Quality Advisor: realtime digital video measurement device. (See Pick Hits)

EDH 10 Inserter: inserts Error Detection and Handling (EDH) packet into digital video per SMPTE 165.

Video format conversion: products include encoders, decoders, serializers, deserializers, D/A converters and A/D converters.

HP Digital Video Power Analyzer: for monitoring TV transmitters.

Circle (656) on Reader Service Card

High Density Circuits

UTS Video Intervalometer: time lapse videography in the camera.

Circle (657) on Reader Service Card

Hipotronics

Product line includes: Power control equipment, Peschel automatic voltage regulators and variable transformers.

Circle (658) on Reader Service Card

Hitachi Denshi

SK-F200: studio camera using IT CCDs with 700-line resolution.

SK-F380: field/studio camera with 600,000 pixel FIT CCD's.

SK-F38: hand-held version of SK-F380.

SK-H5: portable camera using Harpicon tube, dockable, multicore, triaxial systems available.

VL-D550 D-2 recorder: with improved front panel, menus and machine status displays, memory card stores individual user setup data, serial interface.

Z-ONE-C: portable CCD camera; 2/3" 400,000-pixel array, new low-light capability.

Circle (659) on Reader Service Card

Hi-Tech Furnishings

Product line includes: Work area furnishings.

Circle (660) on Reader Service Card

Hi-Tech Trading Company

Product line includes: Buying, selling and locating used equipment.

Circle (661) on Reader Service Card

Holiday Industries

HI-3520: battery operated microwave monitor with alarm; detects electromagnetic radiation from 1 to 18GHz.

HI-3627: 3-axis ELF magnetic field meter.

HI-3701: induced body current meter.

HI-4000: RFR hazard measurement system.

Circle (662) on Reader Service Card

Hoodman

Mobile Equipment Cart: for field and/or studio use.

Circle (663) on Reader Service Card

Horita

GPS-based generators: Master Time Code and Master Sync sources.

PC cards: plug-in board for SMPTE time code, blackburst, sync and tone generation.

Video distribution amplifier: user configurable.

Circle (664) on Reader Service Card

Hotronic

AS11: broadcast-quality, PC-controllable plug-in switcher with digital effects; software upgradeable.

AQ21: stand-alone switcher; integral Y/C, composite compatible TBC frame/sync, digital effects, compression, DSK, PC controllable.

Circle (665) on Reader Service Card

Howe Industries

Product line includes: Custom transit cases and shipping containers.

Circle (666) on Reader Service Card

Hughes Communications

Product line includes: Broadcast satellite services, program distribution.

Circle (667) on Reader Service Card

Hughey & Phillips Inc.

Solid-state controller: for dual red and white lighting systems; includes DC backup.

Circle (668) on Reader Service Card



IBM Corporation/US Mktg/Sales/Comm.

POWER Visualization System(PVS): a general purpose, resolution-independent production and post-production computer.

Circle (669) on Reader Service Card

IBM Multimedia

Ultimedia series: PS/2 486-based machines; 3-year on-site service with 4-hour response time.

Enterprise Multimedia hardware: RISC System/600, AS/400, ES/9000.

Ultimedia Tools series: products from IBM and other vendors; creativity products; unified by Tools Series Architecture.

Circle (670) on Reader Service Card

IBSS

Ghielmetti GKVA2x32: jackfield for audio signal routing control; applicable for analog, digital.

Circle (671) on Reader Service Card

IDB Communications

Product line includes: Satellite communications systems, the Flyaway Phone, satellite terminal in a suitcase.

Circle (672) on Reader Service Card

IDEN Videonics

IFM-50: Frame memory unit NTSC/PAL. Frame sync/TBC with RS-232.

IP-450: standards converter for 8-bit multidirectional operation among NTSC, PAL, PAL-M and SECAM; composite, component Y/C and RGB/S I/O.

IP-X8: computer to video, scan converters.

IP-X20 & IP-X21: VGA cards with built in scan converters.

IP-X50 scan converter: flicker free scan conversion from VGA or Mac II to video; composite, Y/C and RGB outputs in NTSC and PAL.











IVT-20-1, IVT-20-2: dual-channel TBC, transcoding with composite, component and Y/C I/O, RGB/S

**THE ULTIMATE
SYSTEM
SOLUTION!**

pro-bel

At the Heart of your System

Pro-Bel, the leading European supplier of routing systems, is now established in the U.S. We are committed to solving your video and audio routing system problems, be they analog or digital, with a wide array of established products.

-  Analog Audio and Video Matrices.
-  Digital Audio and Video Matrices.
-  RS-422 and 4 wire matrices.
-  Sophisticated user friendly controllers.
-  Automatic tie line operation.
-  Programmable control panels.
-  Under monitor displays.
-  Digital audio converters.
-  Analog and Digital Video Keyers.
-  Digital audio and video test sets.
-  Custom systems.

PRO-BEL INC 4480 North Shallowford Road, Dunwoody, GA 30338-6410
Tel: 404-396-1971 Fax: 404-396-0595

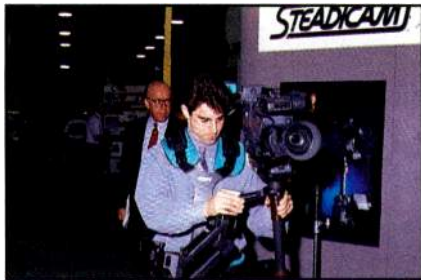

inputs; -1 for 4:1:1 processing, -2 for 4:2:2 processing.

IVT-60: 1- to 6-channel transcoding TBC/synchronizer; composite, component and Y/C I/O facilities.

IVT-7, IVT-7/RGB: composite and Y/C TBC with Freeze feature; /RGB includes RGB I/O.

IVT-9 TBC: full transcoding TBC/frame store with strobe, freeze, sepia effects; composite, component and Y/C I/O; single channel.

Quartet: video production system combines 4-input switcher, digital effects, dual TBCs, keyer; operates from front panel or via Windows-based software.

TBCard, TBCard II: plug-in TBCs for Amiga, IBM; TR-7 remote; composite I/O; TBCard has Y/C input; TBCard II has Y/C IO.

Circle (673) on Reader Service Card

IDS/SAIC

Product line includes: Eidophor video projection systems.

Circle (674) on Reader Service Card

Ikegami Electronics

16 series: professional color monitor; 500-line display.

18 series, 19 series, 20 series: color monitors with auto setup features; -18 for 600TVL, -19/-20 with 700TVL resolutions.

30 series: color monitor with high resolution CRT and auto setup feature; 20" diagonal.

DMC-4501, -4502: digital codec multichannel compression teleconferencing processor; carries four NTSC visual signals with eight sound signals; DS3 standard.

HC-240A: upgraded 3-CCD camera using 1/2" FIT devices.

HC-340: portable camera using 3 2/3" IT CCDs.

HK-343, HL-43: field/studio camera and portable companion using 3 2/3" IT CCDs.

HK-355A: studio/field CCD camera; RGB wideband triaxial system with base station.

HK-377, HL-377: ultra wideband studio/field and portable companion CCD camera; resolution to 900+ lines; 2/3" FIT CCDs with 600,000-pixel arrays; triaxial cable with base station.

HL-55A, HL-55V: 3-FIT CCD camera and camcorder.

PM9-5A, PM-9030: monochrome monitors in 9" and 14" CRT sizes.

PP-70, PP-80: portable microwave links; -70 with 2/7/13GHz, -80 for 2/7GHz.

Circle (675) on Reader Service Card

IKON Video

VW-160: an economical and versatile video wall processor.

VW-300: high resolution and completely modular video wall.

Circle (676) on Reader Service Card

ILC/Daymax

Product line includes: lighting products based on metal halide lamps; DSB-575W ballasts.

Circle (677) on Reader Service Card

illbruck/SONEX Acoustical Products

ProSPEC: pyramid acoustical foam, composite barriers.

SONEX: fabric covered panels.

Circle (678) on Reader Service Card

Image Design Filmtechnologies

RETHETO: film-cleaning machine, with environmentally friendly chemicals, for 16 & 35mm film.

Circle (679) on Reader Service Card

Image Logic Corp.

Direct Caption Card: addition to AutoCaption system, preview captions by displaying them over video directly from the PC.

Universal EDL maker: addition to LogProducer; EDLs and scene lists can be generated from Log Producer logs.

Circle (680) on Reader Service Card

Image Video

AMM-1: 20 segment-per-channel bar mode LED multimeter.

A1240 router: for AES/EBU signals.

A860: A/D converters convert two analog audio inputs to one AES/EBU digital output.

APC980 station automation: for small to intermediate market, real time programming.

CMS-1000: divides VGA or S-VGA into RGB signals.

SMA-50: stereo monitoring amplifier with balanced audio inputs.

D960 converters: D/A devices convert one digital audio input to two analog outputs.

Quantaflex: under monitor displays.

9800 series: routing switchers for AES/EBU digital audio signals.

9910 series: digital video routing switcher.

Circle (681) on Reader Service Card

IMC/International Music Corp.

Model CD3000: sample player with integrated CD-ROM drive.

Model DD-QMac II: editing software for DD1000 disk recorder.

Model DR4d: multitrack hard disk recorder.

Model S01: MIDI digital sampler.

Model S2800, S3000, S3200: stereo digital sampler.

Circle (682) on Reader Service Card

ImMIX

VideoCube: digital workstation for post-production; disk-based non-linear editing; real time digital effects creation; high-resolution anti-aliased character generation; editing, mixing of CD-quality audio. (See Pick Hits)

Circle (683) on Reader Service Card

Industrial Acoustic Company/IAC

STC 49 door: acoustical door; Noise-Lock design.

Accutone 2000 room: includes compatible 5" thick, triple seal door.

Circle (684) on Reader Service Card

Inline

IN1240: hand-held scan doubler and quad decoder.

IN3710/20 RGBS switchers: 4- or 6-port RGBS/video switcher, distribution amplifier.

IN40000 V-Net: high-resolution video network.

IN60000 Pathfinder: matrix switchers to 16 channels; for 120MHz video and audio routing; may be reconfigured.

IN7000, IN8000, IN9000 series: cables and connectors.

Circle (685) on Reader Service Card

Innovision Optics

3-axis Mini-Jib arm: portable camera support handles 100-pound loads.

Mini-Mover enhancement: portable motion control tables, joystick controllers; 4-axis movement; memory permits motion repetition.

Right angle Probe: 90° angle of view for video cameras.

Probe Seal: underwater cover for probe lens.

Series 6000: tubular, high-res. lens, self-illuminating with direct, 90° and 45° angles of view.

Circle (686) on Reader Service Card

InnoVision Technology

Broadcast Titrer 2: broadcast-quality CG for the Amiga.

MONTAGE: 24-bit tiling software for the Video Toaster.

PrimeTime: broadcast-quality CG for IBM ATs and

compatibles.

Circle (687) on Reader Service Card

Inovonics

DAVID: stereo audio processor; includes FM stereo generator.

530: off-air modulation monitor for FM broadcasters.

The Sentinel 550: broadcast monitor receiver/evaluator.

Circle (688) on Reader Service Card

Insulated Wire/Microwave Products

Information not available.

Circle (689) on Reader Service Card

Integrated Switching Systems

PathFinder: switchers that can operate at 1.2Gbs.

SRX: small matrix serial router operating at 400Mbs.

Circle (690) on Reader Service Card

Intelligent Resources

D-1 Serial: Digital I/O for the Mac.

Component Modules: accepts and transmits 3-wire component video signals.

Software Release 3.0: user-configurable, open architecture system to control IR products; can be used to interface third party products through VideoBahn.

Video Navigator: editing software for the Video Explorer.

Circle (691) on Reader Service Card

Intelliprompt (DREAMDATA)

Product line includes: Video prompter systems using PCs, Intelliprompt II.

Circle (692) on Reader Service Card

Intelvideo

DEC 7: NTSC color decoder.

INR impulse noise reducer: removes impulse noise from ignition, electrical and other sources; removes video dropout from NTSC color signals.

Circle (693) on Reader Service Card

Interface Controls

IC 1000: microprocessor based control box.

VC-1R: audio level control for 2 channels at line level.

RM-1R: radio module with optional high gain antenna.

PC-1R: on/off power controller for 120VAC 10amp.

MC-1R: bidirectional motor controller for 120VAC motors, 10amp.

WC-16 & WC-48: wireless control of 16 or 48 channels.

SC 1000: VGA to video scan converter.

Series 3000: automatic dimming system for dimming up to 2.5kW. also available in a rackmount 6-pack version.

Circle (694) on Reader Service Card

Interlace Engineering Corp.

MAXX Series 10: PC graphics frame buffer for broadcast and post-production. Manipulates 32-bit pixels, software programmable.

Circle (695) on Reader Service Card

International Datacasting Corp.

SR250/DA: addressable satellite receiver for data/audio.

MPEG PRO Series: transmit digital audio via satellite.

Circle (696) on Reader Service Card

International E-Z UP Inc.

EZ UP Instant Shelter: self-contained, quick setup, heavy-duty fabric tops with double-truss design.

Circle (697) on Reader Service Card

International Tapetronics/ITC

DigiCenter: digital audio operating platform; hard disk record/playback; traffic interface, automation capabilities.

DPR-612: digital program repeater; stores, replays 15 monophonic programs; for IDs, lines, effects, other short message needs.

Series 2: audio tape cartridge recorder/reproducer; mono, stereo models; Dolby HX Pro headroom extension, active balanced XLR I/O.

Circle (698) on Reader Service Card

Trust the Power



You Can Rely on Varian Tubes.

When the name on your transmitter tube is Varian, you're getting something no other tube can offer — Varian reliability. Varian's klystrons and Eimac® tubes keep your signal strong and on-the-air for years of worry-free dependability.

Varian reliability is beyond the ordinary because we understand the demands you place on broadcast tubes. Before a Varian tube is shipped to a customer, it undergoes stringent tests to insure maximum performance when you powerup.

Since we invented the klystron and designed the first Eimac tube over 50 years ago, we have been delivering reliable power for broadcasters worldwide. And with our commitment to continuous improvement, we have increased tube life, power levels, and efficiency to meet your evolving requirements.

Call us today and see for yourself why Varian tubes are the ones broadcasters trust. In the U.S. call 1-800-544-4636. From other countries, call 415-424-4819.

varian 

Circle (48) on Reply Card

Intraplex

SAM 4400: switched audio multiplexer for distribution of digital audio signals over switched digital networks.

Circle (699) on Reader Service Card

IRIS Technologies

IRIS Desktop Control Platform: hardware, software for Video Commander for Windows; routing, machine control, mapping engines for specialized applications.

Video Commander: routing and switching system for 16x16, 32x32 and 64x64 matrices.

Circle (700) on Reader Service Card

IRT Electronics Pty Ltd

Digital intercom system: 32x32 matrix with single twisted pair interconnection, software configurable switch functions.

VA-393, VA-394: portable analog video, audio fiber-optic transmission system, meets RS-250B short haul spec.

Video Isolator: modular hum isolation system with 500V protection.

VA-391, VA-392: fiber-optic transmission systems with video and up to four audio channels on 1300nm single-mode fiber.

VISCAS: 7.5kHz vertical interval audio system; carries audio within the video signal.

Circle (701) on Reader Service Card

Italiana Ponti Radio SRL

A5000: 5kW TV amplifier(UHF)

LTSM: surge arrester

MMDS: multichannel microwave distribution system.

TTSU/2/5/10: TV exciters

TVM1: TV modulator

TVS100: 100W TV amplifier(UHF).

TVS1000: 1kW TV amplifier(UHF).

TELECAM: Portable microwave transmitter and

receiver.

MTS Series: mobile microwave links.

Panoramic Head: remote control head for dishes up to 120cm diameter, 60Kg maximum weight.

Circle (702) on Reader Service Card

Itame SA

SuperGalaxy 5 KW: FM transmitter.

Circle (703) on Reader Service Card

ITELCO spa

T 674K: 40kW TV transmitter(UHF) using a single IOT.

Circle (704) on Reader Service Card

ITS/Information Transmission

Exciter Plus system: VHF exciter and all other stages, except final power amplifiers.

ITS-1232A transmitter: 2nd generation -1230A, external diplexing, redundant parallel high gain amplifiers in solid-state 1kW UHF translator.

Wireless cable products: including 1610E 20W, 1615E 50W, 1658E 100W, 1640D frequency agile transmitter, 1694D channel combiner, 650 horn antenna with booster; complete 12-channel 20W wireless cable transmitter system.

Circle (705) on Reader Service Card

J

J-Lab

CCD-3: hand-held camera control unit for Betacam.

Circle (706) on Reader Service Card

James & Aster Music

Product line includes: CD libraries; Classical, Medieval, Renaissance selections, Undercover Records.

Circle (707) on Reader Service Card

James Grunder & Associates

Feral Industries C-100: TBC/synchronizer; multiple inputs, outputs with transcoding; operates in NTSC and PAL.

Feral Industries C-100 Plus: TBC, synchronizer with adaptive digital comb filter and automatic DOC; multiple I/O.

Feral Industries MICRO: board-level TBC/synchronizer; 4:2:2 processing, automatic DOC; composite & Y/C I/O, gen-lock.

Feral Dual 4:2:2 TBC.: standalone with RS-232 remote control.

Hamlet HVI 300 series: combination waveform, vector monitors.

Hamlet Micro Scope: portable waveform and vector for display on NTSC monitors.

Hamlet PC Scope: plug-in for PCs and Amigas for digitally generated waveform and vector on NTSC monitors.

YEM Sync generators: SG-3000B gen-lock system; RS-1701C dual generator; RB-1701C rubidium-controlled dual sync generator.

YEM ENC-3000: gen-lock color encoder.

YEM SW-950: computer graphics video switcher.

YEM DA-950AT: super wideband video DA.

YEM scan converters: CVS-980, 980M monochrome, 980H high-resolution; CVS-970AL graphics to HDTV/31.5kHz; CVS-907 VGA-to-NTSC; CVS-910 real time automatic system.

YEM EDEC-2000: digital decoder and line doubler.

YEM VSG-2000A: digital test generator.

Circle (708) on Reader Service Card

Jampro Antennas

JDMS: dual mode slot antenna.

JDMP: dual mode panel antenna.

JDMB: dual mode batwing antenna.

JHD: low-band VHF dipole panel antennas.

JLHP: series of HP translator antennas.

JLST: series of CP translator antennas.

JMDS: multi-point distribution antenna.

JUHD: broadband UHF panel antennas.

JY-series: YAGI antennas for VHF, UHF, FM transmission.

Circle (709) on Reader Service Card

JBL Professional

Control 8SR: control room monitor.



NEW! Call 1-800-285-6660 for more information.

FREE sample and literature available.

Absorb Isolate Dampen

FIRST A I D FOR YOUR EARS





CONTROL NOISE PROBLEMS!

Circle (49) on Reply Card

Sensational Sound Over Switched 56/ISDN

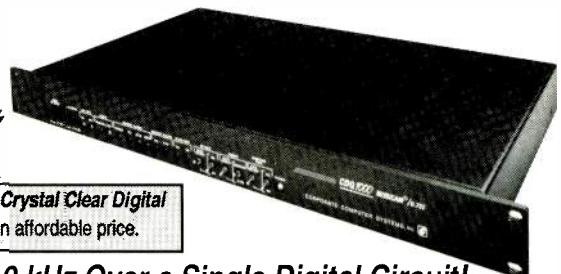

New

The CDQ1000, Crystal Clear Digital Audio™ at an affordable price.

Transmit 10 kHz Over a Single Digital Circuit!

CCS, the pioneer of digital audio codecs, proudly presents the CDQ1000, the only codec that lets you transmit up to 10 kHz of audio over a single switched 56 or ISDN line.

Preserve Your Past Investments in Codecs!

The versatile CDQ1000 is fully compatible with G.722, 7.5 kHz codecs such as the CCS Micro56 and Micro66i. It also interoperates with the CCS CDQ2000 ISO MUSICAM® codec. You can now achieve universal compatibility with a single codec!

- Three modes of operation: 7.5, 8.2, or 10 kHz
- CCITT G.722 or enhanced MUSICAM compression
- Two-way mono transmission
- 56 kbps or 64 kbps data rate
- Both V.35 and X.21 digital interfaces



CCS Audio Products
33 West Main Street
Holmdel, NJ 07733, USA
(908)946-3800 FAX: (908)946-7167



CCS Europe GmbH
Obere Hauptstraße 52
D-8050 Freising
49 8161 12222 FAX: 49 8161 12280

Circle (50) on Reply Card

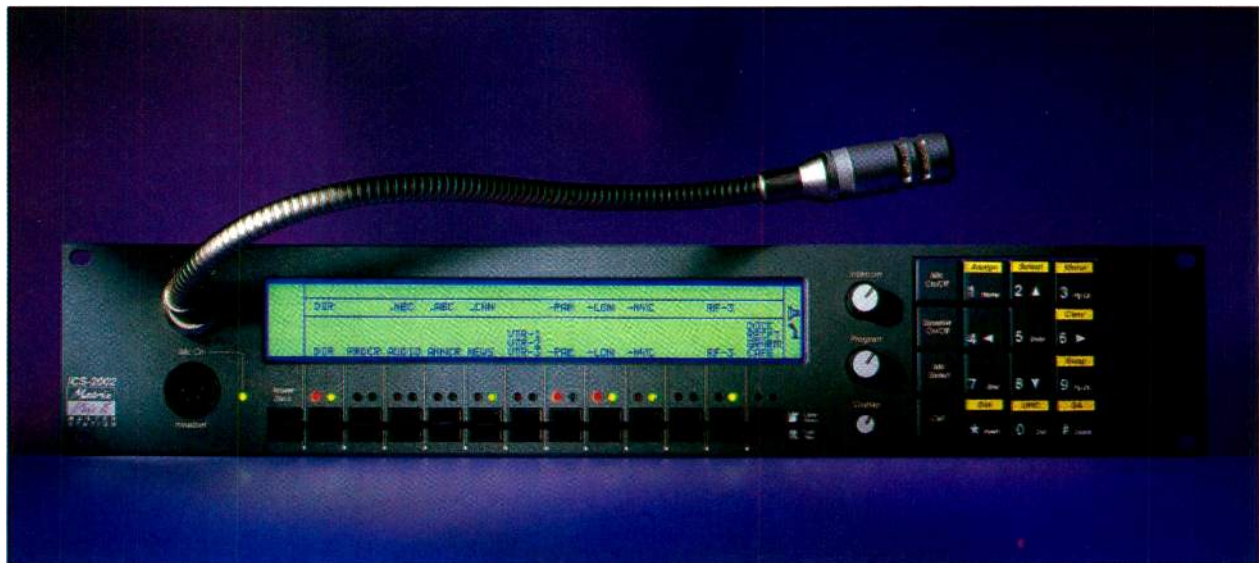

Overheard in all the best places.

It's the new **Matrix Plus® II intercom system**. The system that more and more broadcast professionals and system integrators are starting to talk about. Matrix Plus II builds on the remarkable strengths of the original Matrix Plus—the new industry standard for high-performance communications. Matrix Plus II is a truly integrated, **100 x 100 digitally-controlled intercom** with easy-to-use visual display stations, a comprehensive modular interface system, external DTMF system control, and simplified, pull-down menu programming. Exclusive features include **"Intelligent System Linking"** of multiple systems for expansion beyond 100 ports, and global remote control over crosspoint levels. There's also improved station communications for **long-line remote capability**, as well as optional, fully digitized single-pair wiring. Plus much more, including the highest level of service and support in the industry. Want all the details? Call us at **(510) 527-6666**. The Matrix Plus II. You'll be overhearing more about it.

Matrix Plus II

FROM CLEAR-COM INTERCOM SYSTEMS

Circle (51) on Reply Card

© 1993 Clear-Com Intercom Systems. Matrix Plus is a registered trademark of Clear-Com. 945 Camelia Street, Berkeley, CA 94710. Tel. 510-527-6666, Fax 510-527-6699



M552, M553: variable crossover networks.
M644: 4-channel noise gate.
M712: 2-channel gating compressor/limiter
MPA Power Amplifiers: models from 275-1100W per side
Model 4400A series: studio monitors.
Models 4206, 4208: 2-way, console-top studio monitors.
Soundcraft Mixing Consoles:
 Circle (710) on Reader Service Card

Jefferson Pilot Data/JDS
PC Sesami: Sales rep master planner downloaded to the station PC.
JDS2000 LINK: transfers data from the JDS 2000 traffic system to the station automation system.
BIAS LINK: transfers data from BIAS to station automation system.
 Circle (711) on Reader Service Card

JEM-FAB
DS-422, SD-422: digital serializer and deserializer.
Area Security System: includes monitoring for tower lights, equipment current, temperature, power line, HVAC, UPS; fire controls, central station connection with telephone dialers.
6X GPI Matrix: allows expansion of 4 GPIs into 24.
dPatch: self normalizing serial data patch panel.
 Circle (712) on Reader Service Card

Jensen Tools
Product line includes: Tools and tool kits.
 Circle (713) on Reader Service Card

J.L. Fisher
Leveling High Hat: 4-way leveling head with Mitchell mount.
Push Bar Kit: for Model 9 and 10 camera dollies.
70 foot diameter Curved Square Track: 24 pieces for full circle.
 Circle (714) on Reader Service Card

JNS Electronics
8000 series rack-frame modules: SDA.8705 Ver 2 mono/stereo audio DA; SDA.8225 stereo audio DA with five independently adjustable outputs; DFM-.8252 FM stereo detector/alarm, monitors left and right channels, stereo pilot. LA.8103 line amplifier.
8000 series rack-frame modules: MA.8711 Ver 3 stereo audio monitoring amp; VCA.8292 voltage controlled amplifier, remote control of four stereo audio sources.
8300 series: stereo to 100x1 audio router with panel, PC control.
9000 series: audio router; mono, stereo, 100x100+ matrix; panel and PC control.
D-MUX 500 series: 16-bit stereo or mono audio multiplexing system.
RFL-700 series: 1.5-2.3GHz digital microwave link for D-Mux; E-1, T-1 structure.
 Circle (715) on Reader Service Card

JVC
KY-27Y camera: 3-CCD LoLux camera; 2/3" IT sensors feature LoLux mode.
BR-S411UB S-VHS recorder: portable, dockable with time code, balanced XLR audio I/O.
BR-S525U S-VHS player: with still, slow-motion, Vari-Tracking from -2x, +3x play speed.
BR-S605UB S-VHS recorder: accepts computer video for multimedia; video insert edit mode; SA-K27U time code; extension slots.
BR-S622U recorder, edit feeder: similar to -S822U

without editing functions.
BR-S822U S-VHS editing recorder: uses compact, standard S-VHS cassettes; open architecture.
BR-S925U: time-lapse S-VHS recorder.
KY-17B, KY-17FIT: CCD camera upgrades; -17B uses IT MicroLens devices; -17FIT uses FIT devices.
KY-27U: low light 2/3" 3CCD high resolution camera.
BR-S422U S-VHS dockable recorder: forms lightweight camcorder.
RM-G870U edit controller: 9-pin RS-422, GPI interface; A/B-roll; 128-event EDL memory.
RM-P350U: triaxial camera control unit.
SA-N22W: digital noise reducer for high-end S-VHS applications.
TK-F7300U: single CCD camera captures still-frame HDTV, computer images; 2,200x1,728-pixel with AT/VISTA frame grabber.
GY-X2U S-VHS camcorder: full-size unit with 3 1/2" IT CCDs with microlenses; low light to 3 lux; 650-line resolution from camera, plug-in VITC/LTC generator.
TM-270SU: 27" flat screen color video monitor with optional stacking frame for use in video walls.
TM-550U: multi-standard 5.5" color monitor.
X2: first full-size S-VHS 3-chip camcorder.
 Circle (716) on Reader Service Card



K 5600
JOKER 200: 200W single ended HMI.
JOKER 400: 400W single ended MSR/SE or HMI.
 Circle (717) on Reader Service Card

K&H Products
AR-222: audio recorder cases.
AO-2 Audio Organizer: holds mixer, wireless mics, shotgun mic, fishpole, hand mic, filters, headphones, cables; connectors changes can be made without removing equipment from the bag.
CAR-2 cargo case: for general purpose production use.
FR-1 filter case: for 4" square, 4 1/2" round filters.
RS537/5 rain slickers: fit Sony DXC-537 with BVV5.
AR-D10: case for Sony TCD-d10 audio recorder.
 Circle (718) on Reader Service Card

Kaleidoscope Camera Control
Hot Head System: three choices of heads, with or without tilt slip rings; joystick, pan bar or geared head wheel control choices; DC/AC power.
 Circle (719) on Reader Service Card

Kangaroo Video Products
EMIKOTE products: protection for sensitive electronic equipment.
KVP series: video recorder packs, including newly introduced VCRs.
NAGRA KAP series: audio recorder carrying cases.
 Circle (720) on Reader Service Card

Karl Heitz
Fluid Heads: quick release; 90° front-rear tilts; 360° pan; drag adjust; #180 for loads to 7 lbs; Sport Eco tripod. #280 has 90° side tilt feature; for loads to 10 lbs; Reporter Eco tripod. #380 45° rear tilts; 360° pan; adjustable drag; all-metal quick release, shift plate for centering, balancing of cameras to 15 lbs; with Inter Pro Studex tripod and levelling ball 3.
Peri-Apollar 360° panoramic lens: C-mount lens.
Kinoptik lenses: 4 Macro-apochromats focus from infinity to 1:1 without accessories.
 Circle (721) on Reader Service Card

Kavouras
NEXRAD service access: to display Doppler weather radar products on all Kavouras broadcast weather systems.
RADAC 2100: color weather radar shows 6-color graphics; database; access to National Weather Service or FAA radar networks.
RADAC DBS: real time national composite, regional composite, single-site weather radar network.
TRITON i7: advanced graphics, weather workstation; 386/486 with multitasking i960/i860 RISC pipe-

line processing.
 Circle (722) on Reader Service Card

Kay Industries
Product line includes: power phase conversion products, Phasemaster APW for 3-phase power from 1-phase input.
 Circle (723) on Reader Service Card

KD Kanopy
Majestic: aluminum frame with fabric canopy, includes carrying case.
 Circle (724) on Reader Service Card

Keystone Communications
K2 Skylink: trans-Pacific service between KDD, Japan, and Keystone, Salt Lake.
North American Satellite Guide: published every other month.
 Circle (725) on Reader Service Card

Killer Tracks Music
Product line includes: Production music libraries.
 Circle (726) on Reader Service Card

Kings Electronics
KAP-85 Series: audio patching system, programmable with DIP switches on the rear panel.
Front load jackfields: 26-, 32-position using standard or miniature jacks; self-terminating and non-normal circuits.
Serial Digital video jack: two varieties, PN 7400-1, PN 7500-1 matched 75Ω self-normalizing, internal termination; dual video jacks.
 Circle (727) on Reader Service Card

Kintronic Laboratories
HF Balun: transformer.
HF feedthru: panel.
HF open-wire: feedline.
KTL-MFA-LWA-1.0-2: rapidly deployable low profile am/ml long wire antenna.
Mating network: AM/MW matching system permits rapid tuning.
Switch: HF open wire transmission line device.
 Circle (728) on Reader Service Card

Klark-Teknik
DN3600: dual-channel programmable graphic equalizer.
LBB100: direct injection box provides transformer isolation, attenuation and impedance matching of audio signals.
 Circle (729) on Reader Service Card

Kline Dielectric
Product line includes: Joint venture offering turn-key packages in design, fabrication, construction, installation of towers, inspection, maintenance services; HDTV feasibility studies.
 Circle (730) on Reader Service Card

Kline Towers
Product line includes: design, fabrication and erection of guyed, self-supporting, platform and multi-array towers.
 Circle (731) on Reader Service Card

Knox Video
Desktop Video Manager DVM: for PC platform; 4-layer, 4-input switcher with on-line editor, event controller, DSK, gen-locking sync generator and other features.
Mini D/A: 1x5 DA for NTSC or PAL; packaged in mini-box.
MiniGen: gen-locking sync, black burst generator; four or six black burst outputs; RS-170A.
PC 40: real time character generator on PC card.
PC-D/A: 1x5 DA on PC plug-in card; one card for NTSC or PAL composite; two cards allow NTSC or PAL Y/C components.
PC-Sync: gen-lock sync generator on PC plug-in card for PCs or Amigas; four (or six) black outputs; full RS-170A sync; jumper for Y/C inputs.
RS series routers: 3-channel, 8MHz bandwidth.
 Circle (732) on Reader Service Card

KORG USA
SoundLink: 8-track hard disk recorder, editor automates digital mixing, EQ, effects processing; 16-

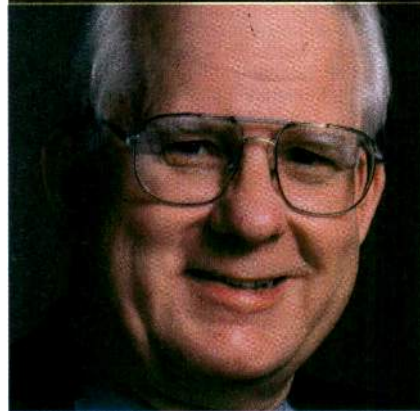

"Our Pictureboxes give us fast, elegant handling of video with key, distributed access, and complete graphics connectivity around the building. In short, Quantel's system concept is great. We're happy with where we are now and we're excited about the future. You have to trust that your suppliers will continue product development, and every Quantel system we own has real growth capability."

WFAA, Dallas, TX has Picturebox Twin (3), Picturebox Single (3), Paintbox, Harriet, Cypher(2) and Picturenent.

"COMPLETE CONNECTIVITY"

Hundreds of Picturebox systems are in service with broadcasters, large and small, across the US and around the world.

Stand-alone or in any size of network, Picturebox is the new industry standard for stills storage, library management and on-air presentation.

It's unbeatable at the basics, it integrates seamlessly, and with the added power to create everything from multilayer graphics to on air captions, Picturebox is much, much more than just a still store.

Call Quantel and put yourself in the picture.

PICTUREBOX

Much, much more than a still store



track MIDI recorder.

SoundLink production system: features 8-track random-access hard disk recorder, editor; automated digital mixer.

Circle (733) on Reader Service Card

Koto Luminous Corp.

DIS-60H: 6000W single ended lamp.

DIS-4: 400W single ended lamp.

DIS-7: 700W single ended lamp.

DIS-6D: 575W double ended lamp, with broader color temperature range than standard 575W.

Circle (734) on Reader Service Card

Kowa Optimed Inc

AF245 audio filing system: 3.5" M-O disk; SCSI interface for optional MO, hard disk (to four maximum); LAN interface for multiple controllers.

Circle (735) on Reader Service Card

L

L E Nelson Sales

1500PAR64: 1.5kW tungsten-halogen PAR64 lamp. **ACL series:** Thorn aircraft landing lamps for production effects.

CMC GEL: gel filter and spun diffusion materials. **CSR2500:** 2.5kW single ended daylight discharge source.

Circle (736) on Reader Service Card

Lakeside Associates

Design consultants: video, audio, post-production and motion picture studio projects.

Circle (737) on Reader Service Card

LDL Communications/Larcan

TTS series transmitters: VHF transmitters 250W to 16kW.

TTS-10U: 10kW solid state UHF transmitter.

Remote Diagnostic System: for Larcan transmitters; PC assists troubleshooting system problems through pictorial presentations.

Circle (738) on Reader Service Card

Leader Instruments

Model 425A: component/composite video test signal generator with digital genlock.

Model 2250: 4-channel 250MHz oscilloscope, with auto-setup, auto-calibration; storage for 100 front-panel settings.

Model 408NPS: video test signal, sync generator for NTSC, PAL and SECAM III; VHF, UHF output over 39-900MHz; composite, component outputs; stores 100 test setups, GPIB option.

Model 5872A: combination waveform, vector monitor; full line select; R-Y operation for DG/DP measurements; overlay of vector, waveform displays.

Model 952: TV/CATV/SAT signal level meter.

Circle (739) on Reader Service Card

Lectrosonics

DCI mic preprocessor: for automated audio consoles to prevent late mics and permit lower noise levels.

UHF wireless: compact ENG/EFP field configurations or studio diversity systems.

Circle (740) on Reader Service Card

Lee Filters

Product line includes: color effect, correction and diffusion lighting filter media.

Circle (741) on Reader Service Card

Leightronix

C-VOICE: telephone remote video equipment controller; interface for remote access to 64 VCRs and 64 switcher destinations.

LGX-DUB: PC-based duplication control software.

LGX-REQUEST VTR playback controller: for remote control by telephone of VCRs, A/V switching for program playback.

Mini-T-IR event controller, switcher: for multiple VCR control with A/V switching to automate playback, record, switching functions.

PRO-16: programmable videotape playback, record controller and switcher.

TCD-RT event controller: to automate VCR, routing switcher.

Circle (742) on Reader Service Card

Leitch Video

ARG-880, VRG-680: audio, video remote gain DAs. **BUG BOX:** based on the PROM-Slide, logo generator/insertor.

MIX-7000 series: digital interface series converters, parallel-to-serial, serial-to-parallel video.

SPG-1312N: NTSC/D-2 master sync generator; -1313N with gen-lock.

SPG-1680N: sync pulse generator card for 680 series video frames.

CDC-3500 interfaces: for modular coders, decoders; 3500AD analog component-to-parallel D-1; 3500DA D-1-to-analog component; 3500CE parallel D-1-to-composite analog video.

1302/2602 series: sync and test generators.

STILLFILE interfaces: for PC Paint, linear key capabilities.

DigiBus: integrated format conversion systems.

STILLFILE Special Edition: still storage system.

6800 series: serial digital distribution amplifiers; compatible with MIX-7000 series converters.

Circle (743) on Reader Service Card

LEMO USA

Product line includes: Audio, video connectors.

Circle (744) on Reader Service Card

Leonard Studio Equipment

HY HY: remote and crane arm base can reach heights of 32 feet in remote camera configuration.

LennyArm: camera crane arms; from 4.25 to 29.25

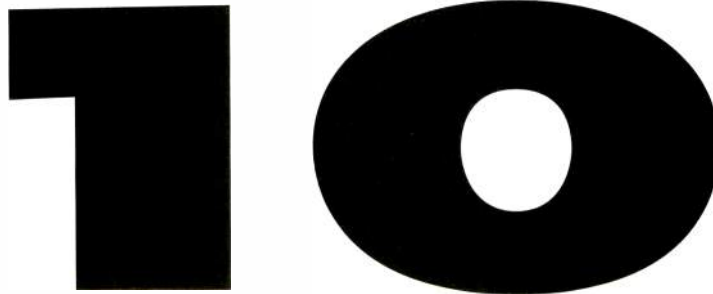

If you look at this and see "ten," not "two," we've got the digital audio system for you.

The **DAD 486x Digital Audio Delivery System** lets you reap all the benefits of a powerful, CD quality digital audio system without having to hire computer wizards to operate it. With your **DAD** on the job, you can throw away your cart and floppy disk machines, the carts, the disks and all the problems and expenses they've caused you. But since **DAD's** basic operation *emulates* standard cart machines, you won't have to waste time learning unusual operating methods or incur brain damage trying to figure out complex computer screens. **DAD's** easy, intuitive touchscreen operation lets you put it right to work boosting your audio quality,

improving your audio operations and paying dividends on your investment quickly and efficiently.

But, underneath **DAD's** easy to operate touchscreen is a powerful, hard disk-based production and playback system. **DAD** can even be configured as a networked system with multiple users and locations for even greater versatility and economy. With virtually unlimited stereo audio storage capacity, *graphic* waveform editing capability and versatile automation, interface and operating features, your **DAD** system is far more than just a replacement for cart machines. It really is a *complete* Digital Audio Delivery System!



The DAD 486x

To receive more information or to find out how to put our DAD to work for you, call us at 1-800-ENCO SYS.

ENCO SYSTEMS, INC. 1866 Craigshire Drive St. Louis, MO 63146
Phone: 1-800-362-6797 Fax: 314-453-0061

Circle (53) on Reply Card

The problem is obvious.



The solution is simple.

No more studio clutter! Reduce overall costs and simplify monitoring needs by letting one unit do all the work.

The VIEWPLEX-2000 is the ultimate video signal multiplexer. It will display up to 16 different channels on one screen with excellent clarity, making applications virtually unlimited.

VIEWPLEX-2000 is ideal for monitoring in a closed circuit set-up, broadcasting multiple images in a collage, or broadcasting sequential images for instructional formats.

If you're thinking of upgrading, don't get

more equipment; just get the one you really need.

Features include: • Video signal format NTSC. • High quality 8 bit picture resolution. • 16 maximum input channels. • 40 different display configurations. • Completely programmable. • Real time picture refreshing at 30 frames/sec. • 8 color character generator built in. For dealer inquiries and further

information, contact:

SUMITOMO ELECTRIC

U.S.A., Incorporated.

Telephone: (310)782-0227

Facsimile: (310)782-0211

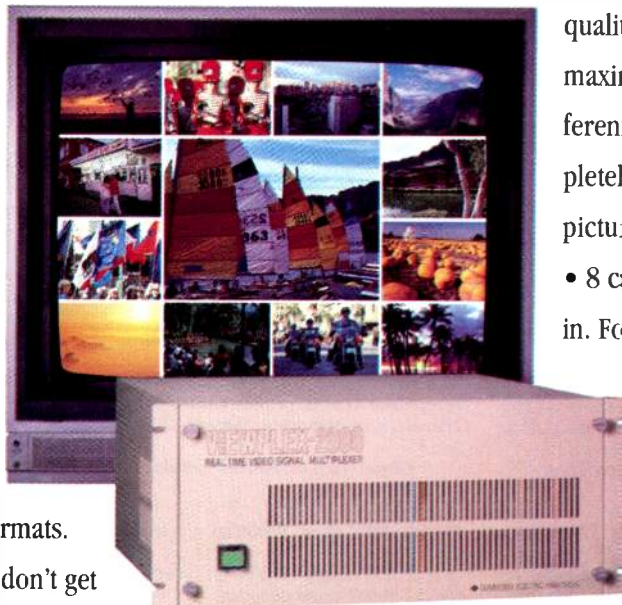

 **SUMITOMO ELECTRIC**

Circle (54) on Reply Card

feet maximum arm lengths; greatest height achieved 56 feet from horizontal.

Sidewinder: camera dolly with battery-powered steering, 900 lb. capacity.

Super Peewee II: small camera dolly with hydraulically operated arm; 23.5" pneumatic tires.

Western Dolly: camera dolly with 48" vertical travel, maximum capacity 785 lbs.

Circle (745) on Reader Service Card

Leonetti Company

Electronic ballasts: model EB 1200 120VAC; EB 2500 and EB 4000 240VAC units.

Fluorescent instrument: 4-tube or 8-tube fixtures producing high output flicker-free lighting.

Sunray 18,000: HMI Fresnel instrument.

Sunray 2500W: HMI PAR instrument.

Circle (746) on Reader Service Card

LES Corporation

System VTL-800: video cassette loader, pancakes to 16" diameter, 20 tape magazine.

System VTL-1600: dual supply video cassette loader.

Circle (747) on Reader Service Card

Lester Audio Laboratories

AES/EBU & SDIF-2 digital output cards: optional for passing digital signal at the output mainframe, rather than conversion back to analog form; various card configurations.

DAS 500: fiber-optic transmission system in 8- or 16-channel formats.

Circle (748) on Reader Service Card

Lex Computer

EditPack 2000: portable, random-access, full screen, full motion video acquisition and editing system, less than 35 lbs.

ReadyEdit 2000: picture processor for 486-PCs with Windows 3.1

Circle (749) on Reader Service Card

Lexicon

20/20 AD: 20-bit analog to digital converter 112dB dynamic range.

CP-1, CP-2, CP-3: digital audio surround sound processors.

LFI-10: digital audio format interface.

MIDI remote Ver 4.0: software for bidirectional communications with LXP-1,-5,-15 digital audio processors.

Nuverb: digital signal processing card, plugs in to Mac Nu Bus.

Opus Software V 3.0: external machine control; AutoMix console automation; CPEX time compression, expansion, pitch shifting, rate conversion.

Circle (750) on Reader Service Card

Lightmaker Company

Lightmaker Mega Brute: 9-light HMI systems.

Combo Ballasts: HMI lighting ballasts that work with all leading manufacturers' heads.

Circle (751) on Reader Service Card

Lighting Eliminators & Consultants

Grounding Augmentation Fill: material for low-resistance grounding in high-resistance soil.

Guy Charge Dissipation Choke: protects against static charges.

Circle (752) on Reader Service Card

Lighting Master Corp.

Product line includes: Bonding & grounding products and services, tower leg ground straps; design, surge suppression products.

Circle (753) on Reader Service Card

LINK

IEC-721, -722: black burst generators; -722 includes gen-lock, tone source.

PSW-826: video, audio switcher; configuration for 16x1 or dual 8x1.

Starflex 3690: transcoder for RGB to Beta and MII.

PRC-865: video AGC processing amplifier; auxiliary input.

Circle (754) on Reader Service Card

Listec Video

A-5500/A-5501 SCROLLBOX: Chinese scrolling prompt display with Chinese word processor and Scrollbox; StudioPlus Editor, smooth speed control; foot controller for variable speed.

A-5505 Scroll-Buddy: full-function 12VDC/110-220VAC mini-Scrollbox; runs on Palmtop computer supporting DOS; dual-screen editing with instant corrections, full-featured Runorder.

A-6000: enhanced A-6000 PC prompter program.

BDL Autoscript: complete range of high-contrast and brightness monitors for prompting.

Circle (755) on Reader Service Card

LNR Communications

DAVSAT: digital satellite communications systems, MVC-10 mobile voice communication; DAD-10 digital audio distribution; DVC-10 digital video compression.

LVD series: low profile digital video exciters for uplinks.

LVM series: low-profile data quality video exciters; combine compact video modulator with low-phase noise digital-ready upconverter.

Circle (756) on Reader Service Card

Logitek

Bright-VU LED: audio level meter with larger display range.

4VUB: four 3 1/2" analog VU meters in 2RU rack-mount package.

Mariner enhancement: incorporates digitally controlled analog faders; low distortion of direct audio faders with reliability and tracking of VCA units.

Super-VU: 40 bar type tricolor LED meters for audio applications.

ADA-4x4 DA: 1RU rack-mount unit configures as four 1x4, two 1x8 or one 1x16 distribution amplifier.

Circle (757) on Reader Service Card

Loral Microwave-Narda

8250: compliance meter for measuring RF radiation.

8842C Personal Monitor: wearable protection against overexposure to non-ionizing radiation.

Circle (758) on Reader Service Card

Louth Automation

Autoscreen: PC based off-line tape preparation system.

ADC-10: automation for low end and cable markets.

ADC-100: advanced automation system; multi-list, multichannel operation.

LCP-20: compact control panel for ADC-100 and NEWSTRAK systems.

NEWSTRAK: PC-based device server for news-room automation.

Circle (759) on Reader Service Card

Lowel-Light

DP & DP&T Kits: lighter due to new case and stand design.

Rifa-Lite: self-contained halogen lamp centered within a silver-reflector housing, folds up like an umbrella.

Circle (760) on Reader Service Card

LPB

FM stereo radiating cable system: unlicensed applications, such as hearing assistance, localized broadcasting.

LPB 7000 series: stereo audio consoles.

Message Manager.

PC-based audio: storage and retrieval system.

Telephone Access: remote controller.

Travelers Information System: 1610kHz operation.

Circle (761) on Reader Service Card

LSI Logic

CW702 JPEG Core: JPEG image compression engine.

L64702 JPEG single chip co-processor.

L64111 MPEG audio decoder.

L64112 Digital TV MPEG decoder.

L64711/12/13/14 Reed Solomon encoders/decoders.

JPEG Video-Rate BitBuster 700 evaluation board.

JPEG chip set.

Circle (762) on Reader Service Card

LTM Corp of America

20K: incandescent lighting unit.

Cinepar 200WS/E: single-ended PAR HMI lighting unit.

Cinepar 575 S/E: single-ended PAR HMI fixture.

Torch: hand-held 200W S/E HMI lighting unit.

Circle (763) on Reader Service Card

Lucasey Manufacturing

EasyView: TV wall mount.

LINK X: modular security system uses interlocking components.

Sightline: TV wall mount.

Circle (764) on Reader Service Card

Lynn Greenberg Electronic Prompting

Telescroll International: extended software with foreign language character sets for Spanish, French, Japanese.

Circle (765) on Reader Service Card

Lyon Lamb Video Animation

I-VAS: animation controller for SG Iris Indigo workstation.

VASTools4Mac: assists in recording Macintosh-generated graphics to videotape or disc, requires Mac System 7.

Circle (766) on Reader Service Card



M/A-COM

BNC connector/adaptor: Combines 2 parallel cables into one BNC male port; useful for computer networking; integral strain relief.

Circle (767) on Reader Service Card

Macrovision

VES-TD: video transmission scrambler for business, teleconference, educational programming; conceals audio and video.

VTC-100: video tilt corrector; an operator-controlled video line-tilt correction unit to compensate for scrambling artifacts and improve pulse response of video equipment and signal paths.

Circle (768) on Reader Service Card

Magic Teleprompting Inc.

MagicScroll 2.0: teleprompting software for Macintosh computers.

Circle (769) on Reader Service Card

Magni Systems

MM-400: low-cost waveform and vector monitor; converts waveform and vector display to a standard video signal for easy display or routing; supports any analog format, including S-video, and automatically detects NTSC or PAL standards.

VGA Producer PRO: VGA-to-NTSC or PAL encoder now includes an RGB version, allowing any VGA graphics program to be converted to color difference or RGB component video; fits in 8-bit PC expansion slot for direct connection to VGA card connector; vertical text scroll, pan, zoom features.

500 Series: cost-reduced component/composite waveform monitors and vectorscopes.

Signal Creator: video signal generator, including serial 525/625 D1/D2 output and new RAM card.

Circle (770) on Reader Service Card

Magnum Tower

Product line includes: Radio, TV and communications towers.

Circle (771) on Reader Service Card

Mainframe Computer Graphics

Inscriber Fontmaker: converts any Windows TrueType or ATM font into an Inscribe font, fully aliased and ready for video; supports full ANSI and PC keyboard mapping, instant on-line resizing and font effects plus keyboard remapping.

New Inscribe frame buffer support: in addition to established support for Truevision and Matrox frame buffers, Inscribe now supports frame buffer for Interlace VMAXX Series 10; includes 32-bit

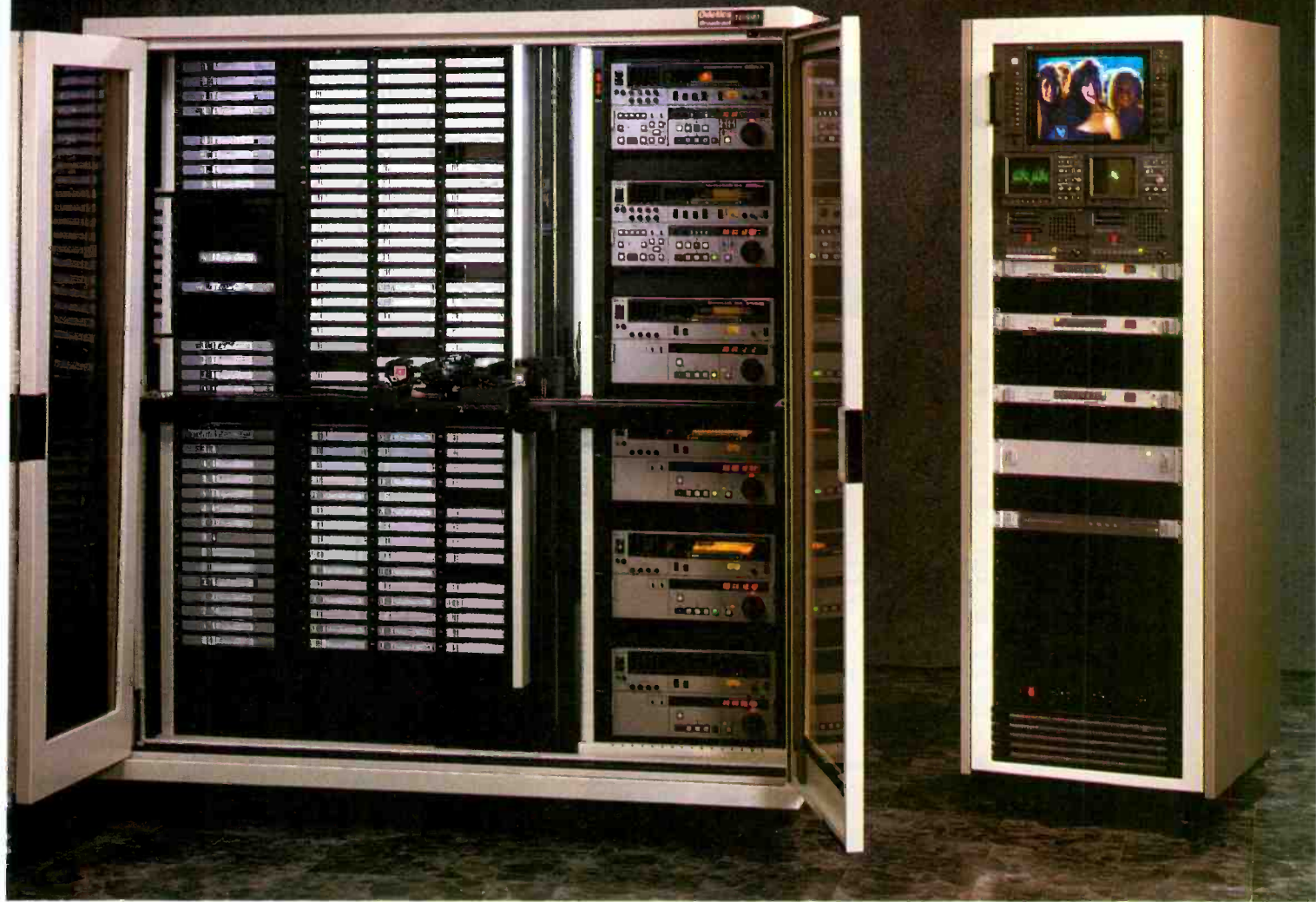

The Odetics TCS90 - The Only Cart Machine Designed with Your Future in Mind

With the TCS90, Odetics Broadcast gives new meaning to the word versatility. Featuring a unique ability to handle multiple cassette sizes and virtually all available broadcast formats, the TCS90 provides incomparable flexibility plus an open window to the future.

Field Changes Made Simple

Don't waste time second-guessing future tape deck format changes. The TCS90's simple straight-forward design makes field upgrades easy and affordable. You can take advantage of technology upgrades as they become available.

Mix cassette sizes to match your needs

Odetics put its award-winning electromechanical expertise to work and developed a system that makes handling dual-sized cassettes simple and foolproof. With a capacity of 150 carts, there is enough on-line access for a full day of programming plus twelve to twenty-four hours of spots and

promos, depending upon your format. And, with Odetics Multicut Software, the TCS90 can store several hundred spots on-line.

The Decision is Yours

Full compatibility with any news or station automation system lets you make choices that make sense for your station's needs. Built-in redundant hardware and software features make choosing Odetics a decision you can be sure of.

Buy for the Long-Term

Because Odetics products are fully compatible with each other, system obsolescence is never a concern. The TCS90 includes the same advanced features as the Odetics TCS2000 large library Cart Machine and all TCS2000 software and hardware options and accessories. It's no wonder Odetics Broadcast is the world-leader in large library automation systems.

**Odetics
Broadcast**



® NATAS

1515 South Manchester Avenue, Anaheim, California 92802-2907 (800) 243-2001 or (714) 774-2200

Director of Sales
Bill Keegan
(714) 774-2200

Northeast
Ray Baldock
(201) 305-0549

Southeast
Emerson Ray
(813) 960-0853

West
Chuck Martin
(818) 999-9796

North Central
Bill Boyd
(612) 894-2121

South Central
David Scally
(404) 917-9506

Circle (55) on Reply Card



pixel-depth, linear key channel, component video output; multistandard resolution.

Circle (772) on Reader Service Card

Major Engineering

Videocassette storage: Patented, adaptable, high-density storage systems for D-2, Beta, M-II, VHS videotape cassettes.

Circle (773) on Reader Service Card

Management Graphics

Solitaire Cine Image Recorder: Produces photographic quality film images from digital information in a variety of user-configurable formats.

Circle (774) on Reader Service Card

Manhattan Production Music

Audiophile Sound Effects: library of 495 popular effects for radio, TV, film use.

Circle (775) on Reader Service Card

Marco Inc.

Product line includes: modular rack systems.

Circle (776) on Reader Service Card

Marconi Communications Systems

B6600 series: FM radio transmitters uses solid-state redundant design using 300W modules; hot pluggable; dual drive with output to 10kW in one cabinet.

B7600 series: solid-state UHF TV transmitters from 1kW to 20kW, featuring compact size, simple installation and uniform RF power module design.

B7650 series: IOT UHF TV transmitters from 10kW to 40kW, using common design across entire range; supports multiple international audio and video formats.

Circle (777) on Reader Service Card

Mark IV Pro Audio Group

See: DDA; Electro-Voice; Klark-Teknik; MIDAS; Vega.

Marti Electronics

STL-15C, R-15C: Composite FM aural STL transmitter and receiver, available from 140MHz to 960MHz. Capable of digital audio/data transmission with external modems.

Circle (778) on Reader Service Card

Master Performance One

Master Performance I: Production music and sound effects collection featuring over 1,100 selections on 8 CDs.

Circle (779) on Reader Service Card

Matco Mfg. & Test

MA-204A: automated playback system; 22x3 stereo AFV router; loss-of-video protection; random, sequential list scans; parallel, serial, IR VTR control; 24 control outputs for VTRs, other devices; battery backed clock, calendar, list memory.

MA-206: Similar to MA-204A, but includes internal routing switcher, front panel control and video display board removed and replaced by an attached PC.

MA-130: DTMF decoding interface; allows local commercial insertion into satellite transmissions automatically through MA-201 or MA-204A; supports five 4-digit DTMF decoders; standard unit includes one decoder board in IRU unit; additional plug-in decoders available.

MA-120: Microprocessor-based serial communications adapter providing serial-to-parallel machine

interface for RS-422 control of various 3/4" and 1/2" VCRs.

Circle (780) on Reader Service Card

Matrox Electronic Systems Ltd.

Illuminator-PRO: video graphics board; 32-bit frame buffer; broadcast quality encoder; full-resolution NTSC/PAL at 32-bits, multimode alpha channel output; integral TBC, digital video effects; various third-party software paint animation packages may be used.

Toccata-PRO: serial 4:2:2:4 (D-1) I/O board option for Illuminator-PRO.

Matrox Marvel: multimedia controller; enhances live video windows to 1,024x768 resolution in applications from video conferencing to frame capture in desktop publishing.

Matrox Studio: complete desktop editing; for EISA PC; A/B/C roll editing, 5-layer video and graphics mix effects; integral TBCs, 32-bit graphics paint, titling software; three DVEs, two keyer channels; 12-track audio mixing; digital audio editing software.

Matrox Studio enhancement: non-linear editing module; 3-D DVE add-on board with A/B roll system; fast cuts editor, D-1 and analog Y/R-Y/B-Y component support.

Personal Producer for Illuminator: low-cost video editing under Windows 3.1; combines video segments, digital audio, graphics, titles, video effects and transitions through intuitive storyboard interface; program automatically stored to videotape from storyboard layout.

Circle (781) on Reader Service Card

Matthews Studio Equipment

Product line includes: Camera support products, pedestals, stands, pan/tilt mounts, cranes, spacer bags, lighting, effects and power distribution.

Circle (782) on Reader Service Card

Maxell Corporation of America

D-3 videocassettes: small, medium and large size 1/2" cassettes offering high particle density, thin reinforced base film and high output.

Betacam BQ videocassettes: new formulation offering improved picture quality, higher output and increased durability.

Circle (783) on Reader Service Card

MCL/Inc.

M/N 10906: high-power Ku-band TWT; 300W output, 14.0-14.5GHz; sealed for outdoor use; antenna mount and flyaway usage; forced air cooling under thermostatic control.

M/N 10961: C-band TWT; 600W or 700W, 5.85-6.425GHz; LED displays, RF drive limiting and TWT protection.

M/N 10974: C-band HPA linearizer; improves intermod performance, reduces HPA backoff requirement; includes RF equalizer.

M/N 10999: High power Ku-band TWT; 300W output, 14-14.5GHz; single drawer rackmount design with LCD multifunction monitor meter; autoranging with RF power display; LED fault indicators and complete TWT protection.

Circle (784) on Reader Service Card

M.C. Lights and Manufacturing

L3000 series Soft Lights: Provide diffuse, virtually shadow-free light over a smooth field; a variety of sizes and configurations are available.

Circle (785) on Reader Service Card

McCurdy Radio Industries

Product line includes: Audio mixers, test sets, meter panels, jackfields, monitor/cue amplifiers; 25Hz tone equipment, universal interface units, traffic interfacing, automation; routing switchers; video DAs, clamping amps; digital audio storage systems; loss of video, silence sensors; under-monitor displays; custom systems, components, equipment.

Circle (786) on Reader Service Card

Media Computing

pcTV²: PC software, hardware; simultaneous display of full-motion video with stereo audio from two non-synchronous sources.

T.E.N. The Electronic Newsroom: PC-based, LAN-compatible broadcast newsroom automation.

codi companion: PC-based sequencing/automa-

tion/effects software for Chyron codi character generator.

Circle (787) on Reader Service Card

Media Concepts

Product line includes: used broadcast TV production equipment.

Circle (788) on Reader Service Card

Media Touch Systems

OmniPLAY: touchscreen radio automation system integrating traffic/billing, music scheduling, satellite services and machine control.

OpLOG: Control software for automated radio broadcasting; supports Novell LAN to link traffic/billing, music and newsroom computers.

MTS Digital: Multi-user mass storage digital audio system; handles up to 8 mono or 4 stereo signals simultaneously.

Circle (789) on Reader Service Card

Meret Optical

HR VIEW 6000: allows remote location of a graphic workstation monitor, keyboard and mouse up to 1km from its CPU.

LiveLink 100/200: fiber-optic links for mobile ENG/EPF systems; for uni- or bidirectional configurations; for 4 video channels, 3 audio pairs, 3 digital channels with intercom.

LiveLink 450: HDTV FO transmission to 10km; 60dB with 3 video, 4 audio, 3 digital channels with intercom.

OmniSpeed LL500: serial digital fiber-optic link; transmits 5-400Mbit/s to 10km without repeaters; handles video, audio formats and compressed signals, such as HDTV; meets SMPTE 259M and CCIR 656

Circle (790) on Reader Service Card

Merlin Engineering Works

Product line includes: Video processing equipment, ME-278-S synchronizer; ME-981/991 data encoder, decoder.

Circle (791) on Reader Service Card

Micro Communications

HDTV feasibility study service: evaluate current NTSC transmission site for HDTV conversion; tower inspection, load analysis and final stress analysis; pattern analysis and design of antenna; relocation of HDTV antenna on tower; final design for HDTV site.

HDTV filters: constant-Z absorptive filters for HDTV transmissions; rejects all out-of-band components for pure transmission of digital signal; to be used for ATV over-the-air test site in Charlotte, NC.

HDTV multi-channel antennas: an "all UHF band" antenna for sites wishing to use a common antenna.

LPTV bandpass filters: interdigital type for out-of-band protection; low insertion loss; 7/8, 1 1/8, 3/8 EIA sizes.

Emergency antenna: universal antenna for emergency use in all markets, on any UHF channel and on all tower types; modular design allows easy transport and installation.

Circle (792) on Reader Service Card

Micron Tool/CamMate Systems

Product line includes: camera support systems, Black Magic boom extensions with remote head, pan/tilt control.

Circle (793) on Reader Service Card

Micro Technology Unlimited

MicroEditor 2.1: software package; includes DAT archiving; up to 50 stereo track mix projects at 8-48kHz sample rates.

MicroSync: optional synchronization board.

MicroSound workstations: digital audio workstations in rack, tower configurations.

Circle (794) on Reader Service Card

Micron Audio Products

TX-521/TX-631: wireless microphone transmitters with switchable frequency control.

SR-522/SR-623: multichannel, switchable-frequency wireless microphone receivers.

MDR-552/MDR-653: multichannel, switchable-frequency wireless microphone diversity receivers.

Circle (795) on Reader Service Card

DIAMOND DIGITAL

Create production magic with BTS' new component digital production switchers.

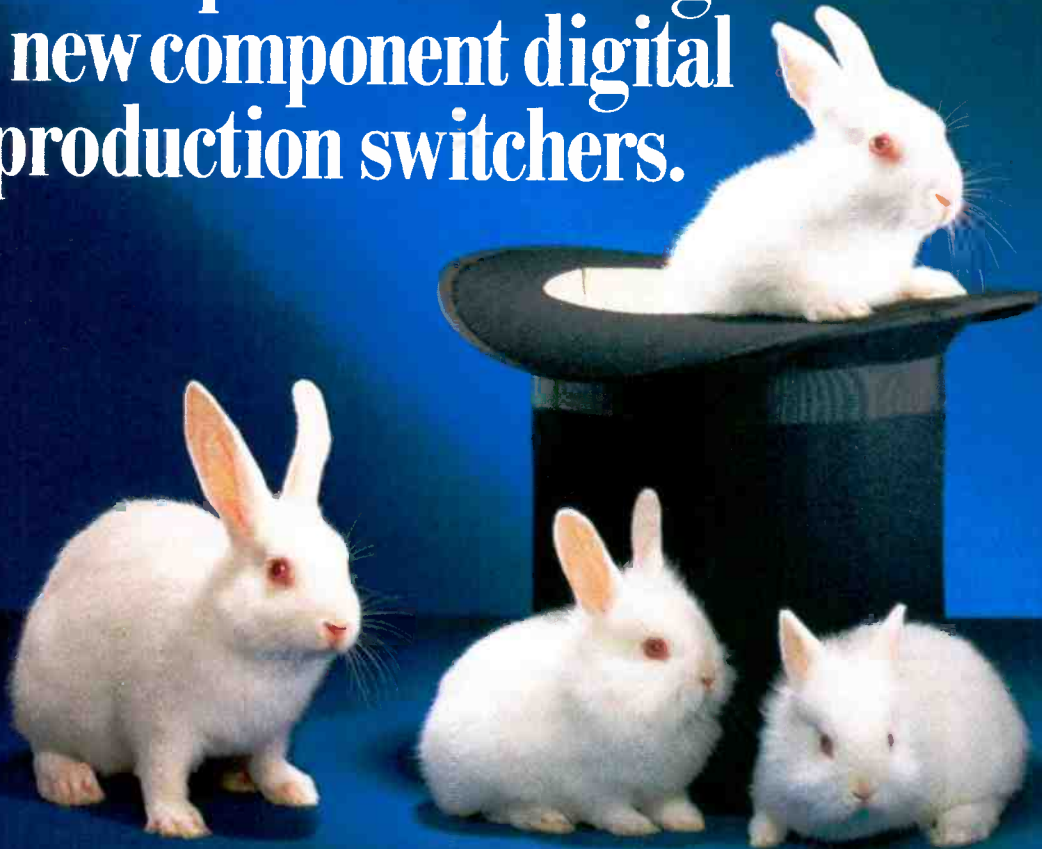

Your business could multiply.

No matter what type of operation you happen to be - small, mid-size, high-end post-production, live production - or whatever kind of magic you want to perform, BTS has a Component Serial Diamond-digital switcher to perfectly match your studio or O.B. facilities.

There are four exciting versions to choose from, each one combining unbelievable creative digital video compositing talents with quick and easy control.

They offer the very latest features including BTS's DynaChrome keying power, Automatic Key Alignment, MultiMix and FXLoop to help you accomplish the most

sophisticated editing tasks simply and cost-effectively.

They incorporate control over external DVEs, routers and editors for network flexibility. And what's more, they're ideal for use with both 4:3 *and* 16:9 formats.

To find out more about the amazing power of BTS Diamond-digital switchers, just write or call. In no time at all, a full color brochure will magically appear on your desk.

BTS

A PHILIPS AND BOSCH COMPANY

BTS Broadcast Television Systems, Inc.
94 West Cochran Street
Simi Valley, CA 93065, U.S.A.

Call toll-free:
(800) 962 - 4BTS
Outside the U.S. and Canada:
(801) 977 - 1551



Creative Television Technology from BTS

Micro Net

Product line includes: Video transmission services; terrestrial linking New York, Philadelphia, Washington DC, Dallas, Austin, Houston, San Antonio; earth stations in Dallas and New York for domestic and international services.

Circle (796) on Reader Service Card

Microtime

Impact 1XP: Low cost, entry-level version of Impact variable image transformer, offering real-time, render-free, true 3-D shape manipulation and live video mapping on shapes.

Impact option cards: Field-installable by user in any Impact series product; offering Defocus, Gouraud Shading and Motion Blur.

Impact version 1.33 software: Provides operational and feature enhancements plus new shapes. **FS-10 Synchronizer:** 10-bit frame synchronizer with A/B inputs, D-2 output and line-by-line video advance.

Composium II: Real-time digital compositor, delivering live-action capability at low cost; includes paint features, clip processing, rotoscoping, video typography and central digital storage library.

Composium version 4.5 software: New features include primary and secondary color correction, macros for recording sequence movements, improved edge tinting, descale output, reverse play, true source stop, lock pan with FX locate, disable autocue and several user-interface improvements.

Circle (797) on Reader Service Card

Microvideo Ltd.

Digital proc amp: adjust black level, Y/U/V gain, Y-C delay, picture position in digital domain.

Digital test pattern generator: 10-bit 270Mb/s serial, RP-125 parallel signals; includes new patterns to check serial digital systems.

Dual 10-bit D/A converter: enhanced mechanical design allows two plug-in modules in 1RU frame.

D1 serial digital to NTSC/PAL: modules for monitoring with six units in 1RU cases; 270Mb/s.

Digital video data inserter: provides transparent insertion of Teletext, data, ITS signals into digital video feed.

Circle (798) on Reader Service Card

Microwave Networks

IDS1: microwave radio product for 15, 18, 23GHz; for point-to-point, data applications in commercial microwave disaster avoidance, cellular and private network emergency restoration; local distribution radio, VSAT networks.

Circle (799) on Reader Service Card

Microwave Radio

DigiPro: Digital audio subcarrier encoder and decoder for CD quality over video microwave links. **MicroLink III:** 18/23GHz broadcast quality, short-haul video microwave system.

MR-40DR: 36-40GHz digital microwave radio system for voice/data transmissions up to 5mi.

Circle (800) on Reader Service Card

Microwave Solutions Inc.

Power Amplifiers Catalog Supplement: outlines Microwave Solutions' general product line of power amplifiers with output power levels of 1W, 3W, 5W, 10W and 15W, and at broadband range of frequencies from 4-14GHz.

Circle (801) on Reader Service Card

MIDAS

MIDAS XL3-16: audio mixing console.

Circle (802) on Reader Service Card

Middle Atlantic Products

MC-1: Automated message center using large fluorescent display panels, controlled by IBM or compatible PC.

Slim 50/Slim 20: Rugged, precision-built equipment racks.

Circle (803) on Reader Service Card

Miles

M36 Digital Striper: Provides digital video and

audio reference signals plus 48kHz word clock, all locked to station black.

M57 Serial Digital Safe Area Generator: Provides a range of video display boxes and cursors locked to the serial digital input.

Circle (804) on Reader Service Card

Milestek

Product line includes: BNC connectors, cabling for analog and digital video; cable cutting, stripping, crimping tools; computer networking adapters, cabling, connectors; also distributors for Trompeter, North Hills, ADC Telecommunications.

Circle (805) on Reader Service Card

Miller Fluid Heads (USA)

Miller 25 fluid head: camera mount/tripod intended for ENG use with self-contained camcorders; sealed clutch-controlled adjustable drag, counterbalance and sliding; quick release camera platform.

Carbon fibre tripods: single- and 2-stage units with extreme rigidity, high twist-resistance and lightweight.

System 15: lightweight, fast handling support system for professional event videography; recommended for ENG configured camera systems weighing up to 15 lbs.

Circle (806) on Reader Service Card

Minolta

CC-110: CRT convergence meter; provides numerical measurement of CRT phosphor convergence; measures R, G and B signals simultaneously to minimize drift of individual measurements.

CA-110: LCD color analyzer for accurate white balance and inspection of color LCD displays.

Circle (807) on Reader Service Card

Mira Imaging

HyperSpace: hardware/software system for rapid computer modeling of complex 3-D objects.

Circle (808) on Reader Service Card

Miralite Communications

Product line includes: sales and installation of satellite and wireless terrestrial communications products for audio, video, voice and data.

Circle (809) on Reader Service Card

Miranda Technologies

SDM-300: serial, parallel 4FSC to NTSC/PAL D/A converter.

SEL-1604: 16x4 serial digital selector for 4:2:2, 4FSC.

TITANIA: 3-D digital effects system for Matrox Studio.

SDM-100A: 4:2:2 to RGB/YUV D/A converter.

ASD-100: component analog video to serial 4:2:2 A/D converter.

SER-200: 4FSC serial-to-parallel and parallel-to-serial digital coders.

Circle (810) on Reader Service Card

Mitsubishi Professional Equipment Div.

AM-4201R: 40" autoscanning video monitor; NTSC/PAL/SECAM/HDTV and multicompartment-compatible.

XC-3725C: 37" autoscanning color monitor with up to 1280x1024 resolution.

DX-2000U: High-resolution analog video still-image recorder using DAT cassettes; accepts composite, S-video or RGB; optional archiving software.

CP-210U: Color video printer producing up to 4 high-resolution images per sheet; accepts wide variety of input signals.

Circle (811) on Reader Service Card

Modulation Sciences

RDS-1: PC-based software and subcarrier generator for RBDS FM data system. (See Pick Hits.)

PROceiver enhancement: antenna diversity system with 12/28VDC power adaptor for MTS PRO channel receiver.

Circle (812) on Reader Service Card

Mohawk/CDT Broadcast Cables

Product line includes: design and development of copper and fiber-optic cable products for audio,

video; multipair, shielded, audio snakes; high-definition mic cables; coax, triax, Ultra flex video cables; composite camera cables; fiber-optic video link; cables conform to SMPTE standards, current NEC code.

Circle (813) on Reader Service Card

Mole-Richardson

Type 4251 Big MoLE: 20kW Molequartz Solarspot; 24" Fresnel lens.

Type 6351: 18kW HMI Fresnel Mole Solar-Arc Solarspot.

Type 6381/6391: Small single-ended globe lights with a variety of lenses; 2.5/4.0kW.

Circle (814) on Reader Service Card

Montage Group

M75/M75D/M100: random-access, full screen, full motion non-linear editors; user interface emulates film-style editing.

M21P: Portable, random-access, full screen, full motion video acquisition and editing system; allows direct camera-to-disk recording on location and on-line EDLs.

MP3: Personal Picture Processor software for desktop PC with IBM/Intel ActionMedia II board.

Circle (815) on Reader Service Card

Moseley Associates

CDQ 2000 option: selectable, high spectral efficiency mode for digital audio-for-video STL.

DSP 6000 high spectral efficiency option: allows DSP 6000 digital aural STL to carry 4 15kHz channels and 2 data channels.

Master-Touch: touchscreen interface for MRC 2 and MRC 160 remote controllers.

MRC 1620 LP: flash reprogramming option; low power option, allowing solar operation; intelligent RS-232 interfaces for MRC 1620 system.

PCL 6000 multichannel: up to 16 channels on a single STL.

Circle (816) on Reader Service Card

MTR AG Electronics

Product line includes: automated signal routers for analog and digital composite and composite video, mono and stereo audio, HDTV and data; distribution amplifiers.

Circle (817) on Reader Service Card

Motorola/North American Group

Product line includes: C-QUAM AM stereo.

Circle (818) on Reader Service Card

MSE Video Tape Services

1" DUB PAK: environmentally conscious alternative to plastic tape shippers.

Recycled D-3 tape: Previously used D-3 cassettes in various lengths.

Circle (819) on Reader Service Card

Multidyne Electronics

SSR-90: solid-state recorder; 1.5 minute capacity for audio source ID; playback alternates between the messages and one of three tones or an external audio source.

TS-4: SMPTE color bar generator with black burst; gen-lock, video ID and spoken ID features.

TS12-RM: Rack-mount test set; generates 12 signals, including VITS, 5MHz line sweep, black burst, stereo audio tone; inserts 16-character VI message ID in external video; lip-sync audio, video synchronizing signal; loop-through for external video, stereo audio; automatic by-pass of external signals.

TS20-RM: rack-mount NTSC test signal generator similar to TS12-RM; exceeds short-haul RS-250C specifications.

Circle (820) on Reader Service Card

Murry Rosenblum Sound Assoc.

Audio Ltd TX 2000HP: high-power (800mW) version of TX 2000 wireless microphone transmitter pack.

Audio Ltd MX 2000: VHF or UHF wireless microphone system in RMS 2000 line, with transmitter and receiver both contained in similar small, lightweight cases; 2-frequency switchable.

Audio Ltd Dx 2000: compact diversity receiver for RMS 2000 wireless microphone system.

Circle (821) on Reader Service Card

France: VELIZY-
VILLACOUBLAY
Tel.: (33-1) 30 70 35 00
Fax: (33-1) 30 70 35 35

Asia: SINGAPORE
Tel.: (65) 227 83 20
Fax: (65) 227 80 96

ELECTRON TUBES FOR TV AND RADIO BROADCAST.



*Extending
your broadcast performance.* We make broadcast performance go

further with a complete selection of tubes and circuit assemblies for TV, FM and radio. OEMs and broadcasters choose Thomson time and again for reliability, power and ongoing optimization of tube lifetime.



Our TH 563, featuring 30 kW UHF in common amplification, opens new horizons in tetrode performance, and joins our full range of VHF and UHF tubes for TV.

Our FM tubes, from 10 to 100 kW, are economical, easy to use and available in industry standard designs.

For the latest radio transmitters, our outstanding new 500 kW TH 576  offers a higher level of efficiency, resulting in lower operating costs.

Whichever tube you need, Thomson delivers the service, quality and innovation that's ready to take your performance to new heights.

Brasil: SÃO-PAULO
Tel.: (55-11) 542 47 22
Fax: (55-11) 240 33 03

Deutschland: MÜNCHEN
Tel.: (49-89) 78 79-0
Fax: (49-89) 78 79-145

España: MADRID
Tel.: (34-1) 564 02 72
Fax: (34-1) 564 19 40

India: NEW DEHLI
Tel.: (91-11) 644 7883
Fax: (91-11) 645 3357

Italia: ROMA
Tel.: (39-6) 63902 48
Fax: (39-6) 63902 07

Japan: TOKYO
Tel.: (81-3) 3264 63 46
Fax: (81-3) 3264 66 96

Sverige: TYRESO
Tel.: (46-8) 742 02 10
Fax: (46-8) 742 80 20

United Kingdom:
BASINGSTOKE
Tel.: (44-256) 84 33 23
Fax: (44-256) 84 29 71

U.S.A.: TOTOWA, NJ
Tel.: (1-201) 812-9000
Fax: (1-201) 812-9050

For other countries,
call France.

 **THOMSON TUBES ELECTRONIQUES**

Circle (57) on Reply Card



VISION PRO-PED / CLASSIC PETREL MK II



CLASSIC OSPREY II / VISION 30



CLASSIC TEAL / CLASSIC MARK 5



CLASSIC HAWK / CLASSIC MARK 7B

Every camera may deserve to be placed on a pedestal. But not the same one.

What if you need the stability and smooth moves of a studio pedestal but the camera requires only a lightweight pan and tilt head? Or, what if your camera configuration demands a heavy-duty pan and tilt but no on air pedestal moves? You need more than one solution.

Fortunately, Vinten's family of lightweight VISION and heavy-duty CLASSIC heads and pneumatic pedestals gives you 54 different solutions (not counting accessories) to create the exact support system to meet your precise needs. And your budget. For proof, four of Vinten's most practical and proven packages are shown here.

VISION PRO-PED two-stage portable pedestal and CLASSIC PETREL MK II pantograph head.

For camera payloads to 100 pounds, this combination delivers broadcast quality on a tight budget. While not designed for on-air floor moves, the pedestal's pneumatic column equals the performance of the OSPREY II. And the PETREL MK II pantograph head combines Vinten's counterbalance system and infinitely variable fluid pan and tilt drag.

CLASSIC OSPREY II two-stage steering, portable pedestal and VISION 30 pan and tilt head.

Together, they're perfectly suited for any load up to 80 pounds. The pneumatic OSPREY rivals Vinten's full size FULMAR for smooth, steering ring controlled dolly and height movements. Yet, it's portable. And with the VISION 30, you get infinitely variable fluid drag pan and tilt ($\pm 180^\circ$) plus Vinten's patented camera counterbalance system.

CLASSIC TEAL single-stage pedestal and CLASSIC MARK 5 cam head.

Supporting camera configurations up to 160 pounds, the TEAL moves on dual gimbed wheels with 8" rubber tires and offers full crab, steering and elevation control from the ring. The head, with continuously variable friction pan and tilt, works with any camera from ENG up to studio equipped with prompter, large lens and viewfinder.

CLASSIC HAWK 3-stage studio pedestal and the new MARK 7B Fluid cam head.

With a payload up to 175 pounds and uncompromising broadcast quality performance, the HAWK is second only to Vinten's FULMAR pedestal and the head is the newest version of the MARK 7, *the world's studio standard*. While the HAWK easily performs flawless on-air dolly moves and elevation changes, the new MARK 7B provides continuously adjustable fluid drag tilt and pan controls, a pan disc brake, a $\pm 60^\circ$ tilt range and a host of new features including a visible camera lock indicator.

If you have a camera that deserves a pedestal, it's a good thing Vinten believes in strong family values and freedom of choice. That's why instead of only one way to support a camera, Vinten offers you 54. After all, Vinten has been supporting broadcast television cameras since 1934. No one has done it better or longer. For more information, call your nearest Vinten location.

Vinten

VINTEN BROADCAST INC., 44 Indian Lane East,
Towaco, NJ 07082 (201) 263-4000 FAX (201) 263-8018
South — Sunrise, Florida 33071 (305) 572-4344
West — Sun Valley, California 91352-4022 (818) 767-0306
Circle (58) on Reply Card

Musikos

Product line includes: production music libraries.
Circle (822) on Reader Service Card

MYAT

Stub Harmonic Filter: controls even harmonics, intermod products and lightning or precipitation discharge.

Flexible Section line: 50Ω or 75Ω, 6¹/₈ EIA flexible line; allows ±30° deflection without VSWR change.
Antenna Power Divider: 8-way UHF divider; 75Ω, 6" input.

Fine Matchers: tune VSWR from 1.5 using four probes at 1/8 wave spacing; 50Ω or 75Ω, 1⁵/₈" to 9" diameters available.

Circle (823) on Reader Service Card



N Systems

Product line includes: complete line of microwave antennas, remote controls for ENG, point-to-point applications; Superquad, Silhouette ENG antennas.

MCSA: digital remote control for ENG receive antennas and receivers; 80386-based with VGA touchscreen monitor and multisite control capability; position memory and several automated functions.

Stiletto ST6/ST8: low windload microwave antennas with asymmetrical reflector and offset feed; 6ft/8ft parabolic units with windloading equivalent to 2-feet smaller dishes; exceeds FCC standards for STL/ICR use.

Silhouette/Superquad: Central ENG receive antenna systems.

Circle (824) on Reader Service Card

Nady Systems

2000 VHF: wireless system with hiss mute circuitry; diversity receiver; 120dB dynamic range; accepts various mic capsules.

351 VR: camcorder VHF wireless mic system; receiver connects to external mic jack on the camera; handheld or lavalier mics.

301 UHF: 4-channel, frequency-synthesized wireless mic/instrument system; handheld, lavalier, instrument mic transmitters.

950 UHF: 10-channel frequency-synthesized wireless mic/instrument system; diversity, companding processor; lapel, instrument or hand-held mics.

950 GS UHF: 40-channel receiver for 950 UHF system.

551 VR: 2-channel wireless video mic uses VHF frequencies; 120dB dynamic range; HT-10 handheld mic; LT-30 lavalier bodypack transmitter with mini XLR connector for electret condenser lavalier mics.
RW-3 UHF: 4-channel, frequency synthesized, true diversity wireless mic receiver; 120dB dynamic range; rackmount design.

Circle (825) on Reader Service Card

Nagra/Phi-Tech

Product line includes: Nagra analog and digital audio recording products.

Circle (826) on Reader Service Card

Nalpak Video Sales

Series 2400 Retro-Kit: Equipment hand-truck enhancement adds cushioned ride currently on nose-end only to complete truck.

Circle (827) on Reader Service Card

National Supervisory Network

Product line includes: transmission plant monitoring service; VISION system for transmission and management of audio, automation and control/monitoring data for remote stations from group HQ; ComStream digital audio products.

Circle (828) on Reader Service Card

National Transcommunications

NTL System 2000: MPEG-based video compression system enabling four broadcast quality signals to be carried within spectrum normally occupied by one analog signal.

Circle (829) on Reader Service Card

Nautel

AMPFET ND5: 5kW all solid-state AM transmitter with integral C-QUAM AM stereo; modular design and duplicate exciter for added reliability and on-line servicing; highly efficient design.

Circle (830) on Reader Service Card

NCC

Product line includes: Dacomobile rolling equipment carts.

Circle (831) on Reader Service Card

NDG Phoenix

OMS for Windows: Operations Management Software for IBM PCs and compatibles operating under Microsoft Windows 3.1.

Circle (832) on Reader Service Card

NEC America/Broadcast (J Alan White)

Product line includes: video display units, DM2710 Data Smart, CM2791 Multimedia monitors.

Circle (833) on Reader Service Card

Nemal Electronics International

Product line includes: precision audio and video cable, #1570 and #2201A; MC424P flexible mic cable.

Circle (834) on Reader Service Card

Neotek

ES-100: audio production console.

Esprit: audio production, on-air, record console.

Circle (835) on Reader Service Card

Nesbit Systems Inc.

FTS File Tracking System: cross-reference, cataloging system manages records retention.

Text retrieval module: word indexing for Media Library and Equipment Tracking System; for PC on a LAN.

Circle (836) on Reader Service Card

Network Music

Primrose Music: CD music library from Italy.

Circle (837) on Reader Service Card

Neumann USA

TLM 193: large diaphragm condenser cardioid microphone for critical recording, broadcast and live sound applications.

Circle (838) on Reader Service Card

Neutrik USA

A2: 2-channel audio generator, analyzer, oscilloscope; for all common audio measurements; numeric or graphic sweep displays; hardcopy through printer with DOS-based PC.

Combo: Combined 1/4" and XLR receptacle; mono or stereo, with or without normalizing contacts.

NanoCon: 3+1 pole subminiature audio connector; 5mm (0.2") diameter; locking connection; all metal housing with chuck type strain relief.

Circle (839) on Reader Service Card

New E.V.S.

Product line includes: video slow motion, processing and delay equipment, RAM recorders; LSM Live Slow Motion system; Video Paint 7.0.

Circle (840) on Reader Service Card

NewsMaker Systems

Release 4.0: complete newsroom automation for MS-DOS/Novell NetWare environment; operates as stand-alone or in network.

Circle (841) on Reader Service Card

NewTek

Video Toaster 4000: New hardware and software for video effects system operating on Commodore Amiga 4000 platform; added capabilities, faster rendering, easier usage and lower cost than previous versions.

Circle (842) on Reader Service Card

Nigel B Furniture

Spaceplanner, Estimator and Imagebank: Windows-based software packages for designing, outfitting and pricing studio floor plans.

Circle (843) on Reader Service Card

Nikon Electronic Imaging

FW-ENG, F-ENG: cost-effective means to expanded special effects; permit Nikkor SLR lenses to be used with ENG cameras.

S15x8.5B II Nikkor: enhanced version of previous S15x cameras; 0.8m MOD; removable servo housing for serviceability; wide zoom ratio.

S19x8B TV Nikkor: ENG lens reaching from 8mm to 152mm focal lengths; f/1.7 maximum aperture.

S9x5.5B TV Nikkor: ultra-wide angle lens; internal focusing system accepts matte boxes, filters; high MFT curve.

Circle (844) on Reader Service Card

Norpak

Product line includes: VBI/teletext data transmission products, TTX6X0 receivers with integrated VCR.

Circle (845) on Reader Service Card

Norsat International Inc.

2000 series: Digital Ku-band low-noise block downconverters (LNBs); high stability and low noise for critical data applications.

7300 series: Ku-band LNB for reliable, compact performance in less critical applications.

9000 series: Ku-band LNB exhibiting high stability.

Circle (846) on Reader Service Card

Northern Technologies

Product line includes: power protection systems.

Circle (847) on Reader Service Card

Nova Systems

NovaBlox additions: low-cost frame synchronizer and sync generator cards.

TBC/synchronizer products: NOVA 950 processor/transcoder TBC; NovaMate single, dual and multi-channel TBC; NOVASync frame synchronizers. (See Pick Hits.)

Circle (848) on Reader Service Card

NPR Satellite Services

Product line includes: Satellite transmission services for radio broadcasting.

Circle (849) on Reader Service Card

NRG Research

Product line includes: Light and power products for professional videographers.

Circle (850) on Reader Service Card

NSE Radio Network

Product line includes: Adult contemporary radio network service.

Circle (851) on Reader Service Card

NUCOWM

FMT/FMRA series: 70MHz modulator/demodulator; supports four FM subcarriers plus video.

FT/FR4 series: STL/ICR heterodyne transmitter/receiver; 70MHz interface; covers 1.3-15GHz.

FT/FR5 series: Direct modulation STL/ICR system; 4 audio channels plus video; covers 1.3-15GHz.
AT/AR4 series: Agile IF heterodyne transmitter/receiver with 70MHz interface.

HTG4: Hand-held multi-function video/audio test generator.

CR4 series: ENG central receiver; single and multi-band with block converter option; covers 1.3-13.25GHz.

Circle (852) on Reader Service Card

Nutel Electronics Corp/Telemet

Circle (853) on Reader Service Card

NVISION

NV5000 series: universal sync generators providing common timing reference for simultaneous lock of NTSC/PAL video, AES/EBU and SDIF-2 digital audio; all outputs simultaneously available. (See Pick Hits.)

NV3064 series: Digital routing switchers for AES/EBU audio or ANSI/SMPTE time code signals; 32x32 or 64x64 configurations.

NV3128: RS-422 data routing switcher; allows control of up to 128 devices.

NV1000 Delay Compensation Modules: Delays AES/EBU audio and timecode up to 20 video fields.

Circle (854) on Reader Service Card

In broadcasting, Image and Power are everything.

BURLE is committed to providing a full range of camera and power broadcast tubes.

As television celebrates its Golden Anniversary, BURLE continues a 50 year tradition of broadcast technology leadership. We've supplied you with Vistacon, Saticon and Vidicon camera tubes since their introduction. And our power tubes are the industry standard for VHF TV.



BURLE supplies a wide variety of camera and power tubes for the broadcast industry.

It takes a domestic source like BURLE to maintain a half century commitment to producing and supplying a full line of broadcast electron tubes. From camera to transmitter, BURLE provides the tubes that keep the broadcasting industry on the air. Count on us to keep you supplied with the full range of broadcast camera and power tubes you need. Today and tomorrow. Contact your local BURLE broadcast tube distributor, or call us at **1-800-827-8823.**

Experience counts.

BURLE Electron
Tubes

Nytone Electronics

VSS-1B: Slide scanner system producing broadcast quality color video from 35mm slides; composite or RGB output.

Circle (855) on Reader Service Card

O

O'Connor Engineering Labs

35L: Quick release lightweight tripod.

1030 upgrade: Increased drag, sleeker profile fluid camera head.

Circle (856) on Reader Service Card

Odetics Broadcast

OmniCart: Multichannel automation system; compiles, records and plays to up to 8 outputs simultaneously; controls external devices. (See Pick Hits.)
XR800/SCS800: Allow optical disc recorders to be integrated and controlled by existing Odetics cart machine systems.

Circle (857) on Reader Service Card

O.L.E Limited

Product line includes: Lightworks editing control systems.

Circle (858) on Reader Service Card

OMB/TransAmerica Int'l Broadcasting

Product line includes: FM transmitters and exciters, STLs, antennas and coax line.

Circle (859) on Reader Service Card

Omicron Video

Model 558-41/N: NTSC, D2 digital video 4x1 routing switcher; bit-parallel and bit-serial with four levels of digital audio; RS-232, -422 control.

Omni-Gen 703/704: NTSC and PAL gen-lock systems for composite video for AMIGA PC; RGB or Y/R-Y/B-Y video output with 200ns delay line; Y/C S-

Video output; optional safe area generator; key pulse output switchable for component or composite production systems.

Circle (860) on Reader Service Card

Omnimusic

Product line includes: Production assistance products, Music and Omni-FX sound effects libraries.

Circle (861) on Reader Service Card

OpAmp Labs

OSC-12: Low distortion audio oscillator; output range from mic level to >+10dBm; powered by 12VAC wall-transformer (supplied).

INST-12: Instrumentation amplifier with BNC I/O; gain 1 to 1000; freq. resp. DC-30kHz; CMRR=120dB; low-noise, low-drift.

M9C: Mic/line utility box for matching impedance, level and/or connectors (XLR, RCA or 1/4"); internal 9V battery).

Circle (862) on Reader Service Card

Optical Disc Corporation

Product line includes: LaserDisc recording systems and Recordable Laser Videodiscs (RLVs) compatible with standard LaserVision or LaserDisc format consumer players; Model 610A/620A recording system accepts composite video for cost effective single-copy or low-volume duplication; Series 500 Mastering Modules handle LaserDisc or CD mastering.

Circle (863) on Reader Service Card

Optimage Interactive Services

Motion Media: Macintosh-based tool for generating MPEG-encoded full-motion video sequences; uses off-the-shelf video capture card and VTR.

Audio to MPEG: Macintosh-based tool for creating MPEG-encoded audio sequences; includes audio capture hardware.

Circle (864) on Reader Service Card

Optimum Productions

Product line includes: Versioning and dubbing of

videos and films with translations to/from English and other languages; meets broadcast and feature film specifications.

Circle (865) on Reader Service Card

Options International

Product line includes: Accessories and upgrade kits for Rank-Cintel and Bosch telecines.

Circle (866) on Reader Service Card

Orban/AKG Acoustics

8200 version 1.0 software: New control options include user-configurable daypart processing, "purist" processing features, multiband processing improvements, SCA and overshoot compensations and EBS tone generator.

8200D/32: AES/EBU digital interface card for 8200 Optimod v 1.0.

8200 ST: 8200 accessory for pre-processing audio at studio when 8200 is located at transmitter.

Circle (867) on Reader Service Card

Orel

Model 10038A: interfacility fiber-optic link for satellite earth stations; allows direct monitoring of uplink RF signal in control room.

Models 10035A/10037A: fiber-optic links for C-band up/downlinks; allow multiple transponders to be carried over a single fiber at actual satellite band frequency between control room and antenna; supports distances of 15km between uplink and HPAs or downlink and LNAs.

Circle (868) on Reader Service Card

Osram Sylvania

20,000 Watt Studio Lamp: Tungsten Halogen lamp with no ballasts, flicker, color shifts or warm-up time; outputs over 1/2 million lumens at 3200K color temperature; 350-hour life.

Circle (869) on Reader Service Card

Otari

Concept 1: Digitally controlled audio console for music and production; symmetrical dual-path architecture; 24-track buses and 10 auxiliary buses; individual 4-band EQ, 100mm fader; full snapshot recall plus dynamic automation of faders and mutes with DISKMIX dual-path VCA automation for up to 96 simultaneous channels.

DISKMIX 2+: hardware and software revision of DISKMIX 2 console automation system; improved data resolution, video display, varispeed performance and data interface; supports 80286/80386 PC processors; runs DISKMIX 3 v4.0 moving fader VCA automation with graphics, pull-down menus.

MADI interface option for DTR-900 II: Multi-channel audio digital interface for PD format 32-track digital recorder.

PD-464 v4.2 software: New features for Macintosh-based multitrack digital audio recording/editing system include on-screen GUIDE waveform display for visual editing, external machine control, DSP stereo mixdown with real-time track solo/mute, offline upload/download, CMX AutoConform support option, sound file interchange via removable magnetic disk and new Sound Library management features.

CB-158: Hardware edit controller for PD-464; provides scrub wheel, illuminated keys for edit and machine controls, and backlit LCD screen for all editing functions.

BackUp Station: Macintosh-based upload/download station for PD-464; holds up to 5 removable magnetic disk drives (480Mbyte or 1Gbyte) plus Exabyte 8mm tape drive; supports future MO drives.

Circle (870) on Reader Service Card

P

Pacific Radio Electronics

Product line includes: Audio hardware and distribution equipment; racks, panels; digital audio and video cables, connectors.

Circle (871) on Reader Service Card

Pacific Recorders & Engineering

Product line includes: Audio mixing consoles, cart machines, digital audio workstations.

Circle (872) on Reader Service Card

Summer Sale!



- New DCA (digitally controlled analog) technology
- The great sound of direct audio
- The accuracy & reliability of VCAs
- True modular frames hold up to 6, 12 or 22 mixers
- Three types of input mixers available
- Mix-Minus, Machine control, Talkback & much more
- Prices start at \$3900



Call:
800-231-5870 or 713-782-4592
for your nearest Logitek dealer

Circle (60) on Reply Card

Fujinon's new 66X field production lens. It turns a long shot into a chip shot...in one shot.



The odds of converting a long shot into a chip shot have never been better, thanks to Fujinon's high-performance Ah66 X 9.5ESM field zoom lens. From a wide angle of 9.5 mm to an extreme close-up of 1250 mm (2X), the Ah66 X 9.5ESM has the highest magnification and best F-stop ramping of any field lens you can buy.

So whether you're shooting sports or concerts, any time the situation calls for a long shot, increase your odds with Fujinon's Ah66 X 9.5ESM. For more information about Fujinon's superb new Ah66 X 9.5ESM, call Fujinon at 1-800-553-6611 or consult your local Fujinon representative.



Broadcast & Communications Products Division

FUJINON INC. 10 High Point Dr., Wayne, NJ 07470-7434 (201) 633-5600
Southern 2001 Midway, Ste. 114, Carrollton, TX 75006-4916 (214) 385-8902
Midwest 3 N. 125 Springvale, West Chicago, IL 60185-1560 (708) 231-7888
Western 129 E. Savarona Way, Carson, CA 90746-1406 (310) 532-2861
Latin American 15181 Southwest 113th St., Miami, FL 33196-2567 (305) 388-7399
FUJI PHOTO OPTICAL CO., LTD. 1-324 Uetake, Omiya City, Saitama 330 Japan;
Phone: 048-668-2152, FAX: 048-651-8517, TELEX: J22885

FOCUSED ON THE FUTURE



Paco Electronics USA

Product line includes: NiCad battery chargers, quick chargers, analyzers, dememorizers.

Circle (873) on Reader Service Card

PAG Ltd.

PAGbelt IC2: battery belt with integral switched-mode charger; 12-14.4V 4-10Ah, 24V or 30V 4-7Ah; dual output XLR4 connectors; ODP over discharge protection; 100-250VAC input.

PAG AR series: auto-ranging fast chargers; for 4.8-14.4V, 12-30VDC NiCad batteries; AR121, AR201 single channel; AR124, AR304 sequential 4-channel units.

Circle (874) on Reader Service Card

Paltex

EDDiSX: self-contained A/B-roll desktop video editor; 486-class CPU, 40MBbyte hard drive, 3.5" floppies; industry standard keyboard, trackball; interfaces for RS-422 VTRs, video switcher; serial control for NewTek Video Toaster; 999-line EDL, list management, EDL ripple, Auto-assembly, Animation mode.

Circle (875) on Reader Service Card

Panasonic

AG-3S-VHS-C Camcorder: three 1/3" CCDs; 270,000 pixels for 530-line resolution; 1 lux low-light sensitivity; 10x optical zoom with 20x digital zoom; electrical image stabilization; color viewfinder, digital TBC, digital noise reduction; wide screen recording feature.

AJ-D340: D-3, 1/2" digital composite studio VTR; smaller, more compact version of the AJ-D350 D-3 studio VTR.

AJ-D350RK/AG-DM350/AG-6842H: Double-speed video duplicating system; uses D-3 masters and produces VHS dubs.

AJ-DX10: D-5 format component digital 1/2" studio VTR; 300Mbit/s digital VTR capable of 10-bit 4:2:2 recording (CCIR 601) with four digital audio channels; no bit-rate reduction employed; switchable 13.5/18MHz video sampling; suitable for 4:3 or 16:9 aspect ratios; optional D-3 playback.

AK-HC900: 3-CCD portable HDTV camera.

AQ-CA3: Composite serial digital video adaptor for AQ-11DF and AQ-20D portable cameras; feeds D-2 or D-3 field recorders with digital composite input.

AT-H1905D: Fully digital professional 19" video monitor; 0.28mm dot pitch; microprocessor-controlled on-screen setup; NTSC digital composite, 4:2:2 component, parallel and serial video interfaces offered.

AU-HD1500: 1/2" studio HDTV recorder.

AU-Z7000: 1/2" portable HDTV recorder.

M.A.R.C Type III updates: New software provides conflict resolution and enhanced compiling/recording intelligence.

TM-2020HD: 20" portable HDTV monitor.

TM-3200HD: 32" HDTV monitor.

TW-HSA 100: HDTV systems adaptor; switches and converts (as necessary) a variety of video sources and formats to HDTV display.

WJ-MX30: A-V switching system; 2-channel digital field synchronization allows special effects in each of the A/B program buses; switches 3 sources plus matte generator; remote control via GPI or RS-232C; over 100 wipes plus PIP, strobe, still, mosaic/scramble, negative/positive and posterization offered; memory for 8 setups.

3-CCD DSP camera: Multi-purpose compact box type camera; wide range of control via DSP; built-

in CG; RGB, Y/C, component and composite outputs; 750-line resolution; >62dB S/N; f8 @ 2000lux.

Circle (876) on Reader Service Card

Panther

Product line includes: Camera support equipment, Super Panther, Mini Panther camera dollies, THOMA remote camera head.

Circle (877) on Reader Service Card

Parallax Graphics Systems

MATADOR v4.0: Enhancement to integrated 2-D animation, paint, special effects system; improved text features, expanded color palettes and manipulation tools, added saturation/brightness adjustments, automates operations of painting, keyframe animation, rotoscoping, chromakeying; smart brush effects, warping; high-speed operation with SGI processor.

Newsroom Graphics System: Family of software for Silicon Graphics workstations for fast, high quality, stylized image preparation; includes maps and generic templates for sports, financial data, quotations, statistics, etc.

Circle (878) on Reader Service Card

Patch Bay Designation

Product line includes: Labels and designation strips for patchbays.

Circle (879) on Reader Service Card

Peerless Sales

Product line includes: Monitor/TV wall and ceiling mounts, the Jumbo and Designer series.

Circle (880) on Reader Service Card

Penny & Giles

Analog faders: 100mm stroke length with stainless steel-loaded polycarbonate casing and conductive plastic tracks; interchangeable unit can be used as retrofit for other products on the market.

Digital T-Bar: for video effects generators, switchers, mixers; uses incremental optical encoder to generate two channels of data; resulting square-wave signal can be decoded to deliver 1,024 pulses over 90° of travel.

3-axis joystick: Small, smooth and responsive controller with no dead band or break-out step; suitable for remote motion control applications.

Circle (881) on Reader Service Card

Penta Laboratories

PL4-400CG: 500W power tetrode; rated for long life and consistent operation in audio/radio-frequency PA or modulator applications.

4CV100,000C: Vapor-cooled ceramic-metal power tetrode with 100kW capability.

PL8349/ACX35,000C: Forced-air cooled, ceramic and metal power tetrode rated at 35kW; designed for long life and consistent operation in a wide variety of applications.

5CX1500C: Ceramic-metal power pentode rated at 1.5kW; low intermodulation distortion.

Circle (882) on Reader Service Card

PEP

Product line includes: Videotape editing products, Shotlist software; DigiSpot digital recorder, cart machine replacement.

Circle (883) on Reader Service Card

Perrott 'The Battery People'

System 90 battery charger: charger/discharger unit with elective discharge and battery fault indication; optional battery conditioning and analysis with digital display; available 1-gang to 6-gang units.

Circle (884) on Reader Service Card

PESA Chyron Group

See: Aurora Systems, Chyron, CMX Editing Systems, Micro Communications, Inc. and PESA Switching Systems.

PESA Switching Systems

RM2416V: Wideband video routing matrix; 24x16 in 1 RU; expandable to 48x64; 100MHz bandwidth.

RM2416A: Wideband audio routing matrix; 24x16 stereo or 24x32 mono in 2 RU; expandable to 48x64 stereo.

SD-5000: Serial digital video routing switcher; handles D-1, D-2, D-3 (NTSC or PAL) and compressed 16:9 HDTV; 64x64 in 10 RU; fiber or coax I/O; passes NRZI signals up to 400Mbit/s with full fiber I/O; companion audio matrix handles up to 20Mbit/s.

Circle (885) on Reader Service Card

Phasetek Inc

P600-196-X: Antenna control system for AM/MF radio stations; switches between main and auxiliary transmitters; up to 4 antenna system modes; accommodates any number of towers.

Circle (886) on Reader Service Card

Philip Drake Electronics

5000 series management products: for analog and digital audio; automatic stereo corrector, stereo monitors, A/D and D/A converters.

DCS 3000 intercom: fully digital matrices to 128x128 in 9RU with redundancy; single coax connection for outstations; Intelligent Ethernet Networking combines as many as eight matrices.

6000 series intercoms: 16x16 to 128x128 matrices; Intelligent Networking permits eight 128x128 systems to be combined.

MicroCompact intercom: systems with matrices to 32x32.

Circle (887) on Reader Service Card

Philips Components

YK2000: 40kW inductive output tube (IOT); 470-810MHz operation; water-cooled, FOM up to 120%; class AB operation for high linearity.

Circle (888) on Reader Service Card

Philips Consumer Electronics

CD-I 350: Professional Compact Disc-Interactive (CD-I) player with 6" active matrix color LCD screen; displays NTSC or PAL; includes built-in pointing device, stereo speakers and multiple I/O; upgradable to full-motion, full-screen video; AC/DC powering.

CDD 521: Desktop CD recorder; Orange Book II system, supporting CD-ROM, CD-ROM XA, CD Multisession, CD-I and CD-Audio; double-speed record and playback capability; SCSI interface included; publishing software available for control by Macintosh or PC/Windows platforms.

CDD462BK/CDD462RS: photo CD players with fast access times, MPC and photo CD capabilities; tray loading system eliminates need for CD caddies; CDD462RS comes with selected software and stereo speakers.

CM405ABK/CM425ABK: Internal/external double-speed SCSI CD-ROM drives; SCSI-2 compliant; self-cleaning lens mechanism; headphone outputs included; multi-session and photo-CD capable.

CDF200: Portable photo CD player; designed for presentations on standard video monitors or projectors; AC/DC powering; plays CD audio; full remote control; image rotate, pan and televue functions.

22ER9141: Full motion, full-screen video extension unit for CD-I players; plug-in mounting; follows MPEG audio and video standards; supports slow motion and still video playback.

Circle (889) on Reader Service Card

Philips Lighting

Product line includes: Lamps for stage, studio.

Circle (890) on Reader Service Card

Philips TV Test Equipment A/S

PM 5644HD: HDTV test pattern generator.

PM 5695M: NTSC TV transmitter monitor; back-lit LCD screen displays multi-channel data; keyboard-operated; mono or BTSC versions.

PM 5639/10: Hand-held projection color balance meter for aligning video projectors.

PM 5639/20: PC-based industrial CRT color analyzer package.

PM 5640AM: NTSC video test signal generator; includes Ghost Cancellation Reference (GCR) signals. (See Pick Hits.)

Circle (891) on Reader Service Card

Photomart Cine-Video

Product line includes: Video equipment and accessories.

Circle (892) on Reader Service Card

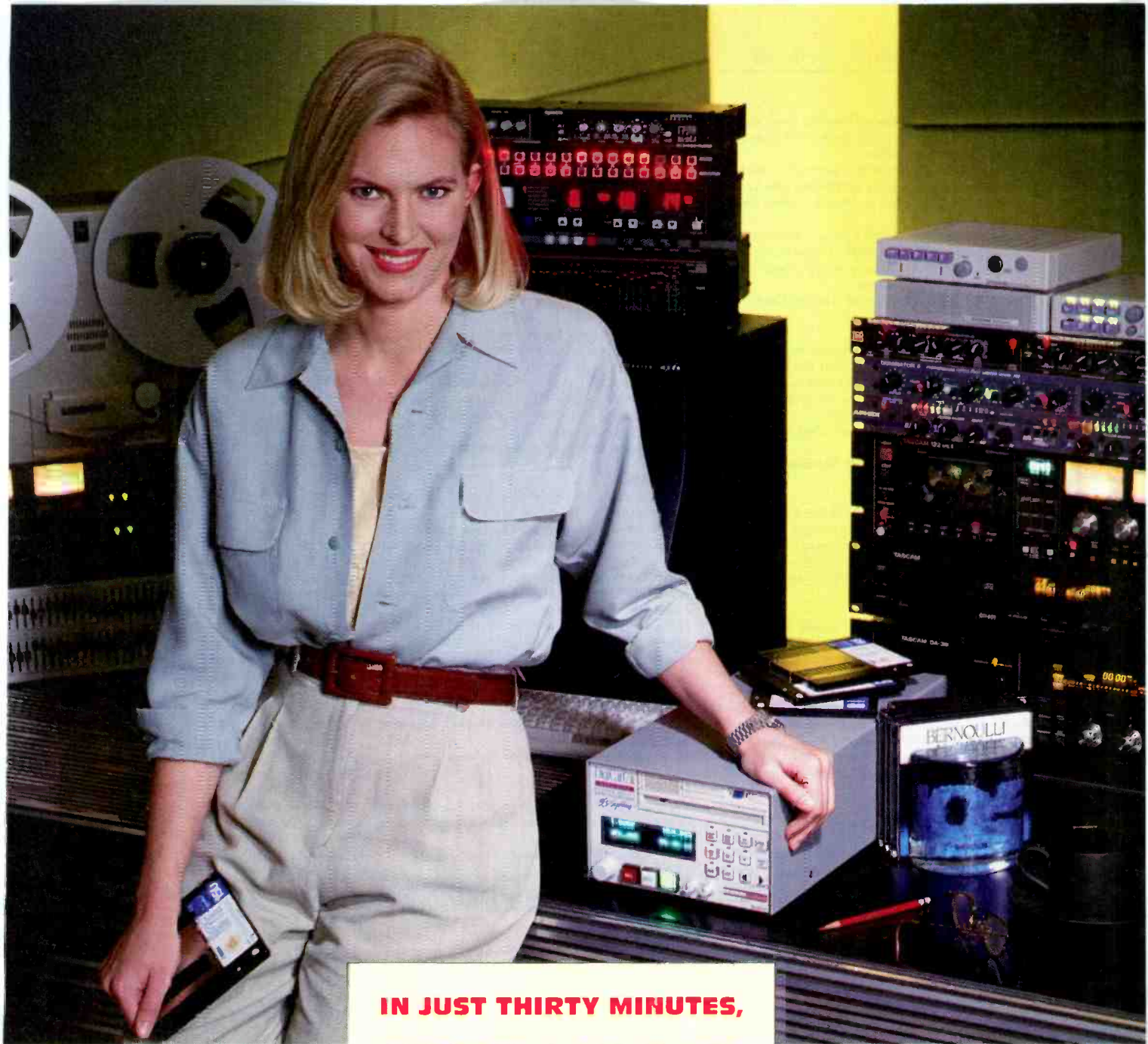

**IN JUST THIRTY MINUTES,
THIS POST-AUDIO EDITOR
LEARNED HOW TO USE
DIGICART/II
—FROM SQUARE ONE.**

By lunch time she had recorded forty-one spot effects, five background effects, and twelve music beds. She also

made twenty-two cuts, eighteen fades, and built ten

playlists. From there, she set up three music loops and nine effects loops. When she was done, she handed

the entire job to the client—on a single disk.

Pretty good first session.

360 Systems

PROFESSIONAL DIGITAL AUDIO

18740 OXNARD STREET, TARZANA, CALIFORNIA PHONE 818 342 3127 FAX 818 342 4372

Circle (62) on Reply Card

Pinnacle Systems

Flash Grafix Composer: Graphics composition system incorporating paint, titling, still storage, 3-D modeling and animation.

Refractor: Enhancement to *Prizm* video workstation providing single-pass curvilinear effects with different video on front and back, highlights and shadow.

pcDVE: Fully programmable, broadcast-quality 3D video effects system for IBM PC and compatible computers; effects include warps, page turns, montages, slabs and cubes.

Circle (893) on Reader Service Card

Pioneer

VDP-V1100: enhanced rewritable videodisc recorder; 0.5sec access time; real time non-linear playback; instant start; RS-422A serial interface.

RM-V8000: Compact, seamless, 80" projection cube system; optional VGA capability.

CAC-V3200: CD autochanger with 300 disc capacity and dual CD players.

Circle (894) on Reader Service Card

Plateau Digital Technology

PVM-07 Opt Camera Pixel Tester: for PVM-1073 system; locates and measures camera pixel errors; accurate for mono or color cameras to 900 lines resolution; 7sec required to test each pickup.

Circle (895) on Reader Service Card

Potomac Instruments

1730-AC: Transmitter output power analyzer; incorporates two instrumentation amplifiers and multifunction analog computer; configurable for correction of out-of-tolerance conditions on a variety of AM and FM transmission equipment.

1750-TLM: Tower light monitor; four comparators each with adjustable DC reference voltage; each input incorporates detector for AC input from tower light current-sampling transformers.

Circle (896) on Reader Service Card

Prime Image

ESS 5: Dual channel electronic still store; composite and Y/C I/O; accepts non-TBC and non-synchronous inputs; NTSC, PAL or PAL-M; 100 or 1000-frame capacity with removable backup on disc or tape; transition effects, sequences and loops.

SC-1X/SC-10X: Single-channel/10-channel standards converters for NTSC, PAL, PAL-M, PAL-N, SECAM, NTSC 4.43; composite or Y/C I/O; TBCs and synchronizes each input.

8X: video expansion chassis for TBC or standards converter cards.

BC-TBC/PCB: Plug-in, true broadcast quality TBC with expanded adjustment features.

Std Con/PCB: Plug-in card variant of SC-1X standards converter.

Circle (897) on Reader Service Card

Pro Battery

Product line includes: Premium nickel-cadmium battery packs for professional TV; NP1As, NP1Bs, 12V, 13.2V, 14.4V bricks types; VP-90s, belts; chargers, primary batteries; rebuilding services.

Circle (898) on Reader Service Card

Pro-Bel

Model 5023: 44.1 to 48kHz digital audio sampling rate converter; AES/EBU or SPDIF formats; selectable 16, 18 or 20-bit dither.

Models 6615/6635: Provide conversion between component analog video and 10-bit (270Mbit/s) serial digital video; full CCIR 601 filtering and variable horizontal timing; 8-bit versions (parallel or serial) also available.

Procion A-V Workbench/A-V Tools: Windows/PC-based control and monitoring system for audio and video equipment; provides touchscreen control and status monitoring of VTRs, routers and multichannel audio; operates standalone or networked.

Circle (899) on Reader Service Card

Production Garden Library

Product line includes: Production music libraries,

Broadcast 100 and AV/Video 200 series.

Circle (900) on Reader Service Card

Professional Label Inc.

Catalog 519: Audio and video cassette/reel labels; floppy disk labels; IBM and Mac label-printing software.

Circle (901) on Reader Service Card

Professional Sound Corp.

Product line includes: Production audio equipment manufacturer and distributor; portable mixers; lavalier microphones; boompoles; audio distribution amps; battery supplies; mic power supplies; RF antennas; sound carts, custom cables.

Circle (902) on Reader Service Card

Progressive Image Technology

SG-SX: S-video and composite genlock and overlay device for Amiga computers.

Video Slot Box: External chassis for Amiga 2000, 3000, 4000, providing four additional video slots; allows switching between multiple video devices on a single computer.

Circle (903) on Reader Service Card

Promusic

Match Music Library: 50-CD set with wide variety of musical styles useful for broadcast.

Claire Music Library: series using French musical talent; brings new colors, interesting concepts to enhance your productions.

Spain is Music Library: musical journey through Spain, Mallorca; historical styles to flamenco, romantic themes; 5-CD set.

File Effects: new sound effects library; 10-CD set of ambient sounds with approximately three minutes duration each.

Circle (904) on Reader Service Card

Prophet Systems

Wizard for Windows: Windows-based radio automation system.

Circle (905) on Reader Service Card

PT Multi Media Promo

Product line includes: Organizer for Broadcast '93 International Broadcasting Exhibition, Jakarta, Indonesia.

Circle (906) on Reader Service Card



Q-TV

Lightweight on-camera prompter: superimpose copy directly over the taking lens insuring eye-to-eye contact.

Executive Speech Prompter: improves speakers eye contact at public speaking events.

FDP series flat panel prompters: 9", 11", 15", 17" prompter displays for studio, remote, executive speech prompting.

Prompting accessories: VGA/NTSC encoder; talent operated controls; Simulscan laptops.

Circle (907) on Reader Service Card

QEI

QSS-10000 transmitter: solid-state 10kW FM system.

691 VPTDO: variable peak duration test for modulation monitor.

FM Automod: closed-loop composite modulation controller.

Circle (908) on Reader Service Card

QSI Systems

Model 800 image inserter: places stored images in video with 760x480-pixel resolution; output is RS170A compatible.

#8000 image generator: graphics editor; creates image EPROMS for image inserter.

Model 824 image inserter: self-contained unit; 1RU high; produces up to a full frame image of 24-bits true color for insertion over NTSC video; built in 256 step linear keyer, pixel resolution 720x480.

Model 824P image inserter: PAL version of 824; 720x512 pixel resolution.

Model 808 image inserter: self-contained; 1RU high; produces up to a full frame image of 8-bit

color with 8-bit key signal for insertion over NTSC video; 720x480 pixel resolution.

Model 808P image inserter: PAL version of 808; 720x512 pixel resolution.

Model 9000 image manipulator/inserter: self-contained unit 2RU high; mouse-controlled/menu-driven device; captures a full frame of NTSC video for manipulation.

Option 1: 9000 preview board: allows full on-line editing and switching between preview and program frame buffers.

Circle (909) on Reader Service Card

Quality Video Supply

Product line includes: Kramer video processors, encoders, decoders, correctors; computer-to-video interface products; other video products.

Circle (910) on Reader Service Card

Quanta

Delta EL: single output (RGB or YUV) character and graphics generator, compatible with other Delta SE or SX models.

Delta PostScript converter: provides downloading from PC or MAC PostScript files via RS-232 port.

T-A-G-S: logo display unit, stores/displays up to 30 Delta-created logos or graphics.

SIGNA: anti-aliased text and graphics system, on-line dynamic sizing of more than 100 fonts on-line.

Circle (911) on Reader Service Card

Quantel

HAL digital compositing system: effects, graphics, keying functions; Chatter disk management system; manipulate multiple layers of live video; Clip library and clip archive, Megablur, and Contour for DVE transitions.

HENRY concurrent editor: simultaneous multilayering and non-linear operation; 15-minute true random access storage; new software enhancements include event tagging, segment copy and drop frame EDL conforming and Contour effects package.

Micro Henry: off-line editor providing full concurrent editing capabilities; true random-access and non-linear storage.

Clipbox: tapeless on-air presentation system with 1½ hours of random access with CCIR 601 video quality storage; clip editing and assembly tools with AES/EBU audio tracks.

Harriet upgrade: interface to Paintbox, Picturebox and shared disk storage via Picturenet; improved graphics preview, library picture search; additional timeline control.

Picturebox: stills preparation, storage, management and networking system; cut-paste graphic creation; integrated captioning.

Paintbox Ver 8.0: includes zoom feature for graphics, pasteup, effects menus; radial, parallel lines; glue functions; extended translation of numeric data to graphics; Picturereport interface to Macintosh.

Circle (912) on Reader Service Card

Quickset

Computerized controls: for pan and tilt heads.

QPT-15: electromechanical pan/tilt system.

QPT 90: low-profile pan/tilt controllers with proportional joystick, digital, RS 232 QPT 15 wireless (RF) and over telephone wires; 10-mile range plus.

Circle (913) on Reader Service Card



R-Columbia Products

RL-100: wireless talent cue hearing aid type headphone.

TR-50B: wireless base station providing full or partial duplex intercommunication.

TR-470: wireless intercom headphone, 1W RF output, 450Mhz band operation.

CC/IC-2B: intercom headset, single or dual ear styles, XLR connector.

Circle (914) on Reader Service Card

Radamec EPO Ltd.

RP2 robotic pedestal: 2nd generation unit designed for ENG/EFP cameras, lenses.

Type 435 P/T head: pan/tilt unit with manual control and adjustable fluid damping; supports



Nature has its own
professionals of
sound and vision.



The wonders of sound and vision found in nature are hard to reproduce. In fact, if anyone has come close it's EEV.

Whatever your broadcast requirements, you'll find EEV has the technology to match. High-efficiency UHF Television Klystrons from 5kW to 70kW for Television Transmitters. A range of Broadcast Tetrodes and Vacuum Capacitors for AM and FM transmitters, and Leddicon® camera tubes to fit virtually every broadcast color camera available today.

Our experience is the key to technological leadership. Our manufacturing know-how ensures the highest quality and reliability. Above all, our professional dedication to our customers' needs makes us the natural choice of broadcasters the world over.

® Leddicon is the Registered Trade Mark of EEV Lead Oxide Camera Tubes.

EEV

Technology for the Broadcast Industry

USA: EEV Inc, 4 Westchester Plaza, Elmsford, NY 10523. Telephone: (914) 592 6050 or 'Toll Free' 1-800-DIAL EEV Telex: 6818096 Fax: (914) 682 8922
CANADA: EEV Canada Ltd, 67 Westmore Drive, Rexdale, Ontario M9V 3Y6. Telephone: (416) 745 9494 Telex 06 989363 Fax: (416) 745 0618
UK: EEV, Waterhouse Lane, Chelmsford, Essex CM1 2QU, England. Telephone: (0245) 493493 Telex: 95103 Fax: (0245) 492492

Subsidiary of the General Electric Company plc of England. **S&C**

Circle (63) on Reply Card



loads to 70kgs.

SAS See and Select: cue computer facility; frame grab function; shot replay through screen selection.
Circle (915) on Reader Service Card

Radiation Systems Inc.

Model 240KVO: offset-feed SNG antenna system.
Anghel: frequency synthesized satellite up/down converter, available for both C and KU-bands.
Truncated antenna: 8' category A performance with 6' tower windloading; frequency range 2GHz, 7GHz, 13Hz.

Circle (916) on Reader Service Card

Radio Computing Services

Linker: integrates commercial and music logs on paper or for transfer to a radio automation system.
RCS Works! integrated programming, traffic, billing, continuity, news, sales and production package.

Circle (917) on Reader Service Card

Radio Design Labs

Rack-up series: RU-MX5 5-input mixer; RU-DA4D 1x4 stereo audio DA; RU-VDA4 1x4 video DA; RU-SM12 dual audio meter; RU-RA3 19" rack adapter holds up to three Rack-up products. (See Pick Hits.)

Circle (918) on Reader Service Card

Radio Systems

RS-24 mixer: 24 linear faders for 48 stereo or mono sources; production or on-air.
RS Master Clock: analog system with drivers, slaves; digital and analog displays available.
RS-Squared: 24dB noise reduction stand-alone encode-decode unit based on Dolby S technology; single-ended stereo phase correction;
TI-101: telephone interface, provides equalization, limiting and conferencing.

Circle (919) on Reader Service Card

RAM Broadcast

32000C: professional communications system, capable of 32-users.
SS9200: on-air console, up to 30 input modules, stereo plus audition and mono sum output channels.
SR10A: audio switcher.
AA9400XL: on-air console, stereo plus audition, two telephone mix-minus buses.

Circle (920) on Reader Service Card

Ramsa Audio/Panasonic

WR-S4400: 4-bus mixers with 12 to 24 channel models; 2-inputs per channel; 3-band EQ; L/R stereo masters from channels, groups and four aux sends.
WP-1000 series: audio power amp uses class H circuit, also WP-1200, WP-1400 models.
WX-RP410/RP700: 30-channel 800MHz UHF wireless mics for ENG/EFP.
SV-3200: R-DAT system.
WS-T212, WS-T215: loudspeaker systems.

Circle (921) on Reader Service Card

Rank Cintel

Jumpfree update: URSA telecine enhancement increases vertical stability allowing real-time transfer with accurate matting; pan, zoom features.
Turbo 2 telecine: adds digital deflection to the Turbo MkIII flying spot optical system; expands adjustment range in image rotations, zoom, positioning, aspect ratio changes, panning.
Piximile: still image transmission by phone line with Windows interface.
Super 16mm gate: URSA enhancement; ideally suited to wide-screen TV.
4x4 4:4:4 option: URSA enhancement; digital output and extension to the digital video channel; increases resolution with field-installed replacement electronics assembly.
MK III HD telecine: 787.5-line, 60-field sequential scanning with flying spot system, also capable of 1250/50 and 1125/60 operation.
Lowspeed option: URSA telecine enhancement

extends operating speed range to 5 frames per second.

Circle (922) on Reader Service Card

Raytheon semiconductor

Product line includes: wide range of semiconductors for audio and video applications.

Circle (923) on Reader Service Card

Recognition Concepts

VDR 1000 series recorders: records either composite or component digital video on same disk, up to 100 minutes of composite, 50 minutes of component or 34 minutes of HDTV video.

Circle (924) on Reader Service Card

RE Electronics

RE-533: RDS coder; stores 16 data records; supports Program Service name, Program Type, Traffic Announcements, Radio Text and other service types; RE531 adds paging capability.
RE8720/8730: tie line audio codec for 15kHz stereo transmission on telco lines or twisted pair conductors.
RE880 sound interface: encodes, decodes four 7.5kHz speech channels to 64kbit/s.

Circle (925) on Reader Service Card

Rees Associates

Product line includes: Architectural services.
Circle (926) on Reader Service Card

Register Data Systems

DigiCorder: digital alternative to cart machine in live station operation.
The Phantom: complete digital audio automation system for recording, scheduling and playback of commercials, liners, promos and satellite sources.
Traffic Master: Radio station business computer system, handles traffic, billing. Upgrades include payroll, general ledger and accounts payable.

Circle (927) on Reader Service Card

Research Technology International/RTI

CF3000-MK V: Lipsner-Smith ultrasonic film cleaner;

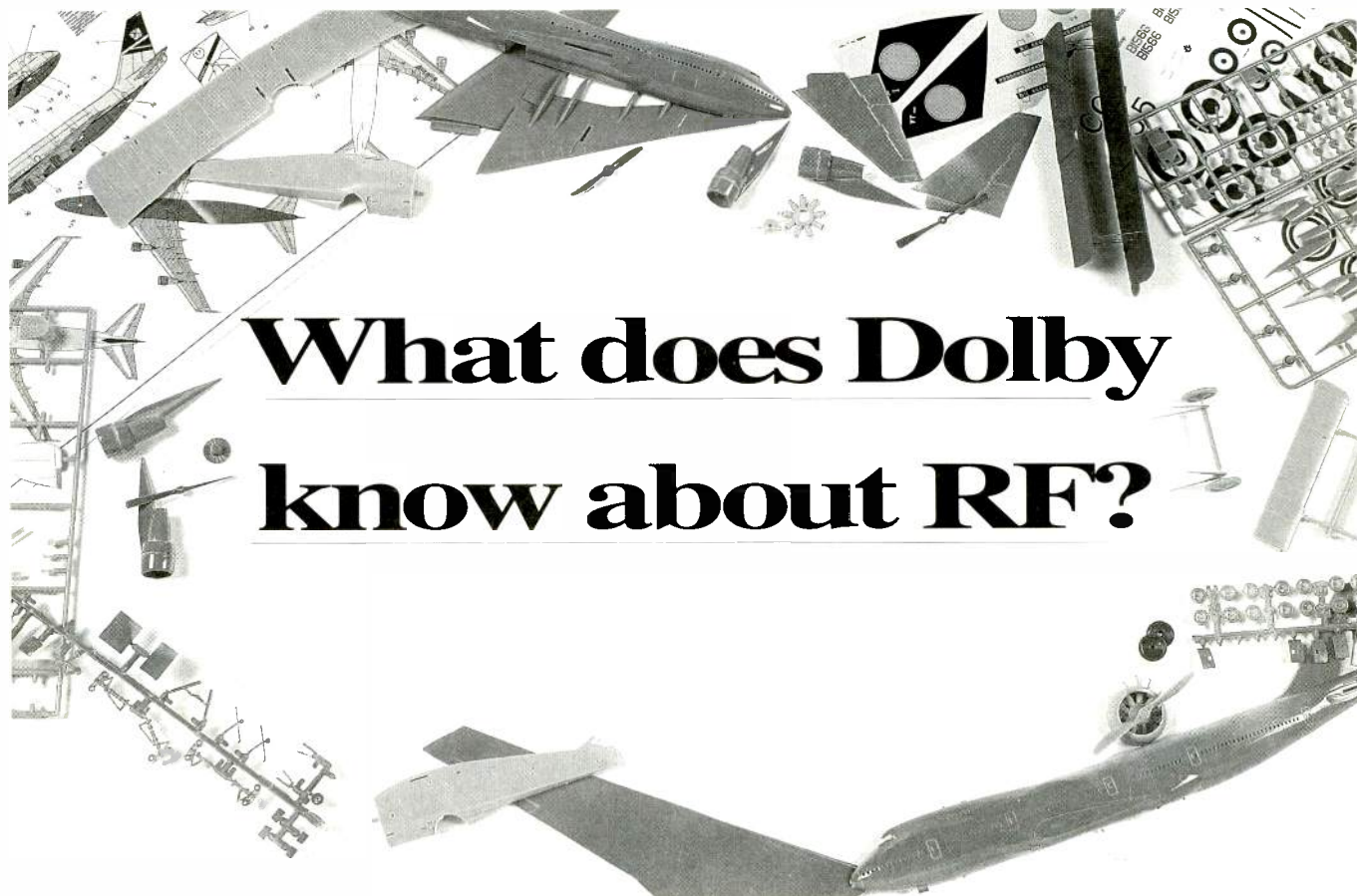

What does Dolby
know about RF?

NAB '93 - Show of Shows

optional submerged buffing for enhanced cleaning, speeds to 200 feet per minute.

TapeChek DVL: produces audible signal when a tape-based defect in the video is sensed.

Proline 4100: Betacam SP tape recycler; automatic cleaning, evaluation and rejuvenation of Betacam cassettes.

TapeChek XCL: cleaner, conditioner, rewinder for VHS.

M110 degausser: with Steady Drive insures proper erasure.

QC Master: dropout warning system, verifies tape condition.

Circle (928) on Reader Service Card

RF Specialities

Product line includes: broadcast-related products, audio, RF and control systems.

Circle (929) on Reader Service Card

RF Technology

D series portables: transmitters, receivers in 1.7-15.6GHz band.

M3000 transmitter, 200DX receiver: effective for surveillance work; applicable to LPTV STL applications.

DM-2, DM-8: digital codecs for 2Mb/s or 8Mb/s data transmitted above video on conventional analog link; (DM-34, DM-45 for 34Mb/s, 45Mb/s capability in narrow bandwidth with QPSK techniques).

UPL series: line extended to include 1.7-15GHz; dual audio, synthesized frequency control.

SVX-140T: satellite video exciter for Ku or C-band operation.

Circle (930) on Reader Service Card

RGB Computer & Video

AmiLink editing systems: controls VTRs, production switchers, effects, audio devices and other peripherals.

Circle (1133) on Reader Service Card

RGB Dynamics

Videolink 1500: scan converter, transforms computer graphics to NTSC or PAL.

MediaWall: uses PC or Mac software to create wall-sized presentations.

Circle (931) on Reader Service Card

Richardson Electronics

Amperex 3-500Z/8802: power triode for AM transmitters.

YL1057 tetrode: metal-ceramic with concentric electrode terminals; replaces Siemens device in TV visual or aural PA and translators; 2.3kW rated, to 860MHz.

FM modules: by Spectrian; ratings for 150W, 300W and 700W.

National NL347: 1kW tetrode for UHF transmitters.

Emac 9007: tetrode for VHF transmitters.

Shure microphones: all broadcast mics and mixers available from stock.

Stage/studio lights: available from GE and Ushio.

Pallets: by Pineapple Technology; ratings for VHF 300 W (high and low band); ratings for UHF: 4W, 10W, 60W and 200W.

Broadcast modules: from RF products; rating 300W pallet.

High-power modules: from AMT; ratings 150W, 300W and 700W.

Circle (932) on Reader Service Card

Rohde & Schwarz

RDS decoders & encoders: line of decoders/encoders for EBU, ARD specifications; retrieves, monitors, transfers RDS and RBDS signals transmitted in FM multiplex system. Includes DMC 05 Coder, decoder DMDC 05 and DMC 01 codec.

VNA video noise meter: for all TV standards; also for 1050-, 1125-, 1250-line HDTV, CCVS, analog component 525-/625-line systems and several non-broadcast standards.

NR410T FM transmitter line: solid-state FM transmitters, models provide output powers ranging from 1kW to 20kW.

Circle (933) on Reader Service Card

Roland Corporation

MUSICAM Codec MUSIC: digital system for audio transmission via digital links, satellite channels or ISDN telephone lines.

SAF, SFF signal generators: provide BG/PAL and M/NTSC test signals plus measurement capabilities.

AR-1000 digital announcement recorder: storage, record, play 500 separate voice announcements.

DM-80-S multitrack manager: software for Macintosh PC; controls DM-80 multitrack hard disk recording system.

DM-80 drives: optional rewritable MO drives provide four-track recording.

FG-1000 Music Timer: for high-quality music playback per user programmed time schedule.

FM 4G 4-channel mixer: accepts mic and line level inputs; configures for PA system in combination with AR-1000 announcement recorder and FG-1000 Music Timer.

SRC-2 sample rate converter: two inputs, select among multiple digital formats for bidirectional conversions.

TAP-10 Audio Producer: sound card and Audio Toolworks software.

DM-80-L resolver: permits accurate frame edge lock to any source of non-synchronous time code.

S-770/750 samplers: digital samplers, RAM expandable up to 94 seconds of stereo sampling at 48kHz.

SP-700 sample playback module: 8Mb of RAM, user expandable to 32MB, yielding more than three minutes of stereo audio.

RAP-10 audio card: provides desktop digital audio workstation capability for use in a PC-compatible computer.

Stereo micro monitors: line of multimedia application self-powered audio monitors.

Circle (934) on Reader Service Card

Rorke Data

Mass storage systems: wide range of magnetic storage devices from major manufacturers for au-

As much as we know about audio.

With decades of experience in audio and psychoacoustics behind it, Dolby's DSTL[®] digital aural STL was destined to be the best-sounding system in the world. And it is. But the story doesn't end there. Using the most advanced RF technologies, the DSTL system achieves new heights of RF performance and reliability:

- Increased fade margin.** Thanks to a highly sensitive receiver, the Dolby DSTL system outperforms analog and other digital STLs on long or obstructed paths, where dependable operation is a must.
- Greater immunity to interference.** A wide RF dynamic range makes the Dolby DSTL system highly immune to adjacent channel and co-channel interference. Even powerful cellular and paging transmitters won't faze it, so your signal comes through loud and clear.
- Superior spectrum efficiency.** With sophisticated modulation techniques and an ultralinear RF transmitter, two program and two auxiliary channels occupy a bandwidth of only 250 kHz (half that of ordinary composite STLs). That means clear skies for you and your frequency coordinator, particularly in congested markets.

Progressive RF technology plus digital sound quality add up to the highest-performance STL ever. Contact Dolby Laboratories or your authorized Dolby DSTL distributor to see how it flies.



dio and video applications.

Circle (935) on Reader Service Card

Rosco Laboratories

E-Colour: European color filters.

Circle (936) on Reader Service Card

Ross Video

RVS 630 production switcher: 30-input with two 4-bus multilevel effects systems, 12 linear keyers. **VTA 7000 series amplifiers:** complete line of video equalizing amplifiers.

Circle (937) on Reader Service Card

RTS Systems

IKP950PCS: production control stations.

SAP612: source assignment panel.

Model 2550: quad galvanic isolated buffer amplifiers.

TIF 950 series: telephone interface.

V-100: lightweight professional headset.

SSA 324: system to system interface.

Circle (938) on Reader Service Card

Rules Service Company

Product line includes: FCC rules, regulations publishers.

Circle (939) on Reader Service Card

The M S Russin Group, Ltd.

RF-2020RCF rack-mount card frame: processing unit for six camera/lens stations.

RF-1000P/T: low-profile, 9lb, programmable pan/tilt unit for camera, lens package to 18lb.

RF-2000DTC desktop controller: for remote programming of 24 preset positions for six camera/lens stations.

Circle (940) on Reader Service Card



Sabine Musical Manufacturing

FBX-90 feedback exterminator: digital notch device senses, eliminates feedback.

Circle (941) on Reader Service Card

SADIE

SADIE: professional digital audio disk editor for Windows.

Circle (1215) on Reader Service Card

Sachtler

Vario Ped 1-90, 2-75: support system for broadcast

cameras.

Video 18 Sensor, Video 20 Sensor: pan/tilt heads with LED display to show correct balance or center of gravity and correct dynamic counterbalance; feature 90% tilt, illuminated leveling bubble.

Suspension system, studio planning: complete line of Gridclimbers, Barrel hoists, motorized grid telescopes, Scenery hoists, Positioning controls. **Director series:** Fresnel lights for EFP and studio applications.

Reporter 1000H: open-face fixture for wide-angle illumination.

Reporter 200D: portable HMI light; size of Reporter 125D, output equivalent to Reporter 270D.

Circle (942) on Reader Service Card

Samson Technologies

Solo Monitor: 10-bus monitor console, 4-band EQ. **UHF Synth series:** multichannel wireless mics; dbx noise reduction.

MPL 2242: rackmount console; 22x10, with eq. **SNR 2000 Behringer audio processing systems:** SNR 2000 multiband denoiser, Autoquad XR 2400 expander/gate, Composer MDX 2000 dynamics processor and Intelligate XR 2000 expander/gate/ducker.

Servo 240/150: bi-polar audio amplifiers, 240W/150W per channel.

Jade: 48-channel input console, parametric equalizers, monitor channels.

Q5: five-output stereo headphone amplifier.

Ku Truck: 500W uplink to SatCom 2.4m prime dish; redundant RF electronics.

Circle (943) on Reader Service Card

Sandar Electronics

VD-2000: digital video matrix; 16 X 16.

VXA-2000: video crosspoint card; 16 x 16.

Circle (944) on Reader Service Card

Sanken/Audio Intervisual Design

CQ-1 prototype: 4-channel Shotgun Surround mic. **Spatializer:** professional real-time processor for placement and movement of audio sounds in 3-D space.

SR-15 Distriplayzer: time code distributor, reshaper, pilot tone stripper & time code analyzer.

Circle (945) on Reader Service Card

SCA Data Systems

Music 4 generator, receiver: 4-channel audio and data capability.

RD-57: RDS generator.

Circle (946) on Reader Service Card

Scala Electronic

MMMDS/ITFS: complete new line of transmit an-

tennas for wireless cable systems.

DVR TV transmit antenna: new VHF TV panel transmit antenna; capable of multi-channel TV applications.

UHF combiners: UHF TV transmitter combiners, capable of 100W/channel; capable of multi-channel TV applications.

Circle (947) on Reader Service Card

Schafer World Communications

Product line includes: CD automation system.

Circle (948) on Reader Service Card

Schmid Telecommunication

Product line includes: Audio test, measurement systems, RESCO network monitoring, control systems.

Circle (949) on Reader Service Card

Schwem Technology

GX-4: camera image stabilizer, matches Sony DXC-930 CCD camera.

FP-1 Gyrozoom: fits most ENG/EFP cameras.

GX-3: camera/zoom lens and stabilizer.

Circle (950) on Reader Service Card

Scientific Atlanta

Encore DSR-3610: digital satellite receiver. (See Pick Hits.)

2.4m antenna: towable mobile self-contained earth terminal.

Digital Ad Delivery system: combines D9100 VQ encoder, D9110 integrated satellite digital receiver with VQ decoder; IBM 386 PC controller; multiple 1Gbit hard disks.

7530I International Video Receiver: converts RF to video and audio.

Model 8136: 3.6m earth station.

Model 8885: digital satellite modem.

Model 9708: integrated receiver and decoder; incorporates VQ vector quantization digital video compression.

Model 7550B: satellite video exciter with sound-in-sync capability.

Circle (951) on Reader Service Card

Seem Audio

Seeport: portable audio mixer; features mono and stereo, 19" rack mount; includes output, talkback and monitor modules.

Circle (952) on Reader Service Card

Selco Products

Pointer knobs: soft-touch control knobs; custom colors for body or pointer.

Custom molded parts

VU/PPM/digital meters: panel, bezel mount.

Circle (953) on Reader Service Card

Sennheiser Electric

MKH80: five-pattern RF condenser microphone.

MD511-MD512: cardioid pattern microphone.

MD515-MD616: supercardioid pattern microphone.

MD527: dynamic supercardioid microphone.

BF1051: handheld wireless microphone system.

WEM2: wireless ear monitoring system.

EM 1046: UHF wireless microphone system with tunable frequencies.

Circle (954) on Reader Service Card

SESCOM

Product line includes: Audio modules, transformers and audio signal processors.

Circle (955) on Reader Service Card

Sherriff Systems

Deputy CG enhancements: titler software for 386/486 PC.

Circle (956) on Reader Service Card

Shima Seiki USA

Movix HD system: non-linear digital HD editing system.

Circle (957) on Reader Service Card

Shively Labs

Product line includes: Panel, side-mount FM broadcast antennas; related equipment; branched, balanced multistation combiners, rigid transmission line, pressurization equipment; omnidirectional

FLEXIBLE VIDEO MATRIX

- 4x2 V.I. Routing Switcher on a single DA card
- Plugs directly into GVG or LEITCH VDA frames
- Expandable to multi buss, multi layer, 8 input
- Composite or Component • Single coax remote
- 30 MHz response • Clamped inputs • Optional GPI

broadcast video systems ltd.

40 West Wilmot St., Richmond Hill, Ontario L4B 1H8
Telephone: (416) 764-1584 Fax: (416) 764-7438

Circle (65) on Reply Card

Our competition is making a lot of noise about their wireless. Trouble is, their wireless make a lot of noise too.



Experience the Nady 950 UHF. The first quiet multichannel UHF wireless.

Fact: Due to problems inherent to UHF technology, like phase noise and residual frequency modulation, UHF wireless systems tend to be noisy.

Fact: Other companies offer high end UHF wireless systems that are 5-10 dB noisier than their VHF systems, and VHF systems that are 10-30 dB noisier than any Nady.

Fact: Some companies that do offer a quiet UHF system don't advertise how they make it quiet: by sacrificing headroom. So you're asked to accept less critical performance—to choose between noise and clipping.

Fact: Nady devoted extensive R&D to testing, simulating and modifying our UHF systems. Our engineers utilized circuit modeling and analog simulation software to optimize our design and compensate for manufacturing tolerances and variations in device parameters.

Fact: Nady engineers achieved the first truly quiet RF link for UHF wireless. The Nady 950's proprietary com-

ponents and circuitry yield radio link carriers that are up to 20 dB quieter than any other UHF system. And Nady's specialized companding noise reduction delivers the best dynamic range—and headroom—in wireless today.

Fact: The Nady 950 features state of the art frequency synthesis. With several ten channel models in the 490-950 MHz range, and a 4C channel version in the 800 MHz range. Plus exclusive hiss mute circuitry, which maintains audio quality as the transmitter moves toward the outside limits of operating range. Variable bass boost. Balanced and unbalanced output. Switchable 115/220 and DC power. Available frequency bands for worldwide use.

Fact: You could pay a lot more for a UHF wireless system, and get a lot more noise. So choose the Nady 950 UHF.

Call us—we'll send you more info.



NADY SYSTEMS, INC. • 6701 Bay Street • Emeryville, CA 94608 • 510/652-2411

Circle (66) on Reply Card

and formal FCC directional pattern studies.
Circle (958) on Reader Service Card

Shook Electronics USA

Model 32-40: network quality production truck.
EFP/SNG trucks: high-density, small footprint designs for international market.
Model 48-63: 48-ft mobile TV production trailer for network sports.
Circle (959) on Reader Service Card

Shure Brothers

FP22: stereo headphone amplifier. (See Pick Hits.)
FP32A: portable stereo mixer, 3-inputs, 2-outputs.
Beta87: premium electret condenser concert quality mic.
L2/87: wireless version of Shure SM87 condenser microphone; handheld transmitter.
EC series wireless mic systems: digitally-controlled frequency-synthesized system.
L5: portable wireless receiver, camera mount, compatible with L series transmitters.
Circle (960) on Reader Service Card

Siemens Audio

CARAT: Computer aided radio and TV, automation system including main control, broadcast production and new studio control, archive, scheduling, commercial production and music/word editing functions.
Circle (961) on Reader Service Card

Sierra Automated Systems

Product line includes: Audio routing, switching and mixing systems, intercom equipment and teleconferencing hubs.
Circle (1203) on Reader Service Card

Sierra Video Systems

32000C: studio communications system; up to 32 users within one 3RU frame.
Control panels: IFB control panels for SAS 32000 series communication system.
Model 88VS router: compact 8x8 matrix for video plus stereo audio.
Sierra, Tahoe series: routing switcher families.
Model 1616D: serial digital video routing switcher in single rack unit.
Delta series: video transcoders.
Series 10: distribution amplifiers.
Circle (962) on Reader Service Card

Sigma Electronics

Series 3200: flexible 16 x 16 to 64 x 64 audio/video routers.
TCD-1080/81: stand-alone transcoders, RGB to component and composite.
Series 1000: plug-in modules; transcoders, encoders, decoders, multichannel DAs.
Circle (963) on Reader Service Card

Signal Technology/Microsonics

Product line includes: Digital signal filters, video delay lines, oscillators and matrix switchers.
Circle (964) on Reader Service Card

Silicon Graphics

Galileo Video: I/O processor for Indigo family of desktop workstations.
Cosmo compress: real-time JPEG video compression/decompression for Indigo workstations.
Siris Video: digital video output for SG family of workstations.
Circle (965) on Reader Service Card

Sinar Bron

ProCyc: 5-foot and 3.5-foot radius curved set pieces hide floor-curtain interface; fiberglass construction.
Broncolor HMI light: 2.5 times as bright as halogen light of equivalent power rating; offers daylight color temp.; provides electronically controlled flicker-free light at constant output.
Circle (966) on Reader Service Card

Sira Sistemi Radio s.r.l.

Product line includes: wide range of RF products:

FM and TV antennas, filters, switches, coaxial products.

Circle (967) on Reader Service Card

Skaggs Communications

Product line includes: consoles, rack-mounting equipment, custom configurations.
Circle (968) on Reader Service Card

Skotel

SER-100, 200: serial digital video coders.
SDM-300: DAC, convertor for 4FSC signals to analog composite.
ASD-100: ADC, component analog video to serial digital video convertor.
SEL-1600: digital video selector, 16x4 serial video matrix.
Titania Toccata: complete 3-D video effects and serial 4:2:2 I/O cards for Matrox Studio.
Circle (969) on Reader Service Card

Smarts Broadcast Systems

Point and Play: combines digital audio with touch-screen operation.
Circle (970) on Reader Service Card

Smith Systems

Product line includes: mobile equipment cars.
Circle (971) on Reader Service Card

Snell & Wilcox

DVS1000: compact 4:2:2 switcher with single M/E; 10 wipe patterns; edge softness; integral serial digital router with 8x4 matrix.
HD2100 downconverter: produces 525-/625-line material with ultimate picture quality.
HD3100 crossconverter: converts between field rates and line rates, bidirectionally; from 1125/60 and 1250/50 to 525/60 or 625/50.
Alchemist with Ph.C: standards converter with phase correlation motion estimation; 24-point linear aperture CCIR-601 converter; transparent conversion retains resolution, removes judder and blur.
HD5100 upconverter: accepts all conventional video formats as inputs to include conventional video into HDTV productions; supports all current HDTV standards.
KUDOS series: CVR45 standards converter; TBS24 wideband digital synchronizer, CC10 color corrector; TPG20 multistandard, multiformat test signal generator.
PRISM digital decoder: reference standard decoder; exceptionally clean separation of luminance and chrominance components; acts as bridge between composite digital and component digital environments.
Gazelle slow motion system: real time picture creation system; uses Ph.C phase correlation motion estimation to produce extra frames for infinitely variable slow motion.
MDE1000 digital encoder: multistandard system samples incoming components to 12 bits; delivers highly accurate, stable output in six encoded standards.
Circle (973) on Reader Service Card

Society of Broadcast Engineers

Circle (1201) on Reader Service Card

Softech Systems Inc.

NewsView: total PC-based integrated newsroom for cost-effective automation.
Circle (974) on Reader Service Card

Softimage

Digital Studio: production/post environment for digital media producers; 3-D imagery, sound, video in one package; operates on SGI workstation; digital on-line editing, compositing, titling, image processing, manipulation; sound editing; Creative Environment 3-D animation, visualization, modeling.
Circle (975) on Reader Service Card

Solid State Logic

Scenaria OmniMix Digital Surround Sound Audio/Video System: dynamic pan automation of up to 32-sources, or submixes in 4-, 5- or 6-channel surround plus spatial effects; includes VisionTrack random-access video system.

G Plus Consoles: enhancements to the G-series consoles.

SL 8000GB: on-air production console; G-series automation computer control over TV, motion picture, music recording configurations; switchable for broadcast, record and remix.
Circle (976) on Reader Service Card

Sonic Solutions

CD Printeric Station: desktop CD recording system; double speed writing; precision track start, end times; 74-minute capacity; also usable for creating CD-ROMs.
MediaNet: network for multimedia professionals; FDDI/CDDI network NuBus cards for Apple Macintosh; simultaneous playback of 100 channels of CD-quality audio, 3-50 channels of compressed digital video; integrated multimedia file server; up to 1,000 nodes.
Circle (977) on Reader Service Card

Sony Communications/Broadcast

DVW-A500: digital Betacam recorder/player; also plays analog Betacam SP tapes; DVW-500 same as DVW-A500 but does not play analog tapes. (See Pick Hits.)
PVV-1A: dockable Betacam SP recorder for DXC-537 and DXC-327A cameras.
LVR-3000N: videodisc recorder; component time division multiplex.
BVP-370A: 3-CCD studio camera; 700 lines.
DVS-6000/6000C: 32-channel digital production video switcher.
DVS-2000C: compact digital component switcher.
BVE-2000: 6-VCR editing control unit; 998 event.
PVE-500: 3-VCR editing control unit; 99 event.
DES-500: PC-based video editing workstation
DME-3000: Digital multi-effects
DFX-C2: converts Sony D-2 VCR to component recording
BVM-1311, BVM-1316, BVM 1911, BVM2811: Broadcast video monitors
FDL-X600: 5.9" LCD color monitor
PCM-E7700: 2-channel digital 4½ audio recorder with editor
DMX-S6000: Digital audio-for video console
CDP-3100: Pro CD player
PCM-2700A: Studio DAT recorder
WRR-810A, WRR-860A: Wireless mic systems for Betacam recorders.
LBU-2000: Laser beam link system
Circle (978) on Reader Service Card

Sony Recording Media

KN-3: ½" video duplication tape for Sony Sprinter.
Circle (979) on Reader Service Card

Sound Ideas

Product line includes: production music, effects products.
 The Warner Bros. sound effects library
Circle (980) on Reader Service Card

Sound Technology

Product line includes: audio test, measurement equipment.
Circle (981) on Reader Service Card

Soundcraft

Product line includes: audio mixer systems, SAC 200 production and on-air consoles, Delta series consoles with audio-for-video interface.
Circle (982) on Reader Service Card

Soundforms Int'l.

Product line includes: portable, lightweight enclosures for recording booths; SoundBooth, SoundRoom.
Circle (983) on Reader Service Card

Spectral Synthesis

Prisma: Windows-based, 12-track digital audio.
Circle (984) on Reader Service Card

Sprague Magnetics

Pro-SS: DOS-based multimedia package
56K: PC-based digital audio workstation
Cable assemblies: Geneva audio, video cable kits.
Circle (985) on Reader Service Card

When you can't see the trees for the forest...

Sierra's Tahoe Series multi-level routing switchers lead the way!

If you can't find the signal you need *when and where* you need it, you need Sierra! Our Tahoe Series video and audio routing switchers will put you and your signals on the right path and improve your productivity at the same time. Tahoe Series routing switchers offer better than broadcast quality performance at affordable prices. See why others are moving up to Sierra Video Systems to get their signal back on the right trail...



- ▶ Available in sizes from 16x16 to 32x64. Custom sizes too!
- ▶ Up to 8 levels of composite or component analog video and audio switching — with transparent performance.
- ▶ Powerful three port serial control system supports up to 64 control panels at distances to 1,500 meters.
- ▶ Serial interface for a host computer or third-party controller. MS-DOS® application software included!
- ▶ Terminal port for system set-up. Assign control panels to levels and outputs as needed.
- ▶ Expandable. Upgrade at any time by simply adding modules. Ask about our trade-up program too!
- ▶ Companion serial digital video, wideband RGB and RS-422 data routing switchers from the SVS™ line-up.
- ▶ Seven-Year Warranty! When it comes to reliability and service, we mean it!



...you can see the difference!

SIERRA VIDEO SYSTEMS, INC.
P.O. Box 2462
Grass Valley, CA 95945 USA
Telephone: + 916.273.9331
Facsimile: + 916.273.9390

For more information about us or to review our broad range of products, simply call us or contact your local SVS™ dealer and request a copy of our latest catalog.

NAB '93 - Show of Shows

Sprocket Video Technologies

Product line includes: digital utility devices, serializer, deserializers.

Circle (986) on Reader Service Card

ST Keltec Corporation

Product line includes: satellite communications products; H60-350X, R60-300Ku, H40-50Ku, H40-50C1J.

Circle (987) on Reader Service Card

Stainless/SG Communications

Product line includes: tower products, services.

Circle (988) on Reader Service Card

Standard Communication

Product line includes: satellite TV, the Agile Omni Broadcast MT-830 and International MT-830I satellite TV receivers.

INTERCONTINENTAL: satellite receiver; microprocessor tracks LNBS without conversion chart.

Circle (989) on Reader Service Card

Stanton Magnetics

CD-33: dual CD player in console; 10-memory program play, 99 even direct access play, $\pm 12\%$ pitch control; forward and reverse, joystick control.

Circle (990) on Reader Service Card

Stanton-Video Services

Remote Head: 900° pan rotation, 2-position focus memory

Circle (991) on Reader Service Card

Star Case

EMS: expandable multitrack system, modular, molded E.I.A. rackmount case.

Circle (992) on Reader Service Card

Steenbeck

Product line includes: video, film editing, trans-

fer systems.

Circle (993) on Reader Service Card

Stellar Communications

Product line includes: Hafler amplifiers

Circle (994) on Reader Service Card

Storeel

Room Stretchers: compact storage system for smaller formats.

Set-up trucks: utility carts with maximum capacity to transfer tapes from storage area to playback area.

Stor-Max systems: double-entry high density premium quality steel tape storage for all formats; lengths from 3-18 feet without raised flooring or motorization.

Railrider systems: lateral high-density tape storage for areas with less than 3-foot depths.

Circle (995) on Reader Service Card

Strand Lighting

Leko: 1000w ellipsoidal spotlights

CD 80: Compact rolling dimmer rack

Circle (996) on Reader Service Card

Strassner Editing Systems

StudioHeart: Windows-based edit controller; supports Videomedia V-LAN

Circle (997) on Reader Service Card

Studer Revox

Product line includes: audio mixers; CD players/recorders, D740; audio tape recorders, A807A 4-track; telephone hybrids; R-DAT recorders; digital, analog routing switchers, digital audio workstations; broadcast automation systems.

Circle (998) on Reader Service Card

Studio Film & Tape

Product line includes: evaluated video recording tape.

Circle (999) on Reader Service Card

Studio Spectrum Inc.

Video dealer

Circle (1000) on Reader Service Card

Studio Technologies

StudioComm: digital audio workstation accessories

Circle (1001) on Reader Service Card

Sundance Technology Group

RADIO: random-access non-linear editing system for Macintosh.

Circle (1002) on Reader Service Card

Superior Electric

Product line includes: electronic and electrical control equipment; STABILINE series power protection equipment.

Circle (1003) on Reader Service Card

Sure Shot Teleproductions

Discovery: 48-foot mobile unit; GVG 300 switcher, Chyron 4200 titler, Abekas A-42, A-53 w/warp, 5 Ikegami 323, 3 Ikegami 323p cameras; Yamaha PM-3000 mixer, Sony 3100 VTRs, BVW-75s with 1/2" and 3/4" VCRs.

Circle (1004) on Reader Service Card

Swintek Enterprises

Mark 1L: UHF System.

Mark 200 transceivers: Full-duplex wireless intercoms.

Mark Q50-200/DCT: On-camera IFB wireless.

Circle (1005) on Reader Service Card

Switchcraft

VIP series: Insulated video patch panels, video patch cords.

Circle (1006) on Reader Service Card

SWR Inc.

Product line includes: RF feedline products; complete line of TV antennas, FM antennas featuring economical performance, Field Engineer Service,

Exclusive Direct Out (DO) switch maximizes flexibility. Allows reconfiguration of M1500 Series mixers without use of external patchbays

3-band EQ with sweep mid-range

In-line configuration allows easy monitoring of channels, use as separate monitor mix or double number of inputs for mix-down

Link (3-4 to 1/L-2/R) allows buses 3 & 4 to be used as a sub-group during mix-down

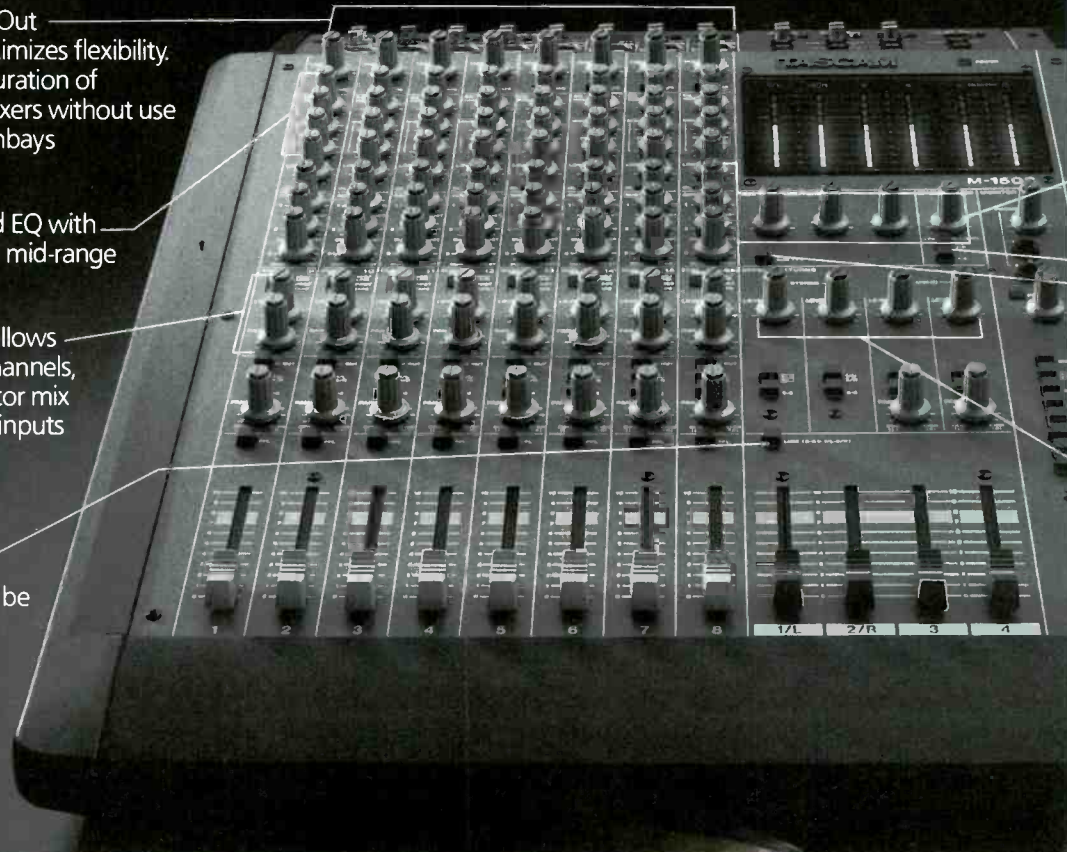

5-year limited parts, labor warranty.
Circle (1007) on Reader Service Card

Symbolics/Graphics Div.

ARKImage: Object oriented 2-D paint and animation for Symbolics 1200 and IBM PGWER Visualization Systems.

ARKSuite: Real-time graphic digital editing, layering and compositing system, designed to integrate with ARKImage.

Circle (1008) on Reader Service Card

Symetrix

Product line includes: Audio processors, 528 Voice processor, 511A single-ended noise reduction system.

Circle (1009) on Reader Service Card

System Associates

Product line includes: Used broadcast and TV production equipment brokers.

Circle (1010) on Reader Service Card

Systems Wireless

Product line includes: Wireless microphone systems, HME series 800 UHF wireless intercom; field production wireless equipment from Vega, Lectrosonics.

Circle (1011) on Reader Service Card

T

Taber

Product line includes: Recording media degaussers.

Circle (1012) on Reader Service Card

Tally Display Corporation

Product line includes: Indicators using matrix-type characters to identify and indicate status of equipment; red, green, yellow colors; senses router

configurations, etc.

Circle (1013) on Reader Service Card

TAO/Technical Aesthetics Operations

Editizer 2.1: A/B roll editing for Windows

Editizer 2.1: A/B roll for Macintosh

Editizer/Cuts: for Windows and Macintosh

Circle (1014) on Reader Service Card

Tapscan

Product line includes: Marketing research systems, QualiTAP, TargetONE.

Circle (1015) on Reader Service Card

TASCAM

112 MKII: Stereo cassette recorder; 4-track, 2-ch, 2-heads.

112R MKII: Same as 112 MKII, except bidirectional.

122 MKIII: Stereo cassette recorder; 4-track, 2-ch, 3-heads.

CD-901R: CD recorder compatible with CD players.

DA-88: digital 8-track recorder. (See Pick Hits.)

Circle (1016) on Reader Service Card

Taurus Communications Inc.

Product line includes: Full service telecommunications services.

Circle (1017) on Reader Service Card

TCS-Tripp Communications

Product line includes: Videocassette, CD organizer cabinets; double-density mobile or static cabinets fit room space limitations; Roll-Around trucks for videocassette applications.

Circle (1018) on Reader Service Card

Teatronics International

Product line includes: Lighting controllers, echelon, MD series modular dimmers.

Circle (1019) on Reader Service Card

Techflex

Product line includes: FLEXO sleeving, braided

monofilament cable, wiring harness management and protection products.

Circle (1020) on Reader Service Card

Techni-Tool

Product line includes: Special purpose tools.

Circle (1021) on Reader Service Card

Technosystem SpA

Product line includes: Microwave links 2GHz through 14GHz.

Circle (1022) on Reader Service Card

Tecnologie Elettroniche Milano/TEM

Product line includes: Radio/TV transmitters, translators.

Circle (1023) on Reader Service Card

Tekskil Industries

Product line includes: Prompting systems WindowsPrompt: Prompting for Windows PCs.

Circle (1024) on Reader Service Card

Tektronix

WFM601: Serial component monitor.

AVTIME: Automated detection system for audio-to-video delays

TSG-90: test generator. (See Pick Hits.)

1910: VITS inserter with Philips Ghost Canceller. (See Pick Hits.)

Circle (1025) on Reader Service Card

Telemetrics

TM-9255: coax camera remote control unit for lower end industrial cameras; uses RG-59/U cable between camera head and base station to 1,500 feet or 2,500 feet of RG-11/U; configurations for Beta, Hi8, MII, S-VHS cameras.

TM66095: pan/tilt control by RS-232; multicore system operates four cameras with 16 presets.

TM-9250: triax/coax camera remote control unit; interfaces for Sony, Panasonic, Hitachi, Ikegami cameras as complete stand-alone systems.

Circle (1026) on Reader Service Card

8 input/4 buss output/8 monitor

3 Aux sends;
 Aux 1, pre or post;
 Aux 2 & 3, either post
 or dual (monitor) send

Dual Master allows for
 mixing of dual section to
 either buss 1/L-2/R
 or buss 3-4

SUM 1+3 switch allows
 Aux 1 and 3 to be summed
 to allow signals from both
 main and dual sections
 to be sent to one effects unit

2 stereo and 2 mono
 effect returns

**YOU GET WHAT YOU PAY FOR.
 AND GET. AND GET. AND GET.**

One look at the features of the new M1508 (left) and you'll agree that it's a lot bigger than it appears. And, if you like what you get with our rack-mountable 8-channel M1508, you're gonna love the 16-channel tabletop M1516 all the more, because it lets you simultaneously utilize up to 32 input sources for mixdown, plus two stereo and two mono effects returns.

One way or the other (\$1,199* for the M1508, \$1,899* for the M1516), you'll get what you pay for, over and over and over again, at your nearest TASCAM dealer.

TASCAM

©1992 TEAC America, Inc., 7733 Telegraph Road, Montebello, CA 90640. 213/726-0303. *Suggested retail price.

Circle (68) on Reply Card

Sennheiser.



Still setting the standards.

Sennheiser's dedication to state-of-the-art technology, coupled with quality engineering, earned our microphones an Academy Award*. Sennheiser continues to set the standard in the industry, this time with the MKH 60 and MKH 70, our newest shotgun microphones. They display all the ruggedness that you need in audio production and the reliability that Sennheiser has become famous for.

Sennheiser. The first and last authority on shotguns!

Ask your Sennheiser Representative for a demonstration.

 **SENNHEISER**

SENNHEISER ELECTRONIC CORPORATION
6 Vista Drive, P.O. Box 987, Old Lyme, CT 06371
(203) 434-9190 FAX# 203-434-1759
Manufacturing Plant: D-3002, Wedemark,
Federal Republic of Germany

**©A.M.P.A.S.®

Circle (69) on Reply Card

NAB '93 - Show of Shows

Telecast Fiber Systems

Product line includes: fiber-optics equipment Sidewinder XL: Fiber optic snake; 12 lbs per 1,000 feet.

Circle (1027) on Reader Service Card

Telepak San Diego

Product line includes: equipment transport products; convenience items, T-Brief Producer/Director briefcase; full line of soft-sided carrying cases for portable video equipment.

Circle (1028) on Reader Service Card

Telescript

Notebook System: computer prompter.

Circle (1029) on Reader Service Card

Television Engineering

Product line includes: Mobile TV production, ENG vehicles; system design, construction; IFB controller.

Circle (1030) on Reader Service Card

Television Equipment Associates

Product line includes: Video filters for OEM design engineers; baseband video switched box delay lines for Video Toaster and TV facility needs.

Circle (1031) on Reader Service Card

Telex Communications/Pro A-V

Product line includes: Audio tape duplication units, Model 6120 high speed system; wired, wireless mic, ENG-4 portable wireless receiver; headsets.

Circle (1032) on Reader Service Card

Telos Systems

Zephyr: Full fidelity stereo on a single ISDN line. (See Pick Hits.)

Unity 2000i: FM processor

Circle (1033) on Reader Service Card

Tentel

Tip projection gauge: electronic digital unit; also measures drum eccentricity.

Betacam related: video training tape and repair/maintenance gauges.

Circle (1034) on Reader Service Card

TFT Inc.

9100S, 9107: composite aural STL transmitter, receiver; combined FM stereo generator with audio processor in transmitter; direct L/R audio, SCA injection inputs; receiver features optional stereo decoder with L/R outputs.

IF interface: STL system.

DMM-92: digital STL for spectral efficiency.

Model 9200/9205: monaural frequency-synthesized, field programmable STL; VLSI design; 70dB SNR at 22kHz FM deviation.

Circle (1035) on Reader Service Card

Theatre Service & Supply

Product line includes: Studio furnishings, studio cyclorama curtains, track systems; scenic supplies, grip equipment.

Circle (1036) on Reader Service Card

Thermodyne International

Smooth wall cases: strong, highly durable with streamline appearance; foam inserts fabricated to specific requirements.

Circle (1037) on Reader Service Card

Thomson Broadcast

PIXTORE: still-store; 386 Windows-based; operates with DIANA server for 525/625, 4x3, 16x9 format pictures; Bellevue interface card; Ethernet LAN tie to ISDN; ISO/IPEG compression.

BELLEVEUE: PC 16:9 display card for 386, 486 PCs; replaces VGA card for 24-bit color images under Windows 3.1; JPEG data compression.

TTV5651 SYNONYM: 4:2:2 component digital video production switcher.

TTV 5790, 5791, 5775: serial digital routing switchers.

TTV 7160: serial digital DA for D-1, D-2/D-3 signals;

auto EQ to 300m cables.

TTV 1625: combines TTV 1647.S camera head, CA 25 multicore adaptor, CCU 1625, control panel for multicore operation.

TTV 7656: serializer, deserializer; four serial outputs from one parallel input; regenerating loop-through output of serial signals with parallel signal; input EQ; D-1, D-2/D-3 NTSC/PAL.

TTV 7760 HD: Hi-Doubler image converter; produces 1050-line from 525, 1250-line from 625 inputs; 16:9 or 4:3 aspect ratios.

TTV 7810: standards converter; bidirectional analog composite NTSC, PAL, SECAM, digital composite NTSC, PAL, analog components and 270Mbit/s 4:2:2 digital component signals.

TTV3821/3820: D1 recorders with dynamic tracking; optional slow-motion; serial digital I/O; 525/60 and 625/50.

TTV7710, 7711: Double D1 splitter, combiner; splits analog HDTV signal into two 4:2:2 signals for recording, processing with standard 4:2:2 equipment; recombines finished product to component, RGB output with composite or tri-level sync.

TTV 7400 DIGIPHASE: serial digital signal phasing device.

Circle (1038) on Reader Service Card

Thomson Digital Image/TDI

Metaballs Blob Modeler: for TDI Explore, TDImage 3-D animation, visualization packages; Boolean operations generate smooth holes, cavities with soft edges; optimized number of polygons to create smooth curves; real time model checks with polygon meshing; blending of Blobs and conversion to polygons.

Metaballs Blob Animator: attach blobs or blending groups to skeletons for animation of muscel and joint movement; combine blending groups to create melting objects, moving molecules; view-dependent adaptive subdivision of blending groups for fast, smooth rendering; full control over animation of blending groups.

Pixiscan cartooning: reduces time to create cartoon series in multiworkstation environment; automatic coloring of a series of drawings; exposure sheet with 30 columns of images; scanning for keyboard drawings; auto line closing of outlines; post treatment of images includes anti-aliasing by compression; SGI workstation

Circle (1039) on Reader Service Card

Thomson Tubes Electroniques

Product line includes: RF power devices for terrestrial broadcast applications; HPA, TWT devices for satellite, microwave communications.

TH 10001 modulator: screen-grid technique modifies class of operation of TV transmitter during sync; improved efficiency by 15%; adapts to all Thomson TV tube families.

TH 3754 TWT: 2nd generation device for DBS transmission in 12.2-12.7GHz spectrum; >58% efficiency from 120W tube.

TH 343 tetrode: FM power device to 30kW at 120MHz; 18dB gain; Pyroblot grids; available in TH 18230G cavity circuit.

TH-8467 projection CRT: 9" device for HDTV projectors; P53 green, P56 red, P11 blue phosphors; EM focus; limiting focus of 2,000 TV points per line; dispenser cathode.

TH-3781, TH-3754: Ku-band TWT devices; 55W or 160W ratings with 60% efficiency; weights of 900g.

Circle (1040) on Reader Service Card

Thomson-LGT

Product line includes: Broadcast systems engineering of complete stations and networks world wide; wide range of solid-state and tube transmitters for TV from 1W to 40kW (2x20kW) in Bands 1 to 5, FM from 1W to 10kW.

Circle (1041) on Reader Service Card

3M Pro A/V Products

966: high-performance analog audio mastering tape.

BC-Metal Betacam SP, BC-Oxide Betacam video-cassettes: low drop-out MP videotape.

D-3 composite digital videocassettes.

Coaxial Cable Stripper
FOR CANARE 75Ω BNC CRIMP PLUGS

NEW FROM CANARE



15 Second Quick

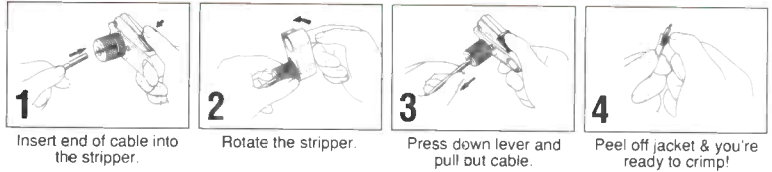

MODEL SELECTION		
Model	CANARE Cable	Others
TS-4C	LV-61S	RG-59B/U
TS-5C	LV-77S	8281

CANARE
511 5th ST., UNIT G SAN FERNANDO, CA 91340
PHONE: (818) 365-2446 FAX: (818) 365-0479

Circle (70) on Reply Card

It can help you measure
both in-house and
outgoing **audio paths.**

It lets you check the
quality of your
incoming **audio feeds.**

DCN D-1 cassette: addition of D-1 shell size to series.

Circle (1042) on Reader Service Card

360 Systems

DigiCart/II: digital audio recorder.

Series 1000: message player.

Circle (1043) on Reader Service Card

Tiffen Manufacturing

Warm Pro-Mist series: filters.

Warm Soft/FX series: filters.

ColorGrad: filters.

EFP Studio/Field filters: clear and UV filters.

Circle (1044) on Reader Service Card

TimeLine

Console Control Unit: keypad on AMS, Euphonix, Neve, Otari, SSL consoles operate TimeLine System Supervisor multitransport controllers interfaced to console automation computers.

Alesis Af2: multipurpose audio-video synchronization interface.

Circle (1045) on Reader Service Card

TM Century

Product line includes: Radio station automation, Digital Commercial System with hard-disk storage.

Circle (1046) on Reader Service Card

TOA Electronics/Digital Mixing Systems

ix-11000: digital mixing system.

Circle (1047) on Reader Service Card

Toko America

VAST-P: video, audio storage and transmission system.

TCD-1000: portable video codec for multimedia teleconferencing systems.

Circle (1048) on Reader Service Card

Torpey Controls & Engineering

Model CLK-50: compact all-digital master clock system.

Dynatel D8800 series: audio/video/cable DAs, switchers, video fader, detector, sync generator.

Circle (1049) on Reader Service Card

Toshiba Corporation

SC-521, -821, -831: CCD color cameras.

HSC-100: CCD color camera.

HDTV digital fiber-optic transmission system.

HDTV System.

Digital SCPC TDM45: digital video compression.

HD-PICOT system: real-time video signal-processing system.

TU2000 series: solid-state UHF transmitters.

TV2000 series: solid-state VHF transmitters.

HSW-1000: HDTV digital video switcher.

Circle (1050) on Reader Service Card

TouchVision Systems

D/Vision V2.1 enhancements: six 44.1kHz audio channels; Targa/PCX overlays; improved SuperTV image quality, animation; 60-hour video capacity; files export as Microsoft Video for Windows, Apple Quicktime, Intel Indeo and WAV audio files.

Circle (1052) on Reader Service Card

Trans Video Electronics

Global SNG/RF-64 and /ISDN-64: self-contained, broadcast-quality portable video news-gathering system.

Circle (1053) on Reader Service Card

TRF Production Music Libraries

New CDs: more than 100 new digitally recorded releases; each contains 75 to 80 minutes of music.

Pyramid Production Music Library: introduced with 11 initial CDs for broadcast, A-V, film applications; Real Country, Real Rock, sports/action, light jazz, light industrial, urban contemporary, Americana, comedy/children, Technopop, solo instruments, jingles.

Circle (1054) on Reader Service Card

Trident Audio

Series 90: 24-bus in-line console; three inputs and 12 switches per module, each with EQ and 12 aux sends; VCA automation is standard for main, monitor fader and optional moving faders on main; 40- and 56-input.

Vector enhancements: LCRS surround-sound pan module; stereo mic/line input, 4-band EQ; 3-way effects return; routing to multitrack, aux, four stereo buses.

Circle (1055) on Reader Service Card

Troll Technology

Touchstar products: master, communications and slave controllers; Trollcam remote tower camera control; Skypod III microwave antenna system.

Circle (1056) on Reader Service Card

Trompeter Electronics

J24WHF: high-frequency serial digital dual coax jack.

Circle (1057) on Reader Service Card

TrueVision

Bravado: multimedia engine; on-board VGA for ISA platforms; full-color video-in-a-window, audio pass-through; Windows 3.0-compatible; 8-bit entry level and 16-bit full-featured versions.

VideoVGA Eight & Sixteen: VideoVGA-8, -8i and -16 graphics engine.

Circle (1058) on Reader Service Card

TSM/Total Spectrum Manufacturing

AutoCam: Network LAN, interconnects two ACP-8000 systems via Ethernet for master/slave operation; MCB-3 vector solving manual control for manual operation; Set Mapping provides collision avoidance.

SP-300/X-Y: enhanced full motion-control pedestal; new wheel design, servo control software.

VS-300P: studio pan/tilt unit.

VS-200M: variable speed, motorized pan/tilt system.

Circle (1059) on Reader Service Card



**SUPERB RANGE
(WITH SUPERB RANGE)**

If you're serious about sound, check out our RMS 2000 range of wireless microphones. Professionally built. Remarkably small. Reassuringly reliable. And with a crystal clear sound quality that makes them the favorite of sound recordists around the world. Contact us now for a demonstration.

Audio Limited USA,
21-36 33rd Road,
Long Island City,
NY 11106.
Tel: (718) 728 2654



**WIRELESS
MICROPHONE SYSTEMS**
Sound Designed

Circle (71) on Reply Card

F I L T E R
P R O B L E M S ?

SEE A SPECIALIST!

- Frequency Range 500KHz to 1.0GHz
- Prices from \$15
- Custom Design Service
- Group Delay and Amplitude Equalisation
- Standard Filters for Video Systems; HDTV; SNG; Antialiasing; Data Pulse Shaping

WE'LL HELP WHATEVER THE PROBLEM



FARADAY TECHNOLOGY
Faraday for Filters

CROFT ROAD INDUSTRIAL ESTATE NEWCASTLE STAFFS ST5 0GZ ENGLAND
TEL 44 782 661501 FAX 44 782 630101

Circle (72) on Reply Card

TC/Television Technology

10kW FM: solid-state transmitter.

IOT transmitter: restyled, high-performance system.

UHF transmitter/translator: 100W system.

1kW UHF: solid-state transmitter with various power levels, ancillary equipment.

Circle (1060) on Reader Service Card

TV Answer/Consumer Marketing Division

TV Answer: wireless, home-based 2-way system allows viewer response to on-screen broadcast with hand-held remote-control device.

Circle (1061) on Reader Service Card

TWR Lighting

Product line includes: Tower lighting products.

Circle (1063) on Reader Service Card

U

Ultimatte Corporation

MemoryHead: repeatable camera mount for video and film productions.

Circle (1064) on Reader Service Card

Union Connector

DistroBox: complete range of portable power distribution boxes; available from 20A to 200A.

Circle (1065) on Reader Service Card

Unique Business Systems

Product line includes: Productivity, business software; RentTrace rental equipment availability tracking.

Circle (1066) on Reader Service Card

UniSet Corporation

Product line includes: Studio furnishings, sets.

Circle (1067) on Reader Service Card

United Ad Label

Product line includes: Blank, custom printed tape format labels for laser, tractor-feed printers for most audio, video formats.

Circle (1068) on Reader Service Card

United Media

MultiVision System: non-linear desktop video editing studio integrates full-motion video capture, digital scene logging and image viewing.

Circle (1069) on Reader Service Card

UREI

COMP1: compressor/expander module.

CPU1, CPU2: computer modules.

GATE1: gate module.

MINI: mono input module.

OUT1: output module.

P.EEQ1: parametric EQ module.

Circle (1070) on Reader Service Card

USA Digital Radio

Product line includes: in-band, on-channel AM and FM digital audio broadcasting.

Circle (1071) on Reader Service Card

US Tape & Label

Product line includes: Labels, promotion products.

Circle (1072) on Reader Service Card

Utah Scientific

Multichannel: automation systems.

MC-601: digital master control switcher.

Circle (1073) on Reader Service Card

Utility Tower

Product line includes: Tower products/services for AM, FM, TV, microwave and communications.

Circle (1074) on Reader Service Card

V

Valentino Production Music

Product line includes: Production music and

sound effects library packages.

Circle (1075) on Reader Service Card

Valmont Industries

Product line includes: Tower structures, Monopoles to 250 feet, also free-standing and guyed Lattice towers.

Circle (1076) on Reader Service Card

Varian Canada Microwave Products

Jetsat: klystron 24-hour emergency delivery, tube repair and maintenance, bonded storage.

Circle (1077) on Reader Service Card

Varian Microwave Equipment Products

C-band HPA: 3kW unit for wideband, single and multicarrier commercial satellite service; micro-processor control section; local or remote-control panel with menu-driven commands.

Circle (1078) on Reader Service Card

Varian Microwave Power Tube Products

Circle (1079) on Reader Service Card

Varian Power Grid Tube Products

IC-550: input circuit for Klystron IOT; improved phase and amplitude linearity and group delay; high gain across UHF TV spectrum with simplified tuning requirements.

Circle (1080) on Reader Service Card

Varian Traveling Wave Tube Products

Circle (1081) on Reader Service Card

VEAM

VSC Connector Series: threaded coupling multipin cylindrical connector for lighting.

CIR series power connectors: 60A and 100A, 4- and 5-pole, 120/240Vac/Vdc.

B-LOK: 400A, 5-pole sequential mating power distribution system.

Circle (1082) on Reader Service Card

Vega Wireless

Q-600 intercom: split-band UHF/VHF wireless system.

RMT-14 wireless IFB: 4-channel transmitter with PL-2 2-channel mini-bodypack IFB receivers.

Sub-mini RSX-7: lavalier mic with choice of Lemo LM210 or mini XLR/Tini QC LM-210x connectors.

Circle (1083) on Reader Service Card

Vertex Communications

Product line includes: Design, engineering, manufacturing of earth station antennas and related components; tracking control systems; dual-reflector antenna systems (1.8m to 32m) for C-, Ku-, X-band frequencies, some L-band; turnkey installations, site testing, maintenance services.

Circle (1084) on Reader Service Card

Vertigo Technology

Meta Balls: modeling software.

Effectors: modeling and animation tools.

Circle (1085) on Reader Service Card

VG Electronics

VGE 1076 series: Slimline RDS coders; entry-level, display and non-display versions; supporting AF, DI, MS, PI, PS, PTY, TA and TP protocol; dynamic and static RDS messages.

VGE 1079: RDS receiver decoder; supplied with PC software to control receiver functions and provides RDS data displays, including views of Tuned Service data, EON references and histograms.

VGE 1078M: RDS monitoring decoder.

Circle (1086) on Reader Service Card

VGV Inc.

DX60: composite digital downstream keyer; features auto/manual timing; six inputs, integral color bar generator, key memory.

Digital D2500: composite digital production switcher; D-2-, -3- and analog-compatible.

CV2: component digital switcher.

Continued on page 117

It can initiate tests
across analog, digital
and multimedia links.
All at the
push of a button.

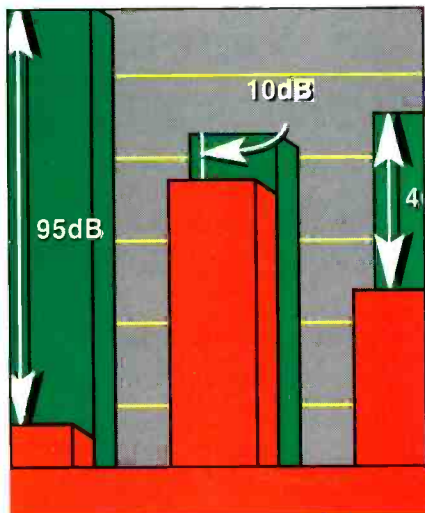

On-air audio processing

Understanding the listener's environment is essential to proper use of today's processing.

By Skip Pizzi, technical editor

The Bottom Line

The last chance a radio station has to help its signal sound better is at the broadcast audio processor. Instead, many of these attempts turn out to be hindrances. This is perhaps the most ongoing subject of controversy in radio, and one that is ultimately unanswerable. New processing hardware can help, however, with improved audio quality and control. Knowing what the listener needs also is a key ingredient, as this month's look at radio retrofitting explains.



In the beginning, there was AM, and its modulation level begat its coverage. Therefore, the people called for a device to save them from the perils of low modulation, and lo, the audio processor was brought forth from the loins of amplifiers. Its adjustments were mightily tweaked, so that it kept the station loud and its coverage strong. And broadcasters saw that it was good...

That bit of history set the tradition for much of what was to follow in radio. When FM came along, however, the loudness = coverage equation was broken, and more kinds of "good" music could be successfully broadcast on the higher fidelity medium. This caused some FM stations to apply little or no audio processing to their air signal. Yet broadcasters soon discovered another reason for reducing the dynamic range of some signals, which the AM processing had previously (although inadvertently) taken care of: Audio programming had to be matched to the environment in which it was heard.

Radio also transformed its service to the user in those years, primarily because of the advent of television. Changing from a medium that people listened to actively, radio became an accompaniment to other activities in the home. Meanwhile, mobile listening also increased dramatically. Both of these trends put radio into increasingly narrow dynamic range environments, as background noise levels increased and smaller radios provided lower maximum listening volumes. Although today's quiet homes and audiophile systems can provide a stunning dynamic range for audio repro-

duction, most radio programming is not heard this way. Cars also have become quieter, with improved sound systems, but even a best-case, car-listening environment has relatively small dynamic range. (See Figure 1.) Therefore, the need for appropriate audio processing in radio broadcasting remains.

The key word is "appropriate"

Figure 1 shows that the dynamic ranges within which radio is listened to are somewhat diverse. Broadcasters must choose a singular processing scheme that works everywhere, however. Based on this data, an appropriate one-size-fits-all maximum dynamic range for radio might be set at approximately 25dB.

Yet a strange paradox of extremes has developed during the last decade or so in FM audio processing styles. At one end is the purist contingent, which takes a hands-off attitude to processing, while the other side attempts to squash every last decibel out of their dynamic range in pursuit of ultimate loudness. The latter folks generally work with musical formats that are already limited in their dynamic range (often far less than 25dB). The purists play wide dynamic-range music (typically exceeding 25dB). By this analysis, the heaviest audio processors are often the ones whose program material needs it the least. The purists who reject processing are the ones who need it the most — a truly bizarre misapplication of technology.

For example, most pop music played back from a cassette in a car can easily be set at a single, comfortable volume.

However, a classical cassette might require frequent volume adjustment. This argues that a pop radio format needs little additional processing, but a classical or news/talk format could benefit from some dynamic range reduction.

In addition to the overapplication of processing, the reduction of dynamic range has obtained its evil reputation among the purists based on technology that has largely been surpassed. Earlier single-band devices' pumping and breathing have been replaced by adaptive, multiband and programmable systems that allow significant dynamic range reduction without traditional artifacts. Compression doesn't have to be the C-word at the radio station anymore. A properly set temporary processor can constrain such wide-range audio as classical music or speech to an appropriately narrow dynamic range and still provide a satisfying listening experience. For such formats, too little processing can be worse than too much under many listening conditions.

New audio processing technology

The current state-of-the-art in broadcast audio processing incorporates

digital technology. The greatest advantage of digital systems in this application is not in digital audio but in digital control. Many of the best audio processing devices maintain high-quality analog sections in some or all of their signal paths, but incorporate digital control systems throughout. User-friendly, wide-ranging control functions on these devices enable a station to carefully contour its processing and develop a signature sound.

Such systems also allow the simple implementation of another important technique called daypart processing. It provides different types of audio processing during different times of the broadcast day. These changes may reflect different programming types (a morning news/talk block followed by a midday music block, for example) or simply different listening habits (narrow dynamic range during drive time with wider range during late night). The processor's internal clock can affect the changes or external control can be used.

Other external control features for the new breed of audio processors also are popular. PC control via modem is typically offered, so a processor's placement at the trans-

mitter site is no longer a significant handicap. A PC at the station (or in a staffer's home, or even a laptop-plus-cell-phone/modem in a car) can be used to access complete control of an audio processor (under password protection). This allows the processor to be adjusted and checked in real time using real world listening environments. Multiple settings can be stored in memory and A/B compared under various listening conditions. The audio processor's manufacturer supplies remote-control software for control and display on the PC.

How to proceed

If your station is still using the same processing equipment it did 10 years ago (perhaps even five years ago), it's time to revisit the rack. Obtain demos of several new devices and compare them to your current system. (Chances are you won't need the same amount of rack space you're using now to accommodate the new systems.)

Take advantage of this evaluation period to consider the sonic improvements of new hardware as well as your processing philosophy. Ultimate loudness no longer needs to be the goal of any format. Ambient conditions dic-



SONEX!
NEW PRODUCTS.
NEW APPLICATIONS.
NEW BROCHURE.

*Send
for your
FREE
copy today!*

illbruck
Minneapolis, Minnesota
1-800-662-0032

Circle (73) on Reply Card

It's automatic, lightweight
and **incredibly**
easy to use.

It goes **wherever**
you need to take it—in the
studio and **in the field.**

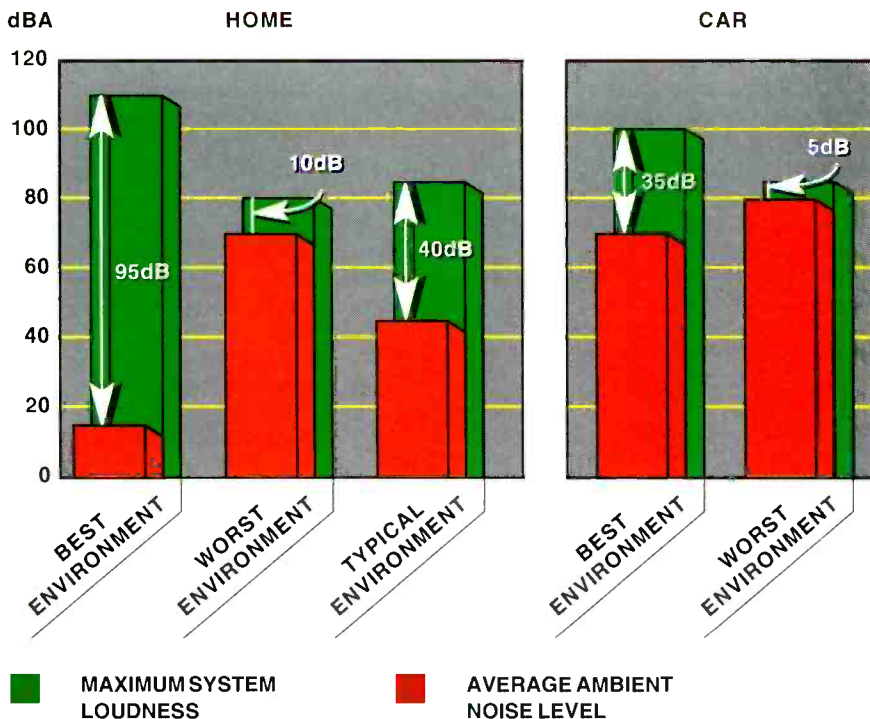

Figure 1. Dynamic range of home and car environments is determined by the difference between maximum audio system loudness and average background noise levels.

tate the need for processing, but today's audio hardware and packaged software continues to drive the tastes of the consumer upward. Sloppy and excessive processing has no place in today's radio market, nor does minimalist processing on the wide-range music that CD releases allow. Use real world listening habits and environments as a guide, and then adjust to taste. Most new processors

Audio programming has to be matched to the environment.

include a number of factory presets for various formats that can provide starting points for this analysis. Consider daypart variations on your processing theme.

Finally, consider how a processor can be more tightly integrated into your facility. Explore its connectivity and how you might use it to your benefit, immediately and in the future.

➔ For more information on broadcast audio processors, circle Reader Service Number 300.

UHF Full Duplex Wireless Intercom System



UP TO 12 FULL DUPLEX CHANNELS

Four independent wireless channels in each base station, with local audio level controls to balance voice levels. Expandable to 12 channels — all can operate simultaneously.

OPERATING RANGE TO 2000 FEET

Get a large, interference-free working area of up to 2000 feet from belt-pac to belt-pac. The Series 800 uses the less-cluttered UHF frequencies and a tone-coded security system for extra protection.

HANDS-FREE OPERATION

On each belt-pac, choose hands-free "Lock" for continuous operation or "Push-To-Talk" for less frequent communications.



CABLED INTERCOM INTERFACE

Interfaces to 2-, 3- and 4-wire cabled intercom systems, with a switchable disconnect.

RECHARGEABLE OR ALKALINE BATTERIES

Get up to 10 hours typical operation in Push-To-Talk mode from a rechargeable battery pack, or 15 hours from AA size alkalines. The base station operates from 115/230 VAC or 11-30 VDC.



Get the new performance standard for wireless communication. Call HME today.

Circle (74) on Reply Card

Continued from page 113

DX300: composite digital vision mixer.
DX120: composite video mixer.
Circle (1087) on Reader Service Card

Vicon Industries
Vectorcam: pan-and-tilt drive.
V7000C: manual desktop controller.
V7070C: manual rack-mount controller.
V7100C: programmable desktop controller.
VM506-2X3RM: triple-monitor system.
Circle (1088) on Reader Service Card

Video Accessory
SG-2: gen-lockable RS-170A blackburst and sync generator.
Circle (1089) on Reader Service Card

Video Associates Labs
AudioPort: external digital audio adapter; plugs into parallel port of PC under DOS/Windows for recording, playback; software-selectable sampling rates (4kHz to 44.1kHz); ADPCM 3:1 compression.
Circle (1090) on Reader Service Card

Video Central
Product line includes: Distributor for video products; utility devices, Optex mini image intensifier and camera surface splash bags.
Circle (1091) on Reader Service Card

Video Communications
STARS II: multi-user software; supports hundreds of simultaneous users on PC LAN; compliant with IBM's CUA standard.
Circle (1092) on Reader Service Card

Video Data Systems
System 840: menu-driven color message system; stores 100 pages with battery backup; 16 colors for

text, backgrounds; 50ns resolution with three fonts; RS-232 remote interface.

Circle (1093) on Reader Service Card

Video Design Pro
VidCAD Ver. 6: cable documentation, design software; for diagrams, 3-D rack drawings, floor plans; based on AutoCAD R12.

CableDOC Manager: cable documentation software without CAD; menu-, icon-driven; creates single, multipair wiring data, jack, terminal block front-panel drawings, router designs, cable labels, lists.

Circle (1094) on Reader Service Card

VideoFusion Ltd. Partnership
VideoFusion 1.5: Upgrade to its digital video effects software for QuickTime post-production. 10% speed improvement and broadcast-quality output (to ship this month).

Circle (1095) on Reader Service Card

Video International Development
SRC 5000: graphics scan converter.
DTC 4500: motion vector standards converter.
DTC 1004, DTC 1504: 4-line, digital TV standard (singular) converters.

DTC 3604 - multi-standards converter.
Circle (1096) on Reader Service Card

VideoLab Para Technologies Trust
Logichron: multitasking high-performance time code processor.

Circle (1097) on Reader Service Card

Videomagnetics Inc.
TD-5, CDS-2500, CDS-3500: tape degaussers.
Circle (1098) on Reader Service Card

Video Matic USA
Information not available.
Circle (1099) on Reader Service Card

Videomedia
ALIX: V-LAN-compatible stand-alone module for

animation and video editing control of serial-only devices from Macintosh or UNIX operating systems.

OZ: video editing software for Microsoft Windows and Macintosh; uses V-LAN network for frame-accurate A/B roll editing on the desktop.

Auto-PICT QT: animation software records and captures PICS, PICT files and QuickTime movies to/from videotape/disk.

V-LAN-CX: compatible module supports prosumer VTRs and camcorders for desktop video applications.

Circle (1100) on Reader Service Card

Videoquip Research
DA-24: 1-input/24-output video and stereo audio distribution amp for duplication facilities.

RS-6400: broadcast-quality audio/video routing switcher matrix system.

BG-2 generator.
SD-2 silence detector: for two independent channels of detection; adjustable silence level -40dBm to 0dBm.

VP-2 VU/PM meter: 2-channel unit; separate extended range displays cover -40 to +22 VU or PPM.

VU, PPM meter.
MP-2 mic pre-amp: 2-channel package; 2 outputs per channel with independent gain adjustments.

Circle (1101) on Reader Service Card

Videotek
Omniframe: versatile rack-mount frame to accommodate 10 modules; video, audio, pulse DAs, sync or test signal generators all reside in universal frame simultaneously; eight outputs per DA.

S-2000: System Auto-Measure product; performs automatic test of RS-170A, FCC (broadcast transmission), FCC (CATV distribution), NTC-7, RS-250C, common NTSC measurements; controlled with PC interface.

TVM-675: combination waveform monitor, vectorscope for composite and component analog

Continued on page 122

SOURCE

OF
 ADC
 AND

TROMPETER

- Competitive Pricing
- Large Stock
- No Minimum Order
- Fast Delivery

CONNECTORS • TOOLS
 CUSTOM CABLE ASSEMBLY
 PATCH PANELS

MileTek™
 1-800-524-7444

Circle (75) on Reply Card

In fact, there's **only**
one thing this
remarkable test
generator doesn't do.

Cost a lot of

money.

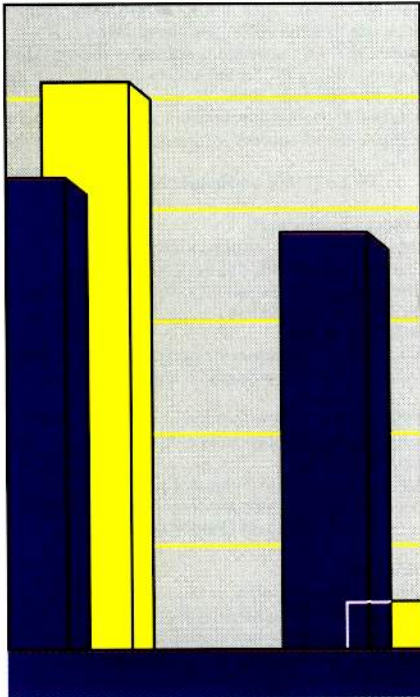

Developments in magnetic tape

Improvements and adjustments continue in the world of magnetic tape.

By George McBride

The Bottom Line

Magnetic tape is the original erasable and editable recording medium. Although many other formats have come along, magnetic tape still flourishes as a preferred method of storage for audio and video recordings. During the last decade, tape has made the switch to digital recording and remains the most cost-effective mode of long-form program storage. Continuing developments guarantee that magnetic tape will endure for years as a viable format for video and audio storage.

S

When magnetic recording was developed by the Germans during World War II, the tape they used was literally a ribbon of acetate with a layer of finely powdered rusted iron filings sprinkled on a layer of adhesive. Those recordings, originating in 1938, are still capable of fairly respectable reproduction.

Yet, the performance of today's magnetic tapes is astonishing when compared to these WW-II vintage recordings, thanks to the continuing advances and refinements in tape formulation and manufacturing.

An overview of the tape manufacturing process

Perhaps today's tape manufacturing's greatest differences from those early days comes in terms of tolerances and precision. For example, to minimize the possibility of extraneous contamination to tape during its manufacture, the entire process is enclosed in extremely hygienic *clean rooms*. These are similar to hospital operating rooms, except that the clean rooms are even more painstaking in their hygiene. The clean room is designed to minimize airborne contamination rather than bacteria.

People who work inside the clean room must wear a uniform that covers their entire body except for their nose and eyes. When they enter, they pass through an air shower to remove any contamination from the uniform. Workers in the tape-coating area wear a static-free uniform and shoes along with a mask.

Metal particulate tapes

The manufacturing process begins with chemical chefs cooking up a nasty-looking concoction that resembles the dregs from an engine crankcase long overdue for an oil change. This substance is referred to as the *magnetic paint, mix or coating*.

The coating mix is called paint because it is literally painted onto a plastic ribbon (base film). The primary ingredients of the coating are magnetic particles, binder, self-cleaning components, lubricants and other fillers necessary in most magnetic tape.

The performance of today's magnetic tapes is astonishing, thanks to continuing advances and refinements.

The binder is a plastic compound that links itself with the plastic material of the base film at the molecular level to form the strong and flexible magnetic tape used in most of today's recording formats. The critical nature of the binder makes it the most proprietary and confidentially held component of a coated tape.

Dispersion

Because certain components of the coating tend to cluster together, it is

McBride is manager of engineering and technical support for Maxell Corporation of America, Fair Lawn, NJ.

Introducing
SIATMAX
 the go **everywhere**
 do **everything**
 audio test generator
 from **Schmid**



The biggest thing in audio testing now fits in the palm of your hand. Introducing SIAT-MAX, the fully portable, hand-held, automatic audio test generator from Schmid.

Weighing in at less than a pound, this self-contained, battery-powered unit, used in combination with a Schmid measurement receiver, gives you a remarkably versatile, practical audio testing tool.

Use SIAT-MAX to initiate fast, accurate audio tests prior to receiving incoming feeds — it's so easy to use, even a reporter in the field can handle it.

Use SIAT-MAX to insert test tones anywhere in-house — whether you need to test the path from your demodulator to distribution switch, or from studio to transmitter.

Use SIAT-MAX to check a line after you've installed new equipment. Or use it to troubleshoot in the field, without lugging complex, bulky equipment, and without having to send a highly skilled technician.

Use SIAT-MAX with a measurement receiver to monitor frequency response, signal-to-noise ratio, THD, crosstalk and every other key audio parameter.

Most of all, use SIAT-MAX to save money, reduce man-hours, improve testing accuracy, increase testing frequency and make the whole process as simple as it can be.

But with all the things SIAT-MAX does, there *is* one it doesn't: Cost a lot of money. The SIAT-MAX audio generator finally makes advanced audio testing affordable.

Which all goes to show, good things do indeed come in small packages. When they come from Schmid, the worldwide leader in audio testing solutions. For a free SIAT-MAX brochure, call **800-438-3953** toll-free today.



SIAT-MAX works in tandem with Schmid measurement receivers to give you a complete, low-cost audio testing solution.



SZ Schmid
 Telecommunication
 Intelligent by design

U.S. Headquarters
 Schmid Telecommunication America, Inc.
 5 W. 26th Street, New York, NY 10010
 Tel: 212-213-2099 • Fax: 212-779-7305

U.S. Sales and Service
 Schmid Telecommunication America, Inc.
 7249-B Browning Road, Pennsauken, NJ 08109
 Tel: 609-663-0228 • Fax: 609-663-0864

Circle (76) on Reply Card

necessary to disperse them and maintain their detachment during the coating process. This is achieved in specialized devices called *sand grind mills* or *ball grind mills*, which resemble large tanks where the mix is blended. An agitation process similar to that of a paint store mixer is used, but with action that is much less turbulent. These mills contain a specialized material that precipitates uniform dispersion of the various components' clusters, while thoroughly blending all of the ingredients of the formula.

Once the coating mixture is properly blended, it is pumped to the coating machine where it is applied to the surface of clear plastic polyethylene terephthalate (PET) or the stronger polyethylene naphthalate (PEN) base film. Base film is configured in a *web* or *jumbo* — a wide, long roll of plastic. A coating machine deposits a thin magnetic coating at a uniform thickness onto the web.

Under a microscope, the surface of freshly coated magnetic tape resembles a moonscape, with peaks and valleys resulting from the coating process. *Calendaring* is a subsequent process that irons peaks down on the magnetic surface of the tape. The tape is compressed between two large and extremely hot rotating drums under several tons of pressure. These drums are ground and polished to an extreme flatness and smoothness. Calendaring is typically quite effective at flattening the tape surface. The degree of flatness on the tape's surface helps deter-



Coating line control room at a tape manufacturing plant. Note the clean-room uniform worn by operator.

mine the abrasiveness of the tape.

Abrasiveness

The abrasiveness of a tape (abrasivity) is an important element of tape formulation. It translates directly to head wear, which correlates to dollars-per-hour in operational costs.

Tape manufacturers could easily manufacture a tape with practically no abrasivity. Such tapes would immediately clog the heads of a recorder, particularly those using rotating heads, because any debris deposited on the head (from tape shedding or other environmental sources) will quickly accumulate and prevent proper tape-to-head contact.

Therefore, to keep the gap area of the heads clean, an abrasive material must be added to the coating formula before mixing. The ideal tape formulation will maintain the optimum balance between desirable head-cleaning

action and an undesirable amount of head wear. For example, when the D-2 format was in its infancy, some early products contained moderately elevated abrasion properties to deter head clogging, which was considered the worst possible tape defect at that time.

Since then, the format has matured, and improved video head designs and materials have been implemented, lowering the likelihood of head clogging. Many D-2 tape products have been revised to reflect these changes in the current equipment, particularly in terms of lower abrasiveness. (See Figure 1.)

One way to accomplish this lower abrasiveness without actually changing the tape formulation (and risking an unwanted alteration of a tape's magnetic properties) involved an adjustment of the dispersion process described previously. By increasing the dispersion of the ceramic fillers (i.e., spreading them more evenly apart), the abrasivity of the tape was lowered and the head wear reduced, while other elements of the tape's performance remained the same.

Slitting

Slitting the web is usually the final step in the magnetic tape manufacturing process. This step cuts the wide web of coated plastic material into ribbons for the desired tape widths, using pairs of rotating blades that the tape passes between.

The slit tape ribbons are then wound onto separate plastic hubs to produce pancakes of tape. The tape on these pancakes is later loaded into reels or cassettes.

Conclusion

This overview barely scratches the surface of the processes involved in making magnetic tape, but it addresses some of the most critical areas of its manufacture.

Meanwhile, magnetic tape technology continues to improve. Today's products are significantly advanced beyond those of 10 years ago, and growth will continue. Tape manufacturers maintain constant ongoing R&D programs to improve current products based on accumulated experience, and to develop high-quality and reliable first-generation products for new formats.

➤ For more information on magnetic tape, circle Reader Service Number 301.

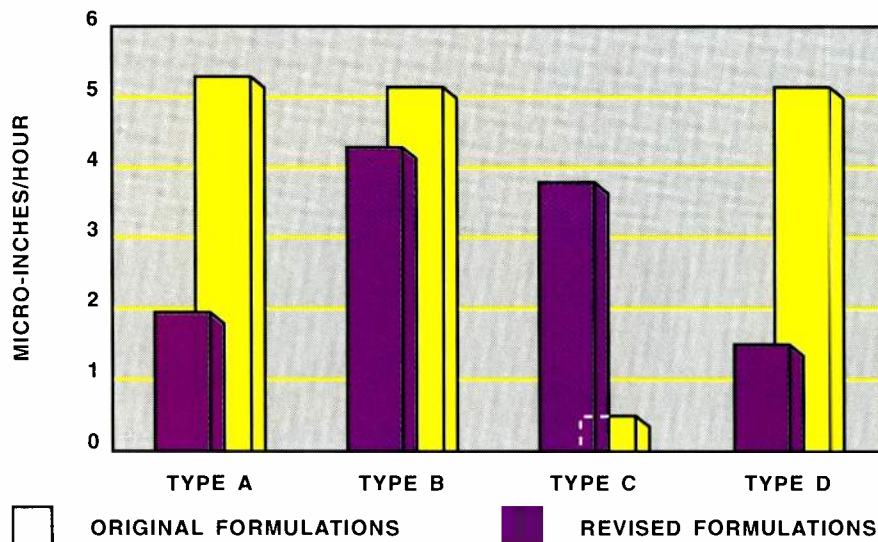

Figure 1. Abrasiveness of four manufacturers' D-2 tapes, comparing their initial offerings (late 1980s) to their current ones (after mid-1991). Abrasiveness is quantified in terms of headwear, in micro-inches per hour.

NEW

FROM



DIGITAL AUDIO ANALYZERS

CRL's digital audio analyzers will provide you with comprehensive analysis of your digital signals.

DAA-50

Clip it to your belt and go!



The DAA-50 contains a high quality digital to analog converter so you can monitor the audio through headphones with a fully adjustable volume control. The DAA-50 tests for a variety of information about your digital audio signal and identifies the information through easily defined LED status indicator lights. Compact and lightweight, the DAA-50 can be used when and wherever it's needed. Clip it to your belt and go!



- Comprehensive Analysis
- Hand-held, Compact, Go Anywhere
- Battery or AC Powered
- Reliable, Easy to Use

DAA-100

It's a Generator & Analyzer in one!

The DAA-100 is a complete digital audio path analyzer and digital audio test signal generator. The DAA-100 generates both analog and digital audio waveforms. The digital audio test signal generator is a powerful tool for designing and troubleshooting both analog and digital systems. The DAA-100 can also give you complete analysis of your digital audio link. An easy to use menu system converts all information into an easily read format and outputs it on a large LCD display. Output the recovered analog audio to either an internal speaker, headphone connector or high quality output for measurement. The DAA-100 is a hand held complete digital audio analyzer/generator for digital audio testing. Use with your existing Analog tester to make a complete integrated analog/digital test system.



- Generates AES/EBU Digital Signals
- Generates Analog Audio Signals
- The Digital Adapter to the Analog Test World!



THE
PROFESSIONAL'S
CHOICE



Circuit Research Labs, Inc.
2522 West Geneva Drive
Tempe, Arizona 85282-3192 U.S.A.
(800) 535-7648 (602) 438-0888
FAX (602) 438-8227

It's lower,
lighter and
you can buy
about 2 for 1
of theirs!

Miller 25 -

Bridging the gap between performance and value. For television news support or corporate/industrial studio.



MILLER FLUID HEADS (USA) INC.
410 Garibaldi Avenue
Lodi, NJ 07644 U.S.A.
Tel: (201) 473 9592 Fax: (201) 473 9693

MILLER TRIPODS CANADA
1055 Granville Street
Vancouver, BC V6Z 1L4 Canada
Tel: (604) 685 5331 Fax: (604) 685 5648

Circle (78) on Reply Card

Continued from page 117

video; stereo audio phase, level measurements.
APM-800: hi-fi 8-input audio program monitor.
Circle (1102) on Reader Service Card

VIDESSENCE

Location Series: three models — 100W to 300W; rugged; low-power consumption; cool operation.
Circle (1103) on Reader Service Card

Vinten Broadcast

Vision SD-12, -22 heads: pan-and-tilt systems with serial drag.

Vision tripods: carbon-fiber and aluminum tripod with Torque Safe self-adjusting leg lock.
Circle (1104) on Reader Service Card

Vision 1250

Information not available.

Circle (1105) on Reader Service Card

VistaCom

VCI/OEM Boards: video codecs with open architecture; made for OEM applications; complete range of CCITT standards.

VCI/CP Board: adapts video, audio and data from multiple sources and transmits the combined data over digital telephone network with sync and forward error correction information.

VCI/DCT Board: plugs into industry standard PC/AT bus or ISA bus; supports full-CIF image resolution of 288x352 pixels.

VCI/AC16 Board: universal audio codec; performs 16kb/s audio coding specified by CCITT AV.254.

VCI/NI Boards: family of network interface modules supporting the H.261/H.221 VistaCom video codecs.
Circle (1106) on Reader Service Card

Vistek Electronics

D 8001: component digital production switcher; 4:2:2 serial I/O, 8 prime inputs; automatic timing; two key layers with priority exchange, chroma-key with upsampld processing.

V4301 framestore: 525-line version of V4301 PAL product; digital system with analog component interfaces.

Autotran automation control: uses PC with Windows and RS-422 serial interface to control 32 devices through Vistek 3400 machine controller.

V2000 Array series: routers for analog video V2200, audio V2300, digital video V2100.

V1200 series: serializer, deserializer products.

Noise reducer and aperture corrector: for Vector standards converter.
Circle (1107) on Reader Service Card

Vizual Inc.

ScheduALL: schedules equipment, personnel, facilities; takes client requests from bidding through billing; modular system for a single user or networks.

VER 3.5: modules include library and labeling system, bidding, project management, Accounts receivable, Production Reports modules, personnel manager.
Circle (1108) on Reader Service Card

Vortex Communications

MADH-II: high-definition intermatrix converters.

VX-8000: Modular video, audio and data routing switchers.

PPM-200: audio monitoring systems.

VX-1100: modular rack system for Eurocard modules.

CK-100: linear component, multichannel keyer.

Logo 3: high-resolution 24-bit color logo generator.
Circle (1109) on Reader Service Card

VTE

Information not available.

Circle (1110) on Reader Service Card

VVYX National Video Network

Product line includes: Switched fiber-optic TV transmission services.
Circle (1111) on Reader Service Card

Walter Brewer Corporation

Product line includes: Design, engineering, installation of studio lighting systems; power distribution equipment.
Circle (1112) on Reader Service Card

Ward-Beck Systems

RENAISSANCE series: modular audio consoles; solid-state switching, VCA control, automation-ready for live assist; compact package integrates with desktop environment.

DAs: remote sensitivity DA; stereo DA; full compatibility with existing line and may be fitted in combination with them in MF-82 rack frames.
Circle (1113) on Reader Service Card

Wavefront Technologies

Rotomation: software for real-time rotoscoping effects.

COMPOSER, Visualizer Paint: enhancements to 2-D products.

Dynamation: 3-D animation tool for interactive creation of realistic images of mycrodynamic events.

Kinemation: 3-D animation software.
Circle (1114) on Reader Service Card

WavePhone

TVTI: high-speed data broadcast device.
Circle (1115) on Reader Service Card

Wegener Communications

DR95, 96: digital audio SCPC receivers.

Series DR180, 185 and 190: digital audio subcarrier receivers.
Circle (1116) on Reader Service Card

Westcott/The F J Westcott Company

Collapsible scrims and flags: easily interchangeable fabric covers.

Collapsible silks and solids for Illuminator line: square and rectangular, reduce to hand-held circles that open with the flick of a wrist.

Apollo JS: light modifier; 50" square with recessed front; portable.
Circle (1117) on Reader Service Card

Wheatstone Broadcast Group

Modular studio furniture.

Rack-mount signal processors.

Wheatstone: digital audio hard-disk recorder.

A-6000 master air console: high-end mixer for radio, television.

SmartSelect: computer-controlled audio switcher.

A-6000: compact audio production console; offers more than 125 input module feature combinations; includes Bus-Minus system; can support up to 4 studios through use of 4 mute buses and 4 complete studio outputs.
Circle (1118) on Reader Service Card

Whirlwind/US Audio

Presspower: active press box; two inputs distributed to 16 outputs through XLR connectors.
Circle (1119) on Reader Service Card

Will-Burt

SABER: compact mechanical telescoping mast; most elevation to any height to 30 feet; self-supporting.
Circle (1120) on Reader Service Card

Winsted Corporation

System/90 series: expanded series of high-tech post-production consoles.

Ergonomic series: multimedia workstations for desktop editing systems; recessed monitor well, adjustable shelves.

1993 video furniture catalog: includes 132 pages of furniture products and accessories for the video and securities industries; also includes products for computer graphics and multimedia use.
Circle (1121) on Reader Service Card

Wireworks

G5/160i: connector standard for pro use in audio

cabling systems up to 52 channels.

TEN-4: speaker cable tester tests speaker cable assemblies terminated with Neutrik NL4 connectors and phone plugs.

BROADWAY Latching System Option (BLS): for pro stage use; installs on male and female sides of mating-pair connectors; eliminates protruding latches.

Circle (1122) on Reader Service Card

Wohler Technologies

AES/EBU digital input option: for AMP-1A, AMP-2 monitor speakers; allows direct acoustical monitoring of digital audio sources.

MSM-2 series: visual audio indicators; up to 20 channels of 60dB-level metering in 2-rack-unit space.

Circle (1123) on Reader Service Card

Wolf Coach

Model 450Bx: design for SNG provides more truck in a smaller package.

Circle (1124) on Reader Service Card

Worldwide Industries

Product line includes: Studio furnishings.

Circle (1125) on Reader Service Card

WSI

WEATHERspectrum 9000 1.1: enhanced weather workstation; art, animation features with advanced forecast and analysis capabilities.

Polar Orbiter Satellite Imagery: from POES satellites; 14 orbits per 24 hour.

PRECIP: precipitation estimations for levels of rainfall.

LIGHTNINGplus: lightning information data, imagery.

NOWrad Plus: high-definition radar composites.

NEXRAD imagery: service provides NWS Next Generation Weather Radar imagery.

NOWrad: mosaic radar imagery now incorporates NEXRAD reflectivity data.

Circle (1126) on Reader Service Card

Wybron

MAC-360: multi-attribute controller; 360 control channels, track ball, two wheels; five fixture types — maximum 12 attributes/fixture.

IPS-DB-6003, IPS-DR-2424 Intelligent Power Systems.

AC-100: auxiliary control unit; incorporates a variety of analog controls into its Intelligent Power System or other DMX512-based dimming system.

Circle (1127) on Reader Service Card

Y

Yale Electronics

Product line includes: Connectorized rack panels, YaleFlex audio snake cable, ADAT & DA-88 cable assemblies and digital cable assemblies.

Circle (1128) on Reader Service Card

Yamaha Music

PM4000: mixer in 32-/40-/48-input frames (24-input special order); EQ, variable high-pass filter; eight primary mix buses plus stereo bus.

DMC1000: 24-bit digital mixing console.

CBX-D5: hard-disk recording system; cross-platform compatibility; for Windows 3.1-compatible and Mac and Atari computers.

SPX990: 20-bit multi-effect signal processor with A/D and D/A conversion.

DEQ5 and DEQ5E: digital EQs.

MC2403, -1603, -1203 and -803: mixing consoles.

Circle (1129) on Reader Service Card

Yamashita Engineering Mfg./YEM

RS-1701C: master sync generator; highly stable gen-lock system from composite video, SC signals.

SG-3000B: gen-lock sync generator; 16 test signals.

ENC-3000: gen-lock color encoder; meets EIA RS-170A or EBU standards.

SW-950: compact, low-crosstalk switcher; accepts 4 EWS outputs.

DA-950AT: super wideband video DA for high-resolution CG or HDTV video, sync pulses.

CVS-980 series: scan converters; -980H high-resolution automatic scan converter; -980 with super-wide range of rates from 15-80kHz, including HDTV format; -980 B/W monochrome version.

VSG-2000A: 10-bit digital TV test signal generator.

Circle (1130) on Reader Service Card

Z

Zaxcom

HPC2000: TBC/machine-control system; TBC control, VTR tape transport control.

Circle (1131) on Reader Service Card

Zero Stantron

Duplicator racks: holds 16 or 24 Panasonic AG6840, AG6850 recorders.

Enclosure options: modular, wood trim, all-steel cabinets; 22 colors; pre-assembled.

Preassembled: racks, consoles.

VCAS5639: editing and production console.

VCSF 600: low-profile console.

Fast Rack Series: equipment racks.

Component Series: frames and consoles.

Series 200: vertical racks.

Cabinet frame wedges

Circle (1132) on Reader Service Card

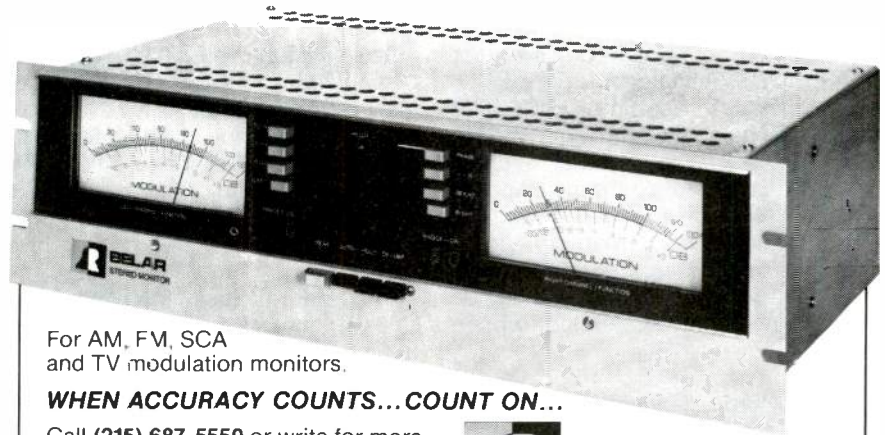

For AM, FM, SCA and TV modulation monitors.

WHEN ACCURACY COUNTS... COUNT ON...

Call (215) 687-5550 or write for more information on Belar AM, FM, Stereo, SCA and TV monitors.



Circle (79) on Reply Card

LINEAR KEYERS

OPAQUE TO TRANSPARENT INSERTS AT YOUR FINGERTIPS

FIVE MODELS WITH FEATURES AND CONTROL SYSTEMS FOR EVERY APPLICATION

- Downstream or stand alone
- Frame accurate mix to key, fade to black
- Serial remote control • GPI interface
- Key source input switcher • Key set memory
- Preview output • Processed black
- Key area masking

MASTERKEY 4
CONTROL PANEL

broadcast video systems ltd.

40 West Wilmot St., Richmond Hill, Ontario L4B 1H8
 Telephone: (416) 764-1584 Fax: (416) 764-7438

Circle (80) on Reply Card

Industry Briefs

BUSINESS SCENE

Ampex Systems Corporation, Redwood City, CA, has delivered a second DCT system to Film and Videotechnik B. Gurtler GmbH, Hamburg, Germany. In addition, Highlight Productions, San Francisco, has installed a DCT 700s post-production switcher and DCT 700i analog interface.

Ampex also has sold two DCT 700d tape drives to Omnicon Video, Sydney, Australia. Another Sydney, Australia-based company, Apocalypse Video, has purchased two DCT 700d tape drives. Broadway Video, New York, has incorporated a DCT 700d tape drive into a new digital component suite scheduled to open in June.

Panasonic, Secaucus, NJ, has installed an AJ-D350 format studio VTR at Audio Visual Transfer (AVT), Atlantic Highlands, NJ. Furthermore, Park Avenue Teleproductions, Richmond, VA, has purchased an AJ-D350 D-3 studio VTR. Panasonic also has sold an AJ-D350 D-3 format studio VTR to The VideoWorks, Westwood, KS.

Panasonic Broadcast & Television Company is the sole supplier of Panasonic Level One and Level Three multilaserdisc players to the educational market. Previously, the corporation's consumer arm, Panasonic Company, had also sold laserdisc products to educational institutions.

Sony, Park Ridge, NJ, has delivered four D-2 composite digital VTRs to WPIX-TV, New York. Sony also has sold a second D-2 suite to Big Shot Productions, Baltimore. In addition, The WPA Film Library has begun transferring the entire British Pathe Newsreel to Sony D-2.

Pioneer, Upper Saddle River, NJ, has sold two V1000 rewriteable videodisc recorders to WSFP-TV/FM, Fort Myers, FL. Nashville Networks, Nashville, TN, also purchased a VDR-V1000 rewriteable videodisc recorder.

Dolby, San Francisco, will supply Dolby S-type noise reduction for use on all of WEA Manufacturing's new analog cassette releases.

Odetics, Anaheim, CA, has delivered a TCS90 cart machine to Nord-

deutscher Rundfunk, a Hamburg, Germany, TV station. Also, Euronews, Europe's first multilingual TV news channels, has purchased two TCS90 cart machines.

Otari, Foster City, CA, has opened a direct sales office in New York City. The office will have direct end-user sales responsibility for Otari's high-tech products, including DTR-900, MTR-100, MTR-90, ProDisk 464 and all console/automation products. The address is 420 Lexington Ave., Suite 300, New York, NY 10170; phone 212-297-6109; fax 212-986-1952.

AEQ, Madrid, Spain, has established a sales, technical service and distribution office in Tempe, AZ. The address is 2211 S. 48th St., Suite H, Tempe, AZ 85282; phone 602-431-0334; fax 602-431-0497.

dbx Professional Products, a division of AKG Acoustics, San Leandro, CA, has named Tom Lee Music Company, Hong Kong, as its dbx distributor in Hong Kong, People's Republic of China and Macau. Syntec International has been appointed as dbx's distributor throughout Australia.

Sony Broadcast & Communications, Hampshire, England, is now providing a commercial conversion service to production companies working with the Sony high-definition video system (HDVS). The Sony High-Definition Facility Europe (SHDFE) uses Sony technology to convert HDVS productions into PAL video format. The service will allow high-definition productions to be broadcast on conventional television.

Avid Technology, Boston, has acquired DiVA Corporation, Cambridge, MA.

Magni Systems, Beaverton, OR, has entered into a joint venture with Great Valley Products to provide desktop video solutions for the PC marketplace. Under the agreement, Magni will design and manufacture a VGA-to-video graphics card, which GVP will market under private label.

Winsted, Minneapolis, MN, has formed a partnership with Winsted Japan for the sale and distribution of Winsted products in the Japanese market. ■

Advertising sales offices

NEW YORK, NEW YORK

Gordon & Associates
210 President Street, Brooklyn, NY 11231
Telephone: (718) 802-0488
FAX: (718) 522-4751

Joanne Melton
Telephone: (212) 332-0628
FAX: (212) 332-0663
888 7th Avenue, 38th Floor
New York, NY 10106

CHICAGO, ILLINOIS

Vytas Urbonas
Telephone: (312) 435-2361
FAX: (312) 922-1408
55 East Jackson, Suite 1100
Chicago, IL 60604

SANTA MONICA, CALIFORNIA

*MC² Magazine Communications
Marketing Corp.*
Jason Perlman
501 Santa Monica Blvd., Ste. 401
Santa Monica, CA 90401
Telephone: (310) 458-9987
FAX: (310) 393-2381

ENCINO, CALIFORNIA

Duane Hefner
16820 Ventura Blvd., 2nd Floor
Encino, CA 91436
Telephone: (818) 386-0630
FAX: (818) 986-5454

OXFORD, ENGLAND

Richard Wooley
Intertec Publishing Corp.
Unit 3, Farm Business Centre,
Clifton Road, Deddington,
Oxford OX15 4TP England
Telephone: (0869) 38794
FAX: (0869) 38040, Telex: 837469 BES G

TOKYO, JAPAN

Mashy Yoshikawa
Orient Echo, Inc., 1101 Grand Maison
Shimomiyabi-Cho 2-18
Shinjuku-ku, Tokyo 162, Japan
Telephone: (03) 235-5961
FAX: (03) 235-5852
Telex: J-33376 MYORIENT

FREWVILLE, SOUTH AUSTRALIA

John Williamson
Hastwell, Williamson, Rep. Pty. Ltd.
109 Conyngham Street
Frewville 5063, South Australia
Phone: 799-522, FAX: 08 79 9522
Telex: AA87113 HANDM

CLASSIFIED ADVERTISING OVERLAND PARK, KANSAS

Renée Hambleton
P.O. Box 12901
Overland Park, KS 66282
(913) 967-1732

Professional Services

East Coast Video Systems

ON-LINE IN-TIME

A full service Company providing...

- Consultation
- Engineering & Design
- Installations
- Training

Serving...

- Cable Systems
- Corporate Facilities
- Broadcast Facilities
- Teleproduction Facilities

52 Ralph Street, Belleville, NJ 07109 (201) 751-5655

NETCOM

STATE-OF-THE-ART ENGINEERING FOR AUDIO & VIDEO

**TURN-KEY SYSTEMS
DESIGN & DOCUMENTATION
EQUIPMENT SALES
CAD SERVICES**

1465 PALISADE AVE., TEANECK, NJ 07666 / (201) 837-8424

JOHN H. BATTISON PE.
CONSULTING BROADCAST ENGINEER,
FCC APPLICATIONS AM, FM, TV, LPTV
Antenna Design, Proofs, Fieldwork
2684 State Route 60 RD *1
Londonville, OH 44842
419-994-3849

Classified

FOR SALE

USED EQUIPMENT. Used Newstar I hardware for sale. If interested, please call SOFTECH SYSTEMS, INC. for equipment list. 1-800-527-6397. (6-93-1)

LEARN HOW YOUR GOVERNMENT TREATS ITS CITIZENS. True life, 10 year experience of man applying for FCC license. GRINDING DOWN shows what can happen when common sense is replaced with red tape. FREE DETAILS. Pepper Schultz Publishing, 527-10th St., Suite 3006, Sparks, Nevada 89431. (6-93-1)

POTOMAC AG-1 Audio Generator / AA-51 Audio Analyzer Test Set in A-1 condition \$2,750.00 plus U.P.S. Jose Fernandez; Box 3047, Bayamon, P.R. 00960. (6-93-1)

SONY 1 INCH BVH-2000, 1100A w/Warranty. Betacam, Cameras, TBCs, Decks, Monitors, or call for replacement parts. Refurbished slant guide assemblies — \$150. We buy clean, late-model equipment. (609) 786-1709. (215) 836-7669. (6-93-1)

"TWO SCALA SL-8" Omni-Directional Low Power TV Antenna 300 watt Ch-67 and Ch-69, excellent condition, \$1,000.00 EACH. Contact Mark 916-246-8782.

ADVANCED SCA DEMOD CARDS — Set to frequency. Widely used by the broadcast industry — \$19.95. Professional SCA radios now available. SCS Radio Technology — 1-800-944-0630 or 417-881-8401.

MISCELLANEOUS RADIO STATION EQUIPMENT AS A PACKAGE. Includes: 5 Tascam 42B, 1 Otari MX-5050 reel-to-reel machines. 6 Dynamax CTR-10 cart decks, 3 eraser and splice finders. 8 8x2 DAs. Cassette duplicator. Call for complete inventory. Ron Russ, CE, KBLA (213) 665-1580.

COMPLETE INTRAPLEX TDM-153 T-1 SYSTEM with 2-15kHz, 3-7.5kHz and 3 four-wire voice modules per side. Includes expansion shelves, backup power supplies and spare master modules. System used for nine months only. Perfect condition! Will include two ADC Kentrox CSUo. Blowout priced at \$8,000. Contact Ron Russ, KBLA, 213-665-1580.

NEW FROM COMTRONIX SYSTEMS, INC.

HIGH PERFORMANCE VHF/UHF
SOLID STATE
AMPLIFIERS

UP TO 200 WATTS PLUS

SEND FOR INFORMATION

TEL 413/785-1313 FAX 413/739-1352

Circle (82) on Reply Card

SONY . AMPEX . BTS . DUBNER GRASSVALLEY . PANASONIC

If You're Looking For the Best in Used Equipment
and You Want the BEST: . DEAL . VALUE . SERVICE
CALL MIDWEST: (708) 251-0001 . CANADA (604) 850-7969

midwest

AUDIO/VIDEO EXCHANGE, INC.
1131 Central Ave. Wilmette, Illinois 60091
International Brokers and Appraisers Serving the Audio / Video Industry

Circle (83) on Reply Card

ALL NEW INVENTORY AT BELOW COST PRICES

COMARK DUPLEXER CH. 13 30KW W/REJECT LOAD	\$13,000
MICRODYNE INT'L VIDEO REC'R 1100IVR INTELSTAT	\$2,300
MICRODYNE DC BLOCK ASIDCB-42	\$100
MICRODYNE DC POWER SUPPLY WP-703A	\$150
POWER TUBE 304TL	\$485
EIMAC TUBE 3CX1500A7	\$630
TUBE 4CX250B	\$70
TUBE 4X7500	\$1,970
BURLE 4-400A/8483	\$130
TUBE 4X150A	\$78
POWER TUBE 5-500	\$343
TUBE 6146A	\$17
POWER TUBE 6156	\$149
POWER TUBE 6623	\$982
POWER TUBE 833A	\$70
EIMAC TUBE 8438	\$127
POWER TUBE 866A	\$27
POWER TUBE 872	\$46
TEK 520A	\$5,000
BIRD 25 KW RF COAXIAL LOAD RESISTOR 857A-115-1	\$5,418
BIRD 10 KW MODULOAD RF LOAD RESISTOR 8631-115	\$4,848
FLOW INTERLOCK CONTROL 8750-230	\$319

**(305) 372-8845
FAX # (305) 372-0757**

CALL US

For New and Rebuilt
Radio Broadcast Equipment

**HALL
Electronics**

(804) 974-6466

1305-F Seminole Trail • Charlottesville, Va. 22901

BE Classifieds
generate
fast results.

Machine Control Patching System

RS-422 NORMALLED PATCHING



JFC
Jem-Fab Corp.

516/867-8510

Circle (84) on Reply Card

BE Classified Advertisements generate results.

Replace incandescent
indicator lamps with
high reliability LED
equivalents.



Eliminate the need to
relamp your control panels,
switches and indicators

Bright LED's
Standard Lamp Bases

- 100 000 hour (11 year) shockproof life
- 5, 6, 12, 14, 24, 28, 48, 60 and 120 volts
- Wedge, bayonet, midget flanged, grooved, telephone slide and other bases
- Red, green, yellow, specials -- warm white, blue

RIGHT BULB.
RIGHT PRICE.
RIGHT DELIVERY.

**LAMP
TECHNOLOGY,
INC.**

1645 Sycamore Ave
Bohemia, NY 11716
516-567-1800

Fax: 516-567-1806
1-800-KEEP LIT
(Outside NY)

Circle (86) on Reply Card

Classified

FOR SALE

Factory Direct Cases

Our price can't be beat



Custom or Stock Sizes

Call for Catalogue or Quote
 Roadie Products, Inc.

800-645-1707
 In NY 516-563-1181
 Fax: 516-563-1390

STUDIOFOAM
SOUND ABSORBENT WEDGES

TESTS 18% BETTER THAN SONEX!
 COSTS LESS! BETTER COLORS! BETTER CUT!

1-800-95-WEDGE

Save in Summer.

SONY BVC-10 Betacart w/ 4 BVW-95 Beta-SP Players \$125,000
 SONY BVH-3100 1" VTR \$26,000
 SONY BVH-2500 1" VTR \$17,500
 UTAH SCIENTIFIC AVS-1B 40x40 Video/Audio Router \$32,000
 CHYRON 4200 Character Generators w/ MGM, 2nd and more starting \$15,000
 TEK 110-S Frame Sync \$4,000
 FOR-A FA-420 TBC with remote \$2,000

MICOR VIDEO EQUIPMENT
 CHICAGO 312 334 4300

EQUIPMENT WANTED

WANTED: USED VIDEO EQUIPMENT. Systems or components. PRO VIDEO & FILM EQUIPMENT GROUP: the largest USED equipment dealer in the U.S.A. (214) 869-0011.

WANTED: *** ELECTRON (VACUUM) TUBES ***. Magnetrans, Klystrons, Planar Triodes, etc... The Vacuum Tube Exchange (800) 995-TUBE or fax lists to (800) 995-6851.

SERVICES

Freeland Products, Inc.
Serving the world with quality rebuilt tubes since 1940.

CALL TODAY FOR A FREE INFORMATION PACKET
 1-800-624-7626

75412 Highway 25 • Covington, LA 70433
 800-624-7626 • 504-893-1243
 Fax 504-892-7323

Their Way

The Broadcast Store

1. Only new equipment or used equipment
2. Salespersons
3. Limited inventories.
4. Sales pitches
5. Sell equipment only

1. New equipment and used equipment.
2. Sales Engineers
3. 15,000 pieces of gear
4. Technical Newsletters
5. Buy, consign, sell, trade

BCS is changing the way you buy video equipment

NY-212-268-8800
 LA-818-551-5858



BE CLASSIFIEDS



Call now & be part of the best classified section in the industry.

913-967-1732
 Ask for Renée.

Circle (85) on Reply Card

SOLVE YOUR AUDIO PROBLEMS ELIMINATE HUM, BUZZ AND GROUND LOOPS IN 600Ω LINES



IL-19 In-Line Transformer \$55.50
 BROAD FREQUENCY RESPONSE, 20-20 kHz;
 LOW DISTORTION; IT REALLY WORKS!
 MENTION THIS AD AND RECEIVE AN ADDITIONAL 10% DISCOUNT

PREPAID ORDERS RECEIVE A 20% DISCOUNT
 AND FREE SECOND DAY FREIGHT
 (THIS OFFER AVAILABLE ONLY IN CONTINENTAL U.S.)



USA AND CANADA ORDERS (800) 634-3457
 FAX ORDERS (800) 551-2749
 SES COM, INC., 2100 WARD DRIVE
 HENDERSON, NEVADA 89015 USA
 TECHNICAL HELP (702) 565-3400
 CALL OR WRITE FOR YOUR FREE 56 PAGE AUDIO CATALOG

RS422 VTR REMOTE CONTROL with TIMECODE DISPLAY & JOGWHEEL

SONY, AMPEX, JVC, BTS
 PANASONIC, HITACHI

Low Cost — Lots of features

DNF INDUSTRIES
 (213) 650-5256 • LA, CA 90069

USED EQUIPMENT

Place free classified ads to sell video equipment. Call 708 673 9200 or Fax 708 673 9205 to receive list or to sell equipment. List updated daily!

Broadcast Equipment Classifieds

INVENTORY REDUCTION

ALL NEW EQUIPMENT AT
 BELOW COST PRICES

FOR-A TRANSCODER CT-600	\$2,200
FOR-A TBC/FAME SYNCHRONIZER FA-800	\$5,100
VIDEO CHARACTER GENERATOR VTW-222s	\$1,600
FOSTEX SYNCHRONIZER 4030	\$890
FOSTEX E-21A STEREO RECORDER	\$2,300
500 AMPEX 198-BC60LA	\$20
1000 AMPEX CASES 1" FIRE RESISTANT	\$4
NEC MULTISYNC 30" COLOR DATA MON.	
DM-3000AP	\$2,600
NOVA TIME BASE CORRECTOR 620	\$2,800
PANASONIC COLOR MON. FT-2700	
MULTISTANDARD	\$1,000
SONY U-MATIC RECORDER BVU-950P	\$8,500
HITACHI REMOTE CONTROL RU-97	\$2,000
HITACHI BASE STATION SK97-BU-97	\$3,700
JVC U-MATIC TAPE PLAYER CR 600	\$3,000
LAIRD LX LEGEND SE CHARACTER GRAPHIC GENERATOR	\$9,000
MAGNI SYSTEMS VS560	\$3,200
NEC COMPUTER INTERFACE IPS-100	\$200
PANASONIC UNIVERSAL VHS/VCR AG-W1	\$1,650
PANASONIC MACHINE CONTROL INTERFACE 1FP45	\$450
SONY EDITOR BVE-600	\$5,200
SONY ECM-77B	\$170
SONY MPX-210	\$1,200
PANASONIC AG-1A81 1/2" FOR AGW-800	\$550
PANASONIC AG-6200	\$1,200

(305) 372-8845
FAX # (305) 372-0757

TRAINING

FCC GENERAL CLASS LICENSE. Cassette recorded lessons with seminars in Washington, Newark, Philadelphia. Bob Johnson Telecommunications. Phone (213)379-4461.

HELP WANTED

ELECTRONICS FIELD/SHOP ENGINEER. Swiderski Electronics, Inc. located in the Chicagoland area, is looking for an Electronics Field/Shop Service Engineer with a min. of 2 years exp. Individual to work with Broadcast/Industrial 1/2", 3/4" & 1" VTR's and related equipment. Full time position. Full company benefits. Send resume & salary history to: Human Resources Dept., 1200 Greenleaf Ave., Elk Grove Village, IL 60007. Fax resume to: (708) 364-5019.

POST PRODUCTION ENGINEER. Large, state-of-the-art facility in sunny South Florida looking for a full-time night shift engineer. Good attitude and self-starter a must. Telecine exp. a plus. Send resume to: Chief Engineer, P.O. Box 451186, Sunrise, FL 33345 (6-93-1)

BROADCAST ENGINEER — Maintain current plant and add new facilities. Knowledge of AM/FM RF, state-of-the-art audio, digital software, computer hardware. Full service, active stations in a great town! Competitive salary plus good benefits. Start 6/1/93. Send Resume to: General Manager, WFVA/WBQB, P.O. Box 269, Fredericksburg, VA 22404. EOE/M-F. (6-93-1)

TELEVISION MAINTENANCE ENGINEER positions are available at WPIX, N.Y.'s movie station. Ideal candidate must have 5 years plus experience troubleshooting analog, digital, and RF (including microwave) equipment to component level. Installation and wiring experience helpful. PC, LAN and programming expertise especially needed. FCC General Class License and SBE Certification a plus. Excellent salary and benefits offered. We are an equal opportunity employer. A Tribute Broadcasting Station. Send resume and salary requirements to: WPIX, 220 East 42 Street, New York, New York 10017, Employment C. (6-93-1)

HANDS-ON CHIEF ENGINEER needed for network-affiliated, group-owned station in the Biggest Little City in the World. Must have 5 years experience with 2 years in supervisory role. Experience with GVG, BTS and Sony tape machines a must. Transmitter microwave experience a plus. Send resume / salary requirements to: Personnel Director, Sunbelt Broadcasting Company, 1500 Foremaster Lane, Las Vegas, NV 89101. No telephone calls. EOE. (6-93-1)

ENGINEER

Quantel, with their continued expansion program require a Broadcast professional. The position requires extensive technical and marketing experience on high-end Post Production products. Good presentation and communications skills are essential for this Connecticut based position. Please fax resume and salary history to: Product Support Manager at 1-203-656-3459.

Classified

HELP WANTED

THE SULTANATE OF OMAN TV BROADCAST ENGINEERING VACANCIES

The Sultanate of Oman operates a modern color television and radio broadcasting service with studio centers situated in the north and south of the country. High-power VHF and low-power UHF transmitters are used to provide TV service to populated areas of the Sultanate.

Due to expansion of the service, vacancies for a variety of television positions have arisen and applications are invited from suitable qualified persons.

TELEVISION MAINTENANCE ENGINEER - STUDIOS

Openings for individuals with extensive background in VTR, cameras, editing systems and other related TV studio maintenance. A degree in electronics technology, or equivalent, is required; SBE certification and PAL experience a plus. Must be able to trouble-shoot to the component level, be a team player and be willing to train others.

TV MAINTENANCE ENGINEER FM & TV TRANSMITTERS

Openings for individuals with extensive background in maintenance of FM/TV transmitters and translators from 1 watt through 10 kw. A degree in electronics technology, or equivalent, is required; SBE certification and satellite or microwave experience a plus. Must be able to trouble-shoot to the component level, be a team player and be willing to train others. Helicopter rides to some sites required.

NOTE: Extensive practical experience in lieu of academic qualifications may be acceptable

RIGGER

Opening for an experienced antenna and tower rigger. Applicant must be able to maintain existing large and small towers and install small translator-style antenna support structures. Many sites are only accessible by helicopter. Individual must be a self-starter and a team player.

EMPLOYMENT BENEFITS

SALARY:

1,271 - 1,657 Oman Rials per month
(Approximate exchange rate: 1 O.R. = 2.58 US \$)

Plus:

R.O. 44 - Water & electricity allowance per month
R.O. 75 - Transportation allowance per month
R.O. 15 - Telephone allowance per month
R.O. 40-50 Yearly increment

Terminal bonus payable at end of contract, after the second year. Applicant signs a one-year contract that is renewable upon mutual satisfaction.

No local income tax is collected. Regarding American taxes, please contact the IRS.

LEAVE:

48 days annual leave inclusive of weekends after the end of each annual contract from the date of employment. A round-trip economy-class air ticket from the place of work to the country of domicile will be granted for the employee, spouse, and three children up to the age of 21 years.

ACCOMMODATIONS:

Free family housing, furnished, is provided.

MEDICAL:

Free medical and dental treatment available for applicant and dependents.

AIR TRAVEL:

An economy-class air ticket will be provided for the selected candidate, spouse, and up to three children, 21 years old or below, from the country of domicile to the place of work in the Sultanate of Oman at the time of employment and the end of the contract. The employee will also be given an excess luggage allowance of 20 kg for him/herself, 10 kg for spouse and 5 kg each for up to three children.

Qualified interested applicants should forward their resume stating nationality, qualifications and full details of experience. Successful applicants will need to possess a valid U.S. passport during the hiring process. Send resume to the following address:

INFORMATION ATTACHE

EMBASSY OF THE SULTANATE OF OMAN

2342 MASSACHUSETTS AVENUE, NW • WASHINGTON, DC 20008
FAX: 202-483-4097 TEL: 202-483-4096

Ad Index

	Page Number	Reader Service Number	Advertiser Hotline		Page Number	Reader Service Number	Advertiser Hotline
AAVS/Div. of Sencore	3	4	605-339-0100	Logitek	96	60	713-782-4592
Abekas Video Systems	*19	12	415-369-5111	Maxell Corp. of America	11	8	800-533-2836
ADC Telecommunications	53	34	800-726-4266	Microtime Inc.	41	27	800-243-1570
AEQ SA	29	17		Midwest Audio/Video Exchange	125	83	708-251-0001
Ampex Systems Corporation	54-55	35	415-367-2011	Milestek	117	75	817-455-7444
Asaca/Shibasoku Corporation	17	11	213-827-7144	Miller Fluid Heads	122	78	201-473-9592
Audio Limited	112	71		Nady Systems, Inc.	105	66	510-652-2411
Audio Precision	13	9	800-231-7350	Nautel Electronics	34	20	902-823-2233
Audio Processing Tech. Ltd.	63	39	23 23 71 110	Nesbit Systems	40	26	609-799-5071
The Broadcast Store, Inc.	126	85	818-551-5858	Newstech	36	23	317-253-1640
BEC Technologies	68	44	407-855-8181	Nikon Electronic Imaging	5	5	800-NIKON-US
Frank R. Beemish & Company	125	84	516-867-8510	Odetics, Inc.	87	55	800-243-2001
Belar Electronics Laboratory	123	79	215-687-5550	OMB Sistemas Electronicos	*19	13	347-627-4537
Broadcast Video				Opamp Labs, Inc.	30	87	213-934-3566
Systems Ltd.	104, 123	65,80	416-764-1584	Orban, Div. of AKG Acoustics	7	6	510-351-3500
BTS Broadcast TV Systems	89	56	800-962-4BTS	Otari Corp.	15	10	415-341-5900
Burle Industries	95	59	717-295-6123	Panasonic Broadcast & TV	59		800-524-0864
Canare Cable, Inc.	111	70	818-365-2446	Pro-Bel Inc.	IFC,77	1,42	404-396-1971
Circuit Research Labs Inc.	121	77	602-438-0888	Quantel	83	52	203-656-3100
Clark Wire & Cable	36	22	708-272-9889	Queue Systems	30	88	818-895-8510
Clear-Com Intercom Systems	81	51	510-527-6666	Radiation Systems	52	31	708-298-9420
Comtronics	125	82	413-739-9691	Roland Corp. US	35	21	213-685-5141
Conex Electro Systems	52	32	206-734-4323	SCA Data Systems, Inc.	56	36	213-576-0655
Corporate Computer Systems	80	50	201-946-3800	Schmid Telecommunication	111,113		
Datatek, Inc.	65	47	800-882-9100	115,117,119	76	
DPS	37	24	606-371-5533	Sennheiser Electronics Corp.	110	69	203-434-9190
Dolby Labs Inc.	102-103	64	415-558-0200	Sharp Copier Division	IBC		
Dynatech Corporation	43-46	28	608-273-5828	Shure Brothers Inc.	72A-B	81	800-25-SHURE
EEV, Inc.	101	63	800-DIAL-EEV	Sierra Video Systems	107	67	916-273-9331
Enco Systems Inc.	84	53	800-ENCO-SYS	Solid State Logic Ltd.	67	43	800-343-0101
EVS Broadcast Equipment	39	25	+32 41 22 00 70	Sony Business	24-25, 32A-H		800-635-SONY
Faraday Technology	112	72		Storeel	64	40	404-458-3280
Flex-Tech, Inc.	80	49	612-546-6660	Sumitomo Electric	85	54	310-782-0227
Fujinon Inc.	97	61	201-633-5600	Tascam/Teac America, Inc.	108-109	68	213-726-0303
Gentner Communication	51	30	801-975-7200	Telex Communications, Inc.	60-61	38	800-554-0716
Graham-Patten Systems Inc.	71	45	800-422-6662	Television Technology Corp.	9	7	303-665-8000
Grass Valley Group	75	46	800-343-1300	Thomson Tubes Electroniques	91	57	201-812-9000
Hardigg Industries	52	33	413-665-2163	Varian Associates Inc.	79	48	
Harris Allied	1,31	319	800-622-0022	Vega, A Mark IV Company	27	15	818-442-0782
HM Electronics Inc.	116	74	619-535-6000	Video Design Pro	57	37	800-VIDCAD-6
illbruck	115	73	800-662-0032	Vinten Broadcast Inc.	92-93	58	201-263-4000
Jampro Antennas, Inc.	28	16	916-383-1177	The Winsted Corporation	64	41	612-944-8556
JVC Professional Products Co.	21	14	800-JVC-5825	Zero Stantron Enclosures	30	18	800-821-0019
Lamp Technology	125	86	516-567-1800	3M Pro Audio/ Video Products	48,45A-B	29	612-733-1959
Leitch	BC	2	800-231-9673	360 Systems	99	62	818-342-3127

*Denotes demographic coverage.

312, 379, 302, 305
641, 652, 953, 955, 1031, 1071

"NEED A PLAIN PAPER FAX WITH THE LOWEST COST-PER-COPY? YOU NEED SHARP'S WINNING GAME PLAN FOR FAX."

BILL WALSH
CHAMPIONSHIP COACH

In football, you concentrate on winning a few yards at a time. In business, it's pennies. That's why Sharp, the #1 fax company has a Winning Game Plan for business.

AMERICA'S
#1
FAX COMPANY
SINCE 1988

A booklet that can help you find the plain paper fax with the lowest cost-per-copy in the industry.

Like Sharp's FO-4800 Plain Paper Laser Fax — with a 15,000 copy toner cartridge that can last years, not months. Plus a compact, desktop size with front-loading trays and small footprint. Advanced features like collated output, 50-sheet capacity, 125 fax and 25 voice number auto-dialer.

And Sharp's F.A.S.T. remote diagnostic system that signals your dealer for maintenance.

So if you're committed to squeezing more value, more productivity out of every penny, call for Sharp's Winning Game Plan booklet today. Or fax 1-800-3-SHARP-3.

It'll put you right where you want to be. In the winning position.

CALL 1-800-BE-SHARP FOR YOUR WINNING GAME PLAN FOR FAX.



SHARP
FROM SHARP MINDS
COME SHARP PRODUCTS™

LCD BANKING SYSTEMS • CALCULATORS • CASH REGISTERS • COLOR SCANNERS • COMPUTERS • COPIERS • FACSIMILE • LASER PRINTERS • TYPEWRITERS • WIZARD™ ORGANIZERS

© 1998 Sharp Electronics Corporation

FULL PERFORMANCE AMAZING PRICE

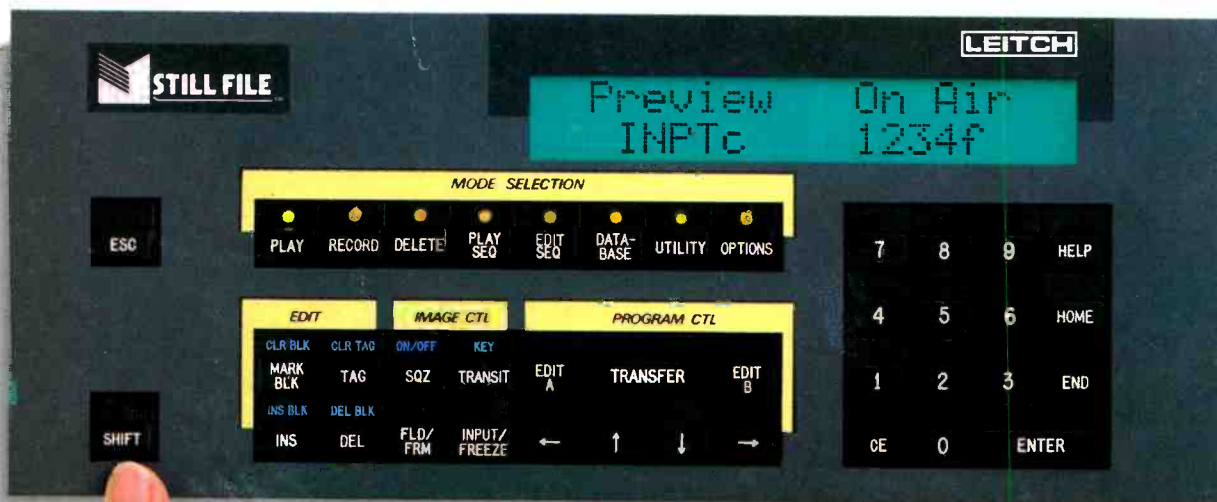

from

\$18,995

Leitch introduces the STILL FILE Special Edition, a new, low cost version of the popular STILL FILE.

Now you can own America's most popular still store for as little as \$18,995.

Call 1-800-231-9673 and ask for more information on the new STILL FILE Special Edition.

\$18,995 includes 1500 fields of storage. Compact control panel is optional.

LEITCH

Leitch Incorporated, 920 Corporate Lane, Chesapeake, VA 23320 - Tel: (804) 548-2300 or (800) 231-9673 Fax: (804) 548-4088

Circle (2) on Reply Card