

OPTIMUS®

Professional Series

Audio/Video Receiver

STAV-3790

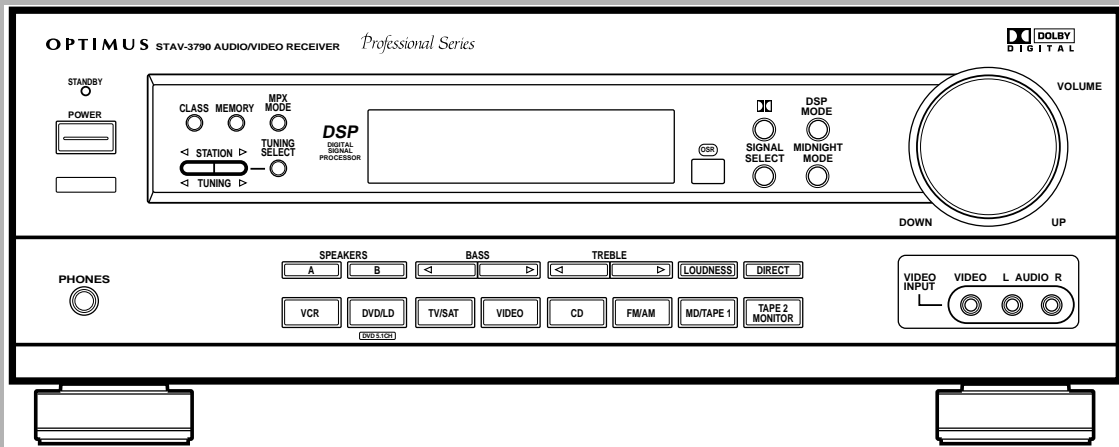

Owner's Manual

Please read before using this equipment.

Introducing the Optimus STAV-3790

Your Optimus STAV-3790 Audio/Video Receiver operates as the perfect control center for your audio/video system. It combines 100 watts-per-channel of clean power with modern styling. It provides connections for one tape deck, one VCR, two audio/video sources, an additional tape deck or audio source, a CD player, and a video monitor.

Your receiver also has special sound options. *Dolby Digital* produces the digitally-processed true lifelike sound in every channel including sub-woofer. *Dolby Pro Logic® Surround Sound* delivers movie theater sound for audio/video programs (especially those encoded with Dolby Surround Sound signals). *DSP Effects* creates a listening environment that simulates a concert hall, jazz club, theater, or a dance hall.

In addition, you can connect a multi-channel decoder or DVD player with 5.1-channel output so that all five channels and subwoofer have independent signals.

Additional features include:

- Digital-Synthesized Tuner** Precisely tunes to AM and FM stations.
- 30 Memory Locations** Let you store and recall the frequencies for up to 30 AM/FM stations.
- Midnight Listening Mode** Lets you enjoy the quality surround sound even at low volumes without disturbing others.
- Optical Digital Output** Lets you directly output the digital source signals to a digital recording device, such as MD, DAT, or CD-R.
- Automatic Tuning** Searches for the next available AM/FM station.
- Tape Monitoring** Lets you listen to the actual recording as you record, if your tape deck has a tape-monitoring feature.
- Built-In Protection Circuits** Automatically turn off the receiver to help avoid power surges or short circuit damage.
- Remote Control** Lets you use a single remote control for the receiver and other compatible components connected to the receiver.

Note: The remote control requires two AA batteries (not supplied).

We recommend you record the receiver's serial number here. The number is on the receiver's back panel.

Serial Number: _____

Note to the Cable TV System Installer:

This reminder is provided to call the CATV system installer's attention to Article 820-40 of the National Electrical Code that provides guidelines for proper grounding and, in particular, specifies that the cable ground shall be connected to the grounding system of the building as close to the point of cable entry as practical.



© 1999 Tandy Corporation.
All Rights Reserved.

RadioShack and Optimus are registered trademarks used by Tandy Corporation.

IMPORTANT SAFETY INSTRUCTIONS

This receiver is made and tested to meet exacting safety standards. It meets both UL and FCC requirements.

WARNING: To reduce the risk of fire or shock hazard, do not expose this product to rain or moisture.

	CAUTION RISK OF ELECTRIC SHOCK. DO NOT OPEN.	
<p>CAUTION: TO REDUCE THE RISK OF ELECTRIC SHOCK, DO NOT REMOVE COVER OR BACK. NO USER-SERVICEABLE PARTS INSIDE. REFER SERVICING TO QUALIFIED PERSONNEL.</p>		



This symbol is intended to alert you to the presence of uninsulated dangerous voltage within the product's enclosure that might be of sufficient magnitude to constitute a risk of electric shock. Do not open the product's case.



This symbol is intended to inform you that important operating and maintenance instructions are included in the literature accompanying this product.

CAUTION

Power Lines—Locate an outdoor antenna away from power lines.

Nonuse Periods—Unplug the receiver's power cord when you will not use it for extended periods.

Outdoor Antenna Grounding—If an outside antenna or cable system is connected to the receiver, ground the antenna or cable system so as to provide some protection against voltage surges and built-up static charges. Article 810 of the National Electrical Code, ANSI/NFPA 80, provides information about proper grounding of the mast and supporting structure, grounding of the lead-in wire to an antenna discharge unit, size of grounding conductors, location of antenna-discharge unit, connection to grounding electrodes, and requirements for the grounding electrode. See the example below.

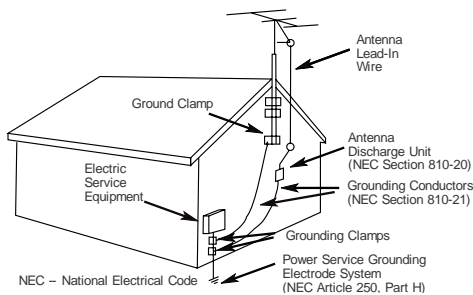

Careful attention is devoted to quality standards in the manufacture of your receiver, and safety is a major factor in its design. However, safety is also your responsibility.

This section lists important information that will help you properly use and enjoy your receiver and accessories. Read all the included safety and operating instructions before using your receiver. Follow them closely, and retain them for future reference.

Heed Warnings — Follow all warnings on the product and in the operating instructions.

Cleaning — Unplug this product from the wall outlet before cleaning. Use only a damp cloth for cleaning. Do not use liquid or aerosol cleaners.

Attachments — Do not use attachments/accessories not recommended by the product manufacturer, as they might create a hazard.

Water and Moisture — Do not use this product near water (for example, near a bathtub, washbowl, kitchen sink, or laundry tub; in a wet basement; or near a swimming pool).

Accessories — Do not place this product on an unstable cart, stand, tripod, bracket, or table. The product may fall, causing serious injury to a child or adult, and serious damage to the product. Use only with a cart, stand, tripod, bracket, or table recommended by the manufacturer or sold with the product. Follow the manufacturer's instructions for mounting, and use a recommended mounting accessory.



Carts — Move the product on a cart carefully. Quick stops, excessive force, and uneven surfaces may cause the product/cart to overturn.

Ventilation — Slots and openings in the cabinet provide ventilation, ensure reliable operation, and protect from overheating. Do not block or cover these openings, and do not place the product on a bed, sofa, rug, or other similar surface. Do not place the product in a built-in bookcase or rack unless it provides proper ventilation as specified by the manufacturer.

Power Sources — Operate this product using only the power source indicated on its marking label. If you are not sure of your home's power type, consult your product dealer or local power company.

Polarization — This product is equipped with a polarized AC line plug (a plug having one blade wider than the other). This plug will fit in the power outlet only one way. This is a safety feature. If you cannot insert the plug fully into the outlet, try reversing the plug. If the plug still doesn't fit, contact your electrician to replace your obsolete outlet. Do not defeat the safety purpose of the polarized plug. If you need an extension, use a polarized cord.

Power-Cord Protection — Route power-supply cords so they are not likely to be walked on or pinched by items placed on or against them, paying particular attention to cords at plugs, convenience receptacles, and the point where they exit from the product.

Lightning — For added protection for this product during a lightning storm, or when it is left unattended and unused for long periods of time, unplug it from the wall outlet and disconnect the antenna or cable system. This will prevent damage to the product due to lightning and power-line surges.

Overloading — Do not overload wall outlets, extension cords, or integral convenience receptacles, as this can result in a risk of fire or electric shock.

Objects and Liquids — Never push objects of any kind into this product through openings, as they may touch dangerous voltage points or short out parts that could result in a fire or electric shock. Never spill liquid of any kind on the product.

Servicing — Do not attempt to service this product yourself, as opening or removing covers may expose you to dangerous voltage or other hazards. Refer all servicing to qualified service personnel.

Damage Requiring Service — Unplug this product from the wall outlet and refer servicing to qualified service personnel under the following conditions:

- When the power-supply cord or plug is damaged.
- If liquid has been spilled or objects have fallen into the product.
- If the product has been exposed to rain or water.
- If the product does not operate normally by following the operating instructions. Adjust only those controls that are covered by the operating instructions, as an improper adjustment of other controls may result in damage and will often require extensive work by a qualified technician to restore the product to normal operation.
- If the product has been dropped or damaged in any way.
- When the product exhibits a distinct change in performance.

Replacement Parts — When replacement parts are required, be sure the service technician uses replacement parts specified by the manufacturer or having the same characteristics as the original part. Unauthorized substitutions may result in fire, electric shock, or other hazards.

Safety Check — Upon completion of service or repairs to this product, ask the service technician to perform safety checks to determine that the product is in proper operating condition.

Wall or Ceiling Mount — The product should be mounted to a wall or ceiling only as recommended by the manufacturer.

Heat — The product should be situated away from heat sources such as radiators, heat registers, stoves, or other products (including amplifiers) that produce heat.

Contents

Preparing Your Receiver	5
Positioning Speakers	5
Connecting Speakers	6
Connecting Program Sources	9
Connecting the Antennas	13
Using One Remote Control for More than One Unit	15
Installing the Remote Control's Batteries	15
Using the AC Power Outlet	16
Connecting to AC Power	16
Initial Setup	17
Basic Procedure	17
Basic Operation	20
Tuning the Radio	21
Using MPX MODE	22
Using Headphones	22
Muting the Receiver	23
Loudness Control	23
Bypassing the Sound Controls	23
Adjusting the Display Brightness	23
Switching Analog/Digital Signal Input	23
Using ATT	23
Cassette Deck/VCR Features	24
Using the MD/TAPE 1 and TAPE 2 MONITOR Buttons	24
Monitoring a Program Source	24
Dubbing a Cassette Tape	24
Playing and Recording Video Tapes	25
Using Advanced Sound Options	26
Adjustment Using Test Tone	27
Dolby Digital Playback	27
DVD 5.1-Channel Playback	27
Using the Midnight Mode	27
Program Format Indicators	27
Using the Remote Control	28
Troubleshooting	38
Care and Maintenance	39
The FCC Wants You to Know	40
Specifications	41
Index to Features by Control Name	43

Preparing Your Receiver

Caution: Make all the necessary connections before you plug in or turn on the receiver.

Positioning Speakers

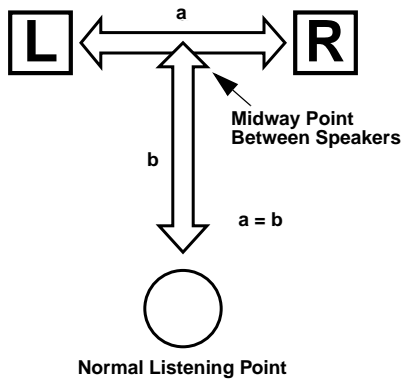

- Surround speakers generally sound best if you position them above ear level.
- To avoid interference with the picture on a nearby TV, use magnetically shielded speaker systems. This is particularly important for the center speaker since it is usually located closest to the TV.

Where you place your speakers (not supplied) can make a noticeable difference in your system's sound. The guidelines in this section will help you choose the best locations. After you use your receiver for a while, you might want to try different locations for your speakers.

Bass response depends largely on speaker location. For strong bass, place the speakers in the corners of the room. If you want even stronger bass, place the speakers directly on the floor. If the bass is too strong, move the speakers slightly away from the corners of the room, or raise them 6 to 18 inches off the floor. You can buy speaker stands at your local RadioShack store.

The distance between the speakers should be about the same as the distance between the normal listening point and the point halfway between the speakers. If you place the speakers too close together, you reduce the stereo separation. If you place them too far apart, you reduce the bass effect and create a *hole* in the middle of the sound.

Most speakers have a tweeter dispersion angle of about 60 degrees. Ideally, your listening position should be just inside the overlap area of the tweeter dispersion. You can angle the speakers toward you for better stereo effect.

To position your speakers for surround sound, place the front speakers at the front of your listening area, and place the (rear) surround speakers behind or to the sides of the listening point (see "Using Advanced Sound Options" on Page 26). Also, place the center speaker above, below, or behind the TV. If you place it beside the TV, the picture may not coincide with the sound.

You can also compensate the speaker positioning by adjusting the control settings for the front, center, or subwoofer speakers. See "Initial Setup" on Page 17.

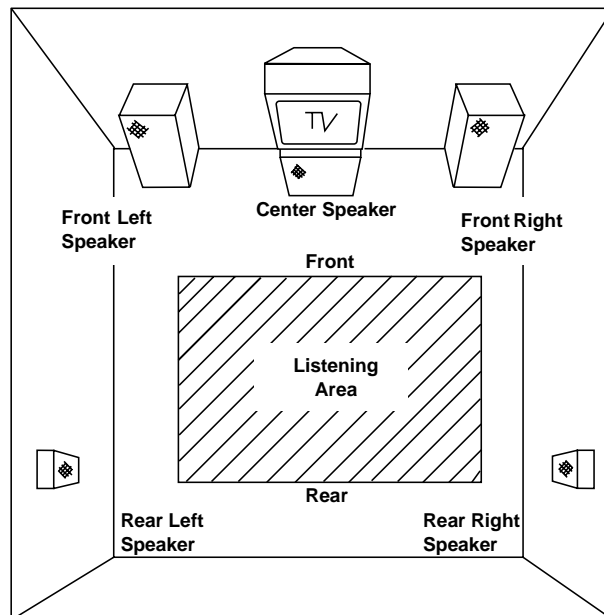

Preparing Your Receiver

Connecting Speakers

Follow these guidelines when you select and connect speakers.

- Only connect speakers that are rated at between 6 and 16 Ohms.
- Be sure you properly connect all speakers.
- Do not connect two pairs of speakers to a single set of terminals at the same time.
- Optimus and other high-quality speakers have color-coded speaker terminals (red for positive polarity and black for negative polarity). Use these color-coded terminals as a guide to help you properly connect the speakers to the receiver.
- Use 16-gauge (or larger) speaker wire for all speaker connections, and consider possible speaker locations before you decide how much speaker wire you need.

Preparing the Speaker Wires

Speaker wire consists of two conductors (individual wires) encased in insulation and is usually color-coded or marked with a ridge along one side so you can identify each conductor. Use these markings as a guide to help you properly connect the speakers to your receiver.

Follow these steps to prepare the speaker wires.

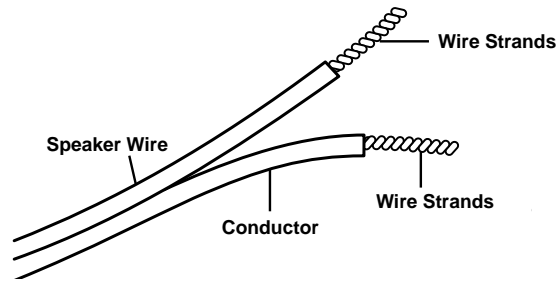

1. Cut the speaker wires to the necessary length.
2. Separate the wires about 4 inches on each end.
3. Using a wire stripper, carefully strip about $\frac{3}{4}$ inch of insulation from the end of each conductor.
4. Twist the end of each conductor to secure any loose wire strands.

Setting the Impedance Selector Switch

Before proceeding to speaker connection, be sure to set the **IMPEDANCE SELECTOR** switch to the appropriate position. If you connect speakers with 6- to 8-ohm impedance, set the switch to **6-LESS THAN 8 W** position. If you are using 8- to 16-ohm impedance, set it to **8-16 Ω** position.

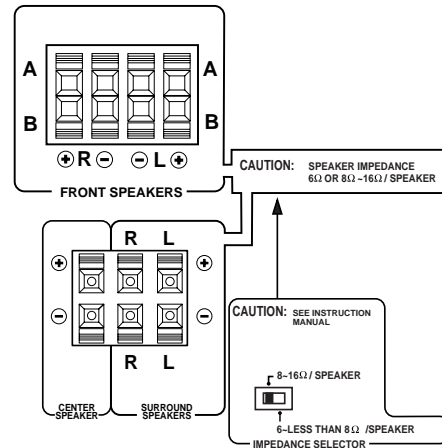

Preparing Your Receiver

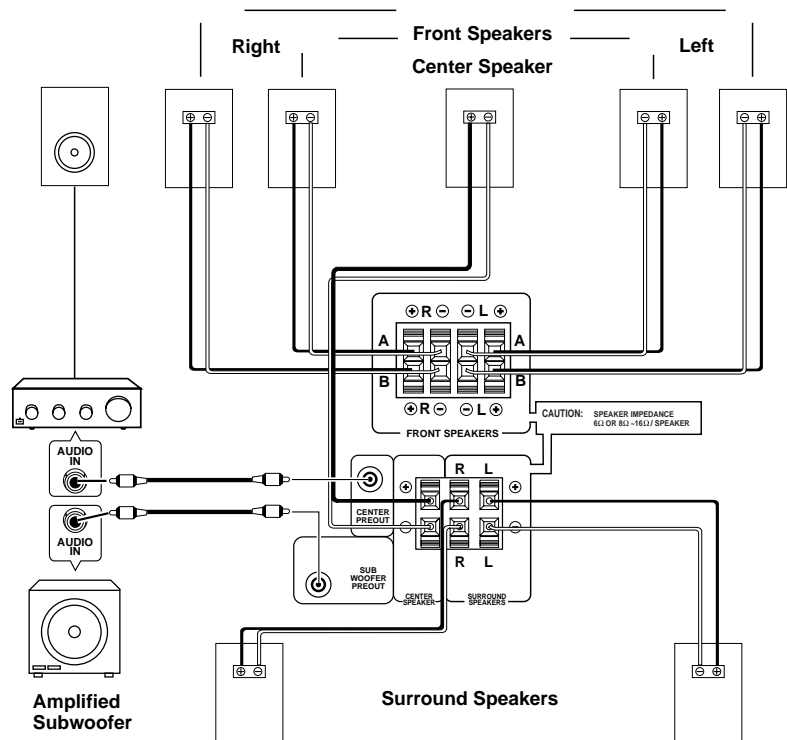

Connecting the Front Speakers

Note: Be sure you connect the receiver's right and left positive (+) and negative (-) terminals to the speaker's corresponding right and left positive (+) and negative (-) terminals.

Follow these steps to connect the right speaker to the receiver's right **FRONT SPEAKERS** terminals.

1. Press open the receiver's **FRONT SPEAKERS R (+)** red lever and insert the ridged or color-coded conductor's end into the small hole. Press the lever closed to secure the conductor.

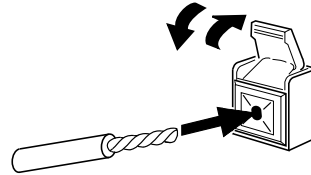

2. Press open the receiver's **FRONT SPEAKERS R (-)** black lever and insert the other conductor's end into the small hole. Press the lever closed to secure the conductor.
3. Connect the ridged or color-coded conductor's loose end to the right speaker's positive (+) terminal.
4. Connect the remaining loose conductor to the right speaker's negative (-) terminal.

Repeat Steps 1-4 to connect the left speaker to the receiver's **FRONT SPEAKERS** left terminals.

Note: You can connect two sets of front speakers to **A** and **B** terminals, but only **A** speaker terminals are active when you use the surround sound system. If you connect only one set of front speakers, be sure to connect them to the **A** terminals.

Preparing Your Receiver

Connecting Surround-Sound Speakers

You can connect a pair of speakers to the receiver for surround-sound programs. Follow the steps in “Preparing Your Receiver” on Page 7 to connect the speakers to the **SURROUND SPEAKERS** terminals.

Connecting the Center Speaker

The center speaker gives additional ambience to surround sound. Follow the steps in “Preparing Your Receiver” on Page 7 to connect the center speaker to the **CENTER SPEAKER** terminals.

Or, if you prefer to use the amplified speaker as your center speaker, connect **CENTER PRE OUT** to its line-level input. You can also connect this jack to the audio input of your TV.

Connecting a Subwoofer Amplifier

Your receiver includes a line-level subwoofer output. Connecting a subwoofer to your system dramatically extends bass response for incredible richness and depth. When you listen to surround-sound programs, a subwoofer enhances your home theater experience by realistically recreating the rumble of an earthquake, the bone-jarring percussion of a cannon, and more. To use the subwoofer output, connect **SUBWOOFER PRE OUT** to an amplified subwoofer’s line-level input or to an amplifier to which you have connected a subwoofer.

RadioShack stores sell a variety of suitable subwoofers and amplifiers.

Preparing Your Receiver

Connecting Program Sources

You can connect up to seven external program sources to your receiver.

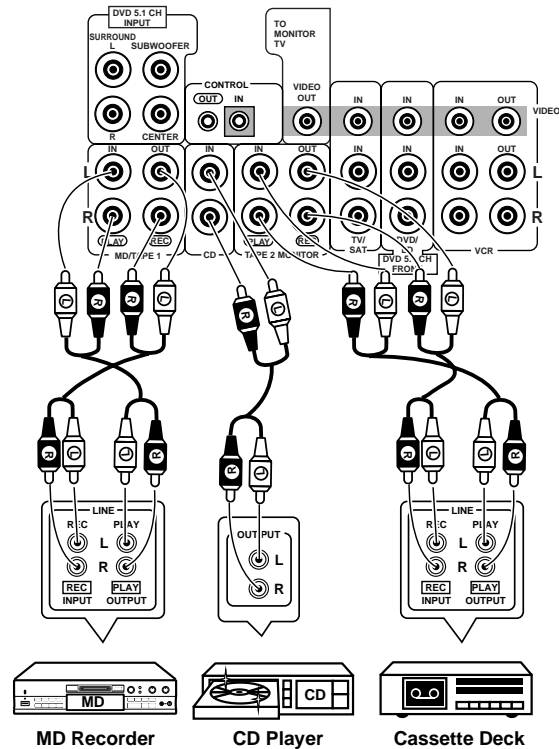

Note: Use shielded audio cables with phono connectors for all audio connections.

Note: If you place the cassette deck directly above, below, or to the left of the receiver, the receiver could interfere with the cassette deck's operation. If possible, position the cassette deck to the right or away from the receiver.

Connecting a CD Player

To connect a CD player to the receiver, connect the CD player's left and right output jacks to the receiver's L and R CD IN jacks.

Connecting Cassette Decks

You can connect cassette decks to the MD/TAPE 1 and TAPE 2 MONITOR jacks. Connect the cassette deck's output jacks to the MD/TAPE 1 IN PLAY or TAPE 2 MONITOR IN PLAY jacks, and connect the cassette deck's input jacks to the MD/TAPE 1 OUT REC or TAPE 2 MONITOR OUT REC jacks.

Connecting MD Recorder

To connect a MD recorder to the receiver, connect the MD recorder's left and right output jacks to the receiver's L and R MD/TAPE 1 IN PLAY jacks and connect the MD recorder's input jacks to the MD/TAPE 1 OUT REC jacks.

You can also use the fiber-optic cable (not supplied) or digital coaxial cable (not supplied) to connect the digital output jack of the CD player or MD recorder (for playback only) to the DIGITAL IN OPT 1 or 2 or COAX jack. See "Digital Connections" on Page 12.

Preparing Your Receiver

Note: If you have a turntable with magnetic cartridge and want to connect it to the STAV-3790, you need to connect a pre-amplifier between the turntable and the receiver. Some turntables have a switchable built-in amplifier: if your turntable has this feature, switch it to preamp mode. Connect the output of the pre-amplifier to any unused audio input jacks (MD/TAPE1, CD, TAPE2 MONITOR, TV/SAT, DVD/LD, or VCR).

Connecting Video Sources

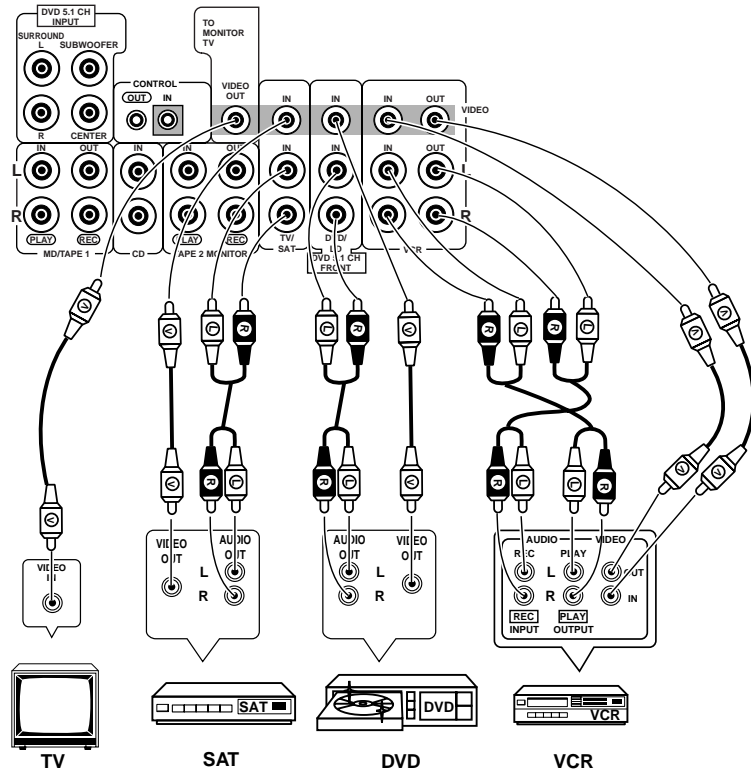

Note: If your VCR is monaural, use a Y-adaptor (available at your local RadioShack store) to connect the VCR's audio output to both the L and R audio inputs on the receiver.

If you connect three video sources, such as VCRs, laser disc (LD) players, digital video disc (DVD) players, or satellite receivers to your receiver, you can use the receiver to select each video source. You can also use the receiver to record from these video sources to the source connected to VCR.

Connect phono cables from each video source's audio outputs to the receiver's VCR IN, DVD/LD IN, or TV/SAT IN jacks. Then connect phono cables from the receiver's VCR OUT jacks to the source's audio input jacks.

Connect video cables from each video source's video outputs to the receiver's VCR VIDEO IN, DVD/LD VIDEO IN, or TV/SAT VIDEO IN jacks. Then connect video cables from the receiver's VCR VIDEO OUT jack to the source's video input.

You can also use the fiber optic cable (not supplied) or digital coaxial cable (not supplied) to connect the digital output jack of the DVD player to the DIGITAL IN OPT1, 2 or COAX jack. See "Digital Connections" on Page 12.

Preparing Your Receiver

Connecting a Camcorder

You can connect the camcorder (or other audio/video device) to the front panel **VIDEO INPUT** jacks. You need a stereo A/V cable (not supplied) with plugs that fit the receiver's jacks and the camcorder's jacks for this connection.

Insert the plugs at one end of the cable into the **VIDEO INPUT** jacks on the receiver's front panel. Then insert the plugs at the other end of the cable into the audio/video out jacks on your camcorder or other audio/video source. Be sure to connect video to video and audio to audio (use the plug's color code as a guide).

Connecting a Video Monitor

The monitor (or TV with baseband video input) you connect to the **TO MONITOR TV** terminal can monitor any program you connect to the receiver's **VCR IN**, **DVD/LD IN**, or **TV/SAT IN** jacks. Connect a video cable from the receiver's **VIDEO OUT TO MONITOR TV** jack to the monitor's video input.

DVD 5.1-Channel Inputs

The receiver accepts both 2-channel and 5.1-channel input for DVD players and multi-channel decoders. Selecting the 5.1-channel mode enables the **SURROUND L/R**, **CENTER**, and **SUBWOOFER** output jacks for signal processing with multi-channel decoder or DVD player with 5.1-channel output.

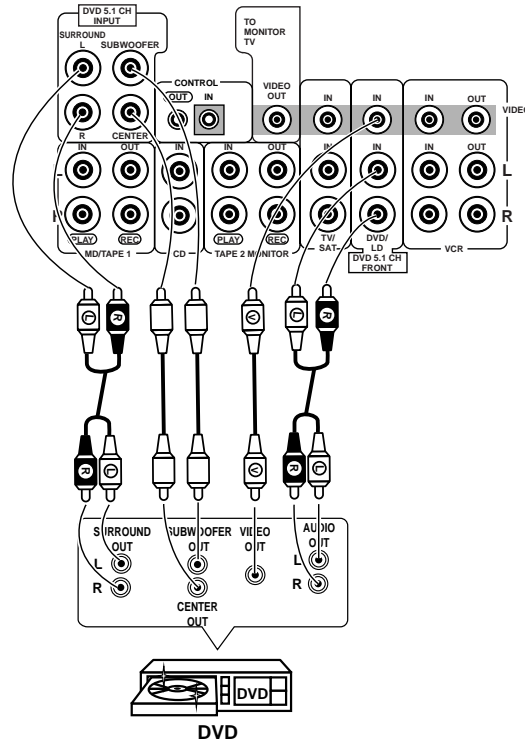

Preparing Your Receiver

Digital Connections

You can connect up to three digital output devices to your receiver. Two inputs use the fiber-optic cable, and one uses coaxial digital audio cable.

Notes:

- You must remove the DIGITAL IN OPT 1 or 2 jack's rubber cover in order to connect to either jack.
- Keep the cover in place when you are not using either jack.

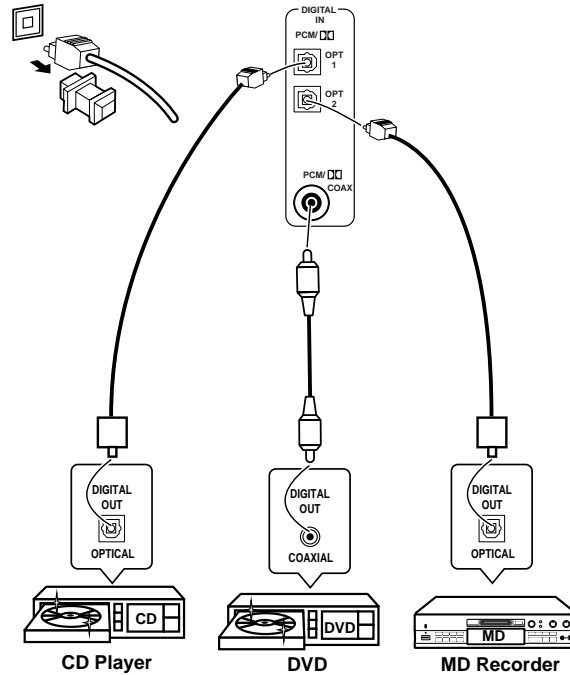

Note: If you are connecting a LD or DVD player with AC-3 RF, you need a separate RF demodulator (not supplied). For details, see the manual provided with the RF demodulator.

Using the appropriate cable, make connections between the digital output jack of your device and the digital input jack on the receiver.

The digital input jacks are assigned to the following function at the factory. For example, when you select the CD function, the OPT 1 jack input activates.

- OPT 1: CD player
- OPT 2: MD recorder
- COAX: DVD player

You can change this arrangement to suit your needs. See "Initial Setup" on Page 17.

Preparing Your Receiver

Connecting the Antennas

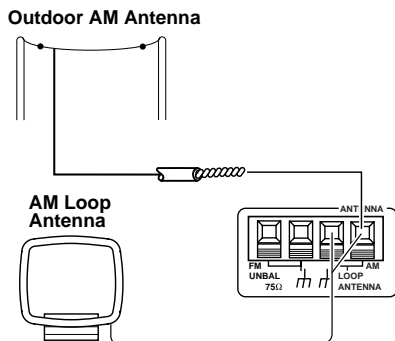
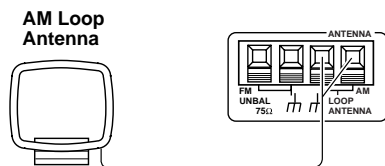
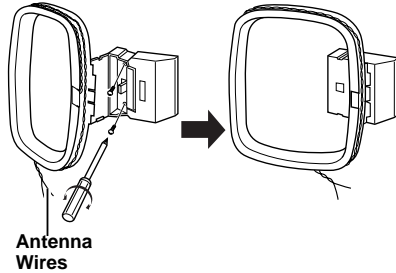
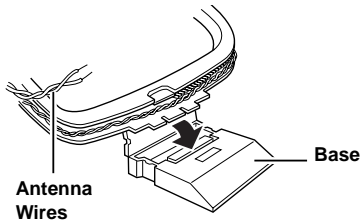

Note: For the best results, use 75-ohm coaxial cable to connect an outdoor antenna to the receiver.

In many areas, the supplied indoor AM loop and FM antennas provide satisfactory reception.

AM Antennas

Assemble the supplied AM antenna's base by swinging the base in the direction of the arrow and inserting the antenna's bottom tabs into the base's slot. If the receiver is in a rack or on a shelf and there is no room for the AM loop antenna, use two screws (not supplied) to mount the base on the wall or another location.

Attach the antenna wires to the AM LOOP ANTENNA and \hbar (ground) terminals (upper two terminals).

Place the antenna on a flat surface and rotate it for the best AM reception.

Notes:

- Keep the AM loop antenna connected even when you use another indoor antenna or an outdoor AM antenna.
- Ensure that the antenna does not touch the receiver or any other metal object.
- Do not place the antenna near a CD player, a personal computer, or a TV set.
- If the wire between your AM loop antenna and receiver is too short, you can add extra wire, available at your local RadioShack store.

You can also use an optional RadioShack shortwave antenna kit (Cat. No. 278-758), which makes an excellent outdoor AM antenna. Connect the outdoor AM antenna wire to the receiver's AM terminal.

FM Antennas

Connect the supplied FM antenna to the FM UNBAL 75 Ω terminal, then extend it.

For better FM reception, you can also use a rabbit-ear TV antenna (for indoor use only). To connect the TV antenna to the receiver, you need a VHF/UHF/FM splitter (not included). RadioShack stores carry a full line of quality antennas and antenna connection accessories.

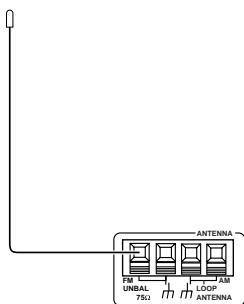

Preparing Your Receiver

Warning: To prevent injury, read and follow all cautions and warnings that accompany the outdoor antenna.

For the best radio reception, use an outdoor antenna. Follow these steps to connect an outdoor FM antenna to the receiver using 75Ω coaxial cable.

Note: If your antenna has 300Ω twin-lead cable, consult your local RadioShack store for the correct adapter.

1. Disconnect the supplied FM antenna from the receiver's FM UNBAL 75Ω terminal.
2. With a stripping tool, remove about 1½ inches of the outdoor antenna cable's outer insulation to expose the cable's shielding.
3. Fold back the shielding from the inner insulation.
4. Remove about 1 inch of the inner insulation from around the center wire.
5. Pull the shielding to one side. Connect the center wire to the receiver's FM UNBAL 75Ω terminal. Twist the shielding to secure any loose wire strands, and connect it to the FM UNBAL 75Ω ⚡ terminal.

Caution: The cable's shielding should only touch the ⚡ terminal.

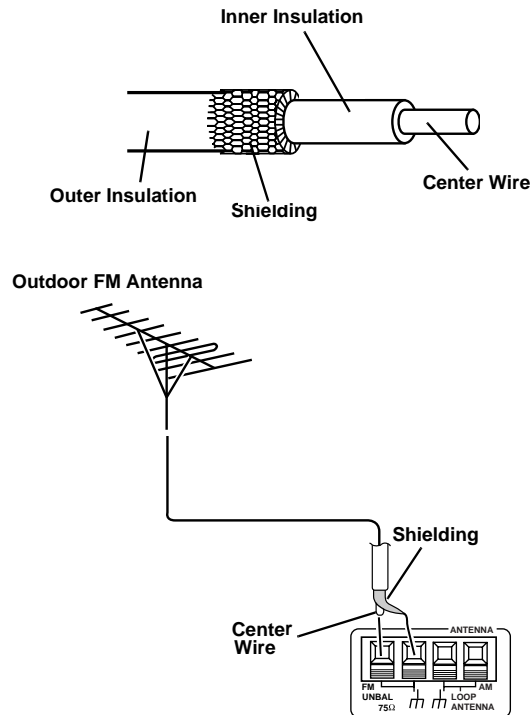

Note: Grounding is not necessary for reception, but we recommend it for better FM reception and to avoid damage from lightning when you use an outdoor FM antenna. Use a separate piece of thick polyvinyl insulated wire to connect the ⚡ terminal to the building's power service grounding electrode system.

Warning: Never connect a wire to a gas pipe for grounding since sparks might ignite the gas.

Preparing Your Receiver

Using One Remote Control for More than One Unit

Note: When you plug the cable into a component's CONTROL IN jack, that component's remote sensor does not function.

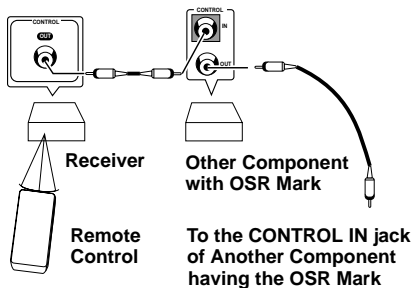

If you also have an Optimus professional series CD player, VCR, or cassette deck with the OSR mark (OSR), you can connect its CONTROL IN jack to the receiver so you can control all of your equipment with a single remote control. You can also use the other component's remote control by pointing it at the receiver's front panel.

1. Connect each component to the receiver as shown in "Connecting Program Sources" on Page 9.

Note: You must connect the audio cables between the receiver and the other audio accessory to use your receiver's remote control to control the accessory.

2. Connect the cable supplied with the CD player, VCR, or cassette deck to the receiver's CONTROL OUT jack and the other component's CONTROL IN jack.
3. When you want to control more than one other component using the receiver's remote control, daisy-chain the CONTROL OUT and CONTROL IN connections as shown.

Installing the Remote Control's Batteries

Your remote control requires two AA batteries (not included) for power. For the best operation and longest life, we recommend alkaline batteries, available at your local RadioShack store.

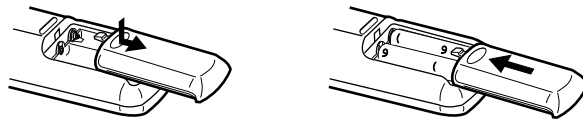

Cautions:

- Use only fresh batteries of the required size and recommended type.
- Always remove old or weak batteries. Batteries can leak chemicals that can damage electronic circuits.

Note: If the remote's range is reduced, replace the batteries.

1. Press and slide open the battery compartment cover.
2. Place two fresh AA batteries in the compartment as indicated by the polarity symbols (+ and -) marked in the compartment.
3. Replace the battery compartment cover.

Preparing Your Receiver

Using the AC Power Outlet

Caution: Do not connect appliances with high power consumption, such as a heater, iron, monitor, or TV, to this AC outlet. Doing so can cause a risk of overheating and fire, and could damage the receiver.

Your receiver has an AC power outlet that you can use to power an electronic device, such as a cassette deck or VCR. This switched outlet turns on and off with the receiver and provides a maximum of 100 watts.

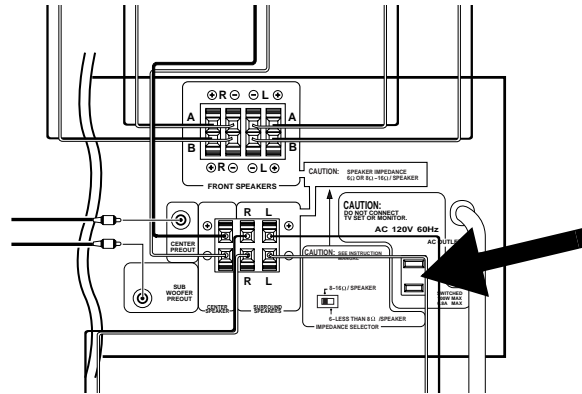

Connecting to AC Power

Warning: To prevent electric shock, do not use this polarized plug with an extension cord, receptacle, or other outlet unless you can fully insert the blades to prevent blade exposure.

Before you plug in the receiver's power cord, double check all other connections.

To power the receiver, plug the supplied power cord into a standard AC outlet. The power cord's plug is polarized and fits only one way.

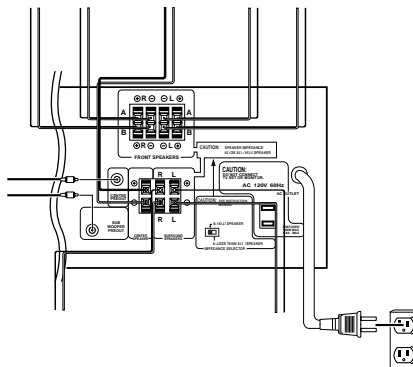

Initial Setup

To obtain the best possible surround sound, you need to set up and adjust your receiver and its components. This is particularly important when you use the  (Dolby) sound mode. These are one-time adjustments and you need not to repeat (unless you change the configuration of your system).

Basic Procedure

1. Press **POWER (RECEIVER POWER)** to turn on the receiver.
2. Press **RECEIVER** located in the center of the remote control to activate remote setup.
3. Press **◀** or **▶** until the component you want to adjust appears on the display. We recommend that you perform adjustments in the order that they appear on the display when you initially set up the receiver.
4. Press **▲** or **▼** to select the option of the displayed component. The setting is automatically entered.
5. Repeat Steps 3 and 4 to adjust the other components.

Speaker Size Setting

1. Press **▶▶** until **F.L.--C.L.--S.L.** appears on the display.
2. Select the front speaker size using **▲** or **▼**. If your speaker systems have a 5-inch or larger cone or if you have not connected a subwoofer, select **L** (large). The receiver sends the bass frequencies to the front speakers. If you use smaller speaker systems, select **S** (small): the receiver sends bass frequencies to the subwoofer.
3. Press **▶▶** to move the cursor to the right and select the center speaker size by pressing **▲** or **▼**. Choose **L** for a 5-inch or larger cone, **S** for a smaller cone, or ***** if you did not connect a center speaker. When you select *****, the center speaker signals are sent to left and right front speakers.
4. Press **▶▶** to move the cursor to the right and select the surround speaker size using **▲** or **▼**: **L** if they are 5-inch or larger, **S** if they are smaller, or ***** if you did not connect surround speakers. When you select *****, the surround speaker signals are sent to the left and right front speakers.

Notes:

- When you select **S** for front speakers, you cannot select **L** for center or surround speakers.
- When you set the front speakers to **S**, the **SUBWF** sets to **ON**.

Subwoofer On/Off Setting

Press **▶▶** until **SUBWF ON** appears on the display and press **▲** or **▼** to turn the subwoofer on or off.

Initial Setup

Crossover Frequency Setting

When you select **S** for any of the speaker's size setting modes, the receiver sends the bass frequencies that were destined for that particular speaker to the subwoofer. This setting determines the frequency that is sent to the subwoofer. If you set all speakers (front, center, and surround) to **L**, you cannot set the crossover frequency (***) appears on the display).

1. Press **▶▶** and **XOVER 100** appears on the display.
2. Press **▲** or **▼** to select the crossover frequency, **100**, **150**, or **200 Hz**.

Low Frequency Effect Attenuator Setting

Dolby Digital audio sources include ultra-low bass tones. Set the Low Frequency Effect (LFE) attenuator as required to prevent this bass tone from distorting speaker sound.

1. Press **▶▶** until **LFEATT 0** appears on the display.
2. Press **▲** or **▼** to select the attenuation level, **0**, **10**, or **** dB**.

Note: The ****** setting, disables the LFE.

Low Cut Filter On/Off Setting

This setting turns the low cut filter for the subwoofer on or off. You cannot adjust this setting if the subwoofer on/off is set to **OFF**.

1. Press **▶▶** until **LCF ON** appears on the display.
2. Press **▲** or **▼** to select **ON** or **OFF**.

Speaker Distance Settings

You can program speaker distance settings for optimal sound in your listening area.

1. Press **▶▶** until **FRT 10ft.** appears on the display.
2. Press **▲** or **▼** to enter the distance between the front speakers and your listening area. Each time you press the button, the distance changes 1 foot (between 1 to 30 feet).
3. Press **▶▶** until **CNT 10ft.** appears on the display.
4. Press **▲** or **▼** to enter the distance between the center speaker and your listening area. Each time you press the button, the distance changes 1 foot (between 1 to 30 feet).
5. Press **▶▶** until **SUR 10ft.** appears on the display.

Note: When the **C*** speaker setting is selected, you cannot set the center speaker's distance.

Initial Setup

Note: When the **S*** speaker setting is selected, you cannot set the surround speaker's distance.

6. Press **▲** or **▼** to enter the distance between the surround speakers and your listening area. Each time you press the button, distance changes for 1 foot (between 1 to 30 feet).

Dynamic Range Control Setting

In Dolby Digital mode, the dynamic range (how loud and soft sounds are produced) is compressed so you can better hear low-level sound. This setting determines the level of compression. Use the **MAX** setting for low volume levels, **OFF** for high volume levels and **MID** for medium volume levels.

1. Press **▶▶** until **DRC OFF** appears on the display.
2. Press **▲** or **▼** to select **OFF**, **MAX**, or **MID**.

Digital Input Setting

Use this setting to assign the rear panel digital input jacks to the desired components. (See "Digital Connections" on Page 12.)

1. Press **▶▶** until **COAX DVD** appears on the display.
2. Press **▲** or **▼** to select the device you connected to rear panel coax digital input, **DVD**, **TV** (satellite receiver or TV tuner), **CD**, **MD**, **VCR**, or **OFF** (no connection).
3. Press **▶▶** until **OPT1 CD** appears on the display.
4. Press **▲** or **▼** to select the device you connected to rear panel OPT1 digital input, **DVD**, **TV** (satellite receiver or TV tuner), **CD**, **MD**, **VCR**, or **OFF** (no connection).
5. Press **▶▶** until **OPT2 CD** appears on the display.
6. Press **▲** or **▼** to select the device you connected to rear panel OPT2 digital input, **DVD**, **TV** (satellite receiver or TV tuner), **CD**, **MD**, **VCR**, or **OFF** (no connection).

Note: We suggest you set the speaker level's when all setup is complete. (See "Adjustment Using Test Tone" on Page 27.)

Basic Operation

Warning: To prevent possible hearing loss, turn **VOLUME** to **MIN** before you turn on the receiver or change the program sources. After you turn on the receiver or change the program source, adjust **VOLUME** to a comfortable listening level.

Note: If you select a source while **TAPE 2 MONITOR** is engaged, **TAPE 2** flashes five times on the display, reminding you to disengage the **TAPE 2 MONITOR** function.

Note: To determine the use of a particular button or control, see "Using the Remote Control" on Page 28 (for the remote control) or "Index to Features by Control Name" on Page 43 (for the front panel) to find the page where the button or control is described.

The controls on the remote control work the same as the buttons on the receiver's front panel, though some are labeled differently.

Follow these steps to use the receiver.

1. Press **POWER** to turn on the receiver's power.
2. Press **SPEAKERS A** or **B** on the front panel (if necessary) so **SP ► A** or **B** appears on the display.
3. Select a program source.

To tune to a radio station, see "Tuning the Radio" on Page 21.

To listen to signals from the component connected to **TAPE 2 MONITOR**, press **TAPE 2 MONITOR** so **TAPE 2** appears on the display.

To listen to a source other than one connected to **TAPE 2 MONITOR**, be sure **TAPE 2** does not show on the display. If necessary, press **TAPE 2 MONITOR** so **TAPE 2** disappears. Then press **VCR**, **DVD/LD** (digital video disc/laser disc), **TV/SAT, VIDEO** (front panel **VIDEO INPUT** jacks), **CD**, **FM/AM** (tuner), or **MD/TAPE 1**, or repeatedly press **FUNC** on the remote control, to display the desired program source.

4. Adjust **VOLUME** clockwise to increase the volume or counterclockwise to decrease it. Or, you can use **VOL -/+** on the remote control. The display shows the current volume setting in **dB**. **-- dB** is the minimum level. Depending on the level setting for each channel, the maximum level can range between **0 dB** and **-10 dB**.
5. To adjust the relative volume levels between speakers, press **RECEIVER** on the remote control. Repeatedly press **CH SELECT** until the speaker for which you want to change volume levels appears on the display, **FL** (front left), **CT** (center), **FR** (front right), **SR** (surround right), **SL** (surround left), and **SW** (subwoofer). Then, adjust the level using **- CH LEVEL +**. You can change the levels within the range of ± 10 **dB**.

You can check the speaker volume levels by making the receiver generate a test tone for each speaker's volume level. See "Adjustment Using Test Tone" on Page 27.

6. Press **< BASS >** or **< TREBLE >** on the receiver to adjust the bass and treble to suit your listening preference.
7. Press **POWER** to turn off the receiver.

Tuning the Radio

Your receiver has four types of electronic tuning — manual, automatic, direct access, and memory.

Note: For weak signals, we recommend manual tuning.

Manual and Automatic Tuning

Follow these steps to manually or automatically tune to stations.

Hint: If none of the tuning buttons on the remote control operate, press **TUNER** first.

1. Press **FM/AM** on the front panel (or repeatedly press **FUNC** on the remote control) until the band name and frequency appears on the display to select the tuner. Then press **FM/AM** (**ENTER** on the remote control) again to select the desired band. The receiver tunes to and displays the frequency last selected in that band.

If **A**, **B**, or **C** and a single digit number appear to the left of the station frequency, press **TUNING SELECT** on the front panel until the band name (**AM** or **FM**) appears. You do not need to press **TUNING SELECT** if you are tuning with the remote control.

2. To manually select the next lower or higher frequency, press **◀ TUNING ▶** (**- TUNE +** on the remote control) once to manually select the next lower or higher frequency. Or, hold down the button to rapidly change frequencies, and release it.

To automatically search for the next lower or higher station, hold down **◀ TUNING ▶** (**- TUNE +** on the remote control) until the display starts to change, then release it. The receiver searches down or up the band to the next strong station.

Notes:

- **TUNED** appears when you receive a strong signal.
- If you press **TUNING ▶** at the top of the frequency range or **TUNING ◀** at the bottom of the frequency range, the display returns to the other end of the range.

Direct Access Tuning (Remote Control Only)

Follow these steps to directly enter a frequency.

1. Repeatedly press **FUNC** to select the tuner. Then press **ENTER** to select the desired band. The receiver tunes to and displays the frequency last selected in that band.
2. Press **MENU**. **__ __ __ __** appears on the display with the first **__** flashing.
3. Enter the desired frequency using the number buttons.

Notes:

- If you enter an invalid frequency (for example, entering 828), the receiver tunes to the closest valid frequency (830 kHz).
- If you do not press a key within 5 seconds, the receiver exits direct access tuning. Start over at Step 2.

Basic Operation

Notes:

- A class is a group of up to 10 station frequencies.
- If you store a frequency in a memory that already contains a frequency, you replace the previous frequency.
- If your receiver is disconnected from AC power for several days, it loses all the stored frequencies.

Memory Tuning

Memory tuning lets you store up to 30 AM or FM frequencies in three different classes (10 frequencies in each class), then quickly tune to a class and station.

Follow these steps to store a station in a memory location using the front panel controls. (You cannot store a station in memory using the remote control.)

1. Press **FM/AM** to select the tuner, then press **FM/AM** again to select the desired band.
2. Tune to the frequency you want to store.

If desired, press **MPX MODE** for FM stereo or monaural sound (see "Using MPX MODE"). This setting is also stored in memory.

3. Press **MEMORY**. The class (**A**, **B**, or **C**) and -- (for the channel number) flash on the display for about 5 seconds.
4. Press **CLASS** until the class you want (**A**, **B**, or **C**) appears, then press **< STATION >** until the channel number you want appears.

In about five seconds, the class and channel number light steadily, indicating the receiver stored the frequency.

To tune to a stored station, press **CLASS** so the desired class number appears, then repeatedly press **< STATION >** to select the channel. Or, you can directly enter the channel number using that number's key on the remote control.

Using MPX MODE

To receive FM stations in stereo, press **MPX MODE** so **MONO** disappears from the display. **STEREO** appears when you receive an FM broadcast in stereo.

You can improve the reception of weak FM stations by pressing **FM MONO** until **MONO** appears. This reduces noise while you listen to a weak FM station, but you get monaural instead of stereo sound.

Using Headphones

To listen using optional headphones (not supplied), insert the headphones' 1/4-inch plug into the receiver's front panel **PHONES** jack and **H.P SP ▶** appears on the display. The speakers are automatically silenced.

Listening Safely

To protect your hearing, note the following when using headphones.

- Set the volume to its lowest setting before you begin listening. After you begin listening, adjust the volume to a comfortable level.
- Do not listen at extremely high volume levels. Extended high-volume listening can lead to permanent hearing loss.
- Once you set the volume, do not increase it. Over time, your ears adapt to the volume level, so a volume level that does not cause discomfort might still damage your hearing.

Basic Operation

Muting the Receiver

To temporarily mute the sound, press **MUTING** on the remote control. **--MUTING --** appears. Press **MUTING** again to restore the audio level.

Loudness Control

To increase the high and low ranges of sounds for improved audio at a low listening level, press **LOUDNESS** on the front panel so **LOUDNESS** appears. Press **LOUDNESS** again to turn off this feature.

Bypassing the Sound Controls

To bypass your receiver's sound controls (**BASS**, **TREBLE** or any special sound options) so you can hear the audio at its original tonal quality (for example), press **DIRECT** so **DIRECT** appears. Press **DIRECT** again to turn off this feature.

Note: When you turn off the bypass feature, you will have to reselect any desired special sound options (see "Using Advanced Sound Options" on Page 26).

Adjusting the Display Brightness

You can change the display brightness so it is easy for your eyes in a dark environment. Press **DIMMER** on the remote control repeatedly until you reach the desired brightness level.

Switching Analog/Digital Signal Input

When you connect a device to any of the rear panel digital input jacks, you must switch the input signal for digital or analog.

Select the device desired, then press **SIGNAL SELECT** (**RECEIVER** followed by **SIG SELECT** on the remote control). Each time you press the button the input mode is switched between **ANALOG** and **DIGITAL** as shown on the display. When the Dolby Digital signal is input, **AC-3** appears on the display.

Notes:

- **SIGNAL SELECT** does not function for any analog device or device that is not assigned to any of the digital input jacks.
- Some laser discs have only analog audio signals. If your laser disc is this type, use the **ANALOG** setting.
- The receiver accepts Dolby Digital or PCM (32 kHz/44 kHz/48 kHz) digital signals only. For other formats of digital signals, use the **ANALOG** setting.

Using ATT

During analog operation, if the receiver receives signals that are too strong, the overload indicator (a dot above the 2nd character position) lights. If this happens, press **ATT** on the remote control to lower the signal and prevent the distortion. **ATT** lights on the display.

Cassette Deck/VCR Features

You can connect two cassette decks to the receiver. Selecting either **MD/TAPE 1** or **TAPE 2 MONITOR** lets you hear the playback from the cassette deck you connected to the receiver's corresponding (**MD/TAPE 1** or **TAPE 2 MONITOR**) jacks.

Using the MD/TAPE 1 and TAPE 2 MONITOR Buttons

Press **MD/TAPE 1**. **MD/TAPE1** appears on the display. You hear the playback from the cassette deck or VCR you connected to the receiver's **MD/TAPE 1 IN** jacks.

Press **TAPE 2 MONITOR**. **TAPE 2** appears on the display along with the last program source you selected. You can hear playback or monitor a recording from the cassette deck you connected to the receiver's **TAPE 2 MONITOR** jacks. The **TAPE 2 MONITOR REC** jacks continue to output sound from the previously selected source after you press **TAPE 2 MONITOR**.

To return to the previous source, press **TAPE 2 MONITOR** again so **TAPE 2** disappears.

Notes:

- If you press **TAPE 2 MONITOR** when that cassette deck is neither playing nor recording, the receiver mutes the current audio source. To hear the audio source, press **TAPE 2 MONITOR** so **TAPE 2** disappears from the display.
- Do not press **TAPE 2 MONITOR** while you are recording on the deck connected to **TAPE 2 MONITOR REC**, because it interrupts the recording for about 1 second.

Monitoring a Program Source

The receiver sends the audio of the program source you select—**VCR**, **DVD/LD**, **TV/SAT**, **VIDEO**, **CD**, or **FM/AM** (tuner)—to the **MD/TAPE 1 OUT/REC** and **TAPE 2 MONITOR OUT/REC** jacks. If you select one of the audio/video source, the video program is also sent to the **VIDEO OUT TO MONITOR TV** jack.

The **VOLUME** control does not affect the level of the signal going to the tape decks.

Dubbing a Cassette Tape

You can copy (dub) a cassette tape from one cassette deck to another through the **STAV-3790**.

You can use either deck as the playback or recording deck. However, if you want to monitor the cassette deck during dubbing, use the deck connected to the **MD/TAPE 1** jacks as the source, and the deck you connected to the **TAPE 2 REC** jacks as the recording deck. Then press **TAPE 2 MONITOR** so **TAPE 2** and the last program source you selected appear on the display. (See "Using the MD TAPE 1 and TAPE 2 MONITOR Buttons".)

The **VOLUME** control does not affect the level of the signal going to the tape decks.

Note: The receiver passes through the original signals as they are. Therefore, you cannot dub the digital signal to analog signal or vice versa.

Cassette Deck/VCR Features

Playing and Recording Video Tapes

You can connect four video sources to the receiver. If you connect a VCR to the VCR and another VCR or camcorder to DVD/LD, TV/SAT, or front panel VIDEO INPUT audio and video jacks, you can copy video cassette tapes from one VCR to another and monitor the dubbing process.

Playing a Video Tape

To play a video tape, insert the tape into the VCR. Press the button (VCR, DVD/LD, TV/SAT, or VIDEO) that corresponds to the jack to which the VCR is connected. The selected function name appears on the display. Follow the VCR's instructions to begin playback. If you connected a monitor to the receiver's TO MONITOR TV jack, you can view the program on that monitor.

Copying a Video Tape

Follow these steps to copy a video tape from one VCR or camcorder to another through the STAV-3790.

1. Insert the tape you want to copy into the VCR or camcorder connected to DVD/LD, TV/SAT, or VIDEO INPUT.
2. Insert a blank tape (or one you want to record over) into the VCR connected to the VCR jacks.
3. Press the button that corresponds to the jack to which the playback VCR or camcorder is connected.
4. Begin recording and playback on the VCRs/camcorder.

Important: Most material performed in public, such as concerts, plays, and movies, or distributed on prerecorded video tapes is copyrighted. The unauthorized recording or duplication of copyrighted material is a violation of the copyright laws of most countries and such duplication may result in fines, imprisonment, or both. Note, however, that in the United States, it is not a violation of U.S. copyright laws for a consumer to record a broadcast television program for private (in-home) viewing.

Using Advanced Sound Options

Your receiver has three special sound options: Dolby Digital, Dolby Pro Logic Surround, and DSP Effect. These special options enhance the sound from a connected program source.

Notes:

- To get the full benefit from programs encoded with Dolby Surround Sound, you need a stereo VCR or DVD/LD player.
- Dolby Surround does not operate correctly if the signal passes through a graphic equalizer. If you connected an equalizer to the **TAPE 2 MONITOR** jacks, do not select **TAPE 2 MONITOR** when you listen to Dolby Surround signals.

To turn on Dolby Digital or Dolby Pro Logic Surround, press **PRO LOGIC**. **PRO LOGIC** appears on the display. The receiver automatically judges whether the received signal is Dolby Digital or Dolby Pro Logic Surround and switches itself to the correct mode. When the receiver receives 5.1-channel Dolby Digital signal, **DIGITAL** lights on the display.

To turn on a DSP effect, press **DSP MODE** until the desired option appears on the display along with **SFC**.

Dolby Digital

Dolby Digital is a compression format that records the sound of six channels (front L/R, center, surround L/R, and subwoofer). Since the subwoofer has a smaller frequency range, the term 5.1-channel is used. All channels' sounds are digitally compressed using a method called AC-3. When playing back, the masking and digital filtering technology yields the best sound quality. The LFE (low frequency effect) technique adds strong bass sounds. See "Low Frequency Effect Attenuator Setting" on Page 18 to set the LFE level. When the source signal has an LFE channel, **LFE** lights on the display and the indicator next to it lights when the receiver actually receives LFE signal.

Dolby Pro Logic Surround

Dolby Pro Logic Surround puts you in the middle of the action. The center- and rear-channel speakers add incredible realism by directing the sound to the appropriate speakers.

DSP Effect

You can choose one of five DSP effects — **HALL 1**, **HALL 2**, **JAZZ**, **DANCE**, **THEATER 1**, or **THEATER 2**. Hall 1 simulates a large concert hall, Hall 2 simulates a concert hall with stone walls, and both are best suited for classical music. Jazz provides the acoustic effects generally heard in jazz clubs. Dance gives the effect of a discotheque. Both theater modes provide the effect of a movie theater. **THEATER 1** sounds like a large movie theater. **THEATER 2** seems like a smaller theater. Try each setting to find the best effect for your programs.

To change the DSP effect level, press **DSP MODE** (on the receiver or remote control), then hold down **- EFFECT +** (on the remote) to change the effect level. The effect can vary depending on the source program.

Using Advanced Sound Options

Adjustment Using Test Tone

The test tone lets you balance the signal levels between all your speakers.

To turn on the test tone, press **□□** then press **TEST TONE**. The receiver sounds a 2-second tone from the front left, center, front right, and surround right, surround left, subwoofer, in sequence. **FL**, **CT**, **FR**, **SR**, **SL**, and **SW** appear as the test tone sounds.

Note: The test tone sounds only for the speakers that you connected and activated as described in “Initial Setup.”

Press **- CH LEVEL +** while the test tone sounds for the speaker you want to adjust.

Press **TEST TONE** again to turn off this feature.

Dolby Digital Playback

When you want to play a source that has Dolby Digital audio signal, set the source to digital mode (see “Switching Analog/Digital Signal Input” on Page 23) and press **□□**. Then activate the source device. **□□ DOLBY DIGITAL** appears on the display as the receiver receives the Dolby Digital signals.

Note: When you connect a DVD/LD player that uses AC-3 RF output, you need to connect an optional RF demodulator.

DVD 5.1-Channel Playback

When you connect a multi-channel decoder or DVD player with 5.1-channel output (see “DVD 5.1-Channel Inputs” on Page 11), press **DVD/LD** on the front panel twice (once to select the DVD/LD function, once to set the receiver to 5.1-channel mode). **DVD 5.1ch** appears on the display.

When you select this **□□** mode **DSP mode**, **SIGNAL SELECT**, **ATT**, **DIRECT**, **TREBLE**, **BASS**, **MIDNIGHT** are disabled.

Using the Midnight Mode

You can compensate for the effect of sound deterioration at low listening levels to enjoy the surround sound of your favorite movie whenever you desire.

Press **MIDNIGHT MODE** (**MIDNIGHT** on the remote control) so **MIDNIGHT** appears on the display. Press the button again to disable this feature.

Program Format Indicators

The following indicators light to show the channels being played.

In 5.1-channel Dolby Digital mode: **L** (left front), **C** (center), **R** (right front), **LS** (left surround), and **RS** (right surround).

In Dolby Surround mode: **L** (left front), **R** (right front), and **S** (surround).

Using the Remote Control

The remote control works up to a distance of about 23 feet, and within a 30-degree angle on either side of the receiver. Point the control at the receiver's front panel and press the desired button(s).

Many buttons on the remote control work the same as buttons on the receiver's front panel. Use these buttons exactly as you would use the corresponding buttons on the receiver.

CONTROL MODE Buttons

The CONTROL MODE buttons select the device you want to control. The remote control can operate the basic functions of your other audio/video devices. Follow these steps to recall and program the remote control with the correct manufacturer's code number for the device.

Note: Some brands have more than one code listed in the charts. If a code does not work with your device, try another. The listed codes might not work with all models from the listed manufacturers.

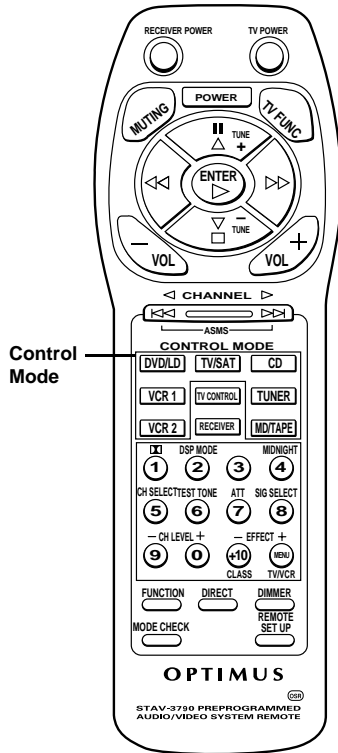

1. While holding REMOTE SET UP, press 1. All the CONTROL MODE buttons start to flash and PUSHFUNC flashes on the display.
2. Press the CONTROL MODE button for the device you want to set the code. For example, to set the code for CD player, press CD.

DVD/LD: DVD or LD player
 TV/SAT: TV or satellite tuner
 CD: CD player/changer
 MD/TAPE: MD recorder or tape recorder
 VCR1: VCR or cassette deck
 VCR2: VCR or cassette deck
 TV CONTROL: TV or CATV tuner

The selected CONTROL MODE button lights steadily and the first manufacturer name and its preset code appear alternately on the display.

3. Repeated press ▲ or ▼ to display the name of the manufacturer of your device. The selected manufacturer name and its preset code flashes alternately. The list of all the available preset codes is located in the back of this manual.
4. Point the remote control to the device desired, and enter the three-digit code. The remote control sends the power on/off signal. If the device turns on or off, you have set the correct code.

If the device does not turn on/off, press ◀ or ▶ to display other codes for the selected manufacturer. If you try every preset code and the device still does not function, you must use the original remote control supplied with your device.

5. Press REMOTE SET UP to exit the preset mode.

You can clear all the programmed codes if necessary. Press REMOTE SET UP and 0 at the same time for about three seconds until all the CONTROL MODE buttons blink three times.

Using the Remote Control

Receiver/Amplifier Operation

Before operation, press **TUNER** to select receiver/amplifier operation.

RECEIVER POWER	Turns the STAV-3790 on/off.
MUTING	Silences the receiver. Press again to restore the sound to its previous level.
- TUNE +	Tunes to radio stations.
ENTER	Selects the AM or FM tuner band.
- VOL +	Adjusts the system's volume.
◁ CHANNEL ▷	Tunes to the next higher or lower memory location.
CLASS	Selects the memory class.
MENU	Allows direct input of the station frequency.
Number Buttons	Selects the corresponding memory station. During Direct Access, enter the station's frequency.
□	Activates Dolby Digital or Dolby Pro Logic Surround mode when pressed after RECEIVER .
DSP MODE	Selects the DSP mode; HALL, JAZZ, DANCE, THEATER 1, or THEATER 2.
MIDNIGHT	Activates the midnight operation mode when pressed after RECEIVER .
CH SELECT	Selects the channel to set the speaker sound level when pressed after RECEIVER .
TEST TONE	Sounds test tones from each speaker when pressed after RECEIVER .
ATT	Attenuates (lowers) the signal level when pressed after RECEIVER .
SIG SELECT	Selects the input signal, digital or analog, when pressed after RECEIVER .
- CH LEVEL +	Sets the level of the channel selected by CH SELECT when pressed after RECEIVER .
- EFFECT +	Adjusts the level of DSP mode when pressed after RECEIVER .
FUNCTION	Selects a program source (VCR, PHONO, tuner, CD, DVD/TV, or LD/SAT). Repeatedly press until the display shows the desired program source.
DIRECT	Bypasses the receiver's audio control circuits. Press again to restore the previous settings.
DIMMER	Dims the display.
MODE CHECK	Press to show the current operation mode of the remote control. The currently active CONTROL MODE button lights.

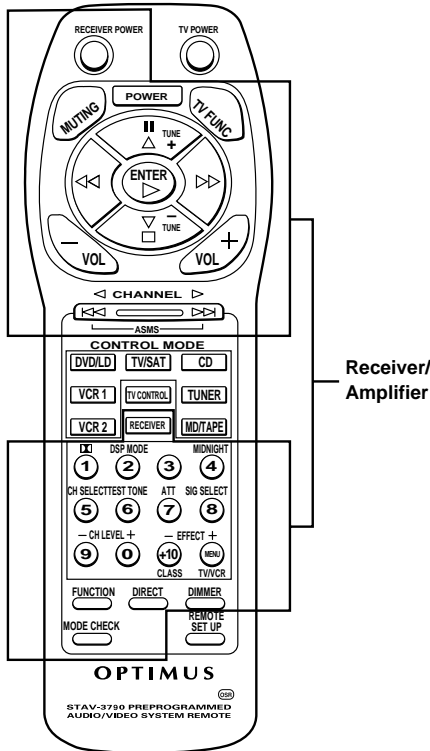

Using the Remote Control

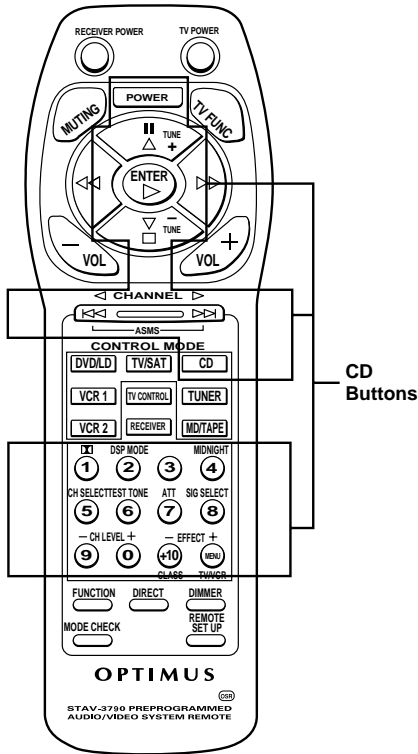

CD Player/MD Recorder Operation

Note: You must have connected the CD player to both of your receiver's **CONTROL OUT** and audio jacks or programmed the code for your CD player/MD recorder into the remote control for these functions to work.

Before operation, press **CD** to select CD player operation.

- | | |
|------------------------------|---|
| POWER | Turns the CD player/MD recorder on and off. |
| ■ | Press to pause play. Press again to resume. Press together with ■ to start recording on MD recorder. |
| ▶ | Plays the disc. |
| ◀◀ / ▶▶ | Rapidly advances backward/forward within a track. |
| ◀◀ / ▶▶ | Returns to the beginning of the current track or advances to the next track. |
| ■ | Stops playback. Press together with ■ to start recording on the MD recorder. |
| Number Buttons | Selects track. |
| +10 | Enters 10 of the track number. For example, to enter track 15, press +10 then 5 (might not work with some CD players). |
| MENU (CD player only) | Selects discs in a multi-play CD changer (might not work with some CD players). Enter the disc number using the number buttons then press MENU . |

Cassette Deck Operation

Note: You must have connected the cassette deck to both your receiver's **CONTROL OUT** and audio jacks for these functions to work when using an Optimus Professional Series cassette deck with the OSR (OSR) mark (see "Using One Remote Control for More than One Unit" on Page 15). If you are using any other brand of cassette deck, you must program the remote control with the appropriate code. Otherwise, the remote control will not operate. (See "Using the Remote Control" on Page 35 for a listing of codes.)

Before operation, press **TAPE** to select cassette deck operation.

The remote control operates a single cassette deck and Deck 2 on a dual cassette deck. To operate Deck 1 on a dual cassette deck, use the buttons shown in parentheses (these buttons do not work with all decks).

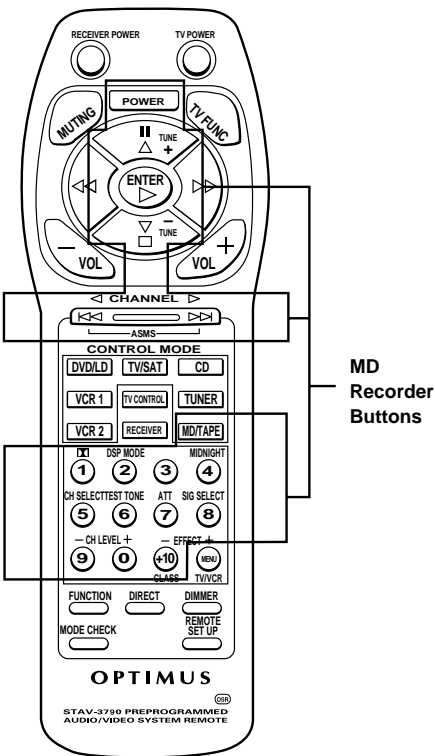

- | | |
|------------------------|---|
| POWER | Turns on/off the cassette deck. |
| ■ | Press to temporarily stop playback/recording. Press again to resume. Press together with ■ to start recording. |
| ▶ (3) | Press to start normal playback. |
| ■ (2) | Stops playback/recording. Press together with ■ to start recording. |
| ◀◀ (1) / ▶▶ (4) | Quickly locates and plays the beginning of recorded material during play.
Or, when the tape is stopped, rapidly searches forward or backward to locate a specific section of the tape. |

Using the Remote Control

DVD/LD Player Operation

Note: You must have programmed the code for your DVD or LD player into the remote control for these functions to work.

Before operation, press **DVD/LD** to select DVD/LD player operation.

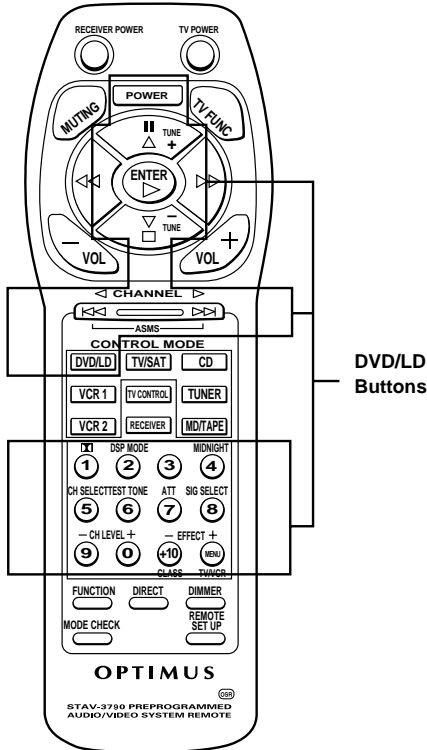

- POWER** Turns on/off the DVD/LD player.
- Press to pause play. Press again to resume. On some DVD players, press to pause the playback so you can view a single frame (freeze-frame operation).
- ▶** Plays the disc.
- Stops playback.
- ◀▶** Rapidly advances backward/forward within a chapter/track.
- ◀◀ / ▶▶** Returns to the beginning of the current chapter/track or advances to the next chapter/track.
- Number Buttons** Selects chapter/track.
- +10** Enters 10 of the chapter/track number. For example, to enter chapter/track 15, press **+10** then **5**.
- MENU** Turns the menu on/off on DVD player, selects the side of a disc on the LD player.

Press the **DVD/LD CONTROL MODE** button twice in succession to enable following operation with some number buttons.

- 2** Up arrow (▲).
- 3** ENTER
- 6** Right/left arrow (◀▶)
- 8** MENU
- 9** TITLE

Using the Remote Control

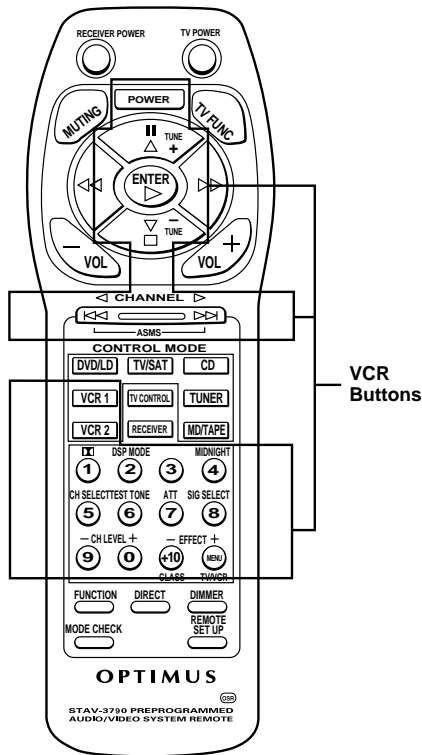

VCR Buttons

VCR Operation

Note: You must have programmed the code for your VCR into the remote control for these functions to work.

Before operation, press **VCR1** or **VCR2** (the one you assigned your VCR operation) to select VCR operation.

- | | |
|-----------------------|---|
| POWER | Turns on/off the VCR. |
| ■ | Press to temporarily stop playback/recording. Press again to resume. Press together with ■ to start recording. |
| ▶ | Press to start normal playback. |
| ■ | Stops playback/recording. Press together with ■ to start recording. |
| ◀/▶ | Quickly locates and plays the beginning of recorded material during play.
Or, when the tape is stopped, rapidly searches forward or backward to locate a specific section of the tape. |
| ◀ CHANNEL ▶ | Press to change the VCR's tuner channel. |
| Number Buttons | Selects channel directly (might not work with some VCRs). |
| +10 | With some VCRs, you might need to press this to enter the channel you selected with number buttons. |
| TV/VCR | Press to switch the VCR antenna output, VCR's tuner output or direct signal from antenna to use TV's tuner. |

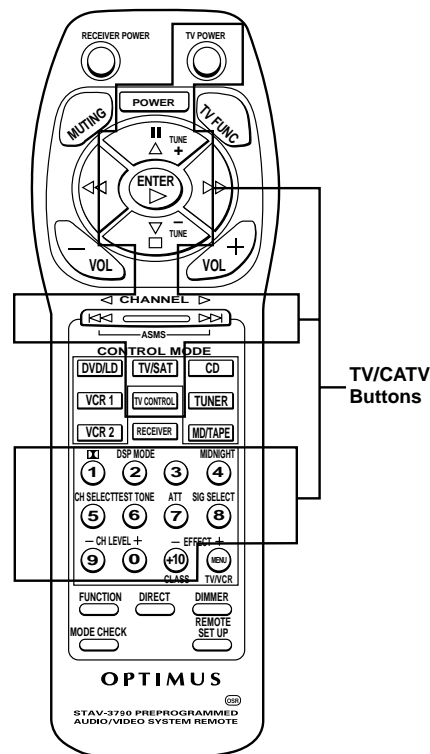

TV/CATV Buttons

TV/CATV Operation

Note: You must have programmed the code for your TV into the remote control for these functions to work.

Before operation, press **TV CONTROL** or **TV/SAT** (the one you assigned your TV operation) to select TV operation.

- | | |
|-----------------------|--|
| TV POWER | Turns on/off the TV. This button works in any remote operation mode. (Operative for the TV assigned to the TV CONTROL button only.) |
| POWER | Turns on/off the TV. |
| ▲/▼ | Increases/decreases the TV volume. |
| ◀ CHANNEL ▶ | Press to change the tuner channel. |
| TV FUNC | Selects the TV's input mode, antenna or line input. This button works in any remote operation mode. |
| - VOL + | Adjusts the volume. |
| Number Buttons | Selects channel directly. |

Using the Remote Control

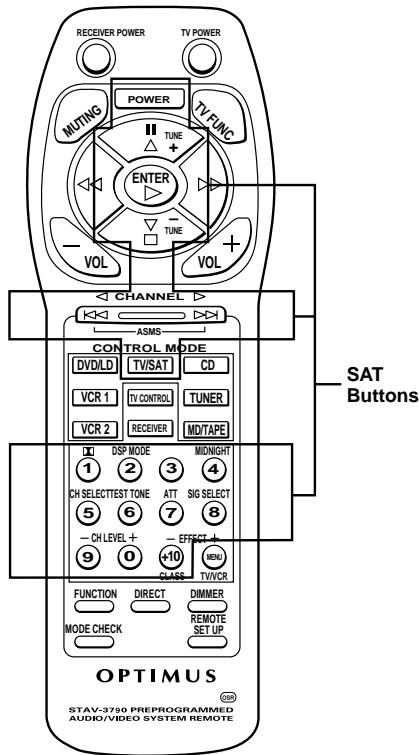

Satellite Receiver Operation

Note: You must have programmed the code for your SAT receiver to the remote control for these functions to work.

Before operation, press TV/SAT receiver to select SAT receiver operation.

POWER	Turns the power on.
◀/▶/▲/▼	Moves the cursor left/right/up/down.
ENTER	Selects the position selected by the cursor buttons ◀/▶/▲/▼.
 ◀◀ / ▶▶ 	Turns the program information screen on/off.
Number Buttons	Selects channel directly.
MENU	Turns the menu on/off.

Background Control

You can control one device while listening to another. For example, you can rewind a tape while listening to CD.

1. While operating one device, press **MODE CHECK**. The current selected **CONTROL MODE** button lights.
2. Repeatedly press **MODE CHECK** so the button for the device you want to control lights.
3. Operate the newly selected device.
4. Press **MODE CHECK** so the original **CONTROL MODE** button lights. You can also press the original button to return to the original function.

Using the Remote Control

Following is the list of the pre-programmed remote control codes for other devices.

DVD Brand	Code
Akai	007
JVC	004
Panasonic	003
Pioneer	000,003
RCA	009
Samsung	005
Sharp	006
Sony	002
Toshiba	001
LD Brand	Code
Kenwood	103
Mitsubishi	100
Panasonic	105,106
Philips	104
Pioneer	100
RCA	107
Sony	101
SAT Brand	Codes
Pioneer	200
RCA	201,203
Sony	202

Using the Remote Control

VCR Brand	Code
Fisher	410,426,412,427,425,420
Goldstar	411,409
Grandiente	452
Hitachi	408,401,406,436,434
JVC	428,430,429,408,414,431,407
Magnavox	414,408,426,403
Mitsubishi	409,420,421,422,423,424,408,407
Optimus	408,432,433,402,418,419
Panasonic	408,432,433
Pioneer	400,453
RCA	401,406,408,414,405,413,411,415
Sanyo	410,412,425,435
Sharp	402,418,419
Sony	416,417,404,408
Toshiba	405,409,426
Zenith	403,404,417
TAPE Brand	Code
Denon	810
Fisher	813
JVC	802
Kenwood	804,807
Onkyo	809,808
Optimus	800
Pioneer	800
Sony	801,806
TEAC	805
Technics	803
Yamaha	811,812

Using the Remote Control

CD Brand	Code
Denon	309
JVC	303
Kenwood	310,321,311
Marantz	323,312,324
Onkyo	320,308,307
Optimus	300
Philips	312,322
Pioneer	300
RCA	302,319,313
Sanyo	313
Sony	301,316,317,318
TEAC	305,306,327,324,325
Technics	304,326
Yamaha	315,314,328
TV Brand	Code
GE	601,608,607,610,611,617,602,628,618
Goldstar	610,623,621,602
Grandiente	635
Hitachi	606,610,624,625,618
JVC	613,623
Magnavox	607,610,603,612,629
Mitsubishi	609,610,602,621
Panasonic	608,622,607
Philips	607
Pioneer	600
RadioShack	610,623,621,602
RCA	601,610,615,616,617,618
Sanyo	621,614
Sharp	602,619,627
Sony	604
Toshiba	605,602,626,621
Zenith	603,620

Using the Remote Control

CATV Brand	Code
Jerrold	711,701,702,712,704,713,703,714,716,715
Pioneer	700
S.A.	705,706,708,709
Zenith	707,717,710
MD Brand	Code
Denon	906
Kenwood	903
Onkyo	905
Pioneer	900, 902
Sharp	902
Sony	901
TEAC	904

Troubleshooting

If the receiver is not working as it should, the following suggestions might help. If you follow the suggestions in this chart and the receiver still does not work properly, contact your local RadioShack store for assistance.

Problem	Cause	Suggestion
Power does not turn on.	Power cord is disconnected.	Plug in the power cord.
	Protection circuit is activated.	Unplug the power cord, then plug it in again.
The receiver does not respond to button presses.	Static discharge has affected the receiver.	Unplug the power cord, then plug it in again. (If static electricity is a problem, use the remote control as much as possible.)
No sound.	Incorrect connections.	Check and correct the connections.
	The mute function is activated.	Press MUTING .
	The volume is turned down.	Turn up the volume.
	Speaker wires are disconnected.	Connect the speaker wires.
	Speakers are turned off.	Press SPEAKER so SP▶A appears on the display. Disconnect the headphones if connected.
	TAPE 2 function is engaged.	Press TAPE 2 so TAPE 2 clears from the display.
No picture when you select a video source.	The selected video source is not set correctly.	Correct the problem with the selected video source.
	Incorrect connections.	Check and correct the connections.
High noise level.	Station not correctly tuned.	Adjust tuning.
	Antenna not connected.	Connect the antenna.
	FM antenna still coiled or is not pointing in the correct direction.	Stretch both ends of the antenna taut and reposition the antenna.
	AM loop antenna not pointing in the correct direction.	Adjust the AM loop antenna.
	Noise is coming from another electrical appliance.	Try using an AC line noise filter to reduce the noise.
Automatic tuning does not stop when searching for stations.	Stations are too weak.	Use a better antenna.
Cannot make copies of video tapes.	Tapes are protected by a copy protection method.	You cannot make a good copy.
	Video connections are incorrect.	Check and correct the connections.
Remote control does not work.	Remote is set to other device.	Press the CONTROL MODE button for the device to control.
	Batteries are weak.	Replace the batteries.
Remote does not control cassette deck or CD player.	Cassette deck or CD player is not compatible.	The feature only works with Optimus Professional Series components.
	Control cable is not plugged in.	Properly connect the control cable.
	Audio cables are not plugged in.	Properly connect the audio cables.

Care and Maintenance

Your Optimus STAV-3790 Audio/Video Receiver is an example of superior design and craftsmanship. The following suggestions will help you care for the receiver so you can enjoy it for years.



Keep the receiver dry. If it gets wet, wipe it dry immediately. Liquids can contain minerals that can corrode the electronic circuits.



Handle the receiver gently and carefully. Dropping it can damage its circuit boards and can cause the receiver to work improperly.



Use and store the receiver and its remote control only in normal temperature environments. Temperature extremes can shorten the life of electronic devices, damage batteries, and distort or melt plastic parts.



Keep the receiver away from dust and dirt, which can cause premature wear of parts.



Wipe the receiver with a damp cloth occasionally to keep it looking new. Do not use harsh chemicals, cleaning solvents, or strong detergents to clean the receiver.



Use only fresh batteries of the recommended size and type in the remote control. Always remove old or weak batteries. They can leak chemicals that can destroy electronic circuits.

Modifying or tampering with your receiver's internal components can cause a malfunction and might invalidate the receiver's warranty and void your FCC authorization to operate it. If the receiver is not operating as it should, take it to your local RadioShack store for assistance.

The FCC Wants You to Know

Your receiver might cause radio or TV interference even when it is operating properly. To determine whether your receiver is causing the interference, turn off your receiver. If the interference goes away, your receiver is causing it. Try to eliminate the interference by:

- Moving your radio or TV away from the receiver
- Connecting your receiver to an outlet that is on a different electrical circuit from the radio or TV
- Contacting your local RadioShack store for help

If you cannot eliminate the interference, the FCC requires that you stop using your receiver.

Specifications

Amplifier

Front Channel Average Power Output	100 Watts per Channel into 8 Ohms From 20 to 20,000 Hz, With No More than 0.09% Total Harmonic Distortion Measured Pursuant to the Federal Trade Commission's Trade Regulation Rule on Amplifier Output Power Claims
Front Channel Surround Power Output	100 Watts per Channel (1 kHz, 0.8% THD, 8 Ohms)
Center Channel Surround Power Output	100 Watts (1 kHz, 0.8% THD, 8 Ohms)
Continuous Rear Surround Power Output	100 Watts per Channel (1 kHz, 0.8% THD, 8 Ohms)
Input Sensitivity/Impedance	
CD, DVD/LD, TV/SAT, VCR, VIDEO, MD/TAPE, TAPE 2 MONITOR	200 mV/47 kOhms
Frequency Response	
CD, DVD/LD, TV/SAT, VCR, VIDEO, MD/TAPE, TAPE 2 MONITOR	5 Hz to 100,000 Hz +0/-3 dB
Output Level/Impedance	
VCR REC, MD/TAPE REC, TAPE 2 MONITOR REC	200 mV/2.2 kOhms
Tone Controls	
Bass	±6 dB (100 Hz)
Treble	±6 dB (10 kHz)
Loudness	+9 dB/+7 dB (100 Hz/10 kHz)
Signal-to-Noise Ratio (IHF, Short Circuited, A Network)	
CD, DVD/LD, TV/SAT, VCR, VIDEO, MD/TAPE, TAPE 2 MONITOR	97 dB
Signal-to-Noise Ratio (EIA, at 1 Watt, 1 kHz)	
CD, DVD/LD, TV/SAT, VCR, VIDEO, MD/TAPE, TAPE 2 MONITOR	80 dB

Video Section

Input Sensitivity/Impedance VCR, DVD/LD, TV/SAT, VIDEO	1 Volt Peak-to-Peak/75 Ohms
Output Level/Impedance VCR, MONITOR	1 Volt Peak-to-Peak/75 Ohms
Frequency Response VCR, MONITOR	5 Hz to 7 MHz +0/-3 dB
Signal-to-Noise Ratio	55 dB
Crosstalk	55 dB

Specifications

FM Tuner

Frequency Range	87.5 to 108 MHz
Usable Sensitivity	Mono: 13.2 dBf, IHF (1.3 μ V/75 Ohms)
50 dB Quieting Sensitivity	
Mono	20.2 dBf
Stereo	38.6 dBf
Signal-to-Noise Ratio	
Mono	73 dB (at 85 dBf)
Stereo	70 dB (at 85 dBf)
Distortion	Stereo: 0.5% (1 kHz)
Alternate Channel Selectivity	60 dB (400 kHz)
Stereo Separation	40 dB (1 kHz)
Frequency Response	30 Hz to 15 kHz (\pm 1 dB)
Antenna Input	75 Ohms Unbalanced

AM Tuner

Frequency Range	530 to 1700 kHz
Sensitivity (IHF, Loop Antenna)	350 μ V/m
Selectivity	25 dB
Signal-to-Noise Ratio	50 dB

General

Power Requirements	120 Volts AC, 60 Hz
Power Consumption	280 Watts
AC Outlet Ratings Switched	Total 100 Watts (0.8 Amps) Maximum
Dimensions (HWD)	6 ¹ / ₄ × 16 ⁹ / ₁₆ × 15 ³ / ₈ Inches (158 × 420 × 391 mm)
Weight	21 lb 10 oz (9.8 kg)

Specifications are typical; individual units might vary. Specifications are subject to change and improvement without notice.

Index to Features by Control Name

This table lists the control and indicator names found on the front of your receiver, along with the page number where the control or indicator is discussed. To find a description for the buttons on the remote control, see "Using the Remote Control" on Page 28

Control	Page
	26
BASS	20
CD	20
CLASS	22
DIRECT	23
DSP MODE	26
DVD/LD	20
FM/AM	21
LOUDNESS	23
MD/TAPE	20
MEMORY	22
MIDNIGHT MODE	27
MPX MODE	22
PHONES	22
POWER	20
SIGNAL SELECT	23
SPEAKERS A/B	20
◁ STATION ▷	22
TAPE 2 MONITOR	20, 24
TREBLE	20
◁ TUNING ▷	21
TUNING SELECT	21
TV/SAT	20
VCR	20, 25
VIDEO	20
VIDEO INPUT	11
VOLUME	20

Limited Two-Year Warranty

This product is warranted by RadioShack against manufacturing defects in material and workmanship under normal use for two (2) years from the date of purchase from RadioShack company-owned stores and authorized RadioShack franchisees and dealers. EXCEPT AS PROVIDED HEREIN, RadioShack MAKES NO EXPRESS WARRANTIES AND ANY IMPLIED WARRANTIES, INCLUDING THOSE OF MERCHANTABILITY AND FITNESS FOR A PARTICULAR PURPOSE, ARE LIMITED IN DURATION TO THE DURATION OF THE WRITTEN LIMITED WARRANTIES CONTAINED HEREIN. EXCEPT AS PROVIDED HEREIN, RadioShack SHALL HAVE NO LIABILITY OR RESPONSIBILITY TO CUSTOMER OR ANY OTHER PERSON OR ENTITY WITH RESPECT TO ANY LIABILITY, LOSS OR DAMAGE CAUSED DIRECTLY OR INDIRECTLY BY USE OR PERFORMANCE OF THE PRODUCT OR ARISING OUT OF ANY BREACH OF THIS WARRANTY, INCLUDING, BUT NOT LIMITED TO, ANY DAMAGES RESULTING FROM INCONVENIENCE, LOSS OF TIME, DATA, PROPERTY, REVENUE, OR PROFIT OR ANY INDIRECT, SPECIAL, INCIDENTAL, OR CONSEQUENTIAL DAMAGES, EVEN IF RadioShack HAS BEEN ADVISED OF THE POSSIBILITY OF SUCH DAMAGES.

Some states do not allow the limitations on how long an implied warranty lasts or the exclusion of incidental or consequential damages, so the above limitations or exclusions may not apply to you.

In the event of a product defect during the warranty period, take the product and the RadioShack sales receipt as proof of purchase date to any RadioShack store. RadioShack will, at its option, unless otherwise provided by law: (a) correct the defect by product repair without charge for parts and labor; (b) replace the product with one of the same or similar design; or (c) refund the purchase price. All replaced parts and products, and products on which a refund is made, become the property of RadioShack. New or reconditioned parts and products may be used in the performance of warranty service. Repaired or replaced parts and products are warranted for the remainder of the original warranty period. You will be charged for repair or replacement of the product made after the expiration of the warranty period.

This warranty does not cover: (a) damage or failure caused by or attributable to acts of God, abuse, accident, misuse, improper or abnormal usage, failure to follow instructions, improper installation or maintenance, alteration, lightning or other incidence of excess voltage or current; (b) any repairs other than those provided by a RadioShack Authorized Service Facility; (c) consumables such as fuses or batteries; (d) cosmetic damage; (e) transportation, shipping or insurance costs; or (f) costs of product removal, installation, set-up service adjustment or reinstallation.

This warranty gives you specific legal rights, and you may also have other rights which vary from state to state.

RadioShack Customer Relations, Dept. W, 100 Throckmorton St., Suite 600, Fort Worth, TX 76102

We Service What We Sell

3/97

RadioShack
A Division of Tandy Corporation
Fort Worth, Texas 76102

06A99

<ARB7198-A>
Printed in Indonesia