

NUVO[®]

Whole Home Audio



NV-A4S-DC /NV-A4S-UK Simplese Audio Distribution System

Installation Guide

ENGLISH

Danger

Exposure to extremely high noise levels may cause a permanent hearing loss. Individuals vary considerably to noise induced hearing loss but nearly everyone will lose some hearing if exposed to sufficiently intense noise for a sufficient time. The U.S. Government's Occupational Safety and Health Administration (OSHA) has specified the following permissible noise level exposures:

| | | | | | | |
|--------------------------|----|----|----|----|-----|-----|
| DURATION PER DAY (HOURS) | 8 | 6 | 4 | 3 | 2 | 1 |
| SOUND LEVEL (dB) | 90 | 93 | 95 | 97 | 100 | 103 |

According to OSHA, any exposure in the above permissible limits could result in some hearing loss. Ear plugs or protectors in the ear canal or over the ears must be worn when operating this amplification system in order to prevent a permanent hearing loss. If exposure in excess of the limits as put forth above, to insure against potentially harmful exposure to high sound pressure levels, it is recommended that all persons exposed to equipment capable of inducing high sound pressure levels, such as this amplification system, be protected by hearing protectors while this unit is in operation.

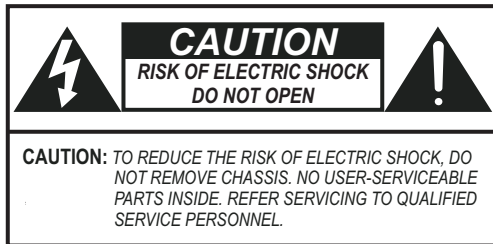

AVIS: RISQUE DE CHOC ELECTRIQUE-NE PAS OUVRIR.



THIS SYMBOL IS INTENDED TO ALERT THE USER TO THE PRESENCE OF NON-INSULATED "DANGEROUS VOLTAGE" WITHIN THE PRODUCT'S ENCLOSURE THAT MAY BE OF SUFFICIENT MAGNITUDE TO CONSTITUTE A RISK OF ELECTRIC SHOCK TO PERSONS.



THIS SYMBOL IS INTENDED TO ALERT THE USER TO THE PRESENCE OF IMPORTANT OPERATING AND MAINTENANCE (SERVICING) INSTRUCTIONS IN THE LITERATURE ACCOMPANYING THE UNIT.



APPARATUS SHALL NOT BE EXPOSED TO DRIPPING OR SPLASHING AND THAT NO OBJECTS FILLED WITH LIQUIDS, SUCH AS VASES, SHALL BE PLACED ON THE APPARATUS.

IMPORTANT SAFETY INSTRUCTIONS

1. Read all safety and operating instructions before using this product.
2. All safety and operating instructions should be kept for future reference.
3. Read and understand all warnings listed on the operating instructions.
4. Follow all operating instructions to operate this product.
5. This product should not be used near water, i.e. Bathtub, sink, swimming pool, wet basement, etc.
6. Only use dry cloth to clean this product.
7. Do not block any ventilation openings, It should not be placed flat against a wall or placed in a built-in enclosure that will impede the flow of cooling air.
8. Do not install this product near any heat sources ;such as, radiators, heat registers, stove or other apparatus (including heat producing amplifiers) that produce heat.
9. Do not defeat the safety purpose of the polarized or grounding-type plug. A polarized plug has two blades with one wider than the other. A grounding-type plug has two blades and a third grounding prong. The wide blade or the third prong are provided for your safety. If the provided plug does not fit into your outlet, consult an electrician for replacement of the obsolete outlet.
10. Protect the power cord being walked on or pinched, particularly at Plugs, convenience receptacles and the point where they exit from the apparatus. Do not break the ground pin of the power supply cord.
11. Only use attachments specified by the manufacturer.
12. Use only with the cart, stand, tripod, bracket, or table specified by the manufacturer or sold with the apparatus. When a cart is used, use caution when moving cart/apparatus combination to avoid injury from tip-over.
13. Unplug this apparatus during lightning storms or when unused for long periods of time.
14. Care should be taken so that objects do not fall and liquids are not spilled into the unit through the ventilation ports or any other openings.
15. Refer all servicing to qualified service personnel. Servicing is required when the apparatus has been damaged in any way; such as, power-supply cord or plug is damaged, liquid has been spilled or objects have fallen into the apparatus, the apparatus has been exposed to rain or moisture, does not operate normally or has been dropped.
16. **WARNING:** To reduce the risk of fire or electric shock, do not expose this apparatus to rain or moisture.

FRENCH

Danger

L'exposition a des niveaux eleves de bruit peut provoquer une perte permanente de l'audition, Chaque organisme humain reagit differemment quant a la perte de l'audition, mais quasiment tout le monde subit une diminution de l'acuite auditive lors d'une exposition suffisamment longue au bruit intense. Les autorites competentes en reglementation de bruit ont defini les expositions tolerees aux niveaux de bruits:

| | | | | | | |
|------------------------------|----|----|----|----|-----|-----|
| DURE EN HEURES PAR JOUR | 8 | 6 | 4 | 3 | 2 | 1 |
| INIVEAU SONORE CONTINU EN dB | 90 | 93 | 95 | 97 | 100 | 103 |

Selon les autorites, toute exposition dans les limites citees ci-dessus, peuvent provoquer certaines pertes d'audition. Des bouchons ou protections dans l'appareil auditif ou sur l'oreille doivent etre portes lors de l'utilisation de ce systeme d'amplification afin de prevenir le risque de perte permanente de l'audition, Dans le cas d'expositions superieures aux limites precitees il est recommande, afin de se premunir contre les expositions aux pressions acoustiques lvees potentiellement dangeure u ses, aux personnes exposees aux equipements capables de delivrer de telles puissances, tels ce systeme d'amplification en fonctionnement, de proteger l'appareil auditif.



CE SYMBOLE A POUR BUT D'AVERTIR L'UTILISATEUR DE LA PRESENCE DE VOLTAGE DANGEREUX NON-ISOLE A L'INTERIEUR DE CE PRODUIT QUI PEUT ETRE DE PUISSANCE SUFFISAMMENT IMPORTANTE POUR PROVOQUER UN CHOC ELECTRIQUE AUX PERSONNES.



CE SYMBOLE A POUR BUT D'AVERTIR L'UTILISATEUR DE LA PRESENCE D'INSTRUCTIONS D'UTILISATION ET DE MAINTENANCE DANS LES DOCUMENTS FOURNIS AVEC CE PRODUIT.



AFIN DE REDUIRE LES RISQUÉ D'INCENDIE ET DE DECHARGE ELECTRIQUE, NE PAS EXPOSER CET APPAREIL A LA PLUIE OU A L'HUMIDITE.

IMPORTANTES INSTRUCTIONS DE SECURITE

1. Lire avec attention toutes les recommandations et précautions d'emploi avant d'utiliser ce produit.
2. Toutes les recommandations et précautions d'emploi doivent être conservées afin de pouvoir s'y reporter si nécessaire.
3. Lire et comprendre tous les avertissements énumérés dans les précautions d'emploi.
4. Suivre toutes les précautions d'emploi pour utiliser ce produit.
5. Ce produit ne doit pas être utilisé près d'eau, comme par exemple baignoires, éviers, piscine, sous-sol humides ... Etc.
6. Utiliser exclusivement un chiffon sec pour nettoyer ce produit.
7. Ne bloquer aucune ouverture de ventilation. Ne pas placer le produit tout contre un mur ou dans une enceinte fermée, cela générerait le flux d'air nécessaire au refroidissement.
8. Ne pas placer le produit près de toute source de chaleur telle que radiateurs, arrivées d'air chaud, fourneaux ou autres appareils générant de la chaleur (incluant les amplificateurs producteurs de chaleur) .
9. Ne pas négliger la sécurité que procure un branchement polarisé ou avec raccordement à la terre, Un branchement polarisé comprend deux fiches dont l'une est plus large que l'autre. Un branchement à la terre comprend deux fiches plus une troisième reliée à la terre. Si la fiche secteur fournie ne s'insert pas dans votre prise de courant. consulter un 'électricien afin de remplacer votre prise obsolète.
10. Protéger le cordon d'alimentation de tout écrasement ou pincement, particulièrement au niveau des fiches, des réceptacles utilisés et à l'endroit de sortie de l'appareil. Ne pas casser la fiche de terre du cordon d'alimentation.
11. Utiliser uniquement les accessoires spécifiés par le constructeur.
12. Utiliser uniquement avec le chariot de transport, le support, le trépied, la console ou la table spécifiés par le constructeur ou vendus avec l'appareil. Lors de l'utilisation d'un chariot, bouger avec précaution l'ensemble chariotlappareil afin d'éviter les dommages d'un renversement.
13. Débrancher cet appareil lors d'orages ou s'il n'est pas utilisé pendant une longue période.
14. Des précautions doivent être prises afin qu'aucun objet ne tombe et qu'aucun liquide ne se répande à l'intérieur de l'appareil par les orifics de ventilation ou n'importe quelle autre ouverture.
15. Pour toutes interventions techniques s'adresser à un technicien qualifié.L'intervention technique est nécessaire lorsque l'appareil a été endommagé de n'importe quelle façon, comme par exemple si le cordon secteur ou sa fiche sont détériorés, si du liquide a coulé ou si des objets sont tombés à l'intérieur de l'appareil, si l'appareil a été exposé à la pluie ou à l'humidité, s'il ne fonctionne pas normalement ou s'il est tombé.
16. ATTENTION: Pour réduire le risque d'incendie ou de choc électrique ne pas exposer l'appareil à la pluie ou à l'humidité.

Table of Contents

| | |
|--|---------|
| Introduction | Page 3 |
| Wiring Diagram..... | Page 4 |
| Front Panel Features | Page 5 |
| Back Panel Features | Page 5 |
| NV-A4DKP-DC Keypad Features | Page 6 |
| NV-A4DKP-UK Keypad Features | Page 7 |
| NV-GRC1 Remote Control..... | Page 8 |
| Installing the Simplese System in Your Home | |
| I. Prewire CAT5 Termination | Page 9 |
| II. Speaker Wire Termination..... | Page 10 |
| III. Allport Termination and Installation..... | Page 10 |
| IV. Installing the Simplese Amplifier | Page 11 |
| V. IR Outputs | Page 11 |
| VI. Keypad and Zone Setup..... | Page 11 |
| Zone EQ Control and Source Grouping | Page 12 |
| Volume Reset | Page 12 |
| All Off | Page 13 |
| Master Mode/All On | Page 13 |
| VII. Using the Fixed and Variable Lineouts..... | Page 14 |
| VIII. Using the Link Jack | Page 15 |
| IX. Mute Input | Page 16 |
| X. The LSA40 Local Source Amplifier | Page 17 |
| XI. The LSA40PD Power Distribution Hub | Page 18 |
| Troubleshooting | Page 19 |
| Specifications | Page 21 |
| Addendum-NV-A4D Serial Control Protocol | Page 22 |

Introduction

Congratulations on your purchase of the NuVo Simplese System. Simplese brings the best of today's digital technology to a true whole-home audio system. Listening to multiple audio sources from independent zones throughout the home has never been easier or more affordable.

The elegant Simplese keypads (available in both US and UK standard wall plate sizes) allow independent selection of up to four different audio sources from up to four zones in the home. The white, ivory, almond, and black trim plates and keypad inserts included with each keypad provide a variety of colors to best match any home décor. Generation D digital amplification provides clear, precise digital sound to each zone without the heat generated by traditional analog amplification. The integrated infrared repeater in each keypad means you can control all of your audio sources wirelessly from any zone of your home.

Enjoying quality audio throughout the home is simple and affordable with Simplese. This installation manual is designed to provide a sequential, step-by-step guide to making full use of the many features and capabilities of the Simplese System.

NV-A4DS-DC Package Contents:

| | |
|-------------------|---|
| 1 NV-A4D | Four-Source, Four-Zone Amplifier |
| 4 NV-A4DKP-DC | Decora®* Zone Controller Keypads with white, ivory, almond, and black inserts and trim plates |
| 1 NV-GRC1 | Remote Control w/batteries |
| 1 NV-A4DAP-DC | Decora® Allport™ Multi-port connection hub |
| 1 NV-APC | Allport connection cable |
| 1 NV-REM1U (pair) | Single rack space rack ear mounts |
| 4 NV-VEC | IR emitters with feedback LED |
| 1 NV-PC2 | IEC 2-wire power cable |

*Decora® is a registered trademark of the Leviton Company

NV-A4DS-UK Package Contents:

| | |
|-------------------|---|
| 1 NV-A4D | Four-Source, Four-Zone Amplifier |
| 4 NV-A4DKP-UK | UK standard 50 x 50 mm Zone Controller Keypads with white, ivory, almond, and black inserts and trim plates |
| 1 NV-GRC1 | Remote Control w/batteries |
| 1 NV-A4DAP-UK | UK standard 50 x 50 mm Allport™ Multi-port connection hub |
| 1 NV-APC | Allport connection cable |
| 1 NV-REM1U (pair) | Single rack space rack ear mounts |
| 4 NV-VEC | IR emitters with feedback LED |
| 1 NV-PC2 | IEC 2-wire power cable |

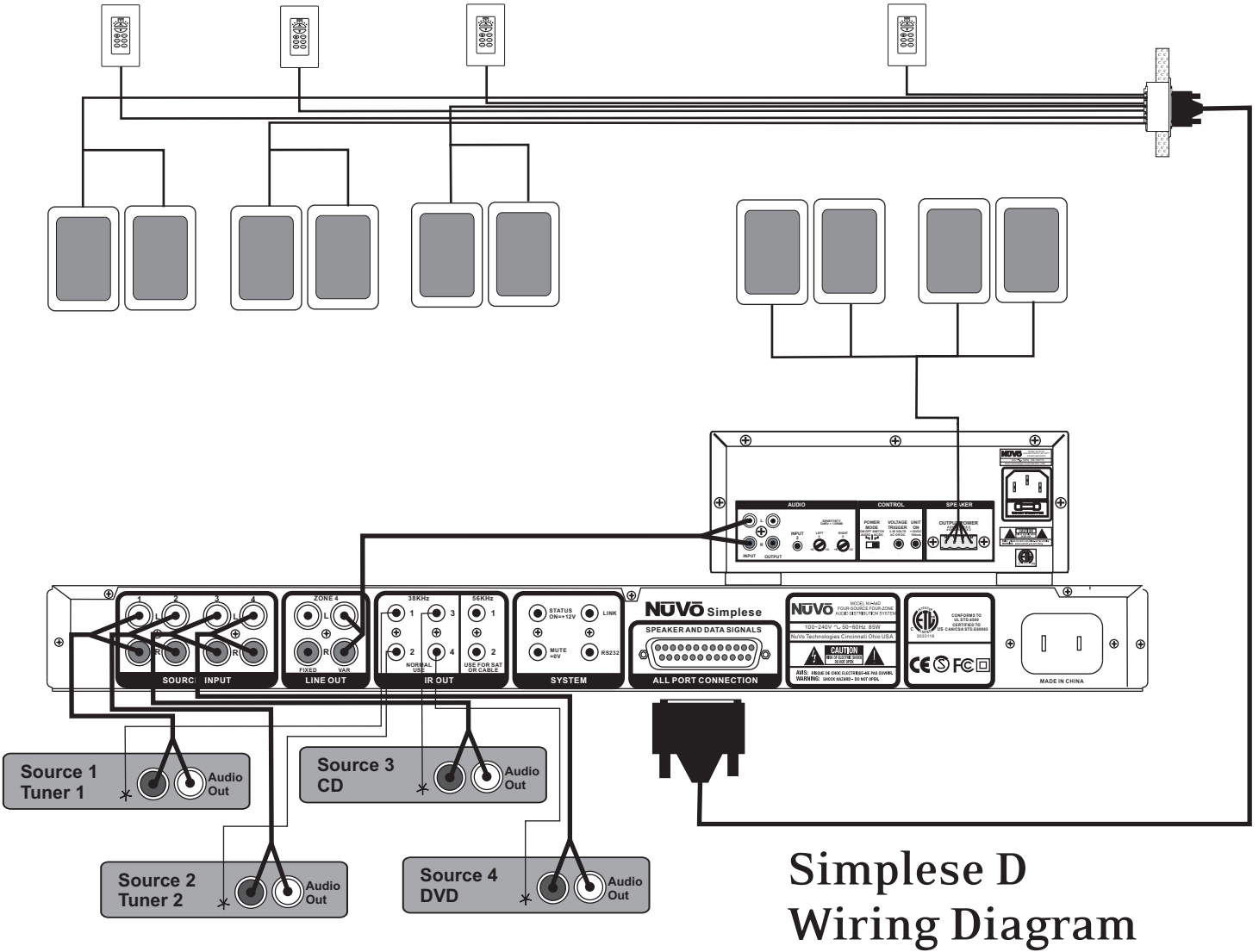

Simplese D Wiring Diagram

Wiring Diagram shown using US standard keypads and Allport

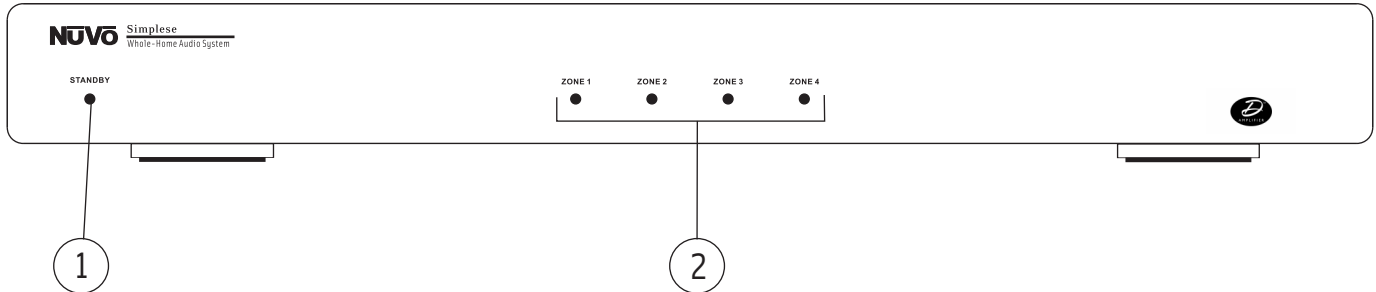

Front Panel Features

1. **Stand-by LED** This LED (light emitting diode) indicates, when lit, that the Simplese amplifier is plugged into an AC power source.
2. **Zone LED** Each of these LEDs indicates, when lit, that its zone keypads are turned on.

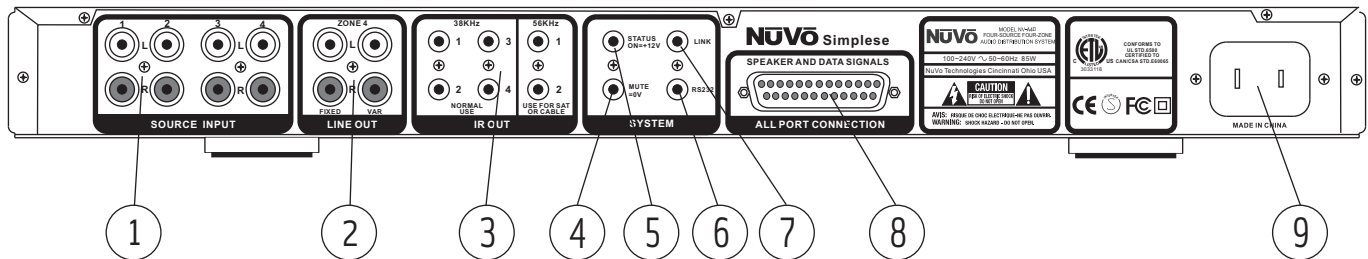

Back Panel Features

1. **Source Inputs** Each of these stereo RCA inputs receives an audio signal from up to four independent audio sources.
2. **Zone 4 Lineouts** These fixed and variable lineouts are used for attaching additional amplification to the zone 4 audio outputs.
3. **IR OUT** These outputs are designed to be used with the included IR (Infrared) emitters to transfer IR function commands from the zone keypads to the appropriate audio source equipment; see IR Outputs pg. 10.
4. **Mute** This 3.5mm mono connection is designed to be used in conjunction with the NV-MI1 mute interface; see Mute Input and the NV-MI1, pg. 15.
5. **Status** This 3.5mm mono connection provides a constant +5 volt output when a zone is turned on. This can be used to trigger external equipment.
6. **RS232** This stereo 3.5mm input provides bidirectional serial communication.
7. **Link** This 3.5mm stereo output is used to expand the Simplese System from four to eight zones; see Using the Link Jack to Create Eight Zones, pg. 14.
8. **Allport Connection** This 25-pin terminal is used in conjunction with the Allport cable to integrate the zone keypads and speakers into the system; see Allport Termination and Installation, pg. 9.
9. **AC** This is used with the included AC power cable to provide electrical power to the system when attached to an active AC power outlet.

NV-A4DKP-DC Keypad Features

- 1. Volume Level** The level of the zone volume is indicated by these LEDs (light emitting diodes).
- 2. Volume** Independent audio volume level for each zone is controlled with this button.
- 3. IR Receiver** Each keypad has an IR (infrared) receiver located under the volume button for wireless control of the audio source equipment.
- 4. Power** The power button turns that keypad's zone on and off independently of the other zones. Pressing and holding the power button turns all the zones off simultaneously.
- 5. Mute** The mute button temporarily silences any audio playing in that keypad's zone. Pressing Mute and the Source buttons simultaneously enables advanced zone control, see pg. 11 and 12 .
- 6. Source Selection** The source buttons independently select any of the four sources connected to the Simplese amplifier. The selected source button will remain lit.

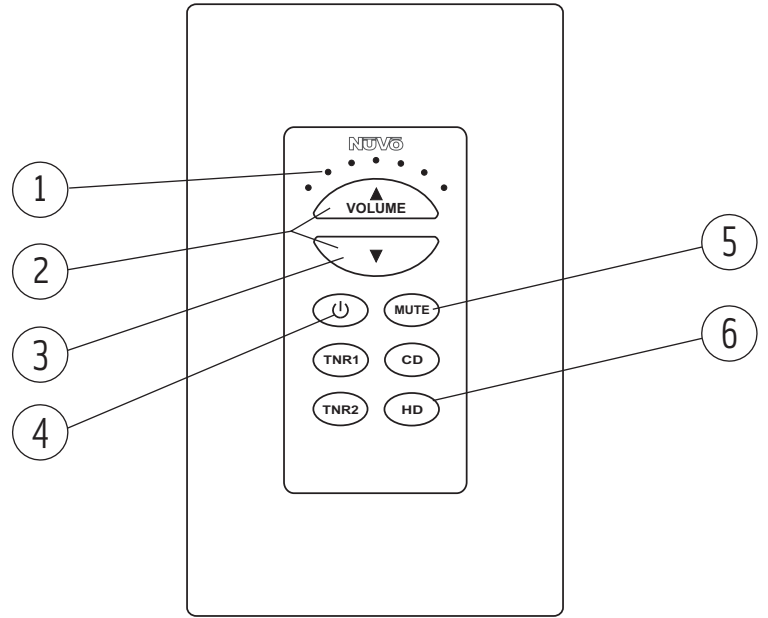

NV-A4DKP-UK Keypad Features

- 1. Volume Level** The level of the zone volume is indicated by these LEDs (light emitting diodes).
- 2. Power** The power button turns that keypad's zone on and off independently of the other zones. Pressing and holding the power button turns all the zones off simultaneously.
- 3. Mute** The mute button temporarily silences any audio playing in that keypad's zone.
- 4. Source Selection** The source buttons independently select any of the four sources connected to the Simplese amplifier. The selected source button will remain lit.
- 5. IR Receiver** Each keypad has an IR (infrared) receiver located under the volume button for wireless control of the audio source equipment.
- 6. Volume** Independent audio volume level for each zone is controlled with these buttons.

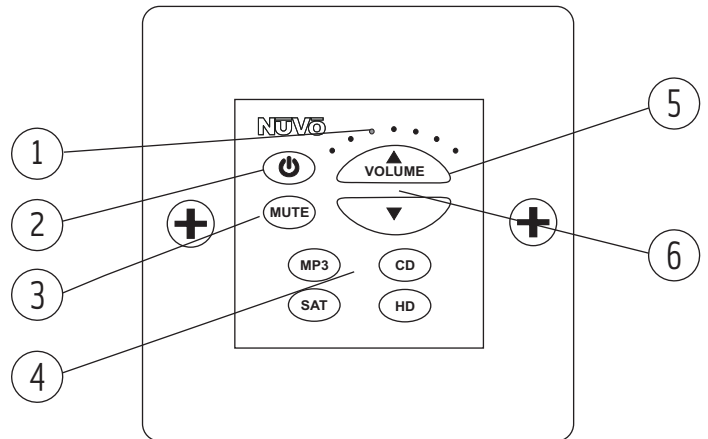

NV-GRC1 Remote Control

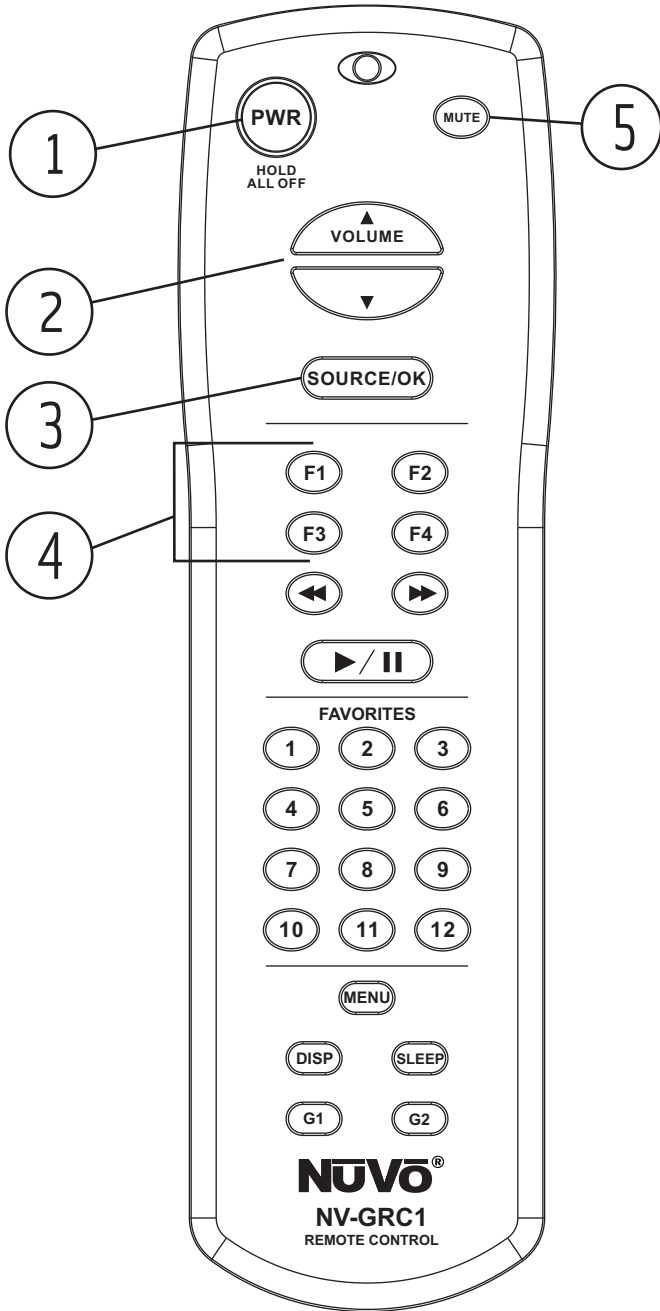

- 1. PWR:** This button turns the local zone on and off with a single tap and performs an "All Off" function when the button is pushed and held.
- 2. Volume:** The local zone's volume will increase and decrease incrementally with the Volume up and down buttons.
- 3. Source/OK:** This button cycles through the four source selections with each tap.
- 4. Function Buttons:** These buttons labeled F1, F2, F3 and F4 provide direct source selection for the corresponding sources 1 - 4.
- 5. Mute:** This mutes the local zone audio with a single tap and un-mutes with a secondary tap.

All other buttons are nonfunctional for Simplese use.

Installing the Simplese System in Your Home

I. Prewire

The Simplese System uses Cat-5 cable for keypad control and either two- or four-conductor 16-gauge speaker wire. All the wire is "homerun" from each zone to the location of the Allport connection hub.

Complete Cat 5 Crimping Instructions

The NuVo audio systems require Cat 5, unshielded, twisted pair (UTP), for communication between the keypads/Display Pads and the main amplifier unit. Each end of the wire is terminated with an RJ45 connector.

The Simplese System can accommodate 2000 total feet of Cat 5 cable. For the most reliable operation, it is best that no single run of Cat 5 exceeds 250 feet.

The correct wiring scheme for the Cat 5 cable is standard EIA/TIA 568A. Properly terminating the Cat 5 cable is crucial for the operation of the system. It is very important to use a good quality crimp tool, and testing each end to end run with a Cat 5 wire tester will insure that your system operates flawlessly, fig.1.

Step-by-Step Crimping Instructions

1. Strip a 2 to 3 inch portion of the insulation, exposing the 4 twisted pairs.
2. Untwist the wires and fan them out individually. Arrange the wires into the correct color scheme as shown in Fig. 1.
3. Flatten the wires in their correct order, and trim them evenly across the top. Most crimp tools have a wire trimmer built-in. It is best to trim the wires to about 1/2" in length.
4. While holding the wires flat between your thumb and forefinger, insert the wires into the RJ45 connector, so each is in its own slot. Push the wire into the RJ45, so all 8 conductors touch the end of the connector. The insulation jacket should extend beyond the crimp point of the RJ45.
5. Insert the RJ45 into the crimp tool receptacle and squeeze the tool firmly. Note that a ratchet type tool should tighten down until it no longer clicks.
6. The RJ45 should be firmly crimped to the Cat 5 insulation. It is necessary that the color scheme be repeated identically on each end of the wire.

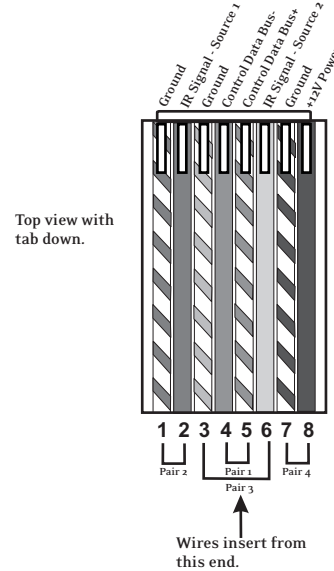
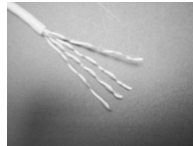

Fig. 1: EIA 568A wiring scheme for Cat 5 Cable
Pin #

1. Green Stripe
2. Green
3. Orange Stripe
4. Blue
5. Blue Stripe
6. Orange
7. Brown Stripe
8. Brown

Note: Colors listed as "stripe" are a white wire with a colored stripe.

Step 1



Step 2

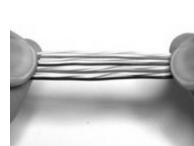

Step 3



Step 4



Step 5



Step 6

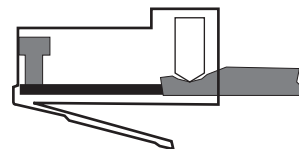

II. Speaker Wire Termination

It is important to keep the proper orientation of positive and negative signal for each speaker connection. Typically, two-conductor speaker wire uses red to denote positive and black to denote negative. Some types of wire indicate positive with a dark line running through the insulation. Four-conductor wire can also be used. This has four separate wires in one outer jacket, making it possible to run a single speaker wire to a zone for its pair of speakers. This type of wire typically uses red and black for one speaker and white and green as positive and negative for the second speaker.

Note: The Simplese System is designed to handle one pair of 8-ohm speakers per zone. Using more than one pair of speakers per zone could cause damage to the amplifier output.

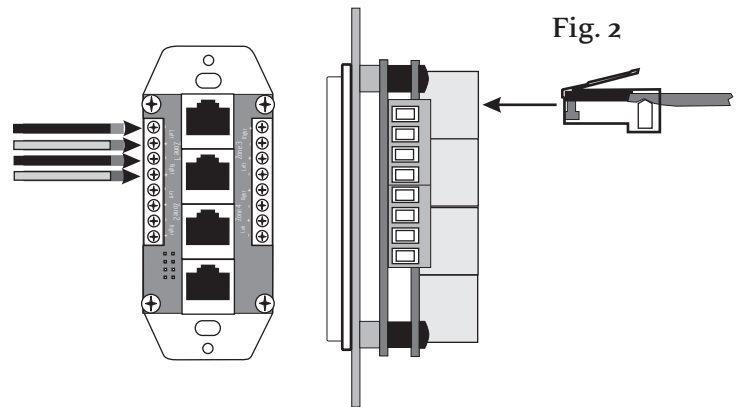

III. Allport Termination and Installation

Both the speaker wire and Cat-5 cables for each zone terminate into the back side of the Allport. The order of Cat-5 plug-ins is irrelevant to the operation of the system, but it is recommended that you label the individual Cat-5 cables for future reference. Follow the zone and polarity labeling for the speaker wire termination, fig. 2.

The final connection from the Allport is made with the Allport cable supplied with the Simplese System, fig. 3.

Note that the examples shown here are using the US standard decora size Allport.

Fig. 3

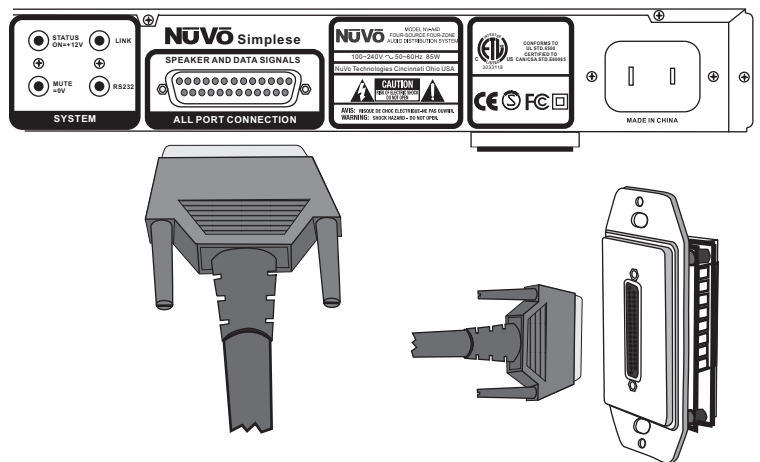

IV. Installing the Simplese Amplifier

The Simplese amplifier component is designed to be placed on a shelf or in a component rack. Rack ear mounts are supplied with the system. If you are using the rack ears and mounting the amplifier with other components, you should remove the feet. Remove the two screws at the front of each side of the lid and use the longer screws included with the rack ears to attach the ears to the Simplese amplifier.

The audio sources are plugged into the four source inputs on the back panel of the Simplese amplifier using stereo RCA cables, fig. 4.

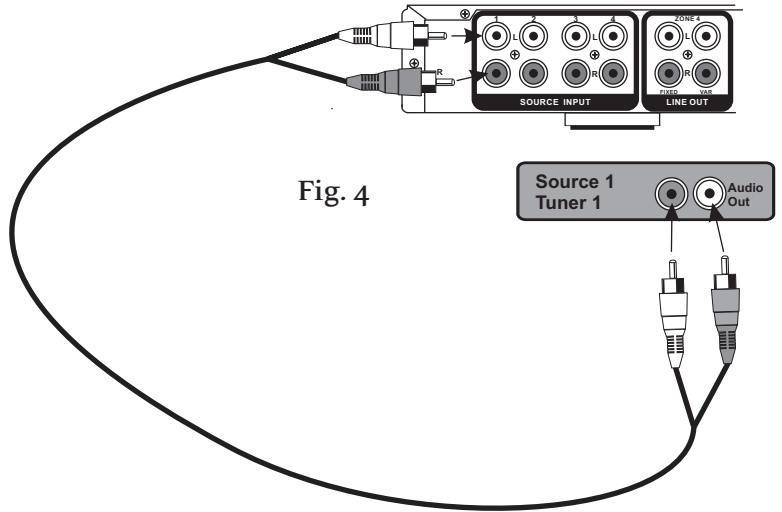

Fig. 4

V. IR Outputs

The Simplese System ships with four IR emitters for transferring IR data from the keypad receivers (located under the volume button) to the IR receiver on each piece of source equipment. There are two separate IR output sections on the back panel. The 38Khz outputs are used for most audio sources. The exception to this is cable and satellite boxes, which operate at a higher IR carrier frequency closer to 56Khz. A second-source one and two 56Khz output is available for these devices. It is important that the output being used for each source matches the source input number. The outputs work individually with each source to allow independent source control. Simply plug the emitter into the appropriate IR output on the back of the Simplese amplifier and attach the flasher end over the IR receiver equipment, fig. 5.

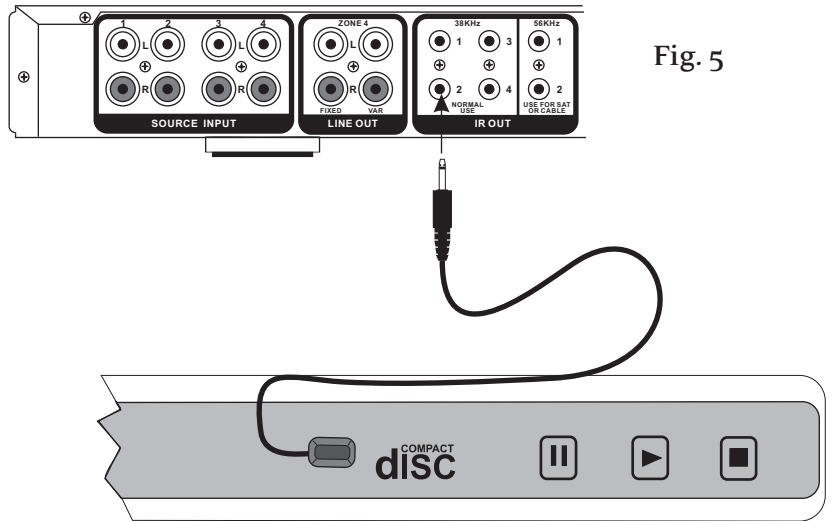

Fig. 5

VI. Keypad and Zone Setup

Each keypad requires a specific zone setting to establish the keypad's location. This setting is made on the back of the keypad using an eight-position rotary switch. To set the switch, place a small slot-head screwdriver in the slot in the switch and turn it clockwise to the appropriate zone number 1-4, fig. 6. The remaining switch positions, 5-0, allow for an additional keypad in each zone. Position 5 corresponds to zone 1, 6 to zone 2, 7 to zone 3, and 0 to zone 4. **Note that the Allport only has four RJ45 jacks, so additional keypads require the use of a Cat-5 splitter.**

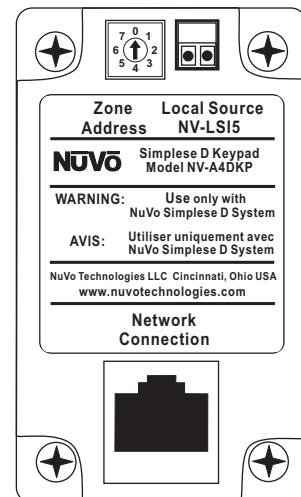

Fig. 6

Example shown using the US Decora standard keypad

EQ Control and Source Grouping

The keypads can be used to set specific zone functions. These are for bass and treble EQ response and source grouping. To change bass response, press the Mute button and Source 1 button simultaneously. Adjust the bass level up or down by using the Volume Up and Volume Down buttons. The volume indicator LEDs will indicate the output level, fig. 7. Adjust treble response using the same process. This is accessed by pressing the Mute and Source 2 buttons. Once the desired setting is made, press the Source button again to return the keypad to normal operation.

Source grouping is a feature that allows multiple zones in an open living space to always share the same source selection but still retain individual volume and on/off control. This is achieved by pressing Mute and Source 3. Volume Up enables the group function, and Volume Down disables the group function and causes the keypad to operate independently of all other groups, fig. 8.

Volume Reset

The Simplese System keypads automatically reset the listening volume to a low level when all zones have been turned off and a zone is turned on again. If a zone is turned off and turned back on before all the zones are turned off, it will return at the previous volume level.

The lit volume LED indicates the treble and bass levels.

Press the Source 1 and Mute buttons for bass control
Press Source 2 and Mute buttons for treble control.

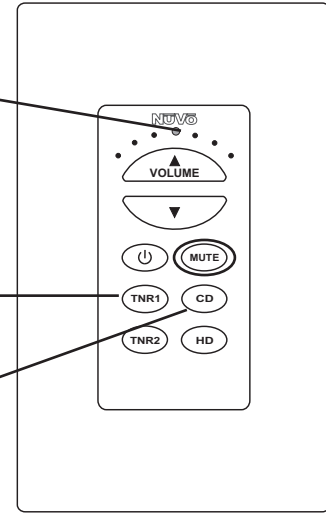

Example shown using the US Decora standard keypad

Fig. 7

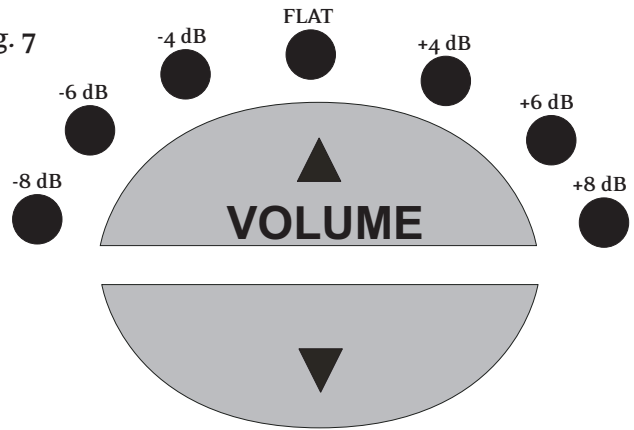
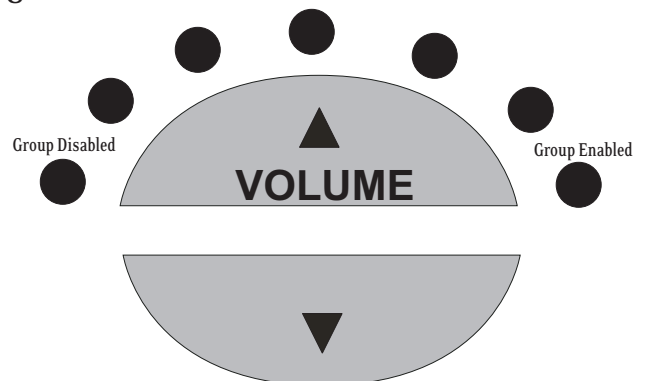

Fig. 8



All Off

All the zones in the system can be turned off simultaneously from any keypad by pushing and holding the power button until the keypad goes completely dark. A single push and release of the power button will only turn that zone off. If another zone is on, the power button will remain lit.

Master Mode/All On

The Simplese System has an All On feature. Any keypad within the system, which can be up to eight zones, has the ability to become a master control for the entire house. The master keypad will control zone on, volume level, and source selection for all other zones.

To place a keypad in Master Mode function, simply press the Mute and Source 4 buttons simultaneously. This will cause the volume indicator LED for that zone's keypad to flash continuously. All other zones will then turn on to the same relative volume level and increase or decrease with the volume adjustment on the master keypad.

Any of the other zone keypads have the ability to override the master function by selecting a new source, changing a local zone's volume control, or by turning a local zone's keypad off and back on.

The master mode is turned off by repeating the sequence of pressing the Mute and Source 4 buttons.

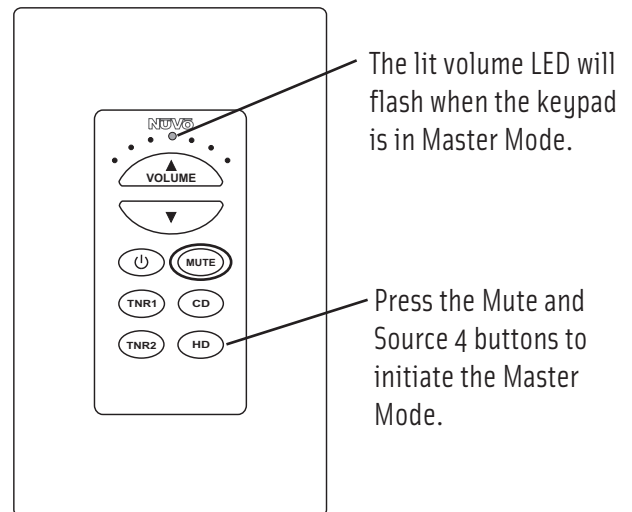

Example shown using the US Decora standard keypad

VII. Using the Fixed and Variable Lineouts

Zone 4 is equipped with two types of pre-amp lineouts for use with an additional amplifier. This can be dedicated to an outdoor zone or large living area that would benefit from more than one pair of speakers. NuVo manufactures a 200-watt stereo amplifier specifically designed for this purpose, called the P2100, although any audio amplifier can be used with the lineouts. The examples shown in this manual refer specifically to the P2100.

The variable lineout is intended for use in a zone where you want the Simplese keypads to control the volume output of the external amplifier, fig. 9.

Fig. 9

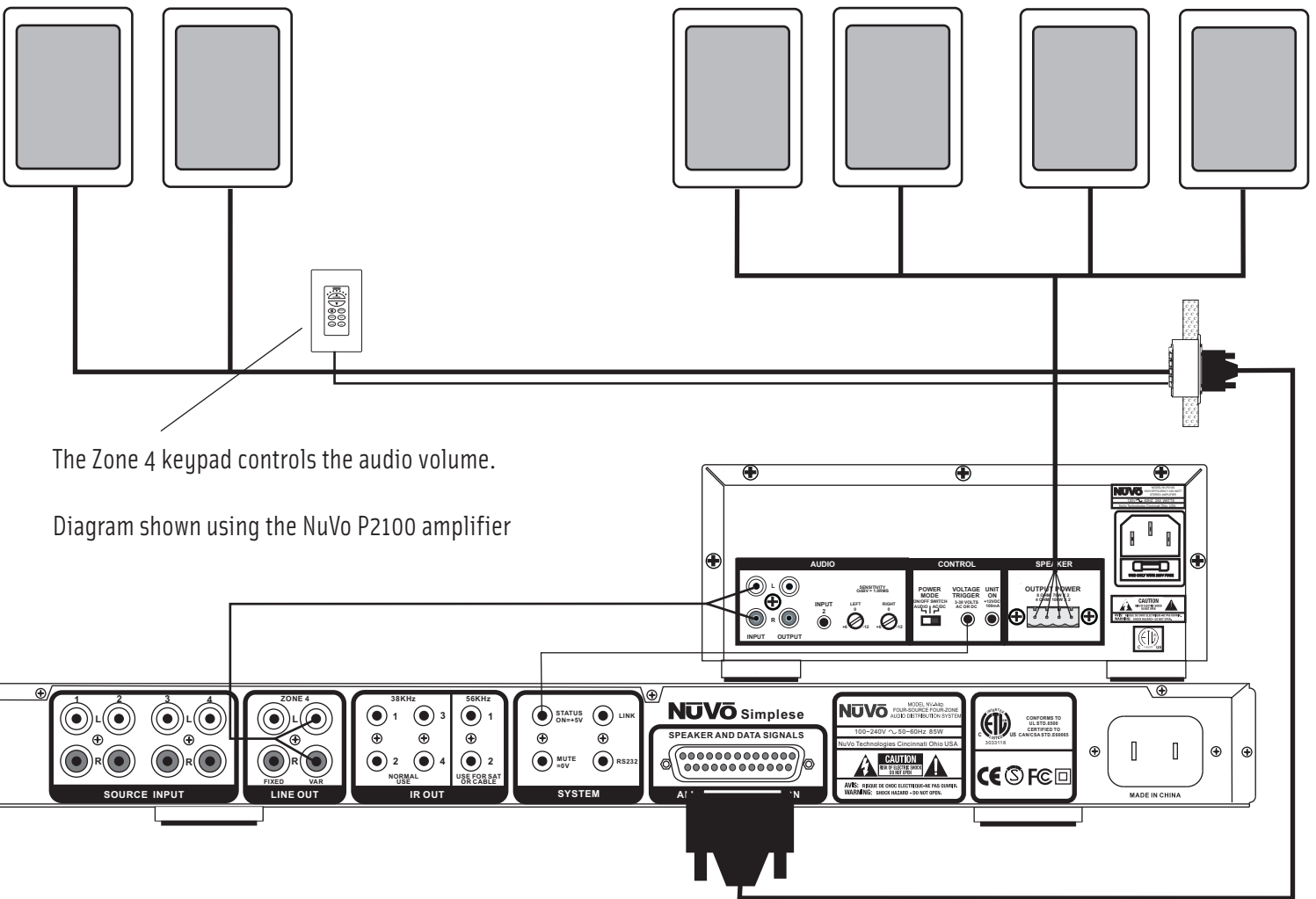

The fixed lineout can be used for zones where it is more appropriate to have a separate volume control from the NuVo keypad for the external amplifier, fig. 10. A good example of this use would be an outdoor zone that is being used in conjunction with zone 4. All three versions, zone 4 amplified output, variable lineout, and fixed lineout can be used simultaneously.

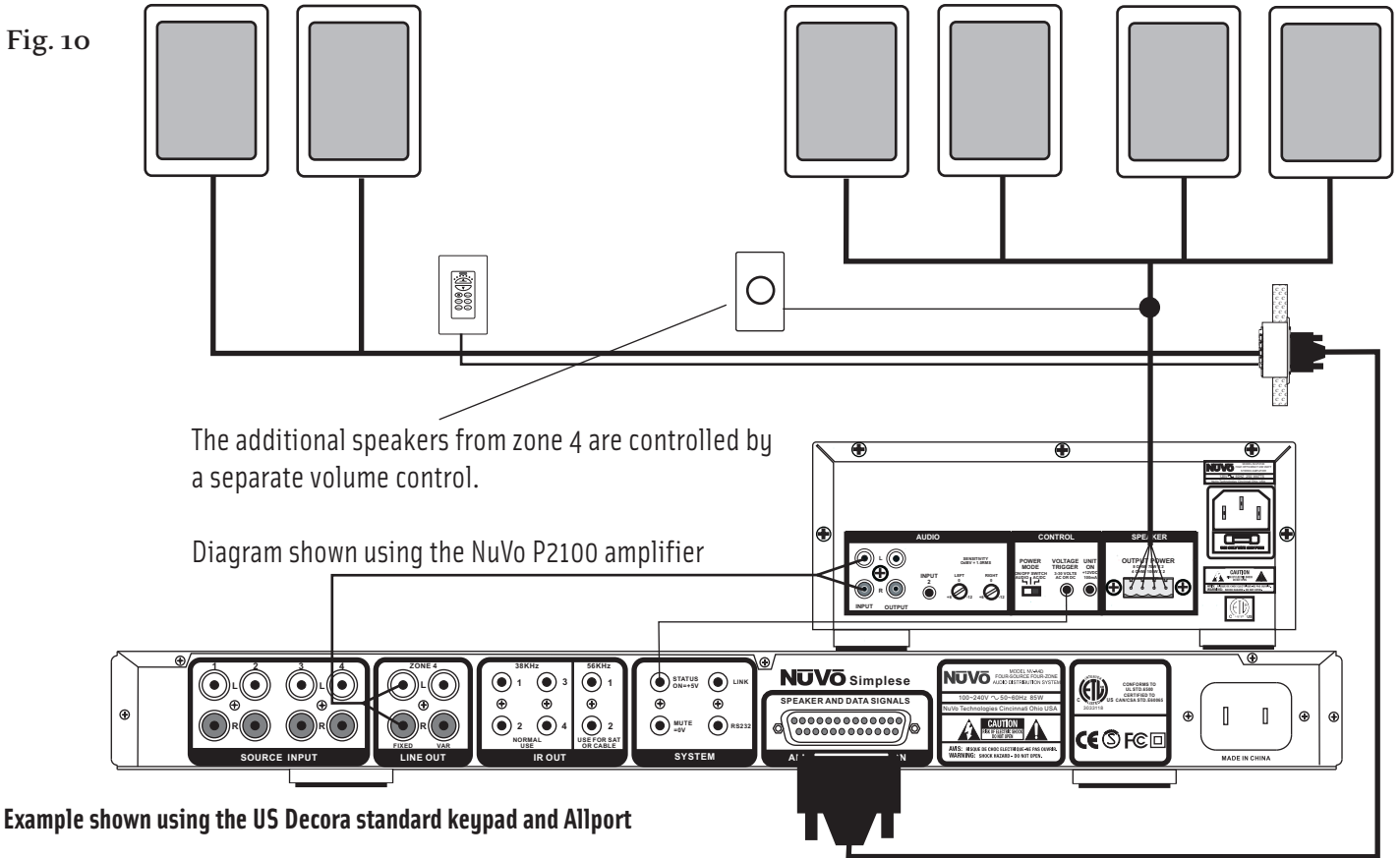

VIII. Using the Link Jack to Create Eight Zones

Two separate Simplese Systems can be made to react as one using the back-panel 3.5mm connection labeled LINK. This requires the use of "Y" cables to link the source inputs and IR outputs. A single stereo mini-patch cable is then plugged into the LINK jack on both Simplese amplifiers. This links the All Off command so when it is initiated at any of the zone keypads, all eight zones will turn off, fig. 11.

Fig. 11

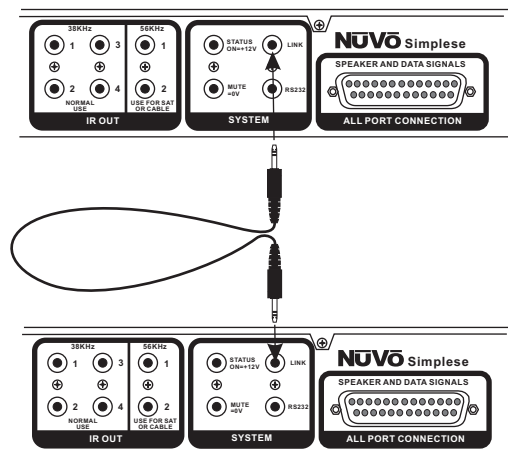

IX. Mute Input and the NuVo MI1

The back panel of the Simplese amplifier has a 3.5mm mono input labeled MUTE. This is designed to be used with the NuVo MI1 Mute Interface. When the MI1 is connected, the system will temporarily mute when the phone or doorbell rings, fig. 12.

Fig. 12

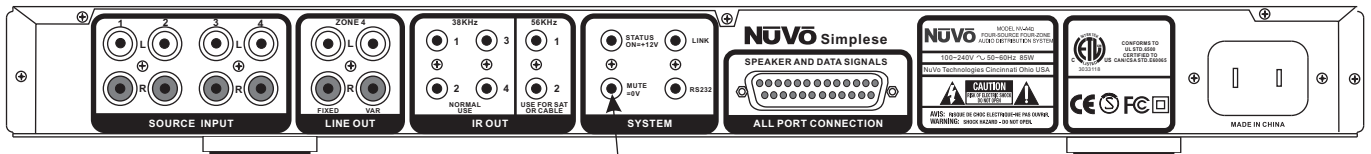

The MI1 connects to the NuVo amplifier using a standard mono patch cable with a mini-plug on each end. Plug one end into the EXT. MUTE input on the back of the amplifier and the other end into the input on the front of the MI1.

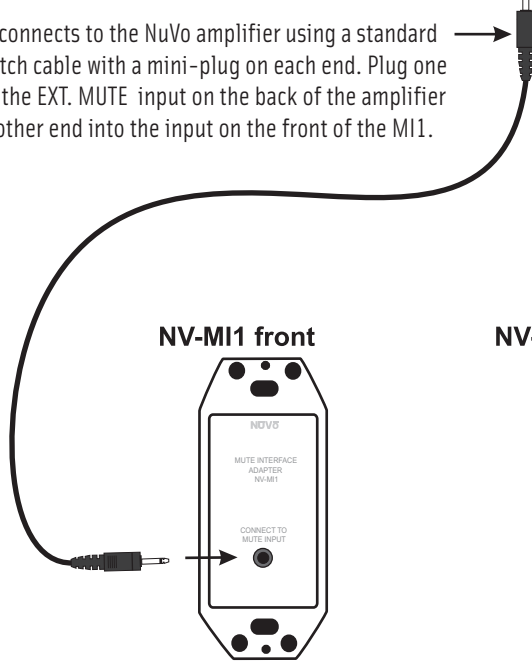

The back of the MI1 will accept up to two AC or DC voltages from two different doorbell chimes. This connection is done with two conductor wire from the terminals on the doorbell chime to the Doorbell A or Doorbell B inputs on the back of the MI1. Polarity is not important for this connection.

NV-MI1 back

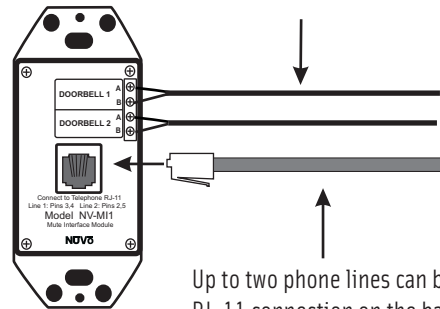

Up to two phone lines can be brought into the RJ-11 connection on the back of the MI1. The voltage from the phone ringer will trigger the NuVo System to mute.

X. The LSA40 Local Source Amplifier

The LSA40 is highly versatile, 40 watt stereo amplifier designed to be installed in a single gang low voltage ring. An audio sensing feature allows the LSA40 to automatically amplify any incoming line-level audio signal. As described in fig. 13, the LSA40 can be connected to the Simplese keypad allowing use with a local source or an incoming NuVo system source through a common pair of speakers in any zone.

Fig. 13

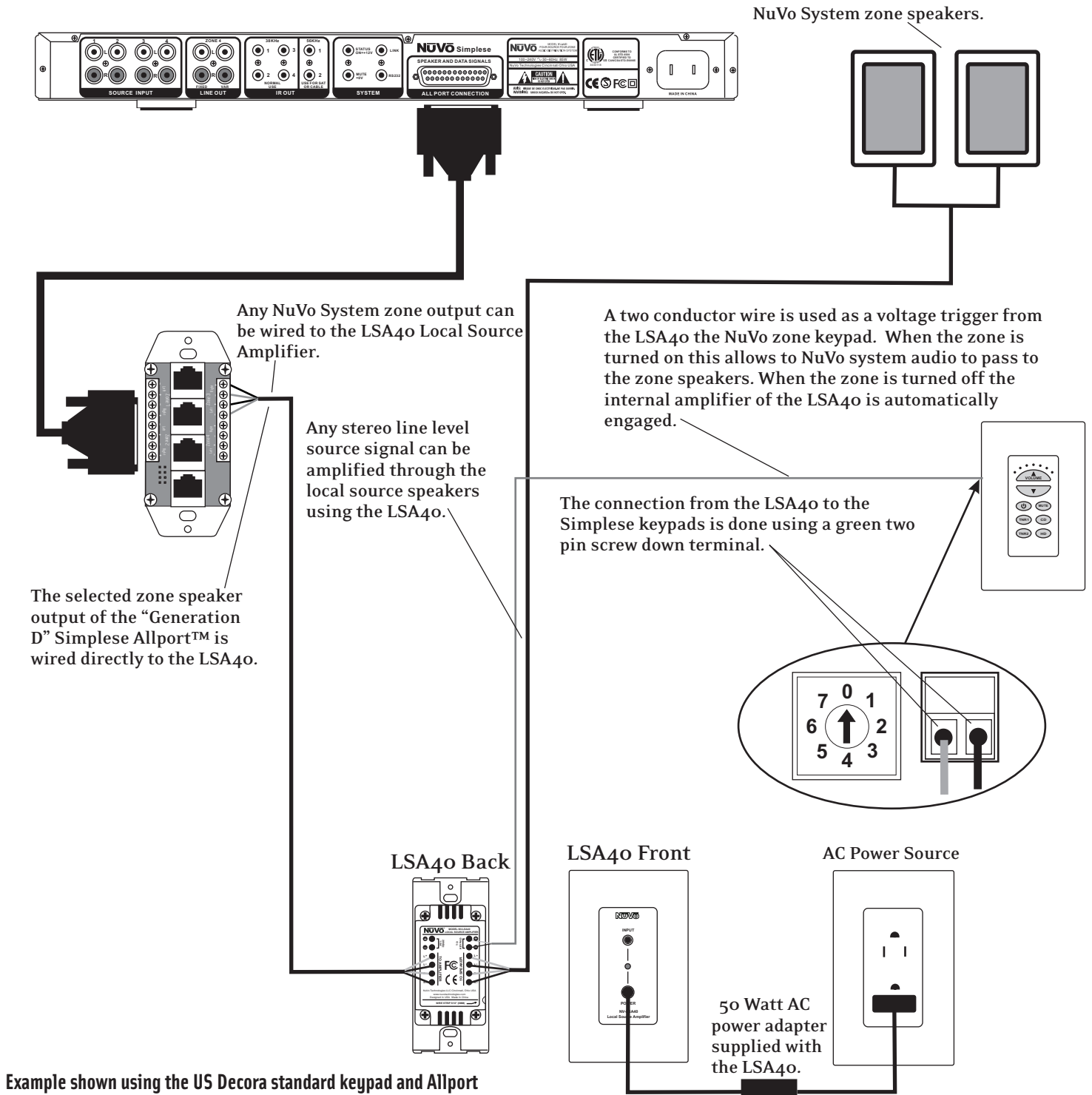

Example shown using the US Decora standard keypad and Allport

XIV. NV-LSA40PD Local Source Amplifier Power Distribution Hub

The LSA40PD is a great device for distributing the necessary DC power to up to 4 individual LSA40 amplifiers. This allows the LSA40 components to be remotely located without the need for an external power supply in the zone, fig. 14. The LSA40PD is typically located where the Simplese amplifier is installed. The power from the head end to each of LSA40 locations is sent over standard 16 gauge speaker wire.

Fig. 14

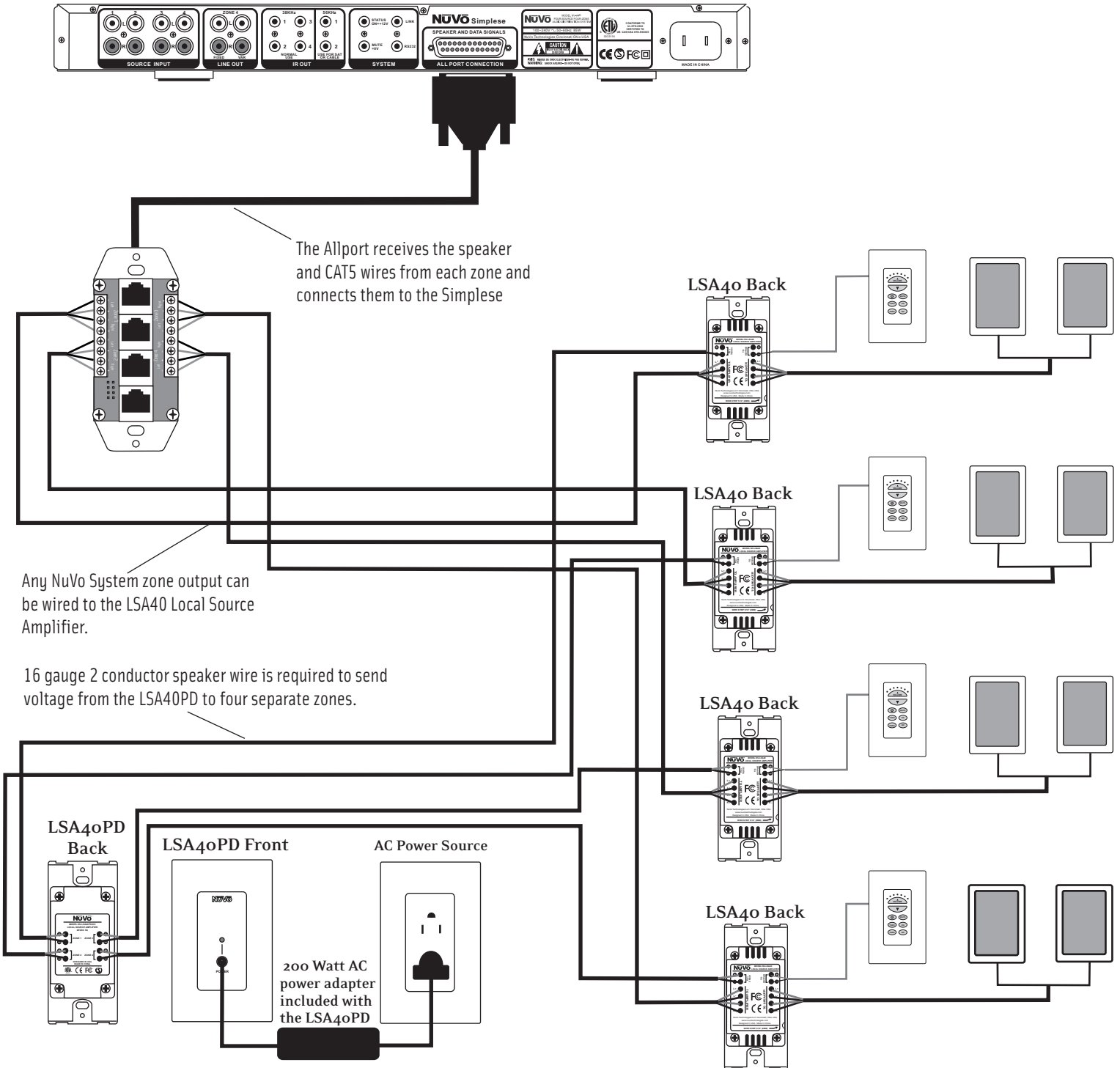

Example shown using the US Decora standard keypads and Allport

Troubleshooting

| Symptom | Probable Cause | Remedy |
|--|--|---|
| When the keypad is plugged in there is a loud pop through the speakers and the keypad does not work. | Improperly wired CAT5 cable. | Check that you are using the 568A or B wiring standard (see section I: Crimping CAT5 wire). The best way to know is to use a CAT5 tester. |
| When the keypad is plugged in, it just flashes and has no functionality. | Assigning duplicate addresses to multiple keypads. | Each keypad must have a unique address set with the Zone Address rotary switch located on the back of the keypad (see section VI, Installing the Simplese keypads). |
| The keypad or keypads will not change source independently. They all change source at the same time | Source Grouping is turned on. | Each keypad has the ability to be set as a source group or remain independent. Use the Mute button and the Source 3 button to turn the Source Group feature on and off (see Source Grouping, page 11). |
| All the keypads change when a source is selected on only one. | The keypads are set for Source Grouping. | Pressing the MUTE and Source 3 button simultaneously sets the Source Grouping feature. This will cause multiple keypads to always share the same source (see Section VI, Zone EQ and Source Grouping on page 11). |
| With the keypads plugged in, the POWER LED on the front of the amplifier will not turn on. | One or more improperly wired CAT5 cables. | Make sure that the amplifier is plugged into a reliable power source. Test that the POWER LED on the amplifier turns on when the Allport Cable is unplugged and plugged in again. Next, unplug all the CAT5 cables from the Allport and plug them back in one at a time until the bad cable(s) is discovered. |

Troubleshooting

| Symptom | Probable Cause | Remedy |
|--|---|---|
| The IR emitters remain constantly lit | IR interference. | This is commonly caused by a security motion detector aimed at the keypad's IR receiver. If possible, redirect the motion detector. Try to keep the keypad from strong direct sunlight. This can also cause interference. This can also be caused by an incorrect wire pinout at the CAT5 RJ-45 termination. Check using a CAT5 tester and re-terminate if necessary. |
| The IR repeater does not properly control the audio source equipment. | One or more of the IR emitters are not properly placed over the IR receiver on the audio source equipment, or the IR output on the Simplese does not correspond with the audio equipment you are controlling. | Reposition the LED end of the emitter on the face of the source equipment, so it is flashing directly over that source's IR receiver. Make sure that the emitter plugged into IR Output #1 is actually going to source #1, and so on for sources 2-4. |
| External amplifier (NV-P2100) or other model audio output creates a hum. | Ground loop. | Unplug the audio input to the amplifier to see if the hum disappears. If so, install a ground loop isolator audio cable. |

Simplese D Specifications

Zones 1-4 Power Amplifier Outputs

| | |
|--------------------------------------|---------------|
| Continuous Average Output Power | 30W (15W x 2) |
| Two channels driven 30-20kHz @1% THD | |
| Rated Distortion (1/2 power) | 0.40% |
| Rated Impedance | 6 Ohms |
| Damping Factor | 50+ |
| Frequency Response (20-20kHz) | ±2dB |

Preamplifier Section

| | |
|-----------------|----------|
| Variable output | 0-600mV |
| Fixed output | 600mV |
| Impedance | 600 Ohms |

Source Inputs 1-4

| | |
|-----------------------------------|-----------|
| input Impedance | 10K |
| Input Sensitivity for rated power | 300mV RMS |
| Input Overload | 3V RMS |

Emitter Outputs

| | |
|--|------------------------|
| Source Outputs | 4 |
| Output Drive Current | 100mA |
| Output Drive Voltage | 5V |
| Source 1&2 | 38kHz/56kHz Selectable |
| Source 3&4 | 38kHz |
| Compatible with single and dual emitters | |

System

| | |
|---------------|-----------|
| System On | 5V @ 50mA |
| External Mute | 3-12V DC |

Power Requirements

| | |
|---|-------------------|
| Power Supply | 90-260VAC 50/60Hz |
| Power Consumption all channels driven to full-rated power | 140W |
| Power Consumption average operating conditions | 30W |
| Power Consumption no signal | Less than 10W |

Physical Specifications

| | |
|-----------------------|-----------------------------|
| Unit Size Millimeters | 44 H. x 430 W. x 270 D. |
| Unit Size Inches | 1.75 H. x 17 W. x 10.625 D. |
| Unit Weight Kilograms | 2.95 |
| Unit Weight Pounds | 6.5 |

NuVo reserves the right to change specifications without notice.

Addendum

NV-A4D SERIAL CONTROL PROTOCOL

Revision 1.1
July 29, 2006

SERIAL PORT PINOUTS – 3.5mm stereo jack

Tip: A4D RECEIVE from System Controller
Ring: A4D TRANSMIT to System Controller
Sleeve: Common ground.

SERIAL PORT PARAMETERS

RS232, RTS/CTS or software flow control (XON/XOFF) NOT required, 9600 baud, 8N1 protocol.

RULES OF PROTOCOL

- (1) In this document, actual characters in a string are presented in **bold** type.
- (2) All numerical fields are coded as ASCII digit characters.
- (3) Each Command string is STARTED with an ASCII "*" character and terminated by a <CR> character (0D hexadecimal). Each response string issued by the A4D will START with an ASCII "#" and be terminated with a <CR> character (0D hexadecimal).
- (4) If a command has an error in it (does not adhere to exact command syntax), the A4D will respond with a "#?<CR>" string.
- (5) Whenever queuing multiple commands to the A4D, the host program should pause for 50 milliseconds between commands to prevent buffer overruns.

NUVO POWER-ON STATE

- (1) Each zone is OFF until ON command is received.
- (2) Each zone's settings will be as last set by zone keypad combinations indicated and as stored in microcontroller non-volatile memory. Factory default settings prior to any initiated zone keypad changes are:
 - A. BASS+0 (Bass FLAT)
 - B. TREB+0 (Treble FLAT)
 - C. GRP0 (SOURCE GROUPING OFF)If these zone settings are overridden by the commands that follow in this document, the overridden values are volatile. In other words, these parameters will return to the last manual settings stored in non-volatile memory upon cycling power on the A4D Main Unit.
- (3) For the first four seconds after power-on, a series of non-control related characters will be issued. These are necessary queries to a program that may be running on a connected PC for the purpose of firmware field upgrades. They should be ignored by the host control system.

NOTES

The commands in this document are a subset of the commands for the NV-E6D. The following E6D commands have been omitted in the A4D:

*IRSETSR, *IRSETDF, *SxIR56SET, *SxIR38SET
*ALLV+, *ALLV-, *ALLVHLD, *Z0xVHLD

The following commands behave slightly differently between the E6D and the A4D:

*Z0xVOL+, Z0xVOL-

Zone ON/OFF

Toggles the specified zone on and off. This is the same as pushing the power button on the zone's keypad.

COMMAND: *Z0xONOFF<CR>

RESPONSE: Same as for *Z0xCONSR<CR>

ALL OFF

COMMAND: *ALLOFF<CR>

RESPONSE: #ALLOFF<CR>

This response is also issued when all off is pressed on any keypad

ALL Mute ON

COMMAND: *ALLMON<CR>

RESPONSE: #ALLMON<CR>

ALL Mute OFF

COMMAND: *ALLMOFF<CR>

RESPONSE: #ALLMOFF<CR>

Zone SouRCe

COMMAND: *Z0xSRCp<CR>

x = zone # from 1 to 4

p = source # from 1 to 4

RESPONSE: Same as for *Z0xCONSR<CR>

Zone VOLume

COMMAND: *Z0xVOLyy<CR>

x = zone # from 1 to 4

yy = level below max volume in dB: -00 to -78 dB (include lead 0 for all single-digit values)

RESPONSE: Same as for *Z0xCONSR<CR>

Zone VOLume +

Increase zone volume by 1 dB

COMMAND: *Z0xVOL+<CR>

x = zone # from 1 to 4

RESPONSE: Same as for *Z0xCONSR<CR>

Zone VOLume -

Decrease zone volume by 1 dB

COMMAND: *Z0xVOL-<CR>

x = zone # from 1 to 4

RESPONSE: Same as for *Z0xCONSR<CR>

Zone MuTe ON

COMMAND: *Z0xMTON<CR>

x = zone # from 1 to 4

RESPONSE: Same as for *Z0xCONSR<CR>

Zone MuTe OFF

COMMAND: *Z0xMTOFF<CR>

x = zone # from 1 to 4

RESPONSE: Same as for *Z0xCONSR<CR>

Returns zone output to currently connected source at previous volume setting

Zone BASS

COMMAND: *Z0xBASSyyy<CR>

x = zone # from 1 to 4

yyy = EQ level, dB, -12 to +0 (flat) to +12 in 2 dB increments

x = zone # from 1 to 4

RESPONSE: Same as for *Z0xSETSR<CR>

NOTE: This command overrides a non-volatile bass setting made on zone keypad using the specified combination of pressing the source 1 button while holding down the mute button.

However, returning to the bass setting mode using the keypad will return the unit to the last setting made on the keypad; the serially set value will not be represented on the indicator lamps or preserved.

COMMAND/RESPONSE DESCRIPTIONS

Zone CONNect Status Request

COMMAND: *Z0xCONSR<CR>

COMMAND: *Z0xSTATUS<CR>

RESPONSE: #Z0xPWRppp,SRCs,GRPt,VOL-yy<CR>

x = zone # from 1 – 4

ppp = 'ON' (two characters) or
'OFF' (three characters)

s = source # from 1 – 4

t = 1 if source group is on, 0 if
source group is off

yy = level below max volume in
dB: -00 to -79 dB (include lead
0 for all single-digit values
yy = "MT" if in mute state
yy = "XM" if external mute is
being held active

This response will also be issued in response to pressing the on/off, volume, or source keys on a keypad.

NOTE – the response will be issued if a source key is pressed on a zone that is powered off even though the key press has no effect on the system. It will be output at every increment during a volume ramp initiated by holding a volume up or volume down key on a keypad. It will also be issued at every increment of a volume ramp commanded by the *Z0xVOL++<CR> and *Z0xVOL--<CR> commands (see below).

The mute value will be asserted if a *Z0xMTON<CR> command has been received, OR if the volume is commanded downward all the way to the lowest possible point (volume off). An active external mute input, however, will always override other volume response values with the "EXTMON" response.

Zone SETtings Status Request

COMMAND: *Z0xSETSR<CR>

RESPONSE: #Z0x,BASSyy,TREByy,GRPq

x = zone # from 1 to 4

x = zone # from 1 to 4

yy = EQ level, dB, -8 to +0 (flat)
to +8 in 1 dB increments

q = 0 if source group is on, 1 if
source group is off (this follows
DIP switch definition)

Zone ON

COMMAND: *Z0xON<CR>

RESPONSE: Same as for *Z0xCONSR<CR>

x = zone # from 1 to 4

Zone OFF

COMMAND: *Z0xOFF<CR>

RESPONSE: Same as for *Z0xCONSR<CR>

x = zone # from 1 to 4

Zone TREBLE

COMMAND: ***Z0xTREByyy<CR>**

x = zone # from 1 to 4

yyy = EQ level, dB, -12 to +0
(flat) to +12 in 2 dB increments

RESPONSE: Same as for ***Z0xSETSR<CR>**

NOTE: This command overrides a non-volatile treble setting made on zone keypad using the specified combination of pressing the source 2 button while holding down the mute button. However, returning to the treble setting mode using the keypad will return the unit to the last setting made on the keypad; the serially set value will not be represented on the indicator lamps or preserved.

Zone source GRouP ON

COMMAND: ***Z0xGRPON<CR>**

x = zone # from 1 to 4

RESPONSE: Same as for ***Z0xSETSR<CR>**

NOTE: This command overrides a non-volatile group setting made on zone keypad using the specified combination of pressing the source 3 button while holding down the mute button. The serially set value will not be preserved if power on the system is cycled.

NOTE: Units with firmware version less than 1.02 use ***Z0xG1** instead of ***Z0xGRPON**

Zone source GRouP OFF

COMMAND: ***Z0xGRPOFF<CR>**

x = zone # from 1 to 4

RESPONSE: Same as for ***Z0xSETSR<CR>**

NOTE: Units with firmware version less than 1.02 use ***Z0xG0** instead of ***Z0xGRPOFF**

VERSION

Firmware version query

COMMAND: ***VER<CR>**

RESPONSE: **#MPU_A4D_vx.yy<CR>**

x = major version number

yy = minor version number

EXTernal Mute ON

Issued whenever the external mute first activates (closure to ground) and 0 whenever the external mute de-activates (open connection to ground).

RESPONSE: **#EXTMON<CR>**

NOTE – there is no command associated with this response; it is always initiated by a change at the external mute input.

EXTernal Mute OFF

Issued whenever external mute de-activates (open connection to ground)

RESPONSE: **#EXTMOFF<CR>**

NOTE – there is no command associated with this response; it is always initiated by a change at the external mute input.

ISOLate ZONES (firmware version 1.04 and up)

COMMAND: ***ISO_ZONES<CR>**

RESPONSE: **#ISO_ZONES<CR>**

NOTE: This command DISABLES the ALL OFF and the PARTY MODE features, so that each zone is independently controlled by its keypad ONLY. If the ON/OFF button is held for three seconds or more while powering down the zone, the volume will reset to -62 dB upon next power up. If the ON/OFF button is held for less than three seconds while powering down the zone, the zone will return to the last volume setting upon next power up. The ***ALLOFF** command will have no effect and no response after this command is issued until ISOLate UNDO is issued.

This command is non-volatile. This setting will persist until ISOLate UNDO command is issued to the unit, even after power is removed from the unit.

ISOLate UNDO (firmware version 1.04 and up)COMMAND: ***ISO_UNDO<CR>**RESPONSE: **#ISO_UNDO<CR>**

NOTE: This command ENABLES the ALL OFF and the PARTY MODE features across all four zones. This is the default setting for the A4D upon first shipment.

This command is non-volatile. This setting will persist until ISOLate ZONES command is issued to the unit, even after power is removed from the unit.

Zone ISOLate (firmware version 1.05 and up)COMMAND: ***Z0xISO<CR>**

x = zone # from 1 to 4

RESPONSE: **# Z0xISO<CR>**

NOTE: DISABLES the ALL OFF and the PARTY MODE features for the targeted zone, so that this zone is independently controlled by its keypad ONLY. These commands implemented from other enabled zones will also have no effect on this zone. If the ON/OFF button is held for three seconds or more while powering down the zone, the volume will reset to -62 dB upon next power up. If the ON/OFF button is held for less than three seconds while powering down the zone, the zone will return to the last volume setting upon next power up. The *ALLOFF command will have no effect and no response after this command is issued until Z0xISO_UNDO is issued.

This command is non-volatile. This setting will persist until ISOLate ZONES command is issued to the unit, even after power is removed from the unit.

Zone ISOLate UNDO (firmware version 1.05 and up)COMMAND: ***Z0xISO_UNDO<CR>**

x = zone # from 1 to 4

RESPONSE: **# Z0xISO_UNDO<CR>**

NOTE: This command ENABLES the ALL OFF and the PARTY MODE feature for the targeted zone and allows the zone to be controlled by other enabled zones using these features. The *ISO_UNDO command has the same effect as issuing this command once for all four zones.

This command is non-volatile. This setting will persist until ISOLate ZONES command is issued to the unit, even after power is removed from the unit.

NUVO[®]

NuVo Technologies
2395 Arbor Tech Dr. Hebron, KY 41048
www.nuvotechnologies.com
Ph: 513-347-2180